

# HC-PARTS

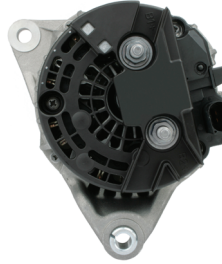
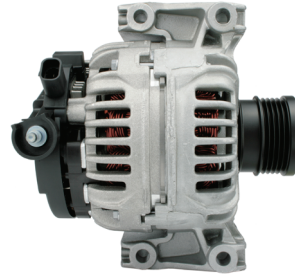

Automotive Components since 1963

## ALTERNATORS & STARTERS

2013/2014

**D:**

Allteilerückgaben sind nur im Verhältnis 1:1 gestattet, d.h. die Nummer des Allteils muss in der Vergleichsliste zum gelieferten Aggregat aufgeführt sein. Die Rückgabe muss in originaler HC-Parts Verpackung erfolgen. Das Allteil muss vollständig, ohne äußerliche Schäden und in einem instandsetzungsfähigem Zustand sein.

**DK:**

Returnering af brugte dele er kun tilladt i forholdet 1:1, dvs. at nummeret på den brugte del skal fremgå af vognlisten for det leverede udstyr. Returneringen skal finde sted i den originale emballage fra HC-Parts. Den brugte del skal være komplet, uden synlige skader og i reparerbar stand.

**E:**

Las devoluciones de piezas antiguas se permiten en una relación de 1:1, es decir el número de la pieza antigua debe aparecer en la lista comparativa del grupo suministrado. La devolución se debe realizar con el embalaje original de HC-Parts. La pieza antigua debe estar entera, sin daños externos y en un estado que permita su reparación.

**F:**

Les restitutions de pièces anciennes sont uniquement autorisées à l'identique, autrement dit le numéro de la pièce ancienne doit figurer sur la liste comparative pour le groupe livré. La restitution doit s'effectuer dans l'emballage d'origine de HC-Parts. La pièce ancienne doit être complète, sans dégâts apparents et dans un état empêchant toute remise en état.

**UK:**

Returns of old parts are only allowed in a ratio of 1:1, meaning that the number of the old part must be listed in the comparison list for the delivered unit. The return must take place in original HC-Parts packaging. The old part must be complete, without visible damage and in a repairable condition.

**I:**

La restituzione dei componenti usati è del tipo 1:1, ovvero il numero del componente usato deve essere elencato nell'elenco di riferimento dell'unità fornita. Per la restituzione deve essere utilizzato l'imballaggio HC-Parts originale. Il componente usato deve essere completo, privo di danni visibili e in condizioni riparabili.

**NL:**

Teruggave van oude onderdelen is alleen toegestaan in de verhouding 1:1, d.w.z. het nummer van het oude onderdeel moet staan vermeld in de vergelijkings tabel voor de geleverde unit. Teruggave dient in de originele HC-Parts verpakking te geschieden. Het oude onderdeel moet compleet, zonder uitwendige beschadigingen en in reparaerbare staat verkeren.

**S:**

Utbyte av aggregat **SKALL** sker bara i ett 1:1-förhållande, dvs. numret på det returnerade aggregatet **SKALL** påföras det leverade aggregatet i checklistan. Aggregatet **SKALL** returneras i originalförpackningen från HC-Parts. Det begagnade aggregatet **SKALL** vara komplett, får inte ha några yttre skador och måste vara i ett reparerbart skick.

**PL:**

Zwroty wadliwych części są możliwe tylko przy wymianie 1:1; do wysłanej części należy dołączyć numer z listy kontrolnej. Zwrot musi nastąpić w oryginalnym opakowaniu HC-Parts. Wadliwa część musi być oddana w całości, bez zewnętrznych uszkodzeń i w stanie gotowym do przeglądu.

## Reasons for rejecting cores

The same unit as delivered must be returned to secure refund of surcharge.

The unit must show no visible damage, such as damaged or broken brackets, mounting holes damaged/broken off or worn out, broken off ribs, broken off or damaged shaft on rotor or armature.

The unit must be remanufacturable. This means that the unit must not be entirely corroded or built together from various units.

The unit must have no shortcomings such as a missing starter relay, regulator, pulley or vacuum pump.

The unit must be returned in the original sales box out of consideration for the protection during transport.

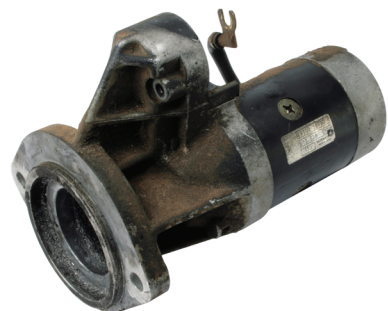
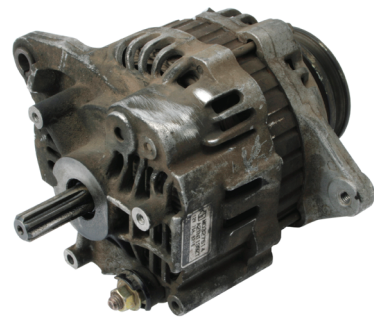
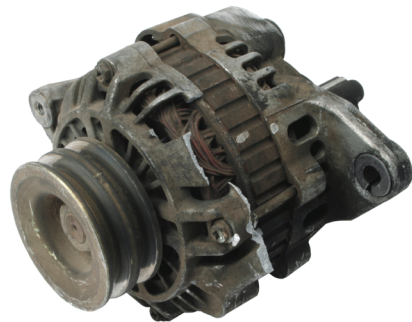



<b>INHALT</b>	Typenübersicht Lichtmaschinen ..... 15 Typenübersicht Anlasser ..... 137 Anlasser-Lichtmaschinen-Kombination (Dynastarter) ..... 215 Anwendungsliste Lichtmaschinen und Anlasser ..... 217 Vergleichsliste O.E. Nummer - Unsere Nummer ..... 789
<b>INDHOLD</b>	Typeoversigt, Generatorer ..... 15 Typeoversigt, Startere ..... 137 Dynastartere ..... 215 Vognliste, Generatorer og Startere ..... 217 Omsætningsliste O.E. nummer - Vort nummer ..... 789
<b>INDICE</b>	Catálogo de tipos, Alternadores ..... 15 Catálogo de tipos, Motores de arranque ..... 137 Dinamo ..... 215 Aplicación en vehículos, Alternadores y Motores de arranque ..... 217 Tabla de conversión Número O.E. - Número nuestro ..... 789
<b>SOMMAIRE</b>	Description des types, Alternateurs ..... 15 Description des types, Démarreurs ..... 137 Dynastart ..... 215 Affectations par véhicules, Alternateurs et Démarreurs ..... 217 Tableau de correspondance O.E. No. - Nôtre No. .... 789
<b>SISÄLLYSLUETTELO</b>	Yhteenveto - laturit ..... 15 Yhteenveto - käynnistimet ..... 137 Käynnistin/generaattori (Dynastart) ..... 215 Soveltuvuustaulukko - laturit + käynnistimet ..... 217 Vertailunumerot OE-HC ..... 789
<b>CONTENTS</b>	Type summary, Alternators ..... 15 Type summary, Starter motors ..... 137 Dynastarters ..... 215 Vehicle Application, Alternators and Starter motors ..... 217 Cross reference list O.E. no. - Our no. .... 789
<b>INDICE</b>	Catalogo Alternatori ..... 15 Catalogo Motorini Avviamento ..... 137 Dinamotori ..... 215 Applicazione per veicoli, Alternatori e Motorini Avviamento ..... 217 Tabella comparativa OE n° - HC n° ..... 789
<b>INHOUD</b>	Type-overzicht, dynamo's ..... 15 Type-overzicht, startmotoren ..... 137 Dynastarters ..... 215 Toepassing en auto-merken, dynamo's en startmotoren ..... 217 Vergelijkingstabel O.E. nummer - ons nummer ..... 789
<b>ZAWARTOŚĆ</b>	Zestawienie typów, alternatory ..... 15 Zestawienie typów, rozruszniki ..... 137 Dynastartery ..... 215 Zastosowanie w pojazdach, alternatory i rozruszniki ..... 217 Lista zamienników Numer O.E. – Numer HC ..... 789
<b>INNEHÅLLS- FÖRTECKNING</b>	Artikelöversikt, Generatorer ..... 15 Artikelöversikt, Startmotorer ..... 137 Dynastart ..... 215 Rekommendationstabell, Generatorer och Startmotorer ..... 217 Översättningstabeller Original Nr. - Vårt Nr. .... 789







GB	I	NL	PL	S	
Air conditioning	Aria condizionata	Air Conditioning	Klimatyzacja	Luftkonditionering	<b>AC</b>
A/C and auxiliary steering system	Sistema A/C e sterzo ausiliario	Airconditioning en hulpstuurinrichting	Klimatyzacja i pomocniczy układ sterowania	Klimatanläggning och hjälpstyrning	<b>ACPS</b>
Automatic Transmission	Cambio automatico	Automatische versnelling	Automatyczna skrzynia biegów	Automatisk växellåda	<b>AT</b>
6-speed automatic transmission	Cambio automatico a 6 velocità	Automatische transmissie met 6 versnellingen	6-biegowa automatyczna skrzynia biegów	6-växlad automatväxellåda	<b>AT6S</b>
7-speed automatic transmission	Cambio automatico a 7 velocità	Automatische transmissie met 7 versnellingen	7-biegowa automatyczna skrzynia biegów	7-växlad automatväxellåda	<b>AT7S</b>
Automatic transmission and A/C	Cambio automatico e A/C	Automatische transmissie en airconditioning	Automatyczna skrzynia biegów i klimatyzacja	Automatväxellåda och klimatanläggning	<b>ATAC</b>
Battery Sense	Sensore Batteria	Accusensor	Czujnik akumulatora	Batterisensor	<b>BS</b>
Chassis	Telaio	Chassis	Podwozie	Chassi	<b>Chas.</b>
Direct Drive	A trazione diretta	Directe aandrijving	Napęd bezpośredni	Direktdrift	<b>DD</b>
DF plug	Spina DF	DF klem	Wtyczka DF	Fältanslutning	<b>DF</b>
For vehicles with dual clutch transmission	Per veicoli con cambio a doppia frizione	Voor voertuigen met dubbele koppeling	Do pojazdów z dwusprzęgłową skrzynią biegów	För fordon med dubbelkoppling	<b>DKG</b>
Double Pulley	Puleggia doppia	Dubbele riemschijf	Podwójne koło pasowe	Dubbelremskiva	<b>DP</b>
Direct shift		Directe schakeling	Przekładnia typu Direct shift	Direktväxling	<b>DSG</b>
Ecomatic	Ecomatic	Ecomatic	Ecomatic	Ecomatic	<b>ECO</b>
Engine	Motore	Motor	Silnik	Motor	<b>Eng.</b>
Free Wheel Pulley	Puleggia con Frizione	Vrijloop	Z wolnobiegim	Frihjulremskiva	<b>FW</b>
Gear Reduction	Riduttore	Reductie startmotor	Rozrusznik z przekładnią	Reduktionsväxel	<b>GR</b>
Internal Fan	Autoventilato	Inwendige ventilator	Wentylator wewnętrzny	Inbyggd fläkt	<b>IF</b>
Internal Regulator	Regolatore interno	Ingebouwde regelaar	Regulator wewnętrzny	Inbyggd relä	<b>IR</b>
Pulley	Puleggia	Riemschijf	Pojedyncze koło pasowe	Remskiva	<b>P</b>
Power Steering	Servosterzo	Stuurbekrachtiging	Wspomaganie kierownicy	Servostyrning	<b>PS</b>
Right hand drive	Guida a destra	Stuur rechts	Kierownica z prawej strony	Högerstyrd	<b>RHD</b>
Serpentine Pulley	Puleggia polivie	Serpentine riemschijf	Koło pasowe wielorowkowe	Serpentinremskiva	<b>SP</b>
4-speed	4 velocità	4 versnellingen	4-biegi	4-växlad	<b>4SP</b>
5-speed	5 velocità	5 versnellingen	5-biegi	5-växlad	<b>5SP</b>
6-speed	6 velocità	6 versnellingen	6-biegi	6-växlad	<b>6SP</b>
Vacuum Pump	Depressore	Vacuumpomp	Pompa próżniowa	Vakuumpump	<b>VP</b>
RPM Connection	Connessione contagiri	Toerenteller	Podłączenie obrotomierza	Med W-anslutning (Varvräknare )	<b>W</b>
Connection for Auxiliary Start	Connessione ausiliaria avviamento	Verbinding voor starthulp	Podłączenie do rozruchu awaryjnego	Hjälpstartsanslutning	<b>15</b>
W/ additional terminal 30h	Con terminale supplementare 30h	Met extra aansluiting 30h	Z dodatkowym terminalem 30h	Med anslutning 30h	<b>30h</b>
Number of fixing holes. Number in brackets represent threaded holes	Numero fori fissaggio. La cifra fra parentesi indica il numero dei fori filettati	Aantal montagegaten in de flens. Tussen haakjes staat het aantal met schroefdraad	Liczba otworów mocujących. Liczba w nawiasie oznacza ilość otworów gwintowanych.	Antal fästöron. Inom parentes, antal fästhål med gänga	<b>3(2)</b>
Vehicle type	Tipo veicolo	Voertuigtype	Typ pojazdu	Vagntyp	<b>( )</b>
Engine Type	Tipo Motore	Motortype	Typ silnika	Motortyp	<b>[ ]</b>
Available while stocks last	Disponibili sino ad esaurimento stock	Leverbaar zolang de voorraad strekt	Dostępne do wyczerpania zapasów magazynowych	Utgående artikel	<b>#</b>
Number of teeth	Numero denti	Aantal tanden	Liczba zębów	Antal kuggar	
Anti Clockwise Rotation	Rotazione antioraria	Links draaiend	Kierunek obrotu przeciwny do ruchu wskazówek zegara.	Rotationsriktning moturs	
Clockwise Rotation	Rotazione oraria	Rechts draaiend	Kierunek obrotu zgodny z ruchem wskazówek zegara	Rotationsriktning medurs	
These units not accepted for surcharge	Unità non accettata per esubero	Geen statie geld voor deze units	Ten produkt nie jest przyjmowany z powrotem jako kaucja	För dessa enheter betalas ingen strompant	<b>◆</b>
Can be replaced if pulley is changed	Intercambiabile sostituendo la puleggia	Is toepasbaar wanneer poelie gewisseld wordt	Zamienny pod warunkiem wymiany koła pasowego	Kan ersättes om remskivan skiftas	<b>▲</b>
Insulated	Isolato	Dubbel geïsoleerd	Podwójna izolacja	Dubbelisolerad	
Program development	Sviluppo del programma	Programmaontwikkeling	Program rozwoju	Programutveckling	<b>*</b>
With engine immobiliser	Con immobiliser motore	Met startvergrendeling	Z immobiliserem silnika	Med startspärr	<b>A10</b>
W/ aut. Choke	Con starter automatico	Met automatische choke	Z automatycznym ssaniem	Med automatchoke	<b>A11</b>
Catalytic converter	Catalizzatore	Katalysator	Katalizator spalin	Katalysator	<b>A12</b>
Cold climate	Climi freddi	Koud klimaat	Zimny klimat	Kallt klimat	<b>A13</b>



	D	DK	E	F	FI
A14	Mit Computeranschluß	M/ computer	Con ordenador	Clim piloté	Tietokoneiliitännällä
A15	DK, IS, N, S, SF	DK,IS,N,S,SF	DK,IS,N,S,SF	DK,IS,N,S,SF	DK,IS,N,S,S,SF
A16	CH, DK, N, S	CH,DK,N,S	CH,DK,N,S	CH,DK,N,S	CH,DK,N,S
A17	Für Kühlwasseraufwärmung	Til kølevandsopvarmning	Para refrigeración por agua	Pour radiateur de chauffage	Jäähdytysnestelämmitys
A18	Automatikgetriebe	Direkte automatisk transmission	Transmisión automática	Transmission automatique directe	Automaattivaihteisto
A19	Mit elektrischen Heizungssystem	M/ elektrisk opvarmningssystem	Con sistema de calefacción eléctrica	A/ chauffage électrique	Sähköinen lämmitysjärj
A20	Zusätzlich eingebaut	Ekstra monteret	Montaje adicional	Montage additionel	Lisäasennus
A21	Mit Vorglühanlage	M/ gløderørs opvarmning	Con bujía de precalentamiento	A/ bougies de préchauffage	Esihehkutuksella
A22	Mit heizbarer Frontscheibe	EI forrude	Parabrisas térmica delantera	A/ para-brise chauffant	Lämmitettävä tuulilasi
A23	Mit heizbarer Frontscheibe und Klimaanlage	EI forrude + klima anlæg	Parabrisas térmica delantera y aire acondicionado	A/ pare-brise chauffant é + air conditionn	Lämmitettävä tuulilasi + ilmastointi
A24	Tiptronic	Tiptronic	Tiptronic	Tiptronic	Tiptronic
A25	Mit Start/Stop-Einrichtung	Med start / stop	Con start / stop	A/ start / stop	Start/Stop-automaattikka
A26	Kontrollleuchte	Kontrol lampe	Lámpara de control	Lampe témoin	Merkkivalo
A27	Anschluß L	Med ladelampe	Conexión L	Raccord L	Merkkivalon liitin L
A28	Anschluß L und Zündung	Tilslutning L + tændning	Conexión L + Ing	Raccord L + Allum.	Merkkivaloliitin+ sytytys
A29	Abgedichtete Ausführung	Olie eller stænkæt	Sellado especial	Version étanche	Erikoistiivistetty
A30	Voltmeter	Voltmeter	Voltímetro	Voltmètre	Volttimittari
A31	Mit Hitzeschild	Med varmeskjold	Tapa de calor	A/ capteur de température	Lämpösuojalla
A32	Automatikgetriebe und kalte Klimazonen	Automatgear og koldt klima	Transmisión automática y climatizador	Automatique, Pays froids	Automaattivaihteistolla, kylmään Imastoon
A33	Taxi	Taxi	Taxi	Taxi	Taksi
A34	Schalt- und Automatikgetriebe	Manuelt og automatgear	Velocidad manual y automática	Manuelle et automatique Transmission	Manuaali- ja automaattivaihteisto
A35	Wassergekühlt	Vandkølet	Enfriado por agua	Refroidit par le système de liquide	Vesijäähdytteinen laturi
A36	Mit offenem Antriebslagerschild	Med åben bendixhus	Con cubre impulsor	Démarrreur avec nez	Avonainen vetopääty
A37	Mit geschlossenem Antriebslagerschild	Med lukket bendixhus	Sin cubre impulsor	Démarrreur sans nez	Vetopääty kauhalla
A38	Manuelle Klimaanlage	Manuel Aircondition	A/C manual	A/C manuelle	Manuaalinen ilmastointi
A39	Automatische Klimaanlage	Automatisk Aircondition	A/C automático	A/C automatique	Automaattinen ilmastointi
A40	Starter-Generator	Starter - Generator	Alternador del motor de arranque	Altern-démarrreur	Käynnistin-laturi
A41	Sequentielles Schaltgetriebe	Sekventiel manuel transmission	Transmisión manual secuencial	Transmission manuelle séquentielle	Käsivälintainen Sequential-vaihteisto
A42	Tropenklima	Tropisk klima	Clima tropical	Climat tropical	Trooppinen ilmasto
A43	Schaltgetriebe	Manuel gear	Transmisión manual	Transmission manuelle	Käsivaihteisto
A44	Automatikgetriebe und Start-Stopp-System	Automat gear og start/ stop system	Transmisión automática y sistema de arranque/parada	Transmission automatique et système Start/Stop	Automaattivaihteisto ja käynnistys-/pysäytysjärjestelmä
A45	Mit Sicherheitsschalter	Med hjælperele	Con interruptor de seguridad	Avec interrupteur de sécurité	Turvakytkimellä
BO	Bosch-Typ	Bosch type	Tipo Bosch	Type Bosch	Bosch-tyyppinen
DR	Delco Remy-Typ	Delco Remy type	Tipo Delco Remy	Type Delco Remy	Delco Remy-tyyppinen
HI	Hitachi-Typ	Hitachi type	Tipo Hitachi	Type Hitachi	Hitachi-tyyppinen
IS	Iskra-Typ	Iskra type	Tipo Iskra	Type Iskra	Iskra-tyyppinen
LM	Kleine Anlasser-Version	Lille starter udgave	Versión pequeña del motor de arranque	Version à petit démarreur	Pieni käynnistin
LU	Lucas-Typ	Lucas type	Tipo Lucas	Type Lucas	Lucas-tyyppinen
MA	Marelli-Typ	Marelli type	Tipo Marelli	Type Marelli	Marelli-tyyppinen
MAG	Magneton-Typ	Magneton type	Tipo Magneton	Type Magneton	Magneton-tyyppinen
MI	Mitsubishi-Typ	Mitsubishi type	Tipo Mitsubishi	Type Mitsubishi	Mitsubishi-tyyppinen
MS	Mitsuba-Typ	Mitsuba type	Tipo Mitsuba	Type Mitsuba	Mitsuba-tyyppinen
ND	Nippondenso-Typ	Nippondenso type	Tipo Nippondenso	Type Nippondenso	Nippondenso-tyyppinen
PL	Prestolite-Typ	Prestolite type	Tipo Prestolite	Type Prestolite	Prestolite-tyyppinen
PR	Paris Rhone-Typ	Paris Rhone type	Tipo Paris Rhone	Type Paris Rhone	Paris Rhone-tyyppinen
SM	Große Anlasser-Version	Stor starter udgave	Versión grande del motor de arranque	Version à grand démarreur	Suuri käynnistin
VA	Valeo-Typ	Valeo type	Tipo Valeo	Type Valeo	Valeo-tyyppinen



GB	I	NL	PL	S	
W/ computer	Con computer	Met computer	Z komputerem	Med dator	<b>A14</b>
DK,IS,N,S,SF	DK,IS,N,S,SF	DK,IS,N,S,SF	DK,IS,N,S,SF	DK,IS,N,S,SF	<b>A15</b>
CH,DK,N,S	CH,DK,N,S	CH,DK,N,S	CH,DK,N,S	CH,DK,N,S	<b>A16</b>
For cooling-water heating	Per riscaldatore acqua	Voor koelwater opwarming	Z ogrzewaniem wodnym	För Uppvärmning av Kylvätskan	<b>A17</b>
Direct automatic transmission	Cambio automatico diretto	Directe automatische overschakeling	Skrzynia typu DSG	Direkt automatisk transmission	<b>A18</b>
W/ electrical heating system	Con riscaldatore elettrico	Met electrisch verwarmingsysteem	Z ogrzewaniem elektrycznym	Med elektrisk uppvärmning	<b>A19</b>
Additionally mounted	Montato in aggiunta	Extra montage	Montowany dodatkowo	Extra monterad	<b>A20</b>
W/ glowplug heating	Con riscaldamento candele	Met gloeibougie verwarming	Z podgrzewaniem świec żarowych	Uppvärmning med glödstift	<b>A21</b>
Heated windscreen	Parabrezza riscaldato	Verwarmd voorscherm	Podgrzewana przednia szyba	Med elektriskt uppvärmd vindruta	<b>A22</b>
Heated windscreen + Air condition	Parabrezza riscaldato + Aria condizionata	Met verwarmd windscherm en air conditioning	Podgrzewana przednia szyba + klimatyzacja	Med elektriskt uppvärmd vindruta + Luftkonditionering	<b>A23</b>
Tiptronic	Tiptronic	Tiptronic	Tiptronic	Tiptronic	<b>A24</b>
W/ start / stop	Con start / stop	Met start / stop	Z start / stop	Med start / stop	<b>A25</b>
Charging lamp	Lampada spia	Controlelamp	Lampka ładowania	Laddningslampa	<b>A26</b>
Connection L	Connessione Spia Batteria	L-aansluiting	Podłączenie L	Anslutning L (Laddn.lampa)	<b>A27</b>
Connection L + Ign.	Connessione Spia Batteria + Accensione	L en ontstekings aansluiting	Podłączenie L + zapłon	Anslutning L (Laddn.lampa) + "15"Spänning	<b>A28</b>
Specially sealed	Sigillatura speciale	Speciaal geseald	Specjalnie uszczelniony	Speciellt tätad	<b>A29</b>
Volt-meter	Voltmetro	Voltmeter	Woltomierz	Voltmeter	<b>A30</b>
W/ heat cap	Con schermo di calore	Met hitte beschermingskap	Z nakładką termoizolacyjną	Med värmesköld	<b>A31</b>
Automatic Transmission and Cold Climate	Trasmissione automatica e climi freddi	Automatisch overschakeling en koud klimaat	Automatyczna skrzynia biegów + wyposażenie na zimny klimat	Automatlåda & kallt klimat	<b>A32</b>
Taxi	Per Taxi	Taxi	Taxi	Taxi	<b>A33</b>
Manual and automatic Transmission	Cambio automatico e manuale	Handmatige en automatische overschakeling	Ręczna i automatyczna skrzynia biegów	Manuell & automatisk transmission	<b>A34</b>
Water cooled	Raffreddato ad acqua	Watergekoeld	Chłodzony cieczą	Vattenkyld	<b>A35</b>
W/ bendixhousing	Pignone protetto da supporto	W/ bendixhousing	Z obudową sprzęgła	Med "Nos"	<b>A36</b>
W/o bendixhousing	Pignone non protetto da supporto	W/o bendixhousing	Bez obudowy sprzęgła	Utan "Nos"	<b>A37</b>
Manual A/C	A/C manuale	Handmatige airconditioning	Klimatyzacja manualna	Manuell luftkonditionering	<b>A38</b>
Automatic A/C	A/C automatica	Automatische airconditioning	Klimatyzacja automatyczna	Automatisk luftkonditionering	<b>A39</b>
Starter-Alternator	Motorino di avviamento-alternatore	Starter-Generator	Rozrusznik-alternator	Startmotor-Generator	<b>A40</b>
Sequential manual transmission	Cambio manuale sequenziale	Sequentiële handmatige transmissie	Ręczna sekwencyjna skrzynia biegów	Sekventiell manuell växellåda	<b>A41</b>
Tropical climate	Clima tropicale	Tropisch klimaat	Klimat tropikalny	Tropiskt klimat	<b>A42</b>
Manual transmission	Cambio manuale	Handmatige transmissie	Ręczna skrzynia biegów	Manuell växellåda	<b>A43</b>
Automatic transmission and Start/Stop system	Cambio automatico e sistema Start/Stop	Automatische transmissie en start/stop-systeem	Automatyczna skrzynia biegów z systemem Start/Stop	Automatisk växellåda och start-/stoppsystem	<b>A44</b>
With safety switch	Con interruttore di sicurezza	Met veiligheidschakelaar	Z wyłącznikiem bezpieczeństwa	Med säkerhetsrelä	<b>A45</b>
Bosch type	Tipo Bosch	Bosch-typypinen	Typ Bosch	Bosch-typ	<b>BO</b>
Delco Remy type	Tipo Delco Remy	Delco Remy-typypinen	Typ Delco Remy	Delco Remy-typ	<b>DR</b>
Hitachi type	Tipo Hitachi	Hitachi-typypinen	Typ Hitachi	Hitachi-typ	<b>HI</b>
Iskra type	Tipo Iskra	Iskra-typypinen	Typ Iskra	Iskra-typ	<b>IS</b>
Small starter version	Versione piccola motorino di avviamento	Kleine starteruitvoering	Rozrusznik - wersja mała	Version med liten startmotor	<b>LM</b>
Lucas type	Tipo Lucas	Lucas-typypinen	Typ Lucas	Lucas-typ	<b>LU</b>
Marelli type	Tipo Marelli	Marelli-typypinen	Typ Marelli	Marelli-typ	<b>MA</b>
Magneton type	Tipo Magneton	Magneton-typypinen	Typ Magneton	Magneton-typ	<b>MAG</b>
Mitsubishi type	Tipo Mitsubishi	Mitsubishi-typypinen	Typ Mitsubishi	Mitsubishi-typ	<b>MI</b>
Mitsuba type	Tipo Mitsuba	Mitsuba-typypinen	Typ Mitsuba	Mitsuba-typ	<b>MS</b>
Nippondenso type	Tipo Nippondenso	Nippondenso-typypinen	Typ Nippondenso	Nippondenso-typ	<b>ND</b>
Prestolite type	Tipo Prestolite	Pretolite-typypinen	Typ Prestolite	Pretolite-typ	<b>PL</b>
Paris Rhone type	Tipo Paris Rhone	Paris Rhone-typypinen	Typ Paris Rhone	Paris Rhone-typ	<b>PR</b>
Large starter version	Versione grande motorino di avviamento	Grote starteruitvoering	Rozrusznik - wersja duża	Version med stor startmotor	<b>SM</b>
Valeo type	Tipo Valeo	Valeo-typypinen	Typ Valeo	Valeo-typ	<b>VA</b>



- D** **HC-PARTS** Austauschaggregate sind nach den modernsten Methoden instandgesetzt. Alle Aggregate werden komplett demontiert. Die Bauteile werden gereinigt sowie mechanisch und elektrisch getestet. Fehlerhafte Komponenten werden entweder instandgesetzt oder durch neue Bauteile ersetzt. Durch die Lackierung sehen die Aggregate fabriknneu aus. Nach der Endmontage wird jedes Aggregat an modernen Prüfeinrichtungen getestet.  
Fast alle **HC-PARTS** Lichtmaschinen werden mit Lüfter und Riemenscheibe geliefert.  
Originalnummern werden nur als Referenz benutzt, und dürfen nicht in Rechnungen erscheinen.
- DK** **HC-Parts'** indbytningsudstyr renoveres efter de mest moderne metoder. Alt udstyr adskilles fuldstændigt. Komponenterne rengøres og testes mekanisk og elektrisk. Defekte komponenter enten renoveres eller udskiftes med ny komponenter. Lakeringen gør, at udstyret fremtræder som fabriksnyt. Efter færdigmontering testes det enkelte udstyr i en moderne testopstilling.  
Næsten alle **HC-Parts'** generatorer leveres med blæser og remskive.  
Originalnumre benyttes udelukkende som reference og må ikke fremgå af fakturaer.
- E** Los grupos de sustitución **HC-PARTS** están reparados conforme a los métodos más modernos. Todos los grupos se desmontan por completo. Los componentes se limpian y se prueban a nivel mecánico y eléctrico. Los componentes defectuosos se reparan o se sustituyen por otros nuevos. Con la pintura, los grupos parecen nuevos de fábrica. Tras el montaje final, se prueba cada grupo en modernos sistemas de ensayo.  
Casi todas las dinamos de **HC-PARTS** se suministran con ventilador y polea de transmisión.  
Los números originales sólo se usan como referencia y no pueden aparecer en facturas.
- F** Les groupes de remplacement de **HC-PARTS** sont remis en état selon les méthodes les plus modernes. Tous les groupes sont entièrement démontés. Les pièces sont nettoyées et testées mécaniquement et électriquement. Les composants défectueux sont soit remis en état, soit remplacés par des pièces neuves. Après la peinture, les groupes auront l'air neufs, comme à la sortie de l'usine.  
Après le montage final, chaque groupe est testé sur des installations d'essai modernes.  
Pratiquement toutes les dynamos de **HC-PARTS** sont livrées avec ventilateur et poulie.  
Les numéros d'origine servent uniquement de référence et ne doivent pas figurer sur les factures.
- FI** **HC-PARTS**-vaihtoaggregaatit on kunnostettu nykyaikaisimmin käytettävissä olevin menetelmin. Kaikki aggregaatit irrotetaan kokonaisuina. Rakennneosat puhdistetaan sekä testataan mekaanisesti ja sähköisesti. Violliset komponentit kunnostetaan tai korvataan uusilla rakenneosilla. Maalaus saa aggregaatit näyttämään kuin uusilta. Loppuasennuksen jälkeen jokainen aggregaatti testataan nykyaikaisin testausvälinein.  
Lähes kaikki **HC-PARTS**-generaattorit toimitetaan tuulettimella ja hihnapyörällä varustettuina.  
Alkuperäisnumeroita käytetään vain viitteinä, eikä niitä saa näkyä laskuilla.
- GB** **HC-PARTS** exchange units are repaired according to the most modern methods. All units are completely disassembled. The components are cleaned and then mechanically and electrically tested. Defective components are either repaired or replaced with new components. After painting, the units appear to be fresh from the factory. Following final assembly, each unit is tested on modern testing equipment.  
Almost all **HC-PARTS** generators are delivered with fan and pulley.  
Original numbers are only used as a reference and may not appear in invoices.
- I** Le unità sostitutive **HC-PARTS** vengono riparate secondo i metodi più moderni. Tutte le unità vengono completamente smontate. I componenti vengono puliti e sottoposti a test meccanici ed elettrici. I componenti guasti vengono riparati o sostituiti con componenti nuovi. Una volta verniciate, le unità sembrano nuove di fabbrica. Dopo il montaggio finale, ogni unità viene testata su moderni banchi di prova.  
Quasi tutti gli alternatori **HC-PARTS** vengono forniti con ventola e puleggia.  
I numeri originali fungono da riferimento e non devono apparire nelle fatture.
- NL** **HC-PARTS** ruilunits worden volgens de modernste technieken gereviseerd. Alle units worden compleet gedemonteerd. Alle componenten worden gereinigd en vervolgens mechanisch en elektrisch getest. Defecte onderdelen worden ofwel gerepareerd, of door nieuwe onderdelen vervangen. Na het aflakken zien de units er weer uit als nieuw. Na de eindmontage wordt elke unit op moderne testbanken uitvoerig getest.  
Nagenoeg alle **HC-PARTS** dynamo's worden met ventilator en poelie geleverd.  
Originele nummers worden uitsluitend gebruikt ter referentie en mogen niet op facturen worden vermeld.
- PL** Części zamienne **HC-PARTS** są naprawiane z wykorzystaniem najnowocześniejszych metod. Wszystkie części zostaną całkowicie zdemontowane. Elementy zostaną oczyszczone, jak również przetestowane pod kątem sprawności mechanicznej i elektrycznej. Uszkodzone komponenty zostaną naprawione lub wymienione na nowe. Dzięki lakierowaniu części wyglądają na fabrycznie nowe. Po montażu końcowym każda część zostanie przetestowana za pomocą nowoczesnych urządzeń testujących.  
Prawie wszystkie alternatory **HC-PARTS** będą wysyłane z wentylatorem i kołem pasowym.  
Originalne numery są używane tylko w celach informacyjnych i nie powinny być umieszczane na fakturach.
- S** **HC-PARTS** utbytesaggregat repareras med hjälp av den senaste tekniken. Alla aggregat demonteras helt och hållet. Komponenterna rengörs samt testas både mekaniskt och elektriskt. Felaktiga komponenter repareras eller byts ut mot nya. Tack vare lackeringen ser de reparerade aggregaten ut som om de vore fabriksnya. Efter slutmonteringen testas varje aggregat i moderna testanordningar.  
Så gott som alla **HC-PARTS**-generatorer levereras ned fläkt och remskiva.  
Originalnumren används enbart som referens och får inte synas på fakturan.





	Field/Läufer, Felt/Rotor, Inductor/Rotor, Inducteur/Rotor, Kenttä/Roottori, Field/Rotor, Campo/Rotore, Veld/Rotor, Wzbudzenie/Wirnik, Fält/Rotor	Massa, Stel, Masa, Chassis, Maatto, Ground, Massa, Massa, Masa, Jord	Kontrolllampe, Kontrolllampe, Lámpara de control, Lampe de contrôle, Latauksen merkivalo, Charging Lamp, Lampada di controllo, Controllelampe Lampka kontrolna, Laddilampa	Zündung, Tænding, Ignición, Allumage, Sytytys, Ignition, Accensione, Ontsteking, Zapłon, Tändning	Mittelpunkt, Midtpunkt, Punto central, Point Central, Keskipiste, Neutral/Wye, Punto Centrale, Neutraal, Punkt centralny, Mittelpunkt	Drehzahlmesser/Ständerwicklung, Omdrehningsmåler/stator, Contador de revoluciones/stator, Compte tours/stator, Kierroslukumittari/Staattori, Tacho/stator, Contagiri/statore, Toerenteller/stator, Obrotomierz/Uzwojenie, Varvräknare	Computeranschluß, Computer control, Control CPU, Borne d'ordinateur, Keskuohjainyksikön liitin, CPU Control, Terminale di computer, Computeraansluiting, Kontrola CPU, Data-ansluiting	Batteriesensung, Batteriføler, Sensor de batería, Sens de batterie, Akkumunistiin, Battery Sense, Sensore Batteria, Accusensor, Czujnik akumulatora, Batteri-sensor	Batterie, Batteri +, Bateria, Batterie, Akun luenapa, Battery, Batteria +, Accu +, Akumulátor +, Batteri +	Dummy, Dummy, Borne sin función, Borne sans fonction, Tyhjä, Dummy, Attacco vuoto, Dummy, Bez funkcji, "Dummy"
BOSCH	DF/F1/F2	B-/D-	D+/61/L/61E	15		W	COM/DF DFM/FR LI/RC LIN	S	B+	
BUTEC	F	-	D+						B+	
CHRYSLER	F1/F2/FLD	GRD							B+	
DELCO	F	GRD	D+/L/1	I/IG		P/R/W	F	M/S/2	B+	
DELPHI			L				DFM		B+	
DUCELLIER	EXC	-/B-	D+	+		W			B+	
ELMOT	67	31	15			W			B+	
FORD (VISTEON)	DF/F/FLD	D-/VE	D+/IND/I			W/STA/S			B+/Bat	
HITACHI	F	E	L	IG/R	N	P	FR/G	S	B/A	D
ISKRA	DF	D-	D+			W			B+	
LADA	67	31	15						B+/30	
LUCAS	F	-	D+			STA/W		S	B+	
PAL/MAGNETON	M	-	R						B+	
MANDO	F	E	L/I	IG/R	N	P		S	B/A	D
MARELLI	67	31	15		C	W	FR/SIG LI/STD PHIN/RC		B+/30	
MITSUBISHI	F	E	L	IG/R	N	P	FR/G/D	S	B/A	D
MOTOROLA	EXC	-/B-	D+			W			B+	
NIPPONDENSO	F/F1/F2	E-	L	IG/R	N	P	FR/C/M	S	B/A	D
PARIS RHONE	EXC	-/B-	L			W			B+	
SEV MARCHAL	DF	-/B-	61+			W			B+	
VALEO	EXC	-	L/D+/61E	15/+		W	COM/FR DF/DFM LIN		B+'	



- D** Die Abbildungen zeigen, an welchen Stellen sich die original Herstellernummer oder das original Typenschild befindet. Wenn das Typenschild unlesbar ist oder fehlt, dann bitte in der Anwendungsliste nachsehen.
- DK** Illustrationerne viser, hvor producentens originalnummer eller typeskilt er anbragt. Såfremt typeskiltet er ulæseligt eller mangler, bedes nummeret slået efter i vognlisten.
- E** Las ilustraciones muestran los puntos donde están los números originales del fabricante o la placa indicadora original. Si la placa indicadora es ilegible o falta, consulte la lista de aplicaciones.
- F** Les illustrations indiquent les endroits où se trouvent le numéro de constructeur d'origine et la plaque signalétique d'origine. Lorsque la plaque signalétique est illisible ou manquante, veuillez consulter la liste d'application.
- FI** Kuvat osoittavat, missä kohdissa alkuperäiset valmistusnumerot tai alkuperäinen tyypikilpi sijaitsee. Jos tyypikilvestä ei saa selvää tai se puuttuu, tiedot on etsittävä sovellusluettelosta.
- GB** The illustrations show where the original factory number or original identification plate is found. When the identification plate is illegible or missing, please check in the application list.
- I** Le illustrazioni mostrano i punti in cui si trova il numero di identificazione originale o la targhetta di identificazione originale. Se la targhetta di identificazione non è leggibile o errata, consultare l'elenco applicazioni.
- NL** De afbeeldingen tonen, waar het originele fabricagenummer of het originele typeplaatje zijn aangebracht. Indien het typeplaatje onleesbaar is, raadpleegt u de tabellijst Toepassingen.
- PL** Ilustracje przedstawiają położenie oryginalnych numerów producenta lub tabliczek znamionowych. Jeśli tabliczka znamionowa jest nieczytelna lub zniszczona, należy sprawdzić na liście zastosowań.
- S** Figurerna visar var det ursprungliga tillverkarnumret eller den ursprungliga typskylten sitter. Om typskylten saknas eller är oläslig, se efter i applikationslistan.

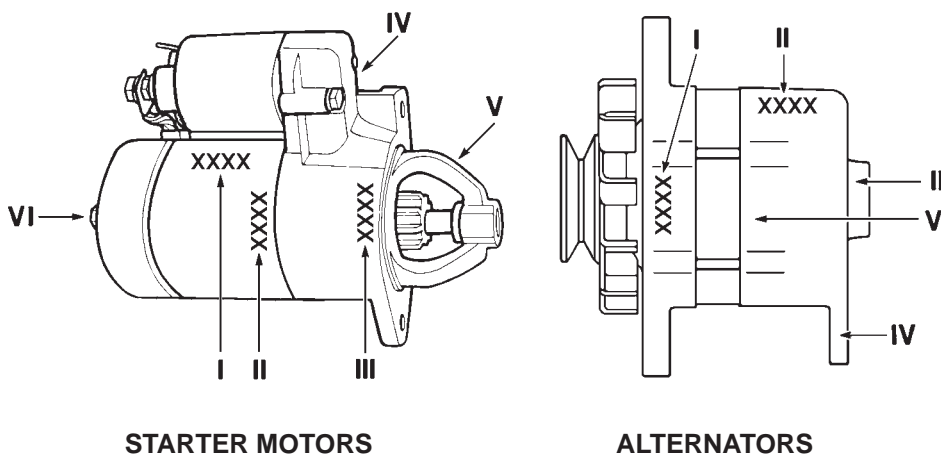

**D****Bevor Sie die Drehstromlichtmaschine einbauen / testen, müssen Sie unbedingt folgende Punkte beachten:**

- Ist die Batterie betriebsbereit und korrekt verbunden ?
- Ist der Keilriemen genügend fest und in Ordnung ?
- Sind alle Anschlüsse sorgfältig ausgeführt ?
- Ist das Bordnetz in Ordnung ?
- Sind alle Bolzen und Muttern sorgfältig angezogen und mit Unterlegscheiben versehen ?

**DK****Før afprøvning af den nymonterede alternator bør De sikre Dem at følgende punkter er i orden:**

- Er batteriets polaritet i orden ?
- Er ventilatorremmen tilpas stram og i orden ?
- Er alle tilslutninger korrekt udført ?
- Er kabelnettet i orden ?
- Er alle bolte og møtrikker ordentligt spændt og med fjederskiver ?

**E****Antes de probar el nuevo alternador, debe controlar los siguientes puntos:**

- ¿Está en orden la polaridad de la batería ?
- ¿La correa del ventilador está suficientemente tensada y en orden ?
- ¿Se han hecho todas las conexiones de modo correcto ?
- ¿Está en orden la red de cables ?
- ¿Están apretados todos los pernos y tuercas de modo seguro con aplicación de arandelas elásticas ?

**F****Avant de tester l'alternateur après repose, il est conseillé de vérifier les points suivants:**

- Polarité de la batterie
- Tension et bon état de la courroie du ventilateur
- Réalisation correcte de toutes les connexions
- Etat du faisceau électrique
- Serrage correct de tous les boulons et écrous en utilisant des rondelles élastiques

**FI****Seuraavat ohjeet sekä muut, pakkauksissa olevat asennusohjeet on ehdottomasti huomioitava laturia asennettaessa:**

- Onko akku kunnossa ja akun kaapelit irrotettu ennen asennusta?
- Onko kiilahihna kiristetty riittävästi ja vahingoittumaton?
- Onko kaikki liitokset tehty oikein ja huolellisesti?
- Onko kaapelinippu kunnossa ja asennettu siististi?
- Onko kaikki pultit ja mutterit kiinnitetty huolellisesti ja varustettu jousialuslevyillä?

**GB****Before testing the replaced alternator it is in your own interest to make sure that the following is ok:**

- Is the battery OK and are the battery cables correctly connected ?
- Is the fan belt tightened properly and is it OK ?
- Are all connections correctly made and have they been tightened ?
- Is the harness OK ?
- Are all bolts and nuts properly tightened and with spring plates ?

**I****Prima di provare l'alternatore, che avete appena montato, dovreste assicurarvi nel vs. interesse, che i seguenti punti siano corretti:**

- La polarità della batteria è corretta ?
- La cinghia è ben tesa ed in buone condizioni ?
- Tutti i collegamenti sono eseguiti correttamente ?
- Il cablaggio è corretto ?
- Tutti i bulloni ed i dadi sono ben serrati e provvisti di rondelle elastiche ?

**NL****Voordat U de dynamo monteert/controleert, dient U beslist op de volgende punten te letten:**

- Is de accu bedrijfsklaar en juist aangesloten ?
- Zit de V-riem goed vast en is deze in goede staat ?
- Zijn alle aansluitingen zorgvuldig uigevoerd ?
- Is het kabelnet in goede staat ?
- Zijn alle bouten en moeren zorgvuldig aangetrokken en van verende sluitringen voorzien ?

**PL****Przed wypróbowaniem wymienionego alternatora w swoim własnym interesie powinieneś sprawdzić następujące rzeczy:**

- Czy akumulator pojazdu jest w pełni sprawny, a przewody akumulatora są podłączone prawidłowo?
- Czy pasek klinowy jest w dobrym stanie i jest naciągnięty prawidłowo?
- Czy wszystkie podłączenia są wykonane prawidłowo i odpowiednio dociśnięte?
- Czy przewody elektryczne są w dobrym stanie?
- Czy śruby i nakrętki są odpowiednio dokręcone i zostały użyte podkładki sprężyste?

**S****Före montering och testning av den nya generatorm, bör man först försäkra sig om att följanda punkter är kontrollerade:**

- Är batteriet OK ?
- Är fläktremmen sträckt och hel ?
- Är alla anslutningar korrekt gjorda ?
- Är kablar och anslutningar hela och i bra skick ?
- Kontrollera laddningsregulatorn. Fungerar den ?
- Är alla bultar och muttrar ordentligt spända med fjäderbrickor ?



D

**Bevor Sie den Anlasser einbauen / testen, müssen Sie unbedingt folgende Punkte beachten:**

- Ist die Batterie aufgeladen und betriebsbereit ?
- Sind die Batteriekabel und -pole sauber und fest verbunden ?
- Ist das Zündschloß in Ordnung ?
- Sind alle Zähne am Zahnkranz in Ordnung ?
- Sind alle Anschlüsse korrekt ausgeführt und sorgfältig angeschlossen ?
- Ist das Bordnetz in Ordnung ?
- Sind alle Bolzen und Muttern sorgfältig angezogen und mit Unterlegscheiben versehen ?

DK

**Før montering/test af startmotoren skal nedenstående tjekliste altid gennemgås:**

- Er batteriet opladet og driftsklart?
- Er batterikablerne og -polerne rengjorte og solidt tilsluttede?
- Er tændingslåsen i orden?
- Er alle tandkransens tænder i orden?
- Er alle tilslutninger korrekt udførte og omhyggeligt tilsluttede?
- Er ledningsnettet i orden?
- Er alle bolte og møtrikker korrekt tilspændte og forsynede med skiver?

E

**Antes de montar/probar el arranque, debe tener en cuenta los siguientes puntos:**

- ¿La batería está cargada y lista para funcionar?
- ¿Los cables y polos de la batería están limpios y bien conectados?
- ¿El contacto está bien?
- ¿Todos los dientes de la corona dentada están bien?
- ¿Todas las conexiones están bien realizadas y empalmadas?
- ¿La red de distribución eléctrica está bien?
- ¿Todos los pernos y tuercas están bien apretados y provistos de arandelas?

F

**Avant de monter / tester le démarreur, les points ci-après doivent être obligatoirement respectés :**

- La batterie est-elle chargée et prête à l'emploi ?
- Les câbles et bornes de batterie sont-ils propres et solidement fixés ?
- La serrure de contact d'allumage est-elle en bon état ?
- Toutes les dents de la couronne dentée sont-elles en bon état ?
- Toutes les connexions sont-elles correctement réalisées et soigneusement établies ?
- Le réseau de bord est-il en bon état ?
- Tous les boulons et écrous sont-ils correctement serrés et munis de rondelles ?

FI

**Ennen käynnistysmoottorin asennusta/testausta on ehdottomasti tarkistettava seuraavat seikat:**

- Onko akku ladattu ja käyttövalmis?
- Ovatko akkukaapelit ja akun navat puhtaat ja liitokset kunnolla paikallaan?
- Onko virtalukko kunnossa?
- Ovatko hammaskehän kaikki hampaat kunnossa?
- Onko kaikki liitännät tehty oikein ja liitetty huolellisesti?
- Onko sähköjärjestelmä kunnossa?
- Onko kaikki pultit ja mutterit kiristetty huolellisesti, onko niiden alla aluslevyt?

GB

**Before installing / testing the starter, be sure to observe the following points:**

- Is the battery charged and ready for operation?
- Are the battery cables and terminals clean and tightly connected?
- Is the ignition lock in good working order?
- Are all teeth on the gear wheel in good working order?
- Have all connections been made carefully and correctly?
- Are the on-board mains functional?
- Are all bolts and nuts carefully tightened and equipped with washers?

I

**Prima di montare / testare il motorino di avviamento, attenersi assolutamente ai seguenti punti:**

- La batteria è carica e pronta al funzionamento?
- Il cavo batteria e i poli batteria sono puliti e collegati saldamente?
- Il blocchetto di accensione è regolare?
- Tutti i denti e la corona dentata sono regolari?
- Tutte le connessioni sono eseguite in maniera corretta e collegate accuratamente?
- La rete di bordo è regolare?
- Tutti i bulloni e i dadi sono accuratamente stretti e dotati di rondelle?

NL

**Alvorens de starter in te bouwen / te testen, altijd beslist eerst de volgende punten controleren:**

- Is de batterij opgeladen en bedrijfsklaar ?
- Zijn de batterijkabels en -polen schoon en goed (vast) aangesloten ?
- Is het contactslot in orde ?
- Zijn alle tanden van de tandkrans in orde ?
- Zijn alle aansluitingen correct uitgevoerd en zorgvuldig aangesloten ?
- Is het boordnet in orde ?
- Zijn alle bouten en moeren zorgvuldig aangehaald en van onderleggingen voorzien ?

PL

**Przed zamontowaniem / testowaniem startera należy zwrócić uwagę na następujące punkty:**

- Czy akumulator jest naładowany i gotowy do pracy?
- Czy przewody i zaciski są czyste i prawidłowo podłączone?
- Czy przełącznik zapłonu jest w dobrym stanie?
- Czy wszystkie zęby na kole zębatym są w dobrym stanie?
- Czy wszystkie złącza są prawidłowo wyprowadzone i połączone?
- Czy instalacja elektryczna jest w dobrym stanie?
- Czy wszystkie śruby i nakrętki są odpowiednio dokręcone i mają podkładki?

S

**Innan du bygger in resp. testar startmotorn måste du ovillkorligen säkerställa att följande punkter är uppfyllda:**

- Är batteriet laddat och redo att använda?
- Är batterikabeln och batteripolerna rena och korrekt anslutna?
- Är tändningslåset i ordning?
- Är alla kuggar i kuggkransen intakta?
- Är alla anslutningar korrekt utförda och noggrant tillkopplade?
- Är spänningsförsörjningen i ordning?
- Är alla bultar och muttrar ordentligt åtdragna och försedda med brickor?

**D****Allgemeine Bedingungen für die Altteilrückgabe:**

- Das Altteil muss anhand einer Originalnummer, oder sonstiger Nummer, eindeutig identifizierbar sein
- Die Nummer des Altteils muss in der aktuell gültigen Vergleichsliste enthalten sein
- Altteilrückgaben sind nur im Verhältnis 1:1 gestattet, d.h. die Nummer des Altteils muss in der Vergleichsliste zum gelieferten Aggregat aufgeführt sein
- Die Rückgabe muss in originaler HC-Parts Verpackung erfolgen
- Das Altteil muss vollständig, ohne äußerliche Schäden und in einem instandsetzungsfähigem Zustand sein.

**DK****Generelle betingelser for returnering af brugte dele:**

- Den brugte del skal kunne identificeres entydigt ved hjælp af et originalnummer eller andet nummer.
- Nummeret på den brugte del skal fremgå af den gældende vognliste.
- Returnering af brugte dele er kun tilladt i forholdet 1 : 1, dvs. at nummeret på den brugte del skal fremgå af vognlisten for det leverede udstyr.
- Returneringen skal finde sted i den originale emballage fra HC-Parts.
- Den brugte del skal være komplet, uden synlige skader og i reparabel stand.

**E****Condiciones generales para la devolución de piezas antiguas:**

- La pieza antigua se debe poder identificar claramente con un número original o cualquier otro número
- El número de la pieza antigua debe estar incluido en la lista comparativa vigente actualmente
- Las devoluciones de piezas antiguas se permiten en una relación de 1:1, es decir el número de la pieza antigua debe aparecer en la lista comparativa del grupo suministrado
- La devolución se debe realizar con el embalaje original de HC-Parts
- La pieza antigua debe estar entera, sin daños externos y en un estado que permita su reparación

**F****Conditions générales pour la restitution des pièces anciennes :**

- La pièce ancienne doit pouvoir être clairement identifiée par son numéro d'origine ou un autre numéro
- Le numéro de la pièce ancienne doit figurer sur la liste comparative actuellement valable
- Les restitutions de pièces anciennes sont uniquement autorisées à l'identique, autrement dit le numéro de la pièce ancienne doit figurer sur la liste comparative pour le groupe livré
- La restitution doit s'effectuer dans l'emballage d'origine de HC-Parts
- La pièce ancienne doit être complète, sans dégâts apparents et dans un état empêchant toute remise en état.

**FI****Kierrätysosien yleiset palautusehdot:**

- Kierrätysosa on pystyttävä tunnistamaan selvästi alkuperäisnumeron tai muun numeron perusteella.
- Kierrätysosan numeron on sisällyttävä ajantasaiseen, voimassa olevaan vertailuluetteloon.
- Kierrätysosien palauttaminen on sallittu vain yksi yhteen eli kierrätysosan numero on mainittava vertailuluettelossa toimitetun aggregaatin kohdalla.
- Palautettavan tuotteen on oltava alkuperäisessä HC-Parts-pakkauksessaan.
- Kierrätysosan on oltava täydellinen ja käyttökunnossa, eikä siinä saa olla ulkoisia vaurioita.

**GB****General conditions for the return of old parts:**

- It must be possible to clearly identify the old part on the basis of an original or other number
- The number of the old part must be included in the currently valid comparison list
- Returns of old parts are only allowed in a ratio of 1:1, meaning that the number of the old part must be listed in the comparison list for the delivered unit
- The return must take place in original HC-Parts packaging
- The old part must be complete, without visible damage and in a repairable condition.

**I****Condizioni generali per la restituzione dei componenti usati:**

- Il componente deve essere identificato in maniera univoca da un numero originale o da un altro numero.
- Il numero del componente usato deve essere contenuto dall'elenco di riferimento attualmente valido.
- La restituzione dei componenti usati è del tipo 1:1, ovvero il numero del componente usato deve essere elencato nell'elenco di riferimento dell'unità fornita.
- Per la restituzione deve essere utilizzato l'imballaggio HC-Parts originale.
- Il componente usato deve essere completo, privo di danni visibili e in condizioni riparabili.

**NL****Algemene voorwaarden voor teruggave van oude onderdelen:**

- Het oude onderdeel moet aan de hand van een origineel nummer, of een ander nummer, eenduidig identificeerbaar zijn
- Het nummer van het oude onderdeel moet in de geldige vergelijkingstabel staan
- Teruggave van oude onderdelen is alleen toegestaan in de verhouding 1:1, d.w.z. het nummer van het oude onderdeel moet staan vermeld in de vergelijkingstabel voor de geleverde unit
- Teruggave dient in de originele HC-Parts verpakking te geschieden
- Het oude onderdeel moet compleet, zonder uitwendige beschadigingen en in repareerbare staat verkeren.

**PL****Ogólne warunki zwrotu wadliwych części:**

- Wadliwa część musi mieć oryginalny numer lub inny numer musi jednoznacznie ją identyfikować
- Numer wadliwej części musi występować na aktualnej liście kontrolnej
- Zwroty wadliwych części są możliwe tylko przy wymianie 1:1; do wysłanej części należy dołączyć numer z listy kontrolnej
- Zwrot musi nastąpić w oryginalnym opakowaniu HC-Parts
- Wadliwa część musi być oddana w całości, bez zewnętrznych uszkodzeń i w stanie gotowym do przeglądu.

**S****Allmänna villkor för retur av begagnade aggregat:**

- Det begagnade aggregatet SKALL kunna entydigt identifieras med ett originalnummer eller annat nummer
- Numret på det begagnade aggregatet SKALL finnas i den aktuella checklisten
- Utbyte av aggregat SKALL sker bara i ett 1:1-förhållande, dvs. numret på det returnerade aggregatet SKALL påföras det levererade aggregatet i checklisten
- Aggregatet SKALL returneras i originalförpackningen från HC-Parts
- Det begagnade aggregatet SKALL vara komplett, får inte ha några yttre skador och måste vara i ett reparerbart skick.



**Gründe, um die Annahme von Altteilen zu verweigern •  
 Årsager til afvisning af returenheder •  
 Razones para la devolución de piezas recuperadas •  
 Causes de rejet des consignes • Hylkäämiseen syyt •  
 Reasons for old core rejecting • Motivazioni di rifiuto reso carcassa •  
 Redenen voor weigering oude inruildelen •  
 Powody odmowy przyjęcia podzespołów do regeneracji •  
 Orsaker till avslag på stommar.**

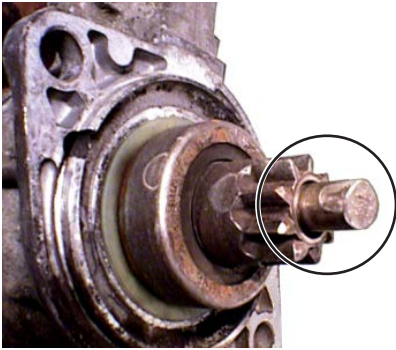

- (D) Ankerwelle abgesägt/abgebrochen
- (DK) Beskadiget ankeraksel
- (E) Rotura o desgaste del eje del rotor
- (F) Arbre d'induit scié/cassé
- (FI) Ankkurin akseli vaurioitunut
- (GB) Armature shaft cut/ broken off
- (I) Motivazioni di rifiuto reso carcassa
- (NL) Tandwielas afgebroken/ as anker afgebroken
- (PL) Złamany lub ucięty wałek wirnika
- (S) Ankaraxel skadad el. av



- (D) Befestigungsflansch abgebrochen
- (DK) Manglende øre
- (E) Soporte de fijación roto
- (F) Flasque de fixation cassé
- (FI) Kiinnityskorva rikki
- (GB) Fixing hole broken off
- (I) Foro di fissaggio spaccato
- (NL) Bevestigingsgat afgebroken
- (PL) Wyłamane otwory mocujące
- (S) Infästning skadad



- (D) Magnetschalter fehlt
- (DK) Manglende relæ
- (E) Falta de automatico
- (F) Relais manquant
- (FI) Solenoidi puuttuu
- (GB) Solenoid missing
- (I) Mancanza solenoide
- (NL) Startrelais / magneetschakelaar ontbreekt
- (PL) Brak elektromagnesu
- (S) Solenoid saknas

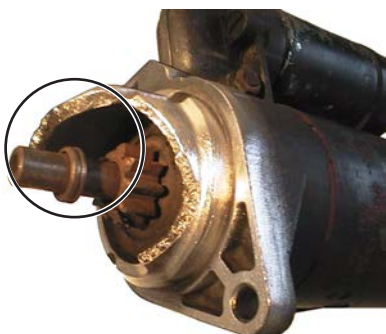

- (D) Antriebslagerschild gebrochen
- (DK) Defekt bendikshus
- (E) Tapa delantera rota
- (F) Palier de commande cassé
- (FI) Vetopääty vioittunut
- (GB) D.E. bracket damaged
- (I) Supporto lato pignone danneggiato
- (NL) Tandwielashuis beschadigd/ afgebroken
- (PL) Połamana głowica
- (S) Gavel skadad



- (D) Schaden unter Stecker
- (DK) Skade under stikforbindelse
- (E) Daños bajo el conector de enchufe
- (F) Endommagement sous le connecteur mâle
- (FI) Vaurioitunut alaosan liitäntä
- (GB) Damage underneath plug connector
- (I) Danno sotto il connettore a spina
- (NL) Schade onder contactstop
- (PL) Uszkodzenie pod wtyczką złącza
- (S) Skada under pluggen



- (D) Schleifringlagerschild beschädigt
- (DK) Beskadiget bagdæksel
- (E) Tapa trasera rota
- (F) Palier endommagé
- (FI) Pääty rikki
- (GB) C.E. bracket broken
- (I) Supporto lato collettore rotto
- (NL) Statorhuis gebroken / beschadigd
- (PL) Połamana obudowa alternatora
- (S) Gavel skadad

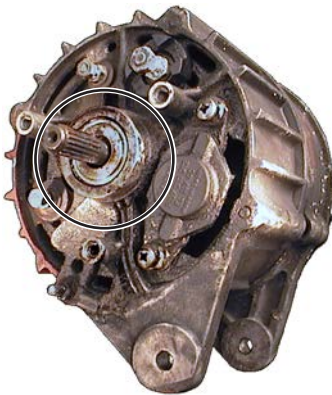

- (D) Vakuumpumpe fehlt
- (DK) Manglende vakuumpumpe
- (E) Falta el depresor
- (F) Pompe a vide manquante
- (FI) Alipainepumppu puuttuu
- (GB) Vacuum pump missing
- (I) Manca pompa vacuum
- (NL) Vacuum pomp ontbreekt
- (PL) Brak pompy próżniowej
- (S) Vakuumpump saknas



- (D) Befestigungsloch beschädigt
- (DK) Beskadiget øre
- (E) Tapa delantera rota o deteriorada
- (F) Trou de fixation endommagé
- (FI) Kiinnityskorva vioittunut
- (GB) Fixing hole damaged
- (I) Foro di fissaggio danneggiato
- (NL) Bevestigingsgat beschadigd / afgebroken
- (PL) Połamane otwory mocujące
- (S) Infästning skadad



- (D) Befestigungsloch ausgeschlagen
- (DK) Utlejret opspændingshul
- (E) Agujero de fijación desgastado
- (F) Trou de fixation endommagé
- (FI) Kiinnityskorva kulunut käyttökelvottomaksi
- (GB) Fixing hole worn out
- (I) Foro di fissaggio logoro
- (NL) Bevestigingsgat "uitgelubberd" en niet meer te gebruiken
- (PL) Zniszczone otwory mocujące
- (S) Infästning skadad



**Mögliche Ursachen für die Ablehnung der Garantie •  
 Mulige årsager for garantiafvisning •  
 Posibles razones para al rechazo de garantias •  
 Raisons des refus des garanties •  
 Mahdollisä tapauksia vaktus hylkäyksin •**



- (D) Fehlerhafter Zündschalter
- (DK) Fejlbehæftet tændingskontakt
- (E) Interruptor de encendido averiado
- (F) Commutateur d'allumage défectueux
- (FI) Viallinen virtalukko
- (GB) Faulty Ignitions switch
- (I) Blocchetti d' accensione difettosi
- (NL) Defecte ontstekingschakelaar
- (PL) Uszkodzony przełącznik zapłonu
- (S) Defekt tändningskontakt



- (D) Das Gerät wurde durch Staub von der Kupplung verschmutzt
- (DK) Enheden er blevet forurennet af støv fra bilens kobling
- (E) El dispositivo se ha ensuciado con polvo procedente del embrague del automóvil
- (F) Le dispositif a été sali par la poussière provenant de l'embrayage de la voiture
- (FI) Laitteeseen on päässyt pölyä auton kytkimestä.
- (GB) The device has been contaminated by dust from the car's clutch
- (I) Il dispositivo è stato contaminato da polvere proveniente dalla frizione dell'autovettura.
- (NL) Het apparaat is verontreinigd door stof van de koppeling van de auto
- (PL) Urządzenie zostało zanieczyszczone pyłem ze sprzęgła samochodu
- (S) Enheten har utsatts för smuts från bilens koppling



- (D) Defekte Antriebe/Zahnräder
- (DK) Fejlbehæftede drev/spidshjul
- (E) Engranajes/piñones dañados
- (F) Entraînements / pignons défectueux
- (FI) Vialliset käyttölaitteet/hammaspyörät
- (GB) Defective Drives / Pinions
- (I) Trasmissioni/pignoni difettosi
- (NL) Defect aandrijftandwiel
- (PL) Uszkodzone tarcze / koła zębate
- (S) Defekta drev/drivhjul



- (D) Alle Komponenten sind beschädigt durch das Eindringen von Sand bzw. Erde, was durch Fahren unter extremen Bedingungen verursacht wurde
- (DK) Alle komponenterne er blevet beskadiget af sand/snavs, der er trængt ind ved kørsel under ekstreme forhold
- (E) Todos los componentes han resultado dañados por penetración de arena/suciedad como consecuencia de la conducción en condiciones extremas
- (F) Tous les composants ont été endommagés par la pénétration du sable/ de la saleté à cause d'une conduite dans des conditions extrêmes
- (FI) Kaikki osat ovat vaurioituneet hiekan tai pölyn vuoksi ajettaessa ääriolosuhteissa.
- (GB) All the component have been damaged from sand/dirt incursion from driving in extreme conditions
- (I) Tutti i componenti sono stati danneggiati da penetrazioni di sabbia/polvere dovute alla guida in condizioni estreme.
- (NL) Alle onderdelen zijn beschadigd door binnengedrongen zand/vuil veroorzaakt door rijden in extreme omstandigheden
- (PL) Komponenty zostały uszkodzone pod wpływem piasku/brudu, który dostał się do ich wnętrza podczas jazdy w trudnych warunkach
- (S) Samtliga komponenter har skadats av sand/smuts som trängt in på grund av körning i extrema förhållanden





**Possible reasons for warranty rejections •  
Motivazioni per possibile contestazione garanzia •  
Mogelijke redenen voor afwijzing van een garantie aanvraag •  
Możliwe powody odrzucenia gwarancji •  
Möjliga orsaker till garantiavslag.**



- Ⓓ Das Gerät weist deutliche Spuren eines Eindringens von Öl aus der Vakuumpumpe oder den Anschlussschläuchen auf
- ⒹK Enheden bærer tydeligt præg af indtrængninger fra enhedens vakuumpumpe eller forbindelsesslanger
- Ⓔ El conjunto presenta huellas inequívocas de penetración de aceite procedente de la bomba de vacío o de las mangueras de conexión del conjunto
- Ⓕ L'unité porte des traces de pénétration d'huile provenant de sa pompe à vide ou de ses flexibles de raccordement.
- ⒻI Laitteessa on selkeitä merkkejä tyhjiöpumpusta tai letkuista tulleesta öljystä.
- ⒻB The unit bears clear traces of oil incursions from the unit's vacuum pump or connecting hoses
- ⒻI L'unità presenta tracce di penetrazioni d'olio provenienti dalla pompa del vuoto o dai tubi flessibili di collegamento dell'unità.
- ⒻNL Het onderdeel vertoont duidelijk sporen van binnengedrongen olie uit de vacuümpomp of de aangesloten slangen van het onderdeel
- ⒻPL Urządzenie nosi ślady oleju wydostającego się z pompy próżniowej lub przewodów łączących
- ⒻS Enheten uppvisar tydliga spår av inträngande olja från enhetens vakuumpump eller anslutningsslangar



- Ⓓ Das Gerät weist außen wie innen Ölablagerungen auf, die vom Motor stammen
- ⒹK Enheden er både indvendig og udvendig fyldt med olie fra bilens motor
- Ⓔ El dispositivo está lleno de aceite, tanto externa como internamente, procedente del motor del automóvil.
- Ⓕ L'extérieur et l'intérieur du dispositif sont remplis d'huile provenant du moteur de la voiture.
- ⒻI Laitteen ulkopinnoilla ja sisällä on auton moottorista peräisin olevaa öljyä.
- ⒻB The device is both externally and internally filled with oil from the car's engine
- ⒻI Il dispositivo è pieno sia esternamente che internamente di olio proveniente dal motore dell'autovettura.
- ⒻNL Het onderdeel is zowel van buiten als van binnen doordrenkt met olie van de motor
- ⒻPL Olej silnikowy znajduje się wewnątrz, jak i na zewnątrz urządzenia
- ⒻS Enheten är full av olja från bilens motor, både invändigt och utvändigt



- Ⓓ Alle Komponenten sind beschädigt durch das Eindringen von Wasser, das von der Straße oder einem Dampfreiniger stammt.
- ⒹK Alle komponenterne er blevet beskadiget ved vandindtrængning fra vejbanen eller fra damprengøring
- Ⓔ Todos los componentes han resultado dañados por la penetración de agua de la carretera o del sistema de limpieza con vapor
- Ⓕ Tous les composants ont été endommagés par la pénétration de l'eau provenant de la route ou du nettoyage à la vapeur.
- ⒻI Kaikki osat ovat vaurioituneet veden vuoksi, joka on peräisin tieltä tai höyrypuhdistuksesta.
- ⒻB All the component have been damaged from water incursion from the road or from steam cleaning
- ⒻI Tutti i componenti sono stati danneggiati da penetrazioni di acqua proveniente dalla strada o dalla pulizia a vapore.
- ⒻNL Alle onderdelen zijn beschadigd door binnengedrongen water van de weg of door stoomreiniging
- ⒻPL Wszystkie części zostały zniszczone przez wnikanie wody z drogi lub z powodu czyszczenia parowego
- ⒻS Samtliga komponenter har skadats av vatten som trängt in, endera från vägstänk eller ångrengöring





D

TYPENÜBERSICHT

DK

TYPE OVERSIGT

E

CATALOGO DE TIPOS

F

SOMMARIE

FI

YHTEENVETO

GB

TYPE SUMMARY

I

PROSPETTO

NL

TYPE-OVERZICHT

PL

ZESTAWIENIE TYPÓW

S

TYP ÖVERSIKT

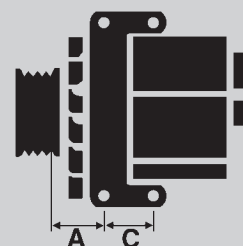
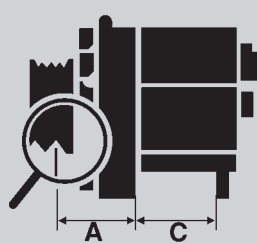
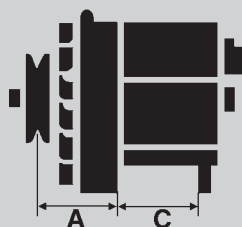
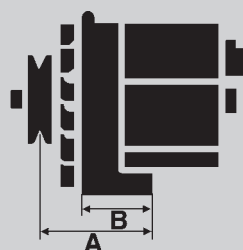



CA 15 H#	CA 17 H	CA 17 V
<p>14 V 28 Amp.  <b>B: 10.0 C: 82.0 mm.</b>            Ford, Triumph, Vauxhall</p>	<p>14 V 34 Amp.  <b>B: 10.0 C: 87.0 mm.</b>            Austin, Case, Ford, Land Rover, LDV, Lotus, MG, Morris, Plymouth, Talbot, Triumph, Vauxhall</p>	<p>14 V 34 Amp.  <b>B: 10.0 C: 86.5 mm.</b>            Ford, Jaguar, Land Rover, Lotus, Mercury, Triumph, Vauxhall</p>

CA 18 H	CA 18 V	CA 23 V
<p>14 V 43 Amp.  <b>B: 10.0 C: 87.0 mm.</b>            Austin, Case, Daimler, Ford, Land Rover, LDV, MG, Morris, Rover, Triumph, Vauxhall</p>	<p>14 V 43 Amp.  <b>B: 10.0 C: 87.5 mm.</b>            Ford, Land Rover, Rover, Triumph, Vauxhall</p>	<p>W  <b>B: 27.0 mm.</b>            Massey Ferguson</p>

CA 35 IR	CA 42 IR	CA 48 IR
<p>14 V 35 Amp.  <b>B: 56.0 mm.</b>            Audi, DAF, VW</p>	<p>P  <b>A: 76.5 B: 56.0 mm.</b>            Bedford, Opel, Vauxhall</p>	<p>P  <b>A: 77.0 B: 56.0 mm.</b>            Opel, Saab, Vauxhall</p>

CA 52 IR	CA 60 IR	CA 61 IR
<p>14 V 55 Amp.  <b>B: 56.0 mm.</b>            Alfa Romeo, American Motors, Audi, VW</p>	<p>P  <b>A: 35.0 B: 11.5 C: 81.0 mm.</b>            Ford</p>	<p>P  <b>A: 36.5 B: 11.0 C: 80.5 mm.</b>            Austin, Daimler, Ford</p>











<p><b>CA 69 IR</b></p>  <p><b>P</b> 14 V 35 Amp.  <b>A:</b> 76.0 <b>B:</b> 56.0 mm.                      Mercedes-Benz</p> 	<p><b>CA 70*</b></p>  <p><b>DP</b> 14 V 55 Amp.  <b>A:</b> 77.0 <b>B:</b> 56.0 mm.                      Lamborghini, Mercedes-Benz</p> 	<p><b>CA 76</b></p>  <p><b>P</b> 14 V 28 Amp.  <b>A:</b> 76.5 <b>B:</b> 56.0 mm.                      Case, Fendt</p>
<p><b>CA 76 IR</b></p>  <p><b>P</b> 14 V 33 Amp.  <b>A:</b> 76.5 <b>B:</b> 56.0 mm.                      Case, Claas, Deutz-Fahr, Fendt, Goldoni</p>	<p><b>CA 77 IR</b></p>  <p><b>P</b> 14 V 33 Amp.  <b>A:</b> 48.5 <b>B:</b> 24.5 <b>C:</b> 73.5 mm.                      Fiat, Lamborghini, Same, Zastava</p> 	<p><b>CA 85 IR</b></p>  <p>14 V 55 Amp.  <b>B:</b> 56.0 mm.                      Audi, VW</p> 
<p><b>CA 87 IR</b></p>  <p><b>P</b> 14 V 55 Amp.  <b>A:</b> 77.0 <b>B:</b> 56.0 mm.                      Mercedes-Benz, Seat</p> 	<p><b>CA 88 IR</b></p>  <p><b>DP</b> 14 V 55 Amp.  <b>A:</b> 92.0 <b>B:</b> 71.0 mm.                      Volvo</p>	<p><b>CA 93 IR</b></p>  <p>14 V 51 Amp.                      VW</p>
<p><b>CA 94 IR</b></p>  <p><b>P</b> 14 V 55 Amp.  <b>A:</b> 36.0 <b>B:</b> 10.0 <b>C:</b> 81.0 mm.                      Ford, Mercury</p> 	<p><b>CA 96 IR</b></p>  <p><b>P</b> 14 V 55 Amp.  <b>A:</b> 36.5 <b>B:</b> 11.0 <b>C:</b> 81.0 mm.                      Austin, Ford, Hatz, Massey Ferguson, Renault</p> 	<p><b>CA 99 IR</b></p>  <p><b>P</b> 14 V 55 Amp.  <b>A:</b> 77.0 <b>B:</b> 56.0 mm.                      Lancia, Opel, Vauxhall</p>

























CA 140 IR	CA 141 IR	CA 150 IR
<p>P A: 109.5    B: 56.0 mm. Audi, VW</p> <p>14 V    45 Amp.</p>	<p>P A: 109.0    B: 56.0 mm. Audi, VW</p> <p>14 V    65 Amp.</p>	<p>P A: 49.0    B: 27.0 C: 65.0 mm. Citroen, Fiat, Peugeot</p> <p>14 V    50 Amp.</p>
CA 158 IR	CA 163 IR	CA 165 IR
<p>P A: 85.0    B: 56.0 mm. Bedford, Opel, Vauxhall</p> <p>14 V    45 Amp.</p>	<p>P A: 82.0    B: 56.0 mm. Audi, Porsche, VW</p> <p>14 V    75 Amp.</p>	<p>P A: 49.0    B: 27.0 C: 65.0 mm. Dacia, Renault, Volvo</p> <p>14 V    50 Amp.</p>
CA 169 IR	CA 170 IR	CA 172 IR#
<p>P A: 66.0    B: 27.0 mm. Renault</p> <p>14 V    50 Amp.</p>	<p>P A: 101.5    B: 56.0 mm. Renault</p> <p>14 V    55 Amp.</p>	<p>P A: 61.0    B: 40.0 mm. Citroen</p> <p>14 V    35 Amp.</p>
CA 175 IR	CA 186 IR	CA 187 IR
<p>P A: 61.0    B: 36.0 C: 52.0 mm. Citroen, Peugeot</p> <p>14 V    70 Amp.</p>	<p>W B: 80.0 mm. MAN, Mercedes-Benz</p> <p>14 V    55 Amp.</p>	<p>W B: 80.0 mm. Mercedes-Benz</p> <p>28 V    27 Amp.</p>



CA 190 IR		CA 195 IR		CA 196 IR	
					
<b>P</b> A: 36.5 Austin, Ford, Mercury, Renault	<b>14 V 35 Amp.</b> B: 10.5 C: 81.0 mm.	<b>P</b> A: 77.0 Ferrari, Fiat, Lancia, Mercedes-Benz, Zetor	<b>14 V 65 Amp.</b> B: 56.0 mm.	<b>P</b> A: 77.0 BMW	<b>14 V 65 Amp.</b> B: 56.0 mm.
					

CA 199 IR		CA 205 IR		CA 207 IR	
					
<b>P</b> A: 74.0 BMW	<b>14 V 65 Amp.</b> B: 51.0 mm.	<b>14 V 45 Amp.</b> B: 56.0 mm. VW		<b>P</b> A: 77.0 Saab	<b>14 V 70 Amp.</b> B: 56.0 mm.
					

CA 212 IR		CA 221 IR		CA 222 IR	
					
<b>P</b> A: 45.0 Fiat-Allis, Iveco	<b>28 V 27 Amp.</b> B: 17.0 C: 63.0 mm.	<b>P</b> A: 77.0 Opel, Vauxhall	<b>14 V 65 Amp.</b> B: 56.0 mm.	<b>W</b> B: 80.0 mm. MAN	<b>28 V 35 Amp.</b>

CA 224 IR		CA 226 IR		CA 227 IR	
					
<b>P</b> A: 49.0 Renault, VW	<b>14 V 50 Amp.</b> B: 27.0 C: 65.0 mm.	<b>P / W</b> A: 36.0 Ford, Massey Ferguson, Morris	<b>14 V 55 Amp.</b> B: 11.0 C: 81.0 mm.	<b>W</b> B: 80.0 mm. Scania	<b>28 V 55 Amp.</b>
					













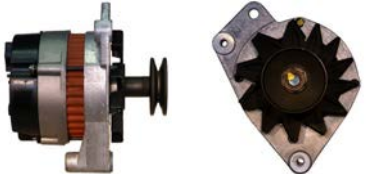

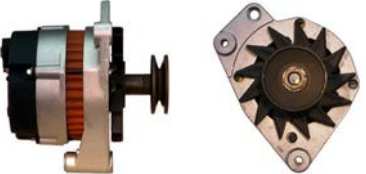
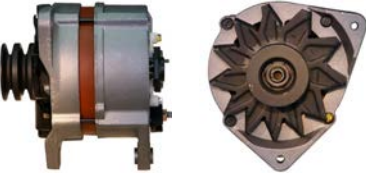
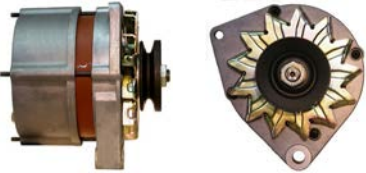
CA 229 IR	CA 235 IR#	CA 237 IR
<p><b>P</b> A: 49.0    B: 27.0 Citroen, Renault, Talbot</p> <p>14 V    70 Amp. C: 65.0 mm.</p>	<p><b>P</b> A: 77.0    B: 56.0 mm. Alfa Romeo</p> <p>14 V    45 Amp.</p>	<p><b>P / W</b> A: 110.0    B: 56.0 mm. Audi, VW</p> <p>14 V    65 Amp.</p>
CA 238 IR	CA 240 IR	CA 241 IR
<p><b>DP / W</b> A: 94.5    B: 56.0 mm. Deutz-Fahr, Fendt, Marshall, Steyr, Volvo, VW</p> <p>14 V    55 Amp.</p>	<p><b>W</b> B: 80.0 mm. DAF, MAN</p> <p>28 V    55 Amp.</p>	<p><b>P</b> A: 109.0    B: 56.0 mm. Audi, VW</p> <p>14 V    55 Amp.</p>
CA 242 IR	CA 251 IR	CA 252 IR
<p><b>P</b> A: 110.0    B: 56.0 mm. Audi, VW</p> <p>14 V    65 Amp.</p>	<p><b>P</b> A: 77.5    B: 56.0 mm. BMW</p> <p>14 V    80 Amp.</p>	<p><b>P</b> A: 52.0    B: 23.5    C: 74.5 mm. Audi, Autobianchi, Fiat, Innocenti, Lancia, VW, Zastava</p> <p>14 V    55 Amp.</p>
CA 254 IR	CA 255 IR	CA 263 IR
<p><b>P</b> A: 52.0    B: 23.5    C: 73.5 mm. Autobianchi, Fiat, Lancia, Zastava</p> <p>14 V    65 Amp.</p>	<p><b>P</b> A: 49.0    B: 16.5    C: 64.5 mm. Alfa Romeo, Fiat, Iveco, Lamborghini, Same</p> <p>14 V    45 Amp.</p>	<p><b>P</b> A: 77.0    B: 56.0 mm. Mercedes-Benz</p> <p>14 V    80 Amp.</p>

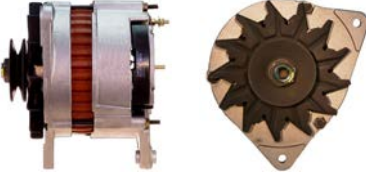

CA 264 IR	CA 268 IR	CA 276 IR
		
		
<b>P</b> <b>A: 84.5</b> <b>B: 56.0 mm.</b> Bedford, Opel, Vauxhall	<b>P</b> <b>A: 49.0</b> <b>B: 27.0</b> Renault	<b>P</b> <b>A: 77.0</b> <b>B: 56.0 mm.</b> VW
		
CA 277 IR#	CA 287 IR	CA 288 IR
		
		
<b>P</b> <b>A: 99.0</b> <b>B: 56.0 mm.</b> VW	<b>P</b> <b>A: 77.0</b> <b>B: 56.0 mm.</b> Mercedes-Benz	<b>P</b> <b>A: 102.0</b> <b>B: 56.0 mm.</b> Renault
		
CA 289 IR	CA 290 IR	CA 291 IR
		
		
<b>P</b> <b>A: 73.0</b> <b>B: 27.0</b> <b>C: 65.5 mm.</b> Volvo	<b>BS</b> <b>B: 10.0</b> <b>C: 86.5 mm.</b> Austin, Ford	<b>P</b> <b>A: 60.0</b> <b>B: 40.0 mm.</b> Citroen, Peugeot, Talbot
		
CA 293 IR	CA 294 IR	CA 295 IR
		
		
<b>P / W</b> <b>A: 36.0</b> <b>B: 11.0</b> <b>C: 80.5 mm.</b> Austin, Ford, MG, Rover	<b>SP</b> <b>A: 46.0</b> <b>B: 27.0</b> <b>C: 69.0 mm.</b> Citroen, Opel, Peugeot, Talbot	<b>P</b> <b>A: 44.5</b> <b>B: 18.5</b> <b>C: 60.5 mm.</b> Lada
		

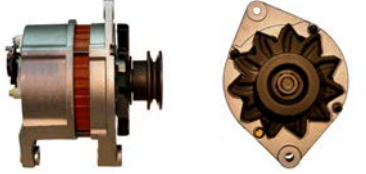
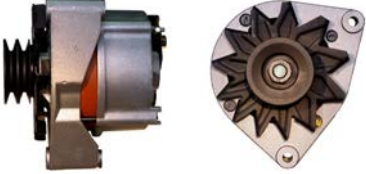
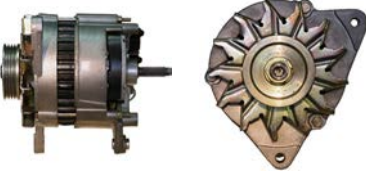



<p><b>CA 296 IR</b></p>	<p><b>CA 297 IR</b></p>	<p><b>CA 298 IR</b></p>
		
<p><b>P</b>                      <b>14 V</b>    <b>55 Amp.</b>  <b>A: 109.0</b>    <b>B: 56.0 mm.</b>                      Audi, VW</p>	<p><b>P</b>                      <b>14 V</b>    <b>45 Amp.</b>  <b>A: 99.0</b>        <b>B: 56.0 mm.</b>                      VW</p>	<p><b>P</b>                      <b>14 V</b>    <b>65 Amp.</b>  <b>A: 109.0</b>    <b>B: 56.0 mm.</b>                      Audi, Seat, VW</p>
<p><b>CA 299 IR</b></p>	<p><b>CA 300 IR</b></p>	<p><b>CA 302 IR</b></p>
		
<p><b>DP / W</b>                      <b>14 V</b>    <b>70 Amp.</b>  <b>A: 37.0</b>    <b>B: 14.0</b>    <b>C: 82.0 mm.</b>                      Ford</p>	<p><b>P</b>                      <b>14 V</b>    <b>55 Amp.</b>  <b>A: 52.0</b>    <b>B: 27.0 mm.</b>                      Alfa Romeo</p>	<p><b>P / W</b>                      <b>14 V</b>    <b>65 Amp.</b>  <b>A: 98.0</b>    <b>B: 56.0 mm.</b>                      Audi, Seat, VW</p>
<p><b>CA 305 IR</b></p>	<p><b>CA 306 IR</b></p>	<p><b>CA 307 IR</b></p>
		
<p><b>P / W</b>                      <b>14 V</b>    <b>55 Amp.</b>  <b>A: 35.0</b>    <b>B: 11.5</b>    <b>C: 83.0 mm.</b>                      Austin, Ford, Land Rover, MG, Rover, Valtra</p>	<p><b>P / W</b>                      <b>14 V</b>    <b>55 Amp.</b>  <b>A: 36.0</b>    <b>B: 11.5</b>    <b>C: 82.5 mm.</b>                      Ford, Rover</p>	<p><b>P</b>                      <b>14 V</b>    <b>45 Amp.</b>  <b>A: 54.0</b>    <b>B: 23.5 mm.</b>                      Autobianchi, Fiat, Lancia, Seat, Zastava</p>
		
<p><b>CA 308 IR</b></p>	<p><b>CA 310 IR</b></p>	<p><b>CA 311 IR</b></p>
		
<p><b>P</b>                      <b>14 V</b>    <b>50 Amp.</b>  <b>A: 63.0</b>    <b>B: 27.0</b>    <b>C: 66.0 mm.</b>                      Peugeot, Talbot</p>	<p><b>DP</b>                      <b>14 V</b>    <b>70 Amp.</b>  <b>A: 77.0</b>    <b>B: 56.0 mm.</b>                      Saab</p>	<p><b>SP / For VP / W</b>                      <b>14 V</b>    <b>55 Amp.</b>  <b>A: 34.0</b>    <b>B: 11.0</b>    <b>C: 83.0 mm.</b>                      Ford</p>
		







CA 312 IR	CA 313 IR	CA 314 IR
 	 	 
<b>P / W</b> A: 36.5    B: 10.5 Case, Ford, Valtra	<b>P</b> A: 66.0    B: 41.0 Seat	<b>P / W</b> A: 58.0    B: 27.0 Renault, Renault V.I.
<b>14 V 60 Amp.</b> C: 81.5 mm.	<b>14 V 55 Amp.</b> C: 41.0 mm.	<b>14 V 75 Amp.</b> C: 65.5 mm.
		
CA 315 IR	CA 316 IR	CA 317 IR
 	 	 
<b>P</b> A: 64.0    B: 27.0 Peugeot, Talbot	<b>P</b> A: 49.0    B: 17.0 Alfa Romeo, Citroen, Fiat, Iveco, Lamborghini, Same	<b>P</b> A: 102.0    B: 56.0 mm. Renault
<b>14 V 70 Amp.</b> C: 65.5 mm.	<b>14 V 55 Amp.</b> C: 64.0 mm.	<b>14 V 50 Amp.</b>
		
CA 318 IR	CA 319 IR	CA 320 IR
 	 	 
<b>P / W</b> A: 84.0    B: 56.0 mm. Audi, VW	<b>P / W</b> A: 110.0    B: 56.0 mm. VW	<b>P</b> A: 82.0    B: 56.0 mm. Audi, Opel, Seat, VW
<b>14 V 90 Amp.</b>	<b>14 V 65 Amp.</b>	<b>14 V 90 Amp.</b>
CA 321 IR	CA 322 IR	CA 324 IR
 	 	 
<b>SP</b> A: 92.0    B: 56.0 mm. Mercedes-Benz	<b>DP / W</b> A: 36.0    B: 14.0 Ford, Porsche	<b>W</b> B: 13.5    C: 82.0 mm. Daimler, Ford, Jaguar, Merkur
<b>14 V 55 Amp.</b>	<b>14 V 90 Amp.</b> C: 82.5 mm.	<b>14 V 90 Amp.</b>
		



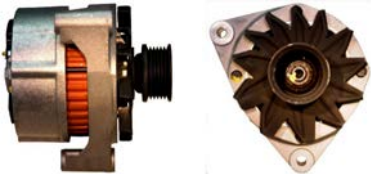
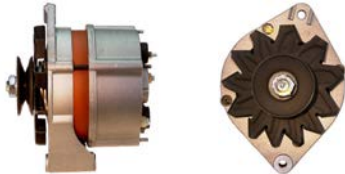



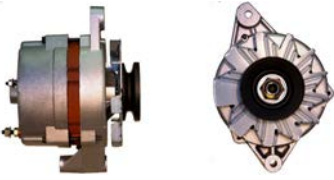

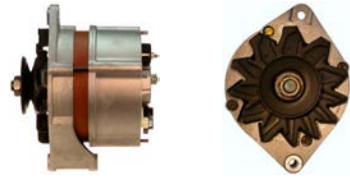
<p><b>CA 325 IR</b></p>	<p><b>CA 326 IR</b></p>	<p><b>CA 327 IR</b></p>
		
<p>P / W A: 37.0 B: 11.0 C: 83.0 mm. Ford, Land Rover, MG</p>	<p>28 V 70 Amp. B: 17.0 C: 63.0 mm. Fiat, Fiat-Allis, Iveco</p>	<p>P / W A: 113.0 B: 80.0 mm. MAN</p>
<p><b>CA 333 IR</b></p>	<p><b>CA 334 IR</b></p>	<p><b>CA 335 IR</b></p>
		
<p>W B: 80.0 mm. DAF, Kässbohrer, MAN, Mercedes-Benz, Padane, Ssangyong</p>	<p>28 V 55 Amp. W B: 80.0 mm. DAF</p>	<p>SP A: 92.0 B: 56.0 mm. Mercedes-Benz</p>
<p><b>CA 337 IR</b></p>	<p><b>CA 339 IR</b></p>	<p><b>CA 340 IR</b></p>
		
<p>P / W A: 109.0 B: 56.0 mm. Audi, VW</p>	<p>W B: 56.0 mm. Case, Claas, Eicher, Iveco, Mercedes-Benz</p>	<p>P / W A: 77.0 B: 56.0 mm. DAF, Deutz-Fahr, Iveco</p>
<p><b>CA 341 IR</b></p>	<p><b>CA 342 IR</b></p>	<p><b>CA 343 IR</b></p>
		
<p>W B: 56.0 mm. Atlas Copco, Iveco, Mercedes-Benz, Steyr</p>	<p>P A: 64.5 B: 14.0 C: 81.5 mm. Seat, VW</p>	<p>P A: 65.0 B: 14.0 C: 82.0 mm. Audi, Seat, VW</p>

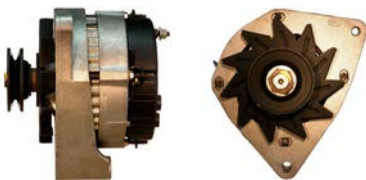

CA 345 IR	CA 347 IR	CA 350 IR
		
SP A: 92.0 B: 56.0 mm. Mercedes-Benz	P A: 77.5 B: 56.0 mm. VW	P A: 57.5 B: 32.0 mm. Fiat, Ford, Lancia
		

CA 352 IR	CA 353 IR	CA 354 IR
		
P A: 85.0 B: 56.0 mm. Bedford, Opel, Vauxhall	P A: 76.5 B: 56.5 mm. Lancia, Opel, Vauxhall	P A: 77.0 B: 56.0 mm. VW









CA 355 IR	CA 359 IR	CA 361 IR
		
P A: 49.0 B: 17.0 C: 64.5 mm. Alfa Romeo, Citroen, Fiat, Iveco, Lamborghini, Lancia, Same	P A: 94.5 B: 56.0 mm. Citroen, Peugeot	P A: 56.0 B: 27.0 C: 68.0 mm. Renault
		

CA 362 IR	CA 364 IR	CA 366 IR
		
P A: 81.5 B: 56.5 mm. BMW	W B: 56.0 mm. VW	W B: 51.0 mm. Valtra, Volvo, Volvo BM

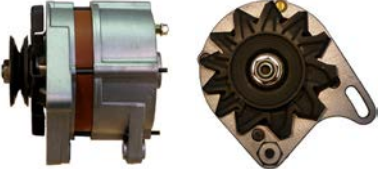

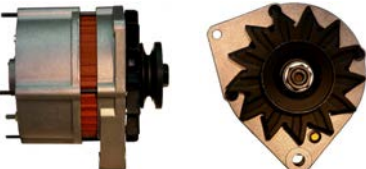
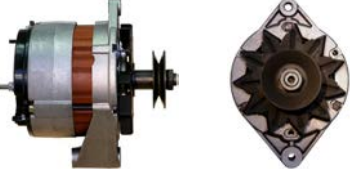
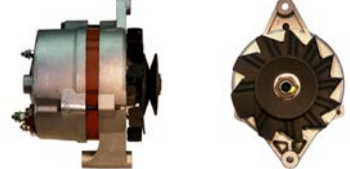
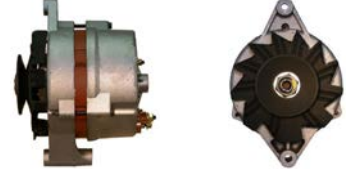

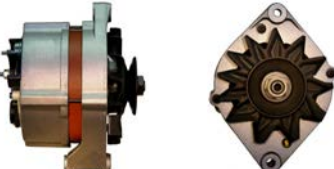





















<p><b>CA 367 IR</b></p>  <p>P / W A: 109.0 B: 56.0 mm. 14 V 45 Amp. Audi, VW</p> 	<p><b>CA 369 IR</b></p>  <p>P A: 72.0 B: 36.0 C: 56.0 mm. 14 V 50 Amp. Citroen, Peugeot</p> 	<p><b>CA 372 IR</b></p>  <p>SP A: 46.0 B: 27.0 C: 68.5 mm. 14 V 60 Amp. Renault, Volvo</p> 
<p><b>CA 373 IR</b></p>  <p>SP A: 46.5 B: 27.0 C: 70.0 mm. 14 V 60 Amp. Renault, Volvo</p> 	<p><b>CA 375 IR</b></p>  <p>P A: 101.0 B: 56.0 mm. 14 V 60 Amp. Renault</p> 	<p><b>CA 376 IR</b></p>  <p>P A: 77.0 B: 56.0 mm. 14 V 65 Amp. Seat, VW</p>
<p><b>CA 377 IR</b></p>  <p>P A: 49.0 B: 27.0 C: 65.5 mm. 14 V 70 Amp. Citroen, Peugeot</p>	<p><b>CA 378 IR</b></p>  <p>P / W A: 49.0 B: 27.0 C: 65.0 mm. 14 V 60 Amp. Renault</p> 	<p><b>CA 380 IR</b></p>  <p>SP A: 46.0 B: 27.0 C: 66.5 mm. 14 V 70 Amp. Citroen, Peugeot, Renault</p> 
<p><b>CA 381 IR</b></p>  <p>DP A: 93.0 B: 71.0 mm. 14 V 80 Amp. Volvo</p>	<p><b>CA 384 IR</b></p>  <p>P / VP / W A: 39.5 B: 13.5 C: 80.5 mm. 14 V 70 Amp. Opel, Vauxhall</p>	<p><b>CA 500 IR</b></p>  <p>W B: 51.0 mm. 28 V 55 Amp. Volvo <i>Mounting ear: I.D. 11 mm</i></p>





CA 501 IR	CA 503 IR	CA 504 IR
		
W B: 56.0 mm. Iveco, KHD	P A: 82.0    B: 56.0 mm. BMW, Piaggio	P A: 51.0    B: 23.5 C: 57.0 mm. Bertone, Fiat, Lancia
28 V    55 Amp.	14 V    90 Amp.	14 V    65 Amp.
CA 505 IR	CA 506 IR	CA 511 IR
		
P / W A: 99.0    B: 56.0 mm. VW	B: 16.5    C: 63.5 mm. Alfa Romeo, Ferrari, Fiat, Lancia	P A: 51.0    B: 27.0 mm. Alfa Romeo
14 V    45 Amp.	14 V    65 Amp.	14 V    65 Amp.
CA 512 IR	CA 513 IR	CA 514 IR
		
P A: 102.0    B: 56.0 mm. Renault	P A: 77.0    B: 56.0 mm. Bedford, Opel, Vauxhall	P A: 77.5    B: 56.5 mm. Bedford, Opel, Vauxhall
14 V    60 Amp.	14 V    55 Amp.	14 V    70 Amp.
		
CA 515 IR	CA 516 IR	CA 517 IR
		
P A: 78.0    B: 56.0 mm. Opel, Vauxhall	P / W A: 87.0    B: 56.0 mm. Bedford, Opel, Vauxhall	P A: 85.0    B: 56.0 mm. Opel, Vauxhall
14 V    90 Amp.	14 V    70 Amp.	14 V    70 Amp.





CA 518 IR		CA 519 IR		CA 520 IR	
					
W B: 51.0 mm. Volvo <i>Mounting ear: I.D. 14 mm</i>	28 V 55 Amp.	SP A: 46.0 B: 11.0 Opel, Vauxhall	14 V 65 Amp. C: 80.5 mm.	P / W A: 109.0 B: 56.0 mm. Audi, VW	14 V 65 Amp.
CA 521 IR		CA 522 IR		CA 524 IR	
					
P A: 31.0 B: 14.0 Audi, Seat, VW	14 V 90 Amp. C: 83.0 mm.	B: 56.0 mm. John Deere	14 V 55 Amp.	SP A: 46.5 B: 27.0 Renault	14 V 70 Amp. C: 66.0 mm.
CA 525 IR		CA 526 IR		CA 527 IR	
					
SP A: 46.0 B: 27.0 Citroen, Peugeot	14 V 50 Amp. C: 66.0 mm.	P / W A: 48.5 B: 27.0 Renault	14 V 70 Amp. C: 66.0 mm.	SP A: 47.0 B: 27.0 Renault	14 V 70 Amp. C: 67.5 mm.
CA 528 IR		CA 529 IR		CA 530 IR	
					
DP A: 94.0 B: 71.0 mm. Volvo	14 V 55 Amp.	SP A: 47.0 B: 27.0 Renault, Volvo	14 V 60 Amp. C: 68.0 mm.	P A: 35.0 B: 11.0 Opel	14 V 65 Amp. C: 81.0 mm.



















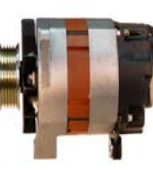













<p><b>CA 532 IR</b></p>  <p>SP A: 46.5    B: 27.0 Citroen, Peugeot, Talbot</p> <p>14 V    80 Amp. C: 65.0 mm.</p> 	<p><b>CA 533 IR</b></p>  <p>P A: 95.0    B: 56.0 mm. Citroen, Peugeot</p> <p>14 V    70 Amp.</p> 	<p><b>CA 534 IR</b></p>  <p>SP A: 49.0    B: 27.0 Eagle, Renault</p> <p>14 V    90 Amp. C: 66.0 mm.</p> 
<p><b>CA 535 IR</b></p>  <p>P / W A: 48.5    B: 27.0 Opel, Renault, Renault V.I.</p> <p>14 V    105 Amp. C: 66.0 mm.</p> 	<p><b>CA 537 IR</b></p>  <p>P A: 76.5    B: 56.0 mm. VW</p> <p>14 V    45 Amp.</p>	<p><b>CA 538 IR</b></p>  <p>P A: 61.0    B: 16.0 BMW</p> <p>14 V    80 Amp. C: 80.0 mm.</p>
<p><b>CA 540 IR</b></p>  <p>P A: 45.0    B: 16.0 BMW</p> <p>14 V    115 Amp. C: 80.0 mm.</p>	<p><b>CA 541 IR</b></p>  <p>P A: 46.0    B: 16.0 BMW</p> <p>14 V    90 Amp. C: 80.0 mm.</p>	<p><b>CA 542 IR</b></p>  <p>P A: 46.0    B: 16.0 BMW</p> <p>14 V    115 Amp. C: 80.0 mm.</p>
<p><b>CA 547 IR</b></p>  <p>P A: 45.0    B: 16.0 BMW</p> <p>14 V    90 Amp. C: 80.0 mm.</p>	<p><b>CA 548 IR#</b></p>  <p>P A: 84.5    B: 56.0 mm. Bedford, Opel, Vauxhall</p> <p>14 V    55 Amp.</p>	<p><b>CA 549 IR</b></p>  <p>P A: 56.0    B: 27.0 Renault</p> <p>14 V    60 Amp. C: 67.5 mm.</p> 



CA 550 IR		CA 556 IR		CA 557 IR	
W B: 27.0 Scania, Volvo	28 V 55 Amp. C: 68.0 mm.	SP / IF A: 42.5 B: 27.0 Citroen, Peugeot	14 V 80 Amp. C: 66.5 mm.	SP A: 46.0 B: 27.0 Renault	14 V 50 Amp. C: 68.5 mm.
CA 558 IR		CA 560 IR		CA 561 IR	
W B: 27.0 Scania	28 V 73 Amp. C: 68.0 mm.	P / W A: 36.5 B: 11.0 Ford, Land Rover	14 V 70 Amp. C: 83.0 mm.	SP / W A: 43.5 B: 11.5 Ford	14 V 55 Amp. C: 83.0 mm.
CA 562 IR		CA 563 IR		CA 564 IR	
SP / W A: 33.0 B: 11.5 Ford	14 V 70 Amp. C: 81.0 mm.	SP / W A: 33.0 B: 14.0 Ford	14 V 90 Amp. C: 82.0 mm.	P / W A: 37.5 B: 11.5 Austin, Dronningborg, Massey Ferguson, MG, New Holland, Nissan, Rover, Valtra	14 V 65 Amp. C: 83.5 mm.
CA 566 IR		CA 567 IR		CA 568 IR	
B: 56.0 mm. Mercedes-Benz, Saab	14 V 80 Amp.	SP A: 78.0 B: 56.0 mm. Saab	14 V 80 Amp.	W B: 80.0 mm. Mercedes-Benz	28 V 30 Amp.



<b>CA 569 IR</b>	<b>CA 570 IR</b>	<b>CA 572 IR</b>
 	 	 
<p>14 V 85 Amp.  <b>B: 17.0 C: 64.0 mm.</b>  Alfa Romeo, Fiat, Iveco, Lancia</p>	<p>P  14 V 70 Amp.  <b>A: 77.0 B: 56.0 mm.</b>  Opel, Vauxhall</p>	<p>P  14 V 55 Amp.  <b>A: 57.0 B: 32.5 mm.</b>  Autobianchi, Fiat, Lancia</p> 
<b>CA 574 IR</b>	<b>CA 579 IR</b>	<b>CA 580 IR</b>
 	 	 
<p>SP  14 V 70 Amp.  <b>A: 46.5 B: 27.0 C: 69.5 mm.</b>  Volvo</p> 	<p>SP  14 V 105 Amp.  <b>A: 49.0 B: 27.0 C: 66.0 mm.</b>  Renault</p> 	<p>SP  14 V 50 Amp.  <b>A: 49.0 B: 27.0 C: 67.5 mm.</b>  Renault</p> 
<b>CA 582 IR</b>	<b>CA 583 IR</b>	<b>CA 584 IR</b>
 	 	 
<p>SP / W  14 V 65 Amp.  <b>A: 35.0 B: 11.0 C: 83.5 mm.</b>  Rover</p> 	<p>SP  14 V 80 Amp.  <b>A: 45.5 B: 27.0 C: 66.5 mm.</b>  Citroen, Peugeot</p> 	<p>SP / W  14 V 55 Amp.  <b>A: 43.0 B: 11.5 C: 83.0 mm.</b>  Ford</p> 
<b>CA 586 IR</b>	<b>CA 587 IR</b>	<b>CA 588 IR</b>
 	 	 
<p>P  14 V 65 Amp.  <b>A: 65.0 B: 40.5 C: 42.0 mm.</b>  Seat</p> 	<p>SP  14 V 70 Amp.  <b>A: 42.5 B: 27.0 C: 73.5 mm.</b>  Citroen, Peugeot</p>	<p>P  14 V 55 Amp.  <b>A: 77.5 B: 56.0 mm.</b>  Seat, VW</p>



CA 589 IR		CA 593 IR		CA 595 IR	
P A: 51.5 Skoda	B: 27.0	14 V 55 Amp. C: 66.0 mm.	P A: 77.5 Alfa Romeo, Ferrari	B: 56.0 mm.	14 V 65 Amp. W 28 V 55 Amp. Mercedes-Benz, Steyr
CA 596 IR		CA 597 IR#		CA 600 IR	
SP A: 49.5 Fiat, Innocenti, Lancia	B: 23.5	14 V 65 Amp. C: 73.5 mm.	SP A: 45.5 Peugeot	B: 11.5	14 V 80 Amp. C: 65.0 mm. W 14 V 55 Amp. Austin, LDV, Massey Ferguson, MG, Rover
CA 601 IR		CA 602 IR		CA 603 IR	
B: 16.5 Fiat, Lancia	C: 63.5 mm.	14 V 65 Amp.	SP / W A: 46.0 Renault	B: 56.0 mm.	14 V 70 Amp. C: 64.0 mm. 14 V 28 Amp. Marshall, Steyr
CA 605 IR		CA 607 IR		CA 608 IR	
SP A: 46.5 Renault	B: 27.0	14 V 70 Amp. C: 72.0 mm.	SP A: 46.5 Renault	B: 16.0	14 V 90 Amp. C: 79.5 mm. P A: 61.0 BMW



CA 609 IR		CA 610 IR		CA 611 IR	
P A: 82.0 BMW	14 V 80 Amp. B: 55.5 mm.	P / W A: 99.0 VW	14 V 90 Amp. B: 56.0 mm.	SP / For VP / W A: 33.5 Ford	14 V 70 Amp. B: 11.5 C: 83.0 mm.

CA 612 IR		CA 613 IR		CA 614 IR	
SP A: 46.5 Renault	14 V 70 Amp. B: 27.0 C: 68.5 mm.	P A: 56.0 Massey Ferguson	14 V 34 Amp. B: 27.0 mm.	SP / IF A: 42.5 Citroen, Peugeot	14 V 90 Amp. B: 27.5 C: 65.0 mm.

CA 615 IR		CA 616 IR		CA 617 IR	
P A: 87.0 Opel	14 V 70 Amp. B: 56.0 mm.	B: 56.0 mm. Case, Ferrari, Goldoni, Lombardini		P / IF A: 94.5 Citroen, Peugeot	14 V 50 Amp. B: 56.0 mm.

CA 618 IR		CA 625 IR		CA 626 IR	
P / IF A: 95.0 Citroen, Peugeot	14 V 70 Amp. B: 56.0 mm.	SP A: 46.5 Volvo	14 V 60 Amp. B: 27.0 C: 68.0 mm.	B: 10.5 C: 81.5 mm. Dronningborg, Hatz, Jaguar, Land Rover	



CA 627 IR	CA 629 IR#	CA 630 IR
<p>14 V 65 Amp. B: 11.0 C: 83.5 mm. Austin, Land Rover, LDV, Rover</p>	<p>14 V 45 Amp. B: 11.5 C: 83.0 mm. Land Rover, LDV</p>	<p>P A: 61.0 B: 16.0 C: 80.0 mm. BMW</p>
CA 631 IR	CA 632 IR	CA 634 IR
<p>P / W A: 47.0 B: 17.0 C: 65.0 mm. Alfa Romeo, Goldoni</p>	<p>SP A: 52.0 B: 27.0 C: 65.5 mm. Renault</p>	<p>SP A: 46.5 B: 27.0 C: 67.5 mm. Renault</p>
CA 635 IR	CA 636 IR	CA 637 IR
<p>SP A: 46.5 B: 27.0 C: 72.0 mm. Renault</p>	<p>SP / IF A: 42.0 B: 27.0 C: 66.0 mm. Citroen, Peugeot</p>	<p>SP / IF A: 42.5 B: 27.0 C: 66.0 mm. Citroen, Fiat, Peugeot, Suzuki</p>
CA 638 IR	CA 639 IR	CA 640 IR
<p>SP / IF A: 42.0 B: 27.0 C: 66.5 mm. Citroen, Fiat, Peugeot</p>	<p>SP / IF A: 42.0 B: 27.0 C: 66.5 mm. Citroen, Peugeot</p>	<p>P A: 49.0 B: 27.0 C: 65.5 mm. Renault</p>



CA 641 IR	CA 642 IR	CA 643 IR
		
<b>P</b> A: 49.0    B: 17.0 Alfa Romeo, Iveco	14 V    45 Amp. C: 64.5 mm. <b>P</b> A: 48.0    B: 17.5    C: 64.5 mm. Alfa Romeo, Citroen, Fiat, Iveco	<b>P / W</b> A: 47.5    B: 27.0    C: 65.5 mm. Renault
		
CA 644 IR	CA 645 IR	CA 646 IR
		
<b>SP</b> A: 40.0    B: 14.5    C: 82.0 mm. Alfa Romeo, Fiat, Lancia	14 V    90 Amp. <b>SP</b> A: 91.5    B: 56.0 mm. Fiat, Mercedes-Benz	<b>SP / IF / W</b> A: 91.5    B: 56.0 mm. Mercedes-Benz
CA 647 IR	CA 649 IR	CA 650 IR
		
<b>P</b> A: 90.0    B: 56.0 mm. Opel, Vauxhall	14 V    70 Amp. <b>P</b> A: 56.0    B: 27.0    C: 72.0 mm. Renault	<b>P / W</b> A: 34.5    B: 11.5    C: 83.0 mm. Ford
		
CA 700 IR	CA 702 IR	CA 705 IR
		
<b>P</b> A: 32.0    B: 14.0    C: 82.0 mm. Alfa Romeo, Audi, Lancia	14 V    115 Amp. <b>W</b> B: 56.0 mm. Iveco, KHD	28 V    35 Amp. <b>DP / W</b> A: 49.0    B: 27.0    C: 65.5 mm. Renault V.I.











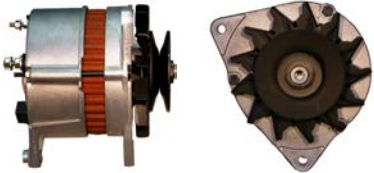
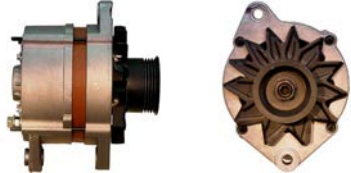

CA 707 IR		CA 708 IR		CA 710 IR	
P / BS A: 36.0    B: 10.5 Ford		P / W A: 88.0    B: 56.0 mm. Audi, VW		P / W A: 114.0    B: 80.0 mm. MAN	
14 V    75 Amp. C: 84.5 mm.		14 V    90 Amp.		28 V    35 Amp.	
CA 711 IR		CA 712 IR		CA 714 IR	
SP A: 46.5    B: 27.0 Volvo		SP A: 48.5    B: 13.0 BMW, Fiat, Lancia		SP A: 92.0    B: 56.0 mm. Mercedes-Benz	
14 V    70 Amp. C: 70.0 mm.		14 V    90 Amp. C: 82.0 mm.		14 V    80 Amp.	
CA 715 IR		CA 716 IR		CA 717 IR	
SP / IF A: 75.0    B: 56.0 mm. Citroen, Peugeot		SP / IF / W A: 46.5    B: 27.0 Renault, Volvo		SP / W A: 43.5    B: 11.0 Ford	
14 V    80 Amp.		14 V    110 Amp. C: 66.5 mm.		14 V    70 Amp. C: 83.0 mm.	
CA 718 IR		CA 719 IR		CA 720 IR	
SP / For VP / W A: 33.0    B: 11.5 Ford		SP / For VP / W A: 33.0    B: 11.0 Ford		SP / IF / W A: 66.0    B: 27.0 Renault	
14 V    55 Amp. C: 82.5 mm.		14 V    70 Amp. C: 83.0 mm.		14 V    110 Amp. C: 67.0 mm.	



CA 721	CA 722 IR	CA 723 IR
		
W B: 27.0 C: 65.0 mm. Renault V.I.	W B: 50.0 mm. Volvo, Volvo Penta <i>Mounting ear: I.D. 14 mm</i>	SP A: 92.0 B: 56.0 mm. Mercedes-Benz
		

CA 724 IR	CA 725 IR	CA 727 IR
		
SP / IF A: 92.0 B: 56.0 mm. Mercedes-Benz	P / BS/W A: 35.5 B: 11.5 C: 83.0 mm. Ford, New Holland	SP A: 55.0 B: 17.0 C: 63.5 mm. Fiat, Lancia
		

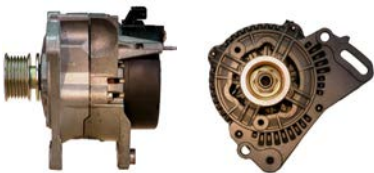
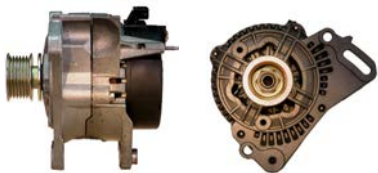





CA 728 IR#	CA 729 IR#	CA 730 IR
		
P A: 102.0 B: 56.0 mm. Renault	SP / IF A: 42.5 B: 27.0 C: 66.0 mm. Citroen, Fiat, Peugeot	SP / IF A: 42.0 B: 27.5 C: 66.5 mm. Citroen, Fiat, Peugeot
		







CA 731 IR	CA 732 IR	CA 733 IR
		
SP / IF A: 35.0 B: 14.0 C: 81.5 mm. Ford	SP / IF / W A: 39.5 B: 14.0 C: 61.0 mm. Seat, VW	SP / IF / W A: 39.5 B: 14.0 C: 61.0 mm. Seat, Skoda, VW
		









<p><b>CA 734 IR</b></p>	<p><b>CA 735 IR</b></p>	<p><b>CA 736 IR</b></p>
<p>P A: 76.0    B: 56.0 mm. Claas, Eicher, Lamborghini</p>	<p>P A: 61.0    B: 36.0    C: 53.0 mm. Citroen, Peugeot, Talbot</p>	<p>SP / IF / W A: 40.0    B: 14.0    C: 61.0 mm. Ford, Seat, Skoda, VW</p>
<p><b>CA 737 IR</b></p>	<p><b>CA 738 IR</b></p>	<p><b>CA 739 IR</b></p>
<p>SP / IF A: 81.0    B: 56.0 mm. Alfa Romeo</p>	<p>SP / IF / W A: 33.0    B: 14.5    C: 81.5 mm. Ford</p>	<p>SP / IF / W A: 33.0    B: 14.0    C: 81.5 mm. Ford</p>
<p><b>CA 740 IR</b></p>	<p><b>CA 748 IR</b></p>	<p><b>CA 749 IR</b></p>
<p>SP / IF / W A: 40.0    B: 14.0    C: 61.0 mm. Seat, VW</p>	<p>W B: 27.0    C: 69.5 mm. Scania</p>	<p>W B: 80.0 mm. Scania</p>
<p><b>CA 811 IR</b></p>	<p><b>CA 813 IR</b></p>	<p><b>CA 814 IR</b></p>
<p>P / W A: 109.0    B: 71.0 mm. Volvo</p>	<p>14 V    75 Amp. Porsche</p>	<p>14 V    90 Amp. Porsche</p>







CA 816 IR		CA 818 IR		CA 819 IR	
					
SP / IF / W A: 62.5 Renault	14 V 80 Amp. B: 27.0 C: 65.0 mm.	SP / IF / W A: 62.0 Renault	14 V 75 Amp. B: 27.0 C: 65.5 mm.	SP / IF A: 62.0 Renault	14 V 110 Amp. B: 27.0 C: 66.5 mm.

CA 820 IR		CA 823 IR#		CA 824 IR	
					
SP / IF A: 42.0 Citroen, Fiat, Lancia, Peugeot	14 V 70 Amp. B: 27.0 C: 66.0 mm.	W B: 16.0 Kässbohrer, Mercedes-Benz	28 V 120 Amp. C: 180.0 mm.	W B: 16.0 Mercedes-Benz, Setra	28 V 120 Amp. C: 180.0 mm.







CA 825 IR		CA 826 IR		CA 827 IR	
					
SP / IF A: 42.0 Citroen, Fiat, Lancia, Peugeot	14 V 95 Amp. B: 27.0 C: 68.0 mm.	P / IF A: 72.0 BMW	14 V 65 Amp. B: 16.5 C: 80.0 mm.	SP / IF / W A: 39.0 Ford, Seat, Skoda, VW	14 V 70 Amp. B: 14.0 C: 61.5 mm.



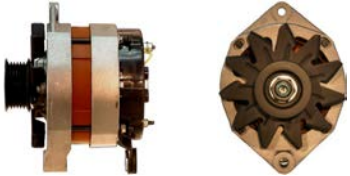

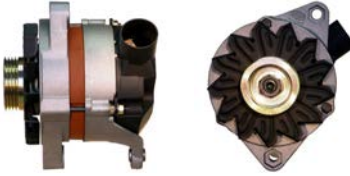

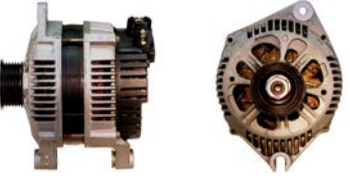

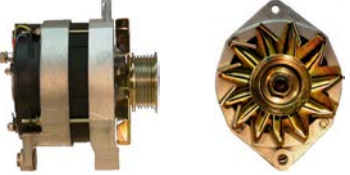
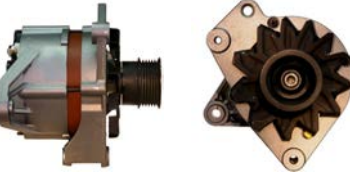
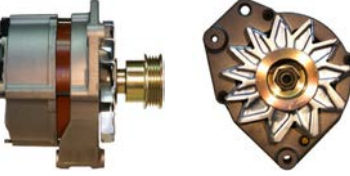
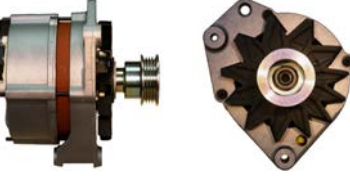

















CA 828 IR		CA 829 IR		CA 830 IR	
					
SP / IF / W A: 39.0 Ford, Seat, VW	14 V 120 Amp. B: 14.0 C: 61.0 mm.	SP / IF / W A: 39.0 Audi, Skoda, VW	14 V 90 Amp. B: 14.0 C: 61.0 mm.	P A: 56.0 Renault	14 V 90 Amp. B: 27.0 C: 68.0 mm.





CA 831 IR		CA 832 IR		CA 833 IR	
					
SP A: 46.5 Renault	B: 27.0 C: 69.0 mm. 14 V 90 Amp.	SP / IF A: 42.0 Citroen, Peugeot	B: 27.0 C: 65.0 mm. 14 V 120 Amp.	SP / IF A: 92.0 Mercedes-Benz	B: 56.0 mm. C: 66.0 mm. 14 V 70 Amp.
CA 834 IR#		CA 835 IR		CA 836 IR	
					
SP A: 49.0 Fiat	B: 23.5 C: 74.0 mm. 14 V 65 Amp.	SP / IF A: 42.5 Citroen, Peugeot	B: 27.0 C: 64.5 mm. 14 V 90 Amp.	SP / IF A: 42.0 Citroen, Fiat, Lancia, Peugeot	B: 27.0 C: 66.0 mm. 14 V 120 Amp.
CA 837 IR		CA 838 IR		CA 840 IR	
					
SP / IF A: 31.0 Audi, VW	B: 14.0 C: 82.0 mm. 14 V 90 Amp.	SP / W A: 46.0 Renault	B: 27.0 C: 67.5 mm. 14 V 90 Amp.	SP A: 96.0 VW	B: 56.0 mm. C: 66.0 mm. 14 V 65 Amp.
CA 841 IR		CA 842 IR		CA 843 IR	
					
SP A: 96.0 VW	B: 56.0 mm. C: 66.0 mm. 14 V 90 Amp.	SP A: 107.0 Audi	B: 56.0 mm. C: 66.0 mm. 14 V 90 Amp.	SP A: 107.0 Audi	B: 56.0 mm. C: 66.0 mm. 14 V 90 Amp.



CA 844 IR		CA 845 IR		CA 846 IR	
					
P / W A: 99.0 VW	14 V 100 Amp. B: 56.0 mm.	SP / IF A: 77.0 BMW	14 V 95 Amp. B: 56.0 mm.	SP A: 33.0 Opel, Vauxhall	14 V 90 Amp. C: 82.0 mm.
CA 847 IR		CA 848 IR		CA 849 IR	
					
W B: 56.0 mm. John Deere	14 V 85 Amp.	SP / IF / W A: 46.5 Renault, Volvo	14 V 110 Amp. C: 66.5 mm.	SP / W A: 47.0 Renault	14 V 70 Amp. C: 72.5 mm.
					
CA 850 IR		CA 851 IR		CA 852 IR	
					
SP A: 48.0 Skoda	14 V 55 Amp. B: 27.0 C: 66.0 mm.	SP / IF A: 54.5 Fiat, Lancia	14 V 65 Amp. B: 32.0 mm.	SP / IF / W A: 39.0 Audi	14 V 70 Amp. C: 61.0 mm.
CA 853 IR		CA 854 IR		CA 855 IR	
					
W B: 51.0 mm. Volvo	28 V 80 Amp.	W B: 80.0 mm. MAN, Mercedes-Benz, Padane	28 V 35 Amp.	SP / IF A: 30.5 Audi, Opel, Vauxhall, VW	14 V 120 Amp. C: 82.0 mm.



CA 856 IR		CA 857 IR		CA 858 IR	
SP / IF / W A: 33.0    B: 14.0 Ford		W B: 50.5 mm. Volvo, Volvo BM, Volvo Penta <i>Mounting ear: I.D. 11 mm</i>		W B: 50.5 mm. Volvo, Volvo Penta <i>Mounting ear: I.D. 14 mm</i>	
		<p>B+D+ W</p>			
CA 859 IR		CA 861 IR		CA 889 IR	
SP A: 69.0    B: 28.0 BMW		SP / IF A: 50.0    B: 33.5 Fiat, Opel, Vauxhall		P A: 50.5    B: 27.5 Renault	
CA 890 IR		CA 892 IR		CA 893 IR	
SP / IF A: 54.0    B: 32.0 mm. Fiat, Lancia		P A: 89.0    B: 56.0 mm. Opel, Vauxhall		P A: 53.5    B: 24.0 mm. Fiat	
CA 894 IR		CA 895 IR		CA 896 IR	
P A: 83.5    B: 56.0 mm. BMW		SP / IF / W A: 54.0    B: 27.0 Renault		SP / IF / W A: 46.5    B: 26.5 Renault	



CA 897 IR		CA 898 IR		CA 899 IR	
SP A: 70.0 BMW	B: 28.0	W B: 26.5 Renault V.I.	C: 76.5 mm.	28 V 60 Amp.	DP A: 92.0 Volvo
	14 V 90 Amp.		C: 66.5 mm.		B: 71.0 mm.

CA 900 IR		CA 901 IR#		CA 902 IR	
P / W A: 108.0 Volvo	B: 71.0 mm.	SP A: 69.0 BMW	C: 76.5 mm.	P A: 46.0 BMW	B: 16.0
	14 V 80 Amp.		C: 76.5 mm.		14 V 140 Amp.

CA 903 IR		CA 905 IR		CA 906 IR	
DP A: 94.0 Volvo	B: 71.0 mm.	DP A: 93.5 Volvo	C: 76.5 mm.	P / W A: 87.5 VW	B: 56.0 mm.
	14 V 65 Amp.		C: 76.5 mm.		14 V 65 Amp.

CA 907 IR		CA 908 IR		CA 909 IR	
W B: 14.5 Volvo	C: 100.0 mm.	SP / IF A: 106.5 Audi	C: 76.5 mm.	P A: 92.0 Fiat, Innocenti	B: 56.0 mm.
	28 V 80 Amp.		C: 76.5 mm.		14 V 45 Amp.







CA 911 IR#		CA 913 IR		CA 914 IR	
P / W A: 76.0 Audi, VW	14 V 65 Amp. B: 56.0 mm.	SP / IF A: 56.0 Renault	14 V 80 Amp. B: 27.0 C: 66.5 mm.	SP / IF A: 56.0 Renault	14 V 110 Amp. B: 27.0 C: 67.0 mm.

CA 1028 IR		CA 1029 IR		CA 1030 IR	
SP / VP / W A: 34.0 Ford	14 V 55 Amp. B: 11.5 C: 83.0 mm.	SP / VP / W A: 33.5 Ford	14 V 70 Amp. B: 11.5 C: 83.5 mm.	SP / VP / W A: 34.0 Ford	14 V 55 Amp. B: 11.0 C: 83.0 mm.

CA 1031 IR		CA 1032 IR		CA 1034 IR	
SP / VP / W A: 34.0 Ford	14 V 70 Amp. B: 12.0 C: 83.0 mm.	SP / IF / W A: 33.0 Ford	14 V 70 Amp. B: 14.0 C: 81.5 mm.	SP / IF / W A: 47.0 Ford	14 V 95 Amp. B: 57.0 mm.

CA 1035 IR		CA 1036 IR		CA 1037 IR	
W B: 80.0 mm. DAF, MAN, Mercedes-Benz, Padane, Renault V.I.	28 V 80 Amp.	SP / IF / W A: 46.0 Renault	14 V 110 Amp. B: 27.0 C: 67.0 mm.	SP / IF / W A: 33.0 Ford	14 V 70 Amp. B: 14.0 C: 79.0 mm.





CA 1051 IR		CA 1052 IR		CA 1053 IR	
<p>SP / IF A: 51.0    B: 34.0 Opel, Vauxhall</p>		<p>14 V    70 Amp. C: 60.0 mm.</p> <p>SP / IF A: 91.5    B: 56.0 mm. Citroen, Fiat, Lancia, Peugeot</p>		<p>14 V    90 Amp.</p> <p>SP / IF A: 50.0    B: 33.0 Isuzu, Opel, Vauxhall</p> <p>14 V    100 Amp. C: 58.0 mm.</p>	

CA 1054 IR		CA 1055 IR		CA 1056 IR	
<p>SP A: 69.0    B: 28.0 BMW</p>		<p>14 V    140 Amp. C: 78.5 mm.</p> <p>SP A: 40.0    B: 17.0 Alfa Romeo, Fiat, Lancia</p>		<p>14 V    70 Amp. C: 70.0 mm.</p> <p>SP / IF A: 48.0    B: 21.0 Renault, Volvo</p> <p>14 V    120 Amp. C: 56.0 mm.</p>	

CA 1057 IR		CA 1058 IR		CA 1059 IR	
<p>SP / IF A: 92.0    B: 56.0 mm. Daewoo, Mercedes-Benz, Ssangyong</p>		<p>14 V    120 Amp.</p> <p>P / W A: 83.0    B: 56.0 mm. Seat, VW</p>		<p>14 V    90 Amp.</p> <p>SP / IF A: 46.5    B: 27.0 Renault</p> <p>14 V    75 Amp. C: 66.0 mm.</p>	



CA 1060 IR		CA 1061 IR#		CA 1062 IR	
<p>SP / IF / W A: 46.5    B: 27.0 Renault</p>		<p>14 V    110 Amp. C: 66.5 mm.</p> <p>SP / IF A: 82.5    B: 56.0 mm. Alfa Romeo</p>		<p>14 V    80 Amp.</p> <p>SP / IF A: 92.0    B: 56.0 mm. Daewoo, John Deere, Mercedes-Benz, Ssangyong</p> <p>14 V    90 Amp.</p>	





CA 1064 IR		CA 1065 IR		CA 1066 IR	
SP / IF A: 69.0 BMW	B: 28.0 C: 76.0 mm. 14 V 80 Amp.	A: 91.5 Citroen, Fiat, Hyundai, Lancia, Peugeot	B: 56.0 mm. 14 V 95 Amp.	A: 52.5 Opel, Vauxhall	B: 33.5 C: 57.0 mm. 14 V 55 Amp.

CA 1068 IR		CA 1069 IR		CA 1070 IR	
W B: 56.0 mm. John Deere	14 V 120 Amp.	A: 93.0 Volvo	B: 71.0 mm. 14 V 100 Amp.	A: 51.0 Opel, Saab, Vauxhall	B: 33.5 C: 59.0 mm. 14 V 120 Amp.



CA 1071 IR		CA 1072 IR		CA 1073 IR	
SP / IF / W A: 33.0 Ford	B: 14.0 C: 83.0 mm. 14 V 90 Amp.	A: 92.0 Mercedes-Benz	B: 56.0 mm. 14 V 55 Amp.	A: 69.0 BMW	B: 28.0 C: 76.5 mm. 14 V 105 Amp.







CA 1074 IR		CA 1075 IR		CA 1076 IR	
Porsche		A: 39.0 Mitsubishi	B: 13.0 C: 66.5 mm. 14 V 90 Amp.	A: 29.0 Ford	B: 14.5 C: 61.5 mm. 14 V 115 Amp.

















CA 1077 IR		CA 1078 IR		CA 1079 IR	
SP / IF A: 52.0 B: 27.0 Renault		14 V 75 Amp. C: 66.5 mm.		SP / IF / W A: 46.5 B: 27.0 Renault	
				14 V 110 Amp. C: 68.5 mm.	
				14 V 75 Amp. C: 67.0 mm.	
CA 1080 IR		CA 1081 IR		CA 1082 IR	
SP / IF / W A: 47.0 B: 26.5 Renault, Volvo		SP / IF A: 83.0 B: 56.0 mm. Mercedes-Benz		W B: 51.0 mm. Thermo King	
CA 1083 IR		CA 1084 IR		CA 1085 IR	
SP / IF / W A: 33.0 B: 14.0 Ford		SP / IF A: 40.5 B: 16.5 Citroen, Fiat		SP / IF / W A: 33.0 B: 14.0 Ford	
CA 1086 IR		CA 1087 IR		CA 1088 IR	
SP / IF A: 42.5 B: 27.0 Citroen, Fiat, Lancia, Peugeot		SP / IF / DF A: 33.0 B: 14.0 Ford, Mazda		SP / IF A: 48.0 B: 21.5 Renault, Volvo	



CA 1089 IR		CA 1090 IR		CA 1092 IR	
					
SP / IF / DF A: 40.0    B: 14.0 Ford, Seat, VW		SP / FW / IF A: 82.0    B: 56.0 mm. Mercedes-Benz		SP / IF A: 69.0    B: 28.0 BMW	
14 V    120 Amp. C: 61.0 mm.		14 V    90 Amp.		14 V    140 Amp. C: 76.0 mm.	
					

CA 1093 IR		CA 1095 IR		CA 1096 IR	
					
SP / IF A: 35.0    B: 14.0 Audi, Skoda, VW		SP / IF A: 89.0    B: 56.0 mm. Citroen, Peugeot		SP / IF A: 48.5    B: 21.0 Renault, Volvo	
14 V    70 Amp. C: 82.0 mm.		14 V    70 Amp.		14 V    80 Amp. C: 56.0 mm.	























CA 1098 IR		CA 1099 IR		CA 1100 IR	
					
SP / IF A: 91.5    B: 56.0 mm. Citroen, Fiat, Lancia, Peugeot		SP / IF A: 42.0    B: 27.0 Peugeot		SP / IF / W A: 39.0    B: 14.0 Rover	
14 V    120 Amp.		14 V    120 Amp. C: 66.5 mm.		14 V    85 Amp. C: 70.0 mm.	
					

CA 1101 IR		CA 1103 IR		CA 1105 IR	
					
SP / W A: 46.0    B: 27.0 Rover		SP / IF A: 50.5    B: 33.5 Opel, Saab, Vauxhall		SP / W A: 47.0    B: 27.0 Renault	
14 V    70 Amp. C: 66.5 mm.		14 V    100 Amp. C: 58.5 mm.		14 V    90 Amp. C: 66.0 mm.	
					



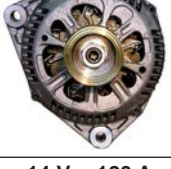
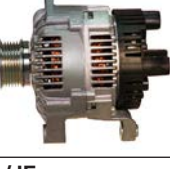























CA 1106 IR		CA 1136 IR		CA 1137 IR	
					
SP / IF A: 47.0 B: 20.0 BMW	14 V 70 Amp. C: 73.5 mm.	SP / IF A: 38.5 B: 13.0 Mitsubishi	14 V 75 Amp. C: 66.5 mm.	SP / IF A: 42.0 B: 21.0 Ford	14 V 70 Amp. C: 25.0 mm.
					
CA 1138 IR		CA 1139 IR		CA 1140 IR	
					
SP / IF / W A: 118.5 B: 56.0 mm. Saab	14 V 90 Amp.	SP / IF A: 34.5 B: 14.0 Audi, VW	14 V 90 Amp. C: 82.0 mm.	SP / IF A: 35.5 B: 14.0 Audi, VW	14 V 120 Amp. C: 82.0 mm.
CA 1141 IR		CA 1142 IR		CA 1143 IR	
					
SP / IF / DF A: 30.0 B: 14.5 Audi, Skoda, VW	14 V 120 Amp. C: 82.0 mm.	SP / IF / W A: 43.0 B: 14.0 Ford, VW	14 V 120 Amp. C: 61.0 mm.	SP / IF / W A: 42.5 B: 14.0 Ford, Mercedes-Benz, Seat, VW	14 V 150 Amp. C: 61.0 mm.
					
CA 1144 IR		CA 1145 IR		CA 1146 IR	
					
SP / FW / IF / DF A: 40.0 B: 14.0 Audi, Seat, Skoda, VW	14 V 120 Amp. C: 61.0 mm.	SP / IF / DF A: 34.0 B: 13.5 Ford	14 V 90 Amp. C: 77.5 mm.	P / IF A: 53.0 B: 33.5 Opel, Vauxhall	14 V 70 Amp. C: 57.0 mm.
					



<b>CA 1147 IR</b>	<b>CA 1148 IR</b>	<b>CA 1149 IR</b>
 	 	 
<p>SP / IF / DF      14 V 120 Amp.  A: 40.0      B: 14.0      C: 61.0 mm.  Audi, VW</p>	<p>W      28 V 65 Amp.  B: 23.0      C: 68.0 mm.  Scania</p>	<p>SP / IF      14 V 90 Amp.  A: 29.5      B: 14.0      C: 61.0 mm.  Ford</p>
<b>CA 1150 IR</b>	<b>CA 1151 IR</b>	<b>CA 1152 IR</b>
 	 	 
<p>SP / IF      14 V 105 Amp.  A: 77.0      B: 57.0 mm.  BMW, Opel, Vauxhall</p>	<p>SP / IF      14 V 70 Amp.  A: 92.0      B: 56.0 mm.  Citroen, Fiat, Lancia, Peugeot</p>	<p>SP / IF      14 V 80 Amp.  A: 92.0      B: 56.0 mm.  Citroen, Fiat, Lancia, Peugeot</p>
<b>CA 1153 IR</b>	<b>CA 1154 IR</b>	<b>CA 1155 IR</b>
 	 	 
<p>SP / IF      14 V 65 Amp.  A: 62.0      B: 32.0 mm.  Fiat, Lancia, Peugeot</p>	<p>SP / IF      14 V 75 Amp.  A: 44.0      B: 32.5      C: 84.0 mm.  Fiat, Lancia</p>	<p>SP / IF      14 V 70 Amp.  A: 91.5      B: 56.0 mm.  Citroen, Fiat, Peugeot</p>
<b>CA 1156 IR</b>	<b>CA 1157 IR</b>	<b>CA 1159 IR</b>
 	 	 
<p>SP / IF      14 V 120 Amp.  A: 91.5      B: 56.0 mm.  Citroen, Fiat, Lancia, Peugeot</p>	<p>SP / IF      14 V 110 Amp.  A: 53.0      B: 27.0      C: 68.5 mm.  Citroen, Fiat, Peugeot</p>	<p>SP / IF      14 V 85 Amp.  A: 44.5      B: 17.0      C: 54.5 mm.  Alfa Romeo, Fiat, Lancia</p>





<p><b>CA 1160 IR</b></p>	<p><b>CA 1161 IR</b></p>	<p><b>CA 1189 IR</b></p>
 	 	 
<p>SP / IF A: 44.5    B: 17.5 Fiat, Lancia</p>	<p>SP / IF A: 41.5    B: 17.0 Fiat</p>	<p>SP / IF A: 44.0    B: 22.5 Fiat, Lancia</p>
<p>14 V    65 Amp. C: 54.0 mm.</p>	<p>14 V    85 Amp. C: 82.0 mm.</p>	<p>14 V    100 Amp. C: 55.0 mm.</p>
<p><b>CA 1190 IR</b></p>	<p><b>CA 1191 IR</b></p>	<p><b>CA 1192 IR</b></p>
 	 	 
<p>SP / IF A: 44.0    B: 17.0 Fiat</p>	<p>IF / W B: 14.0    C: 83.5 mm. Land Rover, Rover</p>	<p>P / W A: 73.5    B: 50.5 mm. Volvo Penta</p>
<p>14 V    75 Amp. C: 55.0 mm.</p>	<p>14 V    100 Amp.</p>	<p>14 V    50 Amp.</p>
<p><b>CA 1193 IR</b></p>	<p><b>CA 1196 IR</b></p>	<p><b>CA 1197 IR</b></p>
 	 	 
<p>W B: 76.0 mm. Cummins</p>	<p>SP / IF A: 59.0    B: 25.0 Fiat</p>	<p>W B: 51.0 mm. Case</p>
<p>28 V    55 Amp.</p>	<p>14 V    65 Amp. C: 71.0 mm.</p>	<p>14 V    65 Amp.</p>
<p><b>CA 1198 IR</b></p>	<p><b>CA 1199 IR</b></p>	<p><b>CA 1203 IR</b></p>
 	 	 
<p>W B: 51.0 mm. Case</p>	<p>SP / IF A: 41.0    B: 22.0 Citroen, Fiat</p>	<p>SP / IF A: 52.0    B: 27.0 Citroen, Peugeot</p>
<p>14 V    95 Amp.</p>	<p>14 V    100 Amp. C: 82.5 mm.</p>	<p>14 V    80 Amp. C: 56.0 mm.</p>





CA 1204 IR		CA 1206 IR		CA 1207 IR	
<b>SP / IF / DF</b> <b>A: 40.0    B: 14.0</b> Volvo		<b>SP / IF</b> <b>A: 82.5    B: 56.0 mm.</b> Mercedes-Benz		<b>SP / IF</b> <b>A: 65.0    B: 28.0 mm.</b> BMW	
14 V    115 Amp. <b>C: 61.0 mm.</b>		14 V    143 Amp.		14 V    140 Amp.	

CA 1208 IR		CA 1209 IR		CA 1216 IR	
<b>SP / IF</b> <b>A: 41.0    B: 22.0</b> Alfa Romeo		<b>SP / FW / IF / W</b> <b>A: 92.0    B: 56.0 mm.</b> Mercedes-Benz		<b>SP / IF</b> <b>A: 44.5    B: 22.0</b> Alfa Romeo, Fiat, Lancia	
14 V    95 Amp. <b>C: 54.5 mm.</b>		14 V    90 Amp.		14 V    85 Amp. <b>C: 55.0 mm.</b>	

CA 1217 IR		CA 1218 IR		CA 1219 IR	
<b>SP / IF / W</b> <b>A: 33.0    B: 17.0</b> Ford, Mazda		<b>SP / IF</b> <b>A: 41.0    B: 17.0</b> Fiat		<b>SP / IF</b> <b>A: 59.0    B: 25.0</b> Fiat	
14 V    70 Amp. <b>C: 65.0 mm.</b>		14 V    85 Amp. <b>C: 54.5 mm.</b>		14 V    85 Amp. <b>C: 71.0 mm.</b>	







CA 1220 IR		CA 1221 IR		CA 1222 IR	
<b>SP / IF</b> <b>A: 58.5    B: 25.0</b> Fiat, Lancia		<b>SP / IF</b> <b>A: 58.5    B: 25.0</b> Fiat, Lancia		<b>SP / IF</b> <b>A: 41.0    B: 22.0</b> Fiat, Lancia	
14 V    75 Amp. <b>C: 71.0 mm.</b>		14 V    85 Amp. <b>C: 72.0 mm.</b>		14 V    85 Amp. <b>C: 55.0 mm.</b>	



<p><b>CA 1223 IR</b></p>	<p><b>CA 1224 IR#</b></p>	<p><b>CA 1226 IR</b></p>
 	 	 
<p>SP / IF A: 44.5    B: 22.0 Alfa Romeo, Fiat, Lancia</p> <p>14 V    100 Amp. C: 55.0 mm.</p>	<p>W B: 16.0    C: 184.0 mm. Mercedes-Benz, Scania</p> <p>28 V    120 Amp.</p>	<p>SP/FW / IF / W A: 42.5    B: 14.0 Skoda, VW</p> <p>14 V    90 Amp. C: 61.0 mm.</p>
<p><b>CA 1227 IR</b></p>	<p><b>CA 1228 IR</b></p>	<p><b>CA 1229 IR</b></p>
 	 	 
<p>P / W A: 35.0    B: 11.5 Ford</p> <p>14 V    55 Amp. C: 83.0 mm.</p>	<p>SP / IF / W A: 39.0    B: 14.5 VW</p> <p>14 V    90 Amp. C: 60.5 mm.</p>	<p>SP / IF / W A: 39.0    B: 14.0 VW</p> <p>14 V    120 Amp. C: 61.0 mm.</p>
		
<p><b>CA 1230 IR</b></p>	<p><b>CA 1231 IR</b></p>	<p><b>CA 1232 IR</b></p>
 	 	 
<p>SP / IF / W A: 33.5    B: 13.5 Ford</p> <p>14 V    100 Amp. C: 82.5 mm.</p>	<p>SP / IF A: 51.0    B: 33.5 Opel, Vauxhall</p> <p>14 V    55 Amp. C: 57.0 mm.</p>	<p>SP / IF A: 32.5    B: 14.5 Audi</p> <p>14 V    120 Amp. C: 81.5 mm.</p>
<p><b>CA 1233 IR</b></p>	<p><b>CA 1234 IR</b></p>	<p><b>CA 1235 IR</b></p>
 	 	 
<p>SP / IF A: 56.0    B: 17.0 Alfa Romeo, Fiat, Lancia</p> <p>14 V    100 Amp. C: 63.5 mm.</p>	<p>SP A: 55.5    B: 17.0 Fiat, Lancia</p> <p>14 V    90 Amp. C: 63.0 mm.</p>	<p>W B: 15.5    C: 180.0 mm. Kässbohrer, Setra</p> <p>28 V    120 Amp.</p>

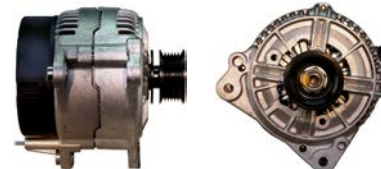































CA 1236 IR	CA 1237 IR	CA 1238 IR#
		
W B: 16.0 C: 180.0 mm. Kässbohrer, Mercedes-Benz, Setra	W B: 16.0 C: 182.0 mm. MAN, Neoplan	SP / IF A: 43.0 B: 27.0 C: 65.0 mm. Citroen, Peugeot

CA 1239 IR	CA 1240 IR	CA 1241 IR
		
SP / FW / IF / W A: 42.0 B: 14.0 C: 61.0 mm. Seat, VW	SP / IF / W A: 40.0 B: 14.0 C: 60.5 mm. Audi, Seat, Skoda, VW	SP / IF / W A: 40.5 B: 14.0 C: 60.5 mm. Audi, Skoda, VW
 W D+	 W D+	 W D+

CA 1242 IR	CA 1243 IR	CA 1244 IR
		
W B: 56.0 mm. Fendt	SP / IF A: 74.5 B: 56.0 mm. Citroen, Peugeot	SP / IF A: 106.5 B: 56.0 mm. Audi, Mercedes-Benz

CA 1245 IR	CA 1246 IR	CA 1247 IR
		
SP / IF A: 64.5 B: 28.0 mm. BMW	SP / IF A: 84.0 B: 56.0 mm. Saab	SP / IF A: 77.5 B: 56.0 mm. BMW
		 15 61E/L





















CA 1248 IR	CA 1253 IR	CA 1254 IR
 	 	 
<p>SP/FW / IF / DF A: 30.0 B: 14.0 C: 61.0 mm. Audi, VW</p>	<p>SP / IF A: 46.0 B: 27.0 C: 68.0 mm. Renault</p>	<p>SP/FW / IF A: 81.0 B: 56.0 mm. Mercedes-Benz</p>
		
CA 1255 IR	CA 1256 IR	CA 1257 IR
 	 	 
<p>SP/FW / IF / W A: 42.5 B: 14.0 C: 60.5 mm. Seat, Skoda, VW</p>	<p>SP / IF A: 68.5 B: 28.0 C: 76.0 mm. BMW</p>	<p>SP / IF A: 54.5 B: 33.5 C: 55.5 mm. Opel, Vauxhall</p>
		
CA 1258 IR	CA 1259 IR	CA 1260 IR
 	 	 
<p>SP / IF A: 41.0 B: 17.0 C: 82.0 mm. Fiat</p>	<p>SP A: 65.0 B: 28.0 mm. BMW</p>	<p>SP/FW / IF / DF A: 39.0 B: 14.5 C: 61.0 mm. Ford, Seat, Volvo, VW</p>
		
CA 1261 IR	CA 1267 IR	CA 1297 IR
 	 	 
<p>SP / IF A: 47.0 B: 20.0 C: 73.5 mm. BMW</p>	<p>SP / IF / W A: 39.0 B: 14.0 C: 61.0 mm. Audi, Skoda, VW</p>	<p>SP/FW / IF / W A: 39.5 B: 14.0 C: 60.5 mm. Seat, VW</p>
		



<b>CA 1298 IR</b>	<b>CA 1299 IR</b>	<b>CA 1300 IR</b>
 	 	 
<p>SP / IF A: 46.5      B: 27.0 Renault</p> <p>14 V    75 Amp. C: 65.0 mm.</p>	<p>SP/FW / IF A: 92.5      B: 56.0 mm. Mercedes-Benz</p> <p>14 V    115 Amp.</p>	<p>SP / IF A: 82.5      B: 56.0 mm. Mercedes-Benz, VW</p> <p>14 V    115 Amp.</p>
		
<b>CA 1301 IR</b>	<b>CA 1302 IR</b>	<b>CA 1303 IR</b>
 	 	 
<p>SP / IF A: 82.5      B: 56.0 mm. Mercedes-Benz, VW</p> <p>14 V    90 Amp.</p>	<p>SP / IF A: 46.5      B: 27.0 Renault</p> <p>14 V    75 Amp. C: 66.0 mm.</p>	<p>SP/FW / IF / W A: 46.5      B: 26.5 Renault, Volvo</p> <p>14 V    120 Amp. C: 66.5 mm.</p>
<b>CA 1304 IR</b>	<b>CA 1305 IR</b>	<b>CA 1306 IR</b>
 	 	 
<p>SP / IF A: 46.5      B: 26.5 Opel, Renault, Vauxhall</p> <p>14 V    75 Amp. C: 66.5 mm.</p>	<p>SP / IF A: 75.0      B: 56.0 mm. Citroen, Fiat, Peugeot</p> <p>14 V    65 Amp.</p>	<p>SP / IF / W A: 46.5      B: 27.0 Renault</p> <p>14 V    75 Amp. C: 66.5 mm.</p>
		
<b>CA 1307 IR#</b>	<b>CA 1308 IR</b>	<b>CA 1309 IR</b>
 	 	 
<p>SP / IF / W A: 46.5      B: 27.0 Renault, Volvo</p> <p>14 V    110 Amp. C: 66.5 mm.</p>	<p>SP / IF / W A: 46.5      B: 27.0 Renault</p> <p>14 V    80 Amp. C: 66.5 mm.</p>	<p>SP / IF / W A: 46.0      B: 26.5 Renault, Volvo</p> <p>14 V    110 Amp. C: 66.5 mm.</p>



CA 1310 IR		CA 1311 IR		CA 1312 IR	
					
IF / W B: 23.5 Scania	28 V 90 Amp. C: 68.0 mm.	SP / IF A: 44.5 Lancia	B: 22.0 14 V 100 Amp. C: 55.0 mm.	SP / IF A: 91.5 Citroen, Fiat, Peugeot	B: 56.0 mm. 14 V 150 Amp.
CA 1313 IR#		CA 1316 IR		CA 1317 IR	
					
SP / IF A: 44.5 Fiat, Lancia	14 V 75 Amp. B: 17.5 C: 54.5 mm.	SP / IF A: 49.5 Ford	B: 25.5 mm. 14 V 130 Amp.	SP / IF / VP / W A: 34.0 Ford, LDV	B: 13.0 C: 82.0 mm. 14 V 95 Amp.
					
CA 1318 IR		CA 1319 IR		CA 1322 IR	
					
SP / IF A: 90.0 MG, Rover	14 V 65 Amp. B: 58.5 mm.	SP / IF A: 52.0 Renault	B: 27.0 14 V 110 Amp. C: 67.0 mm.	SP / IF / W A: 46.5 Renault, Volvo	B: 27.0 C: 66.5 mm. 14 V 120 Amp.
CA 1323 IR		CA 1325 IR		CA 1326 IR#	
					
SP / IF A: 69.0 BMW	B: 28.0 14 V 80 Amp. C: 76.0 mm.	SP / IF A: 69.0 BMW	B: 28.0 14 V 140 Amp. C: 76.0 mm.	SP / IF A: 51.5 Opel, Vauxhall	B: 33.5 C: 55.0 mm. 14 V 70 Amp.
					



CA 1327 IR		CA 1329 IR		CA 1330 IR	
SP / IF A: 51.5    B: 33.5 Opel, Vauxhall		14 V    100 Amp. C: 59.0 mm.		SP / IF A: 54.5    B: 33.5 Opel, Vauxhall	
		14 V    55 Amp. C: 57.0 mm.		P / BS/W A: 36.0    B: 11.0 Ford, New Holland	
				14 V    70 Amp. C: 83.5 mm.	

CA 1331 IR		CA 1332 IR		CA 1333 IR	
SP / IF / W A: 46.5    B: 27.0 Renault, Volvo		SP / IF A: 69.0    B: 28.0 BMW		SP / IF A: 52.0    B: 27.0 Renault	
14 V    80 Amp. C: 66.5 mm.		14 V    105 Amp. C: 75.5 mm.		14 V    80 Amp. C: 66.5 mm.	

CA 1335 IR		CA 1336 IR		CA 1337 IR	
W B: 56.0 mm. Claas, Fendt		W B: 17.0    C: 63.5 mm. Iveco		SP / IF / W A: 31.0    B: 14.0 Land Rover	
14 V    120 Amp.		28 V    55 Amp.		14 V    100 Amp. C: 83.0 mm.	







CA 1338 IR		CA 1339 IR		CA 1340 IR	
SP / IF A: 43.0    B: 22.0 Citroen, Peugeot		P / W A: 59.0    B: 27.0 Renault		SP / IF A: 11.5    B: 71.5 Ford	
14 V    120 Amp. C: 45.0 mm.		14 V    90 Amp. C: 70.5 mm.		14 V    80 Amp. C: 51.0 mm.	

















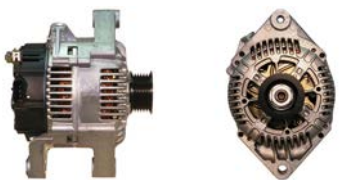

CA 1342 IR		CA 1343 IR		CA 1344 IR	
SP / IF A: 29.5 B: 140.0 Mercedes-Benz	14 V 90 Amp. C: 41.5 mm.	SP / IF / W A: 52.0 B: 27.0 Opel, Renault, Vauxhall	14 V 75 Amp. C: 66.0 mm.	SP / IF A: 66.0 B: 27.0 Renault	14 V 75 Amp. C: 66.5 mm.
CA 1345 IR		CA 1346 IR		CA 1347 IR	
SP / IF A: 66.0 B: 27.0 Renault	14 V 110 Amp. C: 66.5 mm.	SP / W A: 35.0 B: 11.0 Rover	14 V 65 Amp. C: 82.5 mm.	SP / IF A: 92.5 B: 56.0 mm. Lada	14 V 80 Amp.
CA 1349 IR		CA 1350 IR		CA 1378 IR	
SP / IF A: 68.0 B: 32.0 mm. Fiat, Lancia	14 V 65 Amp.	SP / IF A: 44.0 B: 32.5 Fiat, Lancia	14 V 85 Amp. C: 83.5 mm.	SP / IF A: 39.0 B: 14.0 Audi, Seat, Skoda, VW	14 V 90 Amp. C: 61.0 mm.
CA 1379 IR		CA 1380 IR		CA 1381 IR#	
SP / IF / W A: 32.5 B: 14.0 Ford, New Holland	14 V 100 Amp. C: 83.0 mm.	SP / IF / W A: 31.5 B: 14.0 Land Rover	14 V 100 Amp. C: 70.0 mm.	W B: 14.0 C: 101.0 mm. Case	14 V 110 Amp.

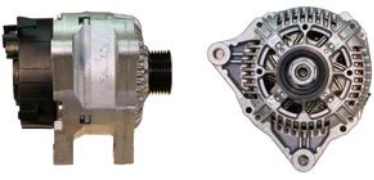

CA 1382 IR#		CA 1383 IR		CA 1385 IR	
					
DP / W A: 51.5 Massey Ferguson	14 V 70 Amp. B: 27.0 mm.	IF / W B: 27.0 Massey Ferguson	14 V 70 Amp. C: 72.5 mm.	SP / IF A: 46.0 Daewoo	14 V 80 Amp. B: 12.5 C: 81.0 mm.
					

CA 1386 IR		CA 1387 IR		CA 1388 IR	
					
SP A: 87.0 Daewoo	14 V 80 Amp. B: 51.0 mm.	W B: 27.0 mm. Massey Ferguson	14 V 70 Amp.	SP / IF A: 42.5 Citroen, Fiat, Lancia, Peugeot, Renault	14 V 150 Amp. B: 22.0 C: 45.0 mm.
					































CA 1389 IR		CA 1390 IR		CA 1391 IR	
					
SP / IF A: 51.0 Opel, Vauxhall	14 V 105 Amp. B: 29.5 C: 54.5 mm.	SP/FW / IF A: 30.0 Mercedes-Benz	14 V 90 Amp. B: 140.0 C: 41.0 mm.	SP / IF A: 54.0 Opel, Vauxhall	14 V 70 Amp. B: 33.5 C: 57.0 mm.
					

CA 1392 IR		CA 1394 IR		CA 1395 IR	
					
SP / IF A: 42.0 Citroen, Fiat, Lancia, Peugeot, Renault	14 V 120 Amp. B: 22.0 C: 45.0 mm.	SP/FW / IF A: 39.0 Audi, Ford, Seat, Skoda, VW	14 V 120 Amp. B: 14.0 C: 61.5 mm.	SP/FW / IF A: 92.5 Mercedes-Benz	14 V 90 Amp. B: 56.0 mm.
					



CA 1396 IR		CA 1398 IR		CA 1400 IR	
SP A: 43.2 Daewoo	14 V 75 Amp. B: 12.5 C: 80.5 mm.	SP / IF A: 46.5 BMW	14 V 80 Amp. B: 19.5 C: 73.5 mm.	SP / IF A: 78.0 BMW	14 V 95 Amp. B: 56.0 mm.
CA 1401 IR		CA 1402 IR		CA 1403 IR	
SP / FW / IF / DF A: 43.5 VW	14 V 90 Amp. B: 14.0 C: 60.5 mm.	SP / IF A: 39.0 VW	14 V 90 Amp. B: 14.0 C: 61.5 mm.	SP / IF / DF A: 30.0 Audi, VW	14 V 120 Amp. B: 14.5 C: 61.0 mm.
CA 1433 IR		CA 1434 IR		CA 1435 IR	
W B: 56.0 mm. Deutz-Fahr, Iveco	14 V 95 Amp.	SP / IF / W A: 52.5 Opel, Renault, Vauxhall	14 V 110 Amp. B: 27.0 C: 66.5 mm.	P A: 45.0 Fiat, Innocenti, Lancia	14 V 55 Amp. B: 16.0 C: 62.0 mm.
CA 1436 IR		CA 1437 IR#		CA 1438 IR	
SP / IF A: 39.5 Audi, Seat, Skoda, VW	14 V 70 Amp. B: 14.0 C: 61.0 mm.	SP / IF A: 41.0 Fiat	14 V 85 Amp. B: 22.0 C: 82.0 mm.	W B: 27.0 Iveco, Renault V.I., Scania	28 V 80 Amp. C: 71.0 mm.

















CA 1439 IR	CA 1440 IR	CA 1441 IR
		
		
SP / FW / IF A: 44.5    B: 20.0 Volvo	14 V    120 Amp. C: 82.0 mm.	P / IF A: 52.5    B: 33.5 Opel, Vauxhall
	14 V    70 Amp. C: 57.5 mm.	SP / FW / IF A: 39.5    B: 14.5 Audi, Seat, Skoda, VW
		14 V    90 Amp. C: 61.0 mm.
		
CA 1442 IR	CA 1443 IR	CA 1444 IR
		
		
SP / IF A: 42.5    B: 22.0 Citroen, Fiat, Peugeot	14 V    70 Amp. C: 45.5 mm.	SP / IF A: 46.5    B: 27.0 Renault
	14 V    120 Amp. C: 81.5 mm.	14 V    110 Amp. C: 66.5 mm.
		
CA 1445 IR	CA 1446 IR	CA 1448 IR
		
		
SP / IF A: 39.0    B: 14.5 Volvo, VW	14 V    120 Amp. C: 61.5 mm.	SP / FW / IF A: 39.0    B: 14.0 Audi, Ford, Seat, Skoda, VW
	14 V    90 Amp. C: 61.0 mm.	28 V    35 Amp. C: 70.0 mm.
		
CA 1451 IR	CA 1452 IR	CA 1455 IR
		
		
SP / IF A: 41.0    B: 17.0 Fiat, Lancia	14 V    100 Amp. C: 54.5 mm.	SP A: 48.0    B: 27.0 Skoda
	14 V    120 Amp. C: 54.5 mm.	14 V    70 Amp. C: 66.0 mm.









CA 1456 IR	CA 1457 IR	CA 1470 IR
		
<p>W 28 V 80 Amp. B: 27.0 C: 71.5 mm. Renault V.I.</p>	<p>P / W 14 V 70 Amp. A: 42.5 B: 10.5 C: 84.0 mm. Universal <i>Universal</i></p>	<p>SP / FW / IF 14 V 98 Amp. A: 20.0 B: 80.0 C: 41.0 mm. Dacia, Nissan, Renault</p>
		
CA 1471 IR	CA 1472 IR	CA 1473 IR
		
<p>SP / IF 14 V 90 Amp. A: 58.5 B: 25.0 C: 70.0 mm. Fiat, Lancia</p>	<p>P 14 V 80 Amp. A: 81.0 B: 56.0 mm. Lada</p>	<p>P / IF 14 V 100 Amp. A: 52.5 B: 34.0 C: 58.5 mm. Opel, Vauxhall</p>
CA 1474 IR	CA 1475 IR	CA 1477 IR
		
<p>SP / IF / DF 14 V 70 Amp. A: 10.0 B: 72.5 mm. Ford</p>	<p>IF 14 V 90 Amp. B: 17.0 C: 69.0 mm. Ford</p>	<p>SP / IF 14 V 120 Amp. A: 91.5 B: 56.0 mm. Mercedes-Benz, Ssangyong</p>
		
CA 1478 IR	CA 1480 IR	CA 1481 IR
		
<p>SP / IF 14 V 115 Amp. A: 26.5 B: 14.0 C: 61.0 mm. Chrysler, Dodge</p>	<p>IF 14 V 143 Amp. B: 56.0 mm. Fendt, Mercedes-Benz</p>	<p>SP / FW / IF 14 V 115 Amp. A: 31.0 B: 70.0 C: 56.0 mm. Mercedes-Benz</p>



CA 1482 IR		CA 1483 IR		CA 1484 IR	
					
SP / IF A: 33.5      B: 14.0 Ford	14 V 105 Amp. C: 63.5 mm.	SP / IF A: 33.0      B: 14.0 Ford	14 V 80 Amp. C: 62.0 mm.	SP / IF A: 20.0      B: 80.0 Dacia, Nissan, Renault	14 V 75 Amp. C: 40.0 mm.
 LDFMS		 FR SIG A LI RC A		 L	

CA 1485 IR		CA 1486 IR		CA 1487 IR	
					
SP / IF A: 59.0      B: 25.0 Fiat, Lancia	14 V 80 Amp. C: 70.5 mm.	SP / IF A: 30.0      B: 14.0 Audi, VW	14 V 90 Amp. C: 61.0 mm.	SP / IF A: 91.0      B: 58.0 mm. MG, Rover	14 V 85 Amp.

CA 1488 IR		CA 1489 IR		CA 1490 IR	
					
SP / IF A: 36.5      B: 14.0 Austin, Rover	14 V 65 Amp. C: 75.5 mm.	SP / FW / IF A: 30.5      B: 70.0 mm. Mercedes-Benz	14 V 90 Amp.	SP / IF A: 50.5      B: 33.5 Opel, Vauxhall	14 V 70 Amp. C: 55.0 mm.

CA 1491 IR		CA 1492 IR		CA 1493 IR	
					
SP / IF A: 83.0      B: 56.0 mm. Mercedes-Benz	14 V 150 Amp.	SP / IF A: 30.0      B: 14.0 Alfa Romeo, Lancia	14 V 120 Amp. C: 61.0 mm.	SP / IF A: 81.5      B: 56.0 mm. John Deere	14 V 115 Amp.



CA 1494 IR	CA 1496 IR	CA 1498 IR
 	 	 
<p>W B: 11.5      C: 83.0 mm. Massey Ferguson</p> <p>14 V   70 Amp.</p> 	<p>SP / IF A: 42.5      B: 22.0 Citroen, Fiat, Peugeot</p> <p>14 V   80 Amp. C: 45.5 mm.</p>	<p>SP / IF / DF A: 42.5      B: 22.0 Citroen, Peugeot</p> <p>14 V   70 Amp. C: 45.5 mm.</p> 
CA 1499 IR	CA 1500 IR	CA 1501 IR
 	 	 
<p>SP / IF A: 42.5      B: 22.0 Citroen, Fiat, Peugeot</p> <p>14 V   80 Amp. C: 45.0 mm.</p> 	<p>SP / IF A: 92.0      B: 56.0 mm. Mercedes-Benz</p> <p>14 V   90 Amp.</p>	<p>SP / IF A: 51.0      B: 33.5 Opel, Vauxhall</p> <p>14 V   100 Amp. C: 59.0 mm.</p>
CA 1502 IR	CA 1503 IR	CA 1504 IR
 	 	 
<p>SP/FW / IF A: 39.5      B: 14.0 Audi, Seat, Skoda, VW</p> <p>14 V   70 Amp. C: 61.0 mm.</p> 	<p>SP / IF A: 77.0      B: 56.0 mm. BMW</p> <p>14 V   140 Amp.</p> 	<p>SP / IF A: 39.5      B: 14.0 Seat, Skoda, VW</p> <p>14 V   70 Amp. C: 61.0 mm.</p> 
CA 1505 IR	CA 1506 IR	CA 1507 IR
 	 	 
<p>B: 80.0 mm. Mercedes-Benz</p> <p>28 V   100 Amp.</p>	<p>SP / IF A: 47.0      B: 26.5 Renault</p> <p>14 V   120 Amp. C: 64.0 mm.</p> 	<p>SP / IF A: 51.5      B: 33.5 Cadillac, Opel, Vauxhall</p> <p>14 V   120 Amp. C: 53.0 mm.</p>



CA 1508 IR		CA 1509 IR		CA 1510 IR	
P / FR A: 35.0 Ford	B: 11.5 C: 83.0 mm. 14 V 70 Amp.	SP / IF A: 42.5 Citroen, Fiat, Lancia, Peugeot	B: 22.0 C: 45.5 mm. 14 V 150 Amp.	SP / FW / IF / W A: 40.0 Seat, VW	B: 14.0 C: 61.0 mm. 14 V 70 Amp.

CA 1511 IR		CA 1512 IR		CA 1540 IR	
SP / IF A: 39.0 Seat, Skoda, VW	B: 14.0 C: 61.5 mm. 14 V 70 Amp.	SP / IF A: 39.5 Audi, Seat, Skoda, VW	B: 14.0 C: 61.5 mm. 14 V 90 Amp.	SP / FW / IF A: 30.0 Audi, VW	B: 14.0 C: 61.0 mm. 14 V 90 Amp.

CA 1541 IR		CA 1542 IR		CA 1544 IR	
SP / FW / IF A: 30.0 Audi, Skoda, VW	B: 14.5 C: 61.5 mm. 14 V 120 Amp.	SP / IF A: 39.5 Seat, Skoda, VW	B: 14.0 C: 61.0 mm. 14 V 90 Amp.	SP / FW / IF A: 20.0 Renault	B: 80.0 C: 40.0 mm. 14 V 85 Amp.

CA 1545 IR		CA 1546 IR		CA 1547 IR	
SP / IF A: 35.0 Audi, Skoda, VW	B: 14.0 C: 82.0 mm. 14 V 70 Amp.	SP / IF A: 35.0 Audi, Skoda, VW	B: 14.0 C: 82.0 mm. 14 V 90 Amp.	SP / FW / IF A: 43.0 VW	B: 14.0 C: 61.0 mm. 14 V 70 Amp.





CA 1548 IR		CA 1549 IR		CA 1550 IR	
SP / FW / IF A: 43.5    B: 14.0 VW		SP / IF / W A: 39.0    B: 14.0 Audi, Skoda, VW		P / W A: 34.0/43.0    B: 11.0 Universal  <i>Universal</i>	
14 V    90 Amp. C: 61.0 mm.		14 V    120 Amp. C: 61.0 mm.		14 V    70 Amp. C: 85.0 mm.	
CA 1551 IR		CA 1552 IR		CA 1553 IR	
P A: 71.0    B: 21.0 Volvo		P / IF / DF A: 34.5    B: 14.0 Ford		SP / FW / IF A: 42.5    B: 22.0 Alfa Romeo, Citroen, Fiat, Lancia, Opel, Peugeot, Suzuki	
14 V    90 Amp. C: 76.5 mm.		14 V    70 Amp. C: 78.5 mm.		14 V    150 Amp. C: 45.5 mm.	
CA 1554 IR		CA 1555 IR		CA 1556 IR	
P / W A: 36.0    B: 11.0 Ford		SP / IF A: 118.5    B: 56.0 mm.		P / IF A: 48.5    B: 14.0 Iveco	
14 V    70 Amp. C: 83.0 mm.		14 V    130 Amp.		14 V    90 Amp. C: 82.0 mm.	
CA 1557 IR		CA 1558 IR		CA 1559 IR	
SP / IF A: 47.0    B: 14.0 Iveco, Multicar		SP / FW / IF A: 43.5    B: 22.0 Alfa Romeo, Fiat, Lancia		SP / IF A: 60.5    B: 28.0 BMW, Land Rover	
14 V    90 Amp. C: 82.0 mm.		14 V    100 Amp. C: 55.0 mm.		14 V    120 Amp. C: 75.5 mm.	



<p><b>CA 1560 IR</b></p>  <p>SP / IF      14 V   90 Amp. A: 39.0    B: 14.0    C: 61.0 mm. Seat, Skoda, VW</p> 	<p><b>CA 1561 IR</b></p>  <p>SP / IF      14 V   100 Amp. A: 54.5    B: 33.5    C: 57.0 mm. Opel, Vauxhall</p>	<p><b>CA 1563 IR</b></p>  <p>SP / IF / W      14 V   90 Amp. A: 82.5    B: 56.0 mm. Mercedes-Benz</p>
<p><b>CA 1564 IR</b></p>  <p>SP / IF      14 V   90 Amp. A: 42.0    B: 22.0    C: 45.5 mm. Citroen, Fiat, Lancia, Peugeot</p>	<p><b>CA 1565 IR</b></p>  <p>SP / IF      14 V   75 Amp. A: 41.0    B: 17.0    C: 82.5 mm. Citroen, Fiat</p>	<p><b>CA 1566 IR</b></p>  <p>SP / IF      14 V   70 Amp. A: 39.5    B: 14.0    C: 61.0 mm. Seat, Skoda</p> 
<p><b>CA 1567 IR</b></p>  <p>SP / IF      14 V   90 Amp. A: 39.5    B: 14.0    C: 61.0 mm. Audi, Seat, Skoda</p> 	<p><b>CA 1568 IR</b></p>  <p>SP / IF      14 V   70 Amp. A: 39.5    B: 14.0    C: 61.0 mm. Seat, Skoda, VW</p> 	<p><b>CA 1569 IR</b></p>  <p>SP / IF      14 V   90 Amp. A: 47.0    B: 20.0    C: 73.5 mm. BMW</p> 
<p><b>CA 1570 IR</b></p>  <p>SP / FW / IF / W      14 V   90 Amp. A: 40.0    B: 14.0    C: 61.0 mm. Audi, Seat, Skoda, VW</p> 	<p><b>CA 1571 IR#</b></p>  <p>SP / IF      14 V   115 Amp. A: 82.5    B: 56.0 mm. Mercedes-Benz, Opel</p>	<p><b>CA 1572 IR</b></p>  <p>SP / FW / IF      14 V   120 Amp. A: 46.5    B: 27.0    C: 68.0 mm. Renault, Volvo</p> 



CA 1573 IR#	CA 1574 IR	CA 1575 IR
<p>SP / IF / W A: 46.0 B: 27.0 C: 66.5 mm. Volvo</p>	<p>IF / W B: 27.0 C: 68.5 mm. Renault V.I.</p>	<p>SP / IF A: 90.5 B: 58.0 mm. MG, Rover</p>
CA 1576 IR	CA 1577 IR	CA 1578 IR
<p>SP / IF A: 90.5 B: 58.0 mm. MG, Rover</p>	<p>SP / IF A: 51.0 B: 33.5 C: 57.0 mm. Opel, Vauxhall</p>	<p>SP / IF A: 46.5 B: 20.0 C: 73.0 mm. BMW</p>
CA 1580 IR	CA 1581 IR	CA 1582 IR
<p>SP / IF A: 47.0 B: 20.0 C: 73.5 mm. BMW</p>	<p>SP / IF A: 54.5 B: 33.5 C: 59.0 mm. Chevrolet, Holden, Opel, Vauxhall</p>	<p>SP / IF A: 51.0 B: 33.5 C: 57.0 mm. Opel, Vauxhall</p>
CA 1583 IR	CA 1584 IR	CA 1585 IR
<p>SP / IF A: 52.5 B: 27.0 C: 56.0 mm. Citroen, Peugeot</p>	<p>SP / IF A: 60.5 B: 28.0 C: 76.0 mm. BMW, Land Rover, Opel, Vauxhall</p>	<p>SP / IF A: 37.5 B: 13.0 C: 66.0 mm. Mitsubishi</p>



<b>CA 1586 IR</b>	<b>CA 1587 IR</b>	<b>CA 1588 IR</b>
 	 	 
<p>SP / IF A: 34.5    B: 14.0 Seat, Skoda, VW</p> <p>14 V    70 Amp. C: 82.0 mm.</p> 	<p>SP / IF / W A: 39.0    B: 14.0 Skoda, VW</p> <p>14 V    90 Amp. C: 60.5 mm.</p> 	<p>SP / IF A: 30.5    B: 14.0 Audi, Skoda, VW</p> <p>14 V    120 Amp. C: 82.5 mm.</p> 
<b>CA 1589 IR</b>	<b>CA 1590 IR</b>	<b>CA 1591 IR</b>
 	 	 
<p>SP / IF / DF A: 42.5    B: 22.0 Citroen, Fiat, Peugeot, Toyota</p> <p>14 V    90 Amp. C: 45.5 mm.</p> 	<p>SP / FW / IF A: 30.5    B: 14.5 Chrysler</p> <p>14 V    115 Amp. C: 60.5 mm.</p>	<p>SP / IF A: 69.0    B: 28.0 BMW</p> <p>14 V    120 Amp. C: 77.0 mm.</p> 
<b>CA 1592 IR</b>	<b>CA 1593 IR</b>	<b>CA 1621 IR</b>
 	 	 
<p>SP / IF A: 31.5    B: 79.0 Holden, Opel, Vauxhall</p> <p>14 V    100 Amp. C: 56.0 mm.</p> 	<p>W B: 80.5 mm. Mercedes-Benz</p> <p>28 V    80 Amp.</p>	<p>SP / IF A: 46.0    B: 27.0 Renault</p> <p>14 V    110 Amp. C: 67.0 mm.</p> 
<b>CA 1622 IR</b>	<b>CA 1623 IR</b>	<b>CA 1624 IR</b>
 	 	 
<p>SP / IF A: 46.5    B: 27.0 Opel, Renault, Vauxhall, Volvo</p> <p>14 V    120 Amp. C: 65.5 mm.</p> 	<p>SP / IF A: 91.5    B: 56.0 mm. Mercedes-Benz</p> <p>14 V    120 Amp.</p> 	<p>W B: 16.0    C: 182.0 mm. Scania</p> <p>28 V    140 Amp.</p>



<p><b>CA 1625 IR</b></p>  <p>SP / IF A: 90.0 B: 58.0 mm. Smart (MCC)</p> <p>14 V 75 Amp.</p>  <p>B+ D+</p>	<p><b>CA 1626 IR</b></p>  <p>SP A: 33.0 B: 14.5 C: 65.5 mm. Skoda</p> <p>14 V 90 Amp.</p>	<p><b>CA 1627 IR</b></p>  <p>SP/FW / IF A: 32.5 B: 14.0 C: 60.5 mm. Nissan, Opel, Renault, Vauxhall, Volvo</p> <p>14 V 125 Amp.</p>  <p>L IG S</p>
<p><b>CA 1628 IR</b></p>  <p>SP / IF A: 21.0 B: 80.0 C: 40.0 mm. Dacia, Renault</p> <p>14 V 98 Amp.</p>  <p>L IG S</p>	<p><b>CA 1629 IR</b></p>  <p>IF / W B: 56.0 mm. Same, Valtra</p> <p>14 V 90 Amp.</p>	<p><b>CA 1630 IR</b></p>  <p>SP/FW / IF A: 32.0 B: 70.0 mm. Mercedes-Benz</p> <p>14 V 150 Amp.</p>
<p><b>CA 1631 IR</b></p>  <p>SP / IF A: 61.0 B: 28.0 C: 75.5 mm. Land Rover, MG, Rover</p> <p>14 V 110 Amp.</p>  <p>15 61E</p>	<p><b>CA 1632 IR</b></p>  <p>SP BMW Water cooled.</p> <p>14 V 150 Amp.</p>  <p>15 L</p>	<p><b>CA 1633 IR</b></p>  <p>SP / IF A: 90.0 B: 58.0 mm. Iveco</p> <p>28 V 90 Amp.</p>  <p>L IG S</p>
<p><b>CA 1634 IR</b></p>  <p>SP/FW Mercedes-Benz Water cooled.</p> <p>14 V 150 Amp.</p>  <p>L DFM</p>	<p><b>CA 1635 IR</b></p>  <p>SP/FW / IF A: 40.0 B: 55.0 C: 74.5 mm. Ford</p> <p>14 V 115 Amp.</p>  <p>FRSIGA LI RC A</p>	<p><b>CA 1636 IR</b></p>  <p>SP / IF A: 41.0 B: 56.0 C: 75.0 mm. Ford</p> <p>14 V 105 Amp.</p>  <p>L DFMS</p>



CA 1637 IR	CA 1638 IR	CA 1639 IR
SP / IF A: 53.5    B: 27.0 Nissan, Renault	SP / IF A: 39.0    B: 55.0 Ford, Jaguar	SP / FW / IF A: 39.5    B: 55.0 Ford
14 V    70 Amp. C: 67.0 mm.	14 V    115 Amp. C: 74.0 mm.	14 V    75 Amp. C: 74.0 mm.
	FR SIG A LI RC A	LDFMS
CA 1640 IR	CA 1641 IR	CA 1642 IR
SP / IF / DF A: 75.0    B: 56.0 mm. Citroen, Peugeot	SP / IF / DF A: 75.0    B: 56.0 mm. Citroen, Peugeot	SP / IF / DF A: 75.0    B: 56.0 mm. Citroen, Peugeot
14 V    70 Amp.	14 V    80 Amp.	14 V    97 Amp.
L DF / DFM	L DF / DFM	L DF / DFM
CA 1643 IR	CA 1644 IR	CA 1645 IR
SP / IF A: 52.0    B: 27.0 Citroen, Fiat, Peugeot	SP / FW / IF A: 39.0    B: 14.0 Audi, Seat, Skoda, VW	SP / FW / IF A: 36.0    B: 14.0 Nissan, Opel, Renault, Vauxhall, Volvo
14 V    120 Amp. C: 68.5 mm.	14 V    120 Amp. C: 61.0 mm.	14 V    125 Amp. C: 61.0 mm.
	L DFM	L
CA 1646 IR	CA 1647 IR	CA 1648 IR
SP / IF A: 42.5    B: 22.0 Citroen, Fiat, Lancia, Peugeot	SP / IF A: 60.5    B: 32.0 mm. Fiat	SP / IF A: 58.5    B: 25.0 Fiat, Lancia
14 V    120 Amp. C: 45.5 mm.	14 V    60 Amp.	14 V    105 Amp. C: 71.0 mm.

























CA 1649 IR	CA 1650 IR	CA 1651 IR
 	 	 
IF B: 17.0 C: 69.5 mm. Ford	SP / IF / W A: 19.5 B: 85.5 C: 34.5 mm. Scania	SP / IF / W A: 39.5 B: 14.0 C: 70.0 mm. Rover
		 B+D+ W
CA 1652 IR	CA 1653 IR	CA 1654 IR
 	 	 
SP / FW / IF A: 42.0 B: 15.0 C: 57.0 mm. Nissan, Renault	SP / FW / IF A: 46.0 B: 27.0 C: 67.0 mm. Renault	SP / FW / IF A: 28.5 B: 63.0 C: 41.5 mm. BMW
		 COM
CA 1656 IR	CA 1658 IR	CA 1659 IR
 	 	 
SP / IF A: 82.0 B: 56.0 mm. Mercedes-Benz	SP / IF A: 54.5 B: 34.0 C: 57.0 mm. Opel, Renault, Vauxhall	W B: 15.5 C: 180.0 mm. Evobus, Kässbohrer, Mercedes-Benz
		
CA 1660 IR	CA 1661 IR	CA 1662 IR
 	 	 
SP / FW / IF A: 29.0 B: 63.0 C: 41.5 mm. BMW	SP / IF A: 33.0 B: 14.0 C: 61.0 mm. Nissan, Opel, Renault, Vauxhall	SP / FW / IF A: 32.5 B: 14.0 C: 60.5 mm. Renault
 COM		



CA 1663 IR		CA 1664 IR		CA 1665 IR	
IF / W B: 80.0 mm. MAN, Neoplan	28 V 90 Amp.	SP / IF A: 35.0 B: 14.0 Audi, Skoda, VW	14 V 120 Amp. C: 82.0 mm.	SP / IF / DF A: 42.0 B: 22.0 Citroen, Peugeot	14 V 80 Amp. C: 45.5 mm.
CA 1666 IR		CA 1667 IR		CA 1670 IR	
IF / W B: 77.5 mm. Mercedes-Benz	28 V 80 Amp.	W B: 15.5 C: 182.0 mm. Renault V.I., Volvo	28 V 140 Amp.	B: 22.0 C: 110.0 mm. Volvo	28 V 180 Amp.
CA 1671 IR		CA 1672 IR		CA 1673 IR	
SP / IF A: 36.0 B: 13.0 C: 81.0 mm. Citroen, Daewoo	14 V 85 Amp.	SP / IF A: 36.0 B: 13.0 C: 81.0 mm. Daewoo	14 V 85 Amp.	SP / FW / IF A: 44.0 B: 20.0 C: 82.0 mm. Volvo	14 V 140 Amp.
CA 1674 IR		CA 1675 IR		CA 1676 IR	
SP / IF / DF A: 42.5 B: 21.0 C: 45.0 mm. Citroen, Fiat, Lancia, Peugeot, Suzuki, Toyota	14 V 150 Amp.	SP / IF A: 30.0 B: 14.0 C: 60.5 mm. Seat, Skoda, VW	14 V 90 Amp.	SP / IF A: 38.0 B: 83.0 C: 43.5 mm. Mini	14 V 105 Amp.





<p><b>CA 1678 IR</b></p>  <p>SP / FW / IF A: 29.0 B: 14.0 Audi, Skoda, VW</p> <p>14 V 140 Amp. C: 60.5 mm.</p> 	<p><b>CA 1679 IR</b></p>  <p>SP / IF A: 47.0 B: 14.0 Iveco, Multicar</p> <p>14 V 120 Amp. C: 80.5 mm.</p> 	<p><b>CA 1680 IR</b></p>  <p>SP / FW / DF A: 30.0 B: 151.5 Mercedes-Benz <i>Water cooled.</i></p> <p>14 V 150 Amp. C: 42.5 mm.</p> 
<p><b>CA 1681 IR</b></p>  <p>SP / IF / DF A: 42.0 B: 22.0 Citroen, Peugeot</p> <p>14 V 90 Amp. C: 45.5 mm.</p> 	<p><b>CA 1682 IR</b></p>  <p>SP / FW / IF A: 39.0 B: 14.5 Ford, Seat, Skoda, VW</p> <p>14 V 70 Amp. C: 61.0 mm.</p> 	<p><b>CA 1683 IR</b></p>  <p>SP / IF A: 118.0 B: 56.0 mm. Saab</p> <p>14 V 140 Amp.</p>
<p><b>CA 1684 IR</b></p>  <p>SP / IF / W A: 46.5 B: 14.0 Renault V.I.</p> <p>14 V 90 Amp. C: 78.5 mm.</p> 	<p><b>CA 1685 IR</b></p>  <p>SP / F/IF A: 92.0 B: 56.0 mm. Daewoo, Ssangyong</p> <p>14 V 75 Amp.</p> 	<p><b>CA 1687 IR</b></p>  <p>SP / IF / DF A: 42.0 B: 22.5 Citroen, Peugeot</p> <p>14 V 70 Amp. C: 45.5 mm.</p> 
<p><b>CA 1688 IR</b></p>  <p>SP / IF A: 29.5 B: 14.5 Alfa Romeo</p> <p>14 V 120 Amp. C: 61.0 mm.</p> 	<p><b>CA 1689 IR</b></p>  <p>SP / IF A: 92.0 B: 56.0 mm. Mercedes-Benz</p> <p>14 V 120 Amp.</p> 	<p><b>CA 1691 IR</b></p>  <p>SP / W A: 33.5 B: 11.0 Ford</p> <p>14 V 70 Amp. C: 83.0 mm.</p>



CA 1692 IR#		CA 1693 IR		CA 1694 IR	
SP / W A: 34.0 Ford	B: 11.0 C: 81.5 mm. 14 V 70 Amp.	IF / W B: 80.0 mm. Bova, DAF, Solaris	28 V 110 Amp.	IF / W B: 80.0 mm. Bova, DAF, Solaris	28 V 80 Amp.

CA 1695 IR		CA 1696 IR		CA 1697 IR	
IF / W B: 78.5 mm. MAN	28 V 55 Amp.	SP/FW / IF A: 43.5 B: 17.0 Fiat	14 V 65 Amp. C: 54.5 mm.	SP/FW / IF A: 44.5 B: 17.0 Fiat	14 V 90 Amp. C: 54.5 mm.

CA 1698 IR		CA 1699 IR		CA 1700 IR	
SP/FW / IF A: 44.5 B: 22.0 Alfa Romeo, Fiat, Lancia	14 V 120 Amp. C: 54.5 mm.	IF / W B: 14.0 C: 81.0 mm. Ginaf, Iveco	28 V 70 Amp.	SP / IF A: 40.0 B: 14.0 Fiat, Iveco	14 V 110 Amp. C: 83.0 mm.

CA 1701 IR		CA 1729 IR		CA 1730 IR	
SP / IF A: 31.0 B: 93.5 Mercedes-Benz	14 V 200 Amp. C: 56.0 mm.	SP / IF A: 39.0 B: 14.0 Audi, Seat, Skoda, VW	14 V 110 Amp. C: 61.0 mm.	SP / IF A: 50.5 B: 34.0 Holden, Opel, Vauxhall	14 V 140 Amp. C: 57.0 mm.



CA 1731 IR		CA 1732 IR		CA 1733 IR	
SP / IF A: 51.0    B: 33.5 Opel, Vauxhall	14 V    120 Amp. C: 57.0 mm.	SP / IF A: 91.5    B: 56.0 mm. Mercedes-Benz	14 V    90 Amp.	SP / IF A: 40.5    B: 14.5 VW	14 V    110 Amp. C: 61.0 mm.

CA 1734 IR		CA 1735 IR		CA 1736 IR#	
SP / IF A: 90.0    B: 58.0 mm. Smart (MCC)	14 V    75 Amp.	SP / W A: 92.0    B: 56.0 mm. Mercedes-Benz	14 V    55 Amp.	B: 80.0 mm. Fendt	14 V    95 Amp.

CA 1737 IR		CA 1738 IR		CA 1739 IR	
SP / IF A: 9.5    B: 72.0    C: 53.0 mm. Ford, Mazda	14 V    70 Amp.	IF / W B: 27.5    C: 70.0 mm. Renault V.I.	28 V    60 Amp.	IF / W B: 79.5 mm. Mercedes-Benz	28 V    100 Amp.

CA 1740 IR		CA 1741 IR		CA 1742 IR	
SP / IF A: 31.5    B: 79.0    C: 55.5 mm. Holden, Opel, Saab, Vauxhall	14 V    120 Amp.	SP / IF / DF A: 41.5    B: 22.0    C: 45.0 mm. Citroen, Peugeot	14 V    120 Amp.	SP / IF A: 17.5    B: 24.0    C: 50.5 mm. Fiat, Ford, Lancia	14 V    85 Amp.























CA 1743 IR		CA 1744 IR		CA 1745 IR	
<b>SP / IF</b> A: 44.0    B: 17.5 Alfa Romeo, Fiat, Lancia		<b>W</b> B: 22.5    C: 68.0 mm. Scania		<b>SP / IF</b> A: 52.0    B: 34.0 Chevrolet, Daewoo	
14 V    90 Amp. C: 54.5 mm.		28 V    65 Amp.		14 V    85 Amp. C: 60.5 mm.	
 L I S					

CA 1746 IR		CA 1747 IR		CA 1748 IR	
<b>SP / IF</b> A: 30.0    B: 14.0 Audi, Skoda, VW		<b>SP / IF</b> A: 53.5    B: 33.5 Opel, Vauxhall		<b>SP / IF</b> A: 54.0    B: 33.5 Opel, Vauxhall	
14 V    140 Amp. C: 82.0 mm.		14 V    70 Amp. C: 57.0 mm.		14 V    100 Amp. C: 57.0 mm.	
 L DFM					

CA 1749 IR		CA 1750 IR		CA 1752 IR	
<b>SP / FW / IF</b> A: 29.5    B: 14.0 Porsche, VW		<b>SP / IF / W</b> A: 40.0    B: 14.0 VW		<b>SP / FW / IF</b> A: 30.0    B: 70.0 Mercedes-Benz	
14 V    150 Amp. C: 61.5 mm.		14 V    90 Amp. C: 61.0 mm.		14 V    120 Amp. C: 56.0 mm.	
 L DFM		 L DFM		 COM	

CA 1753 IR#		CA 1754 IR		CA 1755 IR	
<b>SP / IF</b> A: 45.0    B: 22.0 Fiat, Lancia		<b>SP / FW / IF</b> A: 28.5    B: 70.0 Audi, Seat		<b>SP / IF</b> A: 29.0    B: 14.0 Seat, Skoda, VW	
14 V    120 Amp. C: 54.5 mm.		14 V    120 Amp. C: 56.5 mm.		14 V    70 Amp. C: 61.0 mm.	
 L DFM		 L DFM		 L DFM	



<p><b>CA 1756 IR</b></p>  <p>SP / IF A: 60.5 B: 28.0 BMW, Land Rover</p> <p>14 V 150 Amp. C: 75.5 mm.</p>  <p>L DFM</p>	<p><b>CA 1757 IR</b></p>  <p>SP / IF A: 61.0 B: 28.0 BMW, Land Rover</p> <p>14 V 150 Amp. C: 75.5 mm.</p>  <p>L DFM</p>	<p><b>CA 1758 IR</b></p>  <p>SP / IF A: 40.0 B: 55.0 Ford</p> <p>14 V 90 Amp. C: 74.0 mm.</p>  <p>FR SIG A LI RC A</p>
<p><b>CA 1759 IR</b></p>  <p>SP / FW / IF A: 34.5 B: 14.0 Audi, Skoda, VW</p> <p>14 V 120 Amp. C: 82.5 mm.</p>  <p>L DFM</p>	<p><b>CA 1760 IR</b></p>  <p>SP / IF A: 33.0 B: 14.0 Ford</p> <p>14 V 80 Amp. C: 53.5 mm.</p>  <p>L</p>	<p><b>CA 1761 IR</b></p>  <p>SP / FW / IF A: 42.5 B: 21.0 Citroen, Fiat, Lancia, Peugeot</p> <p>14 V 150 Amp. C: 45.0 mm.</p>  <p>L</p>
<p><b>CA 1762 IR</b></p>  <p>SP / FW / IF / DF A: 42.5 B: 14.5 Dacia, Nissan, Renault</p> <p>14 V 110 Amp. C: 60.0 mm.</p>  <p>L DF / DFM</p>	<p><b>CA 1763 IR</b></p>  <p>SP / FW / IF A: 39.0 B: 14.5 Dodge, Ford, Mitsubishi, Seat, VW</p> <p>14 V 150 Amp. C: 61.5 mm.</p>  <p>L DFM</p>	<p><b>CA 1764 IR</b></p>  <p>SP / FW / IF A: 31.0 B: 93.5 Mercedes-Benz</p> <p>14 V 200 Amp. C: 55.5 mm.</p>  <p>L DFM</p>
<p><b>CA 1765 IR</b></p>  <p>SP / IF A: 54.5 B: 33.5 Holden, Opel, Saab, Vauxhall</p> <p>14 V 120 Amp. C: 59.0 mm.</p>  <p>B+ D+</p>	<p><b>CA 1766 IR</b></p>  <p>SP / IF A: 16.5 B: 24.0 Citroen, Fiat, Lancia</p> <p>14 V 75 Amp. C: 50.0 mm.</p>  <p>B+ D+</p>	<p><b>CA 1767 IR</b></p>  <p>SP / DF A: 33.0 B: 14.0 Renault</p> <p>14 V 155 Amp. C: 60.0 mm.</p> <p><i>Water cooled.</i></p>  <p>L DF / DFM</p>



CA 1768 IR		CA 1769 IR		CA 1770 IR#	
SP / IF A: 32.5 Renault	B: 14.0 C: 60.5 mm. 14 V 110 Amp.	SP/FW / IF A: 28.5 Audi	B: 70.0 C: 56.5 mm. 14 V 150 Amp.	W B: 16.0 DAF	C: 180.0 mm. 28 V 140 Amp.

CA 1771 IR		CA 1772 IR		CA 1773 IR	
SP/FW / IF A: 19.5 Renault	B: 80.0 C: 40.5 mm. 14 V 120 Amp.	SP / IF A: 32.5 Ford	B: 14.0 C: 54.0 mm. 14 V 90 Amp.	SP/FW / IF A: 30.0 BMW	B: 63.0 C: 41.0 mm. 14 V 110 Amp.





CA 1774 IR		CA 1775 IR		CA 1776 IR	
SP/FW / IF A: 29.0 BMW	B: 62.5 C: 41.5 mm. 14 V 145 Amp.	SP/FW / IF A: 31.0 Mercedes-Benz	B: 70.0 C: 56.5 mm. 14 V 150 Amp.	SP / IF A: 81.5 Mercedes-Benz	B: 56.0 mm. C: 150 Amp. 14 V







CA 1777 IR		CA 1778 IR		CA 1779 IR	
SP/FW / IF A: 42.5 Ford, Mazda	B: 21.0 C: 45.5 mm. 14 V 80 Amp.	SP/FW / IF A: 42.5 Ford, Mazda	B: 21.0 C: 45.0 mm. 14 V 150 Amp.	SP/FW / IF A: 40.0 Ford	B: 55.0 C: 74.0 mm. 14 V 110 Amp.







CA 1780 IR	CA 1781 IR	CA 1782 IR
		
<p>SP / IF A: 11.0    B: 72.0 Ford, Mazda</p> <p>14 V    90 Amp. C: 52.0 mm.</p>	<p>SP / IF A: 52.0    B: 27.0 Citroen, Fiat, Peugeot</p> <p>14 V    90 Amp. C: 68.5 mm.</p>	<p>SP/FW / IF A: 39.0    B: 14.0 Audi, Seat, Skoda, VW</p> <p>14 V    140 Amp. C: 61.5 mm.</p>
 <p>FR SIG A LI RC A</p>		 <p>L DFM</p>
CA 1810 IR	CA 1811 IR	CA 1812 IR
		
<p>SP/FW / IF A: 39.0    B: 14.5 Audi, Seat, Skoda, VW</p> <p>14 V    110 Amp. C: 61.5 mm.</p>	<p>SP/FW / IF A: 29.0    B: 70.0 Audi, Seat, Skoda, VW</p> <p>14 V    140 Amp. C: 56.0 mm.</p>	<p>IF / W B: 14.0    C: 82.0 mm. Ginaf, Iveco</p> <p>28 V    90 Amp.</p>
 <p>L DFM</p>	 <p>L DFM</p>	 <p>W 15DFM L S</p>
CA 1813 IR	CA 1814 IR	CA 1815 IR <sup>#</sup>
		
<p>SP / IF A: 30.5    B: 14.0 Audi, Skoda, VW</p> <p>14 V    150 Amp. C: 82.0 mm.</p>	<p>SP / IF A: 32.5    B: 14.0 Nissan, Renault</p> <p>14 V    125 Amp. C: 60.5 mm.</p>	<p>SP / IF A: 39.0    B: 14.0 Audi, Seat, Skoda, VW</p> <p>14 V    110 Amp. C: 61.0 mm.</p>
 <p>L DFM</p>	 <p>L DF/ DFM</p>	 <p>L DFM</p>
CA 1817 IR	CA 1818 IR	CA 1819 IR
		
<p>SP / IF A: 30.0    B: 14.0 Audi, Seat, Skoda, VW</p> <p>14 V    110 Amp. C: 61.0 mm.</p>	<p>SP / IF A: 38.0    B: 14.5 Audi, Seat, Skoda, VW</p> <p>14 V    110 Amp. C: 60.5 mm.</p>	<p>FW / IF B: 14.5    C: 61.0 mm. VW</p> <p>14 V    150 Amp.</p>
 <p>L DFM</p>	 <p>L DFM</p>	 <p>L DFM</p>



CA 1820 IR	CA 1821 IR	CA 1822 IR
		
FW / IF B: 14.5 VW 14 V 180 Amp. C: 61.0 mm.	SP / FW / IF A: 54.0 B: 34.0 Opel, Vauxhall 14 V 120 Amp. C: 56.5 mm.	SP / IF A: 48.0 B: 21.0 Renault, Volvo 14 V 100 Amp. C: 56.0 mm.
		

















CA 1823 IR	CA 1824 IR	CA 1825 IR
		
SP / FW / IF A: 42.5 B: 14.5 Renault 14 V 150 Amp. C: 61.5 mm.	SP / IF A: 32.5 B: 14.5 Nissan, Opel, Renault, Vauxhall 14 V 150 Amp. C: 61.0 mm.	SP / IF A: 68.5 B: 28.0 BMW 14 V 150 Amp. C: 77.5 mm.
		

CA 1826 IR	CA 1827 IR	CA 1828 IR
		
SP / IF A: 69.0 B: 28.0 BMW 14 V 120 Amp. C: 77.0 mm.	SP / IF A: 32.5 B: 14.5 Nissan, Opel, Renault, Vauxhall 14 V 150 Amp. C: 61.0 mm.	SP / IF A: 51.0 B: 33.5 Opel, Saab, Vauxhall 14 V 140 Amp. C: 57.0 mm.
		

CA 1829 IR	CA 1830 IR#	CA 1831 IR
		
SP / IF A: 33.0 B: 13.5 Nissan, Opel, Renault, Vauxhall 14 V 100 Amp. C: 61.0 mm.	SP / IF A: 61.0 B: 32.5 mm. Fiat 14 V 75 Amp.	IF / W B: 56.0 mm. Claas, John Deere 14 V 150 Amp.
		



































<p><b>CA 1832 IR</b></p>  <p>SP / IF A: 42.0    B: 22.0 Citroen</p> <p>14 V    60 Amp. C: 45.5 mm.</p> 	<p><b>CA 1833 IR</b></p>  <p>SP / IF A: 64.0    B: 23.0 Alfa Romeo, Fiat, Opel, Vauxhall</p> <p>14 V    120 Amp. C: 57.0 mm.</p>	<p><b>CA 1834 IR</b></p>  <p>SP/FW / IF A: 42.5    B: 21.0 Ford, Mazda, Volvo</p> <p>14 V    150 Amp. C: 45.5 mm.</p> 
<p><b>CA 1835 IR</b></p>  <p>SP / IF A: 51.5    B: 27.0 Citroen, Fiat, Peugeot</p> <p>14 V    120 Amp. C: 65.0 mm.</p>	<p><b>CA 1836 IR</b></p>  <p>SP / IF A: 28.5    B: 14.0 Ford</p> <p>14 V    120 Amp. C: 61.0 mm.</p> 	<p><b>CA 1837 IR</b></p>  <p>SP / IF A: 40.0    B: 14.0 Fiat, Iveco</p> <p>14 V    140 Amp. C: 81.0 mm.</p> 
<p><b>CA 1839 IR</b></p>  <p>DP / IF A: 41.5    B: 13.0 Ford, Mazda</p> <p>14 V    75 Amp. C: 66.5 mm.</p> 	<p><b>CA 1840 IR</b></p>  <p>SP/FW / IF A: 30.0    B: 70.0 Mercedes-Benz</p> <p>14 V    200 Amp. C: 57.5 mm.</p> 	<p><b>CA 1841 IR</b></p>  <p>SP/FW / IF A: 39.0    B: 14.0 Audi, VW</p> <p>14 V    140 Amp. C: 61.5 mm.</p> 
<p><b>CA 1842 IR</b></p>  <p>IF / W B: 23.0    C: 72.0 mm. Scania</p> <p>28 V    100 Amp.</p>	<p><b>CA 1843 IR</b></p>  <p>SP / IF A: 53.5    B: 32.5 mm. Fiat, Lancia</p> <p>14 V    60 Amp.</p>	<p><b>CA 1844 IR</b></p>  <p>SP / IF A: 54.0    B: 32.0 mm. Fiat, Lancia</p> <p>14 V    70 Amp.</p>



CA 1845 IR	CA 1846 IR	CA 1847 IR
		
SP / IF A: 83.0 B: 56.0 mm. Mercedes-Benz	SP/FW / IF A: 31.0 B: 70.0 C: 56.0 mm. Mercedes-Benz	IF / W B: 80.0 mm. MAN
14 V 150 Amp.	14 V 200 Amp.	28 V 80 Amp.
		
CA 1848 IR	CA 1849 IR	CA 1850 IR
		
SP/FW / IF A: 39.0 B: 14.0 C: 61.0 mm. VW	W B: 17.0 C: 65.0 mm. New Holland	SP / IF A: 42.0 B: 21.0 C: 45.0 mm. Citroen, Peugeot
14 V 150 Amp.	14 V 65 Amp.	14 V 150 Amp.
		
CA 1851 IR	CA 1852 IR	CA 1853 IR
		
SP / IF / W A: 21.0 B: 85.0 C: 35.5 mm. Scania	IF / W B: 27.0 C: 67.0 mm. Renault V.I.	IF / W B: 13.5 C: 106.0 mm. Renault V.I., Volvo
28 V 80 Amp.	28 V 60 Amp.	28 V 80 Amp.
		
CA 1854 IR	CA 1855 IR	CA 1856 IR
		
SP / IF / W A: 47.0 B: 14.0 C: 80.0 mm. Renault V.I.	SP/FW / IF A: 40.5 B: 64.0 C: 55.0 mm. Alfa Romeo, Fiat, Lancia, Opel, Suzuki, Vauxhall	SP / IF A: 41.0 B: 64.0 C: 55.5 mm. Alfa Romeo, Fiat, Lancia
14 V 120 Amp.	14 V 75 Amp.	14 V 75 Amp.
		























CA 1857 IR	CA 1858 IR	CA 1859 IR
 	 	 
IF B: 14.0 Ford 14 V 125 Amp. C: 69.0 mm.	SP/FW / IF A: 31.5 B: 79.0 Opel, Vauxhall 14 V 100 Amp. C: 56.0 mm.	SP/FW / IF A: 30.5 B: 93.0 Mercedes-Benz 14 V 200 Amp. C: 55.5 mm.
 FR SIGA LI RC A	 DFM L	 COMDFM
CA 1860 IR	CA 1861 IR	CA 1862 IR
 	 	 
SP/FW / IF A: 38.0 B: 14.0 Renault 14 V 120 Amp. C: 61.0 mm.	SP/FW / IF A: 44.5 B: 20.0 Volvo 14 V 160 Amp. C: 82.0 mm.	SP/FW / IF A: 41.0 B: 64.0 Alfa Romeo, Fiat, Lancia, Opel, Suzuki, Vauxhall 14 V 90 Amp. C: 55.0 mm.
 2 1 COM	 L	
CA 1863 IR	CA 1864 IR	CA 1865 IR
 	 	 
SP/FW / IF A: 32.5 B: 14.0 Renault 14 V 150 Amp. C: 61.0 mm.	SP/FW / IF A: 75.0 B: 72.0 Ford, Volvo 14 V 120 Amp. C: 69.0 mm.	SP/FW / IF A: 42.5 B: 21.0 Ford, Mazda, Volvo 14 V 120 Amp. C: 45.0 mm.
 L DF/ DFM	 FR SIGA LI RC A	 FR SIGA LI RC A
CA 1866 IR	CA 1867 IR	CA 1868 IR
 	 	 
SP / IF A: 32.5 B: 14.0 Renault 14 V 90 Amp. C: 61.0 mm.	SP / IF A: 18.5 B: 81.5 Mini 14 V 100 Amp. C: 44.0 mm.	SP / IF A: 19.5 B: 81.5 Mini 14 V 110 Amp. C: 43.5 mm.
 2 1 COM	 LDFM	 LDFM



CA 1869 IR	CA 1870 IR	CA 1871 IR
SP / IF A: 55.0    B: 83.0 Mini	IF / W B: 80.0 mm. MAN	IF / W B: 80.0 mm. MAN
14 V    105 Amp. C: 43.5 mm.	28 V    80 Amp.	28 V    110 Amp.
CA 1872 IR	CA 1873 IR	CA 1874 IR
SP / IF A: 82.0    B: 56.0 mm. Mercedes-Benz	SP/FW / IF A: 30.0    B: 151.5 Mercedes-Benz	SP/FW / IF A: 29.0    B: 142.0 Mercedes-Benz
14 V    120 Amp.	14 V    150 Amp. C: 42.0 mm.	14 V    115 Amp. C: 42.0 mm.
CA 1875 IR	CA 1877 IR	CA 1878 IR
SP / IF A: 30.0    B: 142.0 Mercedes-Benz	SP/FW / IF A: 32.0    B: 14.5 Nissan, Opel, Renault, Vauxhall	SP / IF A: 32.5    B: 14.0 Renault
14 V    90 Amp. C: 42.5 mm.	14 V    150 Amp. C: 61.0 mm.	14 V    120 Amp. C: 61.0 mm.
CA 1879 IR	CA 1880 IR	CA 1881 IR
SP/FW / IF A: 41.5    B: 22.0 Citroen, Fiat, Peugeot	SP / IF / W A: 20.0    B: 85.0 Scania	SP/FW / IF A: 42.0    B: 14.0 Dacia, Nissan, Renault
14 V    90 Amp. C: 45.5 mm.	28 V    100 Amp. C: 35.5 mm.	14 V    120 Amp. C: 61.0 mm.



CA 1882 IR	CA 1883 IR	CA 1884 IR
		
<p>SP / IF A: 64.0 B: 23.0 C: 57.0 mm. Opel, Vauxhall</p>	<p>IF / W B: 13.5 C: 106.0 mm. Renault V.I., Volvo</p>	<p>SP/FW / IF A: 112.5 B: 61.5 mm. Fiat, Opel, Vauxhall</p>
		
CA 1885 IR	CA 1886 IR	CA 1887 IR
		
<p>SP/FW / IF A: 112.5 B: 61.0 mm. Alfa Romeo, Fiat, Opel, Vauxhall</p>	<p>SP / IF A: 67.5 B: 32.0 mm. Alfa Romeo, Fiat, Lancia</p>	<p>SP / IF A: 38.5 B: 14.0 C: 61.0 mm. Renault</p>
		
CA 1888 IR	CA 1889 IR	CA 1890 IR
		
<p>SP/FW / IF A: 41.5 B: 21.0 C: 46.0 mm. Citroen, Peugeot</p>	<p>SP / IF A: 29.5 B: 19.0 C: 36.0 mm. Toyota</p>	<p>SP/FW / IF A: 112.5 B: 61.0 mm. Opel, Saab, Vauxhall</p>
		
CA 1904 IR	CA 1905 IR	CA 1906 IR
		
<p>SP / IF A: 56.0 B: 28.0 C: 75.5 mm. BMW</p>	<p>SP / IF A: 60.0 B: 28.5 C: 76.5 mm. BMW</p>	<p>SP/FW / IF A: 33.0 B: 13.0 C: 51.0 mm. Hyundai, Kia</p>
		



CA 1907 IR		CA 1908 IR		CA 1909 IR	
SP / IF A: 35.0 Toyota	B: 18.0 C: 45.0 mm. 14 V 100 Amp.	SP / IF A: 32.0 Mercedes-Benz	B: 70.5 C: 56.0 mm. 14 V 150 Amp.	SP / FW / IF A: 69.0 Opel, Vauxhall	B: 33.5 C: 57.0 mm. 14 V 120 Amp.

CA 1910 IR		CA 1911 IR		CA 1912 IR	
SP / FW / IF A: 39.5 Audi	B: 14.0 C: 61.0 mm. 14 V 180 Amp.	SP / IF A: 30.0 Audi	B: 14.0 C: 61.0 mm. 14 V 150 Amp.	SP / FW / IF A: 39.0 Audi, Seat, Skoda, VW	B: 14.0 C: 61.0 mm. 14 V 180 Amp.

CA 1913 IR		CA 1914 IR		CA 1915 IR	
IF B: 14.0 Citroen, Fiat, Iveco, Peugeot	C: 81.0 mm. 14 V 140 Amp.	SP / IF A: 42.5 Citroen, Peugeot	B: 21.0 C: 45.5 mm. 14 V 150 Amp.	IF B: 14.0 Fiat, Iveco	C: 81.5 mm. 14 V 110 Amp.

CA 1916 IR		CA 1917 IR		CA 1918 IR	
SP / FW / IF A: 32.5 Saab	B: 79.0 C: 56.0 mm. 14 V 120 Amp.	IF / W B: 97.0 Bova, DAF, Solaris	C: 39.0 mm. 28 V 80 Amp.	SP / IF A: 33.0 Renault	B: 14.5 C: 60.5 mm. 14 V 150 Amp.



CA 1919 IR	CA 1920 IR	CA 1921 IR
IF B: 14.0 C: 51.5 mm. Ford	SP/FW / IF A: 42.0 B: 21.0 C: 45.0 mm. Citroen, Fiat, Lancia, Peugeot	SP/FW / IF A: 29.5 B: 14.0 C: 61.0 mm. Audi, Seat, Skoda, VW
CA 1922 IR	CA 1923 IR	CA 1924 IR
SP/FW / IF A: 41.0 B: 93.0 C: 74.0 mm. Ford, Land Rover	SP/FW / IF A: 37.5 B: 70.0 C: 74.0 mm. Ford, Volvo	W B: 15.5 C: 180.0 mm. Mercedes-Benz
CA 1925 IR	CA 1926 IR	CA 1927 IR
SP / IF A: 10.0 B: 72.0 C: 52.0 mm. Ford	SP / IF A: 74.5 B: 72.0 C: 69.0 mm. Ford	SP / IF A: 34.0 B: 13.0 C: 54.5 mm. Hyundai, Kia
CA 1928 IR	CA 1929 IR*	CA 1930 IR*
	PICTURES NOT AVAILABLE AT THE MOMENT	PICTURES NOT AVAILABLE AT THE MOMENT
SP/FW / IF A: 42.0 B: 93.0 C: 74.5 mm. Citroen, Fiat, Ford, Peugeot	SP / IF A: 47.5 B: 27.5 C: 39.0 mm. Toyota	SP/FW / IF A: 30.5 B: 16.5 C: 41.0 mm. Toyota



CA 1931 IR	CA 1932 IR	CA 1933 IR
<b>SP / FW / IF</b> 14 V 150 Amp. A: 75.0 B: 72.5 C: 68.0 mm. Ford, Volvo	<b>SP / IF</b> 14 V 60 Amp. A: 42.0 B: 22.0 C: 45.0 mm. Citroen, Fiat, Peugeot	<b>SP / FW / IF</b> 14 V 125 Amp. A: 38.5 B: 14.0 C: 60.5 mm. Dacia, Nissan, Renault

CA 1934 IR	CA 1935 IR	CA 1936 IR
<b>SP / FW / IF</b> 14 V 105 Amp. A: 41.0 B: 63.5 C: 54.5 mm. Fiat, Ford, Lancia, Opel, Vauxhall	<b>SP / FW / IF</b> 14 V 120 Amp. A: 41.0 B: 64.0 C: 55.0 mm. Fiat, Lancia, Opel, Vauxhall	<b>SP / FW / IF</b> 14 V 150 Amp. A: 32.5 B: 14.0 C: 60.5 mm. Renault

CA 1937 IR	CA 1938 IR	CA 1939 IR
<b>SP / IF</b> 14 V 180 Amp. A: 30.0 B: 14.0 C: 61.0 mm. Audi, VW	<b>SP / FW / IF</b> 14 V 90 Amp. A: 32.5 B: 13.0 C: 51.0 mm. Hyundai, Iveco, Kia	<b>IF</b> 28 V 110 Amp. B: 97.0 C: 40.0 mm. Bova, DAF, Solaris

CA 1940 IR	CA 1941 IR	CA 1942 IR*
<b>SP / IF</b> 14 V 100 Amp. A: 54.0 B: 33.5 C: 56.5 mm. Opel, Vauxhall	<b>IF</b> 14 V 120 Amp. B: 14.0 C: 52.0 mm. Ford	<b>SP / IF</b> 14 V 90 Amp. A: 47.5 B: 27.5 C: 39.0 mm. Toyota





CA 1943 IR*	CA 1944 IR	CA 1945 IR
<p>PICTURES NOT AVAILABLE AT THE MOMENT</p>		
<p>SP / IF                    14 V   75 Amp. A: 90.0            B: 58.0 mm. Suzuki</p>	<p>SP / IF                    14 V   150 Amp. A: 38.0            B: 14.5            C: 61.5 mm. Renault</p>	<p>SP/FW / IF                    14 V   120 Amp. A: 32.5            B: 14.5            C: 61.0 mm. Renault</p>
CA 1946 IR	CA 1947 IR*	CA 1948 IR
	<p>PICTURES NOT AVAILABLE AT THE MOMENT</p>	
<p>SP/FW / IF                    14 V   150 Amp. A: 38.0            B: 13.0            C: 81.0 mm. Nissan</p>	<p>IF                                    28 V   80 Amp. B: 27.0            C: 64.5 mm. Renault V.I.</p>	<p>SP/FW / IF                    14 V   110 Amp. A: 38.0            B: 15.0            C: 60.0 mm. Dacia, Renault</p>
CA 1949 IR	CA 1950 IR	CA 1951 IR*
		<p>PICTURES NOT AVAILABLE AT THE MOMENT</p>
<p>SP / IF                    14 V   80 Amp. A: 29.0            B: 20.0            C: 41.5 mm. Citroen, Peugeot, Toyota</p>	<p>SP/FW / IF                    14 V   100 Amp. A: 92.0            B: 52.5 mm. Toyota</p>	<p>SP/FW / IF                    14 V   90 Amp. A: 93.0            B: 53.0 mm. Toyota</p>
CA 1952 IR	CA 1953 IR	CA 1954 IR
<p>SP/FW / IF                    14 V   130 Amp. A: 113.0            B: 61.0 mm. Cadillac, Saab</p>	<p>SP / IF                    14 V   180 Amp. A: 28.0            B: 62.5            C: 42.5 mm. BMW</p>	<p>SP/FW / IF                    14 V   120 Amp. A: 25.0            B: 80.0            C: 48.0 mm. Citroen, Mini, Peugeot</p>



CA 1955 IR		CA 1956 IR		CA 1957 IR	
SP/FW / IF A: 40.0    B: 64.0 Opel, Vauxhall		SP/FW / IF A: 40.0    B: 64.0 Opel, Vauxhall		SP / IF A: 32.0    B: 14.0 Nissan	
14 V    70 Amp. C: 55.0 mm.		14 V    100 Amp. C: 55.0 mm.		14 V    120 Amp. C: 58.5 mm.	

CA 1958 IR		CA 1959 IR		CA 1960 IR	
SP/FW / IF A: 22.0    B: 50.0 Land Rover		SP/FW / IF A: 32.0    B: 14.0 Nissan, Opel, Renault, Vauxhall		SP / IF A: 63.0    B: 23.0 Opel, Vauxhall	
14 V    150 Amp. C: 48.0 mm.		14 V    150 Amp. C: 61.0 mm.		14 V    120 Amp. C: 57.5 mm.	

CA 1961 IR		CA 1962 IR		CA 1963 IR	
SP/FW / IF A: 118.0    B: 56.0 mm. Saab		SP / IF A: 9.0    B: 72.0 Ford, Volvo		SP / IF A: 45.5    B: 13.0 Nissan	
14 V    140 Amp.		14 V    120 Amp. C: 52.0 mm.		14 V    80 Amp. C: 67.5 mm.	

CA 1964 IR		CA 1965 IR*		CA 1966 IR*	
				PICTURES NOT AVAILABLE AT THE MOMENT	
SP/FW / IF A: 30.0    B: 16.0 Toyota		SP/FW / IF A: 23.5    B: 60.0 Toyota		SP/FW / IF A: 33.5    B: 33.0 Volvo	
14 V    100 Amp. C: 41.0 mm.		14 V    100 Amp. C: 71.0 mm.		14 V    150 Amp. C: 91.5 mm.	



CA 1967 IR	CA 1968 IR	CA 1969 IR
		
<p>SP/FW / IF A: 33.5    B: 33.0    C: 91.0 mm. Ford, Volvo</p>	<p>SP/FW / IF A: 56.5    B: 32.0    C: 90.0 mm. Ford, Volvo</p>	<p>SP/FW / IF A: 16.0    B: 22.0    C: 50.5 mm. Alfa Romeo, Fiat, Lancia</p>
		
CA 1970 IR	CA 1971 IR	CA 1972
		
<p>SP/FW / IF A: 42.0    B: 21.0    C: 46.0 mm. Ford, Mazda</p>	<p>SP/FW / IF A: 32.5    B: 14.5    C: 60.0 mm. Renault</p>	<p>SP/FW / IF A: 39.0    B: 13.0    C: 66.5 mm. Mazda</p>
		
CA 1973 IR	CA 1974 IR	CA 1975 IR
		
<p>SP/FW / IF A: 64.0    B: 23.0    C: 57.0 mm. Opel, Vauxhall</p>	<p>SP/FW / IF A: 38.5    B: 14.0    C: 61.5 mm. Renault</p>	<p>SP/FW / IF A: 38.5    B: 14.0    C: 61.0 mm. Renault</p>
		
CA 1976 IR	CA 1977 IR	CA 1978 IR
		
<p>SP / IF A: 53.5    B: 27.0    C: 67.5 mm. Dacia, Nissan, Renault, Vauxhall</p>	<p>SP / IF A: 45.5    B: 13.0    C: 67.0 mm. Nissan</p>	<p>SP / IF A: 29.0    B: 20.0    C: 42.0 mm. Citroen, Peugeot, Toyota</p>
		



CA 1979 IR	CA 1980 IR*	CA 1981 IR
SP / FW / IF A: 32.0 B: 14.0 C: 60.5 mm. Nissan, Renault	SP / FW / IF A: 36.0 B: 46.0 C: 44.0 mm. Honda	SP / IF A: 44.0 B: 20.0 C: 41.0 mm. Honda
CA 1982 IR	CA 1983 IR	CA 1984 IR
SP / IF A: 69.0 B: 28.0 C: 75.5 mm. BMW	DP / IF A: 37.5 B: 13.0 C: 81.0 mm. Nissan	IF / W B: 56.0 mm. John Deere
CA 1985 IR	CA 1986 IR	CA 1987 IR
SP / FW / IF A: 29.0 B: 14.5 C: 61.0 mm. Audi, Seat, Skoda, VW	SP / FW / IF A: 39.0 B: 14.5 C: 61.0 mm. Audi	SP / FW / IF A: 41.0 B: 64.0 C: 55.0 mm. Opel, Vauxhall
CA 1988 IR	CA 1989 IR	CA 1991 IR*
		PICTURES NOT AVAILABLE AT THE MOMENT
SP / FW / IF A: 44.0 B: 20.0 C: 82.0 mm. Volvo	IF B: 14.5 C: 52.0 mm. Ford	SP / FW / IF A: 32.5 B: 16.0 C: 55.0 mm. Suzuki



CA 1992 IR	CA 1993 IR	CA 1994 IR
		
<p>SP / IF A: 29.5    B: 14.0 Audi</p> <p>14 V    140 Amp. C: 60.5 mm.</p>	<p>SP / IF A: 38.5    B: 55.5 Ford</p> <p>14 V    80 Amp. C: 51.0 mm.</p>	<p>SP / FW / IF A: 112.5    B: 61.0 mm. Opel, Vauxhall</p> <p>14 V    140 Amp.</p>
 <p>COM</p>	 <p>FR SIG A LI RC A</p>	 <p>DFM L</p>
CA 1995 IR	CA 1996 IR	CA 1997 IR
		
<p>SP / FW / IF A: 113.0    B: 61.0 mm. Alfa Romeo, Fiat, Lancia, Suzuki</p> <p>14 V    140 Amp.</p>	<p>SP / FW / IF A: 28.0    B: 70.0 Audi</p> <p>14 V    150 Amp. C: 58.0 mm.</p>	<p>IF B: 80.0 mm. MAN, Neoplan, Temsa</p> <p>28 V    120 Amp.</p>
	 <p>COM DFM</p>	 <p>W 15DFM L S</p>
CA 1998 IR	CA 1999 IR	CA 2000 IR
		
<p>SP / IF A: 66.5    B: 70.0 mm. Fiat</p> <p>14 V    105 Amp.</p>	<p>IF B: 14.5    C: 52.0 mm. Ford</p> <p>14 V    150 Amp.</p>	<p>SP / FW / IF A: 42.0    B: 21.0    C: 45.5 mm. Ford, Volvo</p> <p>14 V    150 Amp.</p>
	 <p>FR SIG A LI RC A</p>	 <p>COM</p>
CA 2001 IR	CA 2002 IR	CA 2003 IR
		
<p>SP / FW / IF A: 61.0    B: 32.0    C: 92.0 mm. Volvo</p> <p>14 V    180 Amp.</p>	<p>SP / IF A: 29.5    B: 14.0    C: 61.0 mm. Audi</p> <p>14 V    140 Amp.</p>	<p>SP / IF A: 38.5    B: 14.0    C: 61.0 mm. Renault</p> <p>14 V    110 Amp.</p>
 <p>COM</p>	 <p>L DFM</p>	 <p>1 COM</p>



CA 2004 IR	CA 2005 IR	CA 2006 IR
<b>SP / IF</b> 14 V   80 Amp. <b>A: 90.0</b> <b>B: 58.0 mm.</b> Suzuki	<b>SP/FW / IF</b> 14 V   100 Amp. <b>A: 112.0</b> <b>B: 60.0 mm.</b> Opel, Saab, Vauxhall	<b>SP/FW / IF</b> 14 V   150 Amp. <b>A: 25.5</b> <b>B: 80.0 mm.</b> Citroen, Mini, Peugeot
CA 2007 IR	CA 2008 IR	CA 2009 IR
<b>SP/FW / IF</b> 14 V   140 Amp. <b>A: 27.5</b> <b>B: 70.0</b> <b>C: 57.0 mm.</b> Audi	<b>SP/FW / IF</b> 14 V   150 Amp. <b>A: 41.5</b> <b>B: 21.0</b> <b>C: 45.0 mm.</b> Citroen, Mitsubishi, Peugeot	<b>SP/FW / IF</b> 14 V   155 Amp. <b>A: 29.5</b> <b>B: 63.0</b> <b>C: 41.5 mm.</b> BMW
CA 2010 IR	CA 2011 IR	CA 2012 IR
<b>SP/FW / IF</b> 14 V   100 Amp. <b>A: 35.0</b> <b>B: 13.0</b> <b>C: 67.0 mm.</b> Opel, Vauxhall	<b>SP/FW / IF</b> 14 V   140 Amp. <b>A: 38.5</b> <b>B: 14.5</b> <b>C: 61.5 mm.</b> Audi, Seat, Skoda, VW	<b>SP / IF</b> 14 V   90 Amp. <b>A: 43.5</b> <b>B: 13.0</b> <b>C: 45.5 mm.</b> Smart (MCC)
CA 2013 IR*	CA 2014	CA 2015 IR
<b>SP/FW / IF</b> 14 V   120 Amp. <b>A: 34.0</b> <b>B: 13.0</b> <b>C: 54.0 mm.</b> Citroen, Mitsubishi, Peugeot	<b>SP/FW / IF</b> 14 V   100 Amp. <b>A: 39.5</b> <b>B: 60.0</b> <b>C: 83.5 mm.</b> Mazda	<b>SP / IF</b> 14 V   120 Amp. <b>A: 42.5</b> <b>B: 22.0</b> <b>C: 45.0 mm.</b> Citroen, Peugeot



CA 2016 IR	CA 2017 IR	CA 2018 IR
		<p>PICTURES NOT AVAILABLE AT THE MOMENT</p>
<p>SP/FW / IF      14 V   150 Amp.                      A: 26.0      B: 14.0      C: 65.0 mm.                      Alfa Romeo, Fiat</p>	<p>SP/FW / IF      14 V   140 Amp.                      A: 35.0      B: 13.5      C: 66.5 mm.                      Opel, Vauxhall</p>	<p>SP/FW / IF / VP      14 V   120 Amp.                      A: 102.5      B: 64.0 mm.                      Hyundai, Kia</p>
		
CA 2019 IR*	CA 2020 IR	CA 2021*
<p>PICTURES NOT AVAILABLE AT THE MOMENT</p>		<p>PICTURES NOT AVAILABLE AT THE MOMENT</p>
<p>IF      28 V   90 Amp.                      B: 27.0      C: 66.0 mm.                      Renault V.I.</p>	<p>SP / IF      14 V   90 Amp.                      A: 33.0      B: 15.0      C: 50.5 mm.                      Hyundai, Kia</p>	<p>SP/FW / IF      14 V   160 Amp.                      A: 45.5      B: 14.0      C: 60.0 mm.                      Chrysler</p>
		
CA 2022 IR	CA 2023 IR	CA 2024 IR
		
<p>SP / IF      14 V   100 Amp.                      A: 90.0      B: 58.0 mm.                      Lexus</p>	<p>SP / IF      14 V   80 Amp.                      A: 38.5      B: 15.0      C: 64.5 mm.                      Chevrolet, Daewoo</p>	<p>SP / IF      14 V   85 Amp.                      A: 90.0      B: 58.0 mm.                      Smart (MCC)</p>
		
CA 2025 IR	CA 2026 IR*	CA 2027 IR
	<p>PICTURES NOT AVAILABLE AT THE MOMENT</p>	
<p>SP/FW      14 V   155 Amp.                      A: 32.5      B: 14.0      C: 61.5 mm.                      Renault  <i>Water cooled.</i></p>	<p>SP / IF      14 V   75 Amp.                      A: 90.0      B: 58.0 mm.                      Opel, Suzuki, Vauxhall</p>	<p>SP/FW / IF      14 V   100 Amp.                      A: 33.0      B: 20.0      C: 51.0 mm.                      Toyota</p>
		



CA 2028 IR		CA 2029 IR		CA 2030 IR	
SP/FW / IF A: 45.5    B: 60.0 Volvo		SP/FW / IF A: 23.5    B: 60.0 Lexus, Toyota		SP/FW / IF A: 42.5    B: 21.0 Citroen, Peugeot	
14 V    160 Amp. C: 82.5 mm.		14 V    130 Amp. C: 71.0 mm.		14 V    180 Amp. C: 45.5 mm.	

CA 2031 IR		CA 2032 IR		CA 2033 IR	
SP/FW / IF A: 42.0    B: 21.0 Citroen, Peugeot		SP/FW / IF A: 31.0    B: 93.5 Mercedes-Benz		SP/FW / IF A: 42.5    B: 21.0 Citroen, Peugeot	
14 V    90 Amp. C: 45.5 mm.		14 V    180 Amp. C: 56.0 mm.		14 V    150 Amp. C: 45.5 mm.	

CA 2034 IR		CA 2035 IR		CA 2036 IR*	
				PICTURES NOT AVAILABLE AT THE MOMENT	
SP / IF A: 39.0    B: 55.0 Ford		SP/FW / IF A: 30.0    B: 63.0 BMW		SP/FW / IF A: 21.5    B: 60.0 Toyota	
14 V    90 Amp. C: 74.0 mm.		14 V    180 Amp. C: 41.0 mm.		14 V    100 Amp. C: 71.0 mm.	















CA 2037 IR		CA 2038 IR		CA 2039 IR	
SP / IF A: 52.0    B: 27.0 Citroen, Fiat, Peugeot		SP/FW / IF A: 30.5    B: 70.0 Mercedes-Benz		SP / IF / W A: 20.0    B: 85.0 Scania	
14 V    150 Amp. C: 66.5 mm.		14 V    180 Amp. C: 56.5 mm.		28 V    100 Amp. C: 35.5 mm.	

















CA 2040 IR	CA 2041 IR	CA 2042
<p>SP / IF                      28 V   90 Amp.                      A: 90.0            B: 58.0 mm.                      Iveco</p>	<p>SP / IF                      14 V   180 Amp.                      A: 57.0            B: 28.0            C: 75.5 mm.                      BMW</p>	<p>SP / IF                      14 V   90 Amp.                      A: 13.0            B: 13.0            C: 66.0 mm.                      Mazda</p>
CA 2043 IR	CA 2044 IR*	CA 2045 IR
<p>SP / IF                      14 V   110 Amp.                      A: 38.5            B: 14.0            C: 61.0 mm.                      Dacia, Renault</p>	<p>SP / IF                      14 V   120 Amp.                      A: 10.5            B: 72.0            C: 52.5 mm.                      Ford</p>	<p>SP/FW / IF                      14 V   120 Amp.                      A: 111.5            B: 61.0 mm.                      Opel, Vauxhall</p>
CA 2046 IR*	CA 2047 IR*	CA 2048 IR
<p>PICTURES NOT AVAILABLE AT THE MOMENT</p>	<p>PICTURES NOT AVAILABLE AT THE MOMENT</p>	
<p>SP / IF                      14 V   70 Amp.                      A: 54.5            B: 33.5            C: 60.0 mm.                      Opel, Vauxhall</p>	<p>SP / IF                      14 V   70 Amp.                      A: 34.0            B: 18.0            C: 40.5 mm.                      Toyota</p>	<p>SP/FW / IF                      14 V   90 Amp.                      A: 45.0            B: 17.0            C: 54.5 mm.                      Fiat, Lancia</p>
CA 2049 IR*	CA 2050 IR*	CA 2051 IR*
<p>PICTURES NOT AVAILABLE AT THE MOMENT</p>	<p>PICTURES NOT AVAILABLE AT THE MOMENT</p>	
<p>SP/FW / IF                      14 V   100 Amp.                      A: 112.5            B: 61.0 mm.                      Alfa Romeo, Fiat, Lancia</p>	<p>SP/FW / IF                      14 V   120 Amp.                      A: 57.0            B: 48.0 mm.                      Alfa Romeo, Fiat, Lancia</p>	<p>SP / IF                      14 V   150 Amp.                      A: 61.0            B: 28.0            C: 76.0 mm.                      BMW</p>















CA 2052 IR	CA 2053 IR	CA 2054 IR
		
SP / IF A: 19.5    B: 101.0    C: 43.0 mm. Mini	SP/FW / IF A: 32.0    B: 70.0    C: 56.0 mm. Mercedes-Benz	SP / IF A: 33.5    B: 14.0    C: 61.0 mm. Renault
		
CA 2055 IR	CA 2056 IR*	CA 2057 IR
		
SP/FW / IF A: 29.5    B: 70.0    C: 55.5 mm. Mercedes-Benz	SP / IF A: 30.0    B: 14.0    C: 61.0 mm. Audi, Seat, Skoda, VW	SP / IF A: 32.5    B: 14.0    C: 61.0 mm. Renault
		
CA 2058 IR*	CA 2059 IR*	CA 2060 IR*
	PICTURES NOT AVAILABLE AT THE MOMENT	
SP / IF A: 33.0    B: 13.5    C: 61.0 mm. Renault	SP / IF A: 54.5    B: 32.5 mm. Fiat	SP / IF A: 62.5    B: 32.0 mm. Fiat
		
CA 2061 IR*	CA 2062 IR*	CA 2063 IR*
	PICTURES NOT AVAILABLE AT THE MOMENT	
SP / IF A: 62.5    B: 32.0 mm. Fiat, Lancia	SP/FW / IF A: 44.5    B: 22.5    C: 54.5 mm. Alfa Romeo, Fiat, Lancia	SP / IF A: 54.0    B: 32.5 mm. Fiat



CA 2064 IR*	CA 2065 IR	CA 2066 IR*
PICTURES NOT AVAILABLE AT THE MOMENT		PICTURES NOT AVAILABLE AT THE MOMENT
<b>SP / FW / IF</b> 14 V   90 Amp. <b>A: 38.0    B: 14.0    C: 61.0 mm.</b> Seat, Skoda, VW	<b>SP / FW / IF</b> 14 V   110 Amp. <b>A: 39.0    B: 14.0    C: 61.0 mm.</b> Seat, Skoda, VW	<b>SP / IF</b> 14 V   85 Amp. <b>A: 53.0    B: 27.0    C: 66.0 mm.</b> Renault
		
CA 2067 IR*	CA 2068 IR*	CA 2069 IR*
PICTURES NOT AVAILABLE AT THE MOMENT	PICTURES NOT AVAILABLE AT THE MOMENT	PICTURES NOT AVAILABLE AT THE MOMENT
<b>SP / IF</b> 14 V   140 Amp. <b>A: 50.5    B: 33.5    C: 57.0 mm.</b> Opel, Vauxhall	<b>SP / IF</b> 14 V   140 Amp. <b>A: 59.0    B: 33.5    C: 52.0 mm.</b> Saab	<b>SP / FW / IF</b> 14 V   100 Amp. <b>A: 95.0    B: 58.0 mm.</b> Toyota
		
CA 2070 IR*	CA 2071*	CA 2072 IR*
PICTURES NOT AVAILABLE AT THE MOMENT	PICTURES NOT AVAILABLE AT THE MOMENT	PICTURES NOT AVAILABLE AT THE MOMENT
<b>SP / IF</b> 14 V   140 Amp. <b>A: 16.0    B: 24.5    C: 50.0 mm.</b> Fiat, Ford, Lancia	<b>SP / FW / IF</b> 14 V   100 Amp. <b>A: 39.0    B: 13.0    C: 65.0 mm.</b> Mazda	<b>SP / FW / IF</b> 14 V   180 Amp. <b>A: 30.5    B: 70.0 mm.</b> Mercedes-Benz
		
CA 2073 IR*	CA 2074 IR*	CA 2075 IR*
PICTURES NOT AVAILABLE AT THE MOMENT	PICTURES NOT AVAILABLE AT THE MOMENT	PICTURES NOT AVAILABLE AT THE MOMENT
<b>SP / IF</b> 14 V   120 Amp. <b>A: 40.5    B: 73.0    C: 74.5 mm.</b> Jaguar	<b>SP / IF</b> 14 V   100 Amp. <b>A: 90.0    B: 58.0 mm.</b> Land Rover	<b>SP / IF</b> 14 V   105 Amp. <b>A: 89.5    B: 57.5 mm.</b> Land Rover
		



CA 2076 IR*	CA 2077 IR*	CA 2078 IR*
PICTURES NOT AVAILABLE AT THE MOMENT	PICTURES NOT AVAILABLE AT THE MOMENT	PICTURES NOT AVAILABLE AT THE MOMENT
<b>SP / IF</b> 14 V   120 Amp. <b>A: 92.0      B: 56.0 mm.</b> Mercedes-Benz 	<b>SP / IF</b> 14 V   70 Amp. <b>A: 90.0      B: 57.0 mm.</b> Subaru, Suzuki 	<b>SP / IF</b> 14 V   105 Amp. <b>A: 36.5      B: 20.5      C: 38.0 mm.</b> Honda 
CA 2079 IR*	CA 2080 IR*	CA 2081 IR*
PICTURES NOT AVAILABLE AT THE MOMENT	PICTURES NOT AVAILABLE AT THE MOMENT	PICTURES NOT AVAILABLE AT THE MOMENT
<b>P / IF</b> 14 V   70 Amp. <b>A: 42.0      B: 13.0      C: 78.5 mm.</b> Nissan 	<b>SP / IF</b> 14 V   90 Amp. <b>A: 37.5      B: 17.0      C: 37.5 mm.</b> Honda 	<b>SP / FW / IF</b> 14 V   120 Amp. <b>A: 37.5      B: 12.0      C: 80.0 mm.</b> Nissan, Opel, Renault, Renault V.I., Vauxhall 
CA 2082 IR*	CA 2083 IR*	CA 2084 IR*
PICTURES NOT AVAILABLE AT THE MOMENT	PICTURES NOT AVAILABLE AT THE MOMENT	PICTURES NOT AVAILABLE AT THE MOMENT
<b>SP / FW / IF</b> 14 V   135 Amp. <b>A: 37.5      B: 13.0      C: 81.5 mm.</b> Nissan, Opel, Renault, Renault V.I., Vauxhall 	<b>SP / IF</b> 14 V   80 Amp. <b>A: 46.0      B: 13.0      C: 80.0 mm.</b> Subaru 	<b>SP / IF</b> 14 V   110 Amp. <b>A: 46.0      B: 13.0      C: 80.0 mm.</b> Subaru 
CA 2085 IR*	CA 2086 IR*	CA 2087 IR*
PICTURES NOT AVAILABLE AT THE MOMENT	PICTURES NOT AVAILABLE AT THE MOMENT	PICTURES NOT AVAILABLE AT THE MOMENT
<b>SP / FW / IF</b> 14 V   130 Amp. <b>A: 36.5      B: 13.0      C: 79.0 mm.</b> Nissan, Renault V.I. 	<b>SP / FW / IF</b> 14 V   210 Amp. <b>A: 38.0      B: 14.5      C: 64.5 mm.</b> Renault 	<b>SP / FW / IF</b> 14 V   80 Amp. <b>A: 26.5      C: 80.0 mm.</b> Citroen, Peugeot 



CA 2088 IR*	CA 2089 IR*	CA 2090 IR*
PICTURES NOT AVAILABLE AT THE MOMENT	PICTURES NOT AVAILABLE AT THE MOMENT	
<b>SP / IF</b> 14 V   95 Amp. <b>A: 43.0      B: 22.5      C: 44.5 mm.</b> Hyundai, Kia	<b>SP/FW / IF</b> 14 V   180 Amp. <b>A: 38.0      B: 14.0      C: 81.5 mm.</b> Fiat, Iveco	<b>SP / IF</b> 14 V   180 Amp. <b>A: 41.0      B: 14.0      C: 81.0 mm.</b> Fiat, Iveco
CA 2091 IR*	CA 2092*	CA 2093 IR*
PICTURES NOT AVAILABLE AT THE MOMENT	PICTURES NOT AVAILABLE AT THE MOMENT	PICTURES NOT AVAILABLE AT THE MOMENT
<b>SP/FW / IF</b> 14 V   120 Amp. <b>A: 41.0      B: 21.0      C: 45.5 mm.</b> Ford, Mazda	<b>SP/FW / IF</b> 14 V   160 Amp. <b>A: 51.0      B: 30.0 mm.</b> Chrysler, Dodge	<b>SP / IF</b> 14 V   90 Amp. <b>A: 11.5      B: 71.5      C: 51.0 mm.</b> Ford
CA 2094 IR*	CA 2095 IR*	CA 2096 IR*
PICTURES NOT AVAILABLE AT THE MOMENT	PICTURES NOT AVAILABLE AT THE MOMENT	PICTURES NOT AVAILABLE AT THE MOMENT
<b>SP / IF</b> 14 V   90 Amp. <b>A: 69.0      B: 24.0 mm.</b> Alfa Romeo, Fiat	<b>SP / IF</b> 14 V   170 Amp. <b>A: 69.0      B: 28.0      C: 76.0 mm.</b> BMW	<b>SP / IF</b> 14 V   105 Amp. <b>A: 56.0      B: 32.0      C: 91.0 mm.</b> Fiat, Lancia
CA 2097 IR*	CA 2098 IR*	CA 2099*
PICTURES NOT AVAILABLE AT THE MOMENT	PICTURES NOT AVAILABLE AT THE MOMENT	PICTURES NOT AVAILABLE AT THE MOMENT
<b>SP/FW / IF</b> 14 V   100 Amp. <b>A: 47.0      B: 20.0      C: 42.5 mm.</b> Toyota	<b>SP / IF</b> 14 V   90 Amp. <b>A: 38.5      B: 14.5      C: 61.0 mm.</b> Dacia, Renault	<b>SP / IF</b> 14 V   85 Amp. <b>A: 24.0      B: 12.0      C: 54.0 mm.</b> Chrysler, Dodge













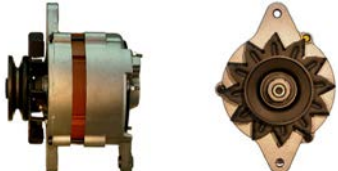





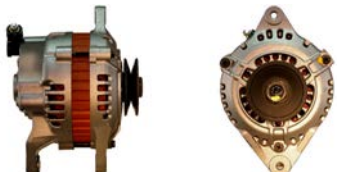



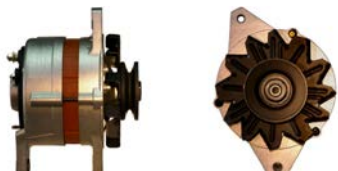

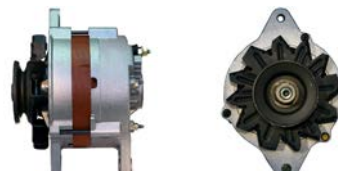
CA 2100 IR*		CA 2101 IR*		CA 2102 IR*	
PICTURES NOT AVAILABLE AT THE MOMENT		PICTURES NOT AVAILABLE AT THE MOMENT		PICTURES NOT AVAILABLE AT THE MOMENT	
SP / IF BMW	14 V 230 Amp.	SP/FW / IF Renault	14 V 120 Amp.	SP / IF Toyota	14 V 80 Amp.

CG 19		CG 50		CG 52	
14 V 30 Amp.		14 V 22 Amp.		14 V 11 Amp.	
VW		<b>B: 10.0 C: 144.0 mm.</b> Austin, Case, Ford, Lotus, MG, Morris, Triumph		<b>B: 10.0 C: 144.0 mm.</b> Case, Massey Ferguson	

CG 58		JA 100		JA 104 IR	
14 V 22 Amp.		14 V 35 Amp.		14 V 50 Amp.	
Case, Ford, Massey Ferguson		<b>P A: 42.0 B: 13.0 C: 80.0 mm.</b> Chevrolet, Ford, Nissan, Subaru		<b>P A: 42.0 B: 13.0 C: 80.5 mm.</b> Nissan	

JA 107 IR		JA 109 IR		JA 116 IR	
14 V 60 Amp.		14 V 60 Amp.		14 V 35 Amp.	
<b>P A: 42.0 B: 13.0 C: 80.0 mm.</b> Nissan		<b>DP A: 42.0 B: 13.0 C: 80.0 mm.</b> Subaru		<b>P A: 42.0 B: 13.0 C: 80.0 mm.</b> Mazda, Yanmar	







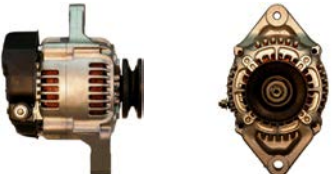





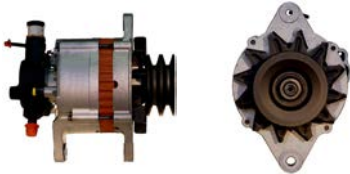

JA 118	JA 125 IR	JA 127 IR
		
<p><b>P</b> A: 42.0    B: 12.5 Daihatsu, Suzuki</p> <p>14 V    35 Amp. C: 67.0 mm.</p> 	<p><b>P</b> A: 42.0    B: 13.0 Mazda, Nissan</p> <p>14 V    60 Amp. C: 80.0 mm.</p> 	<p><b>P</b> A: 42.0    B: 13.0 Ford, Mazda</p> <p>14 V    50 Amp. C: 80.0 mm.</p> 
JA 128 IR	JA 129 IR	JA 130
		
<p><b>SP</b> A: 37.0    B: 13.0 Mazda</p> <p>14 V    65 Amp. C: 80.0 mm.</p> 	<p><b>P / IF / W</b> A: 42.0    B: 13.0 Ford, Mazda, Mercury</p> <p>14 V    55 Amp. C: 66.0 mm.</p> 	<p><b>P</b> A: 44.0    B: 12.0 Daihatsu, Kubota, Suzuki, Toyota</p> <p>14 V    30 Amp. C: 67.0 mm.</p> 
JA 131	JA 137	JA 138
		
<p><b>P</b> A: 43.5    B: 12.5 Daihatsu, Honda, Toyota</p> <p>14 V    40 Amp. C: 75.5 mm.</p> 	<p><b>P</b> A: 44.0    B: 12.0 Daihatsu, Toyota</p> <p>14 V    50 Amp. C: 76.0 mm.</p> 	<p><b>P</b> A: 44.0    B: 12.0 Daihatsu, Toyota</p> <p>14 V    45 Amp. C: 66.5 mm.</p> 
JA 140	JA 141 IR	JA 142 IR
		
<p><b>SP</b> A: 41.0    B: 12.0 Toyota</p> <p>14 V    50 Amp. C: 66.5 mm.</p> 	<p><b>SP / IF</b> A: 89.5    B: 58.0 mm. Toyota</p> <p>14 V    45 Amp.</p> 	<p><b>SP / IF</b> A: 90.0    B: 58.0 mm. Chevrolet, GEO, Toyota</p> <p>14 V    60 Amp.</p> 

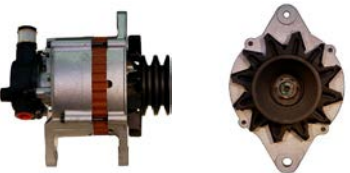

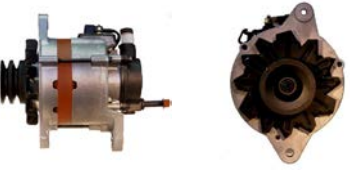
JA 144	JA 148 IR	JA 150 IR
 <p>SP                      14 V   45 Amp.            A: 41.0      B: 12.0      C: 75.0 mm.            Buick, Daihatsu, Honda, Isuzu, Opel, Toyota, VW</p> 	 <p>P / VP                      14 V   45 Amp.            A: 44.5      B: 13.0      C: 53.5 mm.            Dodge, Mazda, Mitsubishi, Plymouth</p> 	 <p>P                              14 V   45 Amp.            A: 42.0      B: 13.0      C: 47.0 mm.            Dodge, Hyundai, Mitsubishi, Plymouth</p> 
JA 151 IR	JA 158 IR#	JA 159 IR#
 <p>P                              14 V   50 Amp.            A: 42.0      B: 14.0      C: 53.5 mm.            Dodge, Mazda, Mitsubishi, Plymouth</p> 	 <p>P                              14 V   60 Amp.            A: 41.5      B: 13.0      C: 80.0 mm.            Nissan</p> 	 <p>SP / IF                      14 V   65 Amp.            A: 38.5      B: 13.0      C: 48.0 mm.            Dodge, Hyundai, Mitsubishi, Plymouth</p> 
JA 160 IR	JA 161 IR	JA 163 IR
 <p>P / IF                      14 V   45 Amp.            A: 43.5      B: 24.0 mm.            Daihatsu</p> 	 <p>SP / IF                      14 V   70 Amp.            A: 90.0      B: 58.0 mm.            Toyota</p> 	 <p>SP / IF                      14 V   60 Amp.            A: 39.0      B: 13.5      C: 81.0 mm.            Nissan</p> 
JA 166 IR	JA 171 IR	JA 173 IR
 <p>SP / IF                      14 V   70 Amp.            A: 36.5      B: 13.0      C: 81.5 mm.            Nissan</p> 	 <p>P                              14 V   40 Amp.            A: 41.0      B: 13.5      C: 67.0 mm.            Bedford, Subaru, Suzuki</p> 	 <p>P / IF                      14 V   60 Amp.            A: 42.5      B: 13.0      C: 66.0 mm.            Kia, Mazda, Mercury</p> 

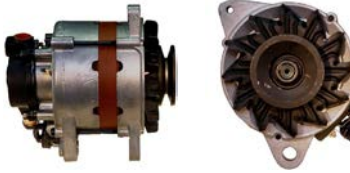



JA 174 IR	JA 180 IR	JA 185 IR
 <p>P / IF A: 42.0    B: 13.0 Mazda</p> <p>14 V    60 Amp. C: 66.0 mm.</p> 	 <p>P / VP A: 50.0    B: 13.0 Ford, Kia, Mazda</p> <p>14 V    60 Amp. C: 80.5 mm.</p> 	 <p>DP / VP A: 41.5    B: 13.0 Nissan</p> <p>14 V    50 Amp. C: 78.0 mm.</p> 
JA 187 IR#	JA 188 IR	JA 189 IR
 <p>DP / VP A: 41.5    B: 13.0 Nissan</p> <p>28 V    25 Amp. C: 80.0 mm.</p> 	 <p>P / IF A: 42.0    B: 20.0 Chevrolet, Suzuki</p> <p>14 V    45 Amp. C: 67.0 mm.</p> 	 <p>SP / IF A: 90.0    B: 58.0 mm. Chevrolet, GEO, Toyota</p> <p>14 V    55 Amp.</p> 
JA 193	JA 194 IR	JA 195
 <p>DP / VP A: 49.5    B: 14.5 Toyota</p> <p>14 V    50 Amp. C: 97.0 mm.</p> 	 <p>P / VP A: 45.5    B: 14.0 Toyota</p> <p>14 V    60 Amp. C: 61.5 mm.</p> 	 <p>P / VP A: 47.5    B: 14.0 Daihatsu</p> <p>14 V    45 Amp. C: 105.5 mm.</p> 
JA 197 IR	JA 198 IR	JA 546 IR#
 <p>P A: 41.0    B: 13.0 Nissan, Subaru</p> <p>14 V    50 Amp. C: 80.0 mm.</p> 	 <p>P / W A: 43.0    B: 13.0 Nissan</p> <p>14 V    60 Amp. C: 80.0 mm.</p> 	 <p>P / IF A: 91.0    B: 58.5 mm. Isuzu</p> <p>14 V    75 Amp.</p> 



JA 551 IR	JA 552 IR	JA 553 IR
		
P / IF A: 43.0 B: 24.0 mm. Daihatsu, Iseki, Piaggio	SP / IF A: 90.0 B: 58.0 mm. Toyota	SP / IF A: 90.0 B: 58.0 mm. Toyota
		
JA 555 IR#	JA 571 IR#	JA 575 IR
		
SP / IF A: 90.0 B: 57.0 mm. Acura, Honda, Rover, Sterling	P / VP A: 45.0 B: 14.0 C: 61.5 mm. Toyota	SP / IF A: 43.5 B: 13.0 C: 64.5 mm. Ford, Mazda
		
JA 576 IR	JA 577 IR	JA 578 IR#
		
P / IF A: 49.0 B: 13.0 C: 65.5 mm. Mazda	P / VP A: 50.0 B: 13.0 C: 80.5 mm. Ford, Mazda	P / IF / VP A: 146.5 B: 70.5 mm. Toyota
		
JA 585 IR	JA 598 IR	JA 599 IR
		
P / VP A: 45.0 B: 14.0 C: 54.0 mm. Mitsubishi	SP / IF A: 38.5 B: 13.0 C: 55.0 mm. Dodge, Hyundai, Mitsubishi, Plymouth	P / IF / W A: 43.0 B: 13.5 C: 66.0 mm. Ford, Mazda, Mercury
		











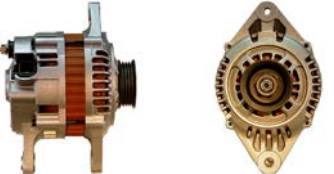
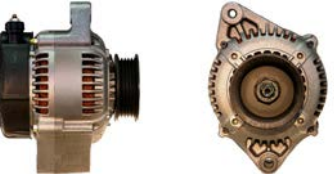

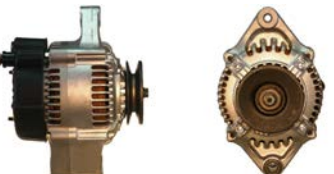



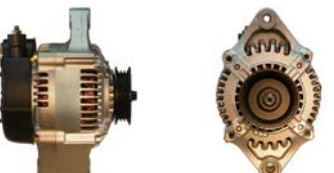
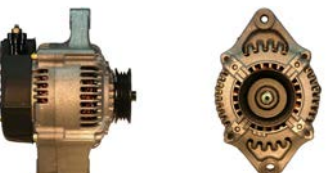

JA 652 IR		JA 653 IR		JA 654 IR#	
P / IF A: 42.0    B: 13.0 Subaru		SP / IF A: 38.0    B: 25.0 Nissan		P / VP A: 50.5    B: 13.5 Mitsubishi	
14 V    45 Amp. C: 67.0 mm.		14 V    65 Amp. C: 81.5 mm.		14 V    65 Amp. C: 55.0 mm.	
JA 657 IR		JA 659 IR		JA 660 IR	
SP / IF A: 90.0    B: 58.0 mm. Daihatsu, Toyota		SP / IF A: 38.5    B: 13.0 Nissan		DP / VP A: 42.0    B: 13.0 Nissan	
14 V    60 Amp. C: 81.0 mm.		14 V    50 Amp. C: 81.0 mm.		14 V    50 Amp. C: 80.5 mm.	
JA 662 IR		JA 663 IR#		JA 664 IR	
P / VP A: 41.5    B: 13.0 Nissan		P / VP A: 46.0    B: 13.0 Mitsubishi		SP / IF A: 34.5    B: 13.5 Hyundai, Mitsubishi	
14 V    60 Amp. C: 80.0 mm.		14 V    55 Amp. C: 54.0 mm.		14 V    65 Amp. C: 78.0 mm.	
JA 665 IR		JA 666 IR		JA 668 IR	
SP / IF A: 38.0    B: 25.0 Nissan		SP / IF A: 38.0    B: 13.0 Eagle, Mitsubishi, Plymouth		P / VP A: 42.0    B: 13.5 Mazda	
14 V    80 Amp. C: 81.0 mm.		14 V    60 Amp. C: 48.0 mm.		14 V    65 Amp. C: 65.0 mm.	

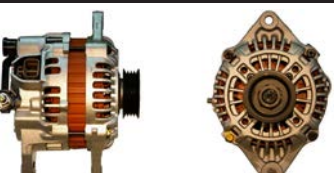

JA 670 IR	JA 671 IR	JA 672 IR
		
<b>P / IF</b> <b>A: 42.0    B: 13.0</b> <b>C: 55.0 mm.</b> Mitsubishi	<b>SP / IF</b> <b>A: 35.0    B: 13.5</b> <b>C: 78.0 mm.</b> Dodge, Eagle, Hyundai, Mitsubishi, Plymouth	<b>DP / VP</b> <b>A: 42.0    B: 13.0</b> <b>C: 80.5 mm.</b> Nissan
		
JA 673 IR	JA 674 IR	JA 675 IR#
		
<b>P / VP</b> <b>A: 42.0    B: 13.0</b> <b>C: 80.0 mm.</b> Opel, Vauxhall	<b>P / VP</b> <b>A: 44.5    B: 13.5</b> <b>C: 54.5 mm.</b> Mitsubishi	<b>P / VP</b> <b>A: 49.5    B: 13.0</b> <b>C: 80.5 mm.</b> Mazda
		
JA 677 IR	JA 678 IR	JA 680 IR#
		
<b>DP / IF / VP</b> <b>A: 43.0    B: 13.0</b> <b>C: 81.5 mm.</b> Nissan	<b>DP / VP</b> <b>A: 42.5    B: 13.5</b> <b>C: 78.0 mm.</b> Nissan	<b>P / VP</b> <b>A: 42.0    B: 13.0</b> <b>C: 75.0 mm.</b> Bedford, Isuzu, Vauxhall
		
JA 682 IR	JA 684 IR	JA 685 IR
		
<b>SP / IF</b> <b>A: 38.0    B: 20.0</b> <b>C: 66.5 mm.</b> Chevrolet, GEO, Subaru, Suzuki	<b>SP / IF</b> <b>A: 35.0    B: 13.0</b> <b>C: 78.0 mm.</b> Eagle, Hyundai, Kia, Mitsubishi, Plymouth	<b>SP / IF</b> <b>A: 39.0    B: 13.0</b> <b>C: 55.0 mm.</b> Dodge, Mitsubishi
		







































JA 689 IR	JA 694 IR	JA 696 IR
		
<p>SP / IF                      14 V   75 Amp.                      A: 39.0      B: 13.0      C: 55.0 mm.                      Dodge, Eagle, Hyundai, Mitsubishi, Plymouth</p> 	<p>SP / IF                      14 V   65 Amp.                      A: 37.5      B: 13.0      C: 66.5 mm.                      Ford, Mazda</p> 	<p>SP / IF                      14 V   65 Amp.                      A: 90.0      B: 58.5 mm.                      Honda</p> 
JA 697 IR#	JA 698 IR	JA 699 IR
		
<p>P / IF                      14 V   55 Amp.                      A: 92.5      B: 58.0 mm.                      Bedford, Isuzu, Opel, Vauxhall</p> 	<p>SP / IF                      14 V   70 Amp.                      A: 47.0      B: 13.0      C: 81.5 mm.                      Subaru</p> 	<p>P / IF                      14 V   65 Amp.                      A: 43.0      B: 13.5      C: 66.0 mm.                      Ford, Mazda, Mercury</p> 
JA 750 IR	JA 751 IR	JA 753 IR
		
<p>DP / IF / VP                      14 V   55 Amp.                      A: 147.0      B: 69.5 mm.                      Toyota</p> 	<p>SP / IF                      14 V   60 Amp.                      A: 89.5      B: 58.0 mm.                      Honda</p> 	<p>SP / IF                      14 V   60 Amp.                      A: 90.0      B: 58.0 mm.                      Honda, Rover</p> 
JA 754 IR	JA 755 IR	JA 756 IR
		
<p>P                      14 V   60 Amp.                      A: 42.0      B: 13.0      C: 80.5 mm.                      Nissan</p> 	<p>SP / IF                      14 V   80 Amp.                      A: 40.0      B: 13.0      C: 66.5 mm.                      Ford, Mazda</p> 	<p>SP                      14 V   67 Amp.                      A: 37.0      B: 25.5      C: 82.0 mm.                      Nissan</p>



JA 757 IR	JA 759 IR	JA 760 IR
<b>P / VP</b> A: 43.5      B: 13.5 Nissan	14 V    55 Amp. C: 80.5 mm.	<b>SP / IF</b> A: 90.0      B: 56.5 mm. Honda
		14 V    70 Amp. A: 90.0      B: 56.5 mm.
JA 761 IR	JA 762 IR	JA 763 IR
<b>P / VP</b> A: 48.0      B: 13.0 Isuzu, Opel, Vauxhall	14 V    50 Amp. C: 80.5 mm.	<b>SP / IF</b> A: 89.5      B: 58.0 mm. Daihatsu
	<b>SP / IF</b> A: 38.0      B: 25.0 Nissan	14 V    45 Amp. C: 82.0 mm.
JA 764 IR	JA 767 IR	JA 769 IR
<b>SP / IF</b> A: 90.0      B: 58.0 mm. Daihatsu	14 V    45 Amp.	<b>P / VP</b> A: 42.0      B: 13.0 Nissan
	<b>SP / IF</b> A: 38.0      B: 13.5 Nissan	14 V    70 Amp. C: 80.5 mm.
JA 771 IR	JA 774 IR	JA 775 IR
<b>SP / IF</b> A: 90.0      B: 58.0 mm. Honda	14 V    65 Amp.	<b>P / VP</b> A: 44.5      B: 13.5 Mitsubishi
	<b>SP / IF</b> A: 36.0      B: 13.0 Subaru	14 V    50 Amp. C: 54.0 mm.







JA 777		JA 780 IR		JA 782 IR	
					
DP / VP A: 52.0 B: 14.5 Toyota, VW	14 V 55 Amp. C: 96.5 mm.	DP / VP A: 42.5 B: 13.0 Nissan	14 V 60 Amp. C: 78.5 mm.	SP / IF A: 37.0 B: 25.5 Nissan	14 V 80 Amp. C: 81.0 mm.
					
JA 783 IR		JA 787 IR		JA 792 IR <sup>#</sup>	
					
SP / IF A: 90.0 B: 58.0 mm. Toyota	14 V 70 Amp.	P A: 76.0 B: 50.5 mm. Bobcat	14 V 55 Amp.	P / IF A: 47.5 B: 20.0 Komatsu	14 V 40 Amp. C: 67.0 mm.
					
JA 793 IR <sup>#</sup>		JA 795 IR		JA 798 IR	
					
P / VP A: 50.0 B: 13.5 Mitsubishi	14 V 65 Amp. C: 54.5 mm.	P / W A: 42.0 B: 13.0 Mazda	14 V 50 Amp. C: 80.0 mm.	SP / IF A: 38.5 B: 20.0 GEO, Subaru, Suzuki	14 V 50 Amp. C: 66.5 mm.
					
JA 805 IR		JA 806 IR		JA 863 IR	
					
P / IF A: 42.5 B: 13.5 Mazda	14 V 60 Amp. C: 65.0 mm.	SP / IF A: 37.0 B: 13.0 Ford, Mazda	14 V 90 Amp. C: 67.0 mm.	P / VP A: 42.0 B: 13.5 Opel, Vauxhall	14 V 70 Amp. C: 77.5 mm.
					









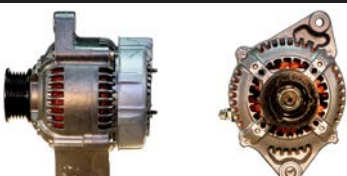

JA 864 IR	JA 866 IR	JA 867 IR
DP / IF A: 95.5      B: 58.5 mm. John Deere	SP / IF A: 90.0      B: 58.0 mm. Daihatsu	DP / VP / W A: 43.5      B: 13.5      C: 80.0 mm. Nissan
JA 868 IR	JA 870 IR	JA 871 IR
SP / IF A: 38.0      B: 25.0      C: 67.5 mm. Nissan	SP / IF A: 39.0      B: 13.0      C: 55.0 mm. Hyundai, Mitsubishi	P / VP A: 42.0      B: 13.5      C: 77.0 mm. Opel, Vauxhall
JA 873 IR	JA 874 IR	JA 876 IR
P / VP A: 49.0      B: 13.0      C: 82.0 mm. Isuzu, Opel, Vauxhall	P / VP A: 42.0      B: 13.0      C: 80.5 mm. Opel	P / IF A: 48.0      B: 13.5      C: 66.0 mm. Mazda
JA 877 IR	JA 878 IR	JA 879 IR
SP / IF A: 38.0      B: 13.0      C: 67.0 mm. Kia, Mazda	P / IF / VP A: 45.5      B: 13.5      C: 54.5 mm. Mitsubishi	SP / IF A: 35.0      B: 13.5      C: 55.0 mm. Hyundai, Proton































JA 880 IR	JA 881 IR	JA 882 IR
 <p>P / IF A: 95.5    B: 58.0 mm. Daihatsu, Piaggio</p> 	 <p>DP / IF / VP    14 V    70 Amp. A: 147.0    B: 70.0 mm. Toyota</p> 	 <p>SP / IF    14 V    80 Amp. A: 90.0    B: 58.0 mm. Toyota</p> 
JA 888 IR#	JA 971 IR	JA 973 IR
 <p>P / IF    14 V    75 Amp. A: 41.5    B: 13.0    C: 55.0 mm. Hyundai</p> 	 <p>P / IF    14 V    35 Amp. A: 43.0    B: 24.0 mm. Aixam, Kubota</p> 	 <p>P / IF    14 V    75 Amp. A: 41.5    B: 13.0    C: 55.0 mm. Mitsubishi</p> 
JA 974 IR	JA 975 IR	JA 976 IR
 <p>SP / IF    14 V    65 Amp. A: 38.0    B: 25.0    C: 82.0 mm. Nissan</p> 	 <p>SP / IF    14 V    90 Amp. A: 36.0    B: 25.0    C: 82.0 mm. Nissan</p> 	 <p>SP / IF    14 V    70 Amp. A: 52.0    B: 28.0    C: 41.5 mm. GEO, Toyota</p> 
JA 978 IR#	JA 980 IR	JA 981 IR
 <p>P / IF    14 V    45 Amp. A: 43.0    B: 21.5 mm. Daihatsu</p> 	 <p>SP / IF    14 V    70 Amp. A: 90.0    B: 58.0 mm. Honda</p> 	 <p>SP / IF    14 V    70 Amp. A: 89.5    B: 58.5 mm. Toyota</p> 





































JA 983 IR		JA 986 IR		JA 987 IR	
					
<b>DP / IF / VP</b> A: 43.0    B: 13.0 Mitsubishi		<b>P</b> A: 42.0    B: 13.0 Yanmar		<b>SP / IF</b> A: 52.5    B: 28.5 GEO, Toyota	
14 V    75 Amp. C: 54.0 mm.		14 V    55 Amp. C: 81.5 mm.		14 V    80 Amp. C: 41.5 mm.	
					

JA 988 IR		JA 989 IR		JA 990 IR	
					
<b>SP / IF</b> A: 90.0    B: 58.5 mm. Toyota		<b>DP / IF / VP</b> A: 146.0    B: 70.0 mm. Toyota		<b>SP / IF</b> A: 38.5    B: 13.0 Infiniti, Nissan	
14 V    70 Amp.		14 V    70 Amp.		14 V    110 Amp. C: 81.5 mm.	
					



















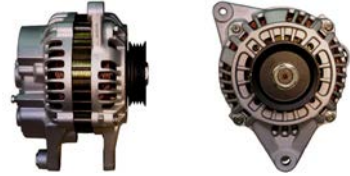



JA 991 IR		JA 994 IR		JA 995 IR	
					
<b>P / IF</b> A: 42.0    B: 25.5 Ford, Nissan		<b>SP / IF</b> A: 35.0    B: 13.0 Hyundai		<b>SP / IF</b> A: 24.0    B: 17.0 Dodge, Hyundai, Mitsubishi	
14 V    65 Amp. C: 82.5 mm.		14 V    90 Amp. C: 55.0 mm.		14 V    110 Amp. C: 55.0 mm.	
					

JA 996 IR#		JA 1117 IR		JA 1119 IR	
					
<b>SP / IF</b> A: 90.0    B: 58.0 mm. Toyota		<b>P / VP</b> A: 41.5    B: 13.5 Ford, Nissan		<b>P / IF</b> A: 95.5    B: 53.0 mm. Toyota	
14 V    70 Amp.		14 V    60 Amp. C: 80.5 mm.		14 V    80 Amp.	
					





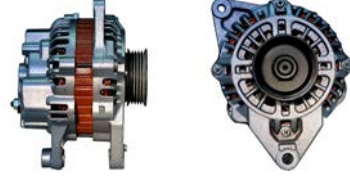

































JA 1120 IR#	JA 1121 IR	JA 1122 IR
 	 	 
<p>P / IF                      14 V   45 Amp.                      A: 92.5      B: 58.5 mm.                      Opel, Vauxhall</p> <p style="text-align: right;">IG </p>	<p>SP / IF                      14 V   50 Amp.                      A: 90.0      B: 58.0 mm.                      Daihatsu</p> <p style="text-align: right;">IG </p>	<p>P / IF                      14 V   70 Amp.                      A: 42.0      B: 13.0      C: 82.0 mm.                      Nissan</p> <p style="text-align: right;"></p>
JA 1123 IR	JA 1126 IR	JA 1129 IR
 	 	 
<p>P / IF                      14 V   60 Amp.                      A: 92.0      B: 58.0 mm.                      Toyota, VW</p> <p style="text-align: right;">S </p>	<p>SP / IF                      14 V   75 Amp.                      A: 37.0      B: 13.0      C: 55.5 mm.                      Dodge, Eagle, Hyundai, Mitsubishi, Proton</p> <p style="text-align: right;"></p>	<p>SP / IF                      14 V   70 Amp.                      A: 90.0      B: 56.5 mm.                      Honda, Rover</p> <p style="text-align: right;">IG </p>
JA 1130 IR	JA 1133 IR	JA 1134 IR
 	 	 
<p>DP / IF / VP                      14 V   75 Amp.                      A: 42.5      B: 13.5      C: 54.5 mm.                      Mitsubishi</p> <p style="text-align: right;"></p>	<p>P / IF / VP                      14 V   75 Amp.                      A: 50.5      B: 13.5      C: 55.5 mm.                      Hindustan, Mitsubishi, Proton</p> <p style="text-align: right;"></p>	<p>SP / IF                      14 V   80 Amp.                      A: 90.0      B: 58.5 mm.                      Toyota</p> <p style="text-align: right;"></p>
JA 1162 IR	JA 1164 IR#	JA 1165 IR
 	 	 
<p>DP / VP                      14 V   90 Amp.                      A: 41.0      B: 14.0      C: 82.5 mm.                      Nissan</p> <p style="text-align: right;"></p>	<p>SP / IF                      14 V   70 Amp.                      A: 90.0      B: 58.5 mm.                      Toyota</p> <p style="text-align: right;">S </p>	<p>SP / IF                      14 V   70 Amp.                      A: 89.5      B: 58.5 mm.                      Toyota</p> <p style="text-align: right;">S </p>







































JA 1166 IR	JA 1167 IR	JA 1169 IR#
 <p>P / IF A: 96.0      B: 53.0 mm. Toyota</p> <p>14 V    80 Amp.</p> 	 <p>SP / IF A: 35.0      B: 13.0      C: 78.5 mm. Dodge, Eagle, Mitsubishi, Plymouth</p> <p>14 V    75 Amp.</p> 	 <p>P A: 75.0      B: 51.0 mm. Mercury</p> <p>14 V    55 Amp.</p> 
JA 1170 IR	JA 1172 IR	JA 1173 IR
 <p>P / IF A: 44.5      B: 20.0      C: 67.0 mm. Toyota</p> <p>14 V    50 Amp.</p> 	 <p>P / VP / W A: 41.5      B: 13.0      C: 81.0 mm. Opel, Vauxhall</p> <p>14 V    70 Amp.</p> 	 <p>SP / IF A: 32.5      B: 13.0      C: 47.0 mm. Mitsubishi</p> <p>14 V    90 Amp.</p> 
JA 1174 IR	JA 1175 IR	JA 1176 IR
 <p>SP / IF A: 37.5      B: 13.0      C: 81.5 mm. Nissan</p> <p>14 V    80 Amp.</p> 	 <p>SP / IF A: 38.0      B: 25.0      C: 81.0 mm. Nissan</p> <p>14 V    80 Amp.</p> 	 <p>SP / IF A: 38.0      B: 25.0      C: 67.0 mm. Nissan</p> <p>14 V    70 Amp.</p> 
JA 1178 IR	JA 1179 IR	JA 1180 IR
 <p>SP / IF A: 89.5      B: 58.0 mm. Toyota</p> <p>14 V    55 Amp.</p> 	 <p>DP / IF / VP A: 42.5      B: 13.0      C: 55.0 mm. Mitsubishi</p> <p>14 V    65 Amp.</p> 	 <p>SP / IF A: 24.0      B: 17.0      C: 54.0 mm. Mitsubishi</p> <p>14 V    90 Amp.</p> 



JA 1181 IR		JA 1182 IR		JA 1183 IR	
					
SP / IF A: 38.5 B: 13.0 Mitsubishi	14 V 75 Amp. C: 48.0 mm.	SP / IF A: 38.0 B: 13.0 Nissan	14 V 70 Amp. C: 81.5 mm.	DP / IF / VP A: 42.0 B: 13.0 Mitsubishi	14 V 65 Amp. C: 54.5 mm.
					
JA 1184 IR		JA 1187 IR#		JA 1188 IR	
					
P / IF / VP A: 45.0 B: 13.0 Mitsubishi	14 V 90 Amp. C: 54.5 mm.	P / IF / VP A: 50.5 B: 13.0 Mitsubishi, Proton	14 V 65 Amp. C: 55.5 mm.	SP / IF A: 37.5 B: 13.0 Mazda	14 V 70 Amp. C: 66.5 mm.
					
JA 1270		JA 1271 IR		JA 1272 IR	
					
DP / VP A: 51.5 B: 14.5 Toyota	14 V 45 Amp. C: 97.0 mm.	DP / IF / VP A: 42.5 B: 13.0 Mitsubishi	14 V 75 Amp. C: 54.5 mm.	SP / IF A: 90.0 B: 58.0 mm. Acura, Honda	14 V 70 Amp.
					
JA 1276 IR		JA 1279 IR		JA 1283	
					
P / IF A: 42.0 B: 13.0 Kia	14 V 50 Amp. C: 65.0 mm.	SP / IF A: 36.5 B: 13.0 Mitsubishi	14 V 90 Amp. C: 54.5 mm.	SP / IF A: 37.5 B: 13.0 Kia, Mazda	14 V 70 Amp. C: 66.0 mm.
					



JA 1284 IR	JA 1286 IR#	JA 1287 IR
 	 	 
<p>SP / IF A: 35.0    B: 13.0 Mitsubishi</p> <p>14 V    90 Amp. C: 79.0 mm.</p> 	<p>P / IF A: 41.5    B: 13.0 Mazda</p> <p>14 V    60 Amp. C: 65.0 mm.</p> 	<p>SP / IF A: 38.5    B: 25.0 Nissan</p> <p>14 V    80 Amp. C: 81.0 mm.</p> 
JA 1289 IR	JA 1290 IR	JA 1293 IR
 	 	 
<p>SP / IF A: 90.0    B: 58.0 mm. Toyota</p> <p>14 V    55 Amp.</p> 	<p>P / VP A: 49.0    B: 13.0 Isuzu, Opel, Vauxhall</p> <p>14 V    80 Amp. C: 85.0 mm.</p> 	<p>SP / IF A: 90.0    B: 58.0 mm. Suzuki</p> <p>14 V    70 Amp.</p> 
JA 1351 IR	JA 1356 IR	JA 1357 IR
 	 	 
<p>SP / IF A: 90.0    B: 58.5 mm. Toyota</p> <p>14 V    70 Amp.</p> 	<p>SP / IF A: 90.5    B: 58.5 mm. Suzuki</p> <p>14 V    85 Amp.</p> 	<p>SP / IF A: 38.5    B: 13.0 Nissan</p> <p>14 V    100 Amp. C: 82.0 mm.</p> 
JA 1358 IR#	JA 1360 IR	JA 1363 IR#
 	 	 
<p>P / IF A: 45.0    B: 24.5 mm. Daihatsu</p> <p>14 V    40 Amp.</p> 	<p>P / IF / VP A: 50.5    B: 13.0 Hindustan, Mitsubishi</p> <p>14 V    90 Amp. C: 55.5 mm.</p> 	<p>P / IF A: 42.0    B: 25.0 Nissan</p> <p>14 V    60 Amp. C: 81.5 mm.</p> 







































JA 1364 IR		JA 1366 IR		JA 1367 IR	
					
P / IF A: 42.0    B: 13.0 Ford, Nissan		14 V    70 Amp. C: 79.0 mm.		P / VP A: 45.0    B: 13.0 Hyundai	
				DP / IF / VP A: 146.0    B: 70.0 mm. Toyota	
				  	
JA 1369 IR		JA 1370 IR		JA 1374 IR	
					
SP / IF A: 90.0    B: 58.0 mm. Toyota		14 V    70 Amp.		P / VP / W A: 42.0    B: 13.0 Opel, Vauxhall	
				SP / IF A: 38.0    B: 25.0 Nissan	
				  	
JA 1375 IR		JA 1376 IR		JA 1377 IR	
					
DP / IF A: 42.0    B: 13.5 Mitsubishi		14 V    75 Amp. C: 54.5 mm.		DP / IF A: 42.5    B: 13.0 Mitsubishi	
				P / IF A: 96.0    B: 53.0 mm. Toyota	
				  	
JA 1405 IR		JA 1406 IR		JA 1407 IR	
					
SP / IF A: 90.0    B: 58.0 mm. Honda, Rover		14 V    75 Amp.		P / IF A: 41.5    B: 25.0 Nissan	
				SP / IF A: 46.5    B: 13.0 Subaru	
				  	



JA 1409	JA 1410 IR	JA 1411 IR
SP / IF A: 39.5 B: 13.5 C: 66.0 mm. Mazda	DP / IF A: 93.5 B: 58.0 mm. Toyota	DP / IF / VP A: 42.5 B: 13.5 C: 54.0 mm. Mitsubishi
JA 1414 IR#	JA 1415 IR	JA 1417 IR
SP / IF A: 90.0 B: 56.5 mm. Honda	SP / IF A: 91.0 B: 56.5 mm. Honda	SP / IF A: 90.0 B: 58.0 mm. Toyota
JA 1418 IR	JA 1419 IR	JA 1421 IR
SP / IF A: 90.0 B: 58.0 mm. Toyota	DP / IF / VP A: 42.5 B: 13.0 C: 53.5 mm. Hyundai, Mitsubishi	DP / VP / W A: 42.5 B: 13.5 C: 80.5 mm. Nissan
JA 1424 IR	JA 1425 IR	JA 1426 IR
SP / IF / VP A: 143.5 B: 70.0 mm. Honda, Land Rover, MG, Rover	SP / IF / VP A: 143.5 B: 70.0 mm. Honda, Land Rover, MG, Rover	SP / IF A: 90.0 B: 56.5 mm. Honda, Rover





JA 1427 IR		JA 1430 IR		JA 1513 IR <sup>#</sup>	
					
P / VP A: 45.5 B: 13.0 Mitsubishi	28 V 30 Amp. C: 80.0 mm.	P / IF / VP A: 50.5 B: 13.0 Suzuki	14 V 70 Amp. C: 82.0 mm.	DP / IF A: 41.5 B: 13.0 Mazda	14 V 80 Amp. C: 65.0 mm.
					
JA 1514 IR		JA 1515 IR		JA 1516 IR	
					
SP / IF A: 90.5 B: 58.0 mm. Honda	14 V 70 Amp.	DP / IF A: 42.0 B: 13.0 Mazda	14 V 80 Amp. C: 65.5 mm.	DP / IF A: 42.0 B: 13.0 Nissan	14 V 60 Amp. C: 79.0 mm.
					
JA 1517 IR		JA 1518 IR		JA 1520 IR	
					
SP / IF A: 48.0 B: 27.5 Toyota	14 V 90 Amp. C: 39.0 mm.	DP / IF / VP A: 42.5 B: 13.0 Hyundai	14 V 110 Amp. C: 55.0 mm.	SP / IF A: 90.0 B: 58.0 mm. Honda	14 V 70 Amp.
					
JA 1521 IR		JA 1522 IR		JA 1523 IR	
					
SP / IF / VP / W A: 35.5 B: 13.0 Chevrolet, Honda, Opel, Vauxhall	14 V 100 Amp. C: 66.5 mm.	SP / IF A: 38.0 B: 13.0 Hyundai, Kia, Mitsubishi, Volvo	14 V 100 Amp. C: 64.5 mm.	SP / IF A: 38.5 B: 13.0 Mitsubishi	14 V 85 Amp. C: 64.5 mm.
					



JA 1525 IR		JA 1526 IR		JA 1527 IR	
DP / VP A: 41.5 Nissan	B: 14.0 C: 82.0 mm.	14 V 90 Amp.	SP / IF / VP / W A: 35.0 Chevrolet, Opel, Vauxhall	B: 13.0 C: 68.0 mm.	14 V 70 Amp.
				P / VP / W A: 43.5 Nissan	
				B: 13.5 C: 80.5 mm.	
JA 1528 IR		JA 1530 IR		JA 1531 IR	
P / IF A: 42.0 Nissan	B: 13.0 C: 81.0 mm.	14 V 90 Amp.	DP / IF A: 41.5 Ford, Mazda	B: 13.0 C: 65.0 mm.	14 V 70 Amp.
				SP / IF A: 37.5 Mitsubishi	
				B: 13.0 C: 66.0 mm.	
JA 1533 IR		JA 1534 IR		JA 1535 IR	
DP / IF / VP A: 42.0 Mitsubishi	B: 13.0 C: 54.0 mm.	14 V 80 Amp.	DP / IF A: 92.0 Toyota	B: 58.0 mm.	14 V 80 Amp.
				SP / IF A: 89.5 Toyota	
				B: 58.0 mm.	
JA 1536 IR		JA 1537 IR		JA 1539 IR	
SP / IF A: 90.0 Toyota	B: 58.0 mm.	14 V 55 Amp.	SP / IF A: 37.5 Kia	B: 13.0 C: 67.0 mm.	14 V 70 Amp.
				SP / IF / VP A: 47.0 Kia	
				B: 13.0 C: 80.0 mm.	



JA 1594 IR		JA 1595 IR		JA 1596 IR	
DP / IF A: 42.5 Nissan	B: 13.0 C: 81.5 mm.	SP / IF A: 33.5 Toyota	B: 18.0 C: 41.5 mm.	SP / IF A: 90.0 MG, Rover	B: 58.0 mm. C: 90.0 mm.
JA 1598		JA 1599 IR		JA 1600 IR	
SP / IF A: 40.0 Mazda	B: 13.0 C: 66.5 mm.	SP / IF A: 90.0 Toyota	B: 58.0 mm. C: 80.0 mm.	P / IF A: 41.5 Chevrolet, Daewoo	B: 17.0 C: 66.0 mm.
JA 1601 IR		JA 1602 IR		JA 1603 IR	
SP / IF A: 24.5 Mitsubishi	B: 17.0 C: 54.0 mm.	SP / FW / IF A: 37.5 Nissan	B: 13.0 C: 80.5 mm.	P / VP / W A: 43.5 Nissan	B: 13.5 C: 80.5 mm.
JA 1604 IR		JA 1605 IR		JA 1606 IR	
P / IF A: 95.5 Toyota	B: 53.0 mm. C: 80.0 mm.	SP / IF A: 34.0 Toyota	B: 18.5 C: 40.5 mm.	SP / IF A: 38.0 Nissan	B: 25.0 C: 80.5 mm.



JA 1607 IR	JA 1608 IR	JA 1609 IR
 <p>SP / IF A: 39.0      B: 13.0 Nissan</p> <p>14 V    80 Amp. C: 81.0 mm.</p> 	 <p>SP / IF A: 90.0      B: 58.0 mm. Rover</p> <p>14 V    90 Amp.</p> 	 <p>SP / IF A: 48.0      B: 29.0 mm. Daihatsu</p> <p>14 V    60 Amp.</p> 
JA 1610	JA 1611 IR	JA 1612 IR
 <p>SP / IF A: 37.5      B: 13.0 Mazda</p> <p>14 V    70 Amp. C: 67.0 mm.</p> 	 <p>P / IF A: 42.0      B: 13.0 Nissan</p> <p>14 V    100 Amp. C: 81.0 mm.</p> 	 <p>SP / IF A: 89.5      B: 58.0 mm. Suzuki</p> <p>14 V    60 Amp.</p> 
JA 1613 IR	JA 1614 IR	JA 1615 IR
 <p>SP / IF A: 35.5      B: 18.0 Toyota</p> <p>14 V    100 Amp. C: 45.5 mm.</p> 	 <p>P / VP / W A: 42.5      B: 13.5 Nissan</p> <p>14 V    55 Amp. C: 80.5 mm.</p> 	 <p>P / IF A: 42.5      B: 13.0 Nissan</p> <p>14 V    90 Amp. C: 81.0 mm.</p> 
JA 1616 IR	JA 1617 IR	JA 1618 IR
 <p>DP / IF A: 94.0      B: 58.0 mm. John Deere</p> <p>14 V    140 Amp.</p> 	 <p>DP / IF A: 42.0      B: 13.5 Mitsubishi</p> <p>14 V    125 Amp. C: 60.0 mm.</p> 	 <p>P / VP A: 45.0      B: 13.0 Hyundai</p> <p>14 V    65 Amp. C: 54.5 mm.</p> 



JA 1702 IR		JA 1703 IR		JA 1704 IR	
P / IF A: 42.0    B: 13.0 Nissan		SP / IF A: 33.5    B: 18.0 Toyota		SP / IF A: 46.0    B: 13.0 Subaru	
14 V    80 Amp. C: 81.0 mm.		14 V    80 Amp. C: 40.0 mm.		14 V    80 Amp. C: 80.0 mm.	
JA 1705		JA 1706		JA 1707	
SP / IF A: 39.5    B: 60.0 Mazda		SP / IF A: 34.0    B: 12.0 Chrysler, Plymouth		SP / IF A: 33.0    B: 12.0 Chrysler, Dodge, Plymouth	
14 V    90 Amp. C: 74.0 mm.		14 V    90 Amp. C: 54.5 mm.		14 V    120 Amp. C: 54.5 mm.	
JA 1708 IR		JA 1709 IR		JA 1710 IR	
SP / FW / IF / VP A: 102.0    B: 63.5 mm. Hyundai, Kia		SP / FW / IF / VP A: 47.5    B: 13.0 Hyundai, Kia		SP / IF / VP A: 143.5    B: 70.0 mm. Land Rover	
14 V    120 Amp.		14 V    110 Amp. C: 80.5 mm.		14 V    120 Amp.	
JA 1711 IR		JA 1712 IR		JA 1713 IR	
DP / IF / VP A: 42.0    B: 13.5 Hyundai, Kia		SP / FW / IF A: 33.0    B: 13.5 Dongfeng (DFL), Nissan		SP / IF A: 46.0    B: 13.0 Subaru	
14 V    75 Amp. C: 55.0 mm.		14 V    110 Amp. C: 59.0 mm.		14 V    85 Amp. C: 80.0 mm.	



JA 1714 IR	JA 1715 IR	JA 1716 IR
 <p>SP / IF A: 47.5      B: 27.0 Toyota</p> <p>14 V    80 Amp. C: 39.0 mm.</p> 	 <p>SP / IF A: 38.0      B: 13.0 Hyundai</p> <p>14 V    60 Amp. C: 48.5 mm.</p> 	 <p>DP / IF / VP A: 42.5      B: 13.5 Hyundai, Mitsubishi</p> <p>14 V    75 Amp. C: 55.0 mm.</p> 
JA 1717 IR	JA 1718 IR	JA 1719 IR#
 <p>DP / IF / VP A: 42.5      B: 13.0 Hyundai, Mitsubishi</p> <p>14 V    90 Amp. C: 55.0 mm.</p> 	 <p>SP / IF A: 38.0      B: 13.0 Hyundai</p> <p>14 V    95 Amp. C: 67.0 mm.</p> 	 <p>SP / IF A: 91.0      B: 56.5 mm. Honda</p> <p>14 V    90 Amp.</p> 
JA 1720 IR	JA 1721 IR	JA 1722 IR
 <p>SP / IF A: 90.0      B: 58.0 mm. Honda</p> <p>14 V    75 Amp.</p> 	 <p>SP/FW / IF A: 92.0      B: 53.0 mm. Toyota</p> <p>14 V    130 Amp.</p> 	 <p>SP / IF A: 47.5      B: 27.0 Toyota</p> <p>14 V    70 Amp. C: 39.5 mm.</p> 
JA 1723 IR	JA 1724 IR	JA 1725 IR
 <p>SP / IF A: 90.0      B: 58.0 mm. Land Rover, MG, Rover</p> <p>14 V    90 Amp.</p> 	 <p>DP / IF A: 91.5      B: 58.0 mm. Toyota</p> <p>14 V    120 Amp.</p> 	 <p>SP / IF A: 45.5      B: 13.0 Nissan</p> <p>14 V    80 Amp. C: 68.0 mm.</p> 



JA 1726 IR		JA 1727 IR		JA 1728 IR	
SP / IF A: 39.0    B: 41.0 Honda		SP / IF A: 94.5    B: 58.0 mm. Honda		SP / IF A: 39.0    B: 31.0 Honda	
14 V    100 Amp. C: 46.0 mm.		14 V    70 Amp.		14 V    70 Amp.	
JA 1783 IR		JA 1784 IR		JA 1785 IR	
P / IF A: 96.0    B: 53.0 mm. Toyota		SP / IF A: 37.0    B: 13.5 Kia		SP / IF A: 37.5    B: 13.0 Kia	
14 V    120 Amp.		14 V    90 Amp. C: 67.0 mm.		14 V    80 Amp. C: 66.5 mm.	
JA 1786 IR		JA 1788 IR		JA 1789 IR	
SP / IF A: 38.0    B: 13.0 Kia		SP / IF A: 35.0    B: 13.5 Hyundai		SP / IF A: 34.0    B: 13.0 Hyundai, Kia	
14 V    80 Amp. C: 67.5 mm.		14 V    80 Amp. C: 55.0 mm.		14 V    90 Amp. C: 54.0 mm.	
JA 1790 IR		JA 1791		JA 1792 IR	
SP / IF A: 38.0    B: 25.0 Nissan		SP / IF A: 33.0    B: 12.0 Chrysler		SP / IF A: 35.5    B: 18.5 Toyota	
14 V    65 Amp. C: 66.5 mm.		14 V    120 Amp. C: 53.5 mm.		14 V    90 Amp. C: 45.5 mm.	



JA 1793 IR		JA 1794 IR		JA 1795 IR	
SP / IF A: 33.0 Toyota	B: 18.0 C: 41.5 mm.	14 V 70 Amp.		SP / IF A: 33.0 Toyota	B: 18.0 C: 41.5 mm.
JA 1796 IR		JA 1797 IR		JA 1798 IR	
SP / FW / IF A: 95.0 Toyota	B: 58.0 mm.	14 V 80 Amp.		SP / IF A: 37.5 Hyundai, Kia	B: 13.0 C: 47.5 mm.
JA 1799#		JA 1800 IR		JA 1801 IR	
SP / IF A: 38.0 Mazda	B: 13.0 C: 67.0 mm.	14 V 70 Amp.		P / VP A: 50.5 Mazda	B: 13.0 C: 85.0 mm.
JA 1802 IR		JA 1803 IR		JA 1804 IR	
DP / IF / VP A: 42.5 Mitsubishi	B: 13.0 C: 55.0 mm.	14 V 90 Amp.		SP / FW / IF / VP A: 42.5 Hyundai, Kia	B: 16.0 C: 55.0 mm.





JA 1805 IR		JA 1806 IR		JA 1807 IR	
SP / IF A: 37.5    B: 13.0 Chrysler, Mitsubishi		P/FW / IF A: 42.0    B: 13.0 Nissan		SP / IF A: 38.0    B: 13.0 Hyundai, Kia	
14 V    90 Amp. C: 66.0 mm.		14 V    110 Amp. C: 80.0 mm.		14 V    110 Amp. C: 66.0 mm.	
JA 1808 IR		JA 1809 IR		JA 1891 IR	
SP/FW / IF / VP A: 150.5    B: 72.0 mm. Hyundai		SP / IF A: 48.0    B: 27.0 Toyota		SP/FW / IF A: 31.5    B: 16.5 Toyota	
14 V    100 Amp. 		14 V    70 Amp. C: 39.0 mm.		14 V    90 Amp. C: 41.0 mm.	
JA 1892 IR		JA 1893 IR		JA 1894 IR	
SP / IF A: 31.0    B: 16.0 Toyota		SP/FW / IF A: 31.5    B: 16.0 Toyota		SP / IF A: 34.0    B: 18.0 Toyota	
14 V    90 Amp. C: 41.0 mm.		14 V    70 Amp. C: 41.5 mm.		14 V    90 Amp. C: 40.5 mm.	
JA 1895 IR		JA 1896 IR		JA 1897 IR	
SP / IF A: 47.5    B: 13.0 Mitsubishi, Smart (MCC)		SP/FW / IF A: 38.5    B: 13.0 Mazda		SP / IF A: 42.0    B: 16.0 Honda	
14 V    85 Amp. C: 46.0 mm.		14 V    90 Amp. C: 64.5 mm.		14 V    80 Amp. C: 39.0 mm.	









JA 1898		JA 1899 IR		JA 1900 IR	
SP / IF A: 13.0 Mazda	14 V 80 Amp. B: 13.0 C: 65.0 mm.	SP/FW / IF / VP A: 35.5 Opel, Vauxhall	14 V 100 Amp. B: 13.0 C: 66.5 mm.	SP/FW / IF / VP A: 35.0 Opel, Vauxhall	14 V 110 Amp. B: 13.0 C: 66.0 mm.





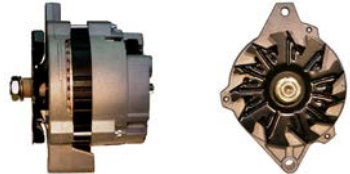

JA 1901 IR		JA 1902		JA 1903 IR	
SP/FW / IF / VP / W A: 35.0 Opel, Vauxhall	14 V 100 Amp. B: 13.0 C: 65.5 mm.	SP / IF A: 75.0 Mazda	14 V 90 Amp. B: 75.0 C: 69.0 mm.	SP / IF A: 43.5 Hyundai, Kia	14 V 120 Amp. B: 23.0 C: 44.0 mm.

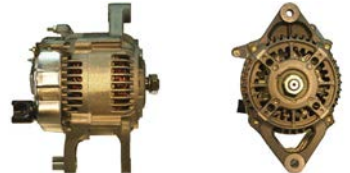

UA 916#		UA 923 IR		UA 938 IR	
P A: 77.0 American Motors, Buick, Cadillac, Chevrolet, GMC, International, Jeep, Oldsmobile, Pontiac	14 V 60 Amp. B: 51.0 mm.	B: 51.0 mm. Jeep	14 V 100 Amp.	B: 51.0 mm. Buick, Cadillac, Chevrolet, GMC, Oldsmobile, Pontiac	14 V 100 Amp.





UA 939 IR		UA 943 IR		UA 945 IR	
B: 51.0 mm. AM General, Buick, Chevrolet, GMC, Oldsmobile	14 V 100 Amp.	B: 50.5 mm. American Motors, Buick, Cadillac, Chevrolet, GMC, International, Jeep, Oldsmobile, Pontiac	14 V 60 Amp.	B: 51.0 mm. American Motors, Buick, Cadillac, Case, Chevrolet, GMC, Jeep, Oldsmobile, Pontiac	14 V 65 Amp.

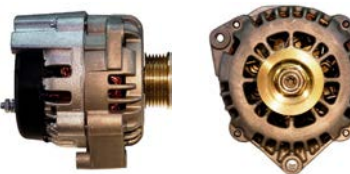
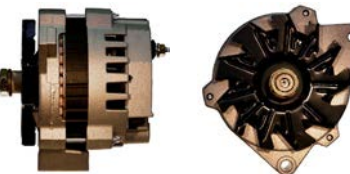

UA 947 IR	UA 953 IR#	UA 958 IR
		
<p>14 V 60 Amp. B: 51.0 mm. Buick, Jeep</p> 	<p>14 V 100 Amp. B: 51.0 mm. Buick, Chevrolet, GMC</p> 	<p>14 V 105 Amp. B: 51.0 mm. Chevrolet, GMC, Oldsmobile</p> 

UA 960	UA 963 IR	UA 964 IR
		
<p>IF 14 V 90 Amp. B: 12.0 C: 54.0 mm. Chrysler, Dodge, Jeep, Plymouth</p> 	<p>IF 14 V 130 Amp. B: 55.0 C: 74.0 mm. Ford</p> 	<p>14 V 100 Amp. B: 51.0 mm. Buick, Chevrolet, Oldsmobile, Pontiac</p> 

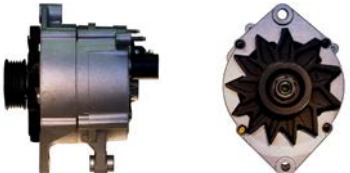
UA 967 IR	UA 1109 IR	UA 1113 IR
		
<p>SP / IF 14 V 105 Amp. A: 73.0 B: 51.0 mm. Chevrolet, GMC</p> 	<p>14 V 105 Amp. B: 51.0 mm. Buick, Chevrolet, Oldsmobile, Pontiac</p> 	<p>14 V 100 Amp. B: 51.0 mm. Buick, Chevrolet, Oldsmobile, Pontiac</p> 

UA 1210 IR#	UA 1212	UA 1213
		
<p>14 V 75 Amp. B: 76.0 mm. Ford, Mercury</p> 	<p>SP 14 V 90 Amp. A: 34.0 B: 12.0 C: 54.0 mm. Chrysler, Dodge, Plymouth</p>	<p>SP 14 V 120 Amp. A: 34.0 B: 12.0 C: 53.5 mm. Chrysler</p>



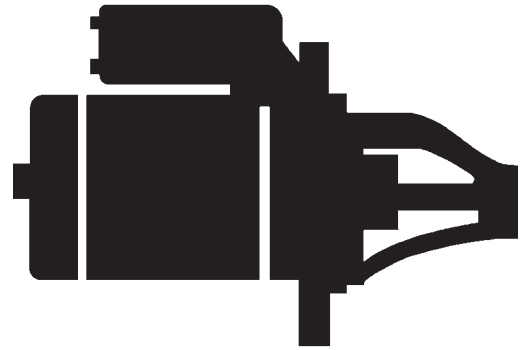

D

TYPENÜBERSICHT

DK

TYPE OVERSIGT

E

CATALOGO DE TIPOS

F

SOMMARIE

FI

YHTEENVETO

GB

TYPE SUMMARY

I

PROSPETTO

NL

TYPE-OVERZICHT

PL







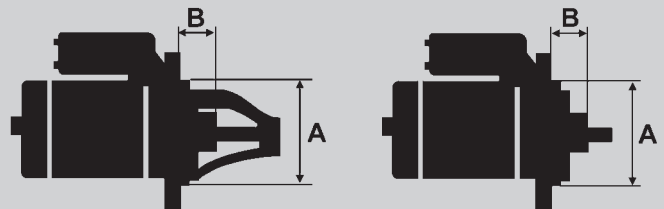

















ZESTAWIENIE TYPÓW

S















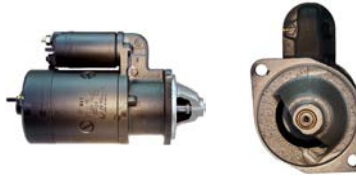









TYP ÖVERSIKT





<b>CS 18</b>	<b>CS 19</b>	<b>CS 62</b>
		
<b>DD / 2 (0)</b> 12 V    0.8 kW <b>A: 89.0    B: 45.0 mm.</b> Austin, Lotus, MG, Plymouth, Triumph, Vauxhall	<b>DD / 2 (0)</b> 12 V    0.8 kW <b>A: 89.0    B: 45.0 mm.</b> MG, Morris, Triumph, Vauxhall	<b>DD / 2 (0)</b> 12 V    0.7 kW <b>A: 76.0    B: 32.0 mm.</b> Porsche, Steyr, VW
 9,10	 9	 9
<b>CS 66</b>	<b>CS 69</b>	<b>CS 70</b>
		
<b>DD / 15 / 2 (0)</b> 12 V    0.65 kW <b>A: 68.0    B: 14.0 mm.</b> Opel, Vauxhall	<b>DD / 15 / 2 (0)</b> 12 V    0.8 kW <b>A: 76.0    B: 4.5 mm.</b> Ford	<b>DD / 15 / 2 (0)</b> 12 V    0.8 kW <b>A: 78.0    B: 15.0 mm.</b> Bedford, Opel, Vauxhall
 9	 9	 9
<b>CS 72</b>	<b>CS 76</b>	<b>CS 78</b>
		
<b>DD / 15 / 2 (0)</b> 12 V    1.1 kW <b>A: 76.0    B: 5.0 mm.</b> Ford, Mercury, Saab, Triumph	<b>DD / 2 (0)</b> 12 V    1.0 kW <b>A: 76.0    B: 28.0 mm.</b> BMW	<b>DD / 15 / 3 (0)</b> 12 V    0.75 kW <b>A: 89.0    B: 29.0 mm.</b> Ford, Mercury, Triumph
 9	 9	 10
<b>CS 79</b>	<b>CS 80</b>	<b>CS 81</b>
		
<b>DD / 15 / 3 (0)</b> 12 V    0.8 kW <b>A: 82.5    B: 14.0 mm.</b> Audi, VW	<b>DD/GR / 15 / 2 (0)</b> 12 V    1.0 kW <b>A: 78.0    B: 16.0 mm.</b> Opel, Vauxhall, Volvo	<b>DD / 15 / 2 (1)</b> 12 V    1.5 kW <b>A: 82.5    B: 21.0 mm.</b> Mercedes-Benz
 9	 9	 9

























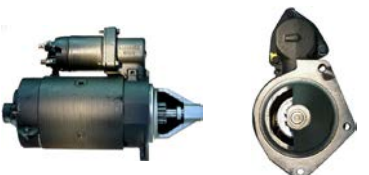

<p><b>CS 83</b></p>  <p>DD / 15 / 2 (1)      12 V      0.8 kW                      A: 82.5      B: 21.0 mm.                      Audi, Mercedes-Benz, Porsche, VW</p> 	<p><b>CS 86</b></p>  <p>DD / 15 / 3 (0)      12 V      1.0 kW                      A: 89.0      B: 29.0 mm.                      Ford, Mercury</p> 	<p><b>CS 89</b></p>  <p>DD / 15 / 2 (0)      12 V      1.1 kW                      A: 88.5      B: 7.5 mm.                      Saab</p> 
<p><b>CS 90</b></p>  <p>DD / 3 (3)      12 V      0.8 kW                      A: 62.0      B: 13.0 mm.                      Autobianchi, Fiat, Lancia, Seat</p> 	<p><b>CS 91</b></p>  <p>DD / 3 (3)      12 V      0.8 kW                      A: 66.5      B: 13.0 mm.                      Fiat, Lancia, Zastava</p> 	<p><b>CS 94</b></p>  <p>DD / 2 (0)      12 V      0.6 kW                      A: 66.0      B: 22.5 mm.                      Renault</p> 
<p><b>CS 95</b></p>  <p>DD / 3 (0)      12 V      0.6 kW                      A: 66.0      B: 9.0 mm.                      Dacia, DAF, Renault, Volvo</p> 	<p><b>CS 97</b></p>  <p>DD / 3 (0)      24 V      4.0 kW                      A: 89.0      B: 47.0 mm.                      Scania, Steyr</p> 	<p><b>CS 98</b></p>  <p>DD / 3 (0)      24 V      5.5 kW                      A: 92.0      B: 36.0 mm.                      Scania</p> 
<p><b>CS 99</b></p>  <p>DD / 3 (0)      24 V      6.0 kW                      A: 89.0      B: 46.0 mm.                      Volvo</p> 	<p><b>CS 103</b></p>  <p>DD / 3 (0)      12 V      2.7 kW                      A: 89.0      B: 27.0 mm.                      Atlas Copco, Deutz-Fahr, Iveco</p> 	<p><b>CS 106</b></p>  <p>DD / 3 (0)      12 V      2.8 kW                      A: 89.0      B: 47.0 mm.                      Case</p> 



























CS 107	CS 109	CS 113
DD / 3 (0) 12 V 2.1 kW A: 89.0 B: 29.0 mm. Massey Ferguson	DD / 3 (0) 12 V 2.0 kW A: 92.0 B: 25.0 mm. Massey Ferguson	DD / 2 (0) 12 V 2.0 kW A: 82.0 B: 20.0 mm. Mercedes-Benz
CS 114	CS 115	CS 116
DD / 3 (0) 12 V 2.4 kW A: 89.0 B: 27.0 mm. Atlas Copco, Bosch, Deutz-Fahr, Iveco, KHD	DD / 15 / 2 (0) 12 V 0.7 kW A: 76.0 B: 44.0 mm. VW	DD / 15 / 2 (0) 12 V 0.8 kW A: 76.0 B: 32.5 mm. Austin, MG, Rover, VW
CS 117	CS 119	CS 120
DD / 2 (0) 12 V 0.7 kW A: 76.0 B: 33.0 mm. Porsche, VW	DD / 15 / 2 (0) 12 V 1.5 kW A: 76.0 B: 28.5 mm. BMW, Ford	DD / 3 (0) 24 V 4.0 kW A: 89.0 B: 48.0 mm. Mercedes-Benz
CS 121	CS 123	CS 126
DD / 3 (0) 24 V 6.0 kW A: 92.0 B: 48.0 mm. Iveco, Scania	DD / 15 / 3 (3) 12 V 0.8 kW A: 76.0 B: 13.0 mm. Ford	DD / GR / 2 (0) 12 V 0.7 kW A: 66.0 B: 20.0 mm. Citroen





























<p><b>CS 128</b></p>  <p>DD / 3 (0)      12 V    2.0 kW                      A: 89.0      B: 22.0 mm.                      Bosch, Peugeot</p> 	<p><b>CS 129</b></p>  <p>DD / 2 (2)      12 V    0.9 kW                      A: 66.0      B: 21.0 mm.                      Citroen, Fiat, Peugeot</p> 	<p><b>CS 131</b></p>  <p>DD / 2 (0)      12 V    0.8 kW                      A: 76.0      B: 26.5 mm.                      Alfa Romeo, VW</p> 
<p><b>CS 132</b></p>  <p>DD / 15 / 2 (1)      12 V    1.1 kW                      A: 82.5      B: 21.0 mm.                      Audi, Porsche, VW</p> 	<p><b>CS 133</b></p>  <p>DD / 15 / 3 (3)      12 V    0.9 kW                      A: 64.0      B: 10.0 mm.                      Bertone, Fiat, Lancia</p> 	<p><b>CS 135</b></p>  <p>DD / 15 / 3 (2)      12 V    1.1 kW                      A: 82.0      B: 3.0 mm.                      Peugeot, Volvo</p> 
<p><b>CS 139</b></p>  <p>DD / 3 (3)      12 V    1.3 kW                      A: 82.5      B: 22.0 mm.                      Fiat, Lada</p> 	<p><b>CS 140</b></p>  <p>DD / 15 / 2 (0)      12 V    1.1 kW                      A: 82.5      B: 34.5 mm.                      Volvo, Volvo Penta</p> 	<p><b>CS 141</b></p>  <p>DD / 3 (3)      12 V    0.8 kW                      A: 82.5      B: 25.0 mm.                      Fiat, Seat</p> 
<p><b>CS 142</b></p>  <p>DD / 3 (3)      12 V    0.85 kW                      A: 66.0      B: 15.0 mm.                      Citroen, Peugeot, Renault, Talbot</p> 	<p><b>CS 147</b></p>  <p>DD / 3 (3)      12 V    0.8 kW                      A: 67.0      B: 12.0 mm.                      Autobianchi, Fiat, Lancia</p> 	<p><b>CS 155</b></p>  <p>DD / 3 (3)      12 V    2.4 kW                      A: 98.5      B: 36.0 mm.                      Citroen, Peugeot</p> 















CS 162	CS 168	CS 180
		
DD / 15 / 2 (0)      12 V      0.7 kW A: 68.0      B: 17.0 mm. Bedford, Opel, Pontiac, Vauxhall	DD / 3 (3)      12 V      0.8 kW A: 80.0      B: 22.5 mm. Peugeot	DD / 3 (0)      12 V      0.8 kW A: 62.0      B: 10.0 mm. Alfa Romeo
		
CS 183	CS 185	CS 186
		
DD / 15 / 2 (0)      12 V      1.1 kW A: 76.0      B: 20.0 mm. BMW	DD / 3 (1)      12 V      1.5 kW A: 82.5      B: 13.0 mm. Audi, VW	DD / 3 (0)      12 V      3.0 kW A: 89.0      B: 48.0 mm. Claas, Mercedes-Benz
		
CS 188	CS 191	CS 194
		
DD / 2 (2)      12 V      2.0 kW A: 82.5      B: 21.0 mm. Audi, Mercedes-Benz, Volvo	DD / 3 (0)      24 V      5.4 kW A: 92.0      B: 47.0 mm. Claas, Kässbohrer, MAN, Mercedes-Benz, Neoplan, Padane, Setra	DD / 3 (0)      24 V      4.5 kW A: 89.0      B: 48.5 mm. Mercedes-Benz
		
CS 198	CS 200	CS 201
		
DD / 3 (0)      24 V      6.0 kW A: 92.0      B: 47.0 mm. Kässbohrer, MAN, Mercedes-Benz, Neoplan, Ssangyong	DD / 3 (0)      12 V      2.8 kW A: 92.0      B: 21.0 mm. Ford, New Holland	DD / 3 (0)      12 V      2.8 kW A: 89.0      B: 29.0 mm. Massey Ferguson
		



























<p><b>CS 230</b></p>  <p>DD / 3 (0)      12 V    2.5 kW                      A: 110.0    B: 27.0 mm.                      Alfa Romeo, Iveco</p> 	<p><b>CS 231</b></p>  <p>DD / 3 (0)      24 V    3.2 kW                      A: 110.0    B: 28.0 mm.                      Iveco</p> 	<p><b>CS 232</b></p>  <p>DD / 3 (0)      24 V    4.0 kW                      A: 110.0    B: 26.0 mm.                      Fiat-Allis, Iveco, Ursus</p> 
<p><b>CS 240</b></p>  <p>DD / 3 (0)      12 V    3.0 kW                      A: 110.0    B: 26.0 mm.                      Fiat, Iveco</p> 	<p><b>CS 263</b></p>  <p>DD / 2 (1)      12 V    0.8 kW                      A: 82.5      B: 17.5 mm.                      Bedford, Opel, Vauxhall</p> 	<p><b>CS 268</b></p>  <p>DD / 15 / 2 (2)    12 V    1.5 kW                      A: 82.5      B: 25.0 mm.                      Mercedes-Benz, Puch (Steyr-Daimler)</p> 
<p><b>CS 269</b></p>  <p>DD / 3 (0)      24 V    4.0 kW                      A: 89.0      B: 27.0 mm.                      MAN</p> 	<p><b>CS 272</b></p>  <p>DD/GR / 2 (0)    12 V    1.7 kW                      A: 76.0      B: 31.0 mm.                      VW</p> 	<p><b>CS 275</b></p>  <p>DD/GR / 3 (3)    12 V    1.0 kW                      A: 82.5      B: 23.5 mm.                      Fiat, Lancia, Seat</p> 
<p><b>CS 276</b></p>  <p>DD / 15 / 3 (0)    12 V    0.7 kW                      A: 82.0      B: 14.0 mm.                      VW</p> 	<p><b>CS 278</b></p>  <p>DD / 15 / 3 (3)    12 V    0.85 kW                      A: 76.0      B: 12.5 mm.                      Ford</p> 	<p><b>CS 280</b></p>  <p>DD / 15 / 3 (3)    12 V    1.1 kW                      A: 66.0      B: 3.0 mm.                      DeLorean, Renault</p> 



<b>CS 282</b>	<b>CS 285</b>	<b>CS 286</b>
		
<p>GR / 15 / 2 (1)      12 V      1.1 kW  A: 82.0      B: 21.5 mm.  Audi, VW</p> 	<p>DD / 15 / 3 (3)      12 V      0.8 kW  A: 64.5      B: 11.0 mm.  Fiat, Innocenti, Lancia, Saab</p> 	<p>DD/GR / 3 (3)      12 V      1.6 kW  A: 82.5      B: 22.0 mm.  Fiat, Lancia, Seat</p> 
<b>CS 289</b>	<b>CS 290</b>	<b>CS 292</b>
		
<p>DD / 3 (0)      12 V      2.0 kW  A: 110.0      B: 27.0 mm.  Alfa Romeo, Fiat</p> 	<p>DD / 2 (1)      12 V      1.7 kW  A: 82.5      B: 17.5 mm.  Bedford, Opel, Vauxhall</p> 	<p>DD / 15 / 2 (2)      12 V      1.1 kW  A: 82.5      B: 35.0 mm.  Volvo</p> 
<b>CS 293</b>	<b>CS 294</b>	<b>CS 295</b>
		
<p>DD / 15 / 3 (2)      12 V      0.8 kW  A: 82.5      B: 14.0 mm.  Audi, Seat, VW</p> 	<p>DD/GR / 15 / 2 (0)      12 V      0.9 kW  A: 76.0      B: 33.0 mm.  Austin, Seat, VW</p> 	<p>GR / 2 (0)      12 V      1.7 kW  A: 76.0      B: 33.5 mm.  VW</p> 
<b>CS 297</b>	<b>CS 298</b>	<b>CS 299</b>
		
<p>DD / 15 / 3 (3)      12 V      0.95 kW  A: 82.5      B: 15.0 mm.  Audi, VW</p> 	<p>DD / 2 (0)      12 V      0.8 kW  A: 76.0      B: 44.0 mm.  VW</p> 	<p>DD / 2 (0)      12 V      1.7 kW  A: 82.5      B: 42.0 mm.  VW</p> 























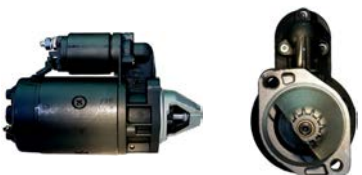

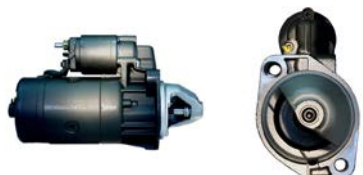

CS 300	CS 306	CS 308
		
DD/GR / 15 / 2 (2)    12 V    1.5 kW A: 82.5    B: 21.0 mm. VW	DD / 3 (0)    12 V    1.05 kW A: 66.0    B: 7.0 mm. Citroen, Peugeot, Rover, Talbot	DD / 3 (0)    12 V    0.5 kW A: 62.0    B: 11.0 mm. Fiat
		
CS 310	CS 311	CS 314
		
DD / 4 (4)    12 V    0.9 kW A: 66.0    B: -2.0 mm. Renault, Volvo	DD / 15 / 2 (2)    12 V    1.5 kW A: 82.5    B: 21.0 mm. Mercedes-Benz	DD / 3 (0)    12 V    2.0 kW A: 89.0    B: 20.0 mm. Peugeot, Talbot
		
CS 315	CS 316	CS 317
		
DD / 3 (2)    12 V    0.9 kW A: 66.0    B: 10.0 mm. Renault	DD / 3 (3)    12 V    1.05 kW A: 82.0    B: 20.0 mm. Renault	DD / 3 (3)    12 V    1.05 kW A: 66.0    B: -6.0 mm. Citroen, Peugeot, Renault
		
CS 321	CS 322	CS 324
		
DD / 3 (3)    12 V    0.9 kW A: 66.0    B: 10.0 mm. Renault, Volvo	GR / 2 (1)    12 V    1.7 kW A: 82.0    B: 20.0 mm. Bedford, Opel, Vauxhall	DD / 15 / 3 (0)    12 V    1.1 kW A: 89.0    B: 28.0 mm. Ford
		

















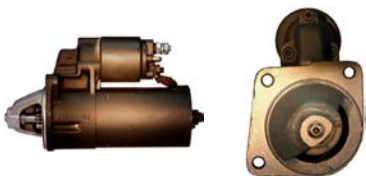









CS 326	CS 327	CS 328
DD/GR / 3 (3) 12 V 0.85 kW A: 66.0 B: -5.0 mm. Citroen, Peugeot	GR / 2 (2) 12 V 1.4 kW A: 82.5 B: 26.0 mm. Daewoo, Mercedes-Benz, Ssangyong	GR / 2 (0) 12 V 1.4 kW A: 76.0 B: 6.0 mm. Ford, Merkur
CS 329	CS 330	CS 331
GR / 3 (0) 12 V 1.4 kW A: 89.0 B: 30.0 mm. Ford, Land Rover	GR / 3 (0) 12 V 1.4 kW A: 76.0 B: 14.5 mm. Ford	GR / 2 (2) 12 V 2.2 kW A: 82.5 B: 27.0 mm. Daewoo, Mercedes-Benz, Ssangyong
CS 332	CS 333	CS 335
DD / 3 (0) 12 V 1.3 kW A: 82.5 B: 32.0 mm. Lada	GR / 3 (0) 12 V 3.5 kW A: 110.0 B: 26.5 mm. Renault	DD / 2 (0) 12 V 3.0 kW A: 82.5 B: 20.5 mm. Lamborghini, Same
CS 336	CS 337	CS 338
DD / 3 (0) 12 V 2.8 kW A: 92.0 B: 21.0 mm. Ford	DD / 3 (0) 12 V 2.5 kW A: 92.0 B: 21.0 mm. Ford	DD/GR / 3 (1) 12 V 2.5 kW A: 80.0 B: -6.5 mm. Fiat, Renault



























<p><b>CS 339</b></p>  <p>DD / 3 (0)      12 V    3.0 kW A: 92.0    B: 20.0 mm. Ford</p> 	<p><b>CS 341</b></p>  <p>GR / 3 (3)      12 V    1.7 kW A: 76.0    B: 15.0 mm. Ford, Mazda</p> 	<p><b>CS 342#</b></p>  <p>DD/GR / 3 (3)      12 V    1.5 kW A: 66.0    B: -5.0 mm. Citroen, Lancia, Peugeot, Talbot</p> 
<p><b>CS 344</b></p>  <p>DD / 3 (3)      12 V    0.8 kW A: 62.0    B: 12.0 mm. Seat</p> 	<p><b>CS 345</b></p>  <p>DD / 3 (0)      12 V    3.0 kW A: 92.0    B: 20.0 mm. Ford</p> 	<p><b>CS 346</b></p>  <p>GR / 15 / 2 (0)      12 V    1.4 kW A: 89.0    B: 19.0 mm. Saab</p> 
<p><b>CS 347</b></p>  <p>DD / 2 (2)      12 V    2.0 kW A: 82.0    B: 21.0 mm. Audi, Volvo, VW</p> 	<p><b>CS 348</b></p>  <p>DD / 3 (0)      12 V    1.7 kW A: 82.5    B: 13.5 mm. VW</p> 	<p><b>CS 350</b></p>  <p>GR / 2 (2)      12 V    2.2 kW A: 82.5    B: 20.5 mm. Audi, Fiat, VW</p> 
<p><b>CS 351</b></p>  <p>GR / 3 (0)      12 V    2.2 kW A: 81.5    B: 23.0 mm. Fiat, Lancia</p> 	<p><b>CS 352</b></p>  <p>DD / 2 (2)      12 V    0.85 kW A: 66.0    B: 21.0 mm. Citroen, Fiat, Peugeot, Talbot</p> 	<p><b>CS 353</b></p>  <p>GR / 3 (3)      12 V    3.1 kW A: 75.0    B: -7.0 mm. Jeep, Renault</p> 



<b>CS 354</b>	<b>CS 355</b>	<b>CS 356</b>
		
<b>DD / 3 (3)</b> 12 V    1.7 kW <b>A: 65.0      B: -3.0 mm.</b> Renault, Volvo	<b>DD / 3 (3)</b> 12 V    0.85 kW <b>A: 66.0      B: 15.0 mm.</b> Citroen, Peugeot, Talbot	<b>GR / 2 (0)</b> 12 V    2.2 kW <b>A: 82.5      B: 15.5 mm.</b> Bedford, Lombardini, Opel, Vauxhall
		
<b>CS 357</b>	<b>CS 358</b>	<b>CS 360</b>
		
<b>GR / 15 / 3 (3)</b> 12 V    1.4 kW <b>A: 76.0      B: 14.0 mm.</b> Ford	<b>GR / 2 (0)</b> 12 V    1.7 kW <b>A: 82.5      B: 42.0 mm.</b> VW	<b>GR / 2 (2)</b> 12 V    1.7 kW <b>A: 82.5      B: 27.0 mm.</b> Daewoo, Maybach, Mercedes-Benz, Ssangyong
		
<b>CS 361</b>	<b>CS 362</b>	<b>CS 364</b>
		
<b>GR / 3 (3)</b> 12 V    2.2 kW <b>A: 98.5      B: 36.0 mm.</b> Citroen, Peugeot, Talbot	<b>DD / 2 (2)</b> 12 V    1.0 kW <b>A: 66.0      B: 20.5 mm.</b> Peugeot	<b>DD / 3 (3)</b> 12 V    1.1 kW <b>A: 67.0      B: 13.5 mm.</b> Fiat, Lancia
		
<b>CS 366</b>	<b>CS 368</b>	<b>CS 370</b>
		
<b>DD / 4 (1)</b> 12 V    2.5 kW <b>A: 89.0      B: 24.0 mm.</b> Peugeot	<b>DD / 3 (2)</b> 12 V    0.9 kW <b>A: 67.0      B: 13.0 mm.</b> Fiat	<b>GR / 3 (0)</b> 12 V    2.2 kW <b>A: 110.0     B: 27.0 mm.</b> Opel, Renault, Renault V.I., Vauxhall
		





























<p><b>CS 371</b></p>  <p><b>DD / 3 (2)</b>      12 V    0.9 kW  <b>A: 64.0    B: 11.0 mm.</b>                      Autobianchi, Fiat, Lancia</p>  <p>9,10</p>	<p><b>CS 372</b></p>  <p><b>GR / 2 (1)</b>      12 V    1.4 kW  <b>A: 82.5    B: 20.0 mm.</b>                      Opel, Saab, Vauxhall</p>  <p>9</p>	<p><b>CS 373</b></p>  <p><b>GR / 3 (3)</b>      12 V    1.7 kW  <b>A: 70.0    B: -6.0 mm.</b>                      Citroen, Fiat, Lancia, Peugeot, Suzuki, Talbot  <i>W/ or w/o bendixhousing</i></p>  <p>10,11</p>
<p><b>CS 374</b></p>  <p><b>GR / 3 (3)</b>      12 V    1.7 kW  <b>A: 82.5    B: 23.0 mm.</b>                      Fiat</p>  <p>10</p>	<p><b>CS 375</b></p>  <p><b>GR / 3 (0)</b>      12 V    1.4 kW  <b>A: 62.0    B: 10.5 mm.</b>                      Alfa Romeo</p>  <p>9</p>	<p><b>CS 376</b></p>  <p><b>GR / 3 (3)</b>      12 V    2.2 kW  <b>A: 82.5    B: 22.5 mm.</b>                      Fiat</p>  <p>9,10</p>
<p><b>CS 377</b></p>  <p><b>GR / 30h / 2 (0)</b>    12 V    1.4 kW  <b>A: 76.0    B: 21.5 mm.</b>                      BMW</p>  <p>9,10</p>	<p><b>CS 378</b></p>  <p><b>GR / 30h / 2 (0)</b>    12 V    2.2 kW  <b>A: 75.5    B: 21.0 mm.</b>                      BMW, Land Rover, Opel, Vauxhall</p>  <p>9</p>	<p><b>CS 382</b></p>  <p><b>DD / 3 (3)</b>      12 V    2.8 kW  <b>A: 98.5    B: 36.0 mm.</b>                      Citroen, Peugeot</p>  <p>9</p>
<p><b>CS 384</b></p>  <p><b>DD / 3 (0)</b>      24 V    5.5 kW  <b>A: 89.0    B: 48.0 mm.</b>                      Iveco</p>  <p>11</p>	<p><b>CS 386</b></p>  <p><b>GR / 2 (2)</b>      12 V    2.2 kW  <b>A: 82.5    B: 21.0 mm.</b>                      Volvo, VW  <i>W/ or w/o bendixhousing</i></p>  <p>9</p>	<p><b>CS 387</b></p>  <p><b>DD / 3 (0)</b>      24 V    5.0 kW  <b>A: 89.0    B: 40.0 mm.</b>                      DAF</p>  <p>11</p>



























<b>CS 388</b>	<b>CS 389</b>	<b>CS 390</b>
<b>DD/GR / 3 (0)</b> 24 V      4.0 kW <b>A: 89.0      B: 48.0 mm.</b> DAF	<b>GR / 15 / 2 (2)</b> 12 V      1.4 kW <b>A: 82.5      B: 36.0 mm.</b> Volvo	<b>DD/GR / 3 (1)</b> 12 V      0.9 kW <b>A: 62.0      B: -5.0 mm.</b> Citroen, Fiat, Peugeot
<b>CS 391</b>	<b>CS 392</b>	<b>CS 393</b>
<b>DD/GR / 3 (0)</b> 24 V      4.0 kW <b>A: 89.0      B: 47.0 mm.</b> Volvo	<b>DD / 15 / 3 (0)</b> 12 V      0.9 kW <b>A: 82.5      B: 14.0 mm.</b> VW	<b>DD / 3 (0)</b> 12 V      0.9 kW <b>A: 66.0      B: 23.0 mm.</b> Fiat, Lancia
<b>CS 394</b>	<b>CS 395</b>	<b>CS 396</b>
<b>DD / 3 (0)</b> 24 V      4.0 kW <b>A: 110.0      B: 26.0 mm.</b> Iveco, Ursus	<b>DD / 2 (0)</b> 12 V      3.0 kW <b>A: 82.5      B: 34.0 mm.</b> John Deere	<b>DD / 3 (2)</b> 12 V      0.8 kW <b>A: 67.0      B: 13.0 mm.</b> Fiat, Innocenti
<b>CS 398</b>	<b>CS 501</b>	<b>CS 502</b>
<b>DD / 3 (0)</b> 12 V      3.7 kW <b>A: 89.0      B: 25.5 mm.</b> Atlas Copco, Deutz-Fahr, Iveco	<b>DD / 3 (0)</b> 24 V      4.8 kW <b>A: 89.0      B: 27.5 mm.</b> Iveco, KHD	<b>DD / 3 (0)</b> 24 V      5.4 kW <b>A: 92.0      B: 46.0 mm.</b> Iveco



























<p><b>CS 503</b></p>  <p>DD / 3 (0)      12 V    2.7 kW                      A: 89.0      B: 48.0 mm.                      Case</p> 	<p><b>CS 506</b></p>  <p>DD / 3 (0)      24 V    5.4 kW                      A: 89.0      B: 47.0 mm.                      Steyr, Volvo</p> 	<p><b>CS 508</b></p>  <p>DD / 15 / 2 (0)      12 V    1.5 kW                      A: 76.0      B: 34.0 mm.                      Porsche</p> 
<p><b>CS 509</b></p>  <p>DD / 15 / 2 (2)      12 V    1.0 kW                      A: 82.5      B: 13.0 mm.                      Audi</p> 	<p><b>CS 510</b></p>  <p>GR / 3 (0)      12 V    2.2 kW                      A: 110.0      B: 27.0 mm.                      Alfa Romeo, Fiat</p> 	<p><b>CS 511</b></p>  <p>DD / 3 (0)      12 V    2.7 kW                      A: 89.0      B: 22.0 mm.                      Case</p> 
<p><b>CS 514</b></p>  <p>GR / 15 / 3 (0)      12 V    1.4 kW                      A: 68.0      B: 23.5 mm.                      Alfa Romeo, Fiat, Lancia</p> 	<p><b>CS 515</b></p>  <p>GR / 30h / 2 (0)      12 V    1.7 kW                      A: 76.0      B: 28.0 mm.                      BMW, Lombardini</p> 	<p><b>CS 516</b></p>  <p>GR / 30h / 3 (0)      12 V    1.4 kW                      A: 76.0      B: 21.0 mm.                      BMW</p> 
<p><b>CS 518</b></p>  <p>DD / 2 (1)      12 V    1.0 kW                      A: 82.5      B: 18.0 mm.                      Opel, Vauxhall</p> 	<p><b>CS 519</b></p>  <p>DD/GR / 2 (0)      12 V    1.0 kW                      A: 68.0      B: 19.0 mm.                      Bedford, Chevrolet, Daewoo, Fiat, Opel, Vauxhall</p> 	<p><b>CS 523</b></p>  <p>DD / 3 (3)      12 V    2.2 kW                      A: 66.0      B: -6.0 mm.                      Citroen, Eagle, Renault</p> 



























<b>CS 524</b>	<b>CS 526</b>	<b>CS 529</b>
		
<b>GR / 3 (0)</b> 12 V    2.2 kW <b>A: 89.0      B: 21.0 mm.</b> DAF, LDV, Peugeot, Talbot	<b>DD / 3 (0)</b> 24 V    6.5 kW <b>A: 115.0      B: 21.0 mm.</b> Iveco	<b>DD / 3 (3)</b> 12 V    1.1 kW <b>A: 82.5      B: 16.0 mm.</b> Fiat
		
<b>CS 530</b>	<b>CS 531</b>	<b>CS 535</b>
		
<b>DD / 3 (0)</b> 24 V    4.0 kW <b>A: 89.0      B: 28.0 mm.</b> Iveco	<b>DD / 2 (0)</b> 12 V    0.8 kW <b>A: 76.0      B: 31.5 mm.</b> VW	<b>DD/GR / 2 (0)</b> 12 V    0.9 kW <b>A: 68.0      B: 18.0 mm.</b> Bedford, Opel, Pontiac, Vauxhall
		
<b>CS 536</b>	<b>CS 541</b>	<b>CS 542</b>
		
<b>DD / 3 (3)</b> 12 V    1.0 kW <b>A: 64.0      B: 11.0 mm.</b> Fiat, Lancia	<b>GR / 3 (3)</b> 12 V    1.8 kW <b>A: 76.0      B: 14.5 mm.</b> Ford	<b>GR / 3 (1)</b> 12 V    1.4 kW <b>A: 62.0      B: -6.0 mm.</b> Citroen, Nissan, Peugeot, Rover
		
<b>CS 543</b>	<b>CS 544</b>	<b>CS 548</b>
		
<b>GR / 3 (0)</b> 12 V    3.1 kW <b>A: 92.0      B: 22.0 mm.</b> Land Rover	<b>DD / 3 (0)</b> 24 V    5.5 kW <b>A: 89.0      B: 48.0 mm.</b> Volvo, Volvo BM	<b>GR / 2 (2)</b> 12 V    1.7 kW <b>A: 82.5      B: 15.5 mm.</b> Audi
		



























<p><b>CS 550</b></p>  <p>DD / 3 (0)      12 V    2.4 kW                      A: 89.0      B: 21.0 mm.                      Fendt</p> 	<p><b>CS 551</b></p>  <p>GR / 3 (2)      12 V    1.4 kW                      A: 62.0      B: 3.0 mm.                      Citroen, Peugeot</p> 	<p><b>CS 554</b></p>  <p>GR / 3 (3)      12 V    2.2 kW                      A: 81.5      B: 29.5 mm.                      Alfa Romeo, Citroen, Fiat</p> 
<p><b>CS 555</b></p>  <p>GR / 2 (2)      12 V    2.2 kW                      A: 82.5      B: 21.0 mm.                      Mercedes-Benz, Seat</p> 	<p><b>CS 559</b></p>  <p>DD / 15 / 2 (0)      12 V    1.0 kW                      A: 76.0      B: 52.5 mm.                      VW</p> 	<p><b>CS 561</b></p>  <p>DD / 2 (0)      12 V    0.8 kW                      A: 76.0      B: 28.0 mm.                      Skoda</p> 
<p><b>CS 562</b></p>  <p>DD/GR / 3 (0)      12 V    1.0 kW                      A: 76.0      B: 14.5 mm.                      Ford</p> 	<p><b>CS 564</b></p>  <p>DD / 3 (0)      24 V    6.5 kW                      A: 115.0      B: 20.0 mm.                      Iveco  <i>Oilproof and waterproof.</i></p> 	<p><b>CS 566</b></p>  <p>GR / 3 (3)      12 V    1.1 kW                      B: -5.0 mm.                      Citroen, Fiat, Lancia, Peugeot</p> 
<p><b>CS 569</b></p>  <p>DD/GR / 2 (2)      12 V    0.9 kW                      A: 82.5      B: 14.0 mm.                      Audi</p> 	<p><b>CS 570</b></p>  <p>GR / 3 (3)      12 V    3.1 kW                      A: 70.0      B: -6.5 mm.                      Citroen, Fiat, Lancia, Peugeot</p> 	<p><b>CS 572</b></p>  <p>DD/GR / 3 (0)      12 V    2.5 kW                      A: 110.0      B: 27.5 mm.                      Fiat, Iveco</p> 



<b>CS 573</b>	<b>CS 574</b>	<b>CS 575</b>
		
<b>GR / 3 (3)</b> 12 V    1.3 kW <b>A: 98.5</b> <b>B: 36.5 mm.</b> Citroen	<b>GR / 2 (0)</b> 12 V    1.7 kW <b>A: 76.0</b> <b>B: 54.0 mm.</b> VW	<b>GR / 3 (3)</b> 12 V    1.7 kW <b>A: 65.0</b> <b>B: -4.0 mm.</b> Renault
 10	 10	 11
<b>CS 576</b>	<b>CS 577</b>	<b>CS 578</b>
		
<b>GR / 2 (2)</b> 12 V    2.2 kW <b>A: 82.5</b> <b>B: 26.0 mm.</b> Mercedes-Benz	<b>GR / 30h / 2 (0)</b> 12 V    1.4 kW <b>A: 76.0</b> <b>B: 27.5 mm.</b> BMW	<b>GR / 15 / 2 (1)</b> 12 V    1.4 kW <b>A: 82.5</b> <b>B: 21.0 mm.</b> Porsche
 10	 9	 9
<b>CS 579</b>	<b>CS 581</b>	<b>CS 583</b>
		
<b>GR / 15 / 2 (0)</b> 12 V    0.9 kW <b>A: 75.0</b> <b>B: 40.0 mm.</b> Austin, MG, Rover	<b>DD/GR / 3 (1)</b> 12 V    1.0 kW <b>B: -6.0 mm.</b> Citroen, Fiat, Peugeot	<b>GR / 2 (2)</b> 12 V    1.7 kW <b>A: 78.0</b> <b>B: 12.5 mm.</b> Mercedes-Benz
 10	 9,10	 10
<b>CS 584</b>	<b>CS 585</b>	<b>CS 587#</b>
		
<b>GR / 3 (0)</b> 12 V    1.4 kW <b>A: 66.0</b> <b>B: 23.0 mm.</b> Alfa Romeo, Fiat, Lancia	<b>GR / 3 (0)</b> 12 V    1.4 kW <b>A: 76.0</b> <b>B: 11.0 mm.</b> Alfa Romeo, Fiat, Lancia	<b>DD / 15 / 2 (0)</b> 12 V    1.4 kW <b>A: 73.0</b> <b>B: 40.0 mm.</b> Land Rover
 11	 9	 9



























<p><b>CS 588#</b></p>  <p>DD/GR / 15 / 2 (1)      12 V      1.4 kW                      A: 89.0      B: 27.0 mm.                      Daimler, Jaguar</p> 	<p><b>CS 589</b></p>  <p>GR / 15 / 2 (0)      12 V      1.4 kW                      A: 73.0      B: 40.0 mm.                      Land Rover</p> 	<p><b>CS 590#</b></p>  <p>DD/GR / 3 (0)      12 V      2.1 kW                      A: 92.0      B: 18.5 mm.                      Land Rover</p> 
<p><b>CS 591#</b></p>  <p>DD / 2 (2)      12 V      1.4 kW                      A: 89.0      B: 26.0 mm.                      Citroen, Jaguar</p> 	<p><b>CS 592</b></p>  <p>DD / 3 (3)      12 V      0.9 kW                      A: 76.0      B: 14.5 mm.                      Ford</p> 	<p><b>CS 594</b></p>  <p>GR / 3 (3)      12 V      1.4 kW                      B: -6.0 mm.                      Citroen, Fiat, Hyundai, Lancia, Mitsubishi, Peugeot</p> 
<p><b>CS 595</b></p>  <p>DD / 3 (0)      24 V      4.0 kW                      A: 89.0      B: 28.0 mm.                      MAN</p> 	<p><b>CS 597</b></p>  <p>GR / 3 (0)      12 V      1.1 kW                      A: 76.0      B: 53.0 mm.                      VW</p> 	<p><b>CS 598</b></p>  <p>GR / 3 (0)      12 V      1.8 kW                      A: 76.0      B: 52.0 mm.                      VW</p> 
<p><b>CS 599</b></p>  <p>GR / 3 (0)      12 V      2.2 kW                      A: 76.0      B: 52.5 mm.                      VW</p> 	<p><b>CS 600</b></p>  <p>GR / 3 (2)      12 V      1.7 kW                      A: 76.0      B: 0.0 mm.                      Volvo</p> 	<p><b>CS 601</b></p>  <p>GR / 15 / 2 (0)      12 V      1.1 kW                      A: 76.0      B: 53.0 mm.                      VW</p> 







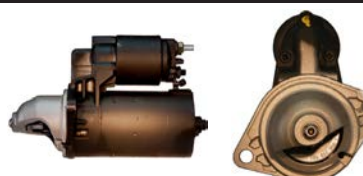



















CS 603	CS 604	CS 605
DD / 2 (0)      12 V      2.0 kW A: 92.0      B: 42.5 mm. Volvo BM	DD / 3 (0)      12 V      2.8 kW A: 89.0      B: 47.0 mm. Valtra	DD / 3 (0)      12 V      3.0 kW A: 89.0      B: 48.0 mm. Mercedes-Benz, Steyr
CS 606	CS 608	CS 610
GR / 3 (1)      12 V      1.7 kW A: 82.5      B: 16.0 mm. Audi, VW	DD/GR / 3 (0)      24 V      4.0 kW A: 88.5      B: 22.0 mm. Renault V.I.	DD/GR / 3 (0)      12 V      0.8 kW A: 67.0      B: 41.0 mm. MG, Rover
CS 611	CS 612	CS 613
GR / 3 (0)      12 V      2.2 kW A: 82.5      B: 21.0 mm. Alfa Romeo, Chrysler, Dodge, Jeep, Rover	GR / 15 / 2 (2)      12 V      1.1 kW A: 82.5      B: 16.0 mm. Audi, Skoda, VW	GR / 3 (3)      12 V      2.2 kW A: 76.0      B: 15.0 mm. Ford, Mazda
CS 616	CS 617	CS 618
GR / 2 (0)      12 V      1.8 kW A: 76.0      B: 52.0 mm. Seat, VW	DD / 3 (0)      24 V      5.4 kW A: 110.0      B: 47.0 mm. DAF	DD/GR / 2 (0)      12 V      1.1 kW A: 76.0      B: 33.0 mm. Audi, Ford, Seat, Skoda, VW



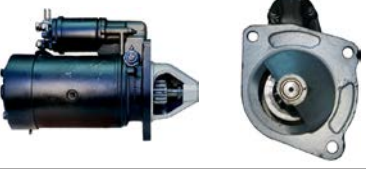

























<p><b>CS 619</b></p>  <p>GR / 2 (0)      12 V    1.1 kW                      A: 76.0      B: 53.0 mm.                      Audi, Ford, Seat, Skoda, VW</p> 	<p><b>CS 620</b></p>  <p>GR / 2 (0)      12 V    1.7 kW                      A: 76.0      B: 52.5 mm.                      Ford, VW</p> 	<p><b>CS 623#</b></p>  <p>DD / 3 (0)      12 V    2.8 kW                      A: 89.0      B: 49.5 mm.                      Massey Ferguson</p> 
<p><b>CS 624</b></p>  <p>GR / 2 (2)      12 V    1.8 kW                      A: 82.5      B: 15.0 mm.                      Audi, Multicar, Skoda, VW</p> 	<p><b>CS 625#</b></p>  <p>GR / 2 (0)      12 V    1.1 kW                      A: 76.5      B: 4.0 mm.                      Ford</p> 	<p><b>CS 680</b></p>  <p>GR / 3 (2)      12 V    1.4 kW                      A: 76.0      B: -1.0 mm.                      Renault, Volvo</p> 
<p><b>CS 681</b></p>  <p>GR / 4 (4)      12 V    1.1 kW                      A: 65.5      B: -2.0 mm.                      Renault, Volvo</p> 	<p><b>CS 682</b></p>  <p>DD/GR / 3 (0)      12 V    3.0 kW                      A: 110.0      B: 27.5 mm.                      Fiat, Iveco, Ursus</p> 	<p><b>CS 683</b></p>  <p>DD / 2 (0)      12 V    0.95 kW                      A: 76.0      B: 44.5 mm.                      VW</p> 
<p><b>CS 684</b></p>  <p>GR / 3 (3)      12 V    1.7 kW                      A: 66.0      B: -1.0 mm.                      Mitsubishi, Porsche, Renault, Volvo</p> 	<p><b>CS 685</b></p>  <p>GR / 3 (3)      12 V    1.4 kW                      A: 76.0      B: 15.0 mm.                      Ford</p> 	<p><b>CS 687</b></p>  <p>DD / 2 (0)      12 V    1.1 kW                      A: 76.0      B: 28.0 mm.                      Alfa Romeo</p> 



<b>CS 688</b>	<b>CS 689</b>	<b>CS 691</b>
		
<b>DD/GR / 3 (0)</b> 24 V    6.6 kW <b>A: 89.0      B: 40.0 mm.</b> Renault V.I.	<b>DD / 3 (1)</b> 12 V    2.5 kW <b>A: 110.0      B: 27.0 mm.</b> Fiat, Iveco, Multicar	<b>DD / 15 / 2 (0)</b> 12 V    0.8 kW <b>A: 89.0      B: 28.0 mm.</b> Austin, Rover
		
<b>CS 692</b>	<b>CS 693</b>	<b>CS 695</b>
		
<b>DD / 3 (0)</b> 12 V    0.6 kW <b>A: 62.0      B: 9.0 mm.</b> Fiat, FSO, Polski-Fiat	<b>DD / 3 (0)</b> 12 V    2.4 kW <b>A: 89.0      B: 28.0 mm.</b> Massey Ferguson	<b>DD / 3 (0)</b> 12 V    2.6 kW <b>A: 89.0      B: 48.0 mm.</b> Perkins
		
<b>CS 699</b>	<b>CS 700</b>	<b>CS 703</b>
		
<b>DD / 3 (0)</b> 24 V    5.4 kW <b>A: 92.0      B: 47.0 mm.</b> Volvo	<b>DD / 3 (0)</b> 24 V    5.2 kW <b>A: 89.0      B: 48.0 mm.</b> Perkins	<b>DD / 3 (0)</b> 12 V    2.8 kW <b>A: 89.0      B: 28.5 mm.</b> Massey Ferguson
		
<b>CS 705</b>	<b>CS 706</b>	<b>CS 707</b>
		
<b>DD / 3 (0)</b> 12 V    2.0 kW <b>A: 92.0      B: 25.0 mm.</b> Case	<b>DD / 2 (0)</b> 12 V    2.7 kW <b>A: 82.5      B: 35.0 mm.</b> John Deere	<b>DD / 2 (0)</b> 12 V    1.9 kW <b>A: 82.5      B: 21.0 mm.</b> Atlas Copco, Deutz-Fahr
		

























<p><b>CS 708</b></p>  <p>DD / 3 (0)      12 V    0.85 kW                      A: 89.0      B: 28.5 mm.                      Ford</p> 	<p><b>CS 709</b></p>  <p>GR / 3 (3)      12 V    2.2 kW                      A: 81.5      B: 23.0 mm.                      Alfa Romeo, Fiat, Ford, Lancia</p> 	<p><b>CS 711</b></p>  <p>DD / 3 (0)      12 V    1.0 kW                      A: 62.0      B: 22.0 mm.                      Fiat</p> 
<p><b>CS 712</b></p>  <p>GR / 3 (3)      12 V    2.2 kW                      A: 70.0      B: -5.0 mm.                      Citroen, Fiat, Lada, Lancia, Peugeot</p> 	<p><b>CS 713</b></p>  <p>GR / 2 (0)      12 V    1.8 kW                      A: 76.0      B: 33.0 mm.                      Ford, Seat, Skoda, VW</p> 	<p><b>CS 715</b></p>  <p>GR / 3 (3)      12 V    1.4 kW                      A: 62.0      B: -5.0 mm.                      Citroen, Fiat, Peugeot</p> 
<p><b>CS 718</b></p>  <p>DD/GR / 2 (0)      12 V    3.0 kW                      A: 82.5      B: 23.0 mm.                      Lamborghini, Same, Steyr</p> 	<p><b>CS 719</b></p>  <p>GR / 3 (2)      12 V    1.4 kW                      A: 76.0      B: 14.0 mm.                      Ford</p> 	<p><b>CS 723</b></p>  <p>DD/GR / 3 (2)      12 V    0.9 kW                      A: 82.5      B: 15.0 mm.                      VW</p> 
<p><b>CS 724</b></p>  <p>DD/GR / 3 (3)      12 V    1.1 kW                      A: 76.0      B: 14.0 mm.                      Ford</p> 	<p><b>CS 725</b></p>  <p>GR / 2 (1)      12 V    1.4 kW                      A: 76.0      B: 28.0 mm.                      Audi, VW</p> 	<p><b>CS 726</b></p>  <p>DD / 3 (0)      24 V    4.0 kW                      A: 89.0      B: 48.0 mm.                      Volvo BM                      Oil sealed</p> 



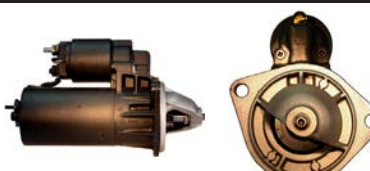







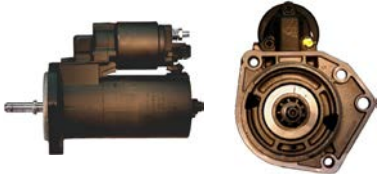















CS 727	CS 782	CS 783
GR / 2 (1)      12 V    1.1 kW A: 82.0      B: 20.0 mm. Daewoo, Opel, Saab, Vauxhall	GR / 3 (0)      12 V    2.2 kW A: 81.5      B: 22.5 mm. Renault	DD / 3 (0)      12 V    3.0 kW A: 99.0      B: 49.5 mm. Volvo, Volvo Penta
CS 784	CS 785#	CS 786
GR / 3 (3)      12 V    1.4 kW A: 66.0      B: 0.0 mm. Opel, Renault, Vauxhall	DD / 3 (0)      12 V    0.9 kW A: 88.5      B: 27.0 mm. Ford	GR / 3 (0)      12 V    1.4 kW A: 76.0      B: 14.5 mm. Ford
CS 787	CS 788	CS 789
GR / 3 (0)      12 V    1.4 kW A: 76.0      B: 14.5 mm. Ford	DD/GR / 4 (2)      12 V    0.9 kW A: 82.5      B: 1.5 mm. Seat, VW <i>W/ or w/o bendixhousing</i>	GR / 2 (0)      12 V    1.8 kW A: 76.0      B: 32.0 mm. Audi, Ford, Mercedes-Benz, Seat, Skoda, VW
CS 790	CS 791	CS 792
DD/GR / 3 (2)      12 V    1.0 kW A: 76.0      B: 13.0 mm. Ford	GR / 3 (3)      12 V    1.1 kW B: -5.0 mm. Renault	GR / 30h / 2 (2)      12 V    1.7 kW A: 76.0      B: 21.5 mm. Alpina-BMW, BMW



























<p><b>CS 794</b></p>	<p><b>CS 795*</b></p>	<p><b>CS 796</b></p>
		
<p>GR / 2 (2)      12 V    2.2 kW                      A: 82.5      B: 26.0 mm.                      Mercedes-Benz</p> <p style="text-align: right;"> 10</p>	<p>DD / 3 (0)      12 V    2.5 kW                      A: 110.0      B: 27.0 mm.                      Fiat</p> <p style="text-align: right;"> 9</p>	<p>DD/GR / 3 (1)      12 V    0.8 kW                      A: 64.0      B: 11.5 mm.                      Fiat, Lancia</p> <p style="text-align: right;"> 9,10</p>
<p><b>CS 798</b></p>	<p><b>CS 800</b></p>	<p><b>CS 801</b></p>
		
<p>GR / 2 (0)      12 V    1.0 kW                      A: 76.0      B: 27.5 mm.                      Skoda, VW</p> <p style="text-align: right;"> 9</p>	<p>DD / 3 (3)      12 V    0.9 kW                      A: 64.5      B: 14.0 mm.                      Fiat</p> <p style="text-align: right;"> 9</p>	<p>GR / 3 (0)      12 V    1.8 kW                      A: 76.0      B: 52.5 mm.                      VW</p> <p style="text-align: right;"> 10,11</p>
<p><b>CS 802</b></p>	<p><b>CS 804</b></p>	<p><b>CS 805</b></p>
		
<p>GR / 2 (0)      12 V    1.4 kW                      A: 76.0      B: 19.5 mm.                      Opel, Saab, Vauxhall</p> <p style="text-align: right;"> 9</p>	<p>DD / 2 (0)      12 V    2.4 kW                      A: 82.0      B: 21.0 mm.                      KHD</p> <p style="text-align: right;"> 9</p>	<p>DD / 3 (0)      24 V    5.5 kW                      A: 89.0      B: 46.0 mm.                      Hanomag  <i>Oil sealed</i></p> <p style="text-align: right;"> 13</p>
<p><b>CS 807</b></p>	<p><b>CS 878</b></p>	<p><b>CS 879</b></p>
		
<p>GR / 2 (0)      12 V    1.1 kW                      A: 76.0      B: 15.0 mm.                      Lombardini</p> <p style="text-align: right;"> 9</p>	<p>GR / 15 / 2 (0)      12 V    1.4 kW                      A: 89.0      B: 18.5 mm.                      Saab</p> <p style="text-align: right;"> 9</p>	<p>GR / 2 (1)      12 V    1.1 kW                      A: 82.5      B: 19.0 mm.                      Chevrolet, Daewoo, Holden, Isuzu, Opel,                      Vauxhall</p> <p style="text-align: right;"> 9</p>



CS 880		CS 881		CS 882	
					
GR / 4 (2) A: 82.0 Seat, VW	12 V 1.1 kW B: 2.0 mm.	DD / 3 (0) A: 92.0 Scania	24 V 6.6 kW B: 36.5 mm.	GR / 3 (3) B: 2.5 mm. Renault	12 V 1.1 kW
					
CS 883		CS 885		CS 886	
					
DD / 3 (3) A: 64.5 Fiat	12 V 0.9 kW B: 11.0 mm.	GR / 3 (3) A: 74.0 Citroen, Peugeot	12 V 2.2 kW B: -5.5 mm.	GR / 2 (2) A: 71.0 Mitsubishi	12 V 1.3 kW B: 3.5 mm.
					
CS 887		CS 888		CS 889	
					
DD / 3 (0) A: 89.0 Bosch, Deutz-Fahr, KHD	12 V 3.1 kW B: 28.0 mm.	GR / 2 (0) A: 76.0 Porsche	12 V 1.7 kW B: 77.0 mm.	DD / 3 (0) A: 89.0 LDV International	12 V 2.8 kW B: 47.0 mm.
					
CS 944		CS 946		CS 949	
					
DD / 3 (0) A: 89.0 Chang Feng (Liebao), Valtra, Zetor	12 V 3.0 kW B: 47.0 mm.	DD / 15 / 3 (0) A: 89.0 Massey Ferguson	12 V 2.1 kW B: 29.0 mm.	DD / 15 / 3 (0) A: 89.0 DAF	12 V 2.1 kW B: 29.0 mm.
					



























<p><b>CS 955</b></p>	<p><b>CS 960</b></p>	<p><b>CS 961</b></p>
		
<p>DD / 3 (0)      24 V    5.4 kW A: 89.0      B: 47.0 mm. Volvo Penta</p> <p style="text-align: right;"> 9</p>	<p>DD / 3 (3)      12 V    0.9 kW A: 76.0      B: 26.5 mm. Ford</p> <p style="text-align: right;"> 10</p>	<p>GR / 2 (0)      12 V    1.4 kW B: 22.0 mm. Ford, Jaguar, Mazda, Mercury</p> <p style="text-align: right;"> 22</p>
<p><b>CS 962</b></p>	<p><b>CS 963</b></p>	<p><b>CS 964</b></p>
		
<p>DD / 3 (0)      24 V    6.6 kW A: 92.0      B: 47.0 mm. Volvo</p> <p style="text-align: right;"> 12</p>	<p>DD / 3 (1)      12 V    0.8 kW A: 64.0      B: 11.0 mm. Fiat, Lancia</p> <p style="text-align: right;"> 9</p>	<p>GR / 3 (3)      12 V    2.2 kW A: 75.5      B: -7.0 mm. Renault</p> <p style="text-align: right;"> 10</p>
<p><b>CS 965</b></p>	<p><b>CS 971</b></p>	<p><b>CS 972</b></p>
		
<p>GR / 30h / 3 (0)    12 V    1.4 kW A: 66.0      B: 23.0 mm. Fiat, Lancia</p> <p style="text-align: right;"> 11</p>	<p>GR / 3 (2)      12 V    1.1 kW A: 72.0      B: 14.0 mm. Ford, Mazda</p> <p style="text-align: right;"> 23</p>	<p>GR / 3 (0)      12 V    1.4 kW A: 88.5      B: 28.0 mm. Ford</p> <p style="text-align: right;"> 9</p>
<p><b>CS 973</b></p>	<p><b>CS 974</b></p>	<p><b>CS 975</b></p>
		
<p>GR / 3 (3)      12 V    2.2 kW A: 81.5      B: 21.5 mm. Citroen, Fiat, Peugeot</p> <p style="text-align: right;"> 9</p>	<p>GR / 2 (0)      12 V    1.8 kW A: 76.0      B: 52.5 mm. Audi, Ford, Seat, Skoda, VW</p> <p style="text-align: right;"> 10,11</p>	<p>DD / 3 (3)      12 V    0.9 kW A: 64.0      B: 11.0 mm. Citroen, Fiat, Lancia</p> <p style="text-align: right;"> 8,9</p>



























<b>CS 976</b>	<b>CS 977</b>	<b>CS 978</b>
<b>GR / 2 (1)</b> 12 V    2.0 kW <b>A: 82.5      B: 18.5 mm.</b> Opel, Saab, Vauxhall	<b>GR / 3 (0)</b> 12 V    2.3 kW <b>A: 92.0      B: 20.0 mm.</b> Ford, LDV	<b>GR / 3 (3)</b> 12 V    1.7 kW <b>A: 68.0      B: 0.0 mm.</b> Renault, Volvo
<b>CS 979#</b>	<b>CS 980</b>	<b>CS 981</b>
<b>GR / 3 (2)</b> 12 V    1.4 kW <b>A: 82.0      B: 8.0 mm.</b> Chrysler, Dodge, Plymouth	<b>DD / 4 (3)</b> 12 V    0.9 kW <b>A: 66.0      B: -1.5 mm.</b> Renault	<b>DD / 3 (1)</b> 12 V    0.9 kW <b>A: 64.0      B: 10.0 mm.</b> Fiat
<b>CS 982</b>	<b>CS 983</b>	<b>CS 984</b>
<b>GR / 2 (0)</b> 12 V    1.4 kW <b>A: 76.5      B: 19.0 mm.</b> Cadillac, Opel, Vauxhall	<b>DD / 3 (0)</b> 24 V    8.0 kW <b>A: 89.0      B: 41.0 mm.</b> Renault V.I.	<b>GR / 30h / 2 (2)</b> 12 V    2.0 kW <b>A: 76.0      B: 21.0 mm.</b> BMW, Opel, Vauxhall
<b>CS 985</b>	<b>CS 986</b>	<b>CS 987#</b>
<b>GR / 15 / 2 (1)</b> 12 V    1.8 kW <b>A: 76.0      B: 29.0 mm.</b> Audi	<b>GR / 3 (2)</b> 12 V    1.1 kW <b>A: 72.0      B: 15.0 mm.</b> Ford	<b>DD / 3 (0)</b> 12 V    2.8 kW <b>A: 92.0      B: 20.0 mm.</b> Case





























<p><b>CS 988</b></p>  <p>GR / 2 (0)      12 V    1.8 kW                      A: 66.0      B: 46.0 mm.                      Audi, Seat, VW</p> 	<p><b>CS 989</b></p>  <p>DD / 3 (0)      24 V    4.0 kW                      A: 89.0      B: 38.0 mm.                      DAF</p> 	<p><b>CS 990</b></p>  <p>GR / 2 (1)      12 V    1.1 kW                      A: 74.0      B: 9.0 mm.                      Chrysler, Dodge, Plymouth</p> 
<p><b>CS 992</b></p>  <p>GR / 3 (3)      12 V    2.2 kW                      A: 82.5      B: 23.0 mm.                      Fiat</p> 	<p><b>CS 994</b></p>  <p>DD / 3 (0)      12 V    2.8 kW                      A: 89.0      B: 29.0 mm.                      Massey Ferguson</p> 	<p><b>CS 995<sup>#</sup></b></p>  <p>DD / 2 (0)      12 V    1.9 kW                      A: 82.0      B: 20.0 mm.                      Sabb</p> 
<p><b>CS 1031</b></p>  <p>DD / 3 (0)      12 V    3.6 kW                      A: 92.0      B: 46.0 mm.                      Mercedes-Benz, New Holland</p> 	<p><b>CS 1032</b></p>  <p>DD / 3 (0)      12 V    2.8 kW                      A: 92.0      B: 21.0 mm.                      Massey Ferguson</p> 	<p><b>CS 1035</b></p>  <p>GR / 3 (0)      12 V    3.1 kW                      A: 89.0      B: 49.0 mm.                      Volvo Penta</p> 
<p><b>CS 1036</b></p>  <p>GR / 2 (0)      12 V    1.4 kW                      A: 66.0      B: 10.0 mm.                      Eagle, Jeep</p> 	<p><b>CS 1037</b></p>  <p>GR / 3 (3)      12 V    1.7 kW                      A: 82.0      B: 23.5 mm.                      Fiat</p> 	<p><b>CS 1038</b></p>  <p>DD / 3 (3)      12 V    0.8 kW                      A: 62.0      B: 12.0 mm.                      Fiat</p> 



<b>CS 1041</b>	<b>CS 1042</b>	<b>CS 1043</b>
		
<b>GR / 15 / 2 (1)</b> 12 V    1.8 kW <b>A: 76.0    B: 27.5 mm.</b> Audi	<b>GR / 3 (0)</b> 12 V    1.4 kW <b>A: 66.0    B: 10.0 mm.</b> Alfa Romeo, Fiat, Lancia	<b>DD/GR / 3 (2)</b> 12 V    0.9 kW <b>A: 64.5    B: 11.0 mm.</b> Fiat
 9	 9	 8,9
<b>CS 1044</b>	<b>CS 1045</b>	<b>CS 1047</b>
		
<b>GR / 2 (2)</b> 12 V    2.0 kW <b>A: 82.5    B: 26.0 mm.</b> Mercedes-Benz	<b>GR / 3 (0)</b> 12 V    2.0 kW <b>A: 82.0    B: 9.0 mm.</b> Alfa Romeo, Fiat, Lancia	<b>GR / 2 (0)</b> 12 V    1.8 kW <b>A: 76.0    B: 27.0 mm.</b> Skoda, VW
 10,11	 9,11	 9
<b>CS 1048</b>	<b>CS 1049</b>	<b>CS 1050</b>
		
<b>GR / 30h / 3 (0)</b> 12 V    1.8 kW <b>A: 76.0    B: 20.5 mm.</b> BMW	<b>GR / 2 (0)</b> 12 V    1.7 kW <b>A: 73.0    B: 39.5 mm.</b> Land Rover	<b>GR / 3 (3)</b> 12 V    1.1 kW <b>A: 76.0    B: 27.0 mm.</b> Ford, Mazda, Volvo
 13	 9	 10
<b>CS 1051</b>	<b>CS 1052</b>	<b>CS 1053</b>
		
<b>GR / 2 (1)</b> 12 V    2.2 kW <b>A: 82.5    B: 20.0 mm.</b> Volvo	<b>DD / 3 (1)</b> 12 V    0.9 kW <b>A: 64.0    B: 11.0 mm.</b> Lancia	<b>GR / 3 (0)</b> 12 V    1.1 kW <b>A: 66.0    B: 10.0 mm.</b> Alfa Romeo, Fiat, Lancia
 9	 9	 9



<p><b>CS 1055</b></p>  <p>GR / 3 (2)      12 V      2.2 kW                      A: 70.0      B: -6.0 mm.                      Renault</p> 	<p><b>CS 1057</b></p>  <p>DD / 2 (1)      12 V      0.7 kW                      A: 63.0      B: 0.0 mm.                      Nissan, Renault</p> 	<p><b>CS 1058</b></p>  <p>GR / 3 (3)      12 V      1.5 kW                      A: 76.0      B: 3.0 mm.                      Ford, Mazda, Mercury</p> 
<p><b>CS 1059</b></p>  <p>GR / 3 (3)      12 V      1.7 kW                      A: 82.0      B: 23.0 mm.                      Fiat, Innocenti</p> 	<p><b>CS 1060</b></p>  <p>GR / 3 (3)      12 V      1.1 kW                      B: -1.0 mm.                      Renault, Volvo</p> 	<p><b>CS 1061</b></p>  <p>DD / 3 (0)      24 V      6.7 kW                      A: 92.0      B: 48.0 mm.                      Scania</p> 
<p><b>CS 1062</b></p>  <p>GR / 2 (0)      12 V      1.1 kW                      A: 76.5      B: 32.0 mm.                      Audi, Ford, Seat, Skoda, VW</p> 	<p><b>CS 1063</b></p>  <p>GR / 3 (1)      12 V      1.1 kW                      A: 82.5      B: 3.5 mm.                      Seat, Skoda, VW</p> 	<p><b>CS 1067</b></p>  <p>GR / 30h / 3 (2)      12 V      1.4 kW                      A: 76.0      B: 22.0 mm.                      BMW</p> 
<p><b>CS 1069</b></p>  <p>DD / 3 (0)      12 V      3.1 kW                      A: 89.0      B: 49.0 mm.                      Case  <i>Oilproof and waterproof.</i></p> 	<p><b>CS 1071</b></p>  <p>GR / 2 (0)      12 V      2.0 kW                      A: 82.5      B: 21.0 mm.                      Opel, Vauxhall</p> 	<p><b>CS 1072</b></p>  <p>GR / 2 (2)      12 V      1.7 kW                      A: 60.0      B: 27.0 mm.                      Maybach, Mercedes-Benz</p> 



CS 1073	CS 1074	CS 1075
DD / 2 (0)      12 V      2.4 kW A: 82.5      B: 22.0 mm. Goldoni, Land Rover	GR / 2 (1)      12 V      1.4 kW A: 82.5      B: 27.5 mm. Audi, Skoda, VW	GR / 2 (2)      12 V      1.2 kW A: 82.5      B: 26.0 mm. Daewoo, Mercedes-Benz, Ssangyong, VW
CS 1076	CS 1077	CS 1107
GR / 3 (1)      12 V      0.8 kW A: 64.0      B: 10.0 mm. Fiat, Lancia	DD / 3 (0)      24 V      6.2 kW A: 92.0      B: 48.0 mm. Mercedes-Benz	GR / 3 (2)      12 V      1.4 kW A: 76.0      B: 13.5 mm. Ford, Mazda, Mercury
CS 1108	CS 1109	CS 1111
GR / 3 (0)      12 V      1.5 kW B: 13.0 mm. Citroen, Fiat, Peugeot, Renault	GR / 3 (3)      12 V      2.6 kW A: 81.5      B: 23.5 mm. Citroen, Fiat, Peugeot	DD / 3 (1)      12 V      0.7 kW A: 62.0      B: -5.0 mm. Citroen, Peugeot
CS 1112	CS 1113	CS 1114
GR / 3 (0)      24 V      4.0 kW A: 89.0      B: 48.0 mm. Mercedes-Benz	GR / 3 (2)      12 V      1.7 kW A: 76.0      B: -1.0 mm. Volvo	GR / 2 (2)      12 V      2.0 kW A: 76.0      B: 29.0 mm. Audi, Skoda, VW



























<p><b>CS 1115</b></p>	<p><b>CS 1116</b></p>	<p><b>CS 1117</b></p>
<p>GR / 2 (2)      12 V    2.0 kW                      A: 82.5      B: 20.5 mm.                      VW</p>	<p>DD / 3 (0)      24 V    6.6 kW                      A: 92.0      B: 47.0 mm.                      Volvo</p>	<p>DD/GR / 2 (0)      12 V    1.0 kW                      A: 70.0      B: 14.0 mm.                      Mercedes-Benz</p>
<p><b>CS 1118</b></p>	<p><b>CS 1119</b></p>	<p><b>CS 1121</b></p>
<p>GR / 3 (1)      12 V    2.2 kW                      A: 110.0      B: 27.0 mm.                      Iveco</p>	<p>GR / 2 (0)      12 V    1.1 kW                      A: 76.0      B: 53.0 mm.                      Audi, Ford, Seat, Skoda, VW</p>	<p>DD / 3 (0)      12 V    2.4 kW                      A: 89.0      B: 49.0 mm.                      Claas</p>
<p><b>CS 1123</b></p>	<p><b>CS 1124</b></p>	<p><b>CS 1125</b></p>
<p>DD / 3 (0)      12 V    3.0 kW                      A: 89.0      B: 30.0 mm.                      Claas</p>	<p>GR / 3 (0)      12 V    2.2 kW                      A: 81.5      B: 10.0 mm.                      Alfa Romeo, Fiat, Lancia</p>	<p>DD/GR / 3 (2)      12 V    0.8 kW                      A: 64.0      B: 11.0 mm.                      Fiat</p>
<p><b>CS 1126</b></p>	<p><b>CS 1128</b></p>	<p><b>CS 1129</b></p>
<p>DD / 3 (0)      12 V    3.1 kW                      A: 92.0      B: 21.0 mm.                      Ford, New Holland</p>	<p>DD / 4 (0)      24 V    6.6 kW                      A: 89.0      B: 40.0 mm.                      Renault V.I.</p>	<p>DD / 3 (0)      24 V    5.2 kW                      A: 110.0      B: 48.0 mm.                      DAF</p>



<b>CS 1130</b>	<b>CS 1131#</b>	<b>CS 1132</b>
<b>GR / 3 (0)</b> 12 V    3.0 kW <b>A: 89.0      B: 28.0 mm.</b> Deutz-Fahr	<b>GR / 3 (3)</b> 12 V    2.2 kW <b>B: -5.0 mm.</b> Peugeot, Renault	<b>GR / 3 (3)</b> 12 V    1.4 kW <b>A: 66.0      B: -1.0 mm.</b> Volvo
<b>CS 1160</b>	<b>CS 1161</b>	<b>CS 1162</b>
<b>GR / 3 (0)</b> 12 V    2.2 kW <b>A: 72.0      B: 0.5 mm.</b> Opel, Renault, Vauxhall	<b>DD / 3 (0)</b> 24 V    6.6 kW <b>A: 92.0      B: 47.0 mm.</b> Volvo	<b>GR / 2 (2)</b> 12 V    2.2 kW <b>A: 82.5      B: 25.0 mm.</b> Mercedes-Benz, Ssangyong
<b>CS 1163</b>	<b>CS 1165</b>	<b>CS 1168#</b>
<b>DD / 3 (0)</b> 24 V    6.6 kW <b>A: 115.0    B: 21.0 mm.</b> Iveco  <i>Oil sealed</i>	<b>GR / 2 (2)</b> 12 V    2.0 kW <b>A: 82.5      B: 21.0 mm.</b> VW	<b>DD / 3 (0)</b> 24 V    7.8 kW <b>A: 92.0      B: 48.0 mm.</b> Mercedes-Benz
<b>CS 1169</b>	<b>CS 1170</b>	<b>CS 1171</b>
<b>DD / 3 (0)</b> 24 V    6.7 kW <b>A: 92.0      B: 48.0 mm.</b> Scania	<b>GR / 3 (0)</b> 12 V    2.2 kW <b>A: 81.5      B: 10.0 mm.</b> Lancia	<b>GR / 30h / 2 (2)</b> 12 V    2.2 kW <b>A: 76.0      B: 21.0 mm.</b> BMW, Land Rover



























<p><b>CS 1172</b></p>  <p>GR / 2 (0)      12 V    1.7 kW A: 70.0      B: 14.0 mm. Mercedes-Benz</p> 	<p><b>CS 1173</b></p>  <p>DD / 3 (0)      12 V    2.9 kW A: 89.0      B: 21.0 mm. Fendt</p> 	<p><b>CS 1174</b></p>  <p>DD / 3 (3)      12 V    0.8 kW B: -2.0 mm. Nissan, Renault</p> 
<p><b>CS 1175</b></p>  <p>GR / 2 (0)      12 V    1.2 kW A: 60.0      B: 10.0 mm. Dodge, Jeep</p> 	<p><b>CS 1176</b></p>  <p>GR / 3 (0)      12 V    1.1 kW A: 76.0      B: 53.0 mm. VW</p> 	<p><b>CS 1177</b></p>  <p>GR / 3 (3)      12 V    1.7 kW A: 65.0      B: -5.0 mm. Citroen, Fiat, Hyundai, Lancia, Peugeot</p> 
<p><b>CS 1179</b></p>  <p>GR / 4 (4)      12 V    0.9 kW A: 66.0      B: 0.0 mm. Renault</p> 	<p><b>CS 1180</b></p>  <p>GR / 3 (0)      12 V    2.2 kW A: 82.5      B: 20.5 mm. Jeep</p> 	<p><b>CS 1181</b></p>  <p>GR / 2 (0)      12 V    2.0 kW A: 76.0      B: 62.0 mm. Audi, Ford, Seat, Skoda, VW</p> 
<p><b>CS 1182</b></p>  <p>GR / 2 (0)      12 V    1.4 kW A: 76.0      B: 35.0 mm. Lada</p> 	<p><b>CS 1183</b></p>  <p>DD / 2 (0)      12 V    0.9 kW A: 68.0      B: 17.0 mm. Bedford, Chevrolet, Daewoo, Opel, Vauxhall</p> 	<p><b>CS 1184</b></p>  <p>DD / 3 (0)      12 V    2.2 kW A: 82.5      B: 23.0 mm. KHD</p> 







































CS 1185	CS 1186	CS 1187
GR / 2 (0) A: 82.5    B: 24.0 mm. KHD	DD / 3 (3) A: 66.0    B: 0.0 mm. Dacia, Renault	GR / 2 (1) A: 83.0    B: 21.0 mm. VW
12 V    2.2 kW	12 V    1.0 kW	12 V    2.0 kW
CS 1188	CS 1189	CS 1190
DD/GR / 2 (0) A: 68.0    B: 19.0 mm. Chevrolet, Daewoo, Opel, Vauxhall	GR / 2 (1) A: 74.0    B: 9.0 mm. Chrysler, Dodge, Plymouth	GR / 3 (2) A: 82.0    B: 9.0 mm. Chrysler, Dodge
12 V    1.1 kW	12 V    1.1 kW	12 V    1.4 kW
CS 1191	CS 1192	CS 1193
GR / 3 (3) A: 66.0    B: 11.0 mm. Fiat, Lancia	DD/GR / 3 (1) A: 64.0    B: 11.0 mm. Fiat, Lancia	GR / 4 (3) B: -1.0 mm. Mitsubishi, Nissan, Opel, Renault, Suzuki, Vauxhall
12 V    1.4 kW	12 V    0.8 kW	12 V    1.8 kW
CS 1194	CS 1195	CS 1196
GR / 2 (0) A: 66.0    B: 46.0 mm. Audi, VW	GR / 3 (0) A: 66.0    B: 9.0 mm. Lancia	GR / 2 (1) A: 82.5    B: 21.0 mm. Volvo
12 V    1.8 kW	12 V    1.4 kW	12 V    2.0 kW





<p><b>CS 1197</b></p>  <p><b>GR / 2 (0)</b>      12 V    1.1 kW  <b>A: 76.0    B: 53.0 mm.</b>                      Audi, Seat, Skoda, VW</p> 	<p><b>CS 1198</b></p>  <p><b>GR / 3 (3)</b>      12 V    2.3 kW  <b>A: 81.5    B: 23.0 mm.</b>                      Citroen, Fiat, Peugeot</p> 	<p><b>CS 1199</b></p>  <p><b>DD / 3 (0)</b>      24 V    6.7 kW  <b>A: 92.0    B: 37.0 mm.</b>                      Scania</p> 
<p><b>CS 1200</b></p>  <p><b>GR / 2 (0)</b>      12 V    2.0 kW  <b>A: 76.0    B: 52.0 mm.</b>                      Seat, Skoda, VW</p> 	<p><b>CS 1201</b></p>  <p><b>GR / 3 (0)</b>      12 V    2.2 kW  <b>A: 92.0    B: 20.0 mm.</b>                      Land Rover</p> 	<p><b>CS 1202</b></p>  <p><b>GR / 2 (2)</b>      12 V    2.3 kW  <b>A: 82.5    B: 26.0 mm.</b>                      Mercedes-Benz</p> 
<p><b>CS 1203</b></p>  <p><b>GR / 3 (3)</b>      12 V    2.3 kW  <b>A: 81.0    B: 27.0 mm.</b>                      Iveco, Mitsubishi, Multicar, Renault V.I.</p> 	<p><b>CS 1204</b></p>  <p><b>GR / 3 (1)</b>      12 V    1.0 kW  <b>A: 50.0    B: 20.0 mm.</b>                      Skoda</p> 	<p><b>CS 1205</b></p>  <p><b>DD / 3 (0)</b>      12 V    3.0 kW  <b>A: 89.0    B: 48.0 mm.</b>                      John Deere</p> 
<p><b>CS 1206</b></p>  <p><b>DD / 2 (2)</b>      12 V    0.8 kW  <b>A: 70.0    B: 15.5 mm.</b>                      Smart (MCC)</p> 	<p><b>CS 1207</b></p>  <p><b>GR / 3 (2)</b>      12 V    2.0 kW  <b>B: -6.0 mm.</b>                      Nissan, Opel, Renault, Vauxhall</p> 	<p><b>CS 1208</b></p>  <p><b>GR / 2 (2)</b>      12 V    1.8 kW  <b>A: 82.5    B: 2.5 mm.</b>                      Audi, VW</p> 



CS 1209	CS 1210	CS 1211
 	 	 
GR / 3 (0) 12 V 2.0 kW A: 76.0 B: 62.0 mm. VW	DD/GR / 2 (2) 12 V 1.0 kW A: 75.0 B: 7.0 mm. Chevrolet, Daewoo, Suzuki	GR / 3 (1) 12 V 0.9 kW A: 50.0 B: 21.0 mm. Seat, VW
		
CS 1212	CS 1213	CS 1241
 	 	 
GR / 3 (0) 12 V 1.8 kW A: 82.0 B: 10.0 mm. Fiat	GR / 2 (2) 12 V 1.1 kW A: 66.0 B: 12.0 mm. Fiat, Lancia	GR / 2 (2) 12 V 1.0 kW A: 70.0 B: 15.0 mm. Smart (MCC)
		
CS 1242	CS 1243	CS 1244
 	 	 
GR / 3 (0) 12 V 2.2 kW A: 66.0 B: 21.0 mm. Land Rover	GR / 3 (0) 24 V 4.0 kW A: 89.0 B: 27.0 mm. MAN	GR / 3 (3) 12 V 1.1 kW A: 64.0 B: -6.0 mm. Citroen, Fiat, Lancia, Peugeot
		
CS 1245	CS 1246	CS 1247
 	 	 
GR / 2 (0) 12 V 2.1 kW B: 36.0 mm. Ford, Jaguar	GR / 2 (0) 12 V 1.4 kW B: 28.5 mm. Ford	GR / 2 (0) 12 V 1.7 kW A: 76.0 B: 19.0 mm. Holden, Opel, Vauxhall
		











<p><b>CS 1248</b></p>  <p>GR / 3 (0)      24 V      4.0 kW                      A: 110.0      B: 27.5 mm.                      Iveco</p> 	<p><b>CS 1249</b></p>  <p>GR / 2 (2)      12 V      1.4 kW                      A: 60.0      B: 26.0 mm.                      Mercedes-Benz</p> 	<p><b>CS 1252</b></p>  <p>GR / 3 (3)      12 V      1.4 kW                      A: 65.0      B: 0.0 mm.                      Renault</p> 
<p><b>CS 1253</b></p>  <p>GR / 2 (0)      12 V      1.1 kW                      A: 75.0      B: 40.5 mm.                      MG, Rover</p> 	<p><b>CS 1254</b></p>  <p>GR / 2 (0)      12 V      0.9 kW                      A: 74.0      B: 22.0 mm.                      Mini</p> 	<p><b>CS 1255</b></p>  <p>GR / 4 (3)      12 V      0.9 kW                      A: 66.0      B: 1.0 mm.                      Nissan, Opel, Renault, Vauxhall</p> 
<p><b>CS 1256</b></p>  <p>GR / 15 / 2 (1)      12 V      1.4 kW                      A: 76.0      B: 26.0 mm.                      BMW</p> 	<p><b>CS 1257</b></p>  <p>GR / 2 (0)      12 V      1.1 kW                      A: 68.0      B: 19.0 mm.                      Fiat, Mercedes-Benz, Opel, Saab, Vauxhall</p> 	<p><b>CS 1260</b></p>  <p>GR / 4 (2)      12 V      1.1 kW                      B: 15.0 mm.                      Citroen, Fiat, Peugeot, Toyota</p> 
<p><b>CS 1261</b></p>  <p>DD / 3 (0)      24 V      4.0 kW                      A: 89.0      B: 23.5 mm.                      Iveco</p> 	<p><b>CS 1263</b></p>  <p>GR / 3 (2)      12 V      2.0 kW                      A: 71.0      B: -1.5 mm.                      Opel, Renault, Vauxhall</p> 	<p><b>CS 1264</b></p>  <p>GR / 3 (0)      12 V      1.7 kW                      A: 82.0      B: 8.5 mm.                      Alfa Romeo, Cadillac, Fiat, Lancia, Opel, Saab, Vauxhall</p> 



























<b>CS 1265</b>	<b>CS 1266</b>	<b>CS 1267</b>
<b>GR / 30h / 3 (2)</b> 12 V      1.8 kW <b>A: 76.0      B: 21.0 mm.</b> BMW	<b>GR / 2 (0)</b> 12 V      1.8 kW <b>A: 76.0      B: 52.0 mm.</b> Seat, VW	<b>GR / 3 (0)</b> 24 V      4.0 kW <b>A: 89.0      B: 27.0 mm.</b> MAN
<b>CS 1268</b>	<b>CS 1269</b>	<b>CS 1270</b>
<b>GR / 15 / 3 (0)</b> 24 V      4.0 kW <b>A: 89.0      B: 48.0 mm.</b> Ginaf, Iveco	<b>DD / 15 / 3 (0)</b> 24 V      6.2 kW <b>A: 92.0      B: 49.0 mm.</b> Mercedes-Benz	<b>GR / 15 / 2 (0)</b> 12 V      1.4 kW <b>A: 75.0      B: 40.0 mm.</b> Lotus, MG, Rover
<b>CS 1271</b>	<b>CS 1272</b>	<b>CS 1273</b>
<b>GR / 3 (2)</b> 12 V      2.2 kW <b>A: 76.0      B: 0.0 mm.</b> Volvo	<b>GR / 3 (2)</b> 12 V      1.1 kW <b>A: 76.0      B: 0.0 mm.</b> Volvo	<b>GR / 3 (2)</b> 12 V      1.1 kW <b>A: 65.0      B: -2.0 mm.</b> Dacia, Nissan, Renault, Suzuki
<b>CS 1274</b>	<b>CS 1275</b>	<b>CS 1276</b>
<b>DD / 3 (0)</b> 24 V      6.2 kW <b>A: 110.0      B: 48.0 mm.</b> Bova, DAF, Solaris	<b>GR / 3 (2)</b> 12 V      1.4 kW <b>B: 13.5 mm.</b> Ford, Mazda	<b>DD / 3 (3)</b> 12 V      0.85 kW <b>B: -3.0 mm.</b> Dacia, Nissan, Renault



<p><b>CS 1277</b></p>  <p>GR / 3 (3)      12 V      1.4 kW                      A: 64.0      B: -5.0 mm.                      Citroen, Fiat, Lancia, Peugeot</p> 	<p><b>CS 1279</b></p>  <p>GR / 3 (0)      24 V      4.0 kW                      A: 89.0      B: 48.5 mm.                      Mercedes-Benz</p> 	<p><b>CS 1280</b></p>  <p>DD / 3 (0)      24 V      4.0 kW                      A: 89.0      B: 27.5 mm.                      Fendt</p> 
<p><b>CS 1281</b></p>  <p>GR / 4 (3)      12 V      2.1 kW                      A: 76.0      B: -1.0 mm.                      Mitsubishi, Volvo</p> 	<p><b>CS 1282</b></p>  <p>GR / 2 (0)      12 V      0.9 kW                      A: 76.0      B: 53.5 mm.                      Audi, Seat, Skoda, VW</p> 	<p><b>CS 1283</b></p>  <p>GR / 2 (2)      12 V      1.1 kW                      A: 70.0      B: 27.0 mm.                      Mercedes-Benz</p> 
<p><b>CS 1284</b></p>  <p>DD / 3 (0)      24 V      6.6 kW                      A: 92.0      B: 47.0 mm.                      Scania</p> 	<p><b>CS 1285</b></p>  <p>GR / 3 (0)      24 V      4.0 kW                      A: 92.0      B: 47.0 mm.                      Volvo</p> 	<p><b>CS 1286</b></p>  <p>GR / 2 (0)      12 V      2.0 kW                      A: 76.0      B: 42.5 mm.                      Audi, Seat, Skoda, VW</p> 
<p><b>CS 1287</b></p>  <p>GR / 2 (0)      12 V      2.0 kW                      A: 76.0      B: 32.5 mm.                      Seat, VW</p> 	<p><b>CS 1288</b></p>  <p>GR / 3 (2)      12 V      2.4 kW                      B: -6.0 mm.                      Renault</p> 	<p><b>CS 1289</b></p>  <p>GR / 3 (3)      12 V      1.1 kW                      A: 76.0      B: 15.0 mm.                      Ford</p> 



CS 1290	CS 1291	CS 1292
		
GR / 3 (0)      12 V      1.3 kW B: 13.5 mm. Citroen, Lancia, Peugeot, Renault	GR / 2 (0)      12 V      1.8 kW A: 75.0      B: 29.0 mm. Fiat, Holden, Opel, Saab, Vauxhall	GR / 3 (0)      24 V      5.0 kW A: 92.0      B: 49.0 mm. Iveco
		
CS 1293	CS 1294	CS 1322
		
GR / 3 (0)      12 V      2.0 kW A: 76.5      B: 52.5 mm. Audi, Seat, Skoda, VW	GR / 3 (0)      12 V      1.1 kW A: 76.0      B: 53.0 mm. Audi, Seat, Skoda, VW	GR / 3 (0)      12 V      1.1 kW A: 76.0      B: 56.0 mm. Audi, Seat, Skoda, VW
		
CS 1323	CS 1324	CS 1325
		
GR / 2 (0)      12 V      2.0 kW A: 76.0      B: 62.0 mm. Audi, Seat, Skoda, VW	GR / 2 (0)      12 V      1.0 kW A: 76.0      B: 52.0 mm. Audi, Seat, Skoda, VW	GR / 3 (0)      24 V      6.0 kW A: 89.0      B: 40.0 mm. Renault V.I.
		
CS 1326	CS 1327	CS 1328
		
GR / 3 (3)      12 V      2.3 kW A: 72.0      B: -5.5 mm. Citroen, Fiat, Lancia, Peugeot	GR / 2 (1)      12 V      1.7 kW A: 76.0      B: 7.5 mm. Porsche, VW	GR / 30h / 2 (2)      12 V      1.6 kW A: 74.0      B: 20.5 mm. BMW
		



<p><b>CS 1329</b></p>  <p>GR / 4 (2)      12 V      1.5 kW                      B: 13.0 mm.                      Citroen, Mini, Peugeot, Toyota</p> 	<p><b>CS 1330</b></p>  <p>GR / 2 (0)      12 V      1.0 kW                      A: 76.0      B: 52.5 mm.                      Audi, Seat, Skoda, VW</p> 	<p><b>CS 1331</b></p>  <p>DD/GR / 3 (0)      24 V      4.0 kW                      A: 110.0      B: 48.0 mm.                      DAF</p> 
<p><b>CS 1332</b></p>  <p>GR / 3 (3)      12 V      1.4 kW                      A: 63.0      B: 0.0 mm.                      Dacia, Nissan, Renault</p> 	<p><b>CS 1333</b></p>  <p>DD / 15 / 3 (0)      24 V      6.2 kW                      A: 92.0      B: 48.5 mm.                      Evobus, Kässbohrer, Mercedes-Benz</p> 	<p><b>CS 1334</b></p>  <p>GR / 2 (1)      12 V      1.1 kW                      A: 64.0      B: 24.0 mm.                      Fiat, Lancia, Opel, Suzuki, Vauxhall</p> 
<p><b>CS 1335</b></p>  <p>GR / 3 (0)      12 V      2.2 kW                      A: 82.0      B: 8.5 mm.                      Alfa Romeo, Fiat, Lancia, Suzuki</p> 	<p><b>CS 1336</b></p>  <p>GR / 3 (3)      12 V      1.4 kW                      A: 76.0      B: 15.0 mm.                      Ford</p> 	<p><b>CS 1337</b></p>  <p>GR / 2 (0)      12 V      1.1 kW                      A: 76.0      B: 62.0 mm.                      Audi, Seat, Skoda, VW</p> 
<p><b>CS 1338</b></p>  <p>GR / 2 (0)      12 V      1.3 kW                      A: 70.0      B: 15.0 mm.                      Mercedes-Benz</p> 	<p><b>CS 1339</b></p>  <p>GR / 2 (2)      12 V      1.2 kW                      A: 66.0      B: 25.5 mm.                      Audi</p> 	<p><b>CS 1340</b></p>  <p>DD / 2 (0)      12 V      1.5 kW                      A: 82.5      B: 40.5 mm.                      Hatz</p> 



CS 1341	CS 1342	CS 1343
GR / 3 (2)      12 V      1.2 kW A: 63.5      B: 15.5 mm. Ford, Mazda, Volvo	GR / 3 (3)      12 V      1.9 kW B: -5.0 mm. Citroen, Fiat, Peugeot	DD/GR / 2 (0)      12 V      0.9 kW A: 76.0      B: 32.5 mm. Seat, Skoda, VW
CS 1344	CS 1345	CS 1346
GR / 3 (3)      12 V      1.2 kW B: -1.0 mm. Renault	GR / 2 (2)      12 V      1.3 kW B: 10.0 mm. Fiat, Lancia	DD/GR / 2 (1)      12 V      1.3 kW A: 64.0      B: 24.0 mm. Fiat, Lancia
CS 1347	CS 1348	CS 1376
GR / 2 (0)      12 V      1.1 kW A: 76.0      B: 62.0 mm. Audi, Seat, Skoda, VW	GR / 3 (0)      24 V      6.0 kW A: 89.0      B: 40.0 mm. Renault V.I.	GR / 3 (0)      12 V      3.0 kW A: 89.0      B: 48.0 mm. John Deere
CS 1377	CS 1378	CS 1379
GR / 3 (3)      12 V      2.2 kW A: 62.5      B: -5.5 mm. Ford, Volvo	GR / 2 (2)      12 V      2.2 kW A: 82.5      B: 59.0 mm. VW	DD/GR / 2 (1)      12 V      0.8 kW A: 64.0      B: 10.5 mm. Alfa Romeo, Fiat, Lancia





<p><b>CS 1380</b></p>  <p>GR / 3 (0)      24 V    5.5 kW                      A: 110.0    B: 48.0 mm.                      Bova, DAF, Solaris</p>  <p>12</p>	<p><b>CS 1381</b></p>  <p>GR / 3 (0)      24 V    4.0 kW                      A: 89.0      B: 45.0 mm.                      Mercedes-Benz</p>  <p>9.11</p>	<p><b>CS 1382</b></p>  <p>GR / 3 (0)      24 V    4.0 kW                      A: 89.0      B: 26.5 mm.                      DAF</p>  <p>10</p>
<p><b>CS 1383</b></p>  <p>GR / 3 (0)      24 V    4.5 kW                      A: 89.0      B: 48.5 mm.                      Iveco</p>  <p>10</p>	<p><b>CS 1384</b></p>  <p>DD / 2 (0)      12 V    0.8 kW                      A: 70.0      B: 14.5 mm.                      Mercedes-Benz</p>  <p>8.9</p>	<p><b>CS 1385</b></p>  <p>DD / 2 (1)      12 V    0.85 kW                      A: 63.0      B: -0.5 mm.                      Dacia, Nissan, Renault</p>  <p>9</p>
<p><b>CS 1386</b></p>  <p>GR / 3 (0)      24 V    5.5 kW                      A: 92.0      B: 47.0 mm.                      Renault V.I.</p>  <p>11</p>	<p><b>CS 1387</b></p>  <p>GR / 2 (2)      12 V    1.7 kW                      A: 82.0      B: 3.0 mm.                      Audi, VW</p>  <p>9</p>	<p><b>CS 1388</b></p>  <p>GR / 3 (0)      24 V    4.5 kW                      A: 92.0      B: 48.0 mm.                      Volvo</p>  <p>12</p>
<p><b>CS 1389</b></p>  <p>GR / 3 (3)      12 V    2.5 kW                      A: 82.0      B: 1.0 mm.                      Citroen, Fiat, Peugeot</p>  <p>9</p>	<p><b>CS 1390</b></p>  <p>GR / 2 (0)      12 V    2.3 kW                      B: 38.0 mm.                      Audi, Ford, Seat, VW</p>  <p>15</p>	<p><b>CS 1391</b></p>  <p>GR / 3 (1)      12 V    2.2 kW                      B: 14.0 mm.                      Citroen, Peugeot</p>  <p>11</p>



<b>CS 1392</b>	<b>CS 1393</b>	<b>CS 1394</b>
<b>GR / 2 (2)</b> 12 V    2.0 kW <b>A: 82.0      B: 2.0 mm.</b> Audi, Seat, Skoda	<b>GR / 2 (0)</b> 12 V    1.7 kW <b>A: 76.0      B: 52.0 mm.</b> Seat, Skoda, VW	<b>GR / 2 (2)</b> 12 V    1.2 kW <b>A: 82.5      B: 14.5 mm.</b> Audi, Seat, Skoda, VW
<b>CS 1395</b>	<b>CS 1396</b>	<b>CS 1397</b>
<b>GR / 2 (0)</b> 12 V    1.4 kW <b>A: 75.0      B: 32.0 mm.</b> Opel, Saab, Vauxhall	<b>GR / 3 (3)</b> 12 V    2.2 kW <b>A: 76.0      B: 14.5 mm.</b> Ford	<b>GR / 2 (0)</b> 12 V    1.7 kW <b>A: 76.0      B: 57.5 mm.</b> VW
<b>CS 1398</b>	<b>CS 1399</b>	<b>CS 1400<sup>#</sup></b>
<b>GR / 3 (2)</b> 12 V    1.4 kW <b>A: 76.0      B: 0.0 mm.</b> Ford, Volvo	<b>GR / 3 (0)</b> 24 V    5.5 kW <b>A: 92.0      B: 48.0 mm.</b> Scania	<b>GR / 3 (0)</b> 24 V    6.0 kW <b>A: 92.0      B: 48.0 mm.</b> Scania
<b>CS 1401</b>	<b>CS 1402</b>	<b>CS 1403</b>
<b>GR / 2 (2)</b> 12 V    1.1 kW <b>A: 82.0      B: 3.0 mm.</b> Audi, Seat	<b>GR / 2 (0)</b> 12 V    1.2 kW <b>B: 29.0 mm.</b> Ford	<b>GR / 2 (0)</b> 12 V    1.2 kW <b>B: 29.0 mm.</b> Ford, Volvo



<p><b>CS 1404</b></p>  <p>GR / 3 (3)      12 V    1.4 kW                      A: 76.0      B: 26.0 mm.                      Ford</p> 	<p><b>CS 1405</b></p>  <p>GR / 2 (0)      12 V    2.2 kW                      A: 76.0      B: 61.5 mm.                      VW</p> 	<p><b>CS 1406</b></p>  <p>GR / 2 (2)      12 V    1.8 kW                      A: 74.0      B: 21.5 mm.                      BMW</p> 
<p><b>CS 1407</b></p>  <p>DD/GR / 2 (1)      12 V    1.1 kW                      A: 74.0      B: 25.0 mm.                      Citroen, Peugeot, Toyota</p> 	<p><b>CS 1408</b></p>  <p>GR / 3 (3)      12 V    2.0 kW                      A: 76.0      B: 6.0 mm.                      Ford</p> 	<p><b>CS 1409</b></p>  <p>GR / 2 (0)      12 V    1.0 kW                      A: 76.0      B: 43.0 mm.                      Audi, Seat, VW</p> 
<p><b>CS 1410</b></p>  <p>GR / 2 (2)      12 V    1.7 kW                      A: 82.5      B: 26.0 mm.                      Mercedes-Benz</p> 	<p><b>CS 1411</b></p>  <p>GR / 2 (1)      12 V    2.2 kW                      A: 76.0      B: 24.5 mm.                      Audi, VW</p> 	<p><b>CS 1412</b></p>  <p>GR / 2 (1)      12 V    1.2 kW                      A: 76.0      B: 25.0 mm.                      BMW</p> 
<p><b>CS 1413</b></p>  <p>DD/GR / 2 (1)      12 V    1.2 kW                      A: 76.0      B: 25.0 mm.                      BMW</p> 	<p><b>CS 1414</b></p>  <p>GR / 2 (2)      12 V    1.4 kW                      A: 60.0      B: 27.0 mm.                      Mercedes-Benz</p> 	<p><b>CS 1415</b></p>  <p>GR / 3 (3)      12 V    2.2 kW                      A: 76.5      B: 13.5 mm.                      Nissan, Opel, Renault, Vauxhall</p> 



CS 1416	CS 1417	CS 1418*
		PICTURES NOT AVAILABLE AT THE MOMENT
GR / 5 (5)      12 V    2.5 kW B: -5.0 mm. Citroen, Fiat, Lancia, Mitsubishi, Peugeot	GR / 4 (2)      12 V    0.9 kW A: 64.0      B: 13.0 mm. Citroen, Mini, Peugeot	GR / 2 (0)      12 V    1.0 kW A: 70.0      B: 19.0 mm. Nissan, Renault
CS 1419	CS 1420	CS 1421
GR / 2 (1)      12 V    1.7 kW A: 76.0      B: 25.5 mm. BMW	DD/GR / 3 (0)      24 V    5.5 kW A: 110.0      B: 47.0 mm. Bova, DAF, Solaris	GR / 2 (0)      12 V    2.0 kW B: 36.0 mm. Citroen, Fiat, Ford, Land Rover, Peugeot
CS 1422	CS 1423	CS 1424
DD / 2 (1)      12 V    0.8 kW A: 75.0      B: 7.0 mm. Chevrolet, Daewoo	GR / 2 (2)      12 V    2.0 kW A: 82.5      B: 15.0 mm. Audi	GR / 2 (2)      12 V    2.0 kW A: 70.0      B: 31.0 mm. Nissan
CS 1425	CS 1426	CS 1427*
		PICTURES NOT AVAILABLE AT THE MOMENT
DD / 3 (3)      12 V    1.1 kW A: 61.5      B: 1.0 mm. Renault	GR / 2 (0)      12 V    1.6 kW B: 15.5 mm. Ford	GR / 2 (0)      12 V    2.0 kW A: 75.0      B: 33.0 mm. Honda

















<p><b>CS 1428</b></p>	<p><b>CS 1429</b></p>	<p><b>CS 1430</b></p>
		
<p>GR / 3 (0)      12 V    1.7 kW                      A: 82.0      B: 4.0 mm.                      Cadillac, Opel, Saab, Vauxhall</p>	<p>GR / 3 (3)      12 V    1.4 kW                      A: 76.0      B: 6.5 mm.                      Ford</p>	<p>GR / 3 (2)      12 V    1.4 kW                      A: 70.5      B: -1.5 mm.                      Ford, Volvo</p>
		
<p><b>CS 1431</b></p>	<p><b>CS 1432*</b></p>	<p><b>CS 1433</b></p>
	<p>PICTURES NOT AVAILABLE                      AT THE MOMENT</p>	
<p>GR / 2 (0)      12 V    1.8 kW                      A: 82.5      B: 18.0 mm.                      Chevrolet, Opel, Vauxhall</p>	<p>GR / 3 (0)      24 V    5.0 kW                      A: 92.0      B: 42.0 mm.                      Iveco</p>	<p>GR / 2 (2)      12 V    1.2 kW                      A: 77.0      B: 17.0 mm.                      Hyundai, Kia</p>
		
<p><b>CS 1434</b></p>	<p><b>CS 1435</b></p>	<p><b>CS 1436</b></p>
		
<p>GR / 3 (3)      12 V    2.3 kW                      A: 81.5      B: 1.5 mm.                      Fiat</p>	<p>GR / 2 (2)      12 V    2.0 kW                      A: 82.5      B: 19.0 mm.                      VW</p>	<p>GR / 2 (0)      12 V    1.4 kW                      B: 22.5 mm.                      Mazda</p>
		
<p><b>CS 1437</b></p>	<p><b>CS 1438</b></p>	<p><b>CS 1439</b></p>
		
<p>GR / 2 (1)      12 V    1.1 kW                      A: 66.0      B: 24.0 mm.                      Audi</p>	<p>GR / 2 (0)      12 V    1.1 kW                      A: 68.0      B: 19.0 mm.                      Alfa Romeo, Fiat, Opel, Vauxhall</p>	<p>GR / 2 (2)      12 V    2.2 kW                      A: 70.0      B: 31.5 mm.                      Nissan</p>
		



CS 1440	CS 1441	CS 1442
GR / 2 (0) A: 76.0 B: 52.5 mm. Porsche	GR / 2 (2) A: 82.5 B: 24.5 mm. Kia	DD / 3 (3) A: 66.0 B: -1.0 mm. Dacia, Renault
12 V 1.7 kW 	12 V 2.0 kW 	12 V 0.8 kW 
CS 1443	CS 1444	CS 1445
GR / 3 (0) A: 89.0 B: 48.0 mm. Volvo	GR / 3 (3) A: 66.0 B: 3.0 mm. Suzuki	GR / 2 (0) A: 74.0 B: 25.5 mm. Mini
24 V 4.0 kW 	12 V 2.0 kW 	12 V 0.9 kW 
CS 1446	CS 1447	CS 1448*
		PICTURES NOT AVAILABLE AT THE MOMENT
GR / 3 (2) A: 64.0 B: 12.5 mm. Hyundai	GR / 2 (1) A: 82.5 B: 18.0 mm. Toyota	GR / 2 (1) A: 82.5 B: 18.0 mm. Opel, Toyota
12 V 2.2 kW 	12 V 3.0 kW 	12 V 2.7 kW 
CS 1449	CS 1450	CS 1451*
PICTURES NOT AVAILABLE AT THE MOMENT		PICTURES NOT AVAILABLE AT THE MOMENT
GR / 3 (3) A: 82.0 B: 22.0 mm. Citroen, Fiat, Peugeot	GR / 2 (1) A: 74.0 B: 14.0 mm. Toyota	GR / 3 (0) A: 92.0 B: 46.0 mm. Volvo
12 V 2.5 kW 	12 V 1.2 kW 	24 V 7.0 kW 



<b>CS 1452*</b>	<b>CS 1453</b>	<b>CS 1454*</b>
<p>PICTURES NOT AVAILABLE AT THE MOMENT</p>		<p>PICTURES NOT AVAILABLE AT THE MOMENT</p>
<p>GR / 2 (0) 12 V A: 65.0 B: 52.0 mm. Smart (MCC)</p> 	<p>GR / 2 (1) 12 V 1.1 kW A: 74.0 B: 15.0 mm. Toyota</p> 	<p>GR / 3 (2) 12 V 2.0 kW A: 82.5 B: 0.0 mm. Chrysler</p> 
<b>CS 1455*</b>	<b>CS 1456*</b>	<b>CS 1457*</b>
<p>PICTURES NOT AVAILABLE AT THE MOMENT</p>		<p>PICTURES NOT AVAILABLE AT THE MOMENT</p>
<p>GR / 2 (0) 12 V 1.0 kW A: 75.0 B: 40.0 mm. Honda</p> 	<p>GR / 2 (0) 12 V 1.0 kW A: 75.0 B: 33.0 mm. Honda</p> 	<p>GR / 2 (0) 12 V 2.0 kW A: 75.0 B: 33.0 mm. Honda</p> 
<b>CS 1458*</b>	<b>CS 1459</b>	<b>CS 1460*</b>
<p>PICTURES NOT AVAILABLE AT THE MOMENT</p>		<p>PICTURES NOT AVAILABLE AT THE MOMENT</p>
<p>GR / 2 (0) 12 V A: 75.0 B: 38.0 mm. Honda</p> 	<p>GR / 2 (2) 12 V 1.4 kW A: 77.0 B: 9.5 mm. Mitsubishi</p> 	<p>GR / 3 (0) 12 V 2.0 kW B: 14.0 mm. Dodge, Mitsubishi</p> 
<b>CS 1461*</b>	<b>CS 1462</b>	<b>CS 1463</b>
<p>PICTURES NOT AVAILABLE AT THE MOMENT</p>	<p>PICTURES NOT AVAILABLE AT THE MOMENT</p>	
<p>GR / 2 (0) 12 V A: 75.0 B: 31.0 mm. Alfa Romeo, Fiat</p> 	<p>DD / 2 (2) 12 V 0.9 kW A: 77.0 B: 21.0 mm. Hyundai</p> 	<p>GR / 3 (0) 24 V 6.2 kW A: 92.0 B: 47.0 mm. Mercedes-Benz</p> 















CS 1464	CS 1465	CS 1466
GR / 3 (0)      24 V      4.0 kW A: 89.0      B: 22.0 mm. Renault V.I.	GR / 2 (2)      12 V A: 77.0      B: 21.0 mm. Hyundai, Kia	GR / 3 (0)      12 V      2.0 kW A: 69.0      B: 6.0 mm. BMW
CS 1467	CS 1468*	CS 1469
	PICTURES NOT AVAILABLE AT THE MOMENT	
GR / 3 (0)      12 V      2.2 kW A: 69.0      B: 6.0 mm. BMW	GR / 3 (2)      12 V      2.0 kW A: 70.0      B: 24.5 mm. Land Rover	GR / 3 (3)      12 V A: 74.0      B: 15.0 mm. Mazda
CS 1470	CS 1471	CS 1472*
	PICTURES NOT AVAILABLE AT THE MOMENT	PICTURES NOT AVAILABLE AT THE MOMENT
GR / 2 (0)      12 V      1.1 kW A: 76.0      B: 63.0 mm. Audi, Seat, Skoda, VW	GR / 2 (0)      12 V      2.0 kW A: 74.0      B: 18.0 mm. JCB, KHD, Perkins	GR / 3 (0)      24 V      4.5 kW A: 92.0      B: 46.5 mm. Volvo
CS 1473	CS 1474	CS 1475
PICTURES NOT AVAILABLE AT THE MOMENT		
GR / 30h / 2 (2)      12 V      2.0 kW A: 76.0      B: 21.0 mm. BMW	GR / 3 (0)      24 V      4.0 kW A: 89.0      B: 48.0 mm. Volvo	GR / 2 (0)      12 V      1.1 kW A: 76.0      B: 52.0 mm. Seat, Skoda





CS 1476*			CS 1477*			CS 1478*		
PICTURES NOT AVAILABLE AT THE MOMENT			PICTURES NOT AVAILABLE AT THE MOMENT					
GR / 2 (0) A: 55.0 Toyota	12 V B: 66.0 mm.	1.3 kW	GR / 2 (0) A: 55.0 Audi, VW	12 V B: 17.0 mm.	1.4 kW	GR / 4 (3) A: 55.0 Renault	12 V B: 0.0 mm.	2.4 kW
CS 1479*			CS 1480*			CS 1481*		
PICTURES NOT AVAILABLE AT THE MOMENT			PICTURES NOT AVAILABLE AT THE MOMENT			PICTURES NOT AVAILABLE AT THE MOMENT		
GR / 2 (1) A: 74.0 Mazda	12 V B: 15.0 mm.	1.2 kW	GR / 2 (0) A: 76.0 Audi, Seat, Skoda, VW	12 V B: 62.0 mm.	1.8 kW	GR / 2 (2) A: 82.5 Chrysler, Jeep	12 V B: 25.5 mm.	2.2 kW
CS 1482*			CS 1483*			CS 1484*		
PICTURES NOT AVAILABLE AT THE MOMENT			PICTURES NOT AVAILABLE AT THE MOMENT			PICTURES NOT AVAILABLE AT THE MOMENT		
GR / 3 (3) A: 82.0 Chrysler	12 V B: 9.0 mm.	2.2 kW	GR / 2 (0) A: 91.0 Toyota	12 V B: 16.5 mm.	3.0 kW	GR / 2 (1) A: 82.5 Toyota	12 V B: 18.5 mm.	2.0 kW
CS 1485*			CS 1486*			CS 1487*		
PICTURES NOT AVAILABLE AT THE MOMENT			PICTURES NOT AVAILABLE AT THE MOMENT			PICTURES NOT AVAILABLE AT THE MOMENT		
GR / 2 (2) A: 82.5 Mercedes-Benz	12 V B: 26.0 mm.	2.0 kW	GR / 3 (0) A: 110.0 DAF	24 V B: 47.5 mm.	4.0 kW	GR / 2 (1) A: 66.0 Suzuki	12 V B: 5.0 mm.	1.4 kW



<b>CS 1488*</b>	<b>CS 1489*</b>	<b>CS 1490*</b>
PICTURES NOT AVAILABLE AT THE MOMENT	PICTURES NOT AVAILABLE AT THE MOMENT	PICTURES NOT AVAILABLE AT THE MOMENT
<b>GR / 3 (0)</b> <b>12 V</b> <b>A: 68.5      B: 29.0 mm.</b> Opel, Saab, Vauxhall	<b>GR / 2 (1)</b> <b>12 V    0.7 kW</b> <b>A: 70.0      B: 32.0 mm.</b> Honda	<b>DD / 2 (1)</b> <b>12 V    0.85 kW</b> <b>A: 74.0      B: 25.0 mm.</b> Toyota
		
<b>CS 1491*</b>	<b>CS 1492*</b>	<b>CS 1493*</b>
PICTURES NOT AVAILABLE AT THE MOMENT	PICTURES NOT AVAILABLE AT THE MOMENT	PICTURES NOT AVAILABLE AT THE MOMENT
<b>GR / 2 (0)</b> <b>12 V    2.5 kW</b> <b>A: 95.0      B: 10.5 mm.</b> Nissan, Opel, Renault, Renault V.I., Vauxhall	<b>GR / 2 (1)</b> <b>12 V    1.2 kW</b> <b>A: 70.0      B: 10.0 mm.</b> Hyundai, Kia	<b>GR / 2 (0)</b> <b>12 V</b> <b>B: 22.5 mm.</b> Mazda
		
<b>CS 1494*</b>	<b>CS 1495*</b>	<b>CS 1496*</b>
PICTURES NOT AVAILABLE AT THE MOMENT	PICTURES NOT AVAILABLE AT THE MOMENT	PICTURES NOT AVAILABLE AT THE MOMENT
<b>GR / 3 (1)</b> <b>24 V    3.7 kW</b> <b>A: 60.0      B: 17.0 mm.</b> Mitsubishi, Mitsubishi Fuso	<b>GR / 3 (0)</b> <b>24 V    5.5 kW</b> <b>A: 89.0      B: 46.0 mm.</b> Renault V.I., Volvo	<b>GR / 3 (0)</b> <b>24 V    5.5 kW</b> <b>A: 89.0      B: 27.0 mm.</b> Renault V.I.
		
<b>CS 1497*</b>	<b>CS 1498*</b>	<b>CS 1499*</b>
PICTURES NOT AVAILABLE AT THE MOMENT	PICTURES NOT AVAILABLE AT THE MOMENT	PICTURES NOT AVAILABLE AT THE MOMENT
<b>GR / 3 (0)</b> <b>24 V    7.2 kW</b> <b>A: 92.0      B: 46.5 mm.</b> Renault V.I.	<b>GR / 2 (2)</b> <b>12 V    0.9 kW</b> <b>A: 74.0      B: 12.0 mm.</b> Daihatsu, Subaru	<b>GR / 2 (1)</b> <b>12 V    1.6 kW</b> <b>A: 74.0      B: 14.5 mm.</b> Toyota
		



























CS 1500*	CS 1501*	CS 1502*
PICTURES NOT AVAILABLE AT THE MOMENT	PICTURES NOT AVAILABLE AT THE MOMENT	PICTURES NOT AVAILABLE AT THE MOMENT
GR / 2 (2) 12 V 1.4 kW A: 74.0 B: 3.0 mm. Toyota	GR / 2 (2) 12 V 1.4 kW A: 82.5 B: 7.5 mm. Chrysler, Dodge, Plymouth	GR / 3 (3) 12 V 1.4 kW A: 81.0 B: 8.5 mm. Chrysler, Dodge
CS 1503*	CS 1504*	CS 1505*
PICTURES NOT AVAILABLE AT THE MOMENT	PICTURES NOT AVAILABLE AT THE MOMENT	PICTURES NOT AVAILABLE AT THE MOMENT
GR / 2 (2) 12 V 1.2 kW A: 78.0 B: 28.0 mm. MG, Rover	GR / 2 (2) 12 V 1.7 kW A: 75.0 B: 0.0 mm. Suzuki	GR / 3 (0) 12 V 2.0 kW A: 79.0 B: 52.0 mm. Audi, Seat, Skoda, VW
CS 1506*	CS 1507*	CS 1508*
PICTURES NOT AVAILABLE AT THE MOMENT	PICTURES NOT AVAILABLE AT THE MOMENT	PICTURES NOT AVAILABLE AT THE MOMENT
GR / 2 (1) 12 V 1.2 kW A: 74.0 B: 12.0 mm. Toyota	GR / 3 (0) 12 V 2.2 kW A: 82.5 B: 19.0 mm. Jeep	GR / 2 (0) 12 V 1.7 kW A: 79.0 B: 60.0 mm. Audi, Seat, VW
CS 1509*	CS 1510*	JS 300
PICTURES NOT AVAILABLE AT THE MOMENT	PICTURES NOT AVAILABLE AT THE MOMENT	
GR / 4 (3) 12 V 1.4 kW A: 66.0 B: 0.0 mm. Renault	GR / 2 (0) 12 V Mitsubishi	DD / 2 (0) 12 V 0.8 kW A: 70.0 B: 11.5 mm. Nissan



























JS 302#		JS 305		JS 307	
DD / 2 (0) A: 82.5    B: 8.0 mm. Nissan, TCM		DD / 2 (0) A: 70.0    B: 42.0 mm. Nissan		DD / 2 (0) A: 82.5    B: 8.0 mm. Nissan	
JS 308#		JS 311#		JS 316	
GR / 2 (0) A: 82.5    B: 8.0 mm. Nissan		DD / 2 (0) A: 75.0    B: 33.0 mm. Honda, Nissan, Rover		GR / 2 (0) A: 74.0    B: 20.0 mm. Toyota, VW	
JS 317		JS 319		JS 325	
DD/GR / 2 (2) A: 74.0    B: 8.0 mm. Chevrolet, GEO, Toyota <i>W/ or w/o bendixhousing</i>		GR / 2 (0) A: 75.0    B: 33.0 mm. Honda, Rover		DD / 15 / 3 (2) A: 74.0    B: 15.0 mm. Mazda, Mercury	
JS 329		JS 330#		JS 335#	
DD / 2 (0) A: 82.5    B: 8.0 mm. Komatsu, Nissan		DD / 2 (0) A: 66.0    B: 17.5 mm. Suzuki, Toyota		DD / 15 / 2 (0) A: 74.0    B: 19.0 mm. Toyota	



























<p><b>JS 336</b></p>  <p>DD / 15 / 2 (0)      12 V      0.8 kW                      A: 82.5      B: 35.0 mm.                      Daihatsu, Komatsu, Toyota</p> 	<p><b>JS 339</b></p>  <p>GR / 2 (2)      12 V      1.0 kW                      A: 74.0      B: 9.0 mm.                      Chrysler, Daihatsu, Dodge, Plymouth, Toyota</p> 	<p><b>JS 340</b></p>  <p>DD / 2 (0)      12 V      0.8 kW                      A: 70.0      B: 21.0 mm.                      Komatsu, Nissan, TCM</p> 
<p><b>JS 343</b></p>  <p>DD / 2 (0)      12 V      0.8 kW                      A: 82.5      B: 7.5 mm.                      Komatsu, Nissan, TCM</p> 	<p><b>JS 344</b></p>  <p>GR / 2 (2)      12 V      2.0 kW                      A: 77.0      B: 3.5 mm.                      Dodge, Hindustan, Hyundai, Mitsubishi, Proton</p> 	<p><b>JS 349</b></p>  <p>DD / 2 (2)      12 V      0.9 kW                      A: 77.0      B: 16.0 mm.                      Dodge, Hyundai, Kia, Mitsubishi, Plymouth, Proton</p> 
<p><b>JS 350</b></p>  <p>DD / 2 (2)      12 V      0.7 kW                      A: 77.0      B: 17.0 mm.                      Dodge, Eagle, Hyundai, Mitsubishi, Plymouth, Proton</p> 	<p><b>JS 357</b></p>  <p>DD/GR / 2 (2)      12 V      0.8 kW                      A: 74.0      B: 4.5 mm.                      Toyota</p> 	<p><b>JS 359</b></p>  <p>GR / 2 (0)      12 V      1.8 kW                      A: 82.5      B: 10.0 mm.                      Nissan</p> 
<p><b>JS 362</b></p>  <p>DD / 2 (0)      12 V      1.1 kW                      A: 77.0      B: 18.0 mm.                      Mitsubishi</p> 	<p><b>JS 365</b></p>  <p>GR / 3 (2)      12 V      2.0 kW                      A: 88.0      B: 7.0 mm.                      Ford, Kia, Mazda, Suzuki                      W/ or w/o bendixhousing</p> 	<p><b>JS 370</b></p>  <p>DD / 15 / 2 (2)      12 V      1.2 kW                      A: 82.5      B: 35.0 mm.                      Volvo</p> 



























<p><b>JS 373</b></p>  <p>GR / 2 (0)      12 V    1.0 kW A: 82.5      B: 33.0 mm. Subaru</p> 	<p><b>JS 378</b></p>  <p>DD/GR / 2 (1)      12 V    1.0 kW A: 82.5      B: 5.0 mm. Nissan</p> 	<p><b>JS 379</b></p>  <p>DD / 2 (0)      12 V    1.8 kW A: 82.5      B: 11.5 mm. Nissan</p> 
<p><b>JS 380</b></p>  <p>DD/GR / 2 (0)      12 V    1.0 kW A: 66.0      B: 4.0 mm. Chevrolet, GEO, Suzuki</p> 	<p><b>JS 385</b></p>  <p>GR / 2 (2)      12 V    1.0 kW A: 74.0      B: 18.0 mm. Daihatsu, Toyota, VW</p> 	<p><b>JS 387</b></p>  <p>DD / 15 / 2 (0)      12 V    0.6 kW A: 65.0      B: 26.0 mm. Bedford, Suzuki</p> 
<p><b>JS 388</b></p>  <p>GR / 2 (2)      12 V    1.0 kW A: 74.0      B: 20.0 mm. Toyota</p> 	<p><b>JS 392</b></p>  <p>GR / 2 (1)      12 V    2.5 kW A: 82.5      B: 15.0 mm. Toyota, VW</p> 	<p><b>JS 394</b></p>  <p>DD / 15 / 2 (0)      12 V    0.8 kW A: 66.0      B: 18.0 mm. Suzuki</p> 
<p><b>JS 396<sup>#</sup></b></p>  <p>DD / 2 (2)      12 V    0.7 kW A: 77.0      B: 17.5 mm. Hyundai, Mitsubishi, Proton</p> 	<p><b>JS 399<sup>#</sup></b></p>  <p>DD / 3 (0)      24 V    3.2 kW A: 105.0      B: 11.0 mm. Nissan</p> 	<p><b>JS 512</b></p>  <p>DD/GR / 2 (2)      12 V    0.8 kW A: 74.5      B: 7.5 mm. Chevrolet, GEO, Pontiac, Subaru, Suzuki</p> 



























JS 517	JS 520	JS 521
		
<p>GR / 2 (0)      12 V    2.5 kW                      A: 95.0      B: 10.0 mm.                      Ford, Nissan  <i>W/ or w/o bendixhousing</i></p>	<p>GR / 2 (0)      12 V    1.2 kW                      A: 70.0      B: 42.0 mm.                      Nissan</p>	<p>GR / 2 (2)      12 V    2.5 kW                      A: 82.5      B: 21.0 mm.                      Daihatsu</p>
		
JS 522	JS 525	JS 539
		
<p>GR / 2 (0)      12 V    2.0 kW                      A: 82.5      B: 10.5 mm.                      Nissan</p>	<p>GR / 2 (2)      12 V    1.0 kW                      A: 74.0      B: 5.0 mm.                      Toyota</p>	<p>GR / 2 (2)      12 V    2.0 kW                      A: 82.5      B: 3.5 mm.                      Nissan</p>
		
JS 540	JS 552	JS 553
		
<p>GR / 3 (0)      24 V    3.5 kW                      A: 105.0      B: 10.0 mm.                      Nissan</p>	<p>GR / 2 (0)      12 V    2.0 kW                      A: 95.0      B: 20.0 mm.                      Chevrolet, GMC, Iseki, Isuzu, Opel, TCM,                      Vauxhall</p>	<p>GR / 3 (1)      24 V    3.2 kW                      A: 60.0      B: 17.0 mm.                      Mitsubishi</p>
		
JS 557	JS 558#	JS 560
		
<p>DD / 2 (0)      12 V    0.8 kW                      A: 82.5      B: 39.5 mm.                      Subaru</p>	<p>DD / 2 (0)      12 V    0.8 kW                      A: 82.5      B: 40.0 mm.                      Subaru</p>	<p>GR / 2 (1)      12 V    1.0 kW                      A: 74.0      B: 8.0 mm.                      GEO, Toyota</p>
		



























<b>JS 563</b>	<b>JS 568</b>	<b>JS 627</b>
		
<b>GR / 2 (1)</b> 12 V    1.0 kW <b>A: 74.0</b> <b>B: 8.0 mm.</b> Toyota	<b>GR / 2 (2)</b> 12 V    2.2 kW <b>A: 82.5</b> <b>B: 9.0 mm.</b> Nissan	<b>GR / 15 / 2 (2)</b> 12 V    1.4 kW <b>A: 82.0</b> <b>B: 43.0 mm.</b> Infiniti, Nissan
		
<b>JS 628</b>	<b>JS 630</b>	<b>JS 632</b>
		
<b>GR / 15 / 2 (2)</b> 12 V    1.2 kW <b>A: 77.0</b> <b>B: 17.0 mm.</b> Dodge, Eagle, Hyundai, Kia, Mazda, Mitsubishi, Plymouth	<b>DD / 15 / 2 (0)</b> 12 V    0.6 kW <b>A: 82.5</b> <b>B: 33.5 mm.</b> Suzuki	<b>GR / 2 (0)</b> 12 V    1.4 kW <b>A: 55.0</b> <b>B: 65.5 mm.</b> Lexus, Toyota
		
<b>JS 633</b>	<b>JS 637</b>	<b>JS 639</b>
		
<b>GR / 2 (0)</b> 12 V    0.85 kW <b>A: 70.0</b> <b>B: 20.5 mm.</b> Ford, Kia, Mazda	<b>GR / 3 (2)</b> 12 V    1.4 kW <b>A: 74.0</b> <b>B: 15.0 mm.</b> Ford, Kia, Mazda	<b>GR / 2 (0)</b> 12 V    2.0 kW <b>A: 95.0</b> <b>B: 11.0 mm.</b> Isuzu, Opel, Vauxhall
		
<b>JS 640</b>	<b>JS 642</b>	<b>JS 643</b>
		
<b>DD / 3 (2)</b> 12 V    0.85 kW <b>A: 74.0</b> <b>B: 16.0 mm.</b> Kia, Mazda	<b>GR / 2 (1)</b> 12 V    2.0 kW <b>A: 82.5</b> <b>B: 15.5 mm.</b> Toyota, VW	<b>DD / 2 (2)</b> 12 V    0.9 kW <b>A: 77.0</b> <b>B: 10.0 mm.</b> Dodge, Eagle, Hyundai, Mitsubishi, Plymouth
		

























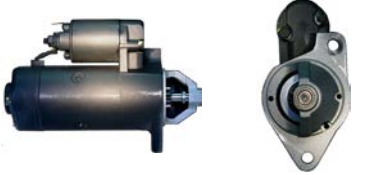

<p><b>JS 644</b></p>  <p>GR / 2 (2)      12 V      1.0 kW                      A: 74.0      B: 8.0 mm.                      Toyota</p> 	<p><b>JS 645</b></p>  <p>GR / 2 (0)      12 V      1.4 kW                      A: 75.0      B: 33.0 mm.                      Acura, Honda, Rover</p> 	<p><b>JS 648</b></p>  <p>DD/GR / 2 (0)      12 V      1.0 kW                      A: 75.0      B: 40.5 mm.                      Honda, Rover</p> 
<p><b>JS 650</b></p>  <p>GR / 2 (0)      12 V      2.0 kW                      A: 82.5      B: 8.0 mm.                      Nissan</p> 	<p><b>JS 651</b></p>  <p>GR / 2 (1)      12 V      1.4 kW                      A: 78.0      B: 18.0 mm.                      Opel, Vauxhall</p> 	<p><b>JS 652</b></p>  <p>GR / 2 (0)      12 V      1.0 kW                      A: 55.0      B: 66.0 mm.                      Lexus, Toyota</p> 
<p><b>JS 655</b></p>  <p>GR / 2 (1)      24 V      4.5 kW                      A: 105.0      B: 14.5 mm.                      Toyota</p> 	<p><b>JS 657</b></p>  <p>DD/GR / 2 (1)      12 V      1.0 kW                      A: 74.0      B: 4.0 mm.                      Daihatsu  <i>W/ or w/o bendixhousing</i></p> 	<p><b>JS 658</b></p>  <p>GR / 2 (2)      12 V      1.2 kW                      A: 73.0      B: 17.0 mm.                      Dodge, Hyundai, Kia, Mitsubishi</p> 
<p><b>JS 660</b></p>  <p>GR / 2 (0)      12 V      2.0 kW                      A: 95.0      B: 12.0 mm.                      Nissan</p> 	<p><b>JS 661#</b></p>  <p>DD / 2 (0)      12 V      0.8 kW                      A: 74.0      B: 33.5 mm.                      Daihatsu</p> 	<p><b>JS 664</b></p>  <p>GR / 2 (0)      12 V      2.0 kW                      A: 75.0      B: 39.0 mm.                      Rover</p> 



























JS 666	JS 667	JS 669
		
GR / 2 (0)      24 V      4.5 kW A: 105.0      B: 17.0 mm. Toyota	GR / 2 (2)      12 V      1.4 kW A: 82.5      B: 3.0 mm. Nissan	GR / 2 (0)      12 V      1.4 kW A: 74.0      B: 21.0 mm. Toyota, VW
		
JS 670	JS 671	JS 672
		
GR / 2 (0)      12 V      1.4 kW A: 82.5      B: 33.0 mm. Subaru <i>W/ or w/o bendixhousing</i>	GR / 2 (0)      12 V      1.0 kW A: 65.0      B: 49.0 mm. Subaru <i>W/ or w/o bendixhousing</i>	DD/GR / 2 (1)      12 V      1.0 kW A: 70.0      B: 11.0 mm. Nissan
		
JS 673	JS 674	JS 679
		
DD / 2 (0)      12 V      0.8 kW A: 66.0      B: 18.0 mm. Kubota	DD/GR / 2 (0)      12 V      0.9 kW A: 74.0      B: 20.0 mm. Mitsubishi	DD/GR / 2 (0)      12 V      2.2 kW A: 95.0      B: 20.5 mm. TCM
		
JS 729	JS 730	JS 731
		
DD / 2 (0)      12 V      1.3 kW A: 89.0      B: 15.0 mm. Yanmar	GR / 2 (0)      12 V      1.0 kW A: 66.0      B: 18.0 mm. Kubota <i>W/ or w/o bendixhousing</i>	DD/GR / 2 (0)      12 V      1.4 kW A: 95.0      B: 19.0 mm. Yanmar
		



























JS 733	JS 734	JS 737
		
<p>GR / 2 (0)      24 V    4.5 kW                      A: 90.0      B: 15.0 mm.                      Toyota</p>	<p>GR / 2 (0)      12 V    1.4 kW                      A: 82.5      B: 25.0 mm.                      Kubota</p>	<p>DD/GR / 2 (0)      12 V    1.2 kW                      A: 74.0      B: 20.0 mm.                      Ford, John Deere, Volvo Penta</p>
 <p>11</p>	 <p>9</p>	 <p>9</p>
JS 747	JS 751	JS 753
		
<p>GR / 3 (0)      12 V    1.7 kW                      A: 72.0      B: 45.5 mm.                      Ford, Mazda</p>	<p>DD / 2 (0)      12 V    0.8 kW                      A: 82.5      B: 9.5 mm.                      TCM</p>	<p>GR / 3 (1)      12 V    1.4 kW                      A: 78.0      B: 18.5 mm.                      Opel, Vauxhall</p>
 <p>12</p>	 <p>8,9</p>	 <p>9</p>
JS 754 <sup>#</sup>	JS 755 <sup>#</sup>	JS 757
		
<p>GR / 2 (0)      12 V    1.4 kW                      B: 14.0 mm.                      Nissan</p>	<p>DD / 2 (0)      12 V    1.0 kW                      A: 70.0      B: 11.0 mm.                      Nissan</p>	<p>GR / 2 (0)      12 V    1.4 kW                      A: 82.5      B: 32.0 mm.                      Subaru</p>
 <p>21</p>	 <p>9</p>	 <p>9</p>
JS 759	JS 760	JS 762
		
<p>DD/GR / 2 (0)      12 V    0.8 kW                      A: 70.0      B: 43.0 mm.                      Nissan</p>	<p>DD/GR / 2 (1)      12 V    0.8 kW                      A: 74.0      B: 8.0 mm.                      Toyota</p>	<p>GR / 3 (3)      12 V    1.4 kW                      A: 82.0      B: 8.0 mm.                      Chrysler, Dodge, Plymouth</p>
 <p>8</p>	 <p>8,9</p>	 <p>9,11</p>











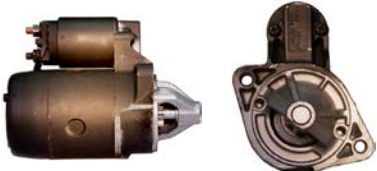















<b>JS 766</b>	<b>JS 769</b>	<b>JS 770</b>
		
<b>GR / 2 (1)</b> 12 V    1.2 kW <b>A: 70.0</b> <b>B: 12.5 mm.</b> Nissan	<b>GR / 2 (2)</b> 12 V    2.2 kW <b>A: 76.5</b> <b>B: 3.5 mm.</b> Dodge, Hyundai, Mitsubishi	<b>GR / 2 (2)</b> 12 V    2.0 kW <b>A: 77.0</b> <b>B: 9.0 mm.</b> Hyundai, Kia, Mitsubishi
 8	 13	 10
<b>JS 774</b>	<b>JS 776<sup>#</sup></b>	<b>JS 777</b>
		
<b>GR / 2 (2)</b> 12 V    2.2 kW <b>A: 74.0</b> <b>B: 4.0 mm.</b> Toyota	<b>GR / 2 (0)</b> 12 V    2.0 kW <b>A: 95.0</b> <b>B: 19.5 mm.</b> Thermo King	<b>GR / 2 (0)</b> 24 V    3.2 kW <b>A: 82.5</b> <b>B: 22.0 mm.</b> Mitsubishi
 9,10	 9	 9,11
<b>JS 779</b>	<b>JS 890</b>	<b>JS 892</b>
		
<b>GR / 2 (0)</b> 12 V    1.2 kW <b>A: 82.5</b> <b>B: 8.0 mm.</b> Mitsubishi, Nissan	<b>GR / 2 (2)</b> 12 V    1.4 kW <b>A: 82.5</b> <b>B: 3.0 mm.</b> Nissan  <i>W/ or w/o bendixhousing</i>	<b>GR / 2 (2)</b> 12 V    2.2 kW <b>A: 77.0</b> <b>B: 10.0 mm.</b> Hyundai, Kia, Mitsubishi
 9	 8,9	 10,11,13
<b>JS 894</b>	<b>JS 895</b>	<b>JS 901</b>
		
<b>GR / 3 (2)</b> 12 V    1.6 kW <b>A: 74.0</b> <b>B: 20.0 mm.</b> Toyota	<b>GR / 2 (0)</b> 12 V    1.2 kW <b>A: 77.0</b> <b>B: 29.5 mm.</b> Iseki	<b>DD / 2 (0)</b> 12 V    0.8 kW <b>A: 65.0</b> <b>B: 31.0 mm.</b> Daihatsu, Piaggio
 9	 15	 8,9



























<p><b>JS 902</b></p>  <p>GR / 2 (2)      12 V    1.4 kW                      A: 74.0      B: 4.0 mm.                      Toyota</p> 	<p><b>JS 908</b></p>  <p>GR / 2 (0)      12 V    1.4 kW                      A: 66.0      B: 18.5 mm.                      Kubota</p> 	<p><b>JS 909</b></p>  <p>GR / 2 (0)      12 V    1.0 kW                      A: 95.0      B: 21.0 mm.                      John Deere, Yanmar</p> 
<p><b>JS 911#</b></p>  <p>GR / 2 (1)      12 V    1.4 kW                      A: 82.5      B: 3.5 mm.                      Nissan</p> 	<p><b>JS 912</b></p>  <p>GR / 2 (0)      12 V    1.0 kW                      A: 55.0      B: 66.0 mm.                      Toyota</p> 	<p><b>JS 913</b></p>  <p>GR / 2 (0)      12 V    1.4 kW                      A: 55.0      B: 66.0 mm.                      Toyota</p> 
<p><b>JS 915</b></p>  <p>GR / 2 (0)      12 V    1.2 kW                      A: 77.0      B: 18.0 mm.                      Mitsubishi, Nissan  <i>W/ or w/o bendixhousing</i></p> 	<p><b>JS 916</b></p>  <p>GR / 2 (2)      12 V    1.0 kW                      A: 74.0      B: 3.0 mm.                      Daihatsu</p> 	<p><b>JS 918</b></p>  <p>GR / 2 (1)      12 V    0.8 kW                      A: 74.0      B: 8.5 mm.                      Toyota</p> 
<p><b>JS 922</b></p>  <p>GR / 2 (2)      12 V    1.2 kW                      A: 77.0      B: 10.0 mm.                      Hyundai, Kia</p> 	<p><b>JS 923</b></p>  <p>GR / 2 (2)      12 V    1.2 kW                      A: 77.0      B: 17.5 mm.                      Hyundai, Kia</p> 	<p><b>JS 924</b></p>  <p>GR / 2 (0)      12 V    1.4 kW                      A: 75.0      B: 55.0 mm.                      Infiniti, Nissan</p> 



























<b>JS 925</b>	<b>JS 936</b>	<b>JS 937</b>
		
<b>DD / 2 (2)</b> 12 V    0.9 kW <b>A: 77.0</b> <b>B: 11.5 mm.</b> Mitsubishi	<b>GR / 2 (0)</b> 12 V    2.2 kW <b>A: 82.5</b> <b>B: 8.0 mm.</b> Nissan	<b>GR / 3 (3)</b> 12 V    1.4 kW <b>A: 70.0</b> <b>B: 28.0 mm.</b> Nissan
		
<b>JS 939</b>	<b>JS 941</b>	<b>JS 942</b>
		
<b>GR / 2 (0)</b> 12 V    1.2 kW <b>A: 82.5</b> <b>B: 8.0 mm.</b> Ford, Nissan	<b>GR / 2 (1)</b> 12 V    1.4 kW <b>A: 78.0</b> <b>B: 19.0 mm.</b> Opel, Vauxhall	<b>GR / 2 (2)</b> 12 V    1.2 kW <b>A: 81.5</b> <b>B: 7.5 mm.</b> Chrysler, Dodge, Plymouth
		
<b>JS 998#</b>	<b>JS 999</b>	<b>JS 1000</b>
		
<b>GR / 2 (1)</b> 12 V    0.8 kW <b>A: 74.0</b> <b>B: 4.0 mm.</b> Daihatsu	<b>GR / 2 (0)</b> 12 V    2.8 kW <b>A: 95.0</b> <b>B: 11.0 mm.</b> Isuzu, Opel, Vauxhall	<b>DD / 3 (2)</b> 12 V    0.9 kW <b>A: 74.0</b> <b>B: 15.0 mm.</b> Ford, Kia, Mazda
		
<b>JS 1001</b>	<b>JS 1003</b>	<b>JS 1004</b>
		
<b>GR / 2 (2)</b> 12 V    2.2 kW <b>A: 82.0</b> <b>B: 3.5 mm.</b> Nissan	<b>DD / 2 (2)</b> 12 V    0.9 kW <b>A: 77.0</b> <b>B: 18.0 mm.</b> Dodge, Eagle, Hyundai, Mitsubishi, Plymouth, Proton	<b>GR / 2 (2)</b> 12 V    1.2 kW <b>A: 77.0</b> <b>B: 9.5 mm.</b> Hyundai, Kia, Mitsubishi
		

























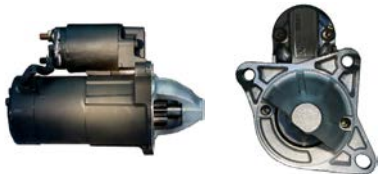

JS 1005#		JS 1006		JS 1009	
					
GR / 2 (2) A: 82.5 Daihatsu	12 V 2.2 kW B: 21.0 mm.	GR / 2 (1) A: 82.5 Jeep	12 V 1.2 kW B: 6.0 mm.	GR / 2 (0) A: 82.5 Mitsubishi	12 V 2.2 kW B: 24.0 mm.
					
JS 1014		JS 1015		JS 1016	
					
GR / 2 (0) A: 77.0 Mitsubishi	12 V 2.0 kW B: 30.0 mm.	GR / 2 (2) A: 74.0 Toyota	12 V 1.0 kW B: 20.0 mm.	DD/GR / 2 (1) A: 70.0 Nissan	12 V 0.9 kW B: 11.5 mm.
					
JS 1018		JS 1019		JS 1020#	
					
GR / 2 (1) A: 74.0 Toyota	12 V 1.2 kW B: 8.0 mm.	GR / 2 (2) A: 74.0 Toyota	12 V 1.4 kW B: 20.0 mm.	GR / 2 (1) A: 73.0 Mitsubishi	12 V 1.0 kW B: 18.0 mm.
					
JS 1021		JS 1022		JS 1023	
					
GR / 2 (0) A: 91.0 Toyota	24 V 4.5 kW B: 16.0 mm.	GR / 2 (0) A: 75.0 Honda	12 V 1.2 kW B: 33.0 mm.	GR / 2 (2) A: 74.0 Toyota	12 V 0.8 kW B: 5.0 mm.
					



























<b>JS 1024</b>	<b>JS 1080</b>	<b>JS 1084</b>
		
<p>GR / 2 (2)      12 V      1.0 kW  A: 74.0      B: 5.0 mm.  Toyota  <i>W/ or w/o bendixhousing</i></p> 	<p>GR / 2 (0)      12 V      1.2 kW  A: 55.0      B: 66.0 mm.  Toyota</p> 	<p>GR / 3 (2)      12 V      1.4 kW  A: 74.0      B: 19.5 mm.  Toyota</p> 
<b>JS 1086</b>	<b>JS 1087</b>	<b>JS 1088</b>
		
<p>GR / 2 (2)      12 V      0.8 kW  A: 74.0      B: 4.0 mm.  Daihatsu</p> 	<p>GR / 3 (0)      24 V      3.5 kW  A: 105.0      B: 33.0 mm.  Nissan</p> 	<p>GR / 2 (2)      12 V      2.2 kW  A: 74.0      B: 4.0 mm.  Toyota  <i>W/ or w/o bendixhousing</i></p> 
<b>JS 1089</b>	<b>JS 1090</b>	<b>JS 1091</b>
		
<p>GR / 2 (1)      12 V      2.0 kW  A: 82.5      B: 15.0 mm.  Toyota</p> 	<p>GR / 2 (1)      12 V      2.7 kW  A: 82.5      B: 15.0 mm.  Toyota</p> 	<p>GR / 2 (1)      12 V      1.2 kW  A: 78.0      B: 20.0 mm.  Opel, Vauxhall</p> 
<b>JS 1092</b>	<b>JS 1094</b>	<b>JS 1096</b>
		
<p>GR / 2 (2)      12 V      1.2 kW  A: 75.0      B: 6.0 mm.  Chevrolet, GEO, Suzuki</p> 	<p>GR / 2 (0)      12 V      1.4 kW  B: 14.0 mm.  Nissan</p> 	<p>GR / 3 (2)      12 V      1.0 kW  A: 74.0      B: 13.0 mm.  Mazda</p> 





<p><b>JS 1098</b></p>	<p><b>JS 1099#</b></p>	<p><b>JS 1100</b></p>
		
<p>DD / 3 (2)      12 V    0.9 kW                      A: 74.0      B: 11.0 mm.                      Kia</p> 	<p>GR / 2 (1)      12 V    1.4 kW                      A: 55.0      B: 17.0 mm.                      Toyota</p> 	<p>GR / 2 (1)      12 V    1.2 kW                      A: 70.0      B: 12.5 mm.                      Nissan</p> 
<p><b>JS 1101</b></p>	<p><b>JS 1102</b></p>	<p><b>JS 1104</b></p>
		
<p>GR / 2 (2)      12 V    1.4 kW                      A: 74.0      B: 19.0 mm.                      Toyota</p> 	<p>GR / 2 (0)      12 V    1.4 kW                      A: 74.0      B: 19.5 mm.                      Bobcat, Ford, Volvo Penta</p> 	<p>GR / 2 (2)      12 V    1.4 kW                      A: 82.5      B: 15.0 mm.                      Nissan</p> 
<p><b>JS 1105</b></p>	<p><b>JS 1135</b></p>	<p><b>JS 1136</b></p>
		
<p>GR / 2 (1)      12 V    1.1 kW                      A: 74.0      B: 9.0 mm.                      Toyota</p> 	<p>GR / 2 (2)      12 V    2.0 kW                      A: 74.0      B: 4.0 mm.                      Toyota</p> 	<p>GR / 3 (2)      12 V    1.0 kW                      A: 74.0      B: 15.5 mm.                      Mazda</p> 
<p><b>JS 1137</b></p>	<p><b>JS 1138#</b></p>	<p><b>JS 1139</b></p>
		
<p>GR / 2 (2)      12 V    1.4 kW                      A: 82.5      B: 44.0 mm.                      Infiniti, Nissan</p> 	<p>GR / 2 (2)      12 V    2.2 kW                      A: 74.0      B: 3.5 mm.                      Toyota</p> 	<p>GR / 2 (2)      12 V    1.2 kW                      A: 77.0      B: 10.0 mm.                      Mitsubishi, Volvo</p> 



<b>JS 1140</b>	<b>JS 1141</b>	<b>JS 1142</b>
		
<b>GR / 2 (2)</b> 12 V    2.2 kW <b>A: 77.0</b> <b>B: 2.5 mm.</b> Mitsubishi	<b>GR / 2 (1)</b> 12 V    1.1 kW <b>A: 74.0</b> <b>B: 7.0 mm.</b> Toyota <i>W/ or w/o bendixhousing</i>	<b>DD / 2 (1)</b> 12 V    0.9 kW <b>A: 70.0</b> <b>B: 11.5 mm.</b> Nissan
		
<b>JS 1145</b>	<b>JS 1146</b>	<b>JS 1147</b>
		
<b>DD / 2 (0)</b> 12 V    1.0 kW <b>A: 70.0</b> <b>B: 18.0 mm.</b> Yanmar	<b>DD / 3 (2)</b> 12 V    0.95 kW <b>A: 74.0</b> <b>B: 16.0 mm.</b> Mazda	<b>GR / 2 (0)</b> 12 V    1.0 kW <b>A: 75.0</b> <b>B: 33.5 mm.</b> Honda, Rover
		
<b>JS 1149</b>	<b>JS 1150</b>	<b>JS 1151</b>
		
<b>GR / 2 (1)</b> 12 V    1.8 kW <b>A: 75.0</b> <b>B: 38.5 mm.</b> Honda, Land Rover, MG, Rover	<b>GR / 2 (0)</b> 12 V    1.6 kW <b>A: 75.0</b> <b>B: 40.0 mm.</b> Honda, Rover	<b>GR / 2 (0)</b> 12 V    1.4 kW <b>A: 75.0</b> <b>B: 39.0 mm.</b> Acura, Honda
		
<b>JS 1152</b>	<b>JS 1153</b>	<b>JS 1154</b>
		
<b>GR / 2 (0)</b> 12 V    1.0 kW <b>A: 75.0</b> <b>B: 33.0 mm.</b> Honda, Rover	<b>GR / 2 (2)</b> 12 V    1.4 kW <b>A: 66.0</b> <b>B: 4.5 mm.</b> Chevrolet, Suzuki	<b>GR / 2 (1)</b> 12 V    2.2 kW <b>A: 82.5</b> <b>B: 18.0 mm.</b> Toyota
		



























JS 1155		JS 1156		JS 1157	
GR / 2 (1) A: 82.5 Toyota	12 V 2.7 kW B: 18.0 mm.	GR / 2 (2) A: 82.0 Nissan	12 V 1.4 kW B: 43.0 mm.	GR / 2 (2) A: 74.0 Toyota	12 V 1.4 kW B: 4.0 mm.
JS 1158		JS 1159		JS 1214	
GR / 2 (1) A: 78.0 Chevrolet, Honda, Opel, Vauxhall	12 V 1.4 kW B: 19.0 mm.	GR / 2 (0) A: 95.0 Nissan	12 V 2.2 kW B: 11.0 mm.	GR / 2 (0) A: 95.0 Ford, Nissan	12 V 1.9 kW B: 10.5 mm.
JS 1215		JS 1216		JS 1217	
DD / 2 (0) A: 75.0 Honda	12 V 0.8 kW B: 33.0 mm.	GR / 2 (0) A: 75.0 Honda	12 V 1.0 kW B: 39.0 mm.	GR / 2 (0) A: 91.0 Toyota	24 V 4.5 kW B: 16.0 mm.
JS 1219		JS 1220		JS 1221	
GR / 2 (0) A: 82.5 Nissan	12 V 1.4 kW B: 8.0 mm.	GR / 2 (2) A: 74.0 Daihatsu	12 V 0.8 kW B: 8.0 mm.	GR / 2 (2) A: 77.0 Mitsubishi	12 V 2.2 kW B: 11.0 mm.



JS 1223	JS 1224	JS 1225
GR / 2 (1) 12 V 1.0 kW A: 74.0 B: 11.0 mm. MG, Toyota	GR / 2 (1) 12 V 1.0 kW A: 74.0 B: 14.0 mm. Toyota	GR / 2 (1) 12 V 1.7 kW A: 82.5 B: 43.0 mm. Nissan
JS 1226	JS 1227	JS 1229
DD / 2 (1) 12 V 0.7 kW A: 70.0 B: 12.5 mm. Nissan	GR / 2 (2) 12 V 2.2 kW A: 77.0 B: 9.0 mm. Mitsubishi	GR / 2 (0) 12 V 1.2 kW A: 74.0 B: 5.5 mm. Rover
JS 1230	JS 1231	JS 1233
GR / 2 (1) 12 V 0.8 kW A: 74.0 B: 16.0 mm. Toyota	GR / 2 (2) 12 V 1.4 kW A: 55.0 B: 18.5 mm. Toyota	GR / 2 (1) 12 V 0.8 kW A: 74.0 B: 14.5 mm. Toyota
JS 1234	JS 1235	JS 1236
GR / 2 (2) 12 V 2.0 kW A: 82.5 B: 25.5 mm. Hyundai, Kia	GR / 2 (0) 12 V 2.2 kW A: 72.5 B: 56.0 mm. Nissan	GR / 2 (1) 12 V 1.1 kW A: 74.0 B: 16.0 mm. Toyota



























<p><b>JS 1237</b></p>	<p><b>JS 1238</b></p>	<p><b>JS 1239</b></p>
		
<p>GR / 2 (2)      12 V    1.2 kW                      A: 74.0      B: 19.0 mm.                      Toyota</p>	<p>GR / 3 (2)      12 V    2.2 kW                      A: 88.0      B: 5.0 mm.                      Mazda</p>	<p>GR / 2 (0)      12 V    1.4 kW                      A: 95.0      B: 21.0 mm.                      John Deere, Thermo King</p>
 <p>9</p>	 <p>10</p>	 <p>15</p>
<p><b>JS 1295</b></p>	<p><b>JS 1296</b></p>	<p><b>JS 1298</b></p>
		
<p>GR / 2 (0)      12 V    1.7 kW                      A: 70.0      B: 54.0 mm.                      Nissan</p>	<p>GR / 3 (3)      12 V    2.3 kW                      A: 88.0      B: 5.0 mm.                      Mazda</p>	<p>GR / 3 (2)      12 V    2.2 kW                      A: 64.0      B: 4.0 mm.                      Kia</p>
 <p>12</p>	 <p>12</p>	 <p>10</p>
<p><b>JS 1299</b></p>	<p><b>JS 1300</b></p>	<p><b>JS 1301</b></p>
		
<p>DD / 2 (1)      12 V    0.7 kW                      A: 74.0      B: 11.0 mm.                      Toyota</p>	<p>DD / 2 (2)      12 V    0.9 kW                      A: 77.0      B: 10.5 mm.                      Mitsubishi</p>	<p>GR / 2 (0)      12 V    1.2 kW                      A: 70.0      B: 42.0 mm.                      Nissan</p>
 <p>8</p>	 <p>8</p>	 <p>8</p>
<p><b>JS 1302</b></p>	<p><b>JS 1303</b></p>	<p><b>JS 1304</b></p>
		
<p>GR / 2 (0)      12 V    1.2 kW                      A: 55.0      B: 66.0 mm.                      Toyota</p>	<p>DD / 2 (2)      12 V    0.8 kW                      A: 75.0      B: 13.0 mm.                      Hyundai, Kia</p>	<p>GR / 2 (2)      12 V    1.2 kW                      A: 77.0      B: 17.0 mm.                      Hyundai, Kia</p>
 <p>13</p>	 <p>8</p>	 <p>8</p>



JS 1305		JS 1306		JS 1307	
DD / 2 (1) A: 70.0 Nissan	12 V 0.7 kW B: 7.5 mm.	GR / 2 (0) A: 75.0 Nissan	12 V 1.4 kW B: 61.0 mm.	DD / 2 (1) A: 70.0 Nissan	12 V 0.7 kW B: 11.0 mm.
JS 1308		JS 1310		JS 1311	
GR / 2 (1) A: 74.0 Toyota	12 V 1.2 kW B: 12.0 mm.	DD/GR / 2 (2) A: 70.0 Suzuki	12 V 1.0 kW B: 29.0 mm.	DD / 2 (2) A: 77.0 Hyundai, Kia	12 V 0.9 kW B: 17.5 mm.
JS 1312		JS 1313		JS 1314	
DD / 2 (2) A: 77.0 Hyundai, Kia	12 V 0.9 kW B: 11.0 mm.	GR / 2 (2) A: 77.0 Hyundai, Mitsubishi	12 V 1.2 kW B: 9.5 mm.	GR / 2 (0) A: 75.0 Honda, Land Rover, Rover	12 V 1.7 kW B: 39.0 mm.
JS 1315		JS 1316		JS 1317	
GR / 2 (1) A: 70.0 Nissan	12 V 1.1 kW B: 8.0 mm.	GR / 2 (1) A: 74.0 Chrysler	12 V 1.2 kW B: 9.0 mm.	GR / 2 (0) B: 21.0 mm. Mazda	12 V 1.0 kW



















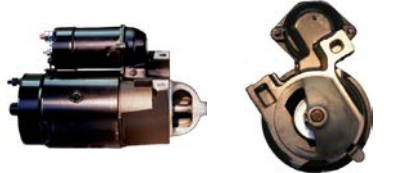





<p><b>JS 1318</b></p>  <p>GR / 2 (0)      12 V      1.4 kW                      A: 82.5      B: 56.0 mm.                      Nissan</p> 	<p><b>JS 1319</b></p>  <p>GR / 2 (2)      12 V      1.2 kW                      A: 70.0      B: 27.0 mm.                      Suzuki</p> 	<p><b>JS 1320</b></p>  <p>GR / 3 (0)      12 V      2.0 kW                      A: 55.0      B: 66.0 mm.                      Land Rover, MG, Rover</p> 
<p><b>JS 1321</b></p>  <p>GR / 2 (1)      12 V      2.0 kW                      A: 76.0      B: 21.0 mm.                      Land Rover, MG, Rover</p> 	<p><b>JS 1349</b></p>  <p>GR / 2 (2)      12 V      1.7 kW                      A: 82.5      B: 24.0 mm.                      Hyundai</p> 	<p><b>JS 1350</b></p>  <p>GR / 2 (0)      12 V      1.2 kW                      A: 75.0      B: 40.0 mm.                      Land Rover</p> 
<p><b>JS 1351</b></p>  <p>GR / 2 (2)      12 V      2.0 kW                      A: 77.0      B: 9.0 mm.                      Hyundai, Kia, Mitsubishi</p> 	<p><b>JS 1352</b></p>  <p>GR / 3 (3)      12 V      2.2 kW                      A: 81.5      B: 17.5 mm.                      Ford, Mazda</p> 	<p><b>JS 1353</b></p>  <p>GR / 2 (0)      12 V      1.0 kW                      A: 75.0      B: 32.0 mm.                      Honda</p> 
<p><b>JS 1354</b></p>  <p>GR / 3 (1)      24 V      3.2 kW                      A: 60.0      B: 16.0 mm.                      Mitsubishi</p> 	<p><b>JS 1355</b></p>  <p>GR / 2 (2)      12 V      2.2 kW                      A: 78.0      B: 19.5 mm.                      Hyundai, Kia</p> 	<p><b>JS 1356</b></p>  <p>DD / 2 (0)      12 V      0.9 kW                      A: 80.0      B: 13.0 mm.                      Yanmar</p> 



JS 1357	JS 1358	JS 1359
GR / 2 (1) A: 74.0 B: 14.0 mm. Toyota	GR / 2 (1) A: 74.0 B: 14.0 mm. Mini, Toyota	DD / 2 (0) A: 75.0 B: 44.5 mm. Mitsubishi, Smart (MCC)
12 V 1.4 kW	12 V 2.0 kW	12 V 0.9 kW
JS 1360	JS 1361	JS 1362
DD / 2 (0) A: 75.0 B: 33.5 mm. Honda	GR / 2 (2) A: 74.0 B: 15.0 mm. Mazda	GR / 2 (1) A: 74.0 B: 15.5 mm. Toyota
12 V 0.8 kW	12 V 1.0 kW	12 V 1.3 kW
JS 1363	JS 1364	JS 1365
GR / 2 (0) A: 55.0 B: 66.0 mm. Toyota	DD / 2 (1) A: 70.0 B: 33.0 mm. Honda	GR / 2 (2) A: 77.0 B: 15.5 mm. Hyundai, Kia
12 V 1.6 kW	12 V 0.7 kW	12 V 1.7 kW
JS 1366	JS 1367	JS 1368*
GR / 2 (0) A: 65.0 B: 48.0 mm. Subaru	GR / 4 (4) A: 70.0 B: 18.5 mm. Nissan	GR / 3 (0) B: 7.0 mm. Citroen, Peugeot
12 V 1.0 kW	12 V 1.0 kW	12 V 2.2 kW





<p><b>JS 1369</b></p>	<p><b>JS 1370</b></p>	<p><b>US 810#</b></p>
		
<p>GR / 2 (1)      12 V    2.0 kW                      A: 74.0      B: 24.0 mm.                      Lexus, Toyota</p> <p style="text-align: right;"> 11</p>	<p>GR / 2 (2)      12 V    1.2 kW                      A: 77.0      B: 9.5 mm.                      Hyundai, Kia</p> <p style="text-align: right;"> 8</p>	<p>DD / 2 (0)      12 V                      Buick, Chevrolet, GMC, Oldsmobile, Pontiac</p> <p style="text-align: right;"> 9</p>
<p><b>US 815#</b></p>	<p><b>US 818</b></p>	<p><b>US 835#</b></p>
		
<p>DD / 3 (0)      12 V    2.5 kW                      A: 89.0      B: 20.0 mm.                      Clark</p> <p style="text-align: right;"> 10</p>	<p>DD / 2 (0)      12 V    1.5 kW                      A: 82.5      B: 7.0 mm.                      Buick, Cadillac, Chevrolet, GMC, Jeep, Oldsmobile, Pontiac</p> <p style="text-align: right;"> 9</p>	<p>DD / 3 (0)      12 V                      A: 89.0      B: 47.0 mm.                      Hyster  <i>Oil sealed</i></p> <p style="text-align: right;"> 10</p>
<p><b>US 845#</b></p>	<p><b>US 851</b></p>	<p><b>US 857</b></p>
		
<p>GR / 3 (0)      12 V    2.5 kW                      A: 89.0      B: 45.5 mm.                      Bobcat, Ford</p> <p style="text-align: right;"> 10,13</p>	<p>DD / 2 (0)      12 V                      B: 10.0 mm.                      Briggs &amp; Stratton</p> <p style="text-align: right;"> 16</p>	<p>DD/GR / 15 / 3 (0)      24 V    4.5 kW                      A: 89.0      B: 47.0 mm.                      Case, Cummins</p> <p style="text-align: right;"> 10</p>
<p><b>US 858</b></p>	<p><b>US 863</b></p>	<p><b>US 864</b></p>
		
<p>DD / 2 (0)      12 V                      A: 68.0      B: 13.0 mm.                      Chevrolet, GMC, Isuzu, Jeep, Oldsmobile, Pontiac</p> <p style="text-align: right;"> 9</p>	<p>DD / 3 (0)      24 V                      A: 92.0      B: 46.0 mm.                      Caterpillar</p> <p style="text-align: right;"> 12</p>	<p>DD / 3 (0)      24 V                      A: 92.0      B: 47.0 mm.                      Caterpillar</p> <p style="text-align: right;"> 11</p>



US 970			US 1028			US 1240		
<b>GR / 2 (0)</b> A: 82.5    B: 8.0 mm. Chevrolet, GMC	<b>12 V</b>	<b>2.5 kW</b>	<b>DD/GR / 2 (0)</b> A: 104.0    B: 16.0 mm. Ford	<b>12 V</b>	<b>1.4 kW</b>	<b>GR / 15 / 2 (0)</b> A: 62.0    B: 19.0 mm. Mercury	<b>12 V</b>	<b>1.4 kW</b>

US 1245#		
<b>GR / 3 (3)</b> A: 89.0    B: 48.5 mm. ERF, Foden, Seddon	<b>24 V</b>	<b>4.5 kW</b>



**DC 1011**



**12 V 11 Amp. 0.9 kW**  
O.E. 0010 300 006, -100





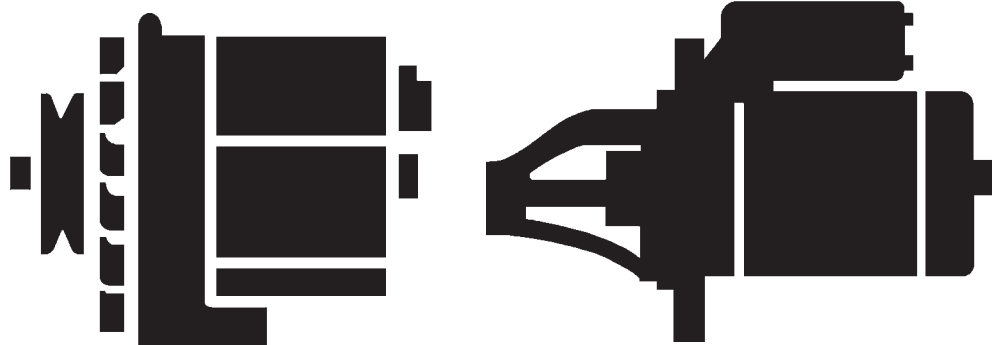

D

**ANWENDUNGSLISTE**

DK

**VOGNLISTE**

E

**APLICACIÓN EN VEHICULOS**

F

**AFFECTATIONS PAR VÉHICULE**

GB

**VEHICLE APPLICATION**

FI

**AUTOMERKKIERITTELY**

I

**APPLICAZIONE PER VEICOLI**

NL

**TOEPASSINGEN WAGENMERKEN**

PL

**ZASTOSOWANIE W POJAZDACH**

S

**REKOMMENDATIONSTABELL**





Acura						
PASSENGER CARS US						
CL 2.2	[F22B1]				01.97-	JS1151 12 1.4
CL 2.3	[F23A1]				01.98- 01.99	JS1151 12 1.4
Integra 1.6 LS	[D16A1]				01.86- 01.89	JS645 12 1.4
Integra 1.6 LS Special Edition	[D16A1]				01.87-	JS645 12 1.4
Integra 1.6 RS	[D16A1]				01.86- 01.89	JS645 12 1.4
Integra 1.6 SE	[D16A1]				01.88-	JS645 12 1.4
Integra 1.8 GS	[B18A1]	01.90- 01.91	JA1272IR	14 70		
Integra 1.8 LS	[B18A1]	01.90- 01.91	JA1272IR	14 70		
Integra 1.8 RS	[B18A1]	01.90- 01.91	JA1272IR	14 70		
Legend 2.5	[C25A1]	01.86- 01.87	JA555IR#	14 70		
Legend 2.5 L	[C25A1]	01.87-	JA555IR#	14 70		
Legend 2.7	[C27A1]	01.87- 01.90	JA555IR#	14 70		
Legend 2.7 L	[C27A1]	01.87- 01.90	JA555IR#	14 70		
Legend 2.7 LS	[C27A1]	01.87- 01.90	JA555IR#	14 70		
Alxam						
PASSENGER CARS EU						
400 0.05		01.00-	JA971IR	14 35		
Alfa Romeo						
PASSENGER CARS EU						
159 2.0 JTDM	[939B3.000]	05.09-	CA2049IR*	14 100		
		A13 05.09-	CA2050IR*	14 120		
		A13 06.10-	CA2050IR*	14 120		
		06.10-	CA2049IR*	14 100		
1750 1.8 Berlina	[AR00548]				03.68- 10.72	CS180 12 0.8
2000 2.0	[AR10520]	10.71- 12.83	CA511IR	14 65	10.71- 12.83	CS180 12 0.8
Alfa 145 1.4 i.e. 16V	[AR33503]	ACPS 12.96- 01.01	CA1216IR	14 85	12.96- 03.97	CS1042 12 1.4
		ACPS 12.96- 01.01	CA1223IR	14 100	03.97- 02.99	CS1053 12 1.1
	[AR38501]	ACPS 12.96- 01.01	CA1216IR	14 85	12.96-	CS1053 12 1.1
		ACPS 12.96- 01.01	CA1223IR	14 100		
Alfa 145 1.4 i.e.	[AR33501]				04.94- 12.96	CS131 12 0.8
Alfa 145 1.6 i.e. 16V	[AR38201]	12.96- 01.01	CA1159IR	14 85	12.96- 01.01	CS1053 12 1.1
		12.96-	CA1223IR	14 100	12.96-	CS1042 12 1.4
	[AR67601]	12.96- 02.99	CA1223IR	14 100	03.97- 02.99	CS1053 12 1.1
		AC 12.96- 02.99	CA1159IR	14 85	12.96- 02.99	CS1042 12 1.4
Alfa 145 1.6 i.e.	[AR33201]	AC 10.94- 12.96	CA1208IR	14 95	04.94- 12.96	CS131 12 0.8
Alfa 145 1.7 i.e. 16V	[AR33401]				04.94- 12.96	CS687 12 1.1
Alfa 145 1.8 i.e. 16V	[AR32201]	03.98-	CA1216IR	14 85	03.98- 12.00	CS1053 12 1.1
		AC 03.98- 12.00	CA1223IR	14 100		
	[AR38401]	12.96-	CA1216IR	14 85	12.96-	CS1042 12 1.4
		12.96- 12.98	CA1223IR	14 100	12.96- 12.98	CS1053 12 1.1
	[AR67106]	ACPS 12.96- 04.98	CA1216IR	14 85	12.96- 04.98	CS1042 12 1.4
		AC 12.96- 04.98	CA1223IR	14 100	12.96- 04.98	CS1053 12 1.1
Alfa 145 1.9 JTD	[AR32302]	AC 02.99- 01.01	CA1558IR	14 100	02.99- 01.01	CS1045 12 2.0
Alfa 145 1.9 TD	[AR33601]	11.96- 05.98	CA1055IR	14 70	11.96- 05.98	CS709 12 2.2
		AC 11.96- 05.98	CA644IR	14 90		
	[AR67501]	04.94- 11.96	CA1055IR	14 70	04.94- 11.96	CS709 12 2.2
		AC 04.94- 11.96	CA644IR	14 90		
Alfa 145 2.0 16V	[AR32301]	03.98- 01.01	CA1223IR	14 100	03.98- 01.01	CS1053 12 1.1
Alfa 145 2.0 Twin Spark i.e. 16V	[AR67204]	10.94- 10.01	CA1208IR	14 95	10.94- 10.01	CS1042 12 1.4
		AC 10.94- 10.01	CA1208IR	14 95		
Alfa 146 1.4 i.e. 16V	[AR33503]	11.96- 01.01	CA1216IR	14 85	12.96- 03.97	CS1042 12 1.4
		11.96- 01.01	CA1223IR	14 100	03.97- 02.99	CS1053 12 1.1
		ACPS 11.96- 01.01	CA1216IR	14 85		
		ACPS 11.96- 01.01	CA1223IR	14 100		
	[AR38501]	12.96-	CA1216IR	14 85	11.96- 01.01	CS1042 12 1.4
		AC 11.96- 01.01	CA1223IR	14 100	12.96-	CS1053 12 1.1
Alfa 146 1.4 i.e.	[AR33501]				12.94- 11.96	CS131 12 0.8
Alfa 146 1.6 i.e. 16V	[AR38201]	11.96- 01.01	CA1223IR	14 100	12.96-	CS1053 12 1.1
		12.96-	CA1159IR	14 85		
	[AR67601]	11.96- 02.99	CA1223IR	14 100	11.96- 02.99	CS1042 12 1.4
		AC 11.96- 02.99	CA1159IR	14 85	11.96- 02.99	CS1053 12 1.1
Alfa 146 1.6 i.e.	[AR33201]	AC 05.95- 11.96	CA1208IR	14 95	05.95- 11.96	CS131 12 0.8
					05.95- 11.96	CS687 12 1.1
Alfa 146 1.7 i.e. 16V	[AR33401]				12.94- 12.96	CS687 12 1.1
Alfa 146 1.8 i.e. 16V	[AR38401]	11.96- 01.01	CA1159IR	14 85	12.96-	CS1042 12 1.4
		11.96- 01.01	CA1216IR	14 85	11.96- 01.01	CS1053 12 1.1
		12.96-	CA1223IR	14 100		
	[AR67106]	11.96- 01.01	CA1159IR	14 85	01.97- 04.98	CS1053 12 1.1
		11.96- 04.98	CA1223IR	14 100	01.97- 04.98	CS1042 12 1.4
Alfa 146 1.8 Twin Spark i.e. 16V	[AR32201]	05.98- 12.00	CA1216IR	14 85	05.98- 12.00	CS1053 12 1.1
		05.98- 12.00	CA1223IR	14 100		
		ACPS 05.98- 12.00	CA1216IR	14 85		
		ACPS 05.98- 12.00	CA1223IR	14 100		
Alfa 146 1.9 JTD	[AR32302]	AC 02.99- 01.01	CA1558IR	14 100	02.99- 01.01	CS1045 12 2.0
Alfa 146 1.9 TD	[AR33601]	12.94- 05.98	CA1055IR	14 70	10.94- 05.98	CS709 12 2.2
		AC 11.96- 05.98	CA644IR	14 90		
	[AR67501]	12.94- 05.98	CA1055IR	14 70	10.94- 05.98	CS709 12 2.2
		AC 11.96- 05.98	CA644IR	14 90		
Alfa 146 2.0 16V	[AR32301]	03.98- 01.01	CA1223IR	14 100	03.98- 01.01	CS1053 12 1.1
Alfa 146 2.0 Twin Spark 16V	[AR67204]	10.94- 10.01	CA1208IR	14 95	10.94- 10.01	CS1042 12 1.4
		10.95- 10.01	CA1223IR	14 100		
		AC 10.94- 10.01	CA1208IR	14 95		
Alfa 147 1.6 Twin Spark 16V	[AR32104]	AC 11.00-	CA1223IR	14 100	01.01-	CS1053 12 1.1
		AC 01.01-	CA1743IR	14 90		
	[AR37203]	AC 11.00-	CA1223IR	14 100	11.00-	CS1053 12 1.1
		AC 01.01-	CA1743IR	14 90		
Alfa 147 1.9 JTD 16V	[192A5.000]	11.02-	CA1698IR	14 120	11.02- 03.05	CS1335 12 2.2
		07.03-	CA1558IR	14 100	04.05-	CS1045 12 2.0
	[192B1.000]	03.05-	CA1558IR	14 100	09.02-	CS1335 12 2.2
	[937A4.000]	09.02-	CA1558IR	14 100	04.05-	CS1045 12 2.0
					09.02- 04.05	CS1335 12 2.2
Alfa 147 1.9 JTD	[182B9.000]	06.03-	CA1698IR	14 120	06.03-	CS1335 12 2.2
	[937A2.000]	11.00-	CA1558IR	14 100	11.00- 05.02	CS1045 12 2.0
		11.00-	CA1698IR	14 120	05.02-	CS1264 12 1.7
Alfa 147 1.9 JTDM 16V	[937A5.000]	07.05-	CA1558IR	14 100	07.05-	CS1045 12 2.0
	[939A7.000]	10.04- 03.10	CA1558IR	14 100	10.04- 03.10	CS1264 12 1.7
Alfa 147 1.9 JTDM 8V	[937A3.000]	07.05-	CA1558IR	14 100	07.05-	CS1264 12 1.7
Alfa 147 1.9 JTDM	[937A6.000]	06.08-	CA1558IR	14 100	06.08-	CS1045 12 2.0
Alfa 147 2.0 Twin Spark 16V	[AR32310]	Eng. -2835764 01.01-	CA1223IR	14 100	01.01-	CS1053 12 1.1
		Eng. 2835764- 01.01-	CA1743IR	14 90		
Alfa 147 3.2 GTA	[932A.000]	02.03-	CA1688IR	14 120	02.03-	CS585 12 1.4



Alfa 155 1.6 Twin Spark	[AR67601]	AC 05.96- 10.97	CA1208IR	14 95	05.96- 10.97	CS1053	12 1.1
		AC 05.96- 10.97	CA1223IR	14 100	05.96- 10.97	CS1042	12 1.4
Alfa 155 1.7 Twin Spark 16V	[AR67106]	AC 05.96- 12.97	CA1216IR	14 85	05.96- 12.97	CS585	12 1.4
		AC 05.96- 12.97	CA1223IR	14 100			
Alfa 155 1.7 Twin Spark	[AR67103]	04.93- 04.96	CA737IR	14 80	04.93- 04.96	CS585	12 1.4
	[AR67105]	04.93- 04.96	CA737IR	14 80	04.93- 04.96	CS585	12 1.4
Alfa 155 1.8 Twin Spark	[AR67101]	02.92- 04.96	CA737IR	14 80	02.92- 04.96	CS585	12 1.4
	[AR67102]	02.92- 04.96	CA737IR	14 80	02.92- 04.96	CS585	12 1.4
	[AR67402]	02.92- 04.96	CA737IR	14 80	02.92- 12.97	CS585	12 1.4
		05.96- 12.97	CA1216IR	14 85			
		AC 05.96- 12.97	CA1223IR	14 100			
Alfa 155 1.9 TD	[AR67501]	04.93- 04.96	CA1055IR	14 70	04.93- 04.96	CS709	12 2.2
		04.93- 04.96	CA1061IR#	14 80			
		04.93- 04.96	CA644IR	14 90			
Alfa 155 2.0 Turbo 16V 4x4	[AR67203]	ACPS 03.93- 04.96	CA1233IR	14 100	01.95- 04.96	CS584	12 1.4
Alfa 155 2.0 Turbo 16V Q4	[AR67203]	ACPS 03.93- 04.96	CA1233IR	14 100	01.95- 04.96	CS584	12 1.4
Alfa 155 2.0 Twin Spark 16V	[AR67204]	12.95- 12.97	CA1208IR	14 95	03.95- 04.96	CS585	12 1.4
Alfa 155 2.0 Twin Spark	[AR67201]	02.92- 04.93	CA737IR	14 80	02.92- 04.93	CS585	12 1.4
	[AR67202]	04.93- 02.95	CA737IR	14 80	04.93- 02.95	CS585	12 1.4
Alfa 155 2.5 V6	[AR67301]				02.92- 04.96	CS585	12 1.4
	[AR67302]				05.96- 10.97	CS585	12 1.4
	[AR67303]				05.96- 10.97	CS585	12 1.4
Alfa 155 2.5 TD	[VM07B]	04.93- 04.96	CA1061IR#	14 80	04.93- 04.96	CS611	12 2.2
	[VM31B]	04.93- 12.97	CA1061IR#	14 80	04.93- 12.97	CS611	12 2.2
Alfa 156 1.6 Twin Spark 16V	[AR32102]	09.97- 05.06	CA1216IR	14 85	04.98- 09.00	CS1053	12 1.1
		AC 04.98- 09.00	CA1223IR	14 100			
		AC 04.98- 09.00	CA1743IR	14 90			
	[AR32103]	AC 09.00- 05.06	CA1223IR	14 100	09.00- 12.01	CS1053	12 1.1
		AC 09.00- 05.06	CA1743IR	14 90			
	[AR32104]	AC 08.00- 05.06	CA1223IR	14 100	08.00- 05.06	CS1053	12 1.1
		AC 08.00- 05.06	CA1743IR	14 90			
	[AR67601]	05.00- 05.06	CA1216IR	14 85	09.97- 05.06	CS1053	12 1.1
		AC 09.97- 09.00	CA1223IR	14 100			
		AC 10.97- 05.00	CA1743IR	14 90			
Alfa 156 1.8 Twin Spark 16V	[AR32201]	09.97- 10.00	CA1216IR	14 85	09.97- 10.00	CS1053	12 1.1
		09.97- 10.00	CA1223IR	14 100			
		ACPS 09.97- 10.00	CA1223IR	14 100			
		AC 05.00- 10.00	CA1223IR	14 100			
	[AR32205]	Eng.-2835764 10.00- 05.06	CA1223IR	14 100	10.00- 05.06	CS1053	12 1.1
	Eng. 2835764- 10.00- 05.06	CA1743IR	14 90				
Alfa 156 1.9 JTD 16V	[192A5.000]	11.02- 05.06	CA1698IR	14 120	11.02- 05.06	CS1335	12 2.2
Alfa 156 1.9 JTD 16V Q4	[937A5.000]	07.04- 05.06	CA1698IR	14 120	07.04- 05.06	CS1335	12 2.2
		07.04- 05.06	CA2062IR*	14 140			
Alfa 156 1.9 JTD	[937A2.000]	05.01- 05.06	CA1698IR	14 120	05.01- 05.06	CS1045	12 2.0
					05.01- 05.06	CS1264	12 1.7
					09.97- 10.00	CS1045	12 2.0
	[AR32302]	09.97- 10.00	CA1223IR	14 100			
		09.97- 10.00	CA1558IR	14 100			
	[AR37101]		10.00- 12.01	CA1558IR	14 100	10.00- 12.01	CS1045
Alfa 156 2.0 JTS	[937A1.000]	03.02- 05.06	CA1743IR	14 90	03.02- 05.06	CS1053	12 1.1
Alfa 156 2.0 Twin Spark 16V	[AR32301]	09.97- 10.00	CA1216IR	14 85	09.97- 10.00	CS1053	12 1.1
		09.97- 10.00	CA1223IR	14 100			
	[AR32310]	10.00- 03.02	CA1223IR	14 100	10.00- 03.02	CS1053	12 1.1
		10.00- 03.02	CA1743IR	14 90			
Alfa 156 2.4 JTD	[839A6.000]	AC 10.00- 05.06	CA1223IR	14 100	10.00- 05.06	CS1335	12 2.2 BO
		03.02- 05.06	CA1698IR	14 120	10.00- 05.06	CS1124	12 2.2 MA
		10.03- 05.06	CA1698IR	14 120	03.02- 05.06	CS1335	12 2.2
		09.97- 10.00	CA1223IR	14 100	10.03- 05.06	CS1335	12 2.2
		09.97- 10.00	CA1452IR	14 120	09.97- 10.00	CS1124	12 2.2
		09.97- 10.00	CA1452IR	14 120	05.00- 10.00	CS1335	12 2.2
		AC 05.00- 10.00	CA1452IR	14 120			
Alfa 156 2.5 V6 24V	[AR32401]	09.97- 10.00	CA1492IR	14 120	10.97- 10.00	CS585	12 1.4
	[AR32405]	10.00- 05.06	CA1688IR	14 120	10.00- 05.06	CS585	12 1.4
Alfa 156 3.2 GTA	[932A.000]	03.02- 05.06	CA1688IR	14 120	03.02- 05.06	CS585	12 1.4
Alfa 159 1.8 MPi	[939A4.000]	03.07-	CA1833IR	14 120	03.07-	CS1438	12 1.1
Alfa 159 1.9 JTS	[939A6.000]				09.05-	CS1461*	12
Alfa 159 1.9 JTDM 16V	[937A8.000]	09.05-	CA1885IR	14 120	09.05-	CS1264	12 1.7
		09.05-	CA2050IR*	14 120	09.05-	CS1045	12 2.0
		03.06-	CA1995IR	14 140			
		03.06-	CA2049IR*	14 100			
	[939A2.000]	09.05-	CA1885IR	14 120	09.05-	CS1045	12 2.0
		09.05-	CA1995IR	14 140			
		09.05-	CA2049IR*	14 100			
	[939A8.000]	09.05-	CA2050IR*	14 120			
		09.05-	CA1885IR	14 120	09.05-	CS1045	12 2.0
		09.05-	CA1995IR	14 140	09.05-	CS1264	12 1.7
Alfa 159 1.9 JTDM 8V	[937A7.000]	03.06-	CA1885IR	14 120	03.05-	CS1335	12 2.2
		03.06-	CA1995IR	14 140	03.05-	CS1264	12 1.7
		03.06-	CA2050IR*	14 120			
	[939A1.000]	09.05-	CA1885IR	14 120	06.05-	CS1264	12 1.7
		03.06- 12.08	CA2049IR*	14 100			
		03.06-	CA2050IR*	14 120			
		CA1995IR	14 140				
[939A7.000]	A13 06.05- 05.07	CA1995IR	14 140				
				09.05-	CS1045	12 2.0	
				09.05-	CS1264	12 1.7	
Alfa 159 2.2 JTS	[939A5.000]				09.05-	CS1461*	12
Alfa 159 2.4 JTDM	[939A3.000]	09.05-	CA2016IR	14 150	06.05-	CS1335	12 2.2
	[939A9.000]	05.07-	CA2016IR	14 150	05.07-	CS1335	12 2.2
Alfa 159 2.4 JTDM Q4	[939A9.000]	05.07-	CA2016IR	14 150	05.07-	CS1335	12 2.2
Alfa 164 2.0	[AR06416]	11.87- 10.92	CA737IR	14 80	06.87- 10.92	CS585	12 1.4
Alfa 164 2.0 Turbo V6	[AR64101]				03.91- 09.92	CS585	12 1.4
	[AR64102]				09.92-	CS585	12 1.4
Alfa 164 2.0 Turbo	[AR06476]	01.88- 10.92	CA569IR	14 85	01.88- 10.92	CS514	12 1.4
	[AR64102]				07.90- 10.92	CS585	12 1.4
Alfa 164 2.0 Twin Spark	[AR06416]	11.90- 09.92	CA737IR	14 80	06.87- 09.92	CS585	12 1.4
	[AR06420]	11.90- 09.92	CA737IR	14 80	06.87- 09.92	CS585	12 1.4
	[AR64103]	09.92- 10.98	CA737IR	14 80	09.92- 10.98	CS585	12 1.4
Alfa 164 2.5 V6	[AR66201]				09.92- 09.98	CS585	12 1.4
Alfa 164 2.5 TD	[VM08B]	09.92- 10.98	CA1061IR#	14 80	09.92- 10.98	CS611	12 2.2
	[VM32B]	09.92- 10.98	CA1061IR#	14 80	09.92- 10.98	CS611	12 2.2
	[VM84A]				06.87- 09.92	CS611	12 2.2



**ALFA ROMEO** *Continued*

Alfa 164 3.0	[AR06410]				11.87- 09.91	<b>CS585</b>	12	1.4
	[AR64301]				02.88- 10.92	<b>CS585</b>	12	1.4
	[AR64304]				04.93- 02.95	<b>CS585</b>	12	1.4
	[AR64308]				04.93- 02.95	<b>CS585</b>	12	1.4
	[AR66302]				03.95- 10.97	<b>CS585</b>	12	1.4
Alfa 164 3.0 4x4	[AR64307]				11.92- 10.97	<b>CS585</b>	12	1.4
Alfa 164 3.0 24V QV	[AR64304]				09.92- 09.98	<b>CS585</b>	12	1.4
	[AR64307]				02.94- 09.98	<b>CS585</b>	12	1.4
	[AR64308]				09.92- 09.98	<b>CS585</b>	12	1.4
Alfa 164 3.0 24V	[AR66301]				09.92- 09.98	<b>CS585</b>	12	1.4
	[AR66302]				09.92- 09.98	<b>CS585</b>	12	1.4
Alfa 164 3.0 i.e. QV	[AR06430]				09.90- 09.92	<b>CS585</b>	12	1.4
	[AR64301]				09.90- 09.92	<b>CS585</b>	12	1.4
Alfa 164 3.0 V6	[AR06410]				06.87- 09.92	<b>CS585</b>	12	1.4
	[AR06412]				04.88- 09.92	<b>CS585</b>	12	1.4
	[AR66303]				09.92- 09.98	<b>CS585</b>	12	1.4
	[AR66305]				09.92- 09.98	<b>CS585</b>	12	1.4
Alfa 166 2.0 Twin Spark	[AR34103]	09.98- 10.00	CA1223IR	14 100	09.98- 10.00	<b>CS1042</b>	12	1.4
		10.99- 10.00	CA1743IR	14 90		<b>CS585</b>	12	1.4
	[AR36301]	Eng. -2835764 10.00-	CA1223IR	14 100	10.00-	<b>CS1042</b>	12	1.4
		Eng. 2835764- 10.00-	CA1743IR	14 90				
Alfa 166 2.0 V6	[AR34102]	09.98-	CA1492IR	14 120	09.98-	<b>CS585</b>	12	1.4
Alfa 166 2.4	[841G.000]	10.03-	CA1698IR	14 120	10.03-	<b>CS1335</b>	12	2.2
	[841H.000]	10.03-	CA1698IR	14 120	10.03-	<b>CS1335</b>	12	2.2
Alfa 166 2.4 JTD	[839A6.000]	AC 10.00-	CA1223IR	14 100	10.00-	<b>CS1335</b>	12	2.2
	[841C.000]				09.00-	<b>CS1335</b>	12	2.2
	[841M.000]	07.05-	CA1223IR	14 100	07.05-	<b>CS1335</b>	12	2.2
	[936B.000]	07.05-	CA1223IR	14 100	07.05-	<b>CS1335</b>	12	2.2
	[AR34202]	09.98- 10.00	CA1223IR	14 100	09.98- 10.00	<b>CS1124</b>	12	2.2
Alfa 166 2.5 V6 24V	[AR34201]	09.98- 09.00	CA1492IR	14 120	09.98- 09.00	<b>CS585</b>	12	1.4
	[AR36201]	10.00-	CA1688IR	14 120	10.00-	<b>CS585</b>	12	1.4
Alfa 166 3.0 V6 24V	[AR34301]	09.98- 10.00	CA1492IR	14 120	09.98- 10.00	<b>CS585</b>	12	1.4
	[AR36101]	10.00-	CA1688IR	14 120	10.00-	<b>CS585</b>	12	1.4
Alfa 166 3.2 V6 24V	[936A.000]	10.03-	CA1688IR	14 120	06.03-	<b>CS585</b>	12	1.4
Alfa 33 1.2	[AR30585]	06.83- 03.88	CA235IR#	14 45	06.83- 03.88	<b>CS131</b>	12	0.8
	[AR30743]	01.90- 08.91	CA593IR	14 65	01.90- 08.91	<b>CS131</b>	12	0.8
Alfa 33 1.3	[AR30168]	10.84- 03.88	CA235IR#	14 45	10.84- 03.88	<b>CS131</b>	12	0.8
	[AR30502]	06.83- 03.88	CA235IR#	14 45	06.83- 03.88	<b>CS131</b>	12	0.8
	[AR30586]	04.88- 12.89	CA593IR	14 65	04.88- 12.89	<b>CS131</b>	12	0.8
	[AR30587]	04.88- 12.89	CA593IR	14 65	04.88- 12.89	<b>CS131</b>	12	0.8
	[AR30732]	02.90- 10.94	CA593IR	14 65	02.90- 10.94	<b>CS131</b>	12	0.8
Alfa 33 1.4	[AR30502]	06.83- 03.88	CA235IR#	14 45	06.83- 03.88	<b>CS131</b>	12	0.8
	[AR30586]				04.88- 12.89	<b>CS131</b>	12	0.8
		06.83- 12.89	CA235IR#	14 45	06.83- 12.89	<b>CS131</b>	12	0.8
Alfa 33 1.4 i.e.	[AR30753]	09.91- 10.94	CA593IR	14 65	09.91- 10.94	<b>CS131</b>	12	0.8
	[AR30755]	09.91- 12.91	CA593IR	14 65	09.91- 12.91	<b>CS131</b>	12	0.8
Alfa 33 1.4 i.e. 4x4	[AR30587]	06.91- 09.94	CA593IR	14 65	06.91- 09.94	<b>CS131</b>	12	0.8
	[AR30755]	06.91- 09.94	CA593IR	14 65	06.91- 09.94	<b>CS131</b>	12	0.8
Alfa 33 1.5	[AR30143]	06.83- 12.85	CA235IR#	14 45	06.83- 12.85	<b>CS131</b>	12	0.8
	[AR30146]	12.86- 12.89	CA235IR#	14 45	12.86- 12.89	<b>CS131</b>	12	0.8
		12.86- 12.89	CA593IR	14 65				
	[AR30182]	01.82- 12.93	CA235IR#	14 45	01.82- 12.93	<b>CS131</b>	12	0.8
		09.86- 12.93	CA593IR	14 65				
	[AR30504]	06.83- 12.85	CA235IR#	14 45	06.83- 12.85	<b>CS131</b>	12	0.8
	[AR30508]	03.88- 12.89	CA235IR#	14 45	03.88- 12.89	<b>CS131</b>	12	0.8
		03.88- 12.89	CA593IR	14 65				
	[AR30514]	09.84- 12.87	CA235IR#	14 45	09.84- 12.87	<b>CS131</b>	12	0.8
		09.86- 12.87	CA593IR	14 65				
	[AR30520]	09.84- 12.86	CA235IR#	14 45	09.84- 12.86	<b>CS131</b>	12	0.8
	[AR30588]	07.86- 12.89	CA235IR#	14 45	07.86- 12.89	<b>CS131</b>	12	0.8
		07.86- 12.89	CA593IR	14 65				
	[AR30734]				01.90- 04.93	<b>CS687</b>	12	1.1
	[AR30751]	01.90- 09.94	CA593IR	14 65	01.90- 09.94	<b>CS131</b>	12	0.8
Alfa 33 1.5 4x4	[AR30146]	09.86- 12.89	CA235IR#	14 45	09.86- 12.89	<b>CS131</b>	12	0.8
		09.86- 12.89	CA593IR	14 65				
	[AR30182]	09.84- 12.87	CA235IR#	14 45	09.84- 12.87	<b>CS131</b>	12	0.8
		09.86- 12.87	CA593IR	14 65				
	[AR30504]	11.83- 12.84	CA235IR#	14 45	11.83- 12.84	<b>CS131</b>	12	0.8
	[AR30508]	03.88- 12.89	CA235IR#	14 45	03.88- 12.89	<b>CS131</b>	12	0.8
		03.88- 12.89	CA593IR	14 65				
	[AR30514]	01.84- 12.89	CA235IR#	14 45	01.84- 12.89	<b>CS131</b>	12	0.8
		01.84- 12.89	CA593IR	14 65				
	[AR30520]	09.84- 12.86	CA593IR	14 65	01.85- 09.86	<b>CS131</b>	12	0.8
		01.85- 09.86	CA235IR#	14 45				
	[AR30588]	09.86- 12.89	CA235IR#	14 45	09.86- 12.89	<b>CS131</b>	12	0.8
		09.86- 12.89	CA593IR	14 65				
Alfa 33 1.5 i.e.	[AR30750]	07.90- 08.91	CA235IR#	14 45	07.90- 08.91	<b>CS131</b>	12	0.8
		07.90- 08.91	CA593IR	14 65				
	[AR30751]	01.90- 09.94	CA593IR	14 65	01.90- 09.94	<b>CS131</b>	12	0.8
Alfa 33 1.5 QV	[AR30146]	06.84- 12.89	CA235IR#	14 45	06.84- 12.89	<b>CS131</b>	12	0.8
		09.86- 12.89	CA593IR	14 65				
	[AR30508]	03.88- 12.89	CA235IR#	14 45	03.88- 12.89	<b>CS131</b>	12	0.8
		03.88- 12.89	CA593IR	14 65				
	[AR30588]	07.87- 12.89	CA593IR	14 65	07.87- 12.89	<b>CS131</b>	12	0.8
Alfa 33 1.7	[AR30550]	10.87- 12.89	CA593IR	14 65	03.88- 12.89	<b>CS131</b>	12	0.8
Alfa 33 1.7 16V	[AR30746]	01.90- 03.92	CA593IR	14 65	01.90- 03.92	<b>CS687</b>	12	1.1
					01.90- 10.90	<b>CS131</b>	12	0.8
	[AR30747]	01.90- 10.94	CA593IR	14 65	01.90- 10.94	<b>CS687</b>	12	1.1
					01.90- 10.90	<b>CS131</b>	12	0.8
Alfa 33 1.7 16V 4x4	[AR30746]	01.90- 03.92	CA593IR	14 65	01.90- 03.92	<b>CS687</b>	12	1.1
	[AR30747]	01.90- 10.94	CA593IR	14 65	01.90- 10.94	<b>CS687</b>	12	1.1
Alfa 33 1.7 i.e.	[AR30558]	10.87- 12.89	CA593IR	14 65	10.87- 12.89	<b>CS131</b>	12	0.8
					09.88- 12.89	<b>CS687</b>	12	1.1
	[AR30736]	01.90- 03.92	CA593IR	14 65	01.90- 03.92	<b>CS687</b>	12	1.1
	[AR30737]	01.90- 09.94	CA593IR	14 65	01.90- 09.94	<b>CS687</b>	12	1.1
	[AR30737A]	04.92- 09.94	CA593IR	14 65	05.85- 09.94	<b>CS687</b>	12	1.1
Alfa 33 1.7 i.e. 4x4	[AR30558]	10.87- 12.89	CA593IR	14 65	10.87- 12.89	<b>CS131</b>	12	0.8
					10.87- 12.89	<b>CS687</b>	12	1.1
	[AR30736]	01.90- 03.92	CA593IR	14 65	01.90- 03.92	<b>CS687</b>	12	1.1
	[AR30737]	01.90- 03.92	CA593IR	14 65	01.90- 03.92	<b>CS687</b>	12	1.1
Alfa 33 1.8 TD	[VM82A]	09.86- 12.89	CA355IR	14 65	09.86- 12.89	<b>CS611</b>	12	2.2
	[VM96A]	07.90- 09.94	CA506IR	14 65	07.90- 09.94	<b>CS611</b>	12	2.2
		07.90- 09.94	CA631IR	14 55				
	[VW82A]	03.88- 12.89	CA355IR	14 65	03.88- 12.89	<b>CS611</b>	12	2.2





Alfa 6 2.0	[AR01932]	07.81- 12.86	CA5111R	14 65		
Alfa 6 2.5 i.e.	[AR01928]	04.79- 12.86	CA5111R	14 65		
Alfa 6 2.5 TD	[VM-HR588HT]	07.81- 05.86	CA3161R	14 55		
Alfa 75 1.6	[AR06100]	05.85- 09.89	CA3001R	14 55	05.85- 09.89	CS180 12 0.8
	[AR61101]	05.89- 02.92	CA3001R	14 55	05.89- 02.92	CS180 12 0.8
Alfa 75 1.8	[AR06168]	09.88- 09.89	CA3001R	14 55	09.88- 02.92	CS180 12 0.8
		09.88- 02.92	CA5111R	14 65		
	[AR06202]	05.85- 09.89	CA3001R	14 55	05.85- 09.89	CS180 12 0.8
	[AR61102]	09.88- 09.89	CA3001R	14 55	09.88- 02.92	CS180 12 0.8
		09.88- 02.92	CA5111R	14 65		
	[AR61201]	08.89- 02.92	CA5111R	14 65	08.89- 02.92	CS180 12 0.8
Alfa 75 1.8 i.e. Turbo	[AR06158]	02.86- 01.90	CA5111R	14 65	02.86- 01.90	CS180 12 0.8
Alfa 75 1.8 Turbo	[AR06134]	02.86- 01.90	CA5111R	14 65	02.86- 01.90	CS180 12 0.8
Alfa 75 2.0	[AR06212]	05.85- 10.88	CA3001R	14 55		
Alfa 75 2.0 Twin Spark	[AR06166]	01.87- 02.92	CA5111R	14 65	01.87- 02.92	CS375 12 1.4
	[AR06224]	01.87- 02.92	CA5111R	14 65	01.87- 02.92	CS375 12 1.4
Alfa 75 2.0 TD	[VM80A]	05.85- 12.89	CA3161R	14 55		
		05.85- 09.92	CA3551R	14 65		
		01.90- 02.92	CA6311R	14 55		
Alfa 75 2.4 TD	[VM81A]	09.88- 12.89	CA3161R	14 55		
		09.88- 02.92	CA3551R	14 65		
		01.90- 02.92	CA6311R	14 55		
Alfa 75 2.5 V6	[AR01646]	05.85- 02.87	CA5111R	14 65		
	[AR01648]	09.86- 04.89	CA5111R	14 65		
	[AR01911]	02.86- 02.92	CA5111R	14 65		
Alfa 75 3.0 V6	[AR06120]	01.87- 02.92	CA5111R	14 65		
	[AR06124]	01.87- 02.92	CA5111R	14 65		
	[AR61503]	02.90- 02.92	CA5111R	14 65		
Alfa 90 1.8	[AR06202]	10.84- 01.87	CA3001R	14 55	10.84- 01.87	CS180 12 0.8
Alfa 90 2.0 i.e.	[AR01713]	10.84- 01.87	CA3001R	14 55	04.85- 01.87	CS375 12 1.4
	[AR06210]	10.84- 07.87	CA5111R	14 65		
	[AR06212]	10.84- 06.86	CA3001R	14 55	04.85- 06.86	CS375 12 1.4
Alfa 90 2.4 TD	[VM81A]	10.84- 01.87	CA3161R	14 55		
Alfa 90 2.5 i.e. V6	[AR01646]	10.84- 07.87	CA5111R	14 65		
	[AR01911]	10.84- 12.90	CA5111R	14 65		
Alfasud 1.2	[AR30102]	05.78- 02.80	CA2351R#	14 45	06.72- 02.80	CS131 12 0.8
		05.78- 02.80	CA521R	14 55		
	[AR30102S]	03.80- 09.84	CA2351R#	14 45	03.80- 09.84	CS131 12 0.8
		03.80- 09.84	CA521R	14 55		
	[AR30104]	05.78- 09.84	CA2351R#	14 45	06.74- 09.84	CS131 12 0.8
		05.78- 09.84	CA521R	14 55		
Alfasud 1.2 Giardinetta	[AR30102]	05.78- 12.81	CA2351R#	14 45	01.78- 12.81	CS131 12 0.8
		05.78- 12.81	CA521R	14 55		
Alfasud 1.3	[AR30180]	05.78- 02.80	CA2351R#	14 45	01.78- 02.80	CS131 12 0.8
		05.78- 02.80	CA521R	14 55		
Alfasud 1.3 Giardinetta	[AR30160]	03.80- 12.81	CA2351R#	14 45	03.80- 12.81	CS131 12 0.8
	[AR30180]	03.80- 12.81	CA521R	14 55	01.78- 02.80	CS131 12 0.8
Alfasud 1.3 Sprint	[AR30164]	05.78- 02.80	CA2351R#	14 45	05.78- 02.80	CS131 12 0.8
	[AR30168]	03.80- 12.84	CA2351R#	14 45	03.80- 12.84	CS131 12 0.8
	[AR30184]	09.76- 12.81	CA2351R#	14 45	09.76- 04.78	CS131 12 0.8
Alfasud 1.3 Super	[AR30160]	01.79- 02.80	CA2351R#	14 45	01.79- 02.80	CS131 12 0.8
		01.79- 02.80	CA521R	14 55		
	[AR30164]	05.78- 02.80	CA2351R#	14 45	09.77- 02.80	CS131 12 0.8
		05.78- 02.80	CA521R	14 55		
Alfasud 1.3 Ti	[AR30168]	03.80- 12.84	CA2351R#	14 45	03.80- 12.84	CS131 12 0.8
	[AR30184]	03.80- 12.84	CA521R	14 55		
		05.78- 09.84	CA2351R#	14 45	09.77- 09.84	CS131 12 0.8
		05.78- 09.84	CA521R	14 55		
Alfasud 1.5	[AR30146]	01.83- 12.87	CA2351R#	14 45	01.83- 12.87	CS131 12 0.8
Alfasud 1.5 Sprint	[AR30124]	03.80- 06.83	CA2351R#	14 45	03.80- 06.83	CS131 12 0.8
	[AR30128]	03.80- 12.84	CA2351R#	14 45	03.80- 12.84	CS131 12 0.8
	[AR30146]	01.83- 12.84	CA2351R#	14 45	01.83- 12.84	CS131 12 0.8
Alfasud 1.5 Ti	[AR30124]	01.81- 06.83	CA2351R#	14 45	01.81- 06.83	CS131 12 0.8
		01.81- 06.83	CA521R	14 55		
	[AR30128]	03.80- 12.84	CA2351R#	14 45	03.80- 12.84	CS131 12 0.8
		03.80- 12.84	CA521R	14 55		
Alfasud 1.5 Ti Sprint	[AR30146]	01.83- 12.84	CA2351R#	14 45	01.83- 12.84	CS131 12 0.8
		01.83- 12.84	CA521R	14 55		
Alfasud 1.7 Sprint	[AR30550]	03.87- 12.89	CA2351R#	14 45	03.87- 12.89	CS131 12 0.8
Alfasud 1.7 i.e. Sprint	[AR30558]	10.87- 12.89	CA2351R#	14 45	10.87- 12.89	CS131 12 0.8
		10.87- 12.89	CA5931R	14 65		
Alfetta 1.6	[AR01600]	07.80- 12.84	CA3001R	14 55	01.75- 12.84	CS180 12 0.8
Alfetta 1.6 GT	[AR01600]				05.76- 12.80	CS180 12 0.8
Alfetta 1.8	[AR01608]				05.72- 02.80	CS180 12 0.8
	[AR01608X]				05.72- 02.80	CS180 12 0.8
	[AR01678]	10.79- 12.84	CA3001R	14 55	10.79- 12.84	CS180 12 0.8
Alfetta 1.8 GT	[AR01608]				07.74- 12.77	CS180 12 0.8
	[AR01608X]				07.74- 12.77	CS180 12 0.8
Alfetta 2.0	[AR01655]	07.78- 12.84	CA3001R	14 55		
	[AR01713]	04.83- 12.84	CA3001R	14 55		
	[AR10520]	07.80- 12.84	CA3001R	14 55		
Alfetta 2.0 GT	[AR01623]	07.80- 01.86	CA3001R	14 55		
	[AR01655]	06.77- 12.84	CA3001R	14 55		
Alfetta 2.0 TD	[VM4HT/2]	10.79- 03.83	CA3001R	14 55		
		10.79- 03.83	CA3161R	14 55		
Alfetta 2.4 TD	[VM4HT2.4]	04.83- 12.84	CA3161R	14 55		
AR 6 1.9 Diesel	[160D100]	04.85- 12.89	CA1291R	14 55	04.85- 12.89	CS554 12 2.2
AR 6 2.4 Diesel	[8144.61.200]	04.85- 02.86	CA3161R	14 55		
AR 6 2.4 TD	[8144.21.220]	09.86- 12.89	CA3161R	14 55	09.86- 12.89	CS510 12 2.2
AR 6 2.5 Diesel	[8144.67.220]	03.86- 12.89	CA3161R	14 55	03.86- 12.89	CS289 12 2.0
AR 8 2.4 Diesel	[8140.21.200D.I.]	04.85- 12.88	CA6411R	14 45	04.85- 12.88	CS230 12 2.5
		04.85- 12.88	CA6421R	14 55		
	[8140.61.200]	04.78- 12.89	CA2551R	14 45	04.78- 08.86	CS230 12 2.5
		01.84- 12.89	CA3161R	14 55		
AR 8 2.4 TD	[8140.21.200D.I.]	04.85- 12.89	CA6411R	14 45	04.85- 12.89	CS230 12 2.5
		04.85- 12.89	CA6421R	14 55		
Arna 1.2	[AR30102]	03.83- 12.86	CA2351R#	14 45	03.83- 12.86	CS131 12 0.8
	[AR30500]	01.85- 12.86	CA2351R#	14 45	01.85- 12.86	CS131 12 0.8
		01.85- 12.86	CA3161R	14 55		
	[AR31000]	09.83- 12.86	CA2351R#	14 45	09.83- 12.86	CS131 12 0.8
Arna 1.3 Ti	[AR30168]	03.83- 12.86	CA2351R#	14 45	03.83- 12.86	CS131 12 0.8
		01.85- 12.86	CA3161R	14 55		





Alfatta 2.0 Sport					01.75- 01.77	CS180	12 0.8
Alfatta 2.0 GT					01.75- 01.77	CS180	12 0.8
GT 2.0 Veloce					01.72- 01.74	CS180	12 0.8
GTV 6 2.5		01.81- 01.86	CA300IR	14 55			
Milano 2.5 Gold		01.87- 01.89	CA300IR	14 55			
Milano 2.5 Platinum		01.87- 01.88	CA300IR	14 55			
Milano 2.5 Silver		01.87-	CA300IR	14 55			
Spider 2.0 Graduate		01.85- 01.90	CA300IR	14 55			
Spider 2.0 Quadrifoglio		01.86- 01.90	CA300IR	14 55			
Spider 2.0 Veloce		01.86-	CA300IR	14 55	01.72- 01.90	CS180	12 0.8
Sprint 2.0 Veloce					01.77- 01.79	CS180	12 0.8
<b>PASSENGER CARS AO</b>							
Alfa 147 2.0	[937A1.000]	07.02- 05.05	CA1223IR	14 100	07.02- 05.05	CS1053	12 1.1
Alfa 156 1.9 JTD	[937A5.000]	03.05- 05.06	CA1698IR	14 120	03.05- 05.06	CS1335	12 2.2
Alfa 164 3.0	[AR06410]				11.92- 10.95	CS585	12 1.4
	[AR64308]				03.95- 08.97	CS585	12 1.4
<b>Alpina-BMW</b>							
<b>PASSENGER CARS EU</b>							
Roadster 4.8 V8					06.02-	CS792	12 1.7
<b>AM General</b>							
<b>PASSENGER CARS US</b>							
Hummer 6.2		01.92- 01.94	UA939IR	14 100			
Hummer 6.2 2 Passenger		01.92- 01.94	UA939IR	14 100			
Hummer 6.2 4 Passenger		01.92- 01.94	UA939IR	14 100			
Hummer 6.2 4 PASSENGER OPEN TOP		01.92- 01.94	UA939IR	14 100			
Hummer 6.2 OPEN BODY RECRUIT		01.92- 01.93	UA939IR	14 100			
Hummer 6.2 Recruit		01.92- 01.94	UA939IR	14 100			
<b>American Motors</b>							
<b>PASSENGER CARS US</b>							
Ambassador 3.8		01.70-	UA916#	14 60			
Ambassador 4.7		01.66- 01.67	UA916#	14 60			
Ambassador 5.0		01.70-	UA916#	14 60			
Ambassador 5.0 Brougham		01.71- 01.74	UA916#	14 60			
Ambassador 5.0 DPL		01.70- 01.71	UA916#	14 60			
Ambassador 5.0 SST		01.70- 01.72	UA916#	14 60			
Ambassador 5.4		01.62- 01.66	UA916#	14 60			
Ambassador 5.9 Brougham		01.71- 01.74	UA916#	14 60			
Ambassador 6.6 Brougham		01.71- 01.74	UA916#	14 60			
Ambassador 6.6 DPL		01.71-	UA916#	14 60			
Ambassador 6.6 SST		01.71- 01.72	UA916#	14 60			
American 3.2		01.60-	UA943IR	14 60			
		01.62- 01.66	UA916#	14 60			
AMX 4.2		01.78- 01.80	UA943IR	14 60			
AMX 5.0							
Classic 3.2		01.61- 01.62	UA943IR	14 60			
		01.63- 01.64	UA916#	14 60			
Classic 3.3		01.65- 01.66	UA916#	14 60			
Concord 2.0		01.78- 01.79	CA52IR	14 55			
Concord 2.5		01.80- 01.82	UA943IR	14 60			
Concord 2.5 DL		01.80- 01.82	UA943IR	14 60			
Concord 2.5 Limited		01.80- 01.82	UA943IR	14 60			
Concord 3.8		01.78- 01.79	UA943IR	14 60			
Concord 4.2		01.78- 01.83	UA943IR	14 60			
Concord 4.2 DL		01.80- 01.83	UA943IR	14 60			
Concord 4.2 Limited		01.80- 01.83	UA943IR	14 60			
Concord 5.0							
Eagle 2.5		01.83- 01.84	UA945IR	14 65			
		01.81- 01.83	UA943IR	14 60			
Eagle 2.5 DL SX4		01.83-	UA943IR	14 60			
		01.83-	UA945IR	14 65			
Eagle 2.5 DL-50		01.81-	UA943IR	14 60			
Eagle 2.5 DL-50 Kammback		01.82-	UA943IR	14 60			
Eagle 2.5 DL-50 SX4		01.81- 01.82	UA943IR	14 60			
Eagle 2.5 Kammback		01.82-	UA943IR	14 60			
Eagle 2.5 Limited		01.83- 01.84	UA945IR	14 65			
		01.81- 01.83	UA943IR	14 60			
Eagle 2.5 SX4		01.83-	UA945IR	14 65			
		01.81- 01.83	UA943IR	14 60			
Eagle 4.2		01.80- 01.88	UA943IR	14 60			
Eagle 4.2 DL SX4		01.83-	UA943IR	14 60			
		01.83-	UA945IR	14 65			
Eagle 4.2 DL-50		01.81-	UA943IR	14 60			
Eagle 4.2 DL-50 Kammback		01.82-	UA943IR	14 60			
Eagle 4.2 DL-50 SX4		01.81- 01.82	UA943IR	14 60			
Eagle 4.2 Kammback		01.82-	UA943IR	14 60			
Eagle 4.2 Limited		01.80- 01.87	UA943IR	14 60			
Eagle 4.2 SX4		01.81- 01.83	UA943IR	14 60			
Gremlin 2.0		01.77-	CA52IR	14 55			
Gremlin 2.0 Custom		01.77- 01.78	CA52IR	14 55			
Gremlin 3.8 Custom		01.76- 01.78	UA943IR	14 60			
Gremlin 4.2		01.76- 01.78	UA943IR	14 60			
Gremlin 4.2 Custom		01.76- 01.78	UA943IR	14 60			
Gremlin 5.0 Custom							
Hornet 4.2		01.76- 01.77	UA943IR	14 60			
Hornet 4.2 Sportabout		01.76- 01.77	UA943IR	14 60			
Matador 5.9							
Pacer 4.2		01.76- 01.79	UA943IR	14 60			
Pacer 4.2 DL		01.80-	UA943IR	14 60			
Pacer 4.2 Limited		01.80-	UA943IR	14 60			
Pacer 5.0							
Spirit 2.0		01.79-	CA52IR	14 55			
Spirit 2.5		01.80- 01.82	UA943IR	14 60			
Spirit 2.5 DL		01.80- 01.82	UA943IR	14 60			
Spirit 2.5 Limited		01.80-	UA943IR	14 60			
Spirit 3.8		01.79-	UA943IR	14 60			
Spirit 4.2		01.79- 01.82	UA943IR	14 60			
Spirit 4.2 DL		01.80- 01.83	UA943IR	14 60			
Spirit 4.2 GT		01.83-	UA943IR	14 60			
		01.83-	UA945IR	14 65			
Spirit 4.2 Limited		01.80-	UA943IR	14 60			
Spirit 5.0		01.79-	CA52IR	14 55			



Atlas Copco							
MISC							
PR 425 8.5	[F6L413]	04.80- 12.86	CA3411R	28	27		
ST 35 2.8	[F3L912]					01.73- 08.82	CS103 12 2.7
						09.82- 12.86	CS114 12 2.4
ST 48 3.8	[F4L912]					02.73- 08.82	CS103 12 2.7
						09.82- 12.86	CS114 12 2.4
ST 71 5.6	[F6L912]					02.73- 12.86	CS398 12 3.7
ST 95 5.6	[BF6L912]					03.73- 12.86	CS398 12 3.7
STS 35 2.8	[F3L912]					02.73- 08.82	CS103 12 2.7
						09.82- 12.86	CS114 12 2.4
STS 48 3.8	[F4L912]					02.73- 08.82	CS103 12 2.7
						09.82- 12.86	CS114 12 2.4
STS 71 5.6	[F6L912]					02.73- 12.86	CS398 12 3.7
STS 95 5.6	[BF6L912]					02.73- 12.86	CS398 12 3.7
US 85 1.9	[F2L912]					08.76- 12.86	CS707 12 1.9
Audi							
PASSENGER CARS EU							
50 1.1	[HB]	08.74- 07.78	CA1361R	14	45	08.74- 07.78	CS79 12 0.8
	[HC]	08.74- 07.78	CA851R	14	55		
50 1.3	[HH]	08.74- 07.77	CA1361R	14	45	08.74- 07.77	CS79 12 0.8
		08.74- 07.77	CA851R	14	55		
50 1.5	[HH]	08.77- 07.78	CA1361R	14	45	08.77- 07.78	CS79 12 0.8
		08.77- 07.78	CA851R	14	55		
80 1.3	[EP]	09.71- 09.73	CA351R	14	35		
		08.81- 07.83	CA1401R	14	45	08.81- 07.86	CS297 12 0.95
		08.81- 07.83	CA1411R	14	65		
		08.81- 07.83	CA1631R	14	75		
		08.81- 10.83	CA521R	14	55		
		08.83- 07.86	CA2411R	14	55		
	[FY]	08.83- 07.86	CA2421R	14	65		
		09.78- 07.81	CA1391R	14	65	09.78- 07.81	CS79 12 0.8
	[FZ]	09.78- 01.80	CA851R	14	55		
		01.80- 07.81	CA1361R	14	45		
	[ZA]	09.78- 07.81	CA1361R	14	45	09.78- 07.81	CS79 12 0.8
		09.78- 07.81	CA1391R	14	65		
	[ZB]	09.78- 01.80	CA851R	14	55		
		05.72- 07.76	CA351R	14	35		
[ZC]	05.72- 07.76	CA521R	14	55			
	05.72- 07.76	CA521R	14	35			
80 1.4	[SE]	05.72- 07.76	CA521R	14	55		
		08.86- 08.91	CA2981R	14	65	08.86- 08.91	CS569 12 0.9
80 1.5	[YJ]	08.87- 08.91	CA3201R	14	90		
		05.72- 08.75	CA351R	14	35		
80 1.6	[ZB]	05.72- 08.75	CA521R	14	55		
		05.72- 08.75	CA351R	14	35		
80 1.6 E	[ZC]	05.72- 07.76	CA351R	14	35		
		05.72- 07.76	CA521R	14	55		
	[ABB]	08.90- 10.91	CA5201R	14	65	AT 08.90- 10.91	CS297 12 0.95
						08.90- 10.91	CS612 12 1.1
	[ABM]	09.91- 07.92	CA2981R	14	65	09.91- 12.94	CS569 12 0.9
		09.91- 07.92	CA3201R	14	90		
	[DT]	08.92- 12.94	CA8431R	14	90		
		08.92- 12.94	CA9081R	14	70		
	Chas. 8C-P-000001-	08.92- 12.94	CA12441R	14	90		
		08.83- 07.85	CA2411R	14	55		
	[PP]	08.83- 07.85	CA2421R	14	65		
		08.83- 07.85	CA3201R	14	90		
	[RN]	08.85- 03.87	CA2961R	14	55		
		08.85- 03.87	CA2981R	14	65		
[SA]	08.87- 09.91	CA2981R	14	65	08.87- 09.91	CS569 12 0.9	
	08.87- 09.91	CA3201R	14	90			
[YV]	09.86- 08.91	CA2981R	14	65	09.86- 08.91	CS569 12 0.9	
	09.86- 08.91	CA3201R	14	90			
[YN]	02.86- 07.86	CA2961R	14	55			
	02.86- 07.86	CA2981R	14	65			
[ZB]	02.86- 07.86	CA3201R	14	90			
	08.81- 07.83	CA1401R	14	45			
[YJ]	08.81- 07.83	CA1411R	14	65			
	08.81- 07.83	CA3201R	14	90			
[YK]	08.81- 07.83	CA521R	14	55			
	09.75- 07.76	CA351R	14	35			
[ZB]	09.75- 07.81	CA521R	14	55			
	08.80- 07.81	CA1401R	14	45			
[ZB]	08.80- 07.81	CA1411R	14	65			
	AC 08.78- 07.80	CA1251R#	14	65			
[ZB]	AC 08.78- 07.80	CA1631R	14	75			
	09.75- 07.76	CA351R	14	35			
[ZB]	09.75- 02.83	CA521R	14	55			
	08.80- 02.83	CA1401R	14	45			
[ZB]	08.80- 02.83	CA1411R	14	65			
	08.80- 02.83	CA1631R	14	75			
[ZB]	08.80- 02.83	CA3201R	14	90			
	AC 08.78- 07.80	CA1251R#	14	65			
[ZB]	AC 08.78- 07.80	CA1631R	14	75			
	09.78- 07.79	CA1251R#	14	65			
[ZB]	09.78- 07.79	CA1251R#	14	65			
	02.79- 07.81	CA1411R	14	65			
80 1.6 E	[ADA]	06.93- 01.96	CA12441R	14	90	06.93- 10.94	CS569 12 0.9
		06.93- 01.96	CA8431R	14	90	09.94- 01.96	CS612 12 1.1
80 1.6 GLE	[YZ]	06.93- 01.96	CA9081R	14	70		
		08.80- 06.82	CA1411R	14	65		
80 1.6 GT	[XX]	08.80- 06.82	CA1631R	14	75		
		08.80- 06.82	CA521R	14	55		
80 1.6 GTE	[YS]	AC 01.79- 07.80	CA1251R#	14	65		
		AC 01.79- 07.80	CA1631R	14	75		
80 1.6 Diesel	[CR]	09.73- 05.75	CA351R	14	35		
		09.73- 05.75	CA521R	14	55		
80 1.6 Diesel	[CR]	01.76- 07.76	CA1631R	14	75		
		01.76- 07.76	CA351R	14	35		
80 1.6 Diesel	[CR]	01.76- 07.76	CA521R	14	55		
		08.80- 07.85	CA2371R	14	65	08.80- 08.86	CS606 12 1.7
		08.80- 07.85	CA3671R	14	45	08.80- 08.86	CS185 12 1.5



	[JK]	08.82- 07.85 08.82- 07.85 08.85- 08.86 08.85- 08.91 09.86- 08.91	CA2371R CA3671R CA3371R CA5201R CA3181R	14 65 14 45 14 45 14 65 14 90	08.80- 08.86 09.86- 04.90 04.90- 08.91 08.80- 08.86	CS185 CS548 CS624 CS606	12 1.5 12 1.7 12 1.8 12 1.7
80 1.6 TD	[CY]	08.81- 07.84 08.81- 07.85 08.81- 07.85 08.84- 05.86 08.85- 05.86 AC 08.81- 07.84	CA1401R CA2371R CA3671R CA3371R CA5201R CA1631R	14 45 14 65 14 45 14 45 14 65 14 75	08.81- 05.86 08.81- 05.86	CS606 CS185	12 1.7 12 1.5
	[RA]	04.88- 03.89 04.88- 03.89	CA3181R CA5201R	14 90 14 65	04.88- 03.89	CS548	12 1.7
	[SB]	04.89- 08.91 04.89- 08.91	CA3181R CA5201R	14 90 14 65	04.87- 04.90 04.90- 08.91	CS548 CS624	12 1.7 12 1.8
80 1.8	[DS]	01.83- 07.83 01.83- 07.83 01.83- 07.83 08.83- 07.85 08.83- 07.85 08.84- 08.86 08.85- 08.86 08.85- 08.86	CA1411R CA1631R CA521R CA2411R CA2421R CA3201R CA2961R CA2981R	14 65 14 75 14 55 14 55 14 65 14 90 14 55 14 65	01.83- 08.86	CS297	12 0.95
	[JN]	08.83- 07.85 08.83- 07.85 08.84- 08.86 08.85- 08.86 08.85- 08.86	CA2411R CA2421R CA3201R CA2961R CA2981R	14 55 14 65 14 90 14 55 14 65	08.84- 08.86	CS297	12 0.95
	[RU]	10.86- 01.90 10.86- 01.90	CA2981R CA3201R	14 65 14 90	AT 10.86- 01.90 10.86- 01.90	CS297 CS509	12 0.95 12 1.0
	[SD]	09.87- 07.88 09.87- 07.88	CA2981R CA3201R	14 65 14 90	09.87- 07.88	CS509	12 1.0
	[SF]	02.86- 07.86 02.86- 07.86 02.86- 07.86	CA2961R CA2981R CA3201R	14 55 14 65 14 90	02.86- 07.86	CS297	12 0.95
80 1.8 Quattro	[JN]	08.85- 08.86 08.85- 08.86	CA2981R CA3201R	14 65 14 90	08.85- 08.86	CS297	12 0.95
	[NE]	08.84- 07.85 07.85- 08.86 07.85- 08.86	CA2421R CA2981R CA3201R	14 65 14 65 14 90	08.84- 08.86	CS297	12 0.95
	[SD]	09.86- 07.88 09.86- 07.88	CA2981R CA3201R	14 65 14 90	09.86- 07.88	CS509	12 1.0
	[SF]	09.86- 07.90 09.86- 07.90	CA2981R CA3201R	14 65 14 90	09.86- 07.90	CS509	12 1.0
80 1.8 E	[DZ]	06.86- 08.91 06.86- 08.91	CA2981R CA3201R	14 65 14 90	09.86- 08.91 06.86- 08.86	CS509 CS297	12 1.0 12 0.95
80 1.8 E Quattro	[DZ]	09.86- 08.91 09.86- 08.91	CA2981R CA3201R	14 65 14 90	09.86- 08.91	CS509	12 1.0
80 1.8 GTE	[DZ]	10.84- 07.85 10.84- 07.85 10.84- 08.86 08.85- 08.86 08.85- 08.86	CA2411R CA2421R CA3201R CA2961R CA2981R	14 55 14 65 14 90 14 55 14 65	10.84- 08.86	CS297	12 0.95
	[PV]	05.85- 03.87 08.85- 03.87 08.85- 03.87	CA3201R CA2961R CA2981R	14 90 14 55 14 65	08.85- 03.87	CS297	12 0.95
80 1.8 GTE Quattro	[DZ]	03.85- 07.85 03.85- 07.85 03.85- 08.86 08.85- 08.86 08.85- 08.86	CA2411R CA2421R CA3201R CA2961R CA2981R	14 55 14 65 14 90 14 55 14 65	03.85- 08.86	CS297	12 0.95
	[PV]	03.85- 08.86 03.85- 08.86 03.85- 08.86	CA2961R CA2981R CA3201R	14 55 14 65 14 90	03.85- 08.86	CS297	12 0.95
80 1.8 S	[JN]	09.86- 10.91 09.86- 10.91	CA2981R CA3201R	14 65 14 90	09.86- 10.91	CS509	12 1.0
	[NE]	09.86- 10.91 09.86- 10.91	CA2981R CA3201R	14 65 14 90	09.86- 10.91	CS509	12 1.0
	[PM]	09.86- 10.91 09.86- 10.91	CA2981R CA3201R	14 65 14 90	09.86- 10.91 AT 09.86- 10.91	CS509 CS297	12 1.0 12 0.95
	[SF]	09.86- 01.90 09.86- 01.90	CA2981R CA3201R	14 65 14 90	09.86- 01.90	CS509	12 1.0
80 1.8 S Quattro	[JN]	09.86- 09.91 09.86- 09.91	CA2981R CA3201R	14 65 14 90	09.86- 09.91	CS509	12 1.0
	[NE]	09.86- 07.88 09.86- 07.88	CA2981R CA3201R	14 65 14 90	09.86- 07.88	CS509	12 1.0
	[PM]	08.90- 09.91 08.90- 09.91	CA2981R CA3201R	14 65 14 90	08.90- 09.91	CS509	12 1.0
80 1.9	[WN]	09.81- 07.83 09.81- 07.83 09.81- 07.83	CA1631R CA2371R CA521R	14 75 14 65 14 55	09.81- 07.83 09.82- 07.83	CS132 CS282	12 1.1 12 1.1
80 1.9 Diesel	[1Y]	08.89- 08.91 08.89- 08.91	CA3181R CA5201R	14 90 14 65	08.89- 08.91 04.90- 08.91	CS548 CS624	12 1.7 12 1.8
80 1.9 TD	[AAZ]	09.91- 12.94 09.91- 01.96 09.91- 01.96 AC 09.91- 12.94	CA5201R CA8291R CA8521R CA3181R	14 65 14 90 14 70 14 90	09.91- 01.96	CS624	12 1.8
80 1.9 TDi	[1Z]	09.91- 01.96 09.91- 01.96 09.91- 01.96	CA11471R CA8291R CA8521R	14 120 14 90 14 70	09.91- 01.96	CS624	12 1.8
80 2.0	[ABK]	09.91- 07.92 09.91- 07.92 09.91- 08.92 07.92- 01.96 07.92- 01.96	CA2981R CA3021R CA8421R CA12441R CA9081R	14 65 14 65 14 90 14 90 14 70	09.91- 01.96	CS612	12 1.1
	[ABT]	09.91- 07.92 09.91- 07.92 09.91- 01.96 01.92- 01.96 07.92- 01.96	CA2981R CA3201R CA8431R CA9081R CA12441R	14 65 14 90 14 90 14 70 14 90	09.91- 01.96	CS612	12 1.1
	[HP]	10.83- 09.84 10.83- 09.84	CA2421R CA3201R	14 65 14 90	10.83- 09.84	CS282	12 1.1
	[JS]	10.83- 09.84 10.83- 09.84	CA2421R CA3201R	14 65 14 90	10.83- 09.84	CS282	12 1.1



AUDI Continued

	[AAD]	10.90- 08.91 CA298IR 14 65	10.90- 08.91 CS509 12 1.0
		10.90- 08.91 CA320IR 14 90	AT 10.90- 08.91 CS297 12 0.95
80 2.0 Quattro	[3A]	10.90- 08.91 CA298IR 14 65	10.90- 08.91 CS509 12 1.0
		10.90- 08.91 CA320IR 14 90	
	[ABK]	09.91- 10.91 CA298IR 14 65	09.91- 12.94 CS612 12 1.1
		09.91- 10.91 CA320IR 14 90	
		10.91- 09.92 CA842IR 14 90	
		09.92- 12.94 CA1244IR 14 90	
	[JS]	10.83- 09.84 CA320IR 14 90	10.83- 09.84 CS282 12 1.1
	[AAD]	10.90- 08.91 CA298IR 14 65	10.90- 08.91 CS509 12 1.0
		10.90- 08.91 CA320IR 14 90	
80 2.0 16V	[ACE]	02.93- 01.96 CA842IR 14 90	08.92- 01.96 CS612 12 1.1
		Chas. 8C-N-011594- 08.92- 01.96 CA842IR 14 90	
80 2.0 16V Quattro	[ACE]	08.92- 01.96 CA842IR 14 90	04.92- 01.96 CS612 12 1.1
80 2.0 E 16V	[6A]	03.90- 12.91 CA843IR 14 90	03.90- 12.91 CS509 12 1.0
80 2.0 E 16V Quattro	[6A]	03.90- 08.91 CA843IR 14 90	03.90- 08.91 CS509 12 1.0
80 2.0 E	[3A]	08.88- 10.90 CA298IR 14 65	AT 08.88- 10.90 CS297 12 0.95
		08.88- 10.90 CA320IR 14 90	08.88- 10.90 CS509 12 1.0
80 2.0 E Quattro	[3A]	08.88- 09.90 CA298IR 14 65	08.88- 09.90 CS509 12 1.0
		08.88- 09.90 CA320IR 14 90	
80 2.2	[WE]	10.80- 07.81 CA125IR# 14 65	10.80- 08.83 CS282 12 1.1
		10.80- 07.81 CA163IR 14 75	10.80- 08.83 CS132 12 1.1
		08.81- 08.83 CA141IR 14 65	
80 2.2 Quattro	[KK]	08.82- 07.84 CA320IR 14 90	08.82- 07.84 CS282 12 1.1
	[KL]	08.82- 07.84 CA320IR 14 90	08.82- 07.84 CS282 12 1.1
80 2.2 S2 Quattro	[ABY]	02.93- 07.95 CA1140IR 14 120	02.93- 07.95 CS282 12 1.1
80 2.2 RS2 Quattro	[ADU]	03.94- 01.96 CA1140IR 14 120	03.94- 01.96 CS282 12 1.1
80 2.3	[NG]	09.91- 01.96 CA521IR 14 90	09.91- 01.96 CS282 12 1.1
		09.91- 01.96 CA700IR 14 115	
80 2.3 Quattro	[NG]	09.91- 12.94 CA521IR 14 90	09.91- 12.94 CS282 12 1.1
		09.91- 12.94 CA700IR 14 115	
80 2.6	[ABC]	07.92- 01.96 CA837IR 14 90	07.92- 01.96 CS725 12 1.4
		07.92- 01.96 CA855IR 14 120	
80 2.6 Quattro	[ABC]	06.92- 12.94 CA837IR 14 90	06.92- 07.95 CS725 12 1.4
		06.92- 07.95 CA855IR 14 120	
80 2.8	[AAH]	09.91- 12.94 CA837IR 14 90	09.91- 01.96 CS725 12 1.4
		09.91- 01.96 CA855IR 14 120	
80 2.8 Quattro	[AAH]	09.91- 12.94 CA837IR 14 90	09.91- 05.95 CS725 12 1.4
		09.91- 05.95 CA855IR 14 120	
90 1.6 TD	[CY]	10.84- 07.85 CA237IR 14 65	10.84- 01.87 CS185 12 1.5
		10.84- 07.85 CA367IR 14 45	10.84- 01.87 CS606 12 1.7
		08.85- 01.87 CA318IR 14 90	
		08.85- 01.87 CA337IR 14 45	
		08.85- 01.87 CA520IR 14 65	
	[RA]	04.87- 03.90 CA318IR 14 90	04.87- 03.90 CS548 12 1.7
		04.87- 03.90 CA520IR 14 65	
	[SB]	04.89- 09.91 CA318IR 14 90	03.90- 09.91 CS624 12 1.8
		04.89- 09.91 CA520IR 14 65	04.87- 03.90 CS548 12 1.7
90 2.0	[HP]	10.84- 03.87 CA320IR 14 90	10.84- 03.87 CS282 12 1.1
		08.85- 03.87 CA911IR# 14 65	
		AC 11.85- 03.87 CA708IR 14 90 ▲	
	[JS]	10.84- 03.87 CA320IR 14 90	10.84- 03.87 CS282 12 1.1
		08.85- 03.87 CA911IR# 14 65	
		AC 11.85- 03.87 CA708IR 14 90 ▲	
	[PS]	05.87- 12.91 CA320IR 14 90	05.87- 12.91 CS509 12 1.0
			AT 05.87- 12.91 CS297 12 0.95
	[SK]	03.86- 03.87 CA320IR 14 90	02.86- 03.87 CS282 12 1.1
		03.86- 03.87 CA911IR# 14 65	
90 2.0 20V	[NM]	08.89- 07.91 CA521IR 14 90	08.89- 07.91 CS282 12 1.1
90 2.0 20V Quattro	[NM]	08.88- 09.91 CA521IR 14 90	08.88- 09.91 CS282 12 1.1
		08.88- 09.91 CA700IR 14 115	
90 2.2	[HY]	10.84- 03.87 CA320IR 14 90	10.84- 03.87 CS282 12 1.1
		08.85- 03.87 CA911IR# 14 65	
		AC 11.85- 03.87 CA708IR 14 90 ▲	
	[KV]	10.84- 03.87 CA320IR 14 90	10.84- 03.87 CS282 12 1.1
		08.85- 03.87 CA911IR# 14 65	
		AC 11.85- 03.87 CA708IR 14 90 ▲	
	[KX]	01.85- 03.87 CA320IR 14 90	01.85- 03.87 CS282 12 1.1
		08.85- 03.87 CA911IR# 14 65	
		AC 11.85- 03.87 CA708IR 14 90 ▲	
90 2.2 E	[KV]	04.87- 05.87 CA343IR 14 90	04.87- 07.91 CS282 12 1.1
		05.87- 07.91 CA521IR 14 90	
		AC 04.87- 07.91 CA708IR 14 90 ▲	
90 2.2 E Quattro	[JT]	10.84- 03.87 CA320IR 14 90	10.84- 03.87 CS282 12 1.1
		AC 11.85- 03.87 CA708IR 14 90 ▲	
	[KV]	11.84- 03.87 CA320IR 14 90	11.84- 09.91 CS282 12 1.1
		04.87- 05.87 CA343IR 14 90	
		04.87- 09.91 CA700IR 14 115	
		05.87- 09.91 CA521IR 14 90	
		AC 11.85- 03.87 CA708IR 14 90 ▲	
90 2.3 E 20V	[7A]	08.88- 12.91 CA521IR 14 90	08.88- 12.91 CS282 12 1.1
		AC 08.88- 12.91 CA700IR 14 115	
90 2.3 E 20V Quattro	[7A]	06.88- 09.91 CA521IR 14 90	06.88- 09.91 CS282 12 1.1
		AC 06.88- 09.91 CA700IR 14 115	
90 2.3 E	[NG]	04.87- 12.91 CA521IR 14 90	04.87- 12.91 CS282 12 1.1
		03.90- 12.91 CA700IR 14 115	
		AC 04.87- 07.91 CA700IR 14 115	
90 2.3 E Quattro	[NG]	04.87- 09.91 CA521IR 14 90	04.87- 09.91 CS282 12 1.1
		04.87- 09.91 CA700IR 14 115	
		AC 04.87- 07.91 CA700IR 14 115	
100 1.6	[YM]	01.75- 07.76 CA35IR 14 35	
		01.75- 07.76 CA52IR 14 55	
	[YV]	08.76- 02.83 CA140IR 14 45	
		08.76- 02.83 CA141IR 14 65	
		08.76- 02.83 CA320IR 14 90	
		08.76- 02.83 CA52IR 14 55	
100 1.8	[4B]	01.88- 11.90 CA298IR 14 65	01.88- 11.90 CS509 12 1.0
		01.88- 11.90 CA320IR 14 90	
	[DR]	08.82- 05.83 CA141IR 14 65	08.82- 10.86 CS297 12 0.95
		08.82- 10.86 CA320IR 14 90	
		08.82- 05.83 CA52IR 14 55	
		06.83- 10.86 CA241IR 14 55	
		06.83- 10.86 CA242IR 14 65	



	[DS]	05.83- 07.85 05.83- 07.89 05.83- 07.89 08.85- 08.86 08.85- 08.86	<b>CA241IR</b> <b>CA242IR</b> <b>CA320IR</b> <b>CA296IR</b> <b>CA298IR</b>	14 55 14 65 14 90 14 55 14 65		05.83- 07.87 08.87- 07.89	<b>CS297</b> <b>CS509</b>	12 0.95 12 1.0
	[JW]	03.83- 07.89 03.83- 07.89	<b>CA242IR</b> <b>CA320IR</b>	14 65 14 90		03.83- 07.87 08.87- 07.89	<b>CS297</b> <b>CS509</b>	12 0.95 12 1.0
	[NP]	01.88- 11.90 01.88- 11.90	<b>CA298IR</b> <b>CA320IR</b>	14 65 14 90		01.88- 11.90	<b>CS509</b>	12 1.0
	[PH]	04.85- 01.88 04.85- 11.90 01.88- 11.90	<b>CA242IR</b> <b>CA320IR</b> <b>CA298IR</b>	14 65 14 90 14 65		04.85- 07.87 07.87- 11.90	<b>CS297</b> <b>CS509</b>	12 0.95 12 1.0
	[RS]	11.86- 08.87 11.86- 08.87	<b>CA298IR</b> <b>CA320IR</b>	14 65 14 90		11.86- 08.87	<b>CS297</b>	12 0.95
	[SH]	02.86- 07.90 02.86- 07.90	<b>CA298IR</b> <b>CA320IR</b>	14 65 14 90		08.87- 07.90 08.86- 07.87	<b>CS509</b> <b>CS297</b>	12 1.0 12 0.95
	[ZU]	09.71- 07.74 09.71- 07.74	<b>CA35IR</b> <b>CA52IR</b>	14 35 14 55		09.71- 07.74 A13 09.71- 07.74	<b>CS83</b> <b>CS132</b>	12 0.8 12 1.1
100 1.8 Quattro	[4B]	01.88- 12.90 01.88- 12.90	<b>CA298IR</b> <b>CA320IR</b>	14 65 14 90		01.88- 12.90	<b>CS509</b>	12 1.0
	[JW]	08.83- 07.84 04.85- 07.89 08.85- 12.87	<b>CA241IR</b> <b>CA320IR</b> <b>CA242IR</b>	14 55 14 90 14 65		08.87- 07.89 03.83- 07.87	<b>CS509</b> <b>CS297</b>	12 1.0 12 0.95
	[NP]	08.85- 12.90 08.85- 11.90 01.88- 12.90	<b>CA242IR</b> <b>CA320IR</b> <b>CA298IR</b>	14 65 14 90 14 65		08.87- 12.90 08.85- 07.88	<b>CS509</b> <b>CS297</b>	12 1.0 12 0.95
	[PH]	04.85- 07.88 04.85- 12.90 08.88- 12.90	<b>CA242IR</b> <b>CA320IR</b> <b>CA298IR</b>	14 65 14 90 14 65		08.87- 12.90 04.85- 07.88	<b>CS509</b> <b>CS297</b>	12 1.0 12 0.95
	[SH]	02.86- 07.88 08.86- 07.90	<b>CA320IR</b> <b>CA298IR</b>	14 90 14 65		02.86- 07.87 08.87- 07.90	<b>CS297</b> <b>CS509</b>	12 0.95 12 1.0
100 1.8 LS	[ZZ]	10.70- 07.76 10.70- 07.76	<b>CA35IR</b> <b>CA52IR</b>	14 35 14 55		A13 01.75- 07.76 09.71- 07.76	<b>CS132</b> <b>CS83</b>	12 1.1 12 0.8
100 1.9	[WH]	08.80- 07.81 08.80- 07.81 08.81- 05.83 08.81- 05.83 08.82- 07.84 06.83- 07.84 06.83- 07.84	<b>CA125IR#</b> <b>CA163IR</b> <b>CA141IR</b> <b>CA52IR</b> <b>CA320IR</b> <b>CA241IR</b> <b>CA242IR</b>	14 65 14 75 14 65 14 55 14 90 14 55 14 65		08.80- 07.84 08.82- 07.84	<b>CS132</b> <b>CS282</b>	12 1.1 12 1.1
	[ZJ]	08.71- 07.76	<b>CA52IR</b>	14 55		A13 08.71- 07.76 08.71- 07.76	<b>CS132</b> <b>CS83</b>	12 1.1 12 0.8
	[ZP]	07.70- 07.71	<b>CA52IR</b>	14 55				
100 1.9 GL	[ZJ]	09.71- 07.76	<b>CA52IR</b>	14 55		09.71- 07.76 A13 01.75- 07.76	<b>CS83</b> <b>CS132</b>	12 0.8 12 1.1
100 2.0	[ABK]	08.92- 06.94 08.92- 06.94	<b>CA1244IR</b> <b>CA908IR</b>	14 90 14 70		08.92- 07.94	<b>CS612</b>	12 1.1
	[KP]	08.84- 12.87	<b>CA320IR</b>	14 90		08.84- 12.87	<b>CS282</b>	12 1.1
	[RT]	01.88- 11.90	<b>CA320IR</b>	14 90		01.88- 11.90	<b>CS282</b>	12 1.1
	[SL]	08.86- 11.87	<b>CA320IR</b>	14 90		08.86- 11.87	<b>CS282</b>	12 1.1
	[WA]	06.76- 08.78	<b>CA125IR#</b>	14 65		08.76- 04.77 AT 08.76- 04.77 08.76- 07.78	<b>CS83</b> <b>CS132</b> <b>CS132</b>	12 0.8 12 1.1 12 1.1
	[AAD]	12.90- 07.91 12.90- 07.91 12.90- 07.91 07.91- 12.92 09.91- 01.93 08.92- 01.93	<b>CA298IR</b> <b>CA320IR</b> <b>CA911IR#</b> <b>CA842IR</b> <b>CA908IR</b> <b>CA1244IR</b>	14 65 14 90 14 65 14 90 14 70 14 90		12.90- 07.91 08.91- 01.93	<b>CS509</b> <b>CS612</b>	12 1.0 12 1.1
	[AAE]	12.90- 07.91 12.90- 07.91 08.91- 07.92 09.91- 07.94 08.92- 07.94	<b>CA298IR</b> <b>CA320IR</b> <b>CA842IR</b> <b>CA908IR</b> <b>CA1244IR</b>	14 65 14 90 14 90 14 70 14 90		08.91- 07.94 12.90- 07.91	<b>CS612</b> <b>CS509</b>	12 1.1 12 1.0
100 2.0 Quattro	[AAD]	12.90- 09.91 10.91- 07.92	<b>CA320IR</b> <b>CA842IR</b>	14 90 14 90		12.90- 07.91 08.91- 07.92	<b>CS509</b> <b>CS612</b>	12 1.0 12 1.1
100 2.0 16V	[ACE]	01.92- 06.94 01.92- 06.94	<b>CA1244IR</b> <b>CA908IR</b>	14 90 14 70		01.92- 06.94	<b>CS612</b>	12 1.1
100 2.0 16V Quattro	[ACE]	07.92- 06.94	<b>CA842IR</b>	14 90		07.92- 06.94	<b>CS612</b>	12 1.1
100 2.0 E 16V	[ACE]	07.92- 06.94	<b>CA842IR</b>	14 90		07.92- 06.94	<b>CS612</b>	12 1.1
100 2.0 E 16V Quattro	[ACE]	07.92- 06.94	<b>CA842IR</b>	14 90		07.92- 06.94	<b>CS612</b>	12 1.1
100 2.0 E	[KP]	08.84- 10.87	<b>CA320IR</b>	14 90		08.84- 10.87	<b>CS282</b>	12 1.1
	[RT]	01.88- 11.90	<b>CA320IR</b>	14 90		01.88- 11.90	<b>CS282</b>	12 1.1
100 2.0 Diesel	[CN]	08.78- 11.90 08.83- 07.85 08.83- 10.84 08.84- 11.90 08.85- 07.89	<b>CA520IR</b> <b>CA141IR</b> <b>CA320IR</b> <b>CA318IR</b> <b>CA298IR</b>	14 65 14 65 14 90 14 90 14 65		08.78- 07.85 05.85- 11.90	<b>CS347</b> <b>CS350</b>	12 2.0 12 2.2
100 2.0 TD	[DE]	08.82- 07.85 08.84- 07.85 08.85- 02.88 08.85- 02.88	<b>CA141IR</b> <b>CA320IR</b> <b>CA318IR</b> <b>CA520IR</b>	14 65 14 90 14 90 14 65		08.82- 07.85 05.85- 02.88	<b>CS347</b> <b>CS350</b>	12 2.0 12 2.2
	[NC]	03.88- 11.90 03.88- 11.90	<b>CA318IR</b> <b>CA520IR</b>	14 90 14 65		03.88- 11.90	<b>CS350</b>	12 2.2
100 2.1	[KF]	08.82- 05.83 08.82- 07.84 08.82- 05.83	<b>CA141IR</b> <b>CA320IR</b> <b>CA52IR</b>	14 65 14 90 14 55		08.82- 07.84	<b>CS282</b>	12 1.1
	[WB]	10.77- 07.81 10.77- 07.81 08.81- 07.82 08.81- 07.82	<b>CA125IR#</b> <b>CA163IR</b> <b>CA141IR</b> <b>CA52IR</b>	14 65 14 75 14 65 14 55		10.77- 07.82	<b>CS132</b>	12 1.1
	[WC]	03.77- 07.81 03.77- 07.81 08.81- 05.83 08.81- 05.83 08.82- 07.84	<b>CA125IR#</b> <b>CA163IR</b> <b>CA141IR</b> <b>CA52IR</b> <b>CA320IR</b>	14 65 14 75 14 65 14 55 14 90		03.77- 07.82 08.82- 07.84	<b>CS132</b> <b>CS282</b>	12 1.1 12 1.1
	[WE]	10.77- 07.81 08.81- 07.82 08.81- 07.82 AC 10.77- 07.81	<b>CA125IR#</b> <b>CA141IR</b> <b>CA52IR</b> <b>CA163IR</b>	14 65 14 65 14 55 14 75		10.77- 07.82	<b>CS132</b>	12 1.1
	[WG]	03.77- 07.81 03.77- 07.81 08.81- 07.82 08.81- 07.82	<b>CA125IR#</b> <b>CA163IR</b> <b>CA141IR</b> <b>CA52IR</b>	14 65 14 75 14 65 14 55		03.77- 07.82	<b>CS132</b>	12 1.1



**AUDI Continued**

100 2.2	[KF]	08.82-05.83 08.82-07.84 08.82-05.83	CA1411R CA3201R CA521R	14 65 14 90 14 55	08.82-07.84	CS282	12 1.1
	[KU]	08.84-12.90 08.84-12.90	CA3201R CA7001R	14 90 14 115	08.84-12.90	CS282	12 1.1
	[KZ]	10.84-07.87	CA3201R	14 90	10.84-07.87	CS282	12 1.1
	[WB]	07.77-07.81 07.77-07.82 08.81-07.82 08.81-07.82	CA1251R# CA1631R CA1411R CA521R	14 65 14 75 14 65 14 55	01.78-07.82	CS132	12 1.1
	[WC]	07.77-07.81 07.77-07.81 08.81-02.83 08.81-02.83	CA1251R# CA1631R CA1411R CA521R	14 65 14 75 14 65 14 55	04.77-02.83	CS132	12 1.1
	[WE]	07.77-07.81 07.77-07.82 08.81-07.82 08.81-07.82	CA1251R# CA1631R CA1411R CA521R	14 65 14 75 14 65 14 55	01.78-07.82	CS132	12 1.1
	[WG]	07.77-07.80 07.77-07.80	CA1251R# CA1631R	14 65 14 75	04.77-07.80	CS132	12 1.1
	[WU]	08.82-07.84	CA3201R	14 90	08.82-07.84	CS282	12 1.1
100 2.2 Quattro	[KU]	08.84-11.90	CA3201R	14 90	08.84-11.90	CS282	12 1.1
100 2.2 E Turbo Quattro	[MC]	08.86-01.89 08.88-11.90 01.89-11.90	CA3201R CA7001R CA5211R	14 90 14 115 14 90	08.86-11.90	CS282	12 1.1
100 2.2 E Quattro	[PX]	08.85-07.86	CA3201R	14 90	08.85-07.86	CS282	12 1.1
100 2.2 Turbo	[MC]	08.86-01.89 08.88-11.90 01.89-11.90	CA3201R CA7001R CA5211R	14 90 14 115 14 90	08.86-11.90 08.86-11.90	CS350 CS282	12 2.2 12 1.1
100 2.2 Turbo Quattro	[MC]	03.86-01.89 01.89-11.90	CA5211R CA7001R	14 90 14 115	03.86-11.90	CS282	12 1.1
100 2.3	[NF]	10.86-07.87 10.86-11.90 07.87-11.90	CA3201R CA7001R CA5211R	14 90 14 115 14 90	10.86-11.90	CS282	12 1.1
	[AAR]	03.90-07.93 03.90-07.91 12.90-07.94 08.93-06.94	CA5211R CA7001R CA8551R CA8371R	14 90 14 115 14 120 14 90	03.90-07.94	CS282	12 1.1
100 2.3 Quattro	[AAR]	01.90-06.94 01.90-11.90 12.90-06.94	CA5211R CA7001R CA8551R	14 90 14 115 14 120	01.90-06.94	CS282	12 1.1
100 2.3 E	[NF]	10.86-07.87 10.86-11.90 07.87-11.90	CA3201R CA7001R CA5211R	14 90 14 115 14 90	10.86-11.90	CS282	12 1.1
	[AAR]	01.90-11.90 01.90-11.90	CA5211R CA7001R	14 90 14 115	01.90-11.90	CS282	12 1.1
100 2.3 E Quattro	[NF]	08.86-11.90 08.86-11.90 07.87-11.90	CA5211R CA7001R CA3201R	14 90 14 115 14 90	08.86-11.90	CS282	12 1.1
100 2.4 Diesel	[3D]	08.89-11.90	CA5211R	14 90	08.89-11.90	CS350	12 2.2
	[AAS]	05.91-06.94	CA5211R	14 90	05.91-07.94	CS350	12 2.2
100 2.5 TDi	[1T]	01.90-11.90 01.90-11.90	CA5211R CA7001R	14 90 14 115	01.90-11.90	CS350	12 2.2
	[ABP]	12.90-07.92	CA7001R	14 115	12.90-07.92	CS350	12 2.2
	[AAT]	12.90-07.94 06.91-06.94	CA7001R CA11411R	14 115 14 120	12.90-07.94	CS350	12 2.2
100 2.6	[ABC]	03.92-06.94 03.92-06.94	CA8371R CA8551R	14 90 14 120	03.92-06.94	CS725	12 1.4
	[ACZ]	01.93-06.94	CA8551R	14 120	01.93-06.94	CS725	12 1.4
100 2.6 Quattro	[ABC]	04.92-06.94	CA8551R	14 120	03.92-06.94	CS725	12 1.4
100 2.8 E	[AAH]	12.90-06.94 12.90-06.94	CA8371R CA8551R	14 90 14 120	12.90-06.94	CS725	12 1.4
100 2.8 E Quattro	[AAH]	12.90-06.94 12.90-06.94	CA8371R CA8551R	14 90 14 120	12.90-07.94	CS725	12 1.4
100 4.2 V8 S4 Quattro	[ABH]	10.92-06.94	CA7001R	14 115	10.92-06.94	CS985	12 1.8
	[AEC]	10.92-07.94	CA7001R	14 115	10.92-07.94	CS985	12 1.8
200 2.1 E	[WC]	08.83-07.84	CA3201R	14 90	08.83-07.84	CS282	12 1.1
200 2.1 Turbo	[KG]	08.83-01.88 AT 08.85-01.88	CA3201R CA3181R	14 90 14 90	08.83-01.88	CS282	12 1.1
200 2.1 Turbo Quattro	[KG]	11.84-12.87	CA3201R	14 90	11.84-12.87	CS282	12 1.1
200 2.2	[KU]	08.84-07.85	CA3201R	14 90	08.84-07.85	CS282	12 1.1
200 2.2 E	[WC]	10.79-07.81	CA1631R	14 75	10.79-09.82	CS132	12 1.1
200 2.2 Turbo 20V Quattro	[3B]	03.89-12.90 03.89-12.90	CA5211R CA7001R	14 90 14 115	03.89-12.90	CS282	12 1.1
200 2.2 Turbo	[1B]	08.88-12.91 08.88-12.91 08.88-12.91	CA3181R CA5211R CA7001R	14 90 14 90 14 115	02.88-12.91	CS282	12 1.1
	[2B]	02.88-12.91 08.88-12.91 08.88-12.91	CA3181R CA5211R CA7001R	14 90 14 90 14 115	02.88-12.91	CS282	12 1.1
	[MC]	08.85-03.88 03.88-12.91 03.88-12.91 AT 08.85-12.91	CA3201R CA5211R CA7001R CA3201R	14 90 14 90 14 115 14 90	08.85-12.91	CS282	12 1.1
	[WJ]	10.79-07.81	CA1631R	14 75	10.79-08.82	CS132	12 1.1
200 2.2 Turbo Quattro	[1B]	02.88-08.88 08.88-11.90 08.88-11.90	CA3201R CA5211R CA7001R	14 90 14 90 14 115	02.88-11.90	CS282	12 1.1
	[MC]	01.85-08.88 01.85-01.89 08.88-12.91 01.89-12.91	CA3181R CA3201R CA7001R CA5211R	14 90 14 90 14 115 14 90	01.85-12.91	CS282	12 1.1
200 2.3	[NF]	11.86-09.91 11.86-09.91	CA5211R CA7001R	14 90 14 115	11.86-09.91	CS282	12 1.1
A1 1.2 TFSi Sportback	[CBZA]				01.12-	CS1330	12 1.0
A1 1.4 TFSi	[CAVG]	01.11-	CA19851R	14 140			
A1 1.4 TFSi Sportback	[CAXA]	11.11-	CA19851R	14 140	6SP 11.11-	CS1294	12 1.1
	[CNVA]	11.11-	CA19851R	14 140			
A1 1.6 TDi	[CAYB]	03.11- 03.11-	CA17821R CA18101R	14 140 14 110	A25 03.11-	CS1505*	12 2.0
		A25 03.11-	CA20111R	14 140			
	[CAYC]	05.10-	CA20111R	14 140	05.10-	CS1505*	12 2.0





A1 1.6 TDi Sportback	[CAYB]	11.11-	CA1810IR	14 110	A25 11.11-	CS1505*	12 2.0	
	[CAYC]	11.11-	CA1782IR	14 140	A25 11.11-	CS1505*	12 2.0	
		11.11-	CA1810IR	14 110				
A1 2.0 TDi	[CFHD]	09.11-	CA1782IR	14 140	A25 09.11-	CS1508*	12 1.7	
		09.11-	CA1810IR	14 110	09.11-	CS1323	12 2.0	
		A25 09.11-	CA2011IR	14 140				
A1 2.0 TDi Sportback	[CFHB]	05.12-	CA1782IR	14 140	A25 05.12-	CS1508*	12 1.7	
		05.12-	CA1810IR	14 110	05.12-	CS1323	12 2.0	
A2 1.2 TDi	[ANY]	07.01-	CA1841IR	14 140	Chas. -8Z4010000 09.99-	CS1194	12 1.8	
		09.99- 06.01	CA1441IR	14 90	Chas. 8Z4010001- 10.03-	CS988	12 1.8	
		09.99- 06.01	CA1644IR	14 120				
A2 1.4	[AUA]	09.99- 04.02	CA1567IR	14 90	09.99- 04.02	CS1197	12 1.1	
		AC 09.99- 04.02	CA1512IR	14 90				
A2 1.4 TDi	[BBY]	AC 11.01-	CA1512IR	14 90	11.01-	CS1197	12 1.1	
	[AMF]	07.01- 08.03	CA1841IR	14 140	09.99- 08.03	CS974	12 1.8	
		09.99- 06.01	CA1644IR	14 120				
	[ATL]	11.03-	CA1841IR	14 140	11.03-	CS974	12 1.8	
	[BHC]	05.03- 08.05	CA1841IR	14 140	05.03- 08.05	CS974	12 1.8	
A2 1.6 FSi	[BAD]	01.02- 08.05	CA1815IR#	14 110	01.02- 08.05	CS1282	12 0.9	
		AC 01.02- 08.05	CA1729IR	14 110				
A3 1.2 TSi	[CBZB]				AT 04.10- 03.10-	CS1470 CS1322	12 1.1 12 1.1	
A3 1.2 TSi Sportback	[CBZB]				AT 04.10- 04.10-	CS1470 CS1322	12 1.1 12 1.1	
A3 1.4 TFSi	[CAXC]	09.07-	CA1817IR	14 110	09.07-	CS1294	12 1.1	
		09.07-	CA1985IR	14 140				
		09.07-	CA2056IR*	14 110				
		DKG 09.07-	CA1921IR	14 110				
	[CMSA]	04.10- 04.10-	CA1985IR CA2056IR*	14 140 14 110	04.10-	CS1470	12 1.1	
A3 1.6	[AEH]	09.96- 05.98	CA1240IR	14 90	09.96- 05.98	CS618	12 1.1	
		09.96- 05.98	CA1241IR	14 120	06.98- 06.01	CS1062	12 1.1	
		09.96- 05.98	CA1267IR	14 70				
		05.98- 06.01	CA1394IR	14 120				
		05.98- 06.01	CA1436IR	14 70				
		AC 05.98- 06.01	CA1378IR	14 90				
			CA1378IR	14 90				
	[AKL]	08.97- 04.98	CA1240IR	14 90	AT 08.97- 06.98	CS618	12 1.1	
		08.97- 04.98	CA1241IR	14 120	AT 07.98- 06.01	CS1062	12 1.1	
		08.97- 04.98	CA1267IR	14 70	08.97- 06.01	CS1119	12 1.1	
		05.98- 06.01	CA1378IR	14 90				
		05.98- 06.01	CA1436IR	14 70				
	[APF]	08.98- 08.00	CA1378IR	14 90	08.98- 08.00	CS1062	12 1.1	
		08.98- 08.00	CA1394IR	14 120				
		08.98- 08.00	CA1436IR	14 70				
	[AVU]	05.00- 04.02	CA1378IR	14 90	05.00- 04.02	CS1062	12 1.1	
		05.00- 04.02	CA1394IR	14 120				
		05.00- 04.02	CA1436IR	14 70				
	[BFQ]	08.00- 04.02	CA1378IR	14 90	08.00- 04.02	CS1062	12 1.1	
		08.00- 04.02	CA1394IR	14 120				
		08.00- 04.02	CA1436IR	14 70				
	[BGU]	05.03-	CA1782IR	14 140	AT, 6SP 05.03-	CS1347	12 1.1	
		05.03-	CA1818IR	14 110	5SP 05.03-	CS1324	12 1.0	
	[BSE]	06.05-	CA1782IR	14 140	AT, 6SP 06.05-	CS1347	12 1.1	
		06.05-	CA1818IR	14 110	5SP 06.05-	CS1324	12 1.0	
	[BSF]	06.05-	CA1782IR	14 140	5SP 06.05-	CS1324	12 1.0	
		06.05-	CA1818IR	14 110	AT, 6SP 06.05-	CS1347	12 1.1	
A3 1.6 Sportback	[BGU]	09.04-	CA1782IR	14 140	AT, 6SP 09.04-	CS1347	12 1.1	
		09.04-	CA1818IR	14 110	5SP 09.04-	CS1324	12 1.0	
	[BSE]	06.05-	CA1782IR	14 140	5SP 06.05-	CS1324	12 1.0	
		06.05-	CA1818IR	14 110	AT, 6SP 06.05-	CS1347	12 1.1	
	[BSF]	06.05-	CA1782IR	14 140	DSG 06.05-	CS1470	12 1.1	
		06.05-	CA1818IR	14 110	5SP 06.05-	CS1324	12 1.0	
	[CCSA]	07.08-	CA1782IR	14 140	AT, 6SP 06.05-	CS1347	12 1.1	
		07.08-	CA1818IR	14 110	07.08-	CS1324	12 1.0	
[CMXA]	05.10-	CA1782IR	14 140	05.10-	CS1324	12 1.0		
	05.10-	CA1818IR	14 110					
A3 1.6 FSi	[BAG]	08.03- 05.04	CA1817IR	14 110	AT, 6SP 08.03- 05.04	CS1347	12 1.1	
					08.03- 05.04	CS1330	12 1.0	
	[BLF]	01.05- 09.07	CA1817IR	14 110	AT, 6SP 01.05- 09.07	CS1347	12 1.1	
[BLP]	08.03- 12.04	CA1817IR	14 110	01.05- 09.07	CS1330	12 1.0		
				AT, 6SP 08.03- 12.04	CS1347	12 1.1		
A3 1.6 FSi Sportback	[BLF]	01.05-	CA1817IR	14 110	08.03- 12.04	CS1330	12 1.0	
	[BLP]	09.04-	CA1817IR	14 110	AT, 6SP 01.05- 09.07	CS1347	12 1.1	
A3 1.6 E-Power	[CMXA]	01.11-	CA1782IR	14 140	6SP 01.05-	CS1330	12 1.0	
		01.11-	CA1818IR	14 110	AT, 6SP 09.04- 6SP 09.04-	CS1347 CS1330	12 1.1 12 1.0	
A3 1.6 Sportback E-Power	[CMXA]	01.11-	CA1782IR	14 140	01.11-	CS1324	12 1.0	
		01.11-	CA1818IR	14 110				
A3 1.6 TDi	[CAYB]	05.09-	CA1782IR	14 140	A25 05.09-	CS1505*	12 2.0	
	[CAYC]	05.09-	CA2011IR	14 140	A25 05.09-	CS1505*	12 2.0	
A3 1.8	[AGN]	09.96- 05.98	CA1240IR	14 90	Sequential Manual 05.09- Transmission (SSG)	CS1480*	12 1.8	
		09.96- 05.98	CA1241IR	14 120	AT 07.98- 06.01	CS1062	12 1.1	
		09.96- 05.98	CA1267IR	14 70	AT 09.96- 06.98	CS618	12 1.1	
		05.98- 06.01	CA1436IR	14 70	09.96- 06.98	CS619	12 1.1	
	[APG]	AC 05.98- 06.01	CA1378IR	14 90	07.98- 06.01	CS1119	12 1.1	
A3 1.8 TFSi	[BYT]	08.98- 04.03	CA1378IR	14 90	AT 08.98- 04.03	CS1062	12 1.1	
		08.98- 04.03	CA1394IR	14 120	08.98- 04.03	CS1119	12 1.1	
		08.98- 04.03	CA1436IR	14 70				
A3 1.8 FSi	[BZB]	11.06- 06.07	CA1811IR	14 140	A24 11.06- 06.07	CS1347	12 1.1	
					11.06- 06.07	CS1294	12 1.1	
	[CDAA]	06.07- 01.09	CA1811IR	14 140	DSG 04.08- 01.09	CS1409	12 1.0	
					DSG 06.07- 06.08	CS1347	12 1.1	
				06.07- 01.09	CS1294	12 1.1		
			07.08-	CA1811IR	14 140	CS1294	12 1.1	
						A24 01.09- 07.08-	CS1470 CS1347	12 1.1 12 1.1



**AUDI Continued**

A3 1.8 TFSi Quattro	[CDA A]	07.08-	CA18111R	14 140	A24 07.08-07.08-	CS1470 CS1294 CS1347	12 1.1 12 1.1 12 1.1
	[BYT]	11.06- 06.07	CA18111R	14 140	11.06- 06.07	CS1470 CS1347 CS1294	12 1.1 12 1.1 12 1.1
		[BZB]	06.07- 06.08	CA18111R	14 140	DSG 11.06- 06.07	CS1347 CS1294
[CDA A]	07.08-	CA18111R	14 140	DSG 06.07- 06.08	CS1347 CS1294	12 1.1 12 1.1	
A3 1.8 Turbo 20V	[AGU]	12.96- 04.98	CA12401R	14 90	07.08-	CS1062 CS1119	12 1.1 12 1.1
		12.96- 04.98	CA12411R	14 120	07.08-	CS1119	12 1.1
		12.96- 04.98	CA12671R	14 70	AT 12.96- 06.98	CS618	12 1.1
		12.96-	CA14361R	14 70	12.96- 06.98	CS619	12 1.1
		AC 05.98-	CA13781R	14 90			
	[AQA]	08.98-	CA14361R	14 70	08.98-	CS1119	12 1.1
	[ARZ]	07.99-	CA14361R	14 70	AT 08.98-	CS1062	12 1.1
	[AUM]	AC 07.99-	CA13781R	14 90	07.99-	CS1119	12 1.1
		07.99-	CA14361R	14 70	AT 07.99-	CS1062	12 1.1
		AC 07.99-	CA13781R	14 90			
A3 1.8 Turbo	[AJQ]	08.98- 08.00	CA13781R	14 90	08.98- 08.00	CS1119	12 1.1
		08.98- 08.00	CA13941R	14 120	AT 08.98- 08.00	CS1062	12 1.1
		08.98- 08.00	CA14361R	14 70			
	[APP]	08.98- 05.00	CA13781R	14 90	AT 08.98- 05.00	CS1062	12 1.1
		08.98- 05.00	CA13941R	14 120	08.98- 05.00	CS1119	12 1.1
		08.98- 05.00	CA14361R	14 70			
	[ARY]	09.00- 06.01	CA13781R	14 90	AT, 4SP 09.00- 06.01	CS1062	12 1.1
		09.00- 06.01	CA13941R	14 120	09.00- 06.01	CS1119	12 1.1
		09.00- 06.01	CA14361R	14 70	AT, 5SP 12.98-	CS1477*	12 1.4
	[AUQ]	05.00- 06.03	CA13781R	14 90	AT 05.00- 06.03	CS1062	12 1.1
		05.00- 06.03	CA13941R	14 120	5SP 05.00- 06.03	CS1119	12 1.1
		05.00- 06.03	CA14361R	14 70	6SP 05.00- 06.03	CS1181	12 2.0
A3 1.8 Turbo Quattro	[AGU]	08.97- 05.98	CA12401R	14 90	08.98- 08.00	CS1119	12 1.1
		08.97- 05.98	CA12411R	14 120	09.97- 06.98	CS619	12 1.1
		08.97- 05.98	CA12671R	14 70	AT 08.97- 06.98	CS618	12 1.1
		05.98- 08.00	CA13781R	14 90	AT 06.98- 08.00	CS1062	12 1.1
		05.98- 08.00	CA13941R	14 120	AT 12.96-	CS1477*	12 1.4
		05.98- 08.00	CA14361R	14 70			
	[AJQ]	08.98- 08.00	CA13781R	14 90	AT 08.98- 08.00	CS1062	12 1.1
		08.98- 08.00	CA14361R	14 70	08.98- 08.00	CS1119	12 1.1
	[AQA]	08.98- 04.01	CA13781R	14 90	08.98- 04.01	CS1119	12 1.1
		08.98- 04.01	CA13941R	14 120	AT 08.98- 04.01	CS1062	12 1.1
	[ARX]	10.99- 06.03	CA12401R	14 90	5SP 10.99- 06.03	CS1119	12 1.1
		10.99- 06.03	CA12411R	14 120	AT, 4SP 10.99- 06.03	CS1062	12 1.1
		10.99- 06.03	CA12671R	14 70	6SP 10.99- 06.03	CS1181	12 2.0
		10.99- 06.03	CA13781R	14 90			
		10.99- 06.03	CA13941R	14 120			
		10.99- 06.03	CA14361R	14 70			
	[ARY]	09.00- 06.03	CA13781R	14 90	09.00- 06.03	CS1181	12 2.0
		09.00- 06.03	CA13941R	14 120	09.00- 06.03	CS1119	12 1.1
	[AGR]	09.96- 04.98	CA11441R	14 120	09.96- 08.00	CS974	12 1.8
		09.96- 05.98	CA15701R	14 90	AT 09.96- 08.00	CS789	12 1.8
	[AHF]	05.98- 08.00	CA13941R	14 120			
		05.98- 08.00	CA14461R	14 90			
05.98- 08.00		CA15021R	14 70				
01.97- 04.98		CA11441R	14 120	AT 01.97- 08.00	CS789	12 1.8	
01.97- 04.98		CA15701R	14 90	01.97- 08.00	CS974	12 1.8	
[ALH]	08.97- 04.98	CA11441R	14 120	AT 08.97- 06.01	CS789	12 1.8	
	08.97- 04.98	CA15701R	14 90	08.97- 06.01	CS974	12 1.8	
	05.98- 06.01	CA13941R	14 120				
	05.98- 06.01	CA14461R	14 90				
	05.98- 06.01	CA15021R	14 70				
[ASV]	09.99- 06.01	CA13941R	14 120	AT 09.99- 06.01	CS789	12 1.8	
	09.99- 06.01	CA14461R	14 90	09.99- 06.01	CS974	12 1.8	
	09.99- 06.01	CA15021R	14 70				
[ASZ]	08.00- 06.03	CA13941R	14 120	AT 08.00- 06.03	CS1062	12 1.1	
	08.00- 06.03	CA14461R	14 90	08.00- 06.03	CS974	12 1.8	
[ATD]	08.00- 06.03	CA15021R	14 70	AT 08.00- 06.03	CS1390	12 2.3	
	10.00- 06.03	CA13941R	14 120	AT, 5SP 10.00- 06.03	CS1390	12 2.3	
	10.00- 06.03	CA14461R	14 90	6SP 10.00- 06.03	CS1181	12 2.0	
[AXR]	10.00- 06.03	CA15021R	14 70	5SP 10.00- 06.03	CS974	12 1.8	
	11.01- 06.03	CA13941R	14 120	6SP 11.01- 06.03	CS1181	12 2.0	
	11.01- 06.03	CA14461R	14 90	AT, 5SP 11.01- 06.03	CS1390	12 2.3	
[BKC]	11.01- 06.03	CA15021R	14 70	5SP 11.01- 06.03	CS974	12 1.8	
[BLS]	03.03-	CA17821R	14 140	5SP 03.03-	CS1293	12 2.0	
	04.08-	CA17821R	14 140	DSG 04.08-	CS1286	12 2.0	
	04.08-	CA18101R	14 110	04.08-	CS1293	12 2.0	
A3 1.9 TDI Quattro	[ASZ]	05.00- 06.03	CA13941R	14 120	AT 05.00- 06.03	CS1390	12 2.3
		05.00- 06.03	CA14461R	14 90	AT 05.00- 06.03	CS1062	12 1.1
		05.00- 06.03	CA15021R	14 70	05.00- 06.03	CS974	12 1.8
A3 1.9 TDI Sportback	[BKC]	09.04-	CA17821R	14 140	09.04-	CS1293	12 2.0
		09.04-	CA18101R	14 110			
A3 2.0 Sportback	[CDLC]	07.08-	CA17821R	14 140	07.08-	CS1347	12 1.1
					A41 07.08-	CS1409	12 1.0
A3 2.0 FSI	[AXW]	05.03-	CA17821R	14 140	AT, 6SP 05.03-	CS1347	12 1.1
		05.03-	CA18181R	14 110	05.03-	CS1294	12 1.1
	[BLR]	01.05- 10.05	CA17821R	14 140	01.05- 10.05	CS1347	12 1.1
	[BLX]	06.04- 12.04	CA17821R	14 140	06.04- 12.04	CS1294	12 1.1
		06.04- 12.04	CA18181R	14 110	AT 06.04- 12.04	CS1347	12 1.1
	[BLY]	09.04- 10.05	CA17821R	14 140	09.04- 10.05	CS1347	12 1.1
		09.04- 10.05	CA18181R	14 110			
	[BMB]	01.04- 08.04	CA17821R	14 140	01.04- 08.04	CS1330	12 1.0
		01.04- 08.04	CA18181R	14 110			
	[BVY]	05.03-	CA17821R	14 140	AT, 6SP 10.03-	CS1347	12 1.1
	05.03-	CA18181R	14 110	10.03-	CS1294	12 1.1	



	[BVZ]	11.05-11.05-	CA1782IR CA1818IR	14 140 14 110		11.05-	CS1347	12 1.1	
A3 2.0 FSi Sportback	[BLR]	01.05-11.05	CA1782IR CA1818IR	14 140 14 110		01.05-11.05	CS1294 CS1347	12 1.1 12 1.1	
	[BLX]	06.04-01.05	CA1782IR CA1818IR	14 140 14 110		AT 06.04-01.05	CS1347 CS1294	12 1.1 12 1.1	
	[BLY]	06.04-11.05	CA1782IR CA1818IR	14 140 14 110		AT 06.04-11.05	CS1347 CS1294	12 1.1 12 1.1	
	[BMB]	01.04-01.05	CA1782IR CA1818IR	14 140 14 110		06.04-11.05	CS1294 CS1347	12 1.1 12 1.1	
	[BVY]	11.05-11.05-	CA1782IR CA1818IR	14 140 14 110		01.04-01.05	CS1294 CS1347	12 1.1 12 1.1	
	[BVZ]	11.05-11.05-	CA1782IR CA1818IR	14 140 14 110		AT 01.04-01.05	CS1294 CS1347	12 1.1 12 1.1	
						11.05-	CS1294	12 1.1	
						AT 11.05-	CS1294	12 1.1	
A3 2.0 TFSI	[AXX]	09.04-09.04-	CA1782IR CA1818IR	14 140 14 110		6SP 11.05-	CS1294 CS1347	12 1.1 12 1.1	
	[BWA]	09.05-09.05-	CA1782IR CA1818IR	14 140 14 110		AT, 6SP 11.05-	CS1347	12 1.1	
	[CAWB]	02.08-02.08-	CA1782IR CA1818IR	14 140 14 110		09.04-	CS1347	12 1.1	
						DSG 09.04-	CS1409	12 1.0	
						DSG 09.05-	CS1409	12 1.0	
						DSG 02.08-	CS1409	12 1.0	
A3 2.0 TFSI Quattro	[AXX]	09.04-10.05	CA1782IR CA1818IR	14 140 14 110		07.08-	CS1347	12 1.1	
	[BWA]	09.05-06.08	CA1782IR CA1818IR	14 140 14 110		A41 07.08-	CS1409	12 1.0	
	[CCZA]	07.08-	CA1811IR	14 140		09.04-10.05	CS1409	12 1.0	
						09.04-10.05	CS1347	12 1.1	
A3 2.0 TFSI Sportback	[AXX]	09.04-09.04-	CA1782IR CA1818IR	14 140 14 110		09.05-06.08	CS1347	12 1.1	
	[BPY]	11.05-05.07	CA1782IR CA1818IR	14 140 14 110		09.05-06.08	CS1409	12 1.0	
	[BWA]	09.05-09.05-	CA1782IR CA1818IR	14 140 14 110		DSG 09.05-06.08	CS1409	12 1.0	
	[CAWB]	02.08-	CA1811IR	14 140		A41 09.05-	CS1409	12 1.0	
						07.08-	CS1347	12 1.1	
						09.04-	CS1347	12 1.1	
A3 2.0 TFSI Sportback Quattro	[AXX]	09.04-09.04-	CA1782IR CA1818IR	14 140 14 110		09.05-06.08	CS1347	12 1.1	
	[BWA]	09.05-09.05-	CA1782IR CA1818IR	14 140 14 110		DSG 09.05-06.08	CS1409	12 1.0	
	[CCZA]	07.08-	CA1811IR	14 140		A41 07.08-	CS1409	12 1.0	
A3 2.0 TDi 16V	[BKD]	05.03-05.03-	CA1782IR CA1810IR	14 140 14 110		07.08-	CS1347	12 1.1	
						A41 07.08-	CS1409	12 1.0	
A3 2.0 TDi 16V Quattro	[BKD]	08.04-08.04-	CA1782IR CA1810IR	14 140 14 110		09.04-10.05	CS1409	12 1.0	
						09.05-06.08	CS1347	12 1.1	
A3 2.0 TDi 16V Sportback	[BKD]	09.04-09.04-	CA1782IR CA1810IR	14 140 14 110		08.04-	CS1286	12 2.0	
						05.03-	CS1323	12 2.0	
A3 2.0 TDi	[AZV]	05.03-05.03-	CA1782IR CA1810IR	14 140 14 110		AT 08.04-	CS1286	12 2.0	
	[BMM]	06.05-06.05-	CA1782IR CA1810IR	14 140 14 110		08.04-	CS1293	12 2.0	
	[BMN]	03.06-03.06-	CA1782IR CA1810IR	14 140 14 110		6SP 11.05-08.04-	CS1323	12 2.0	
	[BUY]	06.06-06.08	CA1782IR CA1810IR	14 140 14 110		08.04-	CS1323	12 2.0	
	[CBAB]	04.08-04.08-	CA1782IR CA2011IR	14 140 14 140		09.04-	CS1286	12 2.0	
		A25 04.08-	CA2011IR	14 140		09.04-	CS1293	12 2.0	
						09.04-	CS1323	12 2.0	
						AT 04.08-	CS1286	12 2.0	
A3 2.0 TDi Quattro	[AZV]	05.03-05.03-	CA1782IR CA1810IR	14 140 14 110		04.08-	CS1323	12 2.0	
	[BMM]	01.06-01.06-	CA1782IR CA1810IR	14 140 14 110		04.08-	CS1286	12 2.0	
	[BMN]	03.06-03.06-	CA1782IR CA1810IR	14 140 14 110		AT 05.03-	CS1286	12 2.0	
A3 2.0 TDi Sportback	[AZV]	09.04-09.04-	CA1782IR CA1810IR	14 140 14 110		05.03-	CS1286	12 2.0	
						05.03-	CS1293	12 2.0	
A3 2.0 TDi Sportback Quattro	[BMM]	06.05-06.05-	CA1782IR CA1810IR	14 140 14 110		05.03-	CS1323	12 2.0	
	[BMN]	03.06-03.06-	CA1782IR CA1810IR	14 140 14 110		01.06-	CS1323	12 2.0	
						AT 01.06-	CS1286	12 2.0	
A3 2.5 RS3 quattro Sportback	[CEPA]	04.11-	CA1782IR	14 140		AT 03.06-	CS1286	12 2.0	
A3 3.2 Quattro	[BMJ]	07.03-	CA1782IR	14 140		03.06-	CS1323	12 2.0	
						AT 03.06-	CS1286	12 2.0	
A3 3.2 V6 Quattro	[BDB]	07.03-	CA1782IR	14 140		09.04-	CS1286	12 2.0	
						09.04-	CS1323	12 2.0	
A3 3.2 V6 Sportback Quattro	[BMJ]	09.04-	CA1782IR	14 140		09.04-	CS1286	12 2.0	
						09.04-	CS1323	12 2.0	
A4 1.6	[ADP]	11.94-10.96	CA1093IR CA1139IR CA1140IR	14 70 14 90 14 120		11.94-10.96	CS612	12 1.1	
	[AHL]	10.96-12.98	CA1093IR CA1139IR CA1140IR	14 70 14 90 14 120		10.96-07.99	CS612	12 1.1	
		10.96-07.99	CA1139IR	14 90					
		10.96-12.98	CA1140IR	14 120					
		08.97-07.99	CA1546IR	14 90					
		01.99-07.99	CA1545IR	14 70					
		01.99-07.99	CA1588IR	14 120					
		01.99-07.99	CA1664IR	14 120					
		01.99-07.99	CA1759IR	14 120					
	[ALZ]	07.00-09.01	CA1545IR	14 70		Chas. -8E-5-030000	07.00-06.04	CS612	12 1.1
		07.00-09.01	CA1546IR	14 90		Chas. 8E-5-030001-	06.04-12.04	CS1394	12 1.2
		11.00-	CA1754IR	14 120					
		11.00-	CA1769IR	14 150					
	11.00-	CA1811IR	14 140						



AUDI Continued

	[ANA]	08.98- 07.00 CA1545IR 14 70 08.98- 07.00 CA1546IR 14 90 08.98- 07.00 CA1664IR 14 120 08.98- 07.00 CA1759IR 14 120		08.98- 07.00 CS612	12 1.1
	[ARM]	08.98- 07.99 CA1545IR 14 70 08.98- 07.99 CA1546IR 14 90 08.98- 07.99 CA1664IR 14 120 08.98- 07.99 CA1759IR 14 120		08.98- 07.99 CS612	12 1.1
A4 1.8	[ADR]	11.94- 12.98 CA1093IR 14 70 11.94- 07.97 CA1139IR 14 90 11.94- 12.98 CA1140IR 14 120 08.97- 04.99 CA1546IR 14 90 01.99- 04.99 CA1545IR 14 70 01.99- 04.99 CA1664IR 14 120 01.99- 04.99 CA1759IR 14 120		11.94- 04.99 CS612	12 1.1
	[AFY]	04.95- 07.97 CA1139IR 14 90 07.95- 12.98 CA1093IR 14 70 07.95- 12.98 CA1140IR 14 120 08.97- 09.01 CA1546IR 14 90 01.99- 09.01 CA1545IR 14 70 01.99- 09.01 CA1664IR 14 120 01.99- 09.01 CA1759IR 14 120		04.95- 09.01 CS612	12 1.1
	[APT]	04.99- 10.00 CA1545IR 14 70 04.99- 10.00 CA1546IR 14 90 04.99- 10.00 CA1664IR 14 120 04.99- 10.00 CA1759IR 14 120		04.94- 10.00 CS612	12 1.1
	[ARG]	08.98- 10.00 CA1545IR 14 70 08.98- 10.00 CA1546IR 14 90 08.98- 10.00 CA1664IR 14 120 08.98- 10.00 CA1759IR 14 120		08.98- 10.00 CS612	12 1.1
	[AVV]	06.00- 09.01 CA1545IR 14 70 06.00- 09.01 CA1546IR 14 90 06.00- 09.01 CA1664IR 14 120 06.00- 09.01 CA1759IR 14 120		06.00- 09.01 CS612	12 1.1
A4 1.8 Quattro	[ADR]	11.94- 12.98 CA1093IR 14 70 11.94- 07.97 CA1139IR 14 90 11.94- 12.98 CA1140IR 14 120 08.97- 04.99 CA1546IR 14 90 01.99- 04.99 CA1545IR 14 70 01.99- 04.99 CA1588IR 14 120		11.94- 04.99 CS612	12 1.1
	[AFY]	07.95- 12.98 CA1093IR 14 70 07.95- 12.98 CA1139IR 14 90 07.95- 12.98 CA1140IR 14 120 08.97- 09.01 CA1546IR 14 90 01.99- 09.01 CA1545IR 14 70 01.99- 09.01 CA1664IR 14 120 01.99- 09.01 CA1759IR 14 120		07.95- 09.01 CS612	12 1.1
	[APT]	02.99- 09.01 CA1545IR 14 70 02.99- 09.01 CA1546IR 14 90 02.99- 09.01 CA1664IR 14 120 02.99- 09.01 CA1759IR 14 120		02.99- 09.01 CS612	12 1.1
	[ARG]	08.98- 06.00 CA1545IR 14 70 08.98- 06.00 CA1546IR 14 90 08.98- 06.00 CA1664IR 14 120 08.98- 06.00 CA1759IR 14 120		08.98- 06.00 CS612	12 1.1
A4 1.8 TFSi	[CABA]	01.08- CA2007IR 14 140		01.08- CS1437	12 1.1
	[CABB]	11.07- CA2007IR 14 140		11.07- CS1437	12 1.1
	[CDHA]	06.08- CA2007IR 14 140		06.08- CS1437	12 1.1
	[CDHB]	04.08- CA2007IR 14 140		04.08- CS1437	12 1.1
A4 1.8 TFSi Quattro	[CDHB]	09.08- CA2007IR 14 140		09.08- CS1437	12 1.1
A4 1.8 Turbo	[AEB]	11.94- 07.98 CA1093IR 14 70 11.94- 07.97 CA1139IR 14 90 11.94- 07.98 CA1140IR 14 120		11.94- 07.98 CS612	12 1.1
	[AJL]	08.97- 12.98 CA1093IR 14 70 08.97- 12.98 CA1139IR 14 90 08.97- 12.98 CA1140IR 14 120 08.97- 09.01 CA1546IR 14 90 01.99- 09.01 CA1545IR 14 70 01.99- 09.01 CA1664IR 14 120 01.99- 09.01 CA1759IR 14 120		08.97- 09.01 CS612	12 1.1
	[AMB]	07.01- CA1754IR 14 120 07.01- CA1811IR 14 140	Chas. -8E-5-030000 07.01- Chas. 8E-5-030001- 07.01-	CS612 CS1394	12 1.1 12 1.2
	[ANB]	05.99- 06.00 CA1545IR 14 70 05.99- 06.00 CA1546IR 14 90 05.99- 06.00 CA1664IR 14 120 05.99- 06.00 CA1759IR 14 120		05.99- 06.00 CS612	12 1.1
	[APU]	08.98- 07.99 CA1545IR 14 70 08.98- 07.99 CA1546IR 14 90 08.98- 07.99 CA1664IR 14 120		08.98- 07.99 CS612	12 1.1
	[ARK]	08.98- 07.99 CA1545IR 14 70 08.98- 07.99 CA1546IR 14 90 08.98- 07.99 CA1664IR 14 120		08.98- 07.99 CS612	12 1.1
	[AVJ]	11.00- 07.02 CA1754IR 14 120 11.00- 07.02 CA1769IR 14 150 11.00- 07.02 CA1811IR 14 140		11.00- 07.02 CS612	12 1.1
	[AWT]	06.00- 11.00 CA1545IR 14 70 06.00- 11.00 CA1546IR 14 90 06.00- 11.00 CA1664IR 14 120 06.00- 11.00 CA1759IR 14 120		06.00- 11.00 CS612	12 1.1
	[BEX]	11.02- 12.04 CA1754IR 14 120 11.02- 12.04 CA1769IR 14 150 11.02- 12.06 CA1811IR 14 140	Chas. -8E-5-030000 11.02- 06.04 Chas. 8E-5-030001- 06.04- 12.04	CS612 CS1394	12 1.1 12 1.2
	[BFB]	07.02- CA1754IR 14 120 07.02- CA1769IR 14 150 07.02- CA1811IR 14 140 Chas. 8E-3-029804- 11.04- AC 07.02- CA1754IR 14 120	Chas. -8E-5-030000 07.02- 06.04 Chas. 8E-5-030001- 06.04- 12.05	CS612 CS1394	12 1.1 12 1.2
	[BKB]	07.02- CA1754IR 14 120 07.02- CA1769IR 14 150 07.02- CA1811IR 14 140	Chas. 8E-5-030001- 06.04- 12.04 Chas. -8E-5-030000 07.02- 06.04	CS1394 CS612	12 1.2 12 1.1
A4 1.8 Turbo Quattro	[AEB]	11.94- 12.98 CA1093IR 14 70 11.94- 07.97 CA1139IR 14 90 11.94- 12.98 CA1140IR 14 120		11.94- 12.98 CS612	12 1.1



	[AJL]	08.97- 12.98 08.97- 12.98 08.97- 12.98 01.99- 09.01 01.99- 09.01 01.99- 09.01	CA1093IR CA1139IR CA1140IR CA1545IR CA1546IR CA1664IR	14 70 14 90 14 120 14 70 14 90 14 120		08.97- 09.01	CS612	12 1.1
	[AMB]	07.01- 07.01-	CA1754IR CA1811IR	14 120 14 140	Chas. -8E-5-030000 Chas. 8E-5-030001-	07.01- 07.01-	CS612 CS1394	12 1.1 12 1.2
	[ANB]	07.99- 06.00 07.99- 06.00 07.99- 06.00 07.99- 06.00	CA1545IR CA1546IR CA1664IR CA1759IR	14 70 14 90 14 120 14 120		07.99- 06.00	CS612	12 1.1
	[APU]	02.99- 09.01 02.99- 09.01 02.99- 09.01	CA1545IR CA1546IR CA1664IR	14 70 14 90 14 120		02.99- 09.01	CS612	12 1.1
	[ARK]	07.98- 07.99 07.98- 07.99 07.98- 07.99	CA1545IR CA1546IR CA1664IR	14 70 14 90 14 120		07.98- 07.99	CS612	12 1.1
	[AVJ]	11.00- 06.02 11.00- 06.02 11.00- 06.02	CA1754IR CA1769IR CA1811IR	14 120 14 150 14 140		11.00- 06.02	CS612	12 1.1
	[AWT]	06.00- 09.01 06.00- 09.01 06.00- 09.01 06.00- 09.01	CA1545IR CA1546IR CA1664IR CA1759IR	14 70 14 90 14 120 14 120		06.00- 09.01	CS612	12 1.1
	[BEX]	11.02- 12.04 11.02- 12.04 11.02- 12.04	CA1754IR CA1769IR CA1811IR	14 120 14 150 14 140	Chas. -8E-5-030000 Chas. 8E-5-030001-	11.02- 06.04 06.04- 12.04	CS612 CS1394	12 1.1 12 1.2
	[BFB]	04.02- 12.05 04.02- 12.05 04.02- 12.05 Chas. 8E-3-029804- 11.04- AC 07.02-	CA1754IR CA1769IR CA1811IR CA1754IR	14 120 14 150 14 140 14 140	Chas. -8E-5-030000 Chas. 8E-5-030001-	04.02- 06.04 06.04- 12.05	CS612 CS1394	12 1.1 12 1.2
A4 1.9 Hybrid Duo	[AHU]	02.99- 11.00	CA1541IR	14 120		02.99- 11.00	CS624	12 1.8
A4 1.9 Diesel	[AFF]	03.96- 12.98 03.96- 06.00 03.96- 06.00	CA1486IR CA1540IR CA1541IR	14 90 14 90 14 120		03.96- 06.00	CS624	12 1.8
A4 1.9 TDi	[1Z]	11.91- 05.95 01.95- 07.96 06.95- 01.96	CA1147IR CA1486IR CA1403IR	14 120 14 90 14 120		11.94- 07.96	CS624	12 1.8
	[AFN]	02.96- 12.98 02.96- 12.98 Chas. -8D-X-199999 02.96- 07.99 Chas. -8D-X-199999 02.96- 07.99	CA1403IR CA1486IR CA1248IR CA1486IR	14 120 14 90 14 120 14 90		02.96- 07.99	CS624	12 1.8
	[AHH]	04.97- 10.00 04.97- 12.98 04.97- 12.98	CA1486IR CA837IR CA855IR	14 90 14 90 14 120		04.97- 10.00	CS624	12 1.8
	[AHU]	08.96- 07.98 08.96- 12.98 08.96- 12.98	CA1394IR CA1403IR CA1486IR	14 120 14 120 14 90		08.96- 07.98	CS624	12 1.8
	[AJM]	08.98- 11.00 08.98- 12.98 08.98- 11.00 01.99- 09.01 01.99- 09.01	CA1248IR CA1403IR CA1486IR CA1540IR CA1541IR	14 120 14 120 14 90 14 90 14 120		08.98- 09.01 AT 08.98- 09.01	CS1208 CS624	12 1.8 12 1.8
	[AVB]	05.01- 11.01-	CA1678IR CA1541IR	14 140 14 120		05.01-	CS624	12 1.8
	[AVF]	04.01- 05.03 06.03- 12.04	CA1678IR CA1782IR	14 140 14 140		6SP 04.01- 12.03 6SP 01.04-	CS1208 CS1387	12 1.8 12 1.7
	[AVG]	08.99- 06.00 08.99- 06.00 Chas. 8D-X-200001- 08.99- 06.00 Chas. 8D-X-200001- 08.99- 06.00	CA1540IR CA1541IR CA1540IR CA1541IR	14 90 14 120 14 90 14 120		08.99- 06.00	CS624	12 1.8
	[AWX]	12.00- 06.03	CA1678IR	14 140		6SP 12.00- 12.03 5SP 12.00- 06.03 6SP, Chas. 8E-4-170001- 12.00- 06.03 6SP 01.04-	CS1208 CS624 CS1387 CS1387	12 1.8 12 1.8 12 1.7 12 1.7
	[BKE]	06.04- Chas. 8E-4-150001- 11.04-	CA1782IR CA1782IR	14 140 14 140		06.04-	CS624	12 1.8
	[BRB]	11.04- Chas. 8E-4-150001- 11.04-	CA1782IR CA1782IR	14 140 14 140		11.04- 11.04-	CS1423 CS624	12 2.0 12 1.8
A4 1.9 TDi Quattro	[AFN]	07.96- 07.99 08.97- 12.98	CA1403IR CA1486IR	14 120 14 90		07.96- 07.99	CS624	12 1.8
	[AJM]	08.98- 09.01 08.98- 11.00 08.98- 09.01	CA1248IR CA1403IR CA1486IR	14 120 14 120 14 90		AT 08.98- 09.01 08.98- 09.01	CS624 CS1208	12 1.8 12 1.8
	[ATJ]	01.00- 09.01 01.00- 09.01	CA1540IR CA1541IR	14 90 14 120		01.00- 11.00 AT 01.00- 09.01	CS1208 CS624	12 1.8 12 1.8
	[AVF]	11.01- 11.01-	CA1541IR CA1678IR	14 120 14 140		6SP 11.01- 12.03 6SP 01.04-	CS1208 CS1387	12 1.8 12 1.7
	[AVG]	08.99- 06.00 08.99- 06.00 08.99- 01.00	CA1403IR CA1540IR CA1541IR	14 120 14 90 14 120		08.99- 06.00	CS624	12 1.8
A4 2.0	[ALT]	11.00- 12.05 11.00- 12.05 11.00- 12.05	CA1754IR CA1769IR CA1811IR	14 120 14 150 14 140	Chas. 8E-5-030001- 06.04- 12.05 Chas. -8E-5-030000 11.00- 06.04		CS1394 CS612	12 1.2 12 1.1
A4 2.0 FSi	[AWA]	11.01- 12.04 11.01- 12.04 11.01- 12.04	CA1754IR CA1769IR CA1811IR	14 120 14 150 14 140	Chas. 8E-5-030001- 06.04- 12.04 Chas. -8E-5-030000 11.01- 06.04		CS1394 CS612	12 1.2 12 1.1
	[BYK]	10.06- 10.06-	CA1769IR CA1811IR	14 150 14 140		AT 10.06- 10.06-	CS1394 CS1401	12 1.2 12 1.1
A4 2.0 TFSi	[BGB]	11.04- 08.05 11.04- 08.05	CA1769IR CA1811IR	14 150 14 140		AT 11.04- 08.05 11.04- 08.05	CS1394 CS1401	12 1.2 12 1.1
	[BPG]	11.04- 05.06 11.04- 05.06	CA1769IR CA1811IR	14 150 14 140		AT 11.04- 05.06 11.04- 05.06	CS1394 CS1401	12 1.2 12 1.1
	[BUL]	06.05- 06.05-	CA1769IR CA1811IR	14 150 14 140		AT 06.05- 06.05-	CS1394 CS1401	12 1.2 12 1.1
	[BWE]	11.04- 11.04-	CA1769IR CA1811IR	14 150 14 140		AT 11.04- 11.04-	CS1394 CS1401	12 1.2 12 1.1
	[BWT]	01.06- 01.06-	CA1769IR CA1811IR	14 150 14 140		AT 01.06- 01.06-	CS1394 CS1401	12 1.2 12 1.1
	[CAEA]	06.08-	CA2007IR	14 140		06.08-	CS1437	12 1.1
	[CDNB]	06.08-	CA2007IR	14 140		06.08-	CS1437	12 1.1



AUDI Continued

	[CDNC]	06.08-	CA2007IR	14 140		06.08-	CS1437	12 1.1
		10.05-	CA1769IR	14 150		10.05-	CS1394	12 1.2
		10.05-	CA1754IR	14 120		10.05-	CS612	12 1.1
		10.05-	CA1811IR	14 140				
A4 2.0 TFSi Flexible fuel	[CFKA]					11.09-	CS1437	12 1.1
A4 2.0 TFSi Flexible fuel Quattro	[CFKA]					11.09-	CS1437	12 1.1
A4 2.0 TFSi Quattro	[BGB]	11.04-	CA1769IR	14 150		11.04-	CS1401	12 1.1
		11.04-	CA1811IR	14 140		AT 11.04-	CS1394	12 1.2
	[BPG]	11.04-	CA1769IR	14 150		AT 11.04-	CS1394	12 1.2
		11.04-	CA1811IR	14 140		11.04-	CS1401	12 1.1
	[BUL]	06.05-	CA1769IR	14 150		AT 06.05-	CS1394	12 1.2
		06.05-	CA1811IR	14 140		06.05-	CS1401	12 1.1
	[BWE]	09.05-	CA1769IR	14 150		AT 09.05-	CS1394	12 1.2
		09.05-	CA1811IR	14 140		09.05-	CS1401	12 1.1
	[BWT]	06.06-	CA1769IR	14 150		06.06-	CS1401	12 1.1
		06.06-	CA1811IR	14 140		AT 06.06-	CS1394	12 1.2
	[CAEB]	06.08-	CA2007IR	14 140		06.08-	CS1437	12 1.1
	[CDNC]	06.08-	CA2007IR	14 140		06.08-	CS1437	12 1.1
A4 2.0 TDi 16V	[BLB]	11.04- 11.05	CA1782IR	14 140		AT 11.04- 11.05	CS1423	12 2.0
						11.04- 11.05	CS1392	12 2.0
	[BRE]	11.04-	CA1782IR	14 140		11.04-	CS1392	12 2.0
						AT 11.04-	CS1423	12 2.0
A4 2.0 TDi	[BNA]	11.04- 10.05	CA1782IR	14 140		11.04- 10.05	CS1392	12 2.0
						AT 11.04- 10.05	CS1423	12 2.0
	[BPW]	11.04-	CA1782IR	14 140		11.04-	CS1392	12 2.0
						AT 11.04-	CS1423	12 2.0
	[BRC]	01.06-	CA1782IR	14 140		01.06-	CS1392	12 2.0
	[BRD]	06.06-	CA1782IR	14 140		06.06-	CS1392	12 2.0
						AT 06.06-	CS1423	12 2.0
	[BRF]	11.05-	CA1782IR	14 140		AT 11.05-	CS1423	12 2.0
						11.05-	CS1392	12 2.0
	[BVA]	06.06-	CA1782IR	14 140		AT 06.06-	CS1423	12 2.0
						06.06-	CS1392	12 2.0
	[BVG]	09.05- 09.06	CA1782IR	14 140		09.05- 09.06	CS1423	12 2.0
	[CAGA]	11.07-	CA1986IR	14 140				
	[CAGB]	11.07-	CA1986IR	14 140				
	[CAGC]	06.08-	CA1986IR	14 140				
	[CAHA]	01.08-	CA1986IR	14 140				
	[CAHB]	08.08-	CA1986IR	14 140				
A4 2.0 TDi Quattro	[BPW]	01.06-	CA1782IR	14 140		01.06-	CS1392	12 2.0
						AT 01.06-	CS1423	12 2.0
	[BRD]	06.06-	CA1782IR	14 140		AT 06.06-	CS1423	12 2.0
						06.06-	CS1392	12 2.0
	[BVA]	06.06-	CA1782IR	14 140		AT 06.06-	CS1423	12 2.0
						06.06-	CS1392	12 2.0
	[CAGA]	04.08-	CA1986IR	14 140				
	[CAGB]	09.09-	CA1986IR	14 140				
	[CAHA]	08.08-	CA1986IR	14 140				
	[CAHB]	04.09-	CA1986IR	14 140				
A4 2.4	[AGA]	08.97- 07.98	CA837IR	14 90		08.97- 07.98	CS1074	12 1.4
		08.97- 07.98	CA855IR	14 120				
	[AJG]	08.97- 07.98	CA855IR	14 120		08.97- 07.98	CS1074	12 1.4
	[ALF]	03.97- 07.98	CA855IR	14 120		08.97- 07.98	CS1074	12 1.4
		08.97- 07.98	CA837IR	14 90				
	[AML]	08.98- 10.00	CA1546IR	14 90 ▲		08.98- 10.00	CS1074	12 1.4
		08.98- 10.00	CA1588IR	14 120				
	[AMM]	06.00- 10.00	CA1546IR	14 90		06.00- 12.05	CS1074	12 1.4
		06.00- 12.05	CA1588IR	14 120				
		09.01- 12.05	CA1746IR	14 140				
		09.01-	CA1813IR	14 150				
	[APS]	08.98- 06.00	CA1546IR	14 90 ▲		08.98- 06.00	CS1074	12 1.4
		08.98- 06.00	CA1588IR	14 120				
	[APZ]	08.98- 06.00	CA1588IR	14 120		08.98- 06.00	CS1074	12 1.4
	[ARJ]	08.98- 10.00	CA1546IR	14 90 ▲		08.98- 10.00	CS1074	12 1.4
		08.98- 10.00	CA1588IR	14 120				
	[BDV]	09.01- 12.05	CA1746IR	14 140		09.01- 12.05	CS1074	12 1.4
		09.01- 12.05	CA1813IR	14 150				
A4 2.4 Quattro	[AGA]	08.97- 07.98	CA837IR	14 90		08.97- 07.98	CS1074	12 1.4
		08.97- 07.98	CA855IR	14 120				
	[ALF]	06.97- 07.98	CA837IR	14 90		06.97- 01.99	CS1074	12 1.4
		06.97- 07.98	CA855IR	14 120				
		08.98- 01.99	CA1588IR	14 120				
	[AML]	08.98- 12.98	CA1546IR	14 90 ▲		08.98- 12.98	CS1074	12 1.4
		08.98- 12.98	CA1588IR	14 120				
	[APS]	02.99- 10.00	CA1546IR	14 90 ▲		02.99- 10.00	CS1074	12 1.4
		02.99- 10.00	CA1588IR	14 120				
	[APZ]	08.98- 09.01	CA1588IR	14 120		08.98- 09.01	CS1074	12 1.4
	[ARJ]	02.99- 06.00	CA1588IR	14 120		02.99- 06.00	CS1074	12 1.4
A4 2.4 30V Quattro	[AGA]	08.97- 07.98	CA837IR	14 90		08.97- 07.98	CS1074	12 1.4
		08.97- 07.98	CA855IR	14 120				
	[ALF]	08.97- 07.98	CA837IR	14 90		08.97- 07.98	CS1074	12 1.4
		08.97- 07.98	CA855IR	14 120				
	[AML]	08.98- 12.98	CA1546IR	14 90 ▲		08.98- 12.98	CS1074	12 1.4
		08.98- 12.98	CA1588IR	14 120				
	[APS]	08.98- 09.01	CA1546IR	14 90 ▲		08.98- 09.01	CS1074	12 1.4
		08.98- 09.01	CA1588IR	14 120				
	[ARJ]	02.99- 07.99	CA1546IR	14 90 ▲		02.99- 07.99	CS1074	12 1.4
		02.99- 07.99	CA1588IR	14 120				
A4 2.5 TDi	[AFB]	09.97- 12.98	CA1141IR	14 120		09.97- 06.00	CS1114	12 2.0
		01.99- 06.00	CA1588IR	14 120				
	[AKN]	09.97- 12.98	CA1141IR	14 120		09.97- 10.00	CS1114	12 2.0
		01.99- 10.00	CA1588IR	14 120				
	[AYM]	08.01- 06.02	CA1746IR	14 140		08.01- 06.02	CS1114	12 2.0
		08.01- 06.02	CA1813IR	14 150				
	[BCZ]	08.02- 12.05	CA1746IR	14 140		06.03- 12.05	CS1114	12 2.0
		08.02- 12.05	CA1813IR	14 150				
	[BDG]	07.02- 12.05	CA1746IR	14 140		Chas. 8E-1-000001- 06.03- 05.06	CS1114	12 2.0
		07.02- 12.05	CA1813IR	14 150				
		Chas. 8E-5-400001- 11.04- 05.06	CA1813IR	14 150				
		Chas. 8E-1-000001- 11.04- 05.06	CA1746IR	14 140				
		Chas. 8E-1-000001- 11.04- 05.06	CA1813IR	14 150				
	[BFC]	08.02- 12.05	CA1746IR	14 140		08.02- 12.04	CS1114	12 2.0
		08.02- 12.05	CA1813IR	14 150				



A4 2.5 TDi Quattro	[AFB]	09.97- 06.00	CA1588IR	14 120		09.97- 06.00	CS1114	12 2.0	
	[AKE]	11.00- 05.03	CA1746IR	14 140		11.00- 05.03	CS1114	12 2.0	
		11.00- 05.03	CA1813IR	14 150					
	[AKN]	02.99- 10.00	CA1588IR	14 120		02.99- 10.00	CS1114	12 2.0	
	[BAU]	09.01- 12.04	CA1746IR	14 140		11.00- 12.04	CS1114	12 2.0	
		09.01- 12.04	CA1813IR	14 150					
A4 2.5 TDi S4	[BDH]	11.02- 12.04	CA1746IR	14 140		11.02- 12.04	CS1114	12 2.0	
		11.02- 12.04	CA1813IR	14 150					
	[AFB]	09.97- 12.98	CA1141IR	14 120		09.97- 06.00	CS1114	12 2.0	
A4 2.5 TDi S4 Quattro	[AKN]	09.97- 06.00	CA1588IR	14 120					
		08.98- 12.98	CA1141IR	14 120		08.98- 09.01	CS1114	12 2.0	
		08.98- 09.01	CA1588IR	14 120					
A4 2.6	[AFB]	09.97- 12.98	CA1141IR	14 120		09.97- 06.00	CS1114	12 2.0	
	[AKN]	09.97- 06.00	CA1588IR	14 120					
		07.98- 12.98	CA1141IR	14 120		07.98- 07.99	CS1114	12 2.0	
A4 2.6 Quattro	[ABC]	07.98- 07.99	CA1588IR	14 120					
		11.94- 07.98	CA837IR	14 90	Chas. -8D.V.205000	11.94- 04.97	CS725	12 1.4	
		11.94- 07.98	CA855IR	14 120	Chas. 8D.V.205001-	04.97- 07.98	CS1074	12 1.4	
A4 2.7 S4 Quattro	[ABC]	11.94- 07.98	CA837IR	14 90		04.97- 07.98	CS1074	12 1.4	
		11.94- 07.98	CA855IR	14 120		11.94- 04.97	CS725	12 1.4	
A4 2.7 RS4 Quattro	[AGB]	01.99- 11.00	CA1588IR	14 120		Chas. T080001-	09.97- 11.00	CS1074	12 1.4
	[AZB]	10.97- 09.01	CA1588IR	14 120		10.97- 09.01	CS1074	12 1.4	
A4 2.7 TDi	[ASJ]	05.00- 09.01	CA1588IR	14 120		05.00-	CS1074	12 1.4	
	[AZR]	05.00- 09.01	CA1588IR	14 120		05.00- 09.01	CS1074	12 1.4	
A4 2.7 TDi	[BPP]	01.06-	CA1911IR	14 150		01.06-	CS1411	12 2.2	
		01.06-	CA2002IR	14 140					
	[BSG]	11.05- 03.08	CA1911IR	14 150		11.05- 03.08	CS1411	12 2.2	
		11.05- 03.08	CA2002IR	14 140					
	[CAMA]	11.07- 05.08	CA1992IR	14 140					
	[CAMB]	11.07-	CA1992IR	14 140					
	[CGKA]	04.08-	CA1992IR	14 140					
	[CGKB]	11.07-	CA1992IR	14 140					
	A4 2.8	[APR]	08.98- 07.99	CA1588IR	14 120		08.98- 07.99	CS1074	12 1.4
		[ACK]	03.96- 12.98	CA837IR	14 90		03.96- 04.97	CS725	12 1.4
			03.96- 12.98	CA855IR	14 120		04.97- 12.98	CS1074	12 1.4
		[ALG]	08.97- 07.98	CA837IR	14 90		08.97- 12.98	CS1074	12 1.4
		08.97- 07.98	CA855IR	14 120					
		10.97- 12.98	CA1588IR	14 120					
[AMX]		05.00- 09.02	CA1588IR	14 120		05.00- 09.02	CS1074	12 1.4	
[AQD]		06.00- 10.00	CA1546IR	14 90					
		08.98- 02.01	CA1588IR	14 120		08.98- 02.01	CS1074	12 1.4	
		01.99- 02.01	CA1546IR	14 90					
A4 2.8 Quattro	[AAH]	11.94- 07.97	CA837IR	14 90	Chas. -8D.V.205000	11.94- 04.97	CS725	12 1.4	
		11.94- 07.97	CA855IR	14 120	Chas. 8D.V.205001-	04.97- 07.97	CS1074	12 1.4	
	[APR]	02.99- 06.00	CA1546IR	14 90		02.99- 06.00	CS1074	12 1.4	
		02.99- 06.00	CA1588IR	14 120					
	[ACK]	03.96- 07.98	CA837IR	14 90		03.96- 07.97	CS725	12 1.4	
		03.96- 07.98	CA855IR	14 120		04.97- 07.98	CS1074	12 1.4	
	[ALG]	05.97- 07.98	CA837IR	14 90		05.97- 07.98	CS1074	12 1.4	
		05.97- 07.98	CA855IR	14 120					
A4 3.0	[AMX]	07.99- 09.01	CA1546IR	14 90		07.99- 09.01	CS1074	12 1.4	
	[AQD]	07.99- 09.01	CA1588IR	14 120					
		08.98- 06.00	CA1546IR	14 90		08.98- 06.00	CS1074	12 1.4	
		08.98- 06.00	CA1588IR	14 120					
	[AAH]	11.94- 12.96	CA837IR	14 90		11.94- 12.96	CS725	12 1.4	
		11.94- 12.96	CA855IR	14 120					
	A4 3.0 Quattro	[ASN]	11.00- 12.05	CA1588IR	14 120		11.00- 12.05	CS1074	12 1.4
			11.00- 12.05	CA1746IR	14 140		AT 11.00- 12.04	CS624	12 1.8
			11.00- 12.05	CA1813IR	14 150				
[AVK]		11.00-	CA1588IR	14 120		11.00-	CS1074	12 1.4	
		11.00-	CA1746IR	14 140		AT 11.00-	CS624	12 1.8	
A4 3.0 TDi Quattro		11.00-	CA1813IR	14 150					
	[BBJ]	04.01- 02.06	CA1588IR	14 120		04.01- 02.06	CS1074	12 1.4	
		04.01- 02.06	CA1746IR	14 140					
		04.01- 02.06	CA1813IR	14 150					
	[ASN]	11.00- 12.05	CA1588IR	14 120		AT 11.00- 12.04	CS624	12 1.8	
		11.00- 12.05	CA1746IR	14 140		11.00- 12.05	CS1074	12 1.4	
		11.00- 12.04	CA1813IR	14 150					
	[AVK]	09.01- 06.02	CA1588IR	14 120		11.00- 06.02	CS1074	12 1.4	
		09.01- 06.02	CA1746IR	14 140		AT 09.01-	CS624	12 1.8	
		09.01- 06.02	CA1813IR	14 150					
A4 3.0 TDi Quattro	[BBJ]	04.01- 07.06	CA1588IR	14 120		04.01- 07.06	CS1074	12 1.4	
		04.01- 07.06	CA1746IR	14 140					
		04.01- 07.06	CA1813IR	14 150					
	[ASB]	10.05-	CA1911IR	14 150		10.05-	CS1411	12 2.2	
		10.05-	CA2002IR	14 140					
	[BKN]	11.04-	CA1911IR	14 150		11.04-	CS1411	12 2.2	
A4 3.2 FSi		11.04-	CA2002IR	14 140					
	[CAPA]	11.07- 05.08	CA1992IR	14 140					
	[CCWA]	04.08-	CA1992IR	14 140					
	[CCWB]	06.08-	CA1992IR	14 140					
	[AUK]					01.05- 03.09	CS1339	12 1.2	
A4 3.2 FSi Quattro	[AUK]					01.05-	CS1339	12 1.2	
	[BKH]					01.05-	CS1339	12 1.2	
A5 1.8 TFSi	[CABD]	10.07-	CA2007IR	14 140		10.07-	CS1437	12 1.1	
	[CDHB]	05.09-	CA2007IR	14 140		05.09-	CS1437	12 1.1	
						10.11-	CS1437	12 1.1	
A5 1.8 TFSi Sportback	[CDHB]	11.09-	CA2007IR	14 140		11.09-	CS1437	12 1.1	
	[CJEB]					10.11-	CS1437	12 1.1	
A5 2.0 TFSi	[CAEA]	03.09-	CA2007IR	14 140		03.09-	CS1437	12 1.1	
	[CDNB]	11.08-	CA2007IR	14 140		11.08-	CS1437	12 1.1	
	[CDNC]	06.08-	CA2007IR	14 140		06.08-	CS1437	12 1.1	
A5 2.0 TFSi Quattro	[CDNC]	06.08-	CA2007IR	14 140		06.08-	CS1437	12 1.1	
A5 2.0 TFSi Sportback	[CDNC]	09.09-	CA2007IR	14 140		09.09-	CS1437	12 1.1	
A5 2.0 TFSi Sportback Quattro	[CDNC]	09.09-	CA2007IR	14 140		09.09-	CS1437	12 1.1	
A5 2.0 TDi	[CAHA]	08.08-	CA1986IR	14 140					
	[CAHB]	08.08-	CA1986IR	14 140					
A5 2.0 TDi Quattro	[CAHA]	08.08-	CA1986IR	14 140					
A5 2.0 TDi Quattro Sportback	[CAHA]	09.09-	CA1986IR	14 140					
A5 2.0 TDi Sportback	[CAGA]	09.09-	CA1986IR	14 140					
	[CAGB]	09.09-	CA1986IR	14 140					
	[CAHB]	09.09-	CA1986IR	14 140					
	[CMEA]	09.09-	CA1986IR	14 140					



**AUDI Continued**

A5 2.7 TDi	[CAMA]	06.07-	CA1992IR	14 140					
	[CAMB]	09.07-	CA1992IR	14 140					
	[CGKA]	05.08-	CA1992IR	14 140					
A5 2.7 TDi Sportback	[CGKB]	09.07-	CA1992IR	14 140					
	[CGKA]	09.09-	CA1992IR	14 140					
A5 3.0 TDi Quattro	[CAPA]	06.07-	CA1992IR	14 140					
	[CCWA]	05.08-	CA1992IR	14 140					
	[CCWB]	03.08-	CA1992IR	14 140					
A5 3.0 TDi Sportback Quattro	[CCWA]	09.09-	CA1992IR	14 140					
A6 1.8	[ADR]	06.94- 10.97	CA1093IR	14 70	06.94- 10.97	CS612	12 1.1		
		06.94- 10.97	CA1139IR	14 90					
		06.94- 10.97	CA1140IR	14 120					
	[AEB]	02.98- 01.99	CA1093IR	14 70	02.98- 01.99	CS612	12 1.1		
		AT 02.98- 01.99	CA1140IR	14 120					
	[AFY]	05.97- 07.98	CA1139IR	14 90	05.97-	CS612	12 1.1		
		05.97- 07.98	CA1140IR	14 120					
		07.98-	CA1546IR	14 90					
		07.98-	CA1664IR	14 120					
		07.98-	CA1759IR	14 120					
		AT 02.98- 07.98	CA1140IR	14 120					
	[AJP]	07.97- 07.98	CA1093IR	14 70	05.97-	CS612	12 1.1		
		08.98-	CA1546IR	14 90					
		08.98-	CA1664IR	14 120					
		08.98-	CA1759IR	14 120					
		AT 07.97- 07.98	CA1140IR	14 120					
		AT 08.98-	CA1664IR	14 120					
	[ANB]	01.99- 09.00	CA1546IR	14 90	01.99- 09.00	CS612	12 1.1		
		01.99- 09.00	CA1664IR	14 120					
	[APU]	11.98- 04.01	CA1545IR	14 70	11.98- 04.01	CS612	12 1.1		
		11.98- 04.01	CA1546IR	14 90					
		11.98- 04.01	CA1664IR	14 120					
	[AQE]	01.99- 04.01	CA1546IR	14 90	01.99- 04.01	CS612	12 1.1		
		01.99- 04.01	CA1664IR	14 120					
	[ARH]	01.99- 04.01	CA1546IR	14 90	01.99- 04.01	CS612	12 1.1		
		01.99- 04.01	CA1664IR	14 120					
	[ARK]	01.99- 05.99	CA1546IR	14 90	01.99- 05.99	CS612	12 1.1		
		01.99- 05.99	CA1664IR	14 120					
	[AWT]	05.00- 04.01	CA1759IR	14 120	05.00- 04.01	CS612	12 1.1		
	A6 1.8 Quattro	[ADR]	10.95- 10.97	CA1093IR	14 70	10.95- 10.97	CS612	12 1.1	
			10.95- 10.97	CA1139IR	14 90				
			10.95- 10.97	CA1140IR	14 120				
	A6 1.8 Turbo	[AEB]	04.97- 07.98	CA1093IR	14 70	04.97- 01.99	CS612	12 1.1	
			04.97- 07.98	CA1140IR	14 120				
			08.98- 01.99	CA1546IR	14 90				
			08.98- 01.99	CA1664IR	14 120				
		[AJL]	06.97- 07.98	CA1093IR	14 70	06.97-	CS612	12 1.1	
			08.98-	CA1546IR	14 90				
			AT 06.97- 07.98	CA1140IR	14 120				
		AT 08.98-	CA1664IR	14 120					
		AC 06.97- 07.98	CA1140IR	14 120					
[ANB]		01.99- 09.00	CA1546IR	14 90	01.99- 09.00	CS612	12 1.1		
		01.99- 09.00	CA1664IR	14 120					
[APU]		11.98- 04.01	CA1545IR	14 70	11.98- 04.01	CS612	12 1.1		
		11.98- 04.01	CA1546IR	14 90					
		11.98- 04.01	CA1664IR	14 120					
[ARK]		01.99- 05.99	CA1546IR	14 90	01.99- 05.99	CS612	12 1.1		
		01.99- 05.99	CA1664IR	14 120					
[AWT]		05.00- 04.01	CA1759IR	14 120	05.00- 04.01	CS612	12 1.1		
A6 1.8 Turbo Quattro		[AEB]	02.97- 01.99	CA1093IR	14 70	02.97- 01.99	CS612	12 1.1	
			12.97- 07.98	CA1140IR	14 120				
			08.98- 01.99	CA1546IR	14 90				
			08.98- 01.99	CA1664IR	14 120				
			AT 02.97- 01.99	CA1140IR	14 120				
		[AJL]	06.97- 07.98	CA1093IR	14 70	06.97-	CS612	12 1.1	
			02.98-	CA1546IR	14 90				
			AT 06.97- 07.98	CA1140IR	14 120				
			AT 02.98-	CA1664IR	14 120				
		[ANB]	01.99- 09.00	CA1546IR	14 90	01.99- 09.00	CS612	12 1.1	
			01.99- 09.00	CA1664IR	14 120				
		[APU]	11.98- 05.01	CA1545IR	14 70	11.98- 05.01	CS612	12 1.1	
			11.98- 05.01	CA1546IR	14 90				
			11.98- 05.01	CA1664IR	14 120				
		[ARK]	01.99- 05.99	CA1546IR	14 90	01.99- 05.99	CS612	12 1.1	
			01.99- 05.99	CA1664IR	14 120				
		[AWT]	05.00- 01.05	CA1759IR	14 120	05.00- 01.05	CS612	12 1.1	
		A6 1.9 TDi	[1Z]	06.94- 06.96	CA1147IR	14 120	06.94- 09.96	CS624	12 1.8
				06.94- 06.96	CA852IR	14 70			
			[AFN]	04.97- 07.98	CA1403IR	14 120	04.97- 04.01	CS624	12 1.8
				07.98- 04.01	CA1541IR	14 120			
			[AHU]	06.96- 10.97	CA1147IR	14 120	06.96- 10.97	CS624	12 1.8
			06.96- 10.97	CA852IR	14 70				
	[AJM]		02.98- 04.01	CA1541IR	14 120	05.99-	CS624	12 1.8	
	[AVF]		08.01- 05.04	CA1541IR	14 120	6SP 12.03- 05.04	CS1387	12 1.7	
			08.01- 05.04	CA1678IR	14 140	6SP 08.01- 12.03	CS1208	12 1.8	
						AT 08.01- 05.04	CS624	12 1.8	
			08.99- 10.00	CA1403IR	14 120	08.99- 10.00	CS624	12 1.8	
			08.99- 10.00	CA1541IR	14 120				
			08.01-	CA1541IR	14 120	6SP 08.01- 12.03	CS1208	12 1.8	
			08.01-	CA1678IR	14 140	6SP 01.04-	CS1387	12 1.7	
						5SP 08.01- 05.04	CS624	12 1.8	
						AT 08.01- 05.04	CS624	12 1.8	
	A6 2.0		[ABK]	06.94- 10.97	CA1244IR	14 90	06.94- 10.97	CS612	12 1.1
				06.94- 10.97	CA908IR	14 70			
			[ALT]	08.01- 05.04	CA1754IR	14 120	08.01- 05.04	CS612	12 1.1
				08.01- 05.04	CA1769IR	14 150			
				08.01- 05.04	CA1811IR	14 140			
		[AAE]	06.94- 08.96	CA1244IR	14 90	06.94- 08.96	CS612	12 1.1	
A6 2.0 16V	[ACE]	06.94- 10.97	CA842IR	14 90	06.94- 10.97	CS612	12 1.1		
		06.94- 10.97	CA908IR	14 70					
	[ACE]	06.94- 12.97	CA842IR	14 90	06.94- 12.97	CS612	12 1.1		





A6 2.0 TFSi	[BPJ]	06.05-	CA1996IR	14 150	06.05-	CS1401	12 1.1
	[BYK]	06.05-	CA1996IR	14 150	06.05-	CS1401	12 1.1
	[CDNB]				05.11-	CS1437	12 1.1
A6 2.0 TDi	[BLB]	07.04-	CA1910IR	14 180	AT 07.04-07.04-	CS1423	12 2.0
						CS1392	12 2.0
	[BNA]	06.05-	CA1910IR	14 180	AT 06.05-06.05-	CS1423	12 2.0
						CS1392	12 2.0
	[BRE]	07.04-	CA1910IR	14 180	06.05-	CS1392	12 2.0
					AT 06.05-	CS1423	12 2.0
	[BRF]	06.05-	CA1910IR	14 180	06.05-	CS1392	12 2.0
					AT 06.05-	CS1423	12 2.0
	[BVG]	09.05-	CA1910IR	14 180	09.05-06.06-	CS1392	12 2.0
	[CAGB]				AT 06.05-06.05-	CS1423	12 2.0
						CS1392	12 2.0
	[CAHB]				AT 04.09-04.09-	CS1423	12 2.0
						CS1392	12 2.0
A6 2.3	[AAR]	06.94-07.94	CA855IR	14 120	06.94-12.95	CS282	12 1.1
		07.94-12.95	CA1141IR	14 120			
A6 2.3 Quattro	[AAR]	06.94-07.97	CA1141IR	14 120	08.94-07.97	CS282	12 1.1
		06.94-07.97	CA837IR	14 90			
		06.94-07.94	CA855IR	14 120			
A6 2.4	[AGA]	04.97-07.98	CA837IR	14 90	04.97-01.99	CS1074	12 1.4
		04.97-07.98	CA855IR	14 120			
		08.98-01.99	CA1588IR	14 120			
	[AJG]	04.97-07.98	CA837IR	14 90	04.97-07.98	CS1074	12 1.4
		04.97-07.98	CA855IR	14 120			
		08.98-	CA1588IR	14 120			
	[ALF]	06.97-07.98	CA837IR	14 90	06.97-	CS1074	12 1.4
		06.97-07.98	CA855IR	14 120			
		08.98-	CA1588IR	14 120			
	[ALW]	08.97-07.98	CA855IR	14 120	08.97-01.99	CS1074	12 1.4
		08.98-01.99	CA1588IR	14 120			
	[AML]	06.00-04.01	CA1546IR	14 90	08.98-09.01	CS1074	12 1.4
		08.98-09.01	CA1588IR	14 120			
	[AMM]	06.00-05.04	CA1588IR	14 120	06.00-05.04	CS1074	12 1.4
	[APC]	04.98-07.98	CA855IR	14 120	04.98-01.01	CS1074	12 1.4
		08.98-01.01	CA1588IR	14 120			
	[APS]	11.98-	CA1588IR	14 120	11.98-	CS1074	12 1.4
	[APZ]	11.98-05.00	CA1588IR	14 120	11.98-05.00	CS1074	12 1.4
	[ARJ]	11.98-	CA1588IR	14 120	11.98-	CS1074	12 1.4
	[ARN]	02.99-	CA1588IR	14 120	02.99-	CS1074	12 1.4
		Chas. 4B -X000001 02.99-	CA1588IR	14 120			
		06.01-	CA1588IR	14 120	06.01-05.04	CS1074	12 1.4
	[ASM]	08.01-05.04	CA1588IR	14 120	08.01-05.04	CS1074	12 1.4
[BDV]	08.01-05.04	CA1746IR	14 140				
				05.04-	CS1339	12 1.2	
A6 2.4 Quattro	[AGA]	04.97-07.98	CA837IR	14 90	04.97-	CS1074	12 1.4
		04.97-07.98	CA855IR	14 120			
		08.98-	CA1588IR	14 120			
	[AJG]	02.97-07.98	CA837IR	14 90	02.97-01.99	CS1074	12 1.4
		02.97-07.98	CA855IR	14 120			
		08.98-01.99	CA1588IR	14 120			
	[ALF]	06.97-07.98	CA837IR	14 90	06.97-	CS1074	12 1.4
		06.97-07.98	CA855IR	14 120			
		08.98-	CA1588IR	14 120			
	[AML]	06.00-05.01	CA1546IR	14 90	06.00-05.01	CS1074	12 1.4
		06.00-05.01	CA1588IR	14 120			
	[APC]	08.98-05.01	CA1546IR	14 90	08.98-05.01	CS1074	12 1.4
		08.98-05.01	CA1588IR	14 120			
	[APS]	11.98-	CA1588IR	14 120	11.98-	CS1074	12 1.4
	[APZ]	11.98-05.00	CA1588IR	14 120	11.98-05.00	CS1074	12 1.4
	[ARJ]	11.98-	CA1588IR	14 120	11.98-	CS1074	12 1.4
[BDV]	08.01-05.04	CA1588IR	14 120	08.01-05.04	CS1074	12 1.4	
	08.01-05.04	CA1746IR	14 140				
				01.05-	CS1339	12 1.2	
A6 2.5 TDi	[AEL]	08.94-10.97	CA1141IR	14 120	08.94-10.97	CS350	12 2.2
	[AFB]	04.97-07.98	CA1141IR	14 120	04.97-05.00	CS1114	12 2.0
		08.98-05.00	CA1588IR	14 120			
	[AKE]	02.00-08.03	CA1588IR	14 120	02.00-08.03	CS1114	12 2.0
		02.00-08.03	CA1746IR	14 140			
	[AKN]	12.97-12.98	CA1141IR	14 120	11.98-04.01	CS1114	12 2.0
		11.98-04.01	CA1588IR	14 120			
	[AYM]	08.01-06.02	CA1588IR	14 120	08.01-06.02	CS1114	12 2.0
		08.01-06.02	CA1746IR	14 140			
	[BAU]	02.00-05.04	CA1588IR	14 120	11.02-01.05	CS1114	12 2.0
		11.02-01.05	CA1746IR	14 140			
	[BCZ]	11.02-05.04	CA1588IR	14 120	11.02-05.04	CS1114	12 2.0
		11.02-05.04	CA1746IR	14 140			
	[BDG]	11.02-05.04	CA1588IR	14 120	11.02-05.04	CS1114	12 2.0
		11.02-05.04	CA1746IR	14 140			
	[BDH]	02.00-05.04	CA1588IR	14 120	11.02-01.05	CS1114	12 2.0
		11.02-01.05	CA1746IR	14 140			
	[BFC]	07.02-08.03	CA1588IR	14 120	07.02-08.03	CS1114	12 2.0
		07.02-08.03	CA1746IR	14 140			
	[BND]	02.00-08.03	CA1588IR	14 120	02.00-08.03	CS1114	12 2.0
	02.00-08.03	CA1746IR	14 140				
[AAT]	06.94-10.97	CA1141IR	14 120	06.94-10.97	CS350	12 2.2	
	Chas. 4A.S.012157-06.94-10.97	CA1141IR	14 120				
	Chas. -4A.S.012156-06.94-10.97	CA521IR	14 90				
	Chas. -4A.S.012156-06.94-10.97	CA837IR	14 90				
A6 2.5 TDi Quattro	[AEL]	07.95-10.97	CA1141IR	14 120	07.95-10.97	CS350	12 2.2
	[AFB]	07.97-07.98	CA1141IR	14 120	07.97-05.00	CS1114	12 2.0
		08.98-05.00	CA1588IR	14 120			
	[AKE]	02.00-08.03	CA1588IR	14 120	02.00-08.03	CS1114	12 2.0
		02.00-08.03	CA1746IR	14 140			
	[AKN]	12.97-12.98	CA1141IR	14 120	12.97-06.99	CS1114	12 2.0
		01.99-06.99	CA1588IR	14 120			
	[BAU]	02.03-01.05	CA1588IR	14 120	02.03-01.05	CS1114	12 2.0
	02.03-01.05	CA1746IR	14 140				
[BDH]	11.02-01.05	CA1588IR	14 120	11.02-01.05	CS1114	12 2.0	
	11.02-01.05	CA1746IR	14 140				
A6 2.6	[ABC]	06.94-07.98	CA837IR	14 90	04.97-07.98	CS1074	12 1.4
		06.94-07.98	CA855IR	14 120	06.94-10.97	CS725	12 1.4



**AUDI Continued**

	[ACZ]	06.94- 10.97	CA837IR	14 90		06.94- 10.97	CS725	12 1.4
		06.94- 10.97	CA855IR	14 120				
A6 2.6 Quattro	[ABC]	06.94- 12.97	CA837IR	14 90		06.94- 12.97	CS725	12 1.4
		06.94- 12.97	CA855IR	14 120				
A6 2.7	[AJK]	02.99- 05.01	CA1546IR	14 90		02.99- 05.01	CS1074	12 1.4
		02.99- 05.01	CA1588IR	14 120				
A6 2.7 Quattro	[AJK]	10.97- 08.00	CA1546IR	14 90		10.97- 08.00	CS1074	12 1.4
		10.97- 08.00	CA1588IR	14 120				
	[AZA]	09.00- 05.01	CA1588IR	14 120		09.00- 05.01	CS1074	12 1.4
A6 2.7 Turbo Quattro	[ARE]	08.01- 06.02	CA1588IR	14 120		08.01- 06.02	CS1074	12 1.4
	[BES]	07.02- 01.05	CA1588IR	14 120		07.02- 01.05	CS1074	12 1.4
A6 2.7 TDi	[BPP]	11.04-	CA1937IR	14 180	Chas. 4F5076501-	11.04-	CS1411	12 2.2
	[BSG]	11.04-	CA1937IR	14 180		11.04-	CS1411	12 2.2
A6 2.7 TDi Allroad Quattro	[BPP]	05.06-	CA1937IR	14 180		05.06-	CS1411	12 2.2
	[BSG]	05.06-	CA1937IR	14 180		05.06-	CS1411	12 2.2
A6 2.7 TDi Quattro	[BPP]	11.04-	CA1937IR	14 180	Chas. -4F5076500	11.04-	CS1411	12 2.2
	[BSG]	06.05-	CA1937IR	14 180		06.05-	CS1411	12 2.2
A6 2.8	[APR]	11.98-	CA1588IR	14 120		11.98-	CS1074	12 1.4
	[ACK]	10.95- 07.98	CA837IR	14 90		04.97-	CS1074	12 1.4
		10.95- 07.98	CA855IR	14 120		10.95- 10.97	CS725	12 1.4
		08.98-	CA1588IR	14 120				
	[AEJ]	06.94- 10.97	CA837IR	14 90		06.94- 10.97	CS725	12 1.4
		06.94- 10.97	CA855IR	14 120				
	[AGE]	10.97- 07.98	CA1139IR	14 90		10.97-	CS1074	12 1.4
		10.97- 07.98	CA1140IR	14 120				
		10.97- 07.98	CA837IR	14 90				
		10.97- 07.98	CA855IR	14 120				
		08.98-	CA1546IR	14 90				
		08.98-	CA1588IR	14 120				
	[ALG]	06.97- 07.98	CA837IR	14 90		06.97- 01.99	CS1074	12 1.4
		06.97- 07.98	CA855IR	14 120				
		08.98- 01.99	CA1546IR	14 90				
		08.98- 01.99	CA1588IR	14 120				
	[AMX]	06.00- 05.01	CA1546IR	14 90		06.00- 04.01	CS1074	12 1.4
		06.00- 05.01	CA1588IR	14 120				
	[AQD]	11.98- 04.01	CA1546IR	14 90		11.98- 04.01	CS1074	12 1.4
		11.98- 04.01	CA1588IR	14 120				
	[ATX]	07.99-	CA1588IR	14 120		07.99-	CS1074	12 1.4
	[BBG]	07.99-	CA1588IR	14 120		07.99-	CS1074	12 1.4
	[AAH]	06.94- 10.97	CA837IR	14 90		06.94- 10.97	CS725	12 1.4
		06.94- 10.97	CA855IR	14 120				
A6 2.8 Quattro	[APR]	11.98-	CA1588IR	14 120		11.98-	CS1074	12 1.4
	[ACK]	10.95- 07.98	CA837IR	14 90		10.95- 10.97	CS725	12 1.4
		10.95- 07.98	CA855IR	14 120		04.97-	CS1074	12 1.4
		08.98-	CA1588IR	14 120				
	[AEJ]	06.94- 10.97	CA855IR	14 120		06.94- 10.97	CS725	12 1.4
	[ALG]	06.97- 07.98	CA837IR	14 90		06.97- 01.99	CS1074	12 1.4
		06.97- 07.98	CA855IR	14 120				
		08.98- 01.99	CA1546IR	14 90				
		08.98- 01.99	CA1588IR	14 120				
	[AMX]	05.00- 09.02	CA1588IR	14 120		05.00- 09.02	CS1074	12 1.4
		06.00- 05.01	CA1546IR	14 90				
	[AQD]	11.98- 05.01	CA1546IR	14 90		11.98- 05.01	CS1074	12 1.4
		11.98- 05.01	CA1588IR	14 120				
	[AAH]	06.94- 10.97	CA855IR	14 120		06.94- 10.97	CS725	12 1.4
A6 2.8 FSi	[BDX]					11.06-	CS1339	12 1.2
	[CCDA]					10.08-	CS1339	12 1.2
	[CCEA]					10.08-	CS1339	12 1.2
A6 2.8 FSi Quattro	[BDX]					06.07-	CS1339	12 1.2
	[CCDA]					10.08-	CS1339	12 1.2
	[CCEA]					10.08-	CS1339	12 1.2
A6 3.0	[ASN]	08.01- 01.05	CA1588IR	14 120		08.01- 01.05	CS1074	12 1.4
		08.01- 01.05	CA1746IR	14 140				
		08.01- 01.05	CA1813IR	14 150				
A6 3.0 Quattro	[ASN]	08.01- 05.04	CA1588IR	14 120		08.01- 05.04	CS1074	12 1.4
		08.01- 05.04	CA1746IR	14 140				
		08.01- 05.04	CA1813IR	14 150				
	[BBJ]	06.01- 05.06	CA1588IR	14 120		06.01- 05.06	CS1074	12 1.4
		06.01- 05.06	CA1746IR	14 140				
		06.01- 07.04	CA1813IR	14 150				
A6 3.0 TFSi Quattro	[CAJA]					10.08-	CS1339	12 1.2
	[CCAA]					10.08- 08.11	CS1339	12 1.2
A6 3.0 TDi Allroad Quattro	[ASB]	05.06-	CA1937IR	14 180		05.06-	CS1411	12 2.2
	[BNG]	05.06-	CA1937IR	14 180		05.06-	CS1411	12 2.2
A6 3.0 TDi Quattro	[ASB]	06.06-	CA1937IR	14 180		06.06-	CS1411	12 2.2
	[BMK]	05.04-	CA1937IR	14 180		05.04-	CS1411	12 2.2
	[BNG]	05.04-	CA1937IR	14 180		05.04-	CS1411	12 2.2
A6 3.2 FSi	[AUK]					05.04- 05.09	CS1339	12 1.2
	[BKH]					05.04- 05.09	CS1339	12 1.2
	[CALA]					05.09- 03.11	CS1339	12 1.2
A6 3.2 FSi Allroad Quattro	[AUK]					05.06-	CS1339	12 1.2
A6 3.2 FSi Quattro	[AUK]					05.04-	CS1339	12 1.2
	[BKH]					05.04-	CS1339	12 1.2
A6 4.2 Quattro	[ARS]					11.98-	CS1041	12 1.8
	[ASG]					06.00-	CS1041	12 1.8
	[AWN]					06.00-	CS1041	12 1.8
	[BAT]					05.04-	CS1041	12 1.8
A8 2.5 TDi	[AFB]	06.97- 10.98	CA1141IR	14 120		06.97- 04.00	CS1114	12 2.0
	[AKE]					05.00- 09.02	CS1114	12 2.0
	[AKN]	11.97- 10.98	CA1141IR	14 120		11.97- 09.02	CS1114	12 2.0
		07.98- 09.02	CA1588IR	14 120				
A8 2.5 TDi Quattro	[AFB]	07.97- 09.98	CA1141IR	14 120		07.97- 06.00	CS1114	12 2.0
		10.98- 06.00	CA1588IR	14 120				
	[AKE]					11.99- 09.02	CS1114	12 2.0
	[AKN]	07.97- 09.98	CA1141IR	14 120		03.98- 04.99	CS1114	12 2.0
		10.98- 04.99	CA1588IR	14 120				
A8 2.8	[APR]	01.99- 04.99	CA1588IR	14 120		01.99- 04.99	CS1074	12 1.4
	[ACK]	07.95- 12.98	CA837IR	14 90		04.97- 12.98	CS1074	12 1.4
		07.95- 12.98	CA855IR	14 120		07.95- 04.97	CS725	12 1.4
	[AEJ]	07.95- 03.96	CA855IR	14 120		07.95- 03.96	CS725	12 1.4
	[ALG]	10.97- 12.98	CA837IR	14 90		10.97- 12.98	CS1074	12 1.4
		10.97- 12.98	CA855IR	14 120				
	[AMX]					05.00- 09.02	CS1074	12 1.4
	[AQD]	01.99- 02.01	CA1588IR	14 120		01.99- 02.01	CS1074	12 1.4



	[AAH]	03.94- 03.96 03.94- 03.96	CA837IR CA855IR	14 90 14 120		03.94- 03.96	CS725	12 1.4		
A8 2.8 Quattro	[APR]	01.99- 04.99	CA1588IR	14 120		01.99- 04.99	CS1074	12 1.4		
	[ACK]	04.96- 12.98 04.96- 12.98	CA837IR CA855IR	14 90 14 120		04.97- 12.98 04.96- 04.97	CS1074 CS725	12 1.4 12 1.4		
	[AEJ]	07.95- 03.96	CA855IR	14 120		07.95- 03.96	CS725	12 1.4		
	[AMX]	05.00- 09.02	CA1588IR	14 120		05.00- 09.02	CS1074	12 1.4		
	[AQD]	01.99- 04.99	CA1588IR	14 120		01.99- 04.99	CS1074	12 1.4		
	[AAH]	09.94- 03.96 09.94- 03.96	CA837IR CA855IR	14 90 14 120		09.94- 03.96	CS725	12 1.4		
	A8 2.8 FSi	[BDX]					08.07-	CS1339	12 1.2	
A8 3.0	[ASN]	08.03- 08.03-	CA1588IR CA1759IR	14 120 14 120		08.03-	CS1074	12 1.4		
	[BBJ]					07.03-	CS1074	12 1.4		
A8 3.0 TDi Quattro	[ASB]	08.03-	CA1937IR	14 180						
	[BNG]	11.03-	CA1937IR	14 180		11.03-	CS1411	12 2.2		
A8 3.2 FSi	[BPK]					06.05-	CS1339	12 1.2		
A8 3.2 FSi Quattro	[BPK]					06.05-	CS1339	12 1.2		
A8 3.7	[AEW]	07.95- 12.98	CA1232IR	14 120		07.95- 12.98	CS1041	12 1.8		
	[AKC]					05.00- 09.02	CS1041	12 1.8		
	[AQG]					11.98- 02.01	CS1041	12 1.8		
A8 3.7 Quattro	[AEW]	07.95- 10.98	CA1232IR	14 120		07.95- 12.98	CS1041	12 1.8		
	[AKC]					05.00- 09.02	CS1041	12 1.8		
	[AKJ]	07.95- 10.98	CA1232IR	14 120		07.95- 12.98	CS1041	12 1.8		
	[AQG]					11.98- 02.01	CS1041	12 1.8		
A8 4.2 Quattro	[ABZ]	03.94- 11.98	CA1232IR	14 120		03.94- 11.98	CS1041	12 1.8		
	[AEM]	06.94- 07.96	CA1232IR	14 120		06.94- 07.96	CS1041	12 1.8		
	[AKG]	04.97- 10.98	CA1232IR	14 120		04.97- 12.98	CS1041	12 1.8		
	[AQF]					11.98- 09.02	CS1041	12 1.8		
	[ARU]					02.99-	CS1041	12 1.8		
	[AUW]					05.00- 07.07	CS1041	12 1.8		
Allroad 2.5 TDi Quattro	[AUX]					11.98-	CS1041	12 1.8		
	[AKE]	05.00- 05.03	CA1588IR	14 120		05.00- 05.03	CS1114	12 2.0		
	[BAU]	02.03- 01.05 02.03- 01.05	CA1446IR CA1588IR	14 90 14 120		02.03- 08.05	CS1114	12 2.0		
	[BCZ]	06.03-	CA1746IR	14 140		06.03-	CS1114	12 2.0		
Allroad 2.7 Turbo Quattro	[ARE]	05.00- 06.02 05.00- 05.02	CA1588IR CA1746IR	14 120 14 140		05.00- 06.02	CS1074	12 1.4		
	[BES]	07.02- 08.05 07.02- 08.05	CA1588IR CA1746IR	14 120 14 140		07.02- 08.05	CS1074	12 1.4		
	[BAS]					07.02-	CS1074	12 1.4		
Cabriole 1.8	[ADR]	01.97- 08.00	CA1093IR	14 70		01.97- 08.00	CS612	12 1.1		
Cabriole 1.9 TDi	[IZ]	07.95- 07.96 AT 07.95- 07.96	CA1147IR CA829IR	14 120 14 90		06.95- 07.96	CS624	12 1.8		
	[AHU]	07.96- 08.00 AT 07.96- 08.00	CA1147IR CA829IR	14 120 14 90		07.96- 08.00	CS624	12 1.8		
	[ABK]	01.93- 09.98 01.93- 09.98	CA843IR CA908IR	14 90 14 70		01.93- 09.98	CS612	12 1.1		
Cabriole 2.0	[ACE]	06.95- 07.96	CA842IR	14 90		05.95- 07.96	CS612	12 1.1		
Cabriole 2.3	[NG]	05.91- 07.94 05.91- 07.94	CA521IR CA700IR	14 90 14 115		05.91- 07.94	CS282	12 1.1		
	[ABC]	01.94-	CA855IR	14 120		01.94-	CS725	12 1.4		
Cabriole 2.6	[ACZ]	06.96- 12.99 Chas. 8G-P-004 001- 05.95- 12.99	CA837IR CA855IR	14 90 14 120		05.95- 12.99	CS725	12 1.4		
	[AAH]	11.92- 08.00 11.92- 08.00	CA837IR CA855IR	14 90 14 120		11.92- 08.00	CS725	12 1.4		
	[YN]	07.80- 08.81 07.80- 08.81	CA1411R CA52IR	14 65 14 55		07.80- 08.81	CS297	12 0.95		
Coupe 1.8	[DD]	08.81- 08.82 08.81- 08.82	CA1411R CA52IR	14 65 14 55		08.81- 08.82	CS297	12 0.95		
	[DZ]	08.89- 07.91 08.89- 07.91	CA298IR CA320IR	14 65 14 90		08.89- 07.91	CS509	12 1.0		
	[DS]	09.82- 05.83 09.82- 10.88 09.82- 05.83 06.83- 07.85 06.83- 07.85 08.85- 10.88	CA1411R CA320IR CA52IR CA241IR CA242IR CA298IR	14 65 14 90 14 55 14 55 14 65 14 65		09.82- 10.88	CS297	12 0.95		
Coupe 1.8 GT	[DZ]	08.86- 10.88 08.86- 10.88 08.86- 10.88	CA296IR CA298IR CA320IR	14 55 14 65 14 90		08.86- 10.88	CS297	12 0.95		
	[JN]	01.85- 07.85 01.85- 07.88 08.85- 07.88	CA242IR CA320IR CA298IR	14 65 14 90 14 65		01.85- 07.88	CS297	12 0.95		
	[JV]	01.85- 07.85 01.85- 07.85 01.85- 07.85 08.85- 07.87 08.85- 07.87	CA241IR CA242IR CA320IR CA296IR CA298IR	14 55 14 65 14 90 14 55 14 65		09.82- 10.88	CS297	12 0.95		
	[PV]	08.86- 10.88 08.86- 10.88 08.86- 10.88	CA296IR CA298IR CA320IR	14 55 14 65 14 90		08.86- 10.88	CS297	12 0.95		
	[SF]	04.86- 10.88 08.86- 10.88	CA298IR CA296IR	14 65 14 55		04.86- 10.88	CS297	12 0.95		
	Coupe 1.8 GT Quattro	[DS]	09.85- 10.88 09.85- 10.88 09.85- 10.88	CA296IR CA298IR CA320IR	14 55 14 65 14 90		09.85- 10.88	CS297	12 0.95	
		[DZ]	12.84- 10.88 12.84- 10.88 12.84- 10.88	CA296IR CA298IR CA320IR	14 55 14 65 14 90		12.84- 10.88	CS297	12 0.95	
		[JN]	09.85- 10.88 09.85- 10.88 09.85- 10.88	CA296IR CA298IR CA320IR	14 55 14 65 14 90		09.85- 10.88	CS297	12 0.95	
		[NE]	09.85- 10.88 09.85- 10.88 09.85- 10.88	CA296IR CA298IR CA320IR	14 55 14 65 14 90		09.85- 10.88	CS297	12 0.95	
		Coupe 1.9	[WN]	08.80- 07.81 08.80- 07.81 08.81- 05.83 08.81- 05.83 08.82- 07.83	CA125IR# CA163IR CA1411R CA52IR CA320IR	14 65 14 75 14 65 14 55 14 90		09.82- 07.83 08.80- 08.82	CS282 CS132	12 1.1 12 1.1
Coupe 2.0			[3A]	05.89- 07.90 05.89- 07.90	CA298IR CA320IR	14 65 14 90		AT 05.89- 07.90 05.89- 07.90	CS297 CS509	12 0.95 12 1.0



AUDI Continued

	[ABK]	09.91- 07.92 CA842IR 14 90		05.89- 12.95 CS612 12 1.1
		08.92- 12.95 CA1244IR 14 90		
		08.92- 12.95 CA908IR 14 70		
	[ACE]	08.92- 07.93 CA842IR 14 90		08.92- 12.95 CS612 12 1.1
		07.93- 12.95 CA1244IR 14 90		
	[HP]	08.83- 07.84 CA320IR 14 90		09.83- 07.86 CS282 12 1.1
		08.85- 07.86 CA911IR# 14 65		
	[JS]	09.83- 07.86 CA320IR 14 90		09.83- 07.86 CS282 12 1.1
		08.85- 07.86 CA911IR# 14 65		
		AC 08.85- 07.86 CA708IR 14 90 ▲		
	[SK]	03.86- 04.88 CA296IR 14 55		03.86- 04.88 CS282 12 1.1
		03.86- 04.88 CA298IR 14 65		
		03.86- 04.88 CA320IR 14 90		
		03.86- 04.88 CA911IR# 14 65		
	[AAD]	08.90- 07.91 CA298IR 14 65		AT 08.90- 07.91 CS297 12 0.95
		08.90- 07.91 CA320IR 14 90		08.90- 07.91 CS509 12 1.0
Coupe 2.0 16V	[6A]	01.92- 07.92 CA842IR 14 90		01.92- 07.92 CS612 12 1.1
Coupe 2.0 20V	[NM]	08.89- 07.91 CA343IR 14 90		08.89- 07.91 CS282 12 1.1
Coupe 2.0 20V Quattro	[NM]	08.89- 07.91 CA521IR 14 90		08.89- 07.91 CS282 12 1.1
Coupe 2.1	[WE]	01.81- 05.83 CA141IR 14 65		01.81- 07.83 CS282 12 1.1
		01.81- 05.83 CA52IR 14 55		
		05.83- 07.83 CA320IR 14 90		
Coupe 2.1 Turbo 20V Quattro	[KW]			05.84- 07.87 CS282 12 1.1
Coupe 2.1 Turbo Quattro	[GV]	07.80- 07.81 CA163IR 14 75		07.80- 07.87 CS132 12 1.1
		06.83- 07.87 CA320IR 14 90		07.80- 07.87 CS282 12 1.1
	[WR]	07.80- 07.81 CA163IR 14 75		07.80- 07.87 CS132 12 1.1
		06.83- 07.87 CA320IR 14 90		07.80- 07.87 CS282 12 1.1
Coupe 2.2 Quattro	[JT]	12.84- 10.88 CA320IR 14 90		12.84- 10.88 CS282 12 1.1
		08.85- 10.88 CA911IR# 14 65		
		AC 08.85- 10.88 CA708IR 14 90 ▲		
	[KV]	10.84- 10.88 CA320IR 14 90		12.84- 07.91 CS282 12 1.1
		08.85- 10.88 CA911IR# 14 65		
		11.88- 07.91 CA521IR 14 90		
		AC 08.85- 10.88 CA708IR 14 90 ▲		
Coupe 2.2 S2 Quattro	[3B]	09.90- 09.92 CA521IR 14 90		09.90- 09.92 CS282 12 1.1
		AC 09.90- 09.92 CA700IR 14 115		
	[ABY]	08.93- 12.95 CA1140IR 14 120 ▲		10.92- 12.95 CS282 12 1.1
Coupe 2.2 20V Quattro	[RR]	08.89- 07.91 CA521IR 14 90		08.89- 07.91 CS282 12 1.1
Coupe 2.2 GT	[KE]	04.82- 07.83 CA141IR 14 65		04.82- 07.84 CS282 12 1.1
		04.82- 05.83 CA52IR 14 55		
		08.82- 07.84 CA320IR 14 90		
	[KL]	09.82- 07.83 CA141IR 14 65		08.82- 07.84 CS282 12 1.1
		09.82- 08.84 CA320IR 14 90		
		09.82- 07.83 CA52IR 14 55		
	[KV]	09.84- 10.88 CA320IR 14 90		09.84- 10.88 CS282 12 1.1
		08.85- 10.88 CA911IR# 14 65		
		AC 08.85- 10.88 CA708IR 14 90 ▲		
	[KX]	01.84- 10.88 CA320IR 14 90		01.84- 10.88 CS282 12 1.1
		08.85- 10.88 CA911IR# 14 65		
		AC 08.85- 10.88 CA708IR 14 90 ▲		
Coupe 2.2 Turbo Quattro	[1B]	02.88- 07.88 CA320IR 14 90		02.88- 11.90 CS282 12 1.1
		08.88- 11.90 CA521IR 14 90		
		08.88- 11.90 CA700IR 14 115		
	[MB]	08.87- 07.88 CA320IR 14 90		08.87- 07.89 CS282 12 1.1
		08.88- 07.89 CA521IR 14 90		
		08.88- 07.89 CA700IR 14 115		
Coupe 2.3	[NG]	01.87- 10.88 CA320IR 14 90		01.87- 07.94 CS282 12 1.1
		10.88- 07.94 CA521IR 14 90		
		10.88- 07.94 CA700IR 14 115		
		AC 01.87- 10.88 CA708IR 14 90 ▲		
		AC 10.88- 07.94 CA700IR 14 115		
Coupe 2.3 Quattro	[NG]	01.87- 10.88 CA320IR 14 90		01.87- 07.94 CS282 12 1.1
		11.88- 07.94 CA521IR 14 90		
		AC 01.87- 10.88 CA708IR 14 90 ▲		
		AC 11.88- 07.94 CA700IR 14 115		
Coupe 2.3 20V	[7A]	08.89- 07.91 CA521IR 14 90		08.89- 07.91 CS282 12 1.1
		AC 08.89- 07.91 CA700IR 14 115		
Coupe 2.3 20V Quattro	[7A]	11.88- 07.91 CA521IR 14 90		11.88- 07.91 CS282 12 1.1
		AC 11.88- 07.91 CA700IR 14 115		
Coupe 2.6	[ABC]	08.92- 12.95 CA855IR 14 120		08.92- 12.95 CS725 12 1.4
Coupe 2.6 Quattro	[ABC]	08.92- 12.95 CA855IR 14 120		08.92- 12.95 CS725 12 1.4
Coupe 2.8	[AAH]	09.91- 12.95 CA855IR 14 120		09.91- 12.95 CS725 12 1.4
Coupe 2.8 Quattro	[AAH]	08.91- 12.95 CA855IR 14 120		08.91- 12.95 CS725 12 1.4
Q3 2.0 TFSi Quattro	[CCZC]			6SP 06.11- CS1347 12 1.1
Q3 2.0 TDi	[CFFA]			A25 09.11- CS1508* 12 1.7
	[CFFB]			09.11- CS1508* 12 1.7
Q5 2.0 TFSi	[CDNB]	08.09- CA2007IR 14 140		08.09- CS1437 12 1.1
	[CDNC]	11.08- CA2007IR 14 140		11.08- CS1437 12 1.1
Q5 2.0 TDi	[CAGA]	08.09- CA1986IR 14 140		
	[CAGB]	08.09- CA1986IR 14 140		
	[CAHA]	11.08- CA1986IR 14 140		
	[CAHB]	11.08- CA1986IR 14 140		
Q5 3.0 TDi	[CCWA]	11.08- CA1992IR 14 140		
	[CCWB]	11.08- CA1992IR 14 140		
Q7 3.0 TDi	[BUG]	03.06- 05.08 CA1937IR 14 180		
	[BUN]	03.06- 11.07 CA1937IR 14 180		
	[CASA]	11.07- CA1937IR 14 180		
	[CABS]	11.07- CA1937IR 14 180		
S3 1.8 Quattro	[AMK]	09.00- 04.02 CA1378IR 14 90		09.00- 04.02 CS1181 12 2.0
		09.00- 04.02 CA1394IR 14 120		
		09.00- 04.02 CA1436IR 14 70		
	[APY]	08.98- 08.00 CA1378IR 14 90		08.98- 08.00 CS1181 12 2.0
		08.98- 08.00 CA1394IR 14 120		
		08.98- 08.00 CA1436IR 14 70		
	[AUL]	09.00- 04.02 CA1378IR 14 90		09.00- 04.02 CS1181 12 2.0
		09.00- 04.02 CA1394IR 14 120		
		09.00- 04.02 CA1436IR 14 70		
	[BAM]	08.01- 06.03 CA1378IR 14 90		08.01- 06.03 CS1181 12 2.0
		08.01- 06.03 CA1394IR 14 120		
S3 2.0 Quattro	[BHZ]	06.08- CA1782IR 14 140		06.08- CS1347 12 1.1
S3 2.0 TFSi Quattro	[BHZ]	11.06- CA1782IR 14 140		6SP 11.06- CS1347 12 1.1
S4 2.2 Turbo Quattro	[AAN]	08.91- 07.94 CA700IR 14 115		08.91- 07.94 CS282 12 1.1
S6 2.2 Turbo Quattro	[AAN]	06.94- 12.97 CA855IR 14 120		06.94- 12.97 CS282 12 1.1
S6 4.2 Plus Quattro	[AHK]	06.96- 10.97 CA700IR 14 115		06.96- 10.97 CS985 12 1.8



S6 4.2 Quattro	[AEC]	09.94- 07.97	CA700IR	14 115	09.94- 07.97	CS985	12 1.8
	[ANK]				09.00-	CS1041	12 1.8
	[AQU]				09.99-	CS1041	12 1.8
S8 4.2 Quattro	[AHC]	07.96- 12.98	CA1232IR	14 120	07.96- 12.98	CS1041	12 1.8
	[AKH]	07.96- 10.98	CA1232IR	14 120	09.96- 12.98	CS1041	12 1.8
	[AQH]				06.99- 02.01	CS1041	12 1.8
	[AVP]				09.00- 09.02	CS1041	12 1.8
	[CDA]	06.08-	CA1811IR	14 140	06.08-	CS1294	12 1.1
TT 1.8 Turbo	[AJQ]	07.98- 08.00	CA1378IR	14 90	07.98- 08.00	CS1119	12 1.1
		07.98- 08.00	CA1394IR	14 120			
	[APP]	11.98- 09.00	CA1394IR	14 120	07.98- 09.00	CS1119	12 1.1
		10.99- 09.00	CA1378IR	14 90			
	[ARY]	09.00- 05.05	CA1378IR	14 90	09.00- 05.05	CS1119	12 1.1
		09.00- 05.05	CA1394IR	14 120	09.00- 05.05	CS1181	12 2.0
	[ATC]	10.98- 08.00	CA1378IR	14 90	A34 10.98- 08.00	CS1119	12 1.1
		10.98- 08.00	CA1394IR	14 120			
	[AUM]	01.01- 01.01-	CA1378IR	14 90	01.01-	CS1119	12 1.1
			CA1394IR	14 120			
	[AUQ]	08.00- 06.06	CA1378IR	14 90	08.00- 06.06	CS1119	12 1.1
		08.00- 06.06	CA1394IR	14 120			
	[AWP]	10.98- 06.06	CA1378IR	14 90	A34 10.98- 06.06	CS1119	12 1.1
		10.98- 06.06	CA1394IR	14 120			
	[BVP]	09.05- 09.05-	CA1378IR	14 90	09.05-	CS1119	12 1.1
			CA1394IR	14 120	AT 09.05- 09.05-	CS1337	12 1.1
						CS1293	12 2.0
		09.05- 09.05-	CA1378IR	14 90	09.05-	CS1293	12 2.0
		CA1394IR	14 120				
TT 1.8 Turbo Quattro	[AJQ]	10.98-	CA1378IR	14 90	10.98-	CS1181	12 2.0
		10.98-	CA1394IR	14 120			
	[AMU]	10.98-	CA1378IR	14 90	10.98-	CS1181	12 2.0
		10.98-	CA1394IR	14 120			
	[APX]	10.98-	CA1378IR	14 90	05.01-	CS1337	12 1.1
		10.98-	CA1394IR	14 120	10.98- 05.01	CS1181	12 2.0
		AC 10.98-	CA1394IR	14 120			
	[ARY]	10.98-	CA1378IR	14 90	10.98- 05.01	CS1181	12 2.0
		10.98-	CA1394IR	14 120	05.01-	CS1337	12 1.1
	[ATC]	07.98- 08.00	CA1378IR	14 90	10.98- 08.00	CS1119	12 1.1
		07.98- 08.00	CA1394IR	14 120	10.98- 08.00	CS1286	12 2.0
	[AUM]	10.99-	CA1378IR	14 90	10.99-	CS1181	12 2.0
		10.99-	CA1394IR	14 120			
	[AWP]	07.98-	CA1378IR	14 90	02.00-	CS1337	12 1.1
		07.98-	CA1394IR	14 120	10.98-	CS1181	12 2.0
[BAM]	10.99-	CA1378IR	14 90	05.01-	CS1337	12 1.1	
	10.99-	CA1394IR	14 120	10.99- 05.01	CS1181	12 2.0	
[BFV]	03.05-	CA1378IR	14 90	03.05-	CS1119	12 1.1	
	03.05-	CA1394IR	14 120				
[BVR]	09.05-	CA1378IR	14 90	09.05-	CS1293	12 2.0	
	09.05-	CA1394IR	14 120				
TT 1.8 Turbo Roadster	[AUM]	01.01-	CA1378IR	14 90	01.01-	CS1119	12 1.1
		01.01-	CA1394IR	14 120			
TT 2.0 TFSi	[BWA]	08.06- 06.10	CA1782IR	14 140	AT 08.06- 06.10	CS1409	12 1.0
					08.06- 06.10	CS1347	12 1.1
	[CESA]				05.10-	CS1347	12 1.1
TT 2.0 TFSi Quattro	[CCZA]	06.08- 06.10	CA1811IR	14 140	06.08- 06.10	CS1347	12 1.1
	[CDLB]	05.08-	CA1782IR	14 140	AT 05.08-	CS1409	12 1.0
					05.08-	CS1347	12 1.1
	[CESA]				05.10-	CS1347	12 1.1
	[CETA]				05.10-	CS1347	12 1.1
TT 2.0 TDi Quattro	[CBBB]	06.08-	CA1782IR	14 140	06.08-	CS1323	12 2.0
TT 2.5 TFSi Quattro	[CEPA]	07.09-	CA1782IR	14 140			
TT 3.2 V6 Quattro	[BUB]	08.06- 06.10	CA1782IR	14 140	AT 08.06- 06.10	CS1286	12 2.0
		Chas. -8J7013500 03.07- 06.10	CA1782IR	14 140	08.06- 06.10	CS1323	12 2.0
TT 3.2 VR6 Quattro	[BHE]	07.03- 06.06	CA1378IR	14 90	07.03- 06.06	CS1337	12 1.1
		07.03- 06.06	CA1394IR	14 120			
	[BPF]	07.03- 05.05	CA1378IR	14 90	07.03- 05.05	CS1337	12 1.1
	07.03- 05.05	CA1394IR	14 120				
V8 3.6 Quattro	[PT]	10.88- 02.94	CA700IR	14 115	10.88- 02.94	CS985	12 1.8
V8 4.2 Quattro	[ABH]	10.91- 11.93	CA700IR	14 115	10.91- 11.93	CS985	12 1.8
<b>PASSENGER CARS US</b>							
80 2.0	[3A]	01.88- 01.90	CA318IR	14 90	01.88- 01.90	CS297	12 0.95
					01.88- 01.90	CS509	12 1.0
80 2.3	[NG]	01.91- 01.92	CA343IR	14 90	01.91- 01.92	CS282	12 1.1
		01.91- 01.92	CA700IR	14 115			
80 2.3 Quattro	[NG]	01.88- 01.92	CA343IR	14 90	01.88- 01.92	CS282	12 1.1
		01.88- 01.92	CA700IR	14 115			
90 1.8 Super		01.70- 01.72	CA35IR	14 35			
90 2.0	[3A]	01.88- 01.88	CA318IR	14 90	01.88- 01.88	CS297	12 0.95
					01.88- 01.88	CS509	12 1.0
90 2.3	[NG]	01.88- 01.91	CA343IR	14 90	01.88- 01.91	CS282	12 1.1
		01.88- 01.91	CA700IR	14 115			
90 2.3 Quattro	[NG]	01.88- 01.89	CA343IR	14 90	01.88- 01.89	CS282	12 1.1
		01.88- 01.89	CA700IR	14 115			
90 2.3 20V Quattro	[7A]	01.90- 01.91	CA343IR	14 90	01.90- 01.91	CS282	12 1.1
		01.90- 01.91	CA700IR	14 115			
90 2.8	[AFC]	01.95- 01.95	CA855IR	14 120	01.95- 01.95	CS725	12 1.4
	[AAH]	01.95-	CA855IR	14 120	01.95-	CS725	12 1.4
90 2.8 Quattro	[AFC]	01.95- 01.95	CA855IR	14 120	01.95- 01.95	CS725	12 1.4
	[AAH]	01.95-	CA855IR	14 120	01.95-	CS725	12 1.4
90 2.8 Sport	[AFC]	01.95- 01.95	CA855IR	14 120	01.95- 01.95	CS725	12 1.4
	[AAH]	01.95-	CA855IR	14 120	01.95-	CS725	12 1.4
90 2.8 Sport Quattro	[AFC]	01.95- 01.95	CA855IR	14 120	01.95- 01.95	CS725	12 1.4
	[AAH]	01.95-	CA855IR	14 120	01.95-	CS725	12 1.4
90 2.8 CS	[AFC]	01.94- 01.94	CA855IR	14 120	01.94- 01.94	CS725	12 1.4
	[AAH]	01.93- 01.94	CA855IR	14 120	01.93- 01.94	CS725	12 1.4
90 2.8 CS Quattro	[AFC]	01.94- 01.94	CA855IR	14 120	01.94- 01.94	CS725	12 1.4
	[AAH]	01.93- 01.94	CA855IR	14 120	01.93- 01.94	CS725	12 1.4
90 2.8 S	[AFC]	01.94- 01.94	CA855IR	14 120	01.94- 01.94	CS725	12 1.4
	[AAH]	01.93- 01.94	CA855IR	14 120	01.93- 01.94	CS725	12 1.4
100 1.9	[ZK]	01.72- 01.72	CA35IR	14 35	01.72- 01.72	CS83	12 0.8
	[ZL]	01.72- 01.73	CA35IR	14 35	01.72- 01.73	CS83	12 0.8
	[ZW]	01.73- 01.73	CA35IR	14 35	01.73- 01.73	CS83	12 0.8
100 1.9 GL	[ZK]	01.72- 01.72	CA35IR	14 35	01.72- 01.72	CS83	12 0.8
	[ZL]	01.72- 01.73	CA35IR	14 35	01.72- 01.73	CS83	12 0.8
	[ZW]	01.73- 01.73	CA35IR	14 35	01.73- 01.73	CS83	12 0.8

**AUDI Continued**

100 1.9 LS	[XT]	01.74- 01.74	CA351R	14	35	01.74- 01.74	CS132	12	1.1
						01.74- 01.74	CS83	12	0.8
	[XU]	01.74- 01.74	CA351R	14	35	01.74- 01.74	CS132	12	1.1
						01.74- 01.74	CS83	12	0.8
	[YA]	01.75- 01.75	CA1631R	14	75	01.75- 01.75	CS132	12	1.1
						01.75- 01.75	CS83	12	0.8
	[YB]	01.75- 01.75	CA1631R	14	75	01.75- 01.75	CS83	12	0.8
						01.75- 01.75	CS132	12	1.1
	[YC]	01.75- 01.77	CA1631R	14	75	01.75- 01.77	CS132	12	1.1
						01.75- 01.77	CS83	12	0.8
	[YD]	01.75- 01.77	CA1631R	14	75	01.75- 01.77	CS83	12	0.8
						01.75- 01.77	CS132	12	1.1
	[ZG]	01.74- 01.74	CA351R	14	35	01.74- 01.74	CS132	12	1.1
					01.74- 01.74	CS83	12	0.8	
[ZH]	01.74- 01.74	CA351R	14	35	01.74- 01.74	CS132	12	1.1	
					01.74- 01.74	CS83	12	0.8	
[ZK]	01.72- 01.72	CA351R	14	35	01.72- 01.72	CS132	12	1.1	
					01.72- 01.72	CS83	12	0.8	
[ZL]	01.72- 01.73	CA351R	14	35	01.72- 01.73	CS132	12	1.1	
					01.72- 01.73	CS83	12	0.8	
[ZW]	01.73- 01.73	CA351R	14	35	01.73- 01.73	CS132	12	1.1	
					01.73- 01.73	CS83	12	0.8	
100 2.3	[NF]	01.89- 01.91	CA3431R	14	90	01.89- 01.91	CS282	12	1.1
		01.89- 01.91	CA7001R	14	115				
100 2.3 Quattro	[NF]	01.89- 01.91	CA3431R	14	90	01.89- 01.91	CS282	12	1.1
		01.89- 01.91	CA7001R	14	115				
100 2.3 E	[NF]	01.89- 01.89	CA3431R	14	90	01.89- 01.89	CS282	12	1.1
		01.89- 01.89	CA7001R	14	115				
100 2.8	[AAH]	01.92- 01.93	CA8551R	14	120	01.92- 01.93	CS725	12	1.4
100 2.8 CS	[AAH]	01.92- 01.94	CA8551R	14	120	01.92- 01.94	CS725	12	1.4
100 2.8 CS Quattro	[AAH]	01.92- 01.94	CA8551R	14	120	01.92- 01.94	CS725	12	1.4
100 2.8 S	[AAH]	01.92- 01.94	CA8551R	14	120	01.92- 01.94	CS725	12	1.4
100 2.8 S Quattro	[AAH]	01.93- 01.93	CA8551R	14	120	01.93- 01.93	CS725	12	1.4
200 2.2 Quattro	[MC]	01.89- 01.89	CA3181R	14	90	01.89- 01.89	CS282	12	1.1
		01.89- 01.89	CA3431R	14	90				
		01.89- 01.89	CA7001R	14	115				
200 2.2 Turbo 10V Quattro	[MC]	01.91- 01.91	CA3431R	14	90	01.91- 01.91	CS282	12	1.1
		01.91- 01.91	CA7001R	14	115				
200 2.2 Turbo 20V Quattro	[3B]	01.91- 01.91	CA3431R	14	90	01.91- 01.91	CS282	12	1.1
		01.91- 01.91	CA7001R	14	115				
200 2.2 Turbo	[MC]	01.89- 01.89	CA3181R	14	90	01.89- 01.91	CS282	12	1.1
		01.89- 01.91	CA3431R	14	90				
		01.89- 01.91	CA7001R	14	115				
200 2.2 Turbo Quattro	[MC]	01.90- 01.90	CA3431R	14	90	01.90- 01.90	CS282	12	1.1
		01.90- 01.90	CA7001R	14	115				
4000 1.6	[YG]	01.80- 01.80	CA1391R	14	65	01.80- 01.80	CS293	12	0.8
		01.80- 01.80	CA351R	14	35				
	[YH]	01.80- 01.80	CA1391R	14	65	01.80- 01.80	CS293	12	0.8
		01.80- 01.80	CA351R	14	35				
4000 1.6	[CR]	01.82- 01.82	CA2521R	14	55	01.82- 01.82	CS185	12	1.5
	[JK]	01.83- 01.83	CA2521R	14	55	01.83- 01.83	CS185	12	1.5
4000 1.6 Turbo	[CY]	01.82- 01.83	CA2521R	14	55	01.82- 01.83	CS185	12	1.5
4000 1.7	[WT]	01.81- 01.83	CA1391R	14	65	01.81- 01.83	CS297	12	0.95
		01.81- 01.83	CA351R	14	35	01.81- 01.83	CS293	12	0.8
4000 1.8 S	[JN]	01.84- 01.84	CA3201R	14	90	01.84- 01.84	CS297	12	0.95
	[MG]	01.85- 01.87	CA3201R	14	90	01.85- 01.87	CS297	12	0.95
		01.87- 01.87	CA3181R	14	90				
4000 2.2	[WE]	01.80- 07.81	CA1251R#	14	65	01.80- 01.83	CS132	12	1.1
		01.80- 07.81	CA1631R	14	75				
		08.81- 05.83	CA1411R	14	65				
		08.81- 05.83	CA521R	14	55				
		08.82- 07.84	CA3201R	14	90				
4000 2.2 CS Quattro	[JT]	01.86- 01.86	CA7081R	14	90	01.86- 01.86	CS282	12	1.1
4000 2.2 S	[KX]	01.86- 01.86	CA7081R	14	90	01.86- 01.86	CS282	12	1.1
	[WE]	01.84- 01.84	CA3201R	14	90	01.84- 01.84	CS282	12	1.1
4000 2.2 S Quattro	[JT]	01.84- 01.85	CA3201R	14	90	01.84- 01.85	CS282	12	1.1
5000 2.0	[CN]	01.79- 01.81	CA1631R	14	75	01.79- 01.81	CS188	12	2.0
5000 2.0 S	[CN]	01.79- 01.81	CA1631R	14	75	01.79- 01.81	CS188	12	2.0
5000 2.0 Turbo	[DE]					01.82- 01.83	CS188	12	2.0
						01.84- 01.85	CS347	12	2.0
5000 2.2	[WD]	01.78- 01.83	CA1631R	14	75	01.78- 01.83	CS132	12	1.1
		01.81- 01.83	CA1391R	14	65				
	[WE]	01.78- 01.83	CA1631R	14	75	01.78- 01.83	CS132	12	1.1
		01.81- 01.83	CA1391R	14	65				
5000 2.2 CS Turbo	[MC]	01.86- 01.88	CA3181R	14	90	01.86- 01.88	CS282	12	1.1
5000 2.2 CS Turbo Quattro	[MC]	01.86- 01.88	CA3181R	14	90	01.86- 01.88	CS282	12	1.1
5000 2.2 S Turbo	[KH]	01.84- 01.85	CA3201R	14	90	01.84- 01.85	CS282	12	1.1
	[WK]	01.80- 01.80	CA1631R	14	75	01.80- 01.80	CS132	12	1.1
	[KZ]	01.85- 01.87	CA3201R	14	90	01.85- 01.87	CS282	12	1.1
	[WD]	01.79- 01.83	CA1631R	14	75	01.79- 01.83	CS132	12	1.1
	[WE]	01.79- 01.83	CA1631R	14	75	01.79- 01.83	CS132	12	1.1
	[WU]	01.84- 01.84	CA3201R	14	90	01.84- 01.84	CS282	12	1.1
5000 2.2 Turbo	[WK]	01.81- 01.83	CA1391R	14	65	01.81- 01.83	CS132	12	1.1
		01.81- 01.83	CA1631R	14	75				
5000 2.3 S	[NF]	01.87- 01.88	CA3431R	14	90	01.87- 01.88	CS282	12	1.1
		01.87- 01.88	CA7001R	14	115				
5000 2.3 S Quattro	[NF]	01.87- 01.88	CA3431R	14	90	01.87- 01.88	CS282	12	1.1
		01.87- 01.88	CA7001R	14	115				
A4 1.8 Turbo	[AEB]	01.97- 01.99	CA11391R	14	90	01.97- 01.99	CS612	12	1.1
	[AMB]	01.02- 01.03	CA15461R	14	90	01.02- 01.03	CS612	12	1.1
	[ATW]	01.00- 01.00	CA15461R	14	90	01.00- 01.00	CS612	12	1.1
	[AWM]	01.01- 01.01	CA15461R	14	90	01.01- 01.01	CS612	12	1.1
A4 1.8 Turbo Quattro	[AEB]	01.97- 01.99	CA11391R	14	90	01.97- 01.99	CS612	12	1.1
	[AMB]	01.02- 01.03	CA15461R	14	90	01.02- 01.03	CS612	12	1.1
	[ATW]	01.00- 01.00	CA15461R	14	90	01.00- 01.00	CS612	12	1.1
	[AWM]	01.01- 01.01	CA15461R	14	90	01.01- 01.01	CS612	12	1.1
A4 2.8	[AFC]	01.96- 01.97	CA8551R	14	120	01.96- 01.97	CS725	12	1.4
	[AHA]	01.97- 01.99	CA8551R	14	120	01.97- 01.99	CS725	12	1.4
	[ATQ]	01.00- 01.01	CA8551R	14	120	01.00- 01.01	CS725	12	1.4
A4 2.8 Quattro	[AFC]	01.96- 01.97	CA8551R	14	120	01.96- 01.97	CS725	12	1.4
	[AHA]	01.98- 01.99	CA8551R	14	120	01.98- 01.99	CS725	12	1.4
	[ATQ]	01.00- 01.00	CA8551R	14	120	01.00- 01.00	CS725	12	1.4
						01.01- 01.01	CS1074	12	1.4
A4 3.0	[AVK]	01.01- 01.01	CA15461R	14	90	01.02- 01.02	CS1074	12	1.4



A4 3.0 Quattro	[AVK]							01.02- 01.02	CS1074	12 1.4
A6 2.7 Turbo Quattro	[APB]							01.00- 01.02	CS1074	12 1.4
A6 2.8	[AFC]	01.95- 01.97	CA855IR	14 120				01.95- 01.98	CS725	12 1.4
	[AHA]	01.98- 01.99	CA855IR	14 120				01.98- 01.99	CS1074	12 1.4
	[ATQ]	01.00- 01.00	CA855IR	14 120				01.00- 01.00	CS1074	12 1.4
	[AAH]	01.95-	CA855IR	14 120				01.95-	CS725	12 1.4
A6 2.8 Quattro	[AFC]	01.95- 01.98	CA855IR	14 120				01.95- 01.98	CS725	12 1.4
	[AHA]	01.98- 01.99	CA855IR	14 120				01.98- 01.99	CS1074	12 1.4
	[ATQ]							01.00- 01.01	CS1074	12 1.4
A6 3.0 Quattro	[AVK]						01.02- 01.02	CS1074	12 1.4	
A6 4.2 Quattro	[ART]							01.00- 01.00	CS1041	12 1.8
	[AWN]							01.01- 01.02	CS1041	12 1.8
A8 3.7	[AEW]	01.97- 01.99	CA1232IR	14 120				01.97- 01.99	CS1041	12 1.8
A8 4.2 Quattro	[ABZ]	01.97- 01.99	CA1232IR	14 120				01.97- 01.99	CS1041	12 1.8
	[AKB]							01.00- 01.02	CS1041	12 1.8
	[AUX]							01.01- 01.02	CS1041	12 1.8
A8 4.2 L Quattro	[AKB]							01.01- 01.02	CS1041	12 1.8
	[AUX]							01.01- 01.02	CS1041	12 1.8
Allroad 2.7 Turbo Quattro	[APB]						01.01- 01.02	CS1074	12 1.4	
Cabriolet 2.8	[AFC]	01.95- 01.98	CA855IR	14 120				01.95- 01.98	CS725	12 1.4
	[AAH]	01.94-	CA855IR	14 120				01.94-	CS725	12 1.4
Coupe 2.2	[WE]	01.81- 01.82	CA163IR	14 75				01.81- 01.82	CS132	12 1.1
Coupe 2.2 GT	[KX]	01.84- 01.85	CA320IR	14 90				01.84- 01.87	CS282	12 1.1
		01.86- 01.87	CA318IR	14 90				01.84- 01.85	CS132	12 1.1
		01.86- 01.87	CA708IR	14 90						
	[WE]	01.83- 01.84	CA139IR	14 65				01.83- 01.84	CS282	12 1.1
Coupe 2.2 Turbo Quattro		01.83- 01.84	CA163IR	14 75				01.83- 01.84	CS132	12 1.1
	[WX]	01.83- 01.84	CA163IR	14 75				01.85-	CS282	12 1.1
		01.85-	CA320IR	14 90				01.83- 01.84	CS132	12 1.1
Coupe 2.3 Quattro	[7A]	01.90- 01.91	CA700IR	14 115				01.90- 01.91	CS282	12 1.1
Coupe 2.3 GT	[NG]	01.87-	CA318IR	14 90				01.87-	CS282	12 1.1
		01.87-	CA708IR	14 90						
Fox 1.5	[XV]	01.74-	CA35IR	14 35				01.74-	CS293	12 0.8
		01.74-	CA52IR	14 55						
	[XW]	01.74-	CA35IR	14 35				01.74-	CS293	12 0.8
		01.74-	CA52IR	14 55						
	[XY]	01.74-	CA35IR	14 35				01.74-	CS293	12 0.8
		01.74-	CA52IR	14 55						
	[XZ]	01.74-	CA35IR	14 35				01.74-	CS293	12 0.8
		01.74-	CA52IR	14 55						
Fox 1.6	[ZD]	01.73-	CA35IR	14 35				01.73-	CS293	12 0.8
		01.73-	CA52IR	14 55						
	[ZE]	01.73-	CA35IR	14 35				01.73-	CS293	12 0.8
		01.73-	CA52IR	14 55						
	[YG]	01.75- 01.79	CA35IR	14 35				01.75- 01.79	CS293	12 0.8
		01.75- 01.79	CA52IR	14 55						
Fox 1.6	[YH]	01.75- 01.79	CA35IR	14 35				01.75- 01.79	CS293	12 0.8
		01.75- 01.79	CA52IR	14 55						
	[YK]	01.76-	CA35IR	14 35				01.76-	CS293	12 0.8
	01.76-	CA52IR	14 55							
S4 2.2 Turbo	[AAN]	01.92- 01.94	CA700IR	14 115				01.92- 01.94	CS282	12 1.1
S4 2.7 Turbo	[APB]							01.00- 01.02	CS1074	12 1.4
S6 2.2 Turbo	[AAN]	01.95-	CA855IR	14 120				01.95-	CS282	12 1.1
S6 4.2	[BBB]							01.02- 01.02	CS1041	12 1.8
S8 4.2	[AYS]							01.02- 01.02	CS1041	12 1.8
TT 1.8 Turbo	[ATC]	01.00- 01.00	CA1549IR	14 120				01.00- 01.00	CS1119	12 1.1
	[AWP]	01.01- 01.02	CA1549IR	14 120				01.01- 01.02	CS1119	12 1.1
TT 1.8 Turbo Quattro	[AMU]	01.01- 01.02	CA1549IR	14 120				01.01- 01.02	CS1181	12 2.0
								01.01- 01.02	CS1119	12 1.1
	[ATC]	01.00- 01.00	CA1549IR	14 120				01.00- 01.00	CS1119	12 1.1
	[AWP]	01.01- 01.02	CA1549IR	14 120				01.01- 01.02	CS1119	12 1.1
V8 3.6 32V Quattro	[PT]	01.90- 01.91	CA700IR	14 115				01.90- 01.91	CS985	12 1.8
V8 4.2 32V Quattro	[ABH]	01.92- 01.94	CA700IR	14 115				01.92- 01.94	CS985	12 1.8
<b>PASSENGER CARS AO</b>										
100 2.6 E V6 Quattro	[ACZ]	08.93- 07.94	CA855IR	14 120				08.93- 07.94	CS725	12 1.4
100 2.6 E Quattro	[ACZ]	08.93- 07.94	CA855IR	14 120				08.93- 07.94	CS725	12 1.4
A3 2.0	[BUY]	06.06-	CA1782IR	14 140				DSG 06.06-	CS1286	12 2.0
		06.06-	CA1810IR	14 110				06.06-	CS1323	12 2.0
A3 2.0 Sportback	[BUY]	06.06-	CA1782IR	14 140				DSG 06.06-	CS1286	12 2.0
		06.06-	CA1810IR	14 110				06.06-	CS1323	12 2.0
A3 3.2 V6	[BMJ]	11.05- 09.06	CA1782IR	14 140				AT 11.05-	CS1286	12 2.0
								11.05-	CS1323	12 2.0
	[BUB]	11.05- 09.06	CA1782IR	14 140				AT 11.05-	CS1286	12 2.0
								11.05-	CS1323	12 2.0
A4 1.8 FSi	[CDHA]							04.08-	CS1437	12 1.1
A4 2.0 TDi	[BVF]	11.05- 03.08	CA1782IR	14 140				AT 11.05- 03.08	CS1423	12 2.0
								11.05- 03.08	CS1392	12 2.0
A4 2.0 TDi Quattro	[CAHA]	01.08-	CA1986IR	14 140						
A4 2.4	[AFM]	07.95- 07.97	CA855IR	14 120				07.95- 07.97	CS725	12 1.4
A4 2.6	[ACZ]	01.96- 07.97	CA855IR	14 120				01.96- 07.97	CS725	12 1.4
A6 2.0	[ADW]	08.95- 07.96	CA1244IR	14 90				Chas. 4AT045001- 08.95- 07.96	CS612	12 1.1
		08.95- 07.96	CA908IR	14 70						
A6 2.4	[AFM]	07.95- 07.97	CA855IR	14 120				07.95- 07.97	CS725	12 1.4
A6 2.7 Turbo Quattro	[AJK]	02.99- 09.00	CA1546IR	14 90				02.99- 09.00	CS1074	12 1.4
		02.99- 09.00	CA1588IR	14 120						
A6 2.8	[AEJ]	08.95- 07.96	CA837IR	14 90				08.95- 07.96	CS725	12 1.4
		08.95- 07.96	CA855IR	14 120						
A6 2.8 Quattro	[ATX]	07.99- 05.01	CA1546IR	14 90				07.99- 05.01	CS1074	12 1.4
		07.99- 05.01	CA1588IR	14 120						
A6 3.0 TDi PF	[ASB]	06.06-	CA1937IR	14 180				06.06-	CS1411	12 2.2
A6 3.2 FSi Quattro	[BYU]							09.06-	CS1339	12 1.2
A8 3.0 L Quattro	[ASN]							08.03- 05.05	CS1074	12 1.4
	[BBJ]							11.03- 05.06	CS1074	12 1.4
A8 4.2 Quattro	[AGH]	07.95- 09.98	CA1232IR	14 120				07.95- 09.98	CS1041	12 1.8
S4 2.7 Biturbo Quattro	[APB]							08.98- 12.98	CS1074	12 1.4
TT 2.0 Quattro	[CDLA]	05.08-	CA1782IR	14 140				05.08-	CS1347	12 1.1
								A41 05.08-	CS1409	12 1.0



Austin									
PASSENGER CARS EU									
1100 MK 1.1		01.72- 12.74	CA17h	14 34		01.70- 12.74	CS18	12 0.8	
		01.73- 12.74	CA190IR	14 35					
		01.70- 12.71	CG50	14 22					
		01.72- 12.74	CA61IR	14 45					
1300 MK 1.3		01.70- 12.71	CG50	14 22		01.70- 12.74	CS18	12 0.8	
		01.72- 12.74	CA61IR	14 45					
		01.73- 12.74	CA190IR	14 35					
		01.72- 12.74	CA17h	14 34					
1300 MK 1.3 GT		01.72- 12.74	CA17h	14 34		01.70- 12.74	CS18	12 0.8	
		01.73- 12.74	CA190IR	14 35					
Allegro 1.0		01.80- 10.83	CA18h	14 43		01.80- 10.83	CS18	12 0.8	
Allegro 1.1	[10H]	05.73- 10.81	CA17h	14 34		05.73- 10.81	CS18	12 0.8	
		05.73- 10.81	CA18h	14 43					
		05.73- 04.77	CA190IR	14 35					
		05.77- 10.81	CA96IR	14 55					
		05.73- 12.84	CA17h	14 34		05.73- 12.84	CS18	12 0.8	
		05.73- 12.84	CA18h	14 43					
		05.73- 04.77	CA190IR	14 35					
		05.77- 03.82	CA96IR	14 55					
		01.75- 03.82	CA17h	14 34		01.75- 03.82	CS18	12 0.8	
		01.75- 10.79	CA290IR	14 45					
Allegro 1.5	[14H]	05.73- 03.82	CA17h	14 34		05.73- 03.82	CS18	12 0.8	
		05.73- 03.82	CA18h	14 43					
		08.75- 03.82	CA290IR	14 45					
Allegro 1.7		08.79- 03.82	CA18h	14 43					
		01.75- 03.82	CA17h	14 34					
Maestro 1.3	[12H]	03.83- 09.92	CA600IR	14 55		Chas. -367394 03.83- 08.88	CS294	12 0.9	
	[12H999AA]	03.83- 08.85	CA600IR	14 55		Chas. -367394 03.83- 08.88	CS294	12 0.9	
	[12HC32]	03.83- 08.85	CA600IR	14 55		Chas. -367394 03.83- 08.88	CS294	12 0.9	
		01.86- 09.92	CA600IR	14 55		01.86- 09.92	CS116	12 0.8	
Maestro 1.6	[16H956AK]	03.83- 10.84	CA293IR	14 55		Chas. -367394 03.83- 10.84	CS294	12 0.9	
	[16HA03AL]	03.83- 08.85	CA293IR	14 55		03.83- 08.88	CS116	12 0.8	
	[16HC37]	03.83- 08.88	CA293IR	14 55		03.83- 08.88	CS116	12 0.8	
						Chas. -367394 10.84- 08.88	CS294	12 0.9	
Maestro 1.6 MG	[16HA35AL]	03.83- 08.90	CA293IR	14 55		03.83- 08.90	CS116	12 0.8	
Maestro 2.0	[20HA50AA]	10.84- 08.88	CA600IR	14 55		10.84- 08.88	CS579	12 0.9	
	[20HC51AA]	10.84- 08.90	CA600IR	14 55		10.84- 08.90	CS579	12 0.9	
	[20HC81]	10.84- 08.90	CA600IR	14 55		10.84- 08.90	CS579	12 0.9	
Maxi 1.5 1500		04.69- 07.80	CA17h	14 34		04.69- 07.80	CS18	12 0.8	
Maxi 1.8 1750	[17H]	04.69- 10.80	CA17h	14 34		04.69- 10.80	CS18	12 0.8	
		10.72- 10.80	CA17h	14 34		10.72- 10.80	CS18	12 0.8	
		10.80- 04.90	CA126IR	14 45		10.80- 12.86	CS18	12 0.8	
Metro 1.0	[99H]	10.80- 04.90	CA126IR	14 45		10.80- 12.86	CS18	12 0.8	
	[99HA65P]	10.80- 04.90	CA18h	14 43					
	[A]	10.80- 04.90	CA126IR	14 45		10.80- 01.87	CS18	12 0.8	
		10.80- 04.90	CA18h	14 43					
Metro 1.3	[12H]	10.80- 12.84	CA18h	14 43		10.80- 12.86	CS18	12 0.8	
	[12H996AA]	01.85- 04.90	CA126IR	14 45					
		10.80- 12.84	CA18h	14 43		10.80- 06.87	CS18	12 0.8	
		01.85- 04.90	CA126IR	14 45					
	[12HA83AA]	10.80- 12.84	CA18h	14 43		10.80- 06.87	CS18	12 0.8	
	[12HC21AA]	01.85- 04.90	CA126IR	14 45					
[12HL]	11.85- 04.90	CA126IR	14 45		11.85- 12.86	CS18	12 0.8		
Metro 1.3 Turbo	[12HA85AA]	10.80- 12.83	CA18h	14 43					
		10.83- 04.90	CA305IR	14 55		10.83- 06.87	CS18	12 0.8	
Mini 0.85 850		01.67- 08.79	CA17h	14 34		01.67- 08.79	CS18	12 0.8	
Mini 0.9		09.69- 10.85	CA17h	14 34		09.69- 10.85	CS18	12 0.8	
Mini 1.0 1000	[99H]	10.67- 08.88	CA17h	14 34		10.67- 09.84	CS18	12 0.8	
		10.67- 08.88	CA18h	14 43					
		10.67- 09.84	CG50	14 22					
	[99HD81]	01.92- 06.93	CA126IR	14 45					
	[A]	10.67- 08.88	CA17h	14 34		10.67- 09.84	CS18	12 0.8	
		10.67- 08.88	CA18h	14 43					
		10.67- 08.74	CG50	14 22					
Mini 1.0 1000 Mayfair Sport	[99H97P]	01.82- 08.88	CA126IR	14 45		08.82- 10.85	CS18	12 0.8	
		08.82- 06.93	CA18h	14 43		11.85- 06.93	CS691	12 0.8	
	[99HA53P]	08.82- 06.93	CA126IR	14 45		08.82- 10.85	CS18	12 0.8	
		08.82- 06.93	CA18h	14 43		11.85- 06.93	CS691	12 0.8	
	[99HC20P]	08.82- 06.93	CA126IR	14 45		11.85- 06.93	CS691	12 0.8	
		08.82- 06.93	CA18h	14 43		08.82- 10.85	CS18	12 0.8	
	[99HD81]	09.88- 06.93	CA126IR	14 45		09.88- 06.93	CS691	12 0.8	
Mini 1.1 1100 Special	[10H]	01.76- 08.81	CA17h	14 34		01.76- 08.81	CS18	12 0.8	
Mini 1.3	[12H]	04.74- 09.80	CA17h	14 34		04.74- 09.80	CS18	12 0.8	
		04.74- 09.80	CA18h	14 43					
Mini 1.3 1300	[12A2A]					01.91- 12.91	CS691	12 0.8	
	[12A2D]	01.92- 04.95	CA126IR	14 45		01.92- 04.95	CS691	12 0.8	
		01.92- 04.95	CA600IR	14 55					
		04.95- 09.00	CA1488IR	14 65					
	[12A2E]					01.92-	CS691	12 0.8	
[12A2L]					01.92-	CS691	12 0.8		
Mini 11.3 GT 1275		10.69- 08.80	CA17h	14 34		10.69- 08.80	CS18	12 0.8	
Mini-Moke 1.0		01.87-	CA126IR	14 45		01.87-	CS691	12 0.8	
Montego 1.3	[12HL]	10.84- 08.88	CA305IR	14 55		10.84- 08.88	CS116	12 0.8	
Montego 1.6	[16HC37]	04.84- 08.88	CA293IR	14 55		04.84- 08.88	CS116	12 0.8	
		AC 04.84- 08.88	CA627IR	14 65		04.86- 08.88	CS579	12 0.9	
Montego 2.0	[20H]	04.84- 12.93	CA600IR	14 55		04.86- 12.93	CS579	12 0.9	
		AC 04.84- 08.88	CA564IR	14 65					
	[20HSC]	04.84- 08.91	CA600IR	14 55		04.86- 08.91	CS579	12 0.9	
	AC 04.84- 08.88	CA564IR	14 65						
Montego 2.0 i Turbo	[20HC85]	04.84- 08.88	CA600IR	14 55		05.86- 08.88	CS579	12 0.9	
		AC 04.84- 08.88	CA564IR	14 65					
Montego 2.0 i	[20H]	04.84- 08.88	CA600IR	14 55		04.86- 08.88	CS579	12 0.9	
		AC 04.84- 08.88	CA564IR	14 65					
Princess 1.7 1700		10.72- 10.82	CA18h	14 43					
Princess 1.8 1800	[18H]	04.76- 09.78	CA18h	14 43					
Princess 2.0 2000	[20H]	10.78- 10.82	CA18h	14 43					
Princess 2.2 2200	[22H]	04.76- 09.78	CA18h	14 43					
		10.78- 10.82	CA18h	14 43					





PASSENGER CARS US							
America 1.3		01.68- 01.72	CG50	14 22		01.68- 01.72	CS18 12 0.8
Cooper 0.9		01.65- 01.66	CG50	14 22		01.65- 01.66	CS18 12 0.8
Cooper 1.0		01.62- 01.64	CG50	14 22		01.62- 01.64	CS18 12 0.8
Cooper 1.1		01.64- 01.64	CG50	14 22		01.64- 01.64	CS18 12 0.8
Cooper 1.3		01.64- 01.69	CG50	14 22		01.64- 01.69	CS18 12 0.8
Healey 1.0 Sprite		01.62- 01.62	CG50	14 22		01.62- 01.62	CS18 12 0.8
Healey 1.1 Sprite		01.63- 01.66	CG50	14 22		01.63- 01.66	CS18 12 0.8
Healey 1.3 Sprite		01.67- 01.67	CG50	14 22		01.67- 01.67	CS18 12 0.8
Healey MK 1.3 Sprite		01.68- 01.70	CG50	14 22		01.68- 01.70	CS18 12 0.8
Mariner 1.8		01.73- 01.75	CA17h	14 34			
Mariner 1.8 GT		01.73- 01.75	CA17h	14 34			
Mini 0.9		01.60- 01.66	CG50	14 22			
Autobianchi							
PASSENGER CARS EU							
A 112 0.9	[A112A5.000]					01.76- 12.78	CS90 12 0.8
A 112 0.9 Junior	[A112A5.000]	07.75- 12.85	CA307IR	14 45		07.75- 12.85	CS90 12 0.8
	[A112B2.000]	07.75- 12.85	CA307IR	14 45		07.75- 12.85	CS90 12 0.8
A 112 0.9 E	[A112A5.000]					01.73- 12.77	CS90 12 0.8
A 112 1.0 Abarth	[A112A1.000]					09.71- 12.75	CS90 12 0.8
	[A112A2.000]	01.74- 12.84	CA307IR	14 45		01.74- 12.84	CS90 12 0.8
A 112 1.0 E Elite LX	[A112B1.000]	11.77- 12.84	CA307IR	14 45		11.77- 12.84	CS90 12 0.8
Y10 1.0	[156A.000]	03.85- 12.88	CA252IR	14 55		03.85- 12.88	CS371 12 0.9
	[156A2.000]	03.85-	CA572IR	14 55		03.85-	CS371 12 0.9
	[156A2.246]	01.89- 09.92	CA572IR	14 55		10.87- 09.92	CS371 12 0.9
Y10 1.0 4WD	[156A3.000]	09.86- 12.88	CA572IR	14 55		12.86- 12.88	CS371 12 0.9
Y10 1.0 Turbo	[156A1.000]	03.85- 12.88	CA572IR	14 55		03.85- 12.88	CS371 12 0.9
Y10 1.1	[156C.000]	06.89- 09.92	CA572IR	14 55		06.89- 09.92	CS371 12 0.9
Y10 1.1 4WD	[156C.000]	06.89- 09.92	CA572IR	14 55		06.89- 09.92	CS371 12 0.9
Y10 1.1 i.e.	[156C.046]	09.90- 01.95	CA572IR	14 55		09.90- 01.95	CS371 12 0.9
Y10 1.3 i.e. GT	[146A5.046]	06.89- 09.92	CA254IR	14 65		01.89- 09.92	CS371 12 0.9
	[156B.000]	06.89- 09.92	CA254IR	14 65		06.89- 09.92	CS147 12 0.8
Bedford							
PASSENGER CARS EU							
Astra 1.3	[13S]	09.84- 09.89	CA128IR	14 45		09.84- 09.89	CS162 12 0.7
		09.84- 09.89	CA514IR	14 70			
		09.84- 09.89	CA128IR	14 45		09.84- 09.89	CS162 12 0.7
		09.84- 09.89	CA514IR	14 70			
Astra 1.4	[14NV]	09.89- 08.91	CA513IR	14 55		09.89- 08.91	CS162 12 0.7
		09.89- 08.91	CA514IR	14 70			
Astra 1.6	[16SV]	09.84- 08.91	CA158IR	14 45		09.84- 08.91	CS1183 12 0.9
		09.84- 08.91	CA264IR	14 55		09.84- 08.91	CS263 12 0.8
		09.84- 08.91	CA352IR	14 65			
Astra 1.6 Diesel	[16D]	07.82- 08.88	CA158IR	14 45		07.82- 08.88	CS290 12 1.7
		07.82- 08.88	CA264IR	14 55		07.82- 08.88	CS322 12 1.7
		07.82- 08.88	CA352IR	14 65			
		09.87- 08.89	CA158IR	14 45		09.87- 08.89	CS290 12 1.7
		09.87- 08.89	CA548IR#	14 55			
Astra 1.7 Diesel		09.88- 08.91	CA516IR	14 70		09.88- 08.91	CS290 12 1.7
Astramax 1.3		09.85- 06.90	CA513IR	14 55		09.85- 06.90	CS162 12 0.7
		09.85- 06.90	CA128IR	14 45			
Astramax 1.4	[14NV]	09.89- 06.90	CA513IR	14 55		09.89- 06.90	CS162 12 0.7
		09.89- 06.90	CA514IR	14 70		09.89- 06.90	CS535 12 0.9
						09.89- 06.90	CS519 12 1.0
Astramax 1.6 Diesel	[16D]	09.85- 08.88	CA158IR	14 45		09.85- 08.88	CS290 12 1.7
		09.85- 08.88	CA548IR#	14 55			
		09.85- 08.88	CA158IR	14 45		09.85- 08.88	CS290 12 1.7
		09.85- 08.88	CA548IR#	14 55			
Astramax 1.7 Diesel		09.88- 06.90	CA516IR	14 70		09.88- 06.90	CS290 12 1.7
Blitz 1.8	[N18Z]					08.69- 10.87	CS70 12 0.8
Blitz 2.0	[20N]	02.85- 10.87	CA42IR	14 55		02.85- 10.87	CS70 12 0.8 BO
Blitz 2.0 Diesel	[20DTR]	10.80- 10.83	CA513IR	14 55			
Blitz 2.3	[23L]	02.80- 10.83	CA128IR	14 45			
Blitz 2.3 Diesel	[23D]					09.84- 10.87	CS356 12 2.2
Midi 2.0	[20PET]	06.88- 08.92	JA697IR#	14 55			
Midi 2.0 TD		09.84- 08.92	JA680IR#	14 50			
Midi 2.2 Diesel	[22DIE]	06.88- 08.92	JA680IR#	14 50			
Midi 2.2 Diesel 4WD	[22DIE]	06.88- 08.92	JA680IR#	14 50			
Midi 2.2 Diesel 4x4	[22DIE]	09.84- 08.92	JA680IR#	14 50			
Rascal 1.0	[FA10A]	07.86- 06.90	JA171IR	14 40		07.86- 06.90	JS387 12 0.6
Bertone							
PASSENGER CARS US							
X-1/9 1.5		01.84- 01.89	CA504IR	14 65		01.84- 01.89	CS133 12 0.9
BMW							
PASSENGER CARS EU							
116 1.6i	(E81, E87)[N45B16TU2]	09.07- 08.08	CA2035IR	14 180		09.07- 09.07	CS1419 12 1.7
	(E87)[N45B16A]	09.04- 09.04	CA1773IR	14 110		09.04- 09.04	CS1412 12 1.2
			CA1774IR	14 145			CS1413 12 1.2
116 2.0 i	(E81, E87)[N43B20A]					A25 01.09- 01.09	CS1419 12 1.7
							CS1412 12 1.2
116 2.0 Diesel	(E81, E87)[N47D20A]	09.04-	CA2041IR	14 180		09.04-	CS1466 12 2.0
						A25 09.04-	CS1467 12 2.2
118 2.0 i	(E87)[N43B20]	04.07- 08.08	CA2035IR	14 180		04.07-	CS1419 12 1.7
	[N46B20B]	09.04-	CA1773IR	14 110		AT 04.07-	CS1412 12 1.2
		09.04-	CA1774IR	14 145		09.04-	CS1413 12 1.2
	(E88)[N43B20A]	03.08- 08.08	CA2035IR	14 180		03.08-	CS1419 12 1.7
						AT 03.08-	CS1412 12 1.2
118 2.0 Diesel	(E81, E87)[N47D20D]	03.07-	CA2041IR	14 180		03.07-	CS1466 12 2.0
	(E82)[N47D20C]	09.09-	CA2041IR	14 180		A25 03.07-	CS1467 12 2.2
						09.09-	CS1466 12 2.0
						A25 09.09-	CS1467 12 2.2
	(E87)[M47N204D4]	09.04-	CA1904IR	14 150		09.04-	CS1406 12 1.8
	[N47D20]	04.07-	CA2041IR	14 180		A25 04.07-	CS1467 12 2.2
						04.07-	CS1466 12 2.0
	(E88)[N47D20]	09.08-	CA2041IR	14 180		A25 09.08-	CS1467 12 2.2
						09.08-	CS1466 12 2.0
120 2.0 i	(E81, E87)[N43B20A]	03.07-	CA2035IR	14 180		03.07-	CS1419 12 1.7
	[N46B20]	03.07-	CA1773IR	14 110		AT 03.07-	CS1412 12 1.2
		03.07-	CA1774IR	14 145		03.07-	CS1413 12 1.2
	(E82)[N43B20A]					A25 09.09-	CS1419 12 1.7
						09.09-	CS1412 12 1.2
	(E87)[N43B20]	04.07-	CA2035IR	14 180		AT 04.07-	CS1412 12 1.2
						04.07-	CS1419 12 1.7



BMW Continued

	[N46B20]	09.04-09.04-	CA1773IR	14 110		09.04-03.07	CS1413	12 1.2
			CA1774IR	14 145				
	(E88)[N43B20A]	03.08-08.08	CA2035IR	14 180		AT 03.08-03.08-	CS1412 CS1419	12 1.2 12 1.7
120 2.0 Diesel	(E82)[N47D20]	10.07-	CA2041IR	14 180		10.07- A25 10.07-	CS1466 CS1467	12 2.0 12 2.2
	[N47D20A]	10.07-	CA2041IR	14 180		A25 10.07- 10.07-	CS1467 CS1466	12 2.2 12 2.0
	(E87)[M47N204D4]	09.04-	CA1904IR	14 150		09.04-	CS1406	12 1.8
	[N47D20]	04.07-	CA2041IR	14 180		04.07-	CS1466	12 2.0
	[N47D20A]	09.04-	CA1904IR	14 150		09.04-	CS1406	12 1.8
	(E88)[N47D20]	03.08-	CA2041IR	14 180		03.08- A25 03.08-	CS1466 CS1467	12 2.0 12 2.2
	[N47D20A]	03.08-	CA2041IR	14 180		03.08- A25 03.08-	CS1466 CS1467	12 2.0 12 2.2
123 2.0 Diesel	(E81, E87)[N47D20]	10.07-	CA2041IR	14 180		10.07- A25 10.07-	CS1466 CS1467	12 2.0 12 2.2
	(E82)[N47D20]	10.07-	CA2041IR	14 180		A25 10.07- 10.07-	CS1467 CS1466	12 2.2 12 2.0
	(E88)[N47D20B]	09.08-	CA2041IR	14 180		09.08- A25 09.08-	CS1466 CS1467	12 2.0 12 2.2
125 3.0 i	(E82)[N52B30A]	10.07-	CA1953IR	14 180		10.07-	CS1412	12 1.2
	(E88)[N52B30A]	03.08-	CA1953IR	14 180		03.08-	CS1412	12 1.2
130 3.0 i	(E81, E87)[N52B30]	03.05-	CA1953IR	14 180		03.05-	CS1412	12 1.2
	(E87)[N52B30A]	09.05-	CA2009IR	14 155		09.05-	CS1412	12 1.2
135 3.0 i	(E82)[N54B30]					10.07-	CS1412	12 1.2
	(E88)[N54B30A]					03.08-	CS1412	12 1.2
315 1.6	(E21)[M10B16]					03.81-02.91	CS119	12 1.5
316 1.6 Ci	(E46)[M43B16]	04.00-04.00-04.00-	CA1569IR CA1578IR CA1580IR	14 90 14 100 14 70		04.00-	CS1067	12 1.4
	[N45B16A]	06.02-06.02-	CA1773IR CA1774IR	14 110 14 145		06.02-	CS1256	12 1.4
316 1.6 i	(E30)[M40B16]	09.88-06.94-09.88-06.94-09.88-06.94-	CA538IR CA608IR CA630IR	14 80 14 90 14 65		09.88-06.94	CS516	12 1.4
	[M40B16C]	09.87-06.90-09.87-06.90-09.87-06.90-	CA538IR CA608IR CA630IR	14 80 14 90 14 65		09.87-06.90	CS516	12 1.4
	(E36)[M40B16]	12.90-09.93-12.90-09.93-12.90-09.93-	CA1041IR CA1042IR CA826IR	14 90 14 105 14 65		12.90-09.93	CS516	12 1.4
	[M43B16]	07.93-08.00-07.93-10.00-	CA1106IR CA1398IR	14 70 14 80		09.97-08.00-07.93-09.97-	CS1067 CS516	12 1.4 12 1.4
	(E46)[M43B16]	04.00-04.00-04.00-	CA1106IR CA1569IR CA1580IR	14 70 14 90 14 70		04.00-	CS1067	12 1.4
	[N45B16A]	06.02-02.05-06.02-02.05-	CA1773IR CA1774IR	14 110 14 145		06.02-02.05	CS1256	12 1.4
	(E90)[N43B16A]	08.08-	CA2035IR	14 180		A25 09.07-09.07-	CS1419 CS1412	12 1.7 12 1.2
	[N45B16A]	02.06-02.06-	CA1773IR CA1774IR	14 110 14 145		02.06-	CS1413	12 1.2
	(E91)[N43B16A]					A25 09.07-09.07-	CS1419 CS1412	12 1.7 12 1.2
316 1.6 Ti	(E46)[N40B16A]	06.02-02.05-06.02-02.05-06.02-02.05-06.02-02.05-	CA1654IR CA1660IR CA1773IR CA1774IR	14 90 14 120 14 110 14 145		06.02-02.05	CS1256	12 1.4
316 1.6 G	(E36)[M43B16]	12.95-08.00-12.95-08.00-	CA1106IR CA1398IR	14 70 14 80		12.95-09.97-09.97-08.00-	CS516 CS1067	12 1.4 12 1.4
316 1.8	(E21)[M10B18]					01.81-08.82	CS119	12 1.5
	(E30)[M10B18]	09.82-12.85-09.82-12.85-	CA199IR CA251IR	14 65 14 80		09.82-12.87	CS119	12 1.5
316 1.8 Ecotronic	(E30)[M10B18]	09.83-08.85-09.83-08.85-09.85-08.87-	CA199IR CA251IR CA362IR	14 65 14 80 14 80		09.83-08.87	CS119	12 1.5
316 1.8 i	(E30)[M10B18]	08.87-08.88-	CA251IR	14 80		08.87-08.88	CS119	12 1.5
	(E46)[N42B18]	02.02-02.05-02.02-02.05-02.02-02.05-02.02-02.05-	CA1654IR CA1660IR CA1773IR CA1774IR	14 90 14 120 14 110 14 145		02.02-02.05	CS1256	12 1.4
	[N46B18]	03.02-02.05-03.02-02.05-03.02-02.05-03.02-02.05-	CA1654IR CA1660IR CA1773IR CA1774IR	14 90 14 120 14 110 14 145		03.02-02.05	CS1256	12 1.4
316 1.8 Ti	(E46)[N42B18]	06.01-04.02-06.01-04.02-06.01-04.02-06.01-04.02-	CA1654IR CA1660IR CA1773IR CA1774IR	14 90 14 120 14 110 14 145		06.01-	CS1256	12 1.4
	[N46B18]	04.04-12.04-04.04-12.04-	CA1773IR CA1774IR	14 110 14 145		04.04-12.04	CS1256	12 1.4
316 1.9 i	(E36)[M43164E3]	12.98-08.00-12.98-08.00-12.98-08.00-	CA1106IR CA1398IR CA1580IR	14 70 14 80 14 70		12.98-08.00	CS1067	12 1.4
	(E46)[M43164E3]	01.99-01.99-01.99-	CA1569IR CA1578IR CA1580IR	14 90 14 100 14 70		01.99-	CS1067	12 1.4
316 2.0 Diesel	(E90)[N47D20C]	07.09-	CA2041IR	14 180		A25 07.09-07.09-	CS1467 CS1466	12 2.2 12 2.0
	(E91)[N47D20C]					A25 09.09-09.09-	CS1467 CS1466	12 2.2 12 2.0
318 1.7 TDS	(E36)[M41D18]	01.95-08.00-	CA1247IR	14 95		01.95-08.00	CS1048	12 1.8
318 1.8 i	(E21)[M10B18]	11.79-08.82-	CA196IR	14 65		11.79-08.82	CS119	12 1.5
	(E30)[M10B18]	09.82-08.83-12.84-08.87-	CA196IR CA251IR	14 65 14 80		09.82-08.87	CS119 CS577	12 1.5 12 1.4
	[M40B18]	09.87-06.94-01.88-06.94-09.88-06.94-	CA538IR CA608IR CA630IR	14 80 14 90 14 65		09.87-06.94	CS516	12 1.4
	(E36)[M40B18]	12.90-05.92-12.90-02.94-12.90-02.94-	CA1041IR CA1042IR CA826IR	14 90 14 105 14 65		12.90-02.94	CS516	12 1.4
	[M43B18]	09.93-10.99-09.93-12.98-09.93-10.99-	CA1106IR CA1261IR CA1398IR	14 70 14 90 14 80		09.93-07.95-01.94-10.99-	CS516 CS1067	12 1.4 12 1.4
318 1.8 iS	(E30)[M42B18]	09.89-08.91-09.89-08.91-	CA1041IR CA826IR	14 90 14 65		09.89-08.91	CS516	12 1.4



	(E36)[M42B18]	03.92- 09.93 03.92- 09.93 03.92- 09.93 09.93- 09.97 09.93- 09.97	CA1041IR CA1042IR CA826IR CA1106IR CA1398IR	14 90 14 105 14 65 14 70 14 80		03.92- 10.95 03.93- 09.97	CS516 CS1067	12 1.4 12 1.4
318 1.8 Ti	(E36)[M42B18]	11.94- 08.95 11.94- 08.95	CA1106IR CA1398IR	14 70 14 80		11.94- 08.95 11.94- 08.95	CS516 CS1067	12 1.4 12 1.4
318 1.9 i	(E46)[M43B19]	02.98- 09.01 02.98- 09.01 02.98- 09.01	CA1569IR CA1578IR CA1580IR	14 90 14 100 14 70		02.98- 09.01	CS1067	12 1.4
318 1.9 iS	(E36)[M44B19]	09.95- 04.99 09.95- 04.99	CA1106IR CA1398IR	14 70 14 80		09.95- 04.99	CS1067	12 1.4
318 1.9 Ti	(E36)[M44B19]	07.95- 09.00 07.95- 09.00	CA1106IR CA1398IR	14 70 14 80		07.95- 09.00	CS1067	12 1.4
318 2.0 Ci	(E46)[N42B20]	09.01- 09.01- 09.01- 09.01-	CA1654IR CA1660IR CA1773IR CA1774IR	14 90 14 120 14 110 14 145		09.01-	CS1256	12 1.4
	[N42B20A]	09.01- 09.01- 09.01- 09.01-	CA1654IR CA1660IR CA1773IR CA1774IR	14 90 14 120 14 110 14 145		09.01-	CS1256	12 1.4
	[N46B20]	02.05- 02.05-	CA1773IR CA1774IR	14 110 14 145		02.05-	CS1256	12 1.4
	[N46B20A]	03.05- 03.05-	CA1773IR CA1774IR	14 110 14 145		03.05-	CS1256	12 1.4
318 2.0 i	(E46)[N42B20]	09.01- 02.05 09.01- 02.05 09.01- 02.05 09.01- 02.05	CA1654IR CA1660IR CA1773IR CA1774IR	14 90 14 120 14 110 14 145		09.01- 02.05	CS1256	12 1.4
	[N46B20]	09.01- 02.05 09.01- 02.05 09.01- 02.05 09.01- 02.05	CA1654IR CA1660IR CA1773IR CA1774IR	14 90 14 120 14 110 14 145		09.01- 02.05	CS1256	12 1.4
	(E90)[N43B20A]	09.07- 08.08	CA2035IR	14 180		09.07- A25 09.07-	CS1412 CS1419	12 1.2 12 1.7
	[N46B20B]	09.05- 09.05-	CA1773IR CA1774IR	14 110 14 145		09.05-	CS1413	12 1.2
	[N46B20TU2]	09.07- 09.07-	CA1773IR CA1774IR	14 110 14 145		09.07-	CS1413	12 1.2
	(E91)[N43B20A]	09.07- 08.08	CA2035IR	14 180		A25 09.07- 09.07-	CS1419 CS1412	12 1.7 12 1.2
	[N46B20B]	01.06- 01.06-	CA1773IR CA1774IR	14 110 14 145		01.06-	CS1413	12 1.2
	[N46B20TU2]	09.07- 09.07- 09.07-	CA1773IR CA1774IR CA2035IR	14 110 14 145 14 180		09.07-	CS1413	12 1.2
318 2.0 Ti	(E46)[N42B20]	09.01- 09.01- 09.01- 09.01-	CA1654IR CA1660IR CA1773IR CA1774IR	14 90 14 120 14 110 14 145		09.01-	CS1256	12 1.4
	[N46B20]	09.01- 09.01- 09.01- 09.01-	CA1654IR CA1660IR CA1773IR CA1774IR	14 90 14 120 14 110 14 145		09.01-	CS1256	12 1.4
318 2.0 Diesel	(E46)[M47204D1] [M47N204D4] (E90)[M47N204D4] [N47D20]	09.01- 09.02 03.03- 02.05 09.05- 07.07- 02.10	CA1756IR CA1757IR CA1904IR CA2041IR	14 150 14 150 14 150 14 180		09.01- 02.05 03.03- 02.05 09.05- 07.07- 02.10	CS1265 CS1328 CS1406 CS1466 CS1467	12 1.8 12 1.6 12 1.8 12 2.0 12 2.2
	[N47D20A]	09.05- 09.05-	CA2041IR	14 180		A25 07.07- 09.05- A25 09.05-	CS1466 CS1467 CS1406	12 2.0 12 2.2 12 1.8
	(E91)[M47N204D4] [N47D20]	09.05- 07.07- 02.10	CA1904IR CA2041IR	14 150 14 180		A25 07.07- 07.07-	CS1467 CS1466	12 2.2 12 2.0
	[N47D20A]	09.07- 09.07-	CA2041IR	14 180		A25 09.07- 09.07-	CS1467 CS1466	12 2.2 12 2.0
318 2.0 TD	(E46)[M47N204D4]	03.03- 12.04	CA1757IR	14 150		03.03-	CS1328	12 1.6
320 2.0	(E21)[M10B20]					08.75- 08.77	CS76	12 1.0
320 2.0 i	(E21)[M10B20]					10.75- 08.77	CS76	12 1.0
	(E30)[M20B20]	09.82- 08.83 09.82- 08.85 09.85- 10.93 04.86- 10.93	CA196IR CA251IR CA362IR CA503IR	14 65 14 80 14 80 14 90		09.82- 06.87 04.86- 10.93 07.87- 10.93	CS183 CS377 CS577	12 1.1 12 1.4 12 1.4
	(E36)[M50B20]	09.90- 12.95 09.90- 08.91 09.90- 08.91 09.91- 12.95 09.91- 06.95	CA1064IR CA1073IR CA897IR CA1092IR CA1323IR	14 80 14 105 14 90 14 140 14 80		09.90- 12.95	CS1067	12 1.4
	[M52B20]	09.94- 12.99 09.94- 12.99	CA1064IR CA1092IR	14 80 14 140		09.94- 12.99	CS1067	12 1.4
	[M52B206S3]	01.95- 10.99 01.95- 10.99	CA1064IR CA1092IR	14 80 14 140		01.95- 10.99	CS1067	12 1.4
	(E46)[M52B20]	03.98- 09.01 03.98- 09.01	CA1256IR CA1591IR	14 90 14 120		03.98- 09.01	CS1067	12 1.4
	[M54B22]	09.00- 09.00-	CA1256IR CA1591IR	14 90 14 120		09.00-	CS1067	12 1.4
	(E90)[N43B20A]	09.07- 08.08	CA2035IR	14 180		A25 09.07- 09.07-	CS1419 CS1412	12 1.7 12 1.2
	[N46B20A]	01.05- 01.05-	CA1773IR CA1774IR	14 110 14 145		01.05-	CS1413	12 1.2
	[N46B20C]	01.05- 01.05-	CA1773IR CA1774IR	14 110 14 145		01.05-	CS1413	12 1.2
	(E91)[N43B20A]	09.07- 08.08	CA2035IR	14 180		A25 09.07- 09.07-	CS1419 CS1412	12 1.7 12 1.2
	(E92)[N43B20]	03.07- 03.07- 03.07- 08.08	CA1773IR CA1774IR CA2035IR	14 110 14 145 14 180		03.07-	CS1412	12 1.2
	[N46B20B]	11.06- 06.07 11.06- 06.07	CA1773IR CA1774IR	14 110 14 145		11.06- 06.07	CS1413	12 1.2
	(E93)[N43B20A]	03.07- 08.08	CA2035IR	14 180		AT 03.07- 03.07-	CS1412 CS1419	12 1.2 12 1.7
	[N46B20B]	03.07- 08.07 03.07- 08.07	CA1773IR CA1774IR	14 110 14 145		03.07- 08.07	CS1413	12 1.2
320 2.0 i L-Jetronic	(E30)[M20B20]	12.85- 03.93 12.85- 03.93	CA362IR CA503IR	14 80 14 90		12.85- 06.87 07.87- 03.93	CS183 CS377	12 1.1 12 1.4
320 2.0 i Motronic	(E30)[M20B20]	12.85- 03.93 12.85- 03.93	CA362IR CA503IR	14 80 14 90		12.85- 06.87 07.87- 03.93	CS183 CS377	12 1.1 12 1.4
320 2.0 iS	(E30)[S1420EA]	11.85-	CA503IR	14 90		05.88- 12.90	CS377	12 1.4
320 2.0 Si	(E90)[N45B20A]	05.06-	CA1774IR	14 145		05.06-	CS1413	12 1.2
320 2.0 V6	(E21)[M20B20]	09.77- 08.82	CA125IR#	14 65		09.77- 08.82	CS183	12 1.1
320 2.0 Diesel	(E46)[M47204D1]	04.98- 09.99	CA1559IR	14 120		04.98- 09.01	CS1265	12 1.8



BMW Continued

		09.99- 09.01	CA1756IR	14 150				
	[M47D20]	04.98- 09.99	CA1559IR	14 120	04.98- 09.01	CS1265	12 1.8	
		09.99- 09.01	CA1756IR	14 150				
	[M47N204D4]	09.01- 09.02	CA1756IR	14 150 ▲	09.01-	CS1328	12 1.6	
		10.02-	CA1757IR	14 150				
	(E90)[M47N204D4]	01.05-	CA1904IR	14 150	01.05-	CS1406	12 1.8	
					09.05-	CS1328	12 1.6	
	[M47N204D5]	01.05-	CA1904IR	14 150	01.05-	CS1406	12 1.8	
	[N47D20A]	09.07-	CA2041IR	14 180	09.07-	CS1466	12 2.0	
					A25 09.07-	CS1467	12 2.2	
	[N47D20C]	01.10-	CA2041IR	14 180	A25 01.10-	CS1467	12 2.2	
					01.10-	CS1466	12 2.0	
	(E91)[M47D20TU]	09.05-	CA1904IR	14 150	09.05-	CS1406	12 1.8	
	[M47N20]	01.05-	CA1904IR	14 150	01.05-	CS1406	12 1.8	
	[N47D20A]	09.07-	CA2041IR	14 180	A25 09.07-	CS1467	12 2.2	
					09.07-	CS1466	12 2.0	
	[N47D20C]	01.10-	CA2041IR	14 180	A25 01.10-	CS1467	12 2.2	
					01.10-	CS1466	12 2.0	
	(E92)[N47D20A]	03.07-	CA2041IR	14 180	03.07-	CS1466	12 2.0	
					A25 03.07-	CS1467	12 2.2	
	[N47D20C]	01.10-	CA2041IR	14 180	A25 01.10-	CS1467	12 2.2	
					01.10-	CS1466	12 2.0	
	(E93)[N47D20A]	03.07-	CA2041IR	14 180	A25 03.07-	CS1467	12 2.2	
					03.07-	CS1466	12 2.0	
	[N47D20C]	01.10-	CA2041IR	14 180	A25 01.10-	CS1467	12 2.2	
					01.10-	CS1466	12 2.0	
320 2.0 Diesel Xdrive	(E90)[N47D20C]	09.07-	CA2041IR	14 180	09.07- 12.10	CS1466	12 2.0	
					A25 09.07- 12.10	CS1467	12 2.2	
	(E91)[N47D20C]	09.07-	CA2041IR	14 180	09.07-	CS1466	12 2.0	
					A25 09.07-	CS1467	12 2.2	
	(E92)[N47D20C]	03.07-	CA2041IR	14 180	03.07-	CS1466	12 2.0	
					A25 03.07-	CS1467	12 2.2	
320 2.0 TD	(E46)[M47N204D4]	09.01- 09.02	CA1756IR	14 150 ▲	09.01-	CS1328	12 1.6	
		10.02-	CA1757IR	14 150				
320 2.2 Ci	(E46)[M54226S1]	09.00-	CA1256IR	14 90	09.00-	CS1067	12 1.4	
		09.00-	CA1591IR	14 120				
	[M54B22]	09.00-	CA1256IR	14 90	09.00-	CS1067	12 1.4	
		09.00-	CA1591IR	14 120				
320 2.2 i	(E46)[M54B22]	09.00- 02.05	CA1256IR	14 90	09.00- 02.05	CS1067	12 1.4	
		09.00- 02.05	CA1591IR	14 120				
323 2.3 i	(E21)[M20B23]	01.78- 08.82	CA196IR	14 65	01.78- 08.82	CS183	12 1.1	
	(E30)[M20B23]	09.82- 08.83	CA196IR	14 65	09.82- 08.86	CS183	12 1.1	
		09.83- 08.85	CA251IR	14 80				
		09.85- 08.86	CA362IR	14 80				
		12.85- 08.86	CA503IR	14 90				
323 2.5 Ci	(E46)[M52B25]	04.98- 09.00	CA1256IR	14 90	04.98- 09.00	CS1067	12 1.4	
		04.98- 09.00	CA1591IR	14 120				
323 2.5 i	(E36)[M52B25]	03.95- 12.99	CA1064IR	14 80	03.95- 12.99	CS1067	12 1.4	
		03.95- 12.99	CA1092IR	14 140				
	(E46)[M52B25]	03.98- 09.00	CA1256IR	14 90	03.98- 09.00	CS1067	12 1.4	
		03.98- 09.00	CA1591IR	14 120				
	(E90)[N52B25]	04.06- 03.07	CA2009IR	14 155	04.06- 06.07	CS1412	12 1.2	
		03.07-	CA1953IR	14 180				
	(E91)[N52B25A]	04.06- 03.07	CA2009IR	14 155	04.06- 06.07	CS1412	12 1.2	
		04.07- 06.07	CA1953IR	14 180				
323 2.5 Ti	(E36)[M52B25]	08.97- 08.00	CA1064IR	14 80	08.97- 08.00	CS1067	12 1.4	
		08.97- 08.00	CA1092IR	14 140				
324 2.4 Diesel	(E30)[M21D24W]	09.85- 08.91	CA196IR	14 65	09.85- 08.91	CS378	12 2.2	
		09.87- 08.91	CA609IR	14 80				
324 2.4 TD	(E30)[M21D24]	09.87- 06.93	CA196IR	14 65	09.87- 06.93	CS984	12 2.0	
		09.87- 06.93	CA609IR	14 80	09.87- 06.93	CS378	12 2.2	
		09.87- 06.93	CA609IR	14 80	09.87- 06.93	CS984	12 2.0	
	[M21D24WA]	09.87- 06.93	CA196IR	14 65				
		09.87- 06.93	CA609IR	14 80				
325 2.5 Ci	(E46)[M54256S5]	09.00-	CA1256IR	14 90	09.00-	CS1067	12 1.4	
		09.00-	CA1591IR	14 120				
325 2.5 i	(E30)[M20B25]	09.83- 08.85	CA251IR	14 80	09.83- 12.86	CS183	12 1.1	
		09.85- 10.93	CA362IR	14 80	12.86- 10.93	CS377	12 1.4	
		12.85- 10.93	CA503IR	14 90				
	(E36)[M50B25]	09.90- 08.91	CA1073IR	14 105	09.90- 04.99	CS1067	12 1.4	
		09.90- 08.91	CA897IR	14 90				
		09.91- 04.99	CA1064IR	14 80				
		09.91- 04.99	CA1092IR	14 140				
	[M52B25]	09.90- 08.91	CA1073IR	14 105	09.90- 09.95	CS1067	12 1.4	
		09.90- 08.91	CA897IR	14 90				
		09.91- 09.95	CA1064IR	14 80				
		09.91- 09.95	CA1092IR	14 140				
	(E46)[M54256S5]	09.00- 03.05	CA1256IR	14 90	09.00- 03.05	CS1067	12 1.4	
		09.00- 03.05	CA1591IR	14 120				
	(E90)[N52B25]	01.05-	CA1953IR	14 180	01.05-	CS1412	12 1.2	
		01.05-	CA2009IR	14 155				
	(E92)[N52B25]	09.06-	CA1953IR	14 180	09.06-	CS1412	12 1.2	
	(E93)[N52B25]	03.07-	CA1953IR	14 180	03.07-	CS1412	12 1.2	
325 2.5 iX	(E30)[M20B25]	03.86- 10.93	CA362IR	14 80	12.86- 10.93	CS377	12 1.4	
		03.86- 10.93	CA503IR	14 90	03.86- 12.86	CS183	12 1.1	
325 2.5 Ti	(E46)[M54256S5]	06.01-	CA1256IR	14 90	06.01-	CS1067	12 1.4	
		06.01-	CA1591IR	14 120				
325 2.5 Xi	(E46)[M54256S5]	09.00- 03.05	CA1256IR	14 90	09.00- 03.05	CS1067	12 1.4	
		09.00- 03.05	CA1591IR	14 120				
	(E90)[N52B25A]	01.05-	CA2009IR	14 155	01.05-	CS1412	12 1.2	
	[N52B25C]	01.05-	CA1953IR	14 180	01.05-	CS1412	12 1.2	
		01.05-	CA2009IR	14 155				
	(E91)[N52B25C]	01.05-	CA1953IR	14 180	01.05-	CS1412	12 1.2	
		01.05-	CA2009IR	14 155				
	(E92)[N52B25]	w/Seat heating 09.06-	CA1953IR	14 180	09.06-	CS1412	12 1.2	
325 2.5 TD	(E36)[M51D25]	03.91- 02.98	CA1150IR	14 105	09.91- 02.98	CS984	12 2.0	
		03.91- 02.98	CA845IR	14 95				
325 2.5 TDS	(E36)[M51D25]	05.93- 10.99	CA1150IR	14 105	05.93- 10.99	CS984	12 2.0	
		05.93- 12.95	CA845IR	14 95				
325 2.7 E	(E30)[M20B27]	10.83- 08.85	CA251IR	14 80	01.87- 12.88	CS377	12 1.4	
		09.85- 12.88	CA362IR	14 80	10.83- 12.86	CS183	12 1.1	
		12.85- 12.88	CA503IR	14 90				
325 3.0 i	(E90)[N53B30A]	09.07-	CA1953IR	14 180	09.07-	CS1412	12 1.2	
	(E91)[N53B30A]	09.07-	CA1953IR	14 180	09.07-	CS1412	12 1.2	
	(E92)[N52B25]	09.07-	CA1953IR	14 180	09.07-	CS1412	12 1.2	
	(E93)[N53B30]	03.07-	CA1953IR	14 180	03.07-	CS1412	12 1.2	
325 3.0 i Xdrive	(E90)[N53B30A]	09.08-	CA1953IR	14 180	09.08-	CS1412	12 1.2	
	(E91)[N53B30A]	09.08-	CA1953IR	14 180	09.08-	CS1412	12 1.2	
	(E92)[N53B30A]	09.08-	CA1953IR	14 180	09.08-	CS1412	12 1.2	
	(E90)[N53B30A]	09.07-	CA1953IR	14 180	09.07-	CS1412	12 1.2	
325 3.0 Xi	(E91)[N53B30A]	09.07-	CA1953IR	14 180	09.07-	CS1412	12 1.2	
	(E92)[N53B30A]	09.07-	CA1953IR	14 180	09.07-	CS1412	12 1.2	



325 3.0 Diesel	(E90)[M57306D3] [N57D30A]	09.06-	CA1904IR	14 150	09.06-	CS1406	12 1.8
	(E91)[M57306D3] [N57D30A]	09.06-	CA1904IR	14 150	09.06-	CS1466	12 2.0
	(E92)[N57D30A] [N57N306D3]	03.07-	CA1904IR	14 150	03.07-	CS1406	12 1.8
	(E93)[N57306D3] [N57D30A]	03.07-	CA1904IR	14 150	03.07-	CS1466	12 1.8
328 2.8 Ci	(E46)[M52B28]	04.99- 09.00 04.99- 09.00	CA1256IR CA1591IR	14 90 14 120	04.99- 09.00	CS1067	12 1.4
	(E36)[M52B28]	01.95- 12.99 01.95- 12.99 01.95- 10.99 03.95- 12.99	CA1064IR CA1092IR CA8971R CA1323IR	14 80 14 140 14 90 14 80	01.95- 12.99	CS1067	12 1.4
328 2.8 i	(E46)[M52B28]	02.98- 09.00 02.98- 09.00	CA1256IR CA1591IR	14 90 14 120	02.98- 09.00	CS1067	12 1.4
	(E46)[M57D30]	10.99- 02.05 10.99- 02.05	CA1559IR CA1756IR	14 120 14 150	10.99- 02.05	CS1171	12 2.2
330 2.9 Diesel	(E46)[M57D30]	06.00- 03.06	CA1756IR	14 150	06.00- 03.06	CS1171	12 2.2
330 2.9 Diesel Xdrive	(E46)[M57D30]	06.00-	CA1256IR	14 90	06.00-	CS1067	12 1.4
	(E46)[M54306S3]	06.00-	CA1591IR	14 120	06.00-	CS1067	12 1.4
330 3.0 Ci	[M54B30]	06.00-	CA1256IR	14 90	06.00-	CS1067	12 1.4
	[M54B30]	06.00-	CA1591IR	14 120	06.00-	CS1067	12 1.4
330 3.0 i	(E46)[M54B30]	06.00- 02.05 06.00- 02.05	CA1256IR CA1591IR	14 90 14 120	06.00- 02.05	CS1067	12 1.4
	(E90)[N52B30]	01.05- 01.05	CA1953IR CA2009IR	14 180 14 155	01.05-	CS1412	12 1.2
330 3.0 i Xdrive	[N52B30A]	01.05-	CA1953IR	14 180	01.05-	CS1412	12 1.2
	[N53B30A]	09.07-	CA1953IR	14 180	09.07-	CS1412	12 1.2
330 3.0 i Xdrive	(E91)[N53B30A]	09.07-	CA1953IR	14 180	09.07-	CS1412	12 1.2
	(E92)[N52B30]	09.06-	CA1953IR	14 180	09.06-	CS1412	12 1.2
330 3.0 i Xdrive	[N53B30]	09.06-	CA1953IR	14 180	09.06-	CS1412	12 1.2
	(E93)[N52B30] [N53B30]	03.07- 03.07	CA1953IR CA1953IR	14 180 14 180	03.07- 03.07	CS1412 CS1412	12 1.2 12 1.2
330 3.0 i Xdrive	(E90)[N53B30A]	09.08-	CA1953IR	14 180	09.08-	CS1412	12 1.2
	(E91)[N53B30A]	09.08-	CA1953IR	14 180	09.08-	CS1412	12 1.2
330 3.0 Xi	(E92)[N53B30A]	09.08-	CA1953IR	14 180	09.08-	CS1412	12 1.2
	(E46)[M54B30]	06.00- 02.05 06.00- 02.05	CA1256IR CA1591IR	14 90 14 120	06.00- 02.05	CS1067	12 1.4
330 3.0 Xi	(E90)[N52B30A]	01.05-	CA1953IR	14 180	01.05-	CS1412	12 1.2
	[N53B30A]	09.07-	CA1953IR	14 180	09.07-	CS1412	12 1.2
330 3.0 Xi	(E91)[N52B30A]	01.05- 01.05	CA1953IR CA2009IR	14 180 14 155	01.05-	CS1412	12 1.2
	[N53B30A]	09.07-	CA1953IR	14 180	09.07-	CS1412	12 1.2
330 3.0 Diesel	(E92)[N52B30A]	09.06-	CA1953IR	14 180	09.06-	CS1412	12 1.2
	(E46)[M57N306D2]	03.03- 02.05	CA1757IR	14 150	03.03- 02.05	CS1473	12 2.0
330 3.0 Diesel	(E90)[M57306D3] [N57D30A]				09.05-	CS1406	12 1.8
	(E91)[M57306D3] [N57D30A]				A25 01.09- 01.09	CS1467 CS1466	12 2.2 12 2.0
330 3.0 Diesel	(E92)[M57306D3] [N57D30A]				09.05-	CS1406	12 1.8
	(E92)[M57306D3] [N57D30A]	09.06-	CA1904IR	14 150	A25 01.09- 01.09	CS1467 CS1466	12 2.2 12 2.0
330 3.0 Diesel	(E93)[N57D30A]				A25 01.09- 01.09	CS1467 CS1466	12 2.2 12 2.0
	[N57N306D3]	03.07-	CA1904IR	14 150	03.07- 03.07	CS1406	12 1.8
330 3.0 Diesel Xdrive	(E46)[M57N306D2]	03.03- 02.05	CA1757IR	14 150	03.03- 02.05	CS1473	12 2.0
	(E90)[M57306D3] [N57D30A]	09.05-	CA1904IR	14 150	09.05-	CS1406	12 1.8
330 3.0 Diesel Xdrive	(E91)[M57306D3] [N57D30A]	09.05-	CA1904IR	14 150	A25 01.09- 01.09	CS1467 CS1466	12 2.2 12 2.0
	(E92)[M57306D3] [N57D30A]	09.06-	CA1904IR	14 150	A25 01.09- 01.09	CS1467 CS1466	12 2.2 12 2.0
335 3.0 i	(E90)[N54B30]				09.06-	CS1412	12 1.2
	(E91)[N54B30]				09.06-	CS1412	12 1.2
335 3.0 i Xdrive	(E92)[N54B30]				09.06-	CS1412	12 1.2
	(E93)[N54B30]				03.07-	CS1412	12 1.2
335 3.0 i Xdrive	(E90)[N54B30A]				09.08-	CS1412	12 1.2
	(E91)[N54B30A]				09.08-	CS1412	12 1.2
335 3.0 Xi	(E92)[N54B30A]				09.08-	CS1412	12 1.2
	(E90)[N54B30A]				09.07-	CS1412	12 1.2
335 3.0 Xi	(E91)[N54B30A]				09.07-	CS1412	12 1.2
	(E92)[N54B30A]				09.06-	CS1412	12 1.2
335 3.0 Diesel	(E90)[M57N3]	09.06-	CA2051IR*	14 150	09.06-	CS1406	12 1.8
	(E91)[M57N3]	09.06-	CA2051IR*	14 150	09.06-	CS1406	12 1.8
335 3.0 Diesel	(E92)[M57N3]	09.06-	CA1904IR	14 150	09.06-	CS1406	12 1.8
	(E92)[M57N3]	09.06-	CA2051IR*	14 150	09.06-	CS1406	12 1.8
518 1.8	(E28)[M10B18]	09.82- 08.84 09.82- 08.84	CA1991R CA2511R	14 65 14 80	06.81- 08.84	CS119	12 1.5
	(E12)[M10B18]	08.79- 08.81	CA1961R	14 65	08.79- 08.81	CS119	12 1.5
518 1.8 i	(E28)[M10B18]	10.81- 01.84 09.84- 11.85 12.85- 12.87	CA1961R CA2511R CA3621R	14 65 14 80 14 80	10.81- 12.87	CS119	12 1.5
	(E34)[M40B18]	08.89- 09.91 10.91- 09.95 10.91- 09.95	CA6081R CA1041IR CA1042IR	14 90 14 90 14 105	08.89- 09.95 08.89- 09.95	CS1067 CS516	12 1.4 12 1.4
518 1.8 i	[M43B18]	05.94- 01.97	CA1398IR	14 80	08.89- 09.95 08.89- 01.97	CS516 CS1067	12 1.4 12 1.4
	(E34)[M43B18]	11.95- 06.96	CA1398IR	14 80	11.95- 06.96 11.95- 06.96	CS1067 CS516	12 1.4 12 1.4
518 2.0 i	(E12)[M10B20]				08.77- 09.79	CS76	12 1.0
520 2.0	(E12)[M10B20]				08.72- 08.77	CS76	12 1.0
520 2.0 i 24V	(E34)[M50B20]	09.89- 08.91 09.89- 08.91 09.89- 08.91 09.91- 09.95	CA1054IR CA8591R CA9011R# CA1064IR	14 140 14 90 14 80 14 80	09.89- 09.95	CS516	12 1.4
	(E34)[M50B20]	09.91- 09.95	CA1092IR	14 140	09.91- 09.95		
520 2.0 i	(E12)[M10B20]				08.72- 08.77	CS76	12 1.0
	(E28)[M20B20]	08.85- 11.85 11.85- 12.87 12.85- 12.87	CA2511R CA5031R CA3621R	14 80 14 90 14 80	08.85- 12.87	CS183	12 1.1
520 2.0 i	(E34)[M20B20]	01.88- 08.91 01.88- 08.91	CA5401R CA5471R	14 115 14 90	01.88- 08.91	CS377	12 1.4





525 3.0 i	(E60)[N53B25]	w/Seat heating 01.07-	CA1953IR	14	180	01.07-	CS1412	12	1.2
	(E61)[N53B30]					01.07-	CS1412	12	1.2
525 3.0 i Xdrive	(E61)[N53B30A]	09.08-	CA1953IR	14	180	09.08-	CS1412	12	1.2
525 3.0 Xi	(E60)[N53B25]	w/Seat heating 01.07-	CA1953IR	14	180	01.07-	CS1412	12	1.2
	(E61)[N53B30]	w/Seat heating 01.07-	CA1953IR	14	180	01.07-	CS1412	12	1.2
525 3.0 Diesel	(E60)[M57306D3]	01.07-	CA1905IR	14	170	01.07-	CS1328	12	1.6
						01.07-	CS1406	12	1.8
	(E61)[N57306D3]	01.07-	CA1905IR	14	170	01.07-	CS1406	12	1.8
	(F10)[N57D30A]					03.10-	CS1466	12	2.0
	(F11)[N57D30A]					09.10-	CS1466	12	2.0
525 3.0 Diesel Xdrive	(E60)[M57306D3]	01.07-	CA1905IR	14	170	01.07-	CS1406	12	1.8
	[M57N2]	09.08-	CA1905IR	14	170	09.08-	CS1406	12	1.8
	(E61)[M57N2]	09.08-	CA1905IR	14	170	09.08-	CS1406	12	1.8
	[N57306D3]	01.07-	CA1905IR	14	170	01.07-	CS1406	12	1.8
528 2.8	(E12)[M30B28]				01.75-	CS76	12	1.0	
528 2.8 i	(E12)[M30B28]				09.79-	CS119	12	1.5	
					04.77-	CS76	12	1.0	
	(E28)[M30B28]	06.81-	CA2511R	14	80	06.81-	CS119	12	1.5
		11.85-	CA503IR	14	90				
		12.85-	CA362IR	14	80				
	(E39)[M52B28]	11.95-	CA1256IR	14	90	11.95-	CS1067	12	1.4
		09.00-	CA1325IR	14	140				
		11.95-	CA1591IR	14	120				
530 2.9 Diesel	(E39)[M57D30]	08.98-	CA1559IR	14	120	08.98-	CS1171	12	2.2
		08.98-	CA1584IR	14	150				
530 2.9 TD	(E39)[M57D30]	08.98-	CA1559IR	14	120	08.98-	CS1171	12	2.2
		08.98-	CA1584IR	14	150				
530 3.0 Diesel	(E60)[N57306D2]	07.03-	CA1905IR	14	170	07.03-	CS1473	12	2.0
		07.03-	CA2051IR*	14	150				
530 3.0 i V8	(E34)[M60B30]	09.92-	CA1245IR	14	140	09.92-	CS792	12	1.7
530 3.0 i	(E34)[M30B30]	01.88-	CA5411R	14	90	01.88-	CS515	12	1.7
		01.88-	CA5421R	14	115				
		09.90-	CA9021R	14	140				
	(E39)[M54B30]	09.00-	CA1256IR	14	90	09.00-	CS1067	12	1.4
		09.00-	CA1591IR	14	120				
	(E60)[M54B30]	07.03-	CA1825IR	14	150	07.03-	CS1067	12	1.4
	[N52B30]	w/Seat heating 01.07-	CA1953IR	14	180				
	[N52B30A]	07.05-	CA1953IR	14	180	07.05-	CS1412	12	1.2
		07.05-	CA2009IR	14	155				
	[N53B30]	w/Seat heating 01.07-	CA1953IR	14	180				
	(E61)[M54B30]	06.04-	CA1825IR	14	150	06.04-	CS1067	12	1.4
[N52B30]	w/Seat heating 01.07-	CA1953IR	14	180	01.07-	CS1412	12	1.2	
[N52B30A]	07.05-	CA1953IR	14	180	07.05-	CS1412	12	1.2	
	07.05-	CA2009IR	14	155					
[N53B30]	w/Seat heating 01.07-	CA1953IR	14	180	01.07-	CS1412	12	1.2	
530 3.0 i Xdrive	(E60)[N53B30A]	09.08-	CA1953IR	14	180	09.08-	CS1412	12	1.2
	(E61)[N53B30A]	09.08-	CA1953IR	14	180	09.08-	CS1412	12	1.2
530 3.0 Xi	(E60)[N52B30]	07.05-	CA2009IR	14	155	07.05-	CS1412	12	1.2
		w/Seat heating 01.07-	CA1953IR	14	180				
	[N53B30]	w/Seat heating 01.07-	CA1953IR	14	180	01.07-	CS1412	12	1.2
	(E61)[N52B30A]	07.05-	CA1953IR	14	180	07.05-	CS1412	12	1.2
	07.05-	CA2009IR	14	155					
[N53B30]	w/Seat heating 01.07-	CA1953IR	14	180	01.07-	CS1412	12	1.2	
530 3.0 Diesel	(E60)[M57306D3]	07.03-	CA2051IR*	14	150	09.05-	CS1406	12	1.8
		09.05-	CA1905IR	14	170	01.07-	CS1328	12	1.6
	(E61)[M57306D3]	07.05-	CA1905IR	14	170	07.05-	CS1406	12	1.8
		07.05-	CA2051IR*	14	150				
	[N57306D2]	06.04-	CA1905IR	14	170	06.04-	CS1473	12	2.0
		06.04-	CA2051IR*	14	150				
	(F10)[N57D30A]					03.10-	CS1466	12	2.0
	(F11)[N57D30A]					09.10-	CS1466	12	2.0
530 3.0 Diesel Gran Turismo	(F07)[N57D30A]				10.09-	CS1466	12	2.0	
					07.10-	CS1466	12	2.0	
530 3.0 Diesel Xdrive	(E60)[M57306D3]	01.07-	CA1905IR	14	170	01.07-	CS1328	12	1.6
						01.07-	CS1406	12	1.8
	[M57N2]	07.05-	CA1905IR	14	170	07.05-	CS1406	12	1.8
		07.05-	CA2051IR*	14	150				
	(E61)[M57306D3]	07.05-	CA1905IR	14	170	07.05-	CS1406	12	1.8
		07.05-	CA2051IR*	14	150				
	[M57N2]	09.08-	CA1905IR	14	170	09.08-	CS1406	12	1.8
	(F07GT)[N57D30A]					09.10-	CS1466	12	2.0
	(F10)					09.11-	CS1466	12	2.0
					A25 09.11-	CS1467	12	2.2	
535 3.0 xDrive	(F07GT)[N55B30A]				09.10-	CS1412	12	1.2	
535 3.0 i	(F10)[N55B30A]				03.10-	CS1412	12	1.2	
	(F11)[N55B30A]				09.10-	CS1412	12	1.2	
535 3.0 i Gran Turismo	(F07)[N55B30A]				10.09-	CS1412	12	1.2	
535 3.0 i xDrive	(F10)[N55B30A]				03.10-	CS1412	12	1.2	
535 3.0 Diesel	(E60)[M57306D4]	09.04-	CA1905IR	14	170	09.04-	CS1473	12	2.0
		09.04-	CA2051IR*	14	150				
	[M57N3]	01.07-	CA1905IR	14	170	01.07-	CS1406	12	1.8
	(E61)[M57306D4]	09.04-	CA1905IR	14	170	09.04-	CS1473	12	2.0
		09.04-	CA2051IR*	14	150				
	[M57N3]	01.07-	CA1905IR	14	170	01.07-	CS1406	12	1.8
(F07GT)[N57D30B]					09.10-	CS1466	12	2.0	
(F10)[N57D30B]					09.10-	CS1466	12	2.0	
(F11)[N57D30B]					09.10-	CS1466	12	2.0	
535 3.0 Diesel xDrive	(F07GT)[N57D30B]				09.10-	CS1466	12	2.0	
535 3.4 i	(E28)[M30B35]	09.84-	CA2511R	14	80	01.85-	CS119	12	1.5
		11.85-	CA503IR	14	90				
		12.85-	CA362IR	14	80				
535 3.5 i	(E34)[M30B35]	01.88-	CA5411R	14	90	01.88-	CS515	12	1.7
		01.88-	CA5421R	14	115				
		01.88-	CA9021R	14	140				
	(E39)[M62B35]	01.96-	CA1207IR	14	140	01.96-	CS792	12	1.7
		04.96-	CA1591IR	14	120				
	10.98-	CA1632IR	14	150	A35				
540 4.0 i V8	(E34)[M60B40]	09.92-	CA1245IR	14	140	09.92-	CS792	12	1.7
540 4.0 i	(E34)[M60B40]	09.93-	CA1245IR	14	140	09.93-	CS792	12	1.7
540 4.4 i	(E39)[M62B44]	01.96-	CA1207IR	14	140	01.96-	CS792	12	1.7
		01.96-	CA1591IR	14	120				
		10.98-	CA1632IR	14	150	A35			
628 2.8 CSi	(E24)[M30B28]	09.79-	CA1991R	14	65	09.79-	CS119	12	1.5
		06.81-	CA2511R	14	80				
		11.85-	CA503IR	14	90				
		12.85-	CA362IR	14	80				
630 3.0 CS	(E24)[M30B30]					04.76-	CS119	12	1.5
	(E63)[N52B30A]	09.04-	CA1953IR	14	180	09.04-	CS1412	12	1.2
630 3.0 i		09.04-	CA2009IR	14	155				
	(E64)[N52B30A]	09.04-	CA1953IR	14	180	09.04-	CS1412	12	1.2
		09.04-	CA2009IR	14	155				
633 3.2 CSi	(E24)[M30B32]	04.76-	CA1991R	14	65	04.76-	CS119	12	1.5









**BMW Continued**

X6 3.0 i Xdrive	(E71)[N54B30A]					09.08-	CS1412	12 1.2
X6 3.0 iX	(E71)[N54B30A]					05.08-	CS1412	12 1.2
X6 3.0 Diesel Xdrive	(E71)[M57D30]	05.08-	CA2095IR*	14 170		05.08-	CS1406	12 1.8
		05.08-	CA2100IR*	14 230				
	[M57D30N2]	05.08-	CA2095IR*	14 170		05.08-	CS1406	12 1.8
		05.08-	CA2100IR*	14 230				
	[M57N2]	09.08-	CA2095IR*	14 170		09.08-	CS1406	12 1.8
		09.08-	CA2100IR*	14 230		09.08-	CS1406	12 1.8
		09.08-	CA2100IR*	14 230				
		09.08-	CA2095IR*	14 170				
X6 3.0 Diesel xDrive30d	(E71)[N57D30A]					09.10-	CS1466	12 2.0
	(E71, E72)[N57D30A]					09.10-	CS1466	12 2.0
X6 3.0 Diesel xDrive40d	(E71)[N57D30B]					10.10-	CS1466	12 2.0
Z1 2.5	[M20B25]	06.88- 06.91	CA362IR	14 80		06.88- 06.91	CS377	12 1.4
		06.88- 06.91	CA503IR	14 90				
Z3 1.8	(E36)[M43194E1]	07.98- 01.03	CA1256IR	14 90		07.98- 01.03	CS1067	12 1.4
		07.98- 01.03	CA1261IR	14 90				
	[M43B19]	07.98- 01.03	CA1256IR	14 90		07.98- 01.03	CS1067	12 1.4
		07.98- 01.03	CA1261IR	14 90				
Z3 1.8 i	(E36)[M43B18]				09.94- 12.98	CS1067	12 1.4	
Z3 1.9 i 16V	[M44B19]				09.95- 12.99	CS1067	12 1.4	
Z3 1.9 i	(E36)[M43194E1]				06.00- 01.03	CS1067	12 1.4	
Z3 2.0	(E36)[M52B20]	04.99- 01.03	CA1207IR	14 140		04.99- 01.03	CS1067	12 1.4
		04.99- 01.03	CA1256IR	14 90				
		04.99- 01.03	CA1325IR	14 140				
Z3 2.2	(E36)[M54B22]	08.00- 01.03	CA1256IR	14 90		08.00- 01.03	CS1067	12 1.4
		08.00- 01.03	CA1259IR	14 120				
			CA1591IR	14 120				
Z3 2.8 i	(E36)[M52B28]	03.96- 09.00	CA1256IR	14 90		11.96- 09.00	CS1067	12 1.4
		03.97- 09.00	CA1325IR	14 140				
		04.97- 09.00	CA1591IR	14 120				
Z3 3.0	(E36)[M54B30]	06.00- 06.03	CA1256IR	14 90		06.00- 06.03	CS1067	12 1.4
		06.00- 06.03	CA1591IR	14 120				
Z3 3.2	(E36)[S54326S4] [S54B32]	06.01- 01.03	CA1982IR	14 120				
		06.01- 01.03	CA1982IR	14 120				
Z3 3.2 M	(E36)[S50B32]				03.97- 12.00	CA1332IR	14 105	
Z4 2.0 i	(E85)[N46B20A]	04.05-	CA1773IR	14 110		04.05-	CS1413	12 1.2
		04.05-	CA1774IR	14 145				
Z4 2.2 i	(E85)[M54B22]				10.03-	CS1067	12 1.4	
Z4 2.5 i	(E85)[M54256S5] [N52B25A]	02.03-	CA1826IR	14 120		02.03-	CS1067	12 1.4
		01.06-	CA2009IR	14 155		01.06-	CS1412	12 1.2
Z4 2.5 i Sdrive	(E89)[N52B25]				05.09-	CS1412	12 1.2	
Z4 2.5 Si	(E85)[N52B25A]				01.06-	CA2009IR	14 155	
Z4 3.0 sDrive35is	(E89)[N54B30A]				09.10-	CS1412	12 1.2	
Z4 3.0 i	(E85)[M54B30]				02.03-	CS1067	12 1.4	
Z4 3.0 i Sdrive	(E89)[N52B30] [N54B30A]	05.09-				05.09-	CS1412	12 1.2
		05.09-				05.09-	CS1412	12 1.2
Z4 3.0 Si	(E85)[N52B30A]				01.06-	CA2009IR	14 155	
Z8 4.9	(E52)[S38B49]				06.00- 06.03	CS792	12 1.7	
<b>PASSENGER CARS US</b>								
318 1.8 i	[M10]					01.84- 01.85	CA251IR	14 80
318 1.8 Ti	[M42]	01.95-	CA1042IR	14 105				
		01.95-	CA1398IR	14 80				
318 1.9	[M44]	01.96- 01.97	CA1261IR	14 90		01.96- 01.97	CS1067	12 1.4
		01.96- 01.97	CA1398IR	14 80				
318 1.9 i	[M44]	01.96- 01.98	CA1261IR	14 90		01.96- 01.98	CS1067	12 1.4
		01.96- 01.98	CA1398IR	14 80				
318 1.9 iS	[M44]	01.96- 01.97	CA1261IR	14 90		01.96- 01.97	CS1067	12 1.4
		01.96- 01.97	CA1398IR	14 80				
318 1.9 Ti	[M44]	01.96- 01.99	CA1261IR	14 90		01.96- 01.99	CS1067	12 1.4
		01.96- 01.99	CA1398IR	14 80				
320 1.8 i	[M10]					01.80- 01.83	CS119	12 1.5
320 2.0 i	[M10]					01.77- 01.79	CS119	12 1.5
323 2.5 Ci	[M52]					01.00- 01.00	CS1067	12 1.4
323 2.5 i	[M52]	01.99- 01.00	CA1054IR	14 140		01.99- 01.00	CS1067	12 1.4
		01.99- 01.00	CA1064IR	14 80				
		01.99- 01.00	CA1092IR	14 140				
323 2.5 i Sport	[M52]	01.00- 01.00	CA1591IR	14 120		01.00- 01.00	CS1067	12 1.4
		01.98- 01.99	CA1054IR	14 140		01.98- 01.99	CS1067	12 1.4
323 2.5 iC	[M52]	01.98- 01.99	CA1064IR	14 80				
		01.98- 01.99	CA1092IR	14 140				
		01.98- 01.99	CA1054IR	14 140		01.98- 01.99	CS1067	12 1.4
323 2.5 iS	[M52]	01.98- 01.99	CA1064IR	14 80				
		01.98- 01.99	CA1064IR	14 80				
		01.98- 01.99	CA1092IR	14 140				
		01.01- 01.03	CA1591IR	14 120		01.01- 01.03	CS1067	12 1.4
325 2.5 i	[M20]	01.87- 01.91	CA362IR	14 80		01.87- 01.91	CS377	12 1.4
	[M50]	01.92- 01.95	CA1054IR	14 140		01.92- 01.95	CS377	12 1.4
		01.92- 01.95	CA1064IR	14 80				
		01.92- 01.95	CA1073IR	14 105				
		01.92- 01.95	CA1092IR	14 140				
01.92- 01.95	CA362IR	14 80						
01.92- 01.95	CA503IR	14 90						
[M54]	01.01- 01.03	CA1591IR	14 120		01.01- 01.03	CS1067	12 1.4	
	01.01- 01.03	CA1591IR	14 120		01.01- 01.03	CS1067	12 1.4	
325 2.5 iC	[M20] [M50]	01.87- 01.93	CA362IR	14 80		01.87- 01.93	CS377	12 1.4
		01.94- 01.95	CA1054IR	14 140				
		01.94- 01.95	CA1064IR	14 80				
		01.94- 01.95	CA1092IR	14 140				
[M54]	01.94- 01.95	CA503IR	14 90					
	01.87- 01.91	CA362IR	14 80		01.87- 01.91	CS377	12 1.4	
325 2.5 iS	[M20] [M50]	01.92- 01.95	CA1054IR	14 140		01.92- 01.95	CS377	12 1.4
		01.92- 01.95	CA1064IR	14 80				
		01.92- 01.95	CA1092IR	14 140				
		01.92- 01.95	CA503IR	14 90				
325 2.5 iX	[M20]				01.88- 01.91	CS377	12 1.4	
325 2.5 Xi	[M54]				01.01- 01.03	CS1067	12 1.4	
325 2.5 Xi Sport	[M54]				01.01- 01.03	CS1067	12 1.4	
325 2.7	[M20]				01.87- 01.88	CS377	12 1.4	
325 2.7 E	[M20]				01.84- 01.87	CS183	12 1.1	
328 2.8	[M52]	01.98- 01.99	CA1054IR	14 140		01.98- 01.99	CS1067	12 1.4
		01.98- 01.99	CA1064IR	14 80				
		01.98- 01.99	CA1092IR	14 140				
		01.00- 01.00	CA1591IR	14 120		01.00- 01.00	CS1067	12 1.4
328 2.8 Ci	[M52]	01.00- 01.00	CA1591IR	14 120		01.96- 01.00	CS1067	12 1.4
		01.96- 01.99	CA1054IR	14 140				
		01.96- 01.99	CA1064IR	14 80				
		01.96- 01.99	CA1092IR	14 140				
328 2.8 iC	[M52]	01.96- 01.97	CA1054IR	14 140		01.96- 01.97	CS1067	12 1.4
		01.96- 01.97	CA1064IR	14 80				
		01.96- 01.97	CA1092IR	14 140				



328 2.8 iS	[M52]	01.96- 01.99 01.96- 01.99 01.96- 01.99	CA1054IR CA1064IR CA1092IR	14 140 14 80 14 140		01.96- 01.99	CS1067	12 1.4
330 3.0 Ci	[M54]	01.01- 01.03	CA1591IR	14 120		01.01- 01.03	CS1067	12 1.4
330 3.0 i	[M54]	01.01- 01.03	CA1591IR	14 120		01.01- 01.03	CS1067	12 1.4
330 3.0 Xi	[M54]	01.02- 01.03	CA1591IR	14 120		01.02- 01.03	CS1067	12 1.4
524 2.4 TD	[M21]	01.85- 01.86 01.85- 01.86	CA1961R CA6091R	14 65 14 80				
525 2.5 i	[M20] [M50]	01.91- 01.95 01.91- 01.95 01.91- 01.95	CA1054IR CA1073IR CA8591R	14 140 14 105 14 90		01.89- 01.90	CS377	12 1.4
	[M54]	01.01- 01.03	CA1591IR	14 120		01.01- 01.03	CS1067	12 1.4
525 2.5 i Sport	[M54]	01.01- 01.03	CA1591IR	14 120		01.01- 01.03	CS1067	12 1.4
525 2.5 iT	[M50]	01.93- 01.93- 01.95-	CA1064IR CA1092IR CA1054IR	14 80 14 140 14 140				
528 2.7 E	[M20]	01.82- 01.86 01.87- 01.88	CA1961R CA3621R	14 65 14 80		01.82- 01.86 01.87- 01.88	CS183 CS377	12 1.1 12 1.4
528 2.8 i	[M30]	01.79- 01.81	CA1991R	14 65		01.79- 01.81	CS119	12 1.5
528 2.8 iT	[M52]	01.97-	CA1256IR	14 90		01.97- 01.00	CS1067	12 1.4
528 2.8 iT	[M52]	01.99- 01.00	CA1591IR	14 120		01.99- 01.00	CS1067	12 1.4
530 3.0 i	[M30] [M54] [M60]	01.01- 01.03 01.94- 01.95	CA1591IR CA1245IR	14 120 14 140		01.75- 01.78 01.01- 01.02	CS119 CS1067	12 1.5 12 1.4
530 3.0 iT	[M60]	01.94- 01.95	CA1245IR	14 140		01.94- 01.95	CS792	12 1.7
530 3.2 i	[M30]	01.83- 01.84	CA2511R	14 80		01.83- 01.84	CS119	12 1.5
535 3.5 i	[M30]	01.85- 01.86 01.87- 01.88- 01.93	CA2511R CA3621R CA5411R	14 80 14 80 14 90		01.85- 01.86 01.88- 01.93	CS119 CS515	12 1.5 12 1.7
		01.88- 01.93	CA9021R	14 140				
535 3.5 iS	[M30]	01.88- 01.88-	CA5411R CA9021R	14 90 14 140		01.88-	CS515	12 1.7
540 4.0 i	[M60]	01.94- 01.95	CA1245IR	14 140		01.94- 01.95	CS792	12 1.7
540 4.4 i	[M62]	01.03- 01.97- 01.02	CA1632IR CA1207IR	14 150 A35 14 140		01.97- 01.02	CS792	12 1.7
540 4.4 i Sport	[M62]	01.01- 01.03	CA1632IR	14 150 A35		01.01- 01.02	CS792	12 1.7
540 4.4 iT	[M62]	01.99- 01.00	CA1632IR	14 150 A35		01.99- 01.00	CS792	12 1.7
630 3.0 CSi	[M30]					01.77-	CS119	12 1.5
633 3.2 CSi	[M30]					01.78- 01.84	CS119	12 1.5
635 3.5 CSi	[M30]	01.78- 01.84 01.85- 01.86 01.87- 01.89	CA1991R CA2511R CA3621R	14 65 14 80 14 80		01.85- 01.89	CS119	12 1.5
733 3.2 i	[M30]	01.78- 01.84	CA1991R	14 65		01.78- 01.84	CS119	12 1.5
735 3.5 i	[M30]	01.85- 01.86 01.87- 01.92 01.87- 01.92	CA2511R CA5411R CA9021R	14 80 14 90 14 140		01.85- 01.92	CS119	12 1.5
735 3.5 iL	[M30]	01.88- 01.92 01.88- 01.92	CA5411R CA9021R	14 90 14 140		01.88- 01.92	CS515	12 1.7
740 4.0 i	[M60]	01.93- 01.94 01.95-	CA1245IR CA1207IR	14 140 14 140		01.93- 01.94	CS792	12 1.7
740 4.0 iL	[M60]	01.93- 01.95	CA1245IR	14 140		01.93- 01.95	CS792	12 1.7
740 4.4 i	[M62]	01.97- 01.98 01.99- 01.01	CA1207IR CA1632IR	14 140 14 150 A35		01.97- 01.01	CS792	12 1.7
740 4.4 iL	[M62]	01.96- 01.98 01.99- 01.01	CA1207IR CA1632IR	14 140 14 150 A35		01.96- 01.01	CS792	12 1.7
750 5.0 iL	[M70]	01.88- 01.94	CA1207IR	14 140				
750 5.4 iL	[M73]	01.95- 01.98 01.99- 01.01	CA1207IR CA1632IR	14 140 14 150 A35				
840 4.0 Ci	[M60]	01.94- 01.95	CA1245IR	14 140		01.94- 01.95	CS792	12 1.7
840 4.4 Ci	[M62]	01.96- 01.97	CA1207IR	14 140		01.96- 01.97	CS792	12 1.7
850 5.0 Ci	[M70]	01.93- 01.94	CA1207IR	14 140				
850 5.0 i	[M70]	01.91- 01.92	CA1207IR	14 140				
850 5.4 Ci	[M73]	01.95- 01.97	CA1207IR	14 140				
850 5.6 CSi	[S70]	01.94- 01.95	CA1207IR	14 140		01.66- 01.71	CS119	12 1.5
1800 1.8						01.71-	CS119	12 1.5
1802 1.8						01.66- 01.72	CS119	12 1.5
2000 2.0						01.68- 01.69	CS119	12 1.5
2000 2.0 C						01.68- 01.69	CS119	12 1.5
2000 2.0 CS						01.68- 01.71	CS119	12 1.5
2000 2.0 Ti						01.69- 01.72	CS119	12 1.5
2000 2.0 Ti i						01.68- 01.71	CS119	12 1.5
2000 2.0 Ti i Lux						01.66- 01.76	CS119	12 1.5
2002 2.0						01.68- 01.71	CS119	12 1.5
2002 2.0 Ti						01.71- 01.74	CS119	12 1.5
2002 2.0 Ti i						01.73- 01.74	CS119	12 1.5
2002 2.0 Turbo						01.68- 01.71	CS119	12 1.5
2500 2.5						01.68- 01.74	CS119	12 1.5
2800 2.8						01.68- 01.71	CS119	12 1.5
2800 2.8 CS						01.71-	CS119	12 1.5
2.8 2.8 Bavaria						01.72- 01.74	CS119	12 1.5
3.0 3.0 Bavaria						01.71- 01.74	CS119	12 1.5
3.0 3.0 CS						01.71- 01.74	CS119	12 1.5
3.0 3.0 CSi						01.71-	CS119	12 1.5
3.0 3.0 CSL						01.71- 01.74	CS119	12 1.5
3.0 3.0 S						01.71- 01.76	CS119	12 1.5
3.0 3.0 Si								
L6 3.5	[M30]	01.87- 01.87	CA3621R	14 80		01.87- 01.87	CS119	12 1.5
L7 3.5	[M30]	01.86-	CA3621R	14 80		01.86-	CS119	12 1.5
M3 2.3	[S14]	01.88- 01.91	CA5031R	14 90				
M3 3.0	[S50]	01.95- 01.95- 01.95-	CA1054IR CA1064IR CA1092IR	14 140 14 80 14 140				
M3 3.2	[S52]	01.96- 01.99 01.96- 01.99 01.96- 01.99	CA1054IR CA1064IR CA1092IR	14 140 14 80 14 140		01.96- 01.99	CS1067	12 1.4
M5 3.5	[S38]					01.88-	CS119	12 1.5
M5 3.6	[S38]					01.91- 01.93	CS515	12 1.7
M5 5.0	[S62]					01.00- 01.02	CS792	12 1.7
M6 3.5	[S38]					01.87- 01.88	CS119	12 1.5
X5 4.4	[M62]	01.00- 01.03	CA1632IR	14 150 A35		01.00- 01.03	CS792	12 1.7
X5 4.6 iS	[M62]	01.02- 01.03	CA1632IR	14 150 A35		01.03- 01.03	CS792	12 1.7
Z3 1.9	[M44]	01.96- 01.98 01.96- 01.98	CA1261IR CA1398IR	14 90 14 80		01.96- 01.98	CS1067	12 1.4
Z3 2.5	[M52] [M54]	01.99- 01.00 01.99- 01.99 01.01- 01.02	CA1256IR CA1591IR CA1591IR	14 90 14 120 14 120		01.99- 01.00	CS1067	12 1.4
Z3 2.8	[M52]	01.97- 01.00 01.98- 01.00	CA1256IR CA1591IR	14 90 14 120		01.97- 01.00	CS1067	12 1.4
Z3 3.0	[M54]	01.01- 01.02	CA1591IR	14 120		01.01- 01.02	CS1067	12 1.4



**BMW Continued**

Z3 3.2 M	[S52]	01.99- 01.00 01.99- 01.00 01.99- 01.00	CA1054IR CA1064IR CA1092IR	14 140 14 80 14 140	01.99- 01.00	CS1067	12 1.4
Z4 2.5	[M54]				01.03- 01.03	CS1067	12 1.4
Z4 3.0	[M54]				01.03- 01.03	CS1067	12 1.4
Z8 5.0	[S62]				01.01- 01.03	CS792	12 1.7
<b>PASSENGER CARS AO</b>							
318 1.8 i	(E30)[M40B18C]	06.88- 02.92	CA1041IR	14 90	06.88- 02.92	CS1067	12 1.4
330 3.0 i	(E92)[N52B30A]	08.06-	CA1953IR	14 180			
330 3.0 Xi	(E92)[N52B30A]	09.06-	CA1953IR	14 180			
728 2.8 iX	(E38)[M52B28]	11.95- 09.01 11.95- 09.01	CA1325IR CA1591IR	14 140 14 120	11.95- 09.01 09.98- 06.03	CS1067 CS792	12 1.4 12 1.7
M5 5.0	(E39)				01.88-	US845#	12 2.5
Z3 3.2		04.00- 04.01 08.00- 06.03	CA1332IR CA1982IR	14 105 14 120			
<b>Bobcat</b>							
<b>MISC</b>							
773		01.95-	JA787IR	14 55			
980		01.88-	JA787IR	14 55	01.88-	US845#	12 2.5
Various Models						JS1102	12 1.4
<b>Bosch</b>							
<b>MOTORS</b>							
DDOD 27 2.8	[F3L912]				04.82- 12.91 01.92- 01.99	CS114 CS887	12 2.4 12 3.1
DDOD 36 4.0	[F4L912]				04.82- 12.91 01.92- 01.99	CS114 CS887	12 2.4 12 3.1
DDOD 46 4.7	[F5L912]				04.82- 01.99	CS128	12 2.0
DDOD 57 5.7	[F6L912]				04.82- 01.99	CS128	12 2.0
<b>Bova</b>							
<b>TRUCKS EU</b>							
122 12.9	[MX300]	10.06- 10.06-	CA1917IR CA1939IR	28 80 28 110	10.06-	CS1420	24 5.5
130 12.9	[MX340]	07.07- 07.07-	CA1917IR CA1939IR	28 80 28 110	07.07-	CS1420	24 5.5
	[MX375]	07.07- 07.07-	CA1917IR CA1939IR	28 80 28 110	07.07-	CS1420	24 5.5
131 12.9	[MX340]	07.07- 07.07-	CA1917IR CA1939IR	28 80 28 110	07.07-	CS1420	24 5.5
141 12.9	[MX340]	07.07- 07.07-	CA1917IR CA1939IR	28 80 28 110	07.07-	CS1420	24 5.5
	[MX375]	07.07- 07.07-	CA1917IR CA1939IR	28 80 28 110	07.07-	CS1420	24 5.5
DD 130 12.6	[XE355C]	09.04-	CA1693IR	28 110	09.04-	CS1380	24 5.5
DD 138 12.6	[XE355C]	09.04-	CA1693IR	28 110	09.04-	CS1380	24 5.5
FHD 10 12.6	[XE250C]	09.01- 09.01-	CA1693IR CA1694IR	28 110 28 80	09.01- 09.01-	CS1380 CS1274	24 5.5 24 6.2
FHD 12 12.6	[XE250C]	09.01- 09.01-	CA1693IR CA1694IR	28 110 28 80	09.01- 09.01-	CS1274	24 6.2
FHD 13 12.6	[XE250C]	09.01- 09.01-	CA1693IR CA1694IR	28 110 28 80	09.01- 09.01-	CS1380 CS1274	24 5.5 24 6.2
FLD 12 12.6	[XE250C]	09.01- 09.01-	CA1693IR CA1694IR	28 110 28 80	09.01- 09.01-	CS1380 CS1274	24 5.5 24 6.2
FLD 13 12.6	[XE250C]	09.01- 09.01-	CA1693IR CA1694IR	28 110 28 80	09.01- 09.01-	CS1380 CS1274	24 5.5 24 6.2
HD 120 12.6	[XE250C]	10.99- 10.99-	CA1693IR CA1694IR	28 110 28 80	10.99- 10.99-	CS1274 CS1380	24 6.2 24 5.5
HD 122 12.6	[XE250C]	10.99- 10.99-	CA1693IR CA1694IR	28 110 28 80	10.99- 10.99-	CS1274 CS1380	24 6.2 24 5.5
<b>Briggs &amp; Stratton</b>							
<b>MOTORS</b>							
Various Models						US851	12
<b>Buick</b>							
<b>PASSENGER CARS EU</b>							
Century 5.7 Limited	[LF9]	01.82- 01.83 01.83- 01.86 01.87- 01.92	UA943IR UA945IR UA938IR	14 60 14 65 14 100			
Park Avenue 3.8	[L27]	01.91- 10.96	UA964IR	14 100			
Skylark 2.8	[LE2]	01.79- 12.82	UA943IR	14 60	04.79- 12.82	US810#	12
Skylark 3.3 V6	[LG7]	09.89- 01.91	UA947IR	14 60			
<b>PASSENGER CARS US</b>							
Apollo 4.1		01.73- 01.75	UA943IR	14 60	01.73- 01.75	US818	12 1.5
Apollo 4.1 SR		01.75- 01.75	UA943IR	14 60	01.75-	US818	12 1.5
Apollo 4.3		01.75-	UA943IR	14 60	01.75-	US818	12 1.5
Apollo 4.3 SR		01.75-	UA943IR	14 60	01.75-	US818	12 1.5
Apollo 5.7		01.73- 01.75	UA943IR	14 60	01.73- 01.75	US818	12 1.5
Apollo 5.7 SR		01.75- 01.75	UA943IR	14 60	01.75-	US818	12 1.5
Centurion 5.7		01.72- 01.73	UA943IR	14 60	01.72- 01.73	US818	12 1.5
Centurion 7.5		01.72- 01.73 01.71-	UA943IR UA916#	14 60 14 60	01.71- 01.73	US818	12 1.5
Century 2.2 Custom		01.93- 01.96	UA939IR	14 100			
Century 2.2 Limited		01.93-	UA939IR	14 100			
Century 2.2 Special		01.93- 01.96	UA939IR	14 100			
Century 2.5		01.84- 01.89 01.87- 01.89	UA943IR UA938IR	14 60 14 100	01.84- 01.89	US810#	12
Century 2.5 Custom		01.83- 01.86 01.87- 01.92	UA945IR UA938IR	14 65 14 100			
		01.82- 01.92	UA943IR	14 60			
Century 2.5 Limited		01.82- 01.92	UA943IR	14 60			
		01.83- 01.86	UA945IR	14 65			
		01.87- 01.92	UA938IR	14 100			
Century 2.5 Special		01.91- 01.92	UA938IR	14 100	01.91- 01.92	US810#	12
Century 2.8		01.85- 01.87- 01.88 01.87- 01.88	UA945IR UA1109IR UA938IR	14 65 14 105 14 100			
Century 2.8 Custom		01.83- 01.86 01.87- 01.89 01.87- 01.89	UA945IR UA938IR UA1109IR	14 65 14 100 14 105			
		01.83- 01.85	UA943IR	14 60			
Century 2.8 Limited		01.83- 01.86	UA945IR	14 65			
		01.83- 01.85	UA943IR	14 60			
		01.87- 01.89	UA938IR	14 100			
		01.87- 01.89	UA1109IR	14 105			
Century 3.0		01.84- 01.85	UA943IR	14 60	01.84- 01.85	US810#	12
Century 3.0 Custom		01.83- 01.85	UA945IR	14 65	01.82- 01.85	US810#	12
		01.82- 01.82	UA943IR	14 60			



Century 3.0 Limited	01.82- 01.82	UA943IR	14	60	01.82- 01.85	US810#	12
	01.83- 01.85	UA945IR	14	65			
Century 3.0 T-Type	01.83- 01.84	UA945IR	14	65	01.83- 01.84	US810#	12
	01.83- 01.84	UA943IR	14	60			
Century 3.2 Custom	01.78- 01.79	UA943IR	14	60	01.78- 01.79	US810#	12
						US818	12 1.5
Century 3.2 Limited	01.78- 01.79	UA943IR	14	60	01.78- 01.79	US818	12 1.5
Century 3.2 Special	01.78- 01.79	UA943IR	14	60	01.78- 01.79	US818	12 1.5
Century 3.2 Sport	01.78- 01.79	UA943IR	14	60	01.78- 01.79	US818	12 1.5
Century 3.3					01.89-	US810#	12
Century 3.3 Custom	01.91- 01.93	UA938IR	14	100	01.89- 01.93	US810#	12
Century 3.3 Limited	01.91- 01.93	UA938IR	14	100	01.89- 01.93	US810#	12
Century 3.3 Special	01.91- 01.93	UA938IR	14	100	01.91- 01.93	US810#	12
Century 3.8	01.75- 01.85	UA943IR	14	60	01.75- 01.81	US818	12 1.5
	01.86- 01.86	UA945IR	14	65	01.84- 01.88	US810#	12
	01.87- 01.88	UA938IR	14	100			
Century 3.8 Custom	01.75- 01.85	UA943IR	14	60	01.84- 01.88	US810#	12
	01.87- 01.88	UA938IR	14	100	01.75- 01.79	US818	12 1.5
Century 3.8 Limited	01.86- 01.86	UA945IR	14	65	01.78- 01.81	US818	12 1.5
	01.87- 01.88	UA938IR	14	100	01.84- 01.88	US810#	12
	01.78- 01.85	UA943IR	14	60			
Century 3.8 Special	01.75- 01.79	UA943IR	14	60	01.75- 01.79	US818	12 1.5
Century 3.8 Sport	01.78- 01.80	UA943IR	14	60	01.78- 01.80	US818	12 1.5
Century 3.8 T-Type	01.84- 01.86	UA945IR	14	65	01.84- 01.85	US810#	12
	01.84- 01.85	UA943IR	14	60			
Century 3.8 Turbo	01.80-	UA943IR	14	60	01.80-	US818	12 1.5
Century 3.8 Turbo Custom	01.79-	UA943IR	14	60	01.79-	US818	12 1.5
Century 3.8 Turbo Limited	01.79- 01.80	UA943IR	14	60	01.79- 01.80	US818	12 1.5
Century 3.8 Turbo Special	01.79-	UA943IR	14	60	01.79-	US818	12 1.5
Century 3.8 Turbo Sport	01.79- 01.80	UA943IR	14	60	01.79- 01.80	US818	12 1.5
Century 4.3	01.80- 01.81	UA943IR	14	60			
Century 4.3 Limited	01.80- 01.81	UA943IR	14	60			
Century 4.3	01.84- 01.85	UA943IR	14	60			
Century 4.3 Custom	01.82- 01.85	UA943IR	14	60			
	01.83- 01.85	UA945IR	14	65			
Century 4.3 Limited	01.84- 01.85	UA945IR	14	65			
	01.82- 01.82	UA943IR	14	60			
Century 4.4	01.81-	UA943IR	14	60			
Century 4.4 Limited	01.81-	UA943IR	14	60			
Century 4.9	01.80-	UA943IR	14	60			
Century 4.9 Custom	01.79-	UA943IR	14	60			
Century 4.9 Limited	01.79- 01.80	UA943IR	14	60			
Century 4.9 Special	01.79-	UA943IR	14	60			
Century 4.9 Sport	01.79- 01.80	UA943IR	14	60			
Century 5.0	01.77-	UA943IR	14	60			
Century 5.0 Custom	01.77- 01.79	UA943IR	14	60			
Century 5.0 Limited	01.78- 01.80	UA943IR	14	60			
Century 5.0 Special	01.78- 01.79	UA943IR	14	60			
Century 5.0 Sport	01.78-	UA943IR	14	60			
Century 5.7	01.73- 01.77	UA943IR	14	60	01.73- 01.77	US818	12 1.5
Century 5.7 Custom	01.75- 01.79	UA943IR	14	60	01.75- 01.77	US818	12 1.5
Century 5.7 Luxus	01.73- 01.74	UA943IR	14	60	01.73- 01.74	US818	12 1.5
Century 5.7 Special	01.79-	UA943IR	14	60			
Century 5.7	01.81-	UA943IR	14	60			
Century 5.7 Limited	01.81-	UA943IR	14	60			
Century 6.6 Custom	01.77-	UA943IR	14	60			
Century 7.5	01.73-	UA943IR	14	60	01.73-	US818	12 1.5
Century 7.5 Luxus	01.73-	UA943IR	14	60	01.73-	US818	12 1.5
Electra 3.0 300	01.85-	UA945IR	14	65	01.85-	US810#	12
Electra 3.8	01.86-	UA945IR	14	65	01.86-	US810#	12
Electra 3.8 300	01.85-	UA945IR	14	65	01.85-	US810#	12
Electra 3.8 Limited	01.87- 01.87	UA945IR	14	65	01.87- 01.90	US810#	12
	01.88- 01.90	UA964IR	14	100			
Electra 3.8 Park Avenue	01.85- 01.87	UA945IR	14	65	01.85- 01.90	US810#	12
	01.88- 01.90	UA964IR	14	100			
Electra 3.8 Park Avenue Ultra	01.90-	UA964IR	14	100	01.90-	US810#	12
Electra 3.8 T-Type	01.85-	UA945IR	14	65	01.85- 01.90	US810#	12
	01.88- 01.90	UA964IR	14	100			
Electra 3.8 Ultra	01.89-	UA964IR	14	100	01.89-	US810#	12
Electra 4.1 Limited	01.80- 01.84	UA943IR	14	60	01.80- 01.84	US818	12 1.5
Electra 4.1 Park Avenue	01.80- 01.84	UA943IR	14	60	01.80- 01.84	US818	12 1.5
Electra 4.3 300	01.85-	UA945IR	14	65			
	01.85-	UA943IR	14	60			
Electra 4.3 Park Avenue	01.85-	UA945IR	14	65			
	01.85-	UA943IR	14	60			
Electra 4.9	01.80-	UA943IR	14	60			
Electra 5.0	01.81- 01.83	UA943IR	14	60			
	01.84- 01.89	UA945IR	14	65			
Electra 5.0 Limited	01.81- 01.83	UA943IR	14	60			
	01.84-	UA945IR	14	65			
Electra 5.0 Park Avenue	01.81- 01.83	UA943IR	14	60			
	01.84-	UA945IR	14	65			
Electra 5.7	01.80-	UA943IR	14	60	01.80-	US818	12 1.5
Electra 5.7 225	01.76- 01.79	UA943IR	14	60	01.76- 01.79	US818	12 1.5
Electra 5.7 225 Limited	01.77-	UA943IR	14	60	01.77-	US818	12 1.5
Electra 5.7 Limited	01.78- 01.80	UA943IR	14	60	01.78- 01.80	US818	12 1.5
Electra 5.7 Park Avenue	01.78- 01.80	UA943IR	14	60	01.78- 01.80	US818	12 1.5
Electra 5.7	01.84- 01.85	UA945IR	14	65			
	01.80- 01.83	UA943IR	14	60			
Electra 5.7 Limited	01.80- 01.83	UA943IR	14	60			
Electra 5.7 Park Avenue	01.83-	UA945IR	14	65			
	01.80- 01.82	UA943IR	14	60			
Electra 6.6	01.62- 01.66	UA916#	14	60			
Electra 6.6 225	01.77- 01.79	UA943IR	14	60			
Electra 6.6 225 Limited	01.77-	UA943IR	14	60			
Electra 6.6 Limited	01.78- 01.79	UA943IR	14	60			
Electra 6.6 Park Avenue	01.78- 01.79	UA943IR	14	60			
Electra 7.0	01.65- 01.67	UA916#	14	60	01.67- 01.67	US818	12 1.5
Electra 7.0 225	01.68- 01.69	UA916#	14	60	01.68- 01.69	US818	12 1.5
Electra 7.0 225 Custom	01.68- 01.69	UA916#	14	60	01.68- 01.69	US818	12 1.5
Electra 7.5	01.73- 01.73	UA943IR	14	60	01.73- 01.73	US818	12 1.5



### BUICK Continued

Electra 7.5 225	01.72- 01.74	UA943IR	14 60				01.70- 01.74	US818	12 1.5
	01.70- 01.71	UA916#	14 60						
Electra 7.5 225 Custom	01.72- 01.75	UA943IR	14 60				01.70- 01.75	US818	12 1.5
	01.70- 01.71	UA916#	14 60						
Electra 7.5 225 Limited	01.74- 01.75	UA943IR	14 60				01.74- 01.75	US818	12 1.5
Estate Wagon 5.7	01.72- 01.79	UA943IR	14 60				01.70- 01.79	US818	12 1.5
	01.70-	UA916#	14 60						
Estate Wagon 6.6	01.77- 01.79	UA943IR	14 60						
Estate Wagon 7.5	01.72- 01.75	UA943IR	14 60				01.70- 01.75	US818	12 1.5
	01.70- 01.71	UA916#	14 60						
Gran Fury 5.6	01.67- 01.67	UA916#	14 60				01.67- 01.67	US818	12 1.5
Gran Fury 6.6	01.65- 01.67	UA916#	14 60				01.65- 01.67	US818	12 1.5
GS 5.7	01.72- 01.72	UA943IR	14 60				01.70- 01.72	US818	12 1.5
	01.70- 01.71	UA916#	14 60						
GS 350 5.7	01.68- 01.69	UA916#	14 60				01.68- 01.69	US818	12 1.5
GS 400 6.6	01.68- 01.69	UA916#	14 60				01.68- 01.69	US818	12 1.5
GS 455 7.5	01.70- 01.72	UA916#	14 60				01.70- 01.72	US818	12 1.5
Invicta 6.6	01.62- 01.63	UA916#	14 60						
Lesabre 3.0 Custom							01.86-	US810#	12
Lesabre 3.0 Limited							01.86-	US810#	12
Lesabre 3.8	01.76- 01.81	UA943IR	14 60				01.76- 01.81	US818	12 1.5
	01.87- 01.87	UA945IR	14 65				01.87- 01.91	US810#	12
	01.88- 01.91	UA964IR	14 100						
Lesabre 3.8 Custom	01.77- 01.85	UA943IR	14 60				01.86- 01.95	US810#	12
	01.88- 01.94	UA964IR	14 100				01.77- 01.85	US818	12 1.5
	01.82- 01.87	UA945IR	14 65						
Lesabre 3.8 Limited	01.88- 01.94	UA964IR	14 100				01.86- 01.95	US810#	12
	01.83- 01.87	UA945IR	14 65				01.79- 01.85	US818	12 1.5
	01.79- 01.85	UA943IR	14 60						
Lesabre 3.8 Turbo Sport	01.78- 01.80	UA943IR	14 60				01.78- 01.80	US818	12 1.5
Lesabre 4.1	01.80- 01.81	UA943IR	14 60				01.80- 01.81	US818	12 1.5
Lesabre 4.1 Custom	01.83- 01.84	UA945IR	14 65				01.82- 01.84	US818	12 1.5
	01.82- 01.84	UA943IR	14 60						
Lesabre 4.1 Limited	01.83- 01.84	UA945IR	14 65				01.80- 01.84	US818	12 1.5
Lesabre 4.9	01.80- 01.84	UA943IR	14 60						
	01.65- 01.65	UA916#	14 60				01.65- 01.79	US818	12 1.5
Lesabre 4.9 Custom	01.77- 01.79	UA943IR	14 60						
	01.77- 01.78	UA943IR	14 60				01.77- 01.78	US818	12 1.5
Lesabre 4.9 Limited	01.79-	UA943IR	14 60						
Lesabre 5.0	01.83- 01.90	UA945IR	14 65						
	01.78- 01.83	UA943IR	14 60						
Lesabre 5.0 Custom	01.83- 01.85	UA945IR	14 65						
	01.78- 01.83	UA943IR	14 60						
Lesabre 5.0 Limited	01.83- 01.85	UA945IR	14 65						
	01.81- 01.83	UA943IR	14 60						
Lesabre 5.6	01.66- 01.67	UA916#	14 60				01.66- 01.67	US818	12 1.5
Lesabre 5.7	01.72- 01.80	UA943IR	14 60				01.68- 01.80	US818	12 1.5
	01.68- 01.71	UA916#	14 60						
Lesabre 5.7 Custom	01.68- 01.71	UA916#	14 60				01.68- 01.78	US818	12 1.5
	01.72- 01.78	UA943IR	14 60						
Lesabre 5.7 Limited	01.79- 01.80	UA943IR	14 60				01.79- 01.80	US818	12 1.5
Lesabre 5.7 Luxus	01.74-	UA943IR	14 60				01.74-	US818	12 1.5
Lesabre 5.7	01.80- 01.83	UA943IR	14 60						
Lesabre 5.7 Custom	01.83- 01.83	UA945IR	14 65						
	01.82- 01.83	UA943IR	14 60						
Lesabre 5.7 Limited	01.83- 01.85	UA945IR	14 65						
	01.80- 01.83	UA943IR	14 60						
Lesabre 6.6	01.63- 01.64	UA916#	14 60						
Lesabre 6.6 Custom	01.77- 01.78	UA943IR	14 60						
	01.75-	UA916#	14 60						
Lesabre 7.0	01.64- 01.64	UA916#	14 60						
Lesabre 7.5	01.70- 01.71	UA916#	14 60				01.70- 01.75	US818	12 1.5
	01.72- 01.75	UA943IR	14 60						
Lesabre 7.5 Custom	01.72- 01.75	UA943IR	14 60				01.70- 01.75	US818	12 1.5
	01.70- 01.71	UA916#	14 60						
Lesabre 7.5 Luxus	01.74-	UA943IR	14 60				01.74-	US818	12 1.5
Opel 1.8	01.77- 01.79	JA144	14 45						
Park Avenue 3.8	01.91- 01.94	UA964IR	14 100				01.91- 01.94	US810#	12
Park Avenue 3.8 Ultra	01.91- 01.91	UA964IR	14 100				01.91-	US810#	12
Park Avenue 3.8 Super Ultra	01.91- 01.94	UA964IR	14 100						
Reatta 3.8							01.91-	US810#	12
Regal 2.8 Custom	01.88- 01.89	UA1113IR	14 100						
Regal 2.8 Limited	01.88- 01.89	UA1113IR	14 100						
Regal 3.1 Custom	01.89- 01.93	UA1113IR	14 100						
Regal 3.1 Limited	01.89- 01.93	UA1113IR	14 100						
Regal 3.2	01.78- 01.79	UA943IR	14 60				01.78- 01.79	US818	12 1.5
Regal 3.2 Limited	01.78- 01.79	UA943IR	14 60				01.78- 01.79	US818	12 1.5
Regal 3.8	01.83- 01.87	UA945IR	14 65				01.75- 01.87	US818	12 1.5
	01.75- 01.83	UA943IR	14 60						
Regal 3.8 Custom	01.90- 01.95	UA964IR	14 100				01.90- 01.95	US810#	12
Regal 3.8 Gran Sport	01.92- 01.95	UA964IR	14 100				01.92- 01.95	US810#	12
Regal 3.8 Limited	01.78- 01.87	UA943IR	14 60				01.78- 01.87	US818	12 1.5
	01.90- 01.95	UA964IR	14 100				01.90- 01.95	US810#	12
Regal 3.8 Turbo Grand National	01.84- 01.85	UA945IR	14 65				01.84- 01.87	US818	12 1.5
Regal 3.8 Turbo Limited	01.87- 01.87	UA945IR	14 65				01.87-	US818	12 1.5
Regal 3.8 Turbo Sport	01.78- 01.82	UA943IR	14 60				01.78- 01.82	US818	12 1.5
Regal 3.8 Turbo T-Type	01.83- 01.83	UA943IR	14 60				01.83- 01.85	US818	12 1.5
	01.83- 01.83	UA945IR	14 65						
Regal 4.1	01.83- 01.84	UA945IR	14 65				01.82- 01.84	US818	12 1.5
	01.82- 01.84	UA943IR	14 60						
Regal 4.1 Limited	01.82- 01.84	UA945IR	14 65				01.82- 01.84	US818	12 1.5
	01.82- 01.84	UA943IR	14 60						
Regal 4.3	01.80- 01.81	UA943IR	14 60						
Regal 4.3 Limited	01.80- 01.81	UA943IR	14 60						
Regal 4.3	01.82- 01.83	UA943IR	14 60						
	01.84- 01.84	UA945IR	14 65						
Regal 4.3 Limited	01.83- 01.84	UA945IR	14 65						
Regal 4.4	01.82- 01.82	UA943IR	14 60						
	AC 01.82- 01.82	UA943IR	14 60						
	01.82- 01.82	UA945IR	14 65						



Regal 4.4 Limited	AC 01.82- 01.82	UA943IR	14	60			
	01.82- 01.82	UA943IR	14	60			
	01.82- 01.82	UA945IR	14	65			
Regal 4.9	01.79- 01.80	UA943IR	14	60			
Regal 4.9 Limited	01.79- 01.80	UA943IR	14	60			
Regal 5.0	01.77- 01.83	UA943IR	14	60			
	01.83- 01.87	UA945IR	14	65			
	AC 01.83- 01.83	UA945IR	14	65			
Regal 5.0 Limited	01.83- 01.87	UA945IR	14	65			
	AC 01.83- 01.83	UA945IR	14	65			
	01.78- 01.83	UA943IR	14	60			
	01.73- 01.76	UA943IR	14	60		01.73- 01.76	US818 12 1.5
Regal 5.7	01.83- 01.85	UA945IR	14	65			
	01.81- 01.83	UA943IR	14	60			
	01.83- 01.83	UA945IR	14	65			
Regal 5.7 Limited	01.81- 01.82	UA943IR	14	60			
	01.73- 01.74	UA943IR	14	60		01.73- 01.74	US818 12 1.5
	01.88- 01.93	US810#	12				
Riviera 3.8	01.80-	UA943IR	14	60			
Riviera 3.8 Turbo	01.79- 01.80	UA943IR	14	60			
Riviera 3.8 Turbo S	01.83- 01.83	UA945IR	14	65			
Riviera 3.8 Turbo T-Type	01.83- 01.85	UA945IR	14	65			
Riviera 5.0	01.77- 01.80	UA943IR	14	60		01.77- 01.80	US818 12 1.5
Riviera 5.7	01.79- 01.80	UA943IR	14	60			
Riviera 5.7 S	01.83- 01.85	UA945IR	14	65			
Riviera 5.7	01.63- 01.65	UA916#	14	60			
Riviera 6.6	01.77- 01.78	UA943IR	14	60			
Riviera 7.0	01.63- 01.69	UA916#	14	60		01.67- 01.69	US818 12 1.5
Riviera 7.5	01.70- 01.74	UA943IR	14	60		01.70- 01.74	US818 12 1.5
Roadmaster 5.0	01.91- 01.92	UA939IR	14	100			
Roadmaster 5.7	01.92- 01.93	UA939IR	14	100			
Roadmaster 5.7 Limited	01.92- 01.93	UA939IR	14	100			
Skyhawk 1.8 Custom	01.83- 01.86	UA945IR	14	65			
	01.82- 01.82	UA943IR	14	60			
	01.83- 01.86	UA945IR	14	65			
Skyhawk 1.8 Limited	01.82- 01.82	UA943IR	14	60			
	01.86- 01.86	UA945IR	14	65			
	01.83- 01.86	UA945IR	14	65			
Skyhawk 1.8 Sport	01.84- 01.84	UA945IR	14	65			
Skyhawk 1.8 T-Type	01.84- 01.86	UA945IR	14	65			
Skyhawk 1.8 Turbo Custom	01.88- 01.89	UA947IR	14	60			
Skyhawk 1.8 Turbo T-Type	01.83- 01.86	UA943IR	14	60			
Skyhawk 2.0	01.83- 01.86	UA943IR	14	60			
Skyhawk 2.0 Custom	01.83- 01.86	UA943IR	14	60			
Skyhawk 2.0 Limited	01.86- 01.86	UA945IR	14	65			
Skyhawk 2.0 Sport	01.83- 01.86	UA943IR	14	60			
Skyhawk 2.0 Turbo Custom	01.75- 01.80	UA943IR	14	60		01.75- 01.80	US818 12 1.5
Skyhawk 2.0 Turbo Limited	01.76- 01.80	UA943IR	14	60		01.76- 01.80	US818 12 1.5
Skyhawk 2.0 Turbo Sport	01.91- 01.92	UA938IR	14	100			
Skyhawk 3.8	01.88- 01.95	UA938IR	14	100			
Skyhawk 3.8 S	01.90- 01.95	UA938IR	14	100			
Skyhawk 3.8 S	01.88- 01.95	UA938IR	14	100			
Skyhawk 3.8 S	01.90- 01.91	UA938IR	14	100			
Skyhawk 3.8 S	01.90- 01.91	UA953IR#	14	100		01.80- 01.82	US810# 12
Skyhawk 3.8 S	01.82- 01.82	UA945IR	14	65			
Skyhawk 3.8 S	01.80- 01.82	UA943IR	14	60			
Skyhawk 3.8 Custom	01.83- 01.85	UA943IR	14	60		01.83- 01.85	US810# 12
	01.83- 01.85	UA945IR	14	65			
	01.88- 01.91	UA953IR#	14	100			
	01.90- 01.91	UA953IR#	14	100			
Skyhawk 3.8 Custom	01.88- 01.89	UA953IR#	14	100		01.80- 01.85	US810# 12
Skyhawk 3.8 Limited	01.80- 01.85	UA943IR	14	60			
	01.82- 01.85	UA945IR	14	65			
	01.90- 01.91	UA953IR#	14	100			
	01.80- 01.82	UA943IR	14	60		01.80- 01.82	US810# 12
Skyhawk 3.8 Limited	01.82- 01.82	UA945IR	14	65			
Skyhawk 3.8 Limited	01.80- 01.82	UA943IR	14	60		01.80- 01.82	US810# 12
Skyhawk 3.8 Limited	01.83- 01.85	UA943IR	14	60		01.83- 01.85	US810# 12
Skyhawk 3.8 Custom	01.83- 01.85	UA945IR	14	65			
	01.83- 01.85	UA945IR	14	65			
	AC 01.83- 01.85	UA945IR	14	65			
Skyhawk 3.8 Limited	01.80- 01.85	UA943IR	14	60		01.80- 01.85	US810# 12
	01.85- 01.85	UA945IR	14	65			
	AC 01.83- 01.84	UA945IR	14	65			
	01.80- 01.82	UA943IR	14	60		01.80- 01.82	US810# 12
Skyhawk 3.8 Limited	01.83- 01.84	UA943IR	14	60		01.83- 01.84	US810# 12
Skyhawk 3.8 Limited	01.83- 01.84	UA945IR	14	65			
Skyhawk 3.0 Custom	01.86- 01.88	US810#	12				
Skyhawk 3.0 Limited	01.86- 01.88	US810#	12				
Skyhawk 3.2	01.62- 01.63	UA916#	14	60			
Skyhawk 3.3	01.91- 01.91	UA947IR	14	60		01.91- 01.92	US810# 12
Skyhawk 3.3 Custom	01.89- 01.89	UA947IR	14	60		01.89- 01.93	US810# 12
Skyhawk 3.3 Gran Sport	01.90- 01.93	US810#	12				
Skyhawk 3.3 Limited	01.89- 01.91	UA947IR	14	60		01.89- 01.93	US810# 12
Skyhawk 3.3 Limited	01.90- 01.91	UA947IR	14	60		01.90- 01.91	US810# 12
Skyhawk 3.3 Luxury Edition	01.61- 01.63	UA916#	14	60			
Skyhawk 3.5	01.64- 01.67	UA916#	14	60		01.64- 01.67	US818 12 1.5
Skyhawk 3.7	01.75- 01.79	UA943IR	14	60		01.75- 01.79	US818 12 1.5
Skyhawk 3.8	01.78- 01.79	UA945IR	14	65			
	01.78- 01.79	UA943IR	14	60		01.78- 01.79	US818 12 1.5
	01.78- 01.79	UA945IR	14	65			
Skyhawk 3.8 Custom	01.78- 01.79	UA943IR	14	60		01.78- 01.79	US818 12 1.5
Skyhawk 3.8 S	01.78- 01.79	UA945IR	14	65			
Skyhawk 3.8 S	01.75- 01.79	UA943IR	14	60		01.75- 01.79	US818 12 1.5
Skyhawk 3.8 SR	01.75- 01.77	UA945IR	14	65		01.75- 01.77	US818 12 1.5
Skyhawk 3.8 SR	01.75- 01.77	UA943IR	14	60			
Skyhawk 4.1	01.68- 01.71	UA916#	14	60		01.68- 01.71	US818 12 1.5
Skyhawk 4.3	01.75- 01.76	UA943IR	14	60		01.75- 01.76	US818 12 1.5
	01.75- 01.76	UA945IR	14	65			



**BUICK Continued**

Skyllark 4.3 S	01.76- 01.76	UA943IR	14 60	01.76-	US818	12 1.5
	01.76- 01.76	UA945IR	14 65			
Skyllark 4.3 SR	01.75- 01.76	UA943IR	14 60	01.75- 01.76	US818	12 1.5
	01.75- 01.76	UA945IR	14 65			
Skyllark 4.9	01.64- 01.67	UA916#	14 60	01.64- 01.67	US818	12 1.5
	01.77- 01.77	UA943IR	14 60			
	01.77- 01.77	UA945IR	14 65			
Skyllark 4.9 S	01.77-	UA943IR	14 60	01.77-	US818	12 1.5
Skyllark 4.9 SR	01.77- 01.77	UA945IR	14 65	01.77-	US818	12 1.5
	01.77- 01.77	UA943IR	14 60			
Skyllark 5.0	01.77- 01.79	UA943IR	14 60			
	01.77- 01.79	UA945IR	14 65			
Skyllark 5.0 Custom	01.78- 01.79	UA943IR	14 60			
	01.78- 01.79	UA945IR	14 65			
Skyllark 5.0 S	01.77- 01.80	UA943IR	14 60			
	01.77- 01.80	UA945IR	14 65			
Skyllark 5.0 SR	01.77- 01.77	UA943IR	14 60			
	01.77- 01.77	UA945IR	14 65			
Skyllark 5.6	01.66- 01.67	UA916#	14 60	01.66- 01.67	US818	12 1.5
Skyllark 5.7	01.68- 01.71	UA916#	14 60	01.68- 01.76	US818	12 1.5
	01.72- 01.79	UA943IR	14 60			
	01.72- 01.79	UA945IR	14 65			
Skyllark 5.7 Custom	01.68- 01.71	UA916#	14 60	01.68- 01.71	US818	12 1.5
	01.72- 01.79	UA943IR	14 60			
	01.78- 01.79	UA945IR	14 65			
Skyllark 5.7 S	01.76- 01.77	UA943IR	14 60	01.76-	US818	12 1.5
	01.76- 01.76	UA945IR	14 65			
Skyllark 5.7 SR	01.75- 01.77	UA945IR	14 65	01.75- 01.76	US818	12 1.5
	01.75- 01.77	UA943IR	14 60			
Skyllark 6.6	01.65- 01.67	UA916#	14 60	01.65- 01.67	US818	12 1.5
Skyllark 6.6 Custom	01.68-	UA916#	14 60	01.68-	US818	12 1.5
Skyllark 7.5	01.72-	UA943IR	14 60	01.72-	US818	12 1.5
Skyllark 7.5 Custom	01.70- 01.70	UA916#	14 60	01.70-	US818	12 1.5
	01.72- 01.72	UA943IR	14 60			
Somerset 2.5 Regal	01.85- 01.85	UA943IR	14 60			
	01.85- 01.85	UA945IR	14 65			
Somerset 2.5 Regal Limited	01.85- 01.85	UA945IR	14 65			
	01.85- 01.85	UA943IR	14 60			
Somerset 3.0	01.86- 01.86	UA943IR	14 60	01.86- 01.87	US810#	12
Somerset 3.0 Limited	01.86- 01.86	UA943IR	14 60	01.86-	US810#	12
Somerset 3.0 Regal	01.85- 01.85	UA943IR	14 60	01.85-	US810#	12
Somerset 3.0 Regal Limited	01.85- 01.85	UA943IR	14 60	01.85-	US810#	12
	01.85- 01.85	UA945IR	14 65			
Somerset 3.0 T-Type				01.86-	US810#	12
Special 3.2	01.63- 01.63	UA916#	14 60			
Special 3.5	01.62- 01.63	UA916#	14 60			
Special 3.7	01.64- 01.67	UA916#	14 60	01.64- 01.67	US818	12 1.5
Special 4.1	01.68- 01.69	UA916#	14 60	01.68- 01.69	US818	12 1.5
Special 4.9	01.64- 01.67	UA916#	14 60	01.64- 01.67	US818	12 1.5
Special 5.7	01.68- 01.69	UA916#	14 60	01.68- 01.69	US818	12 1.5
Sportwagon 3.7	01.64- 01.65	UA916#	14 60	01.64- 01.65	US818	12 1.5
Sportwagon 4.9	01.64- 01.65	UA916#	14 60	01.64- 01.65	US818	12 1.5
Sportwagon 5.6	01.67- 01.67	UA916#	14 60	01.66- 01.67	US818	12 1.5
Sportwagon 5.7	01.72-	UA943IR	14 60	01.68- 01.71	US818	12 1.5
	01.68- 01.71	UA916#	14 60			
Sportwagon 6.6	01.68- 01.68	UA916#	14 60	01.68- 01.68	US818	12 1.5
Sportwagon 7.5	01.70-	UA916#	14 60	01.70-	US818	12 1.5
Wildcat 6.6	01.63- 01.66	UA916#	14 60			
Wildcat 7.0	01.64- 01.69	UA916#	14 60	01.64- 01.69	US818	12 1.5
Wildcat 7.0 Custom	01.68- 01.69	UA916#	14 60	01.68- 01.69	US818	12 1.5
Wildcat 7.5 Custom	01.70-	UA916#	14 60	01.70-	US818	12 1.5

**Cadillac**

<b>PASSENGER CARS EU</b>						
BLS 1.9 Diesel	[Z19DTH]	04.06-	CA1952IR	14 130	04.06- AT 04.06-	CS1428 CS1264
						12 1.7 12 1.7
<b>PASSENGER CARS US</b>						
Escalade 5.8	[LO5]	10.98-	UA1538IR	14 105		
Calais 7.0		01.65- 01.67	UA916#	14 60	01.65- 01.67	US818
Calais 7.7		01.72- 01.74	UA943IR	14 60	01.68- 01.74	US818
		01.68- 01.71	UA916#	14 60		
Calais 8.2		01.75- 01.76	UA943IR	14 60	01.75- 01.76	US818
Catera 3.0		01.97- 01.01	CA1507IR	14 120	01.97- 01.01	CS982
Deville 4.1		01.80- 01.81	UA943IR	14 60	01.80- 01.81	US818
		01.80- 01.84	UA938IR	14 100		
Deville 4.3		01.85-	UA943IR	14 60		
Deville 5.4		01.53- 01.55	UA943IR	14 60		
Deville 6.0		01.56- 01.58	UA943IR	14 60	01.80-	US818
		01.80-	UA938IR	14 100		
Deville 6.4		01.59- 01.60	UA943IR	14 60		
		01.61- 01.63	UA916#	14 60		
Deville 7.0		01.64- 01.67	UA916#	14 60	01.65- 01.79	US818
		01.77- 01.79	UA943IR	14 60		
Deville 7.7		01.68- 01.71	UA916#	14 60	01.68- 01.74	US818
		01.72- 01.74	UA943IR	14 60		
Deville 8.2		01.74- 01.76	UA943IR	14 60	01.74- 01.76	US818
Eldorado 4.1		01.82- 01.85	UA938IR	14 100		
		01.82- 01.85	UA945IR	14 65		
Eldorado 4.1 Biarritz		01.84- 01.85	UA938IR	14 100		
		01.84- 01.85	UA945IR	14 65		
Eldorado 5.4		01.53- 01.55	UA943IR	14 60		
Eldorado 5.7		01.80-	UA938IR	14 100		
Eldorado 6.0		01.56- 01.58	UA943IR	14 60		
Eldorado 6.4		01.59- 01.60	UA943IR	14 60		
		01.61- 01.63	UA916#	14 60		
Eldorado 7.0		01.77- 01.78	UA943IR	14 60		
		01.64- 01.67	UA916#	14 60		
Eldorado 7.7		01.68- 01.69	UA916#	14 60		
Eldorado 8.2		01.72- 01.76	UA943IR	14 60		
		01.70- 01.71	UA916#	14 60		
Fleetwood 4.1		01.85-	UA938IR	14 100		
Fleetwood 4.1 Brougham		01.80- 01.85	UA938IR	14 100	01.80- 01.81	US818
		01.80- 01.81	UA943IR	14 60		
Fleetwood 4.3		01.85-	UA943IR	14 60		
Fleetwood 5.7 Brougham						





Fleetwood 6.0		01.80- 01.84	UA938IR	14 100		01.80- 01.84	US818	12 1.5
		01.80-	UA943IR	14 60				
Fleetwood 6.0 Brougham		01.80-	UA938IR	14 100		01.80-	US818	12 1.5
		01.80-	UA943IR	14 60				
Fleetwood 6.0 Formal		01.80- 01.84	UA938IR	14 100		01.80- 01.84	US818	12 1.5
		01.80-	UA943IR	14 60				
Fleetwood 7.0		01.77- 01.79	UA943IR	14 60		01.65- 01.79	US818	12 1.5
		01.65- 01.67	UA916#	14 60				
Fleetwood 7.0 Brougham		01.77- 01.79	UA943IR	14 60		01.77- 01.79	US818	12 1.5
Fleetwood 7.0 Formal		01.77- 01.79	UA943IR	14 60		01.77- 01.79	US818	12 1.5
Fleetwood 7.7		01.72- 01.74	UA943IR	14 60		01.68- 01.74	US818	12 1.5
		01.68- 01.71	UA916#	14 60				
Fleetwood 7.7 60 Special		01.72- 01.74	UA943IR	14 60		01.68- 01.74	US818	12 1.5
		01.68- 01.71	UA916#	14 60				
Fleetwood 7.7 75		01.72- 01.74	UA943IR	14 60		01.68- 01.74	US818	12 1.5
		01.68- 01.71	UA916#	14 60				
Fleetwood 7.7 Brougham		01.68- 01.70	UA916#	14 60		01.68- 01.70	US818	12 1.5
Fleetwood 8.2		01.76- 01.76	UA943IR	14 60		01.78- 01.76	US818	12 1.5
Fleetwood 8.2 60 Special		01.75- 01.76	UA943IR	14 60		01.75- 01.76	US818	12 1.5
Fleetwood 8.2 75		01.75- 01.76	UA943IR	14 60		01.75- 01.76	US818	12 1.5
Series 60 5.4 Fleetwood		01.53- 01.55	UA943IR	14 60				
Series 60 6.0 Fleetwood		01.56- 01.58	UA943IR	14 60				
Series 60 6.4 Fleetwood		01.61- 01.63	UA916#	14 60				
		01.59- 01.60	UA943IR	14 60				
Series 60 7.0 Fleetwood		01.64- 01.64	UA916#	14 60				
Series 62 4.1		01.55- 01.55	UA943IR	14 60				
Series 62 5.4		01.53- 01.55	UA943IR	14 60				
Series 62 6.0		01.56- 01.58	UA943IR	14 60				
Series 62 6.4		01.59- 01.60	UA943IR	14 60				
		01.61- 01.63	UA916#	14 60				
Series 62 7.0		01.64- 01.64	UA916#	14 60				
Series 70 6.0 Fleetwood Eldorado		01.58- 01.58	UA943IR	14 60				
Series 75 5.4 Fleetwood		01.53- 01.55	UA943IR	14 60				
Series 75 6.0 Fleetwood		01.56- 01.58	UA943IR	14 60				
Series 75 6.4 Fleetwood		01.61- 01.63	UA916#	14 60				
		01.59- 01.60	UA943IR	14 60				
Series 75 7.0 Fleetwood		01.64- 01.64	UA916#	14 60				
Seville 4.1		01.82- 01.85	UA938IR	14 100				
Seville 5.7		01.80-	UA938IR	14 100		01.76- 01.77	US818	12 1.5
Seville 5.7		01.78- 01.85	UA943IR	14 60				
<b>Case</b>								
<b>AGRICULTURE</b>								
110	[Cummins 6BT]	05.97-	CA1197IR	14 65				
		05.97-	CA1198IR	14 95				
120	[Cummins 6BT]	05.97-	CA1197IR	14 65				
		05.97-	CA1198IR	14 95				
135	[Cummins 6BT]	05.97-	CA1197IR	14 65				
		05.97-	CA1198IR	14 95				
321		01.86-	CA76IR	14 33				
		10.76- 06.86	CA76	14 28				
421		01.86-	CA76IR	14 33				
		10.76- 06.86	CA76	14 28				
433		02.77-	CA616IR	14 32		01.86-	CS511	12 2.7
450 C		01.89- 01.94	CA1197IR	14 65				
		01.89- 01.94	CA1198IR	14 95				
454		01.72-	CA17h	14 34		01.72-	CS106	12 2.8
		01.82-	CA18h	14 43				
455		01.89- 01.94	CA1197IR	14 65				
		01.89- 01.94	CA1198IR	14 95				
475		01.82-	CA18h	14 43				
480 CK		01.89- 01.94	CA1197IR	14 65				
		01.89- 01.94	CA1198IR	14 95				
484		01.82-	CA18h	14 43				
485		01.82-	CA18h	14 43				
485		01.89- 01.93	UA945IR	14 65				
531		01.86-	CA76IR	14 33				
		10.76- 06.86	CA76	14 28				
533		02.77-	CA616IR	14 32		01.86-	CS511	12 2.7
540		01.88-	CA616IR	14 32				
554		01.86-	CA76IR	14 33				
		10.76- 06.86	CA76	14 28				
574		01.72-	CA17h	14 34		01.72-	CS106	12 2.8
		01.82-	CA18h	14 43				
580		01.89- 01.94	CA1197IR	14 65		01.82- 01.94	CS705	12 2.0
		01.89- 01.94	CA1198IR	14 95				
584		01.82-	CA18h	14 43				
585		01.82-	CA18h	14 43				
644		10.76- 06.86	CA76	14 28				
		01.86-	CA76IR	14 33				
674		01.72-	CA17h	14 34		01.72-	CS106	12 2.8
		01.82-	CA18h	14 43				
684		01.82-	CA18h	14 43				
685		01.82-	CA18h	14 43				
784		01.82-	CA18h	14 43		01.82-	CS106	12 2.8
785		01.82-	CA18h	14 43		01.82-	CS106	12 2.8
833		09.81-	CA616IR	14 32		09.81-	CS511	12 2.7
833 A		09.81-	CA616IR	14 32		09.81-	CS511	12 2.7
844		01.74- 01.86	CA76	14 28		01.86- 12.90	CS503	12 2.7
		01.86- 12.90	CA76IR	14 33				
850		01.89- 01.94	CA1197IR	14 65				
		01.89- 01.94	CA1198IR	14 95				
885		01.89- 01.94	CA1197IR	14 65				
956 XL		01.85-	CA339IR	14 55				
1150		01.89- 01.94	CA1198IR	14 95				
		01.89- 01.94	CA1197IR	14 65				
1150 E		01.89- 01.94	CA1197IR	14 65				
		01.89- 01.94	CA1198IR	14 95				
1155 E		01.89- 01.94	CA1197IR	14 65				
		01.89- 01.94	CA1198IR	14 95				
1190		01.83-	CA18h	14 43				
1294 3.6		01.84- 06.89	CA18h	14 43		01.84- 06.89	CS987#	12 2.8
1394		01.84-	CA18h	14 43				
		01.84-	CA312IR	14 60				
1490		01.84-	CA18h	14 43		01.80-	CS705	12 2.0



**CASE** *Continued*

1494		01.84-	CA18h	14	43			
		01.84-	CA312IR	14	60			
1550		01.89- 01.94	CA1197IR	14	65			
		01.89- 01.94	CA1198IR	14	95			
1594		01.84-	CA312IR	14	60			
1690		01.84-	CA18h	14	43	01.80-	CS705	12 2.0
1694		01.84-	CA312IR	14	60			
4200		01.93-	CA126IR	14	45			
5120 Maxxum	[6T-590]	01.90-	CA1197IR	14	65			
		01.90-	CA1198IR	14	95			
5130	[6T-590]					06.90-	CS1069	12 3.1
5130 Maxxum	[6T-590]	01.90-	CA1197IR	14	65	06.90-	CS1069	12 3.1
		01.90-	CA1198IR	14	95			
5140	[6T-590]					06.90-	CS1069	12 3.1
5140 Maxxum	[6T-590]	01.90-	CA1197IR	14	65	06.90-	CS1069	12 3.1
		01.90-	CA1198IR	14	95			
5150	[6T-590]					06.90-	CS1069	12 3.1
7000		01.88-	CA1381IR#	14	110			
8000		05.97-	CA1381IR#	14	110			
E833		01.86-	CA616IR	14	32			
E833 A		01.86-	CA616IR	14	32			
MX		01.95- 01.02	CA1198IR	14	95			
V433		01.86-	CA616IR	14	32	01.86-	CS511	12 2.7
V533		01.86-	CA616IR	14	32	01.86-	CS511	12 2.7
Various Models		01.65-	CG50	14	22	01.72-	CS106	12 2.8
		01.65-	CG52	14	11	01.85- 01.92	US857	24 4.5
		01.65-	CG58	14	22			
<b>Caterpillar</b>								
<b>MISC</b>								
Various Models						01.85-	US864	24
						01.83-	US863	24
<b>Chang Feng (Liebao)</b>								
<b>AGRICULTURE</b>								
3320						01.92-	CS944	12 3.0
<b>Chevrolet</b>								
<b>PASSENGER CARS EU</b>								
Aveo 1.2	[B12D1]					01.08-	CS1422	12 0.8
	[F12S3]	03.06- 10.08	CA2023IR	14	80	03.06- 10.08	CS1422	12 0.8
						04.08-	CS1422	12 0.8
Aveo 1.2 16V	[B12D1]					04.08-	CS1422	12 0.8
Aveo 1.4	[F14D3]					03.06-	CS519	12 1.0
						01.08-	CS519	12 1.0
Beretta 2.2	[LN2]							
Beretta 2.3 16V	[LGO]	09.90- 01.92	UA938IR	14	100			
Beretta 3.1 V6	[LHO]					01.89-	US810#	12
Camaro 3.4 V6	[L32]					12.92- 12.95	US858	12
Camaro 5.0	[LG4]	01.90- 01.92	UA939IR	14	100			
Camaro 5.7	[LS1]	07.98-	UA1538IR	14	105			
Captiva 2.0 Diesel	[Z20S]					09.07-	CS1431	12 1.8
Captiva 2.0 Diesel 4WD	[Z20S]					10.06-	CS1431	12 1.8
Captiva 2.0 Diesel 4x4	[Z20S]					10.06-	CS1431	12 1.8
Captiva 2.4	[Z24SED]					06.06-	CS879	12 1.1
Captiva 2.4 4WD	[Z24SED]					06.06-	CS879	12 1.1
Captiva 2.4 LPG	[Z24SED]					01.07-	CS879	12 1.1
Captiva 2.4 LPG 4WD	[Z24SED]					01.07-	CS879	12 1.1
Corsica 2.2	[LN2]							
Cruze 2.0 CDi	[Z20S1]					05.09-	CS1431	12 1.8
						05.09-	CS1431	12 1.8
Epica 2.0 Diesel						01.07-	CS1431	12 1.8
Evanda 2.0	[X20SED]					03.05-	CS879	12 1.1
Kalos 1.2	[B12S1]	03.05-	CA2023IR	14	80	03.05-	CS1422	12 0.8
		03.05-	JA1600IR	14	65 ▲			
	[F12S3]	03.05-	CA2023IR	14	80	03.05-	CS1422	12 0.8
Kalos 1.4	[F14S3]					03.05- 09.06	CS519	12 1.0
Kalos 1.4 16V	[F14D3]					03.05-	CS519	12 1.0
Lacetti 1.4 16V	[F14D3]					03.05-	CS519	12 1.0
Lacetti 1.6	[F16D3]					03.05-	CS519	12 1.0
Lacetti 1.8	[T18SED]					03.05-	CS879	12 1.1
						08.05-	CS879	12 1.1
						08.05-	CS519	12 1.0
Lacetti 2.0 Diesel	[Z20DM]					01.07-	CS1431	12 1.8
Lumina 2.3 APV	[LD2]	12.92- 07.98	UA1109IR	14	105			
		10.93- 07.96	UA1113IR	14	100			
Lumina 3.1 APV	[L82]	01.94- 01.95	UA1113IR	14	100			
	[LG6]	08.89- 01.95	UA1113IR	14	100			
Malibu 3.8	[LC3]	01.83- 01.83	UA945IR	14	65			
Malibu 5.0	[LG4]	01.83- 12.83	UA945IR	14	65			
Matiz 0.8	[F8CV]	03.05-	JA1600IR	14	65 ▲	03.05-	CS1210	12 1.0
Matiz 0.8 LPG	[F8CV]	03.05-	JA1600IR	14	65 ▲	03.05-	CS1210	12 1.0
Matiz 1.0	[B10S]	03.05-	JA1600IR	14	65 ▲	03.05-	CS1422	12 0.8
	[B10S1]	03.05-	JA1600IR	14	65 ▲	03.05-	CS1422	12 0.8
Matiz 1.0 LPG	[B10S1]	03.05-	JA1600IR	14	65 ▲	03.05-	CS1422	12 0.8
Monte Carlo 3.8	[LC3]	01.83- 01.87	UA945IR	14	65			
Nubira 1.4	[F14D3]					01.05-	CS519	12 1.0
Nubira 1.6	[F16D3]					03.05-	CS519	12 1.0
Nubira 1.8	[F18D3]					01.06-	CS519	12 1.0
	[T18SED]					03.05-	CS879	12 1.1
						08.05-	CS519	12 1.0
						08.05-	CS879	12 1.1
Nubira 2.0 Diesel	[Z20DM]					01.07-	CS1431	12 1.8
	[Z20S]					01.05-	CS1431	12 1.8
Rezzo 1.6	[A16DMS]					08.05-	CS519	12 1.0
Rezzo 2.0	[T20SED]	08.05-	CA1745IR	14	85	08.05-	CS879	12 1.1
Rezzo/Tacuma 1.6	[A16DMS]					03.05-	CS1183	12 0.9
						03.05-	CS1188	12 1.1
Rezzo/Tacuma 2.0	[T20SED]	03.05-	CA1745IR	14	85	03.05-	CS879	12 1.1
S10 4.3	[L35]	10.94- 05.05	UA939IR	14	100	10.94- 05.05	US858	12
S10 4.3 4x4		10.94- 08.02	UA939IR	14	100	10.94- 08.02	US858	12
Spark 1.0						03.10-	CS1422	12 0.8
Spark 1.2						03.10-	CS1422	12 0.8
<b>PASSENGER CARS US</b>								
Astre 2.5		01.85- 01.90	UA943IR	14	60	01.85- 01.90	US810#	12
Astre 4.3		01.92- 01.95	UA967IR	14	105			
		01.85-	UA943IR	14	60	01.92- 01.98	US858	12



Bel Air 3.8	01.63- 01.65	UA916#	14 60		01.63- 01.65	US818	12 1.5
Bel Air 3.9	01.55- 01.56	UA943IR	14 60				
Bel Air 4.1	01.65- 01.71	UA916#	14 60		01.65- 01.73	US818	12 1.5
	01.72- 01.73	UA943IR	14 60				
Bel Air 4.4	01.81- 01.81	UA943IR	14 60				
Bel Air 4.6	01.63- 01.67	UA916#	14 60		01.63- 01.67	US818	12 1.5
Bel Air 5.0	01.68- 01.81	UA916#	14 60		01.68-	US818	12 1.5
	01.81- 01.81	UA943IR	14 60				
Bel Air 5.4	01.63- 01.67	UA916#	14 60		01.62- 01.67	US818	12 1.5
Bel Air 5.7	01.72- 01.75	UA943IR	14 60		01.69- 01.71	US818	12 1.5
	01.69- 01.71	UA916#	14 60				
Bel Air 6.5	01.66- 01.69	UA916#	14 60				
Bel Air 6.6	01.72- 01.75	UA943IR	14 60				
	01.70- 01.71	UA916#	14 60				
Bel Air 6.7	01.63- 01.65	UA916#	14 60				
Bel Air 7.0	01.66- 01.69	UA916#	14 60				
Bel Air 7.4	01.72- 01.75	UA943IR	14 60				
	01.70- 01.71	UA916#	14 60				
Beretta 2.0							
Beretta 2.2							
	01.93- 01.95	UA939IR	14 100				
Beretta 2.2 GT							
	01.93-	UA939IR	14 100				
Beretta 2.8	01.87- 01.89	UA1109IR	14 105				
Beretta 2.8 GT	01.89-	UA1109IR	14 105				
Beretta 3.1	01.90- 01.93	UA1109IR	14 105				
Beretta 3.1 GT	01.90- 01.93	UA1109IR	14 105				
Beretta 3.1 GTZ	01.91- 01.93	UA1109IR	14 105				
Biscayne 3.8	01.63- 01.65	UA916#	14 60		01.63- 01.65	US818	12 1.5
Biscayne 4.1	01.65- 01.71	UA916#	14 60		01.65- 01.71	US818	12 1.5
	01.72-	UA943IR	14 60				
Biscayne 4.6	01.63- 01.67	UA916#	14 60		01.63- 01.67	US818	12 1.5
Biscayne 5.0	01.68-	UA916#	14 60		01.68-	US818	12 1.5
Biscayne 5.4	01.63- 01.67	UA916#	14 60		01.62- 01.67	US818	12 1.5
Biscayne 5.7	01.69- 01.71	UA916#	14 60				
	01.72-	UA943IR	14 60		01.69- 01.71	US818	12 1.5
Biscayne 6.5	01.66- 01.69	UA916#	14 60				
Biscayne 6.6	01.72-	UA943IR	14 60				
	01.70- 01.71	UA916#	14 60				
Biscayne 6.7	01.63- 01.65	UA916#	14 60				
Biscayne 7.0	01.66- 01.69	UA916#	14 60				
Biscayne 7.4	01.72-	UA943IR	14 60				
	01.70- 01.70	UA916#	14 60				
Blazer 4.1	01.69- 01.71	UA916#	14 60		01.69- 01.75	US818	12 1.5
	01.72- 01.82	UA943IR	14 60				
Blazer 4.3					01.95-	US858	12
Blazer 4.8	01.73-	UA943IR	14 60		01.70-	US818	12 1.5
	01.70-	UA916#	14 60				
Blazer 5.0	01.72- 01.87	UA943IR	14 60		01.69- 01.87	US818	12 1.5
	01.87- 01.87	UA939IR	14 100				
	01.69- 01.71	UA916#	14 60				
Blazer 5.7	01.73- 01.86	UA943IR	14 60				
	01.69- 01.72	UA916#	14 60		01.87- 01.94	US818	12 1.5
	01.87- 01.94	UA939IR	14 100				
Blazer 6.2	01.82- 01.91	UA943IR	14 60				
Blazer 6.6	01.75- 01.79	UA943IR	14 60				
Blazer 7.4	01.73- 01.78	UA943IR	14 60				
Brookwood 4.1	01.69-	UA916#	14 60		01.69-	US818	12 1.5
Brookwood 5.7	01.72-	UA943IR	14 60		01.69- 01.71	US818	12 1.5
	01.69- 01.71	UA916#	14 60				
Brookwood 6.6	01.70-	UA916#	14 60				
	01.72-	UA943IR	14 60				
C10 3.8	01.63- 01.66	UA916#	14 60		01.63- 01.66	US818	12 1.5
C10 4.1	01.72- 01.84	UA943IR	14 60		01.66- 01.75	US818	12 1.5
	01.66- 01.70	UA916#	14 60				
C10 4.1 Big Ten	01.77- 01.80	UA943IR	14 60				
C10 4.1 Suburban	01.72- 01.80	UA943IR	14 60		01.68- 01.75	US818	12 1.5
	01.68- 01.71	UA916#	14 60				
C10 4.3	01.85- 01.86	UA943IR	14 60				
C10 4.6	01.63- 01.67	UA916#	14 60		01.63- 01.67	US818	12 1.5
C10 4.8	01.63- 01.71	UA916#	14 60		01.69- 01.71	US818	12 1.5
	01.73- 01.80	UA943IR	14 60				
C10 4.8 Big Ten	01.78- 01.80	UA943IR	14 60				
C10 4.8 Suburban	01.68- 01.71	UA916#	14 60		01.69- 01.71	US818	12 1.5
	01.73- 01.74	UA943IR	14 60				
C10 4.8	01.74-	UA943IR	14 60				
C10 4.8 Suburban	01.74- 01.74	UA943IR	14 60				
C10 5.0	01.68- 01.69	UA916#	14 60				
	01.72- 01.86	UA943IR	14 60		01.68- 01.73	US818	12 1.5
					01.85- 01.86	US858	12
C10 5.0 Big Ten	01.77- 01.79	UA943IR	14 60				
C10 5.0 Suburban	01.72- 01.86	UA943IR	14 60				
	01.68- 01.71	UA916#	14 60		01.85- 01.86	US858	12
					01.68- 01.73	US818	12 1.5
C10 5.4	01.62- 01.67	UA916#	14 60		01.62- 01.67	US818	12 1.5
C10 5.4 Suburban	01.68- 01.68	UA916#	14 60		01.68- 01.68	US818	12 1.5
C10 5.7	01.72- 01.86	UA943IR	14 60				
	01.69- 01.71	UA916#	14 60		01.82- 01.83	US818	12 1.5
C10 5.7 Big Ten	01.77- 01.80	UA943IR	14 60				
C10 5.7 Suburban	01.72- 01.86	UA943IR	14 60				
	01.69- 01.71	UA916#	14 60				
C10 5.7	01.78- 01.81	UA943IR	14 60				
C10 5.7 Big Ten	01.78- 01.79	UA943IR	14 60				
C10 5.7 Suburban	01.78- 01.81	UA943IR	14 60				
C10 5.7	01.74-	UA943IR	14 60				
C10 5.7 Suburban	01.74- 01.74	UA943IR	14 60				
C10 6.2	01.82- 01.86	UA943IR	14 60				
C10 6.2 Suburban	01.82- 01.86	UA943IR	14 60				
C10 6.5	01.68- 01.69	UA916#	14 60				
C10 6.5 Suburban	01.68- 01.69	UA916#	14 60				
C10 6.6	01.76- 01.79	UA943IR	14 60				
	01.70- 01.72	UA916#	14 60				
C10 6.6 Big Ten	01.80-	UA943IR	14 60				



**CHEVROLET** *Continued*

C10 6.6 Suburban	01.70- 01.71	UA916#	14 60				
	01.72- 01.72	UA943IR	14 60				
C10 7.4	01.73- 01.80	UA943IR	14 60				
C10 7.4 Big Ten	01.77- 01.79	UA943IR	14 60				
C10 7.4 Suburban	01.73- 01.80	UA943IR	14 60				
C1500 4.3	01.88- 01.95	UA939IR	14 100	01.88- 01.98	US858		12
C1500 5.0	01.88- 01.95	UA939IR	14 100	01.96- 01.99	US858		12
C1500 5.7	01.88- 01.95	UA939IR	14 100				
C1500 5.7 Suburban	01.92- 01.95	UA939IR	14 100				
C1500 6.2	01.88- 01.93	UA939IR	14 100				
C1500 6.5	01.94- 01.95	UA939IR	14 100	01.94- 01.95	US970		12 2.5
C1500 6.5 Turbo	01.94- 01.98	UA939IR	14 100	01.94- 01.98	US970		12 2.5
C1500 6.5 Turbo Suburban	01.94- 01.99	UA939IR	14 100	01.94- 01.99	US970		12 2.5
C1500 7.4	01.90- 01.93	UA953IR#	14 100				
C20 3.8	01.63- 01.65	UA916#	14 60	01.63- 01.65	US818		12 1.5
C20 4.1	01.72- 01.84	UA943IR	14 60	01.66- 01.75	US818		12 1.5
	01.68- 01.71	UA916#	14 60				
C20 4.1 Suburban	01.68- 01.71	UA916#	14 60	01.68- 01.74	US818		12 1.5
	01.72- 01.74	UA943IR	14 60				
C20 4.3	01.85- 01.86	UA943IR	14 60				
C20 4.6	01.63- 01.67	UA916#	14 60	01.63- 01.67	US818		12 1.5
C20 4.8	01.63- 01.72	UA916#	14 60	01.69- 01.72	US818		12 1.5
	01.73- 01.86	UA943IR	14 60				
C20 4.8 Suburban	01.73- 01.86	UA943IR	14 60				
	01.68- 01.72	UA916#	14 60	01.69- 01.72	US818		12 1.5
C20 4.8	01.74-	UA943IR	14 60				
C20 4.8 Suburban	01.74- 01.74	UA943IR	14 60				
C20 5.0	01.72- 01.86	UA943IR	14 60				
	01.68- 01.69	UA916#	14 60	01.85- 01.86	US858		12
				01.68- 01.69	US818		12 1.5
C20 5.0 Suburban	01.72- 01.86	UA943IR	14 60				
	01.68- 01.71	UA916#	14 60	01.85- 01.86	US858		12
				01.68- 01.73	US818		12 1.5
C20 5.4	01.62- 01.68	UA916#	14 60	01.62- 01.68	US818		12 1.5
C20 5.4 Suburban	01.68- 01.68	UA916#	14 60	01.68- 01.68	US818		12 1.5
C20 5.7	01.72- 01.86	UA943IR	14 60				
	01.64- 01.71	UA916#	14 60				
C20 5.7 Suburban	01.69- 01.71	UA916#	14 60				
	01.72- 01.86	UA943IR	14 60	01.82- 01.86	US818		12 1.5
C20 5.7	01.74-	UA943IR	14 60				
C20 5.7 Suburban	01.74- 01.74	UA943IR	14 60				
C20 6.2	01.82- 01.86	UA943IR	14 60				
C20 6.2 Suburban	01.82- 01.86	UA943IR	14 60				
C20 6.5	01.68- 01.69	UA916#	14 60				
C20 6.5 Suburban	01.68- 01.69	UA916#	14 60				
C20 6.6	01.76- 01.79	UA943IR	14 60				
	01.70- 01.71	UA916#	14 60				
C20 6.6 Suburban	01.70- 01.71	UA916#	14 60				
	01.72- 01.80	UA943IR	14 60				
C20 6.7	01.64- 01.65	UA916#	14 60				
C20 7.4	01.73- 01.86	UA943IR	14 60				
C20 7.4 Suburban	01.73- 01.86	UA943IR	14 60				
C2500 4.3	01.88- 01.95	UA939IR	14 100	01.88- 01.95	US858		12
C2500 5.0	01.88- 01.95	UA939IR	14 100				
				01.94- 01.95	US858		12
C2500 5.7	01.88- 01.95	UA939IR	14 100				
C2500 5.7 Suburban	01.92- 01.95	UA939IR	14 100				
C2500 6.2	01.88- 01.93	UA939IR	14 100	01.89- 01.93	US970		12 2.5
C2500 6.5	01.94- 01.95	UA939IR	14 100	01.94- 01.95	US970		12 2.5
C2500 6.5 Turbo	01.92- 01.00	UA939IR	14 100	01.92- 01.00	US970		12 2.5
C2500 6.5 Turbo Suburban	01.94- 01.99	UA939IR	14 100	01.94- 01.99	US970		12 2.5
C2500 7.4	01.91- 01.92	UA953IR#	14 100				
	01.94- 01.95	UA939IR	14 100				
C2500 7.4 Suburban	01.94- 01.95	UA939IR	14 100				
	01.92- 01.93	UA953IR#	14 100				
C30 3.8	01.64- 01.65	UA916#	14 60	01.64- 01.65	US818		12 1.5
C30 4.1	01.66- 01.71	UA916#	14 60	01.66- 01.75	US818		12 1.5
	01.72- 01.80	UA943IR	14 60				
C30 4.6	01.63- 01.67	UA916#	14 60	01.63- 01.67	US818		12 1.5
C30 4.8	01.63- 01.72	UA916#	14 60				
	01.73- 01.86	UA943IR	14 60	01.69- 01.72	US818		12 1.5
C30 4.8	01.74-	UA943IR	14 60				
C30 5.0	01.72- 01.79	UA943IR	14 60				
	01.86-	UA945IR	14 65	01.68- 01.69	US818		12 1.5
	01.68- 01.69	UA916#	14 60				
C30 5.4	01.62- 01.68	UA916#	14 60	01.62- 01.68	US818		12 1.5
C30 5.7	01.72- 01.86	UA943IR	14 60				
	01.64- 01.71	UA916#	14 60	01.83- 01.83	US818		12 1.5
C30 5.7	01.78- 01.78	UA943IR	14 60				
C30 5.7	01.74-	UA943IR	14 60				
C30 6.2	01.82- 01.86	UA943IR	14 60				
C30 6.5	01.68- 01.69	UA916#	14 60				
C30 6.6	01.70- 01.71	UA916#	14 60				
	01.76- 01.79	UA943IR	14 60				
C30 6.7	01.64- 01.65	UA916#	14 60				
C30 7.4	01.73- 01.86	UA943IR	14 60				
C3500 5.7	01.88- 01.95	UA939IR	14 100				
C3500 6.2	01.88- 01.93	UA939IR	14 100				
C3500 6.5 Turbo	01.92- 01.00	UA939IR	14 100	01.92- 01.00	US970		12 2.5
C3500 6.5 Turbo HD Chassis Cab				01.01- 01.01	US970		12 2.5
C3500 7.4	01.88- 01.92	UA953IR#	14 100				
	01.94- 01.95	UA939IR	14 100				
Camaro 2.5	01.82- 01.86	UA943IR	14 60				
Camaro 2.8	01.82- 01.84	UA943IR	14 60	01.85- 01.89	US858		12
	01.85- 01.89	UA945IR	14 65				
Camaro 3.1 RS				01.90- 01.92	US858		12
Camaro 3.4				01.93- 01.95	US858		12
Camaro 3.8	01.67- 01.69	UA916#	14 60	01.67- 01.81	US818		12 1.5
	01.80- 01.81	UA943IR	14 60				
Camaro 4.1	01.72- 01.79	UA943IR	14 60	01.67- 01.79	US818		12 1.5
	01.67- 01.71	UA916#	14 60				
Camaro 4.1 LT	01.77-	UA943IR	14 60	01.77-	US818		12 1.5
Camaro 4.4	01.80- 01.81	UA943IR	14 60				



Camaro 5.0	01.67- 01.67	UA916#	14 60						
	01.72- 01.84	UA943IR	14 60						
				01.67- 01.89	US818	12 1.5			
				01.85- 01.86	US858	12			
Camaro 5.0 Iroc-Z				01.90-	US818	12 1.5			
Camaro 5.0 LT	01.76-	UA943IR	14 60						
Camaro 5.0 RS				01.90- 01.92	US818	12 1.5			
Camaro 5.4	01.67- 01.67	UA916#	14 60	01.67- 01.67	US818	12 1.5			
Camaro 5.7	01.67- 01.71	UA916#	14 60						
	01.72- 01.81	UA943IR	14 60	01.69- 01.89	US818	12 1.5			
				01.90-	US818	12 1.5			
Camaro 5.7 Iroc-Z									
Camaro 5.7 LT	01.76- 01.77	UA943IR	14 60						
Camaro 5.7 Z28	01.72- 01.72	UA943IR	14 60						
				01.91- 01.92	US818	12 1.5			
Camaro 6.5	01.67- 01.70	UA916#	14 60						
Camaro 6.6	01.72-	UA943IR	14 60						
	01.70- 01.71	UA916#	14 60						
Caprice 3.8	01.80- 01.84	UA943IR	14 60	01.80- 01.84	US818	12 1.5			
	01.85-	UA945IR	14 65						
Caprice 4.1	01.77- 01.79	UA943IR	14 60	01.67- 01.79	US818	12 1.5			
	01.67- 01.69	UA916#	14 60						
Caprice 4.3	01.85- 01.90	UA943IR	14 60	01.85- 01.90	US818	12 1.5			
	01.94- 01.96	UA964IR	14 100						
Caprice 4.3 Classic Brougham	01.87- 01.88	UA943IR	14 60	01.87- 01.88	US818	12 1.5			
Caprice 4.3 Classic LS	01.94-	UA964IR	14 100						
Caprice 4.4	01.80- 01.82	UA943IR	14 60						
Caprice 4.6	01.66- 01.67	UA916#	14 60						
Caprice 5.0	01.86- 01.90	UA945IR	14 65	01.68- 01.90	US818	12 1.5			
	01.77- 01.88	UA943IR	14 60						
	01.68-	UA916#	14 60						
Caprice 5.0 Classic Brougham				01.87- 01.90	US818	12 1.5			
Caprice 5.0 Classic LS	01.93-	UA939IR	14 100						
Caprice 5.4	01.66- 01.67	UA916#	14 60	01.68-	US818	12 1.5			
Caprice 5.7	01.72- 01.82	UA943IR	14 60						
	01.94- 01.96	UA964IR	14 100	01.69- 01.71	US818	12 1.5			
	01.69- 01.71	UA916#	14 60						
Caprice 5.7 Classic LTZ									
Caprice 5.7 LS	01.94-	UA964IR	14 100						
Caprice 5.7	01.84- 01.85	UA945IR	14 65						
	01.80- 01.83	UA943IR	14 60						
Caprice 6.5	01.66- 01.69	UA916#	14 60						
Caprice 6.6	01.72- 01.76	UA943IR	14 60						
	01.70- 01.71	UA916#	14 60						
Caprice 7.0	01.66- 01.69	UA916#	14 60						
Caprice 7.4	01.72- 01.75	UA943IR	14 60						
	01.70- 01.71	UA916#	14 60						
Cavalier 2.0									
Cavalier 2.0 CS									
Cavalier 2.0 RS									
Cavalier 2.0 VL									
Cavalier 2.2									
Cavalier 2.2 RS									
Cavalier 2.2 VL									
Cavalier 2.8	01.85- 01.89	UA943IR	14 60						
Cavalier 2.8 CS	01.85- 01.87	UA943IR	14 60						
Cavalier 2.8 RS	01.86- 01.88	UA943IR	14 60						
Cavalier 2.8 Type-10	01.85-	UA943IR	14 60						
Cavalier 2.8 Z24	01.86- 01.89	UA943IR	14 60						
Cavalier 3.1	01.90- 01.94	UA1109IR	14 105						
Cavalier 3.1 RS	01.91- 01.94	UA1109IR	14 105						
Cavalier 3.1 Z24	01.90- 01.94	UA1109IR	14 105						
Celebrity 2.5	01.82- 01.90	UA943IR	14 60						
Celebrity 2.8	01.82- 01.86	UA943IR	14 60						
	01.84-	UA945IR	14 65						
Celebrity 3.1	01.90-	UA1109IR	14 105						
Celebrity 4.3	01.82- 01.85	UA943IR	14 60						
	01.84- 01.85	UA945IR	14 65						
Chevellé 3.2	01.64- 01.66	UA916#	14 60	01.64- 01.66	US818	12 1.5			
Chevellé 3.8	01.64- 01.67	UA916#	14 60	01.64- 01.67	US818	12 1.5			
Chevellé 3.8 300	01.68-	UA916#	14 60	01.68-	US818	12 1.5			
Chevellé 3.8 300 Deluxe	01.68-	UA916#	14 60	01.68-	US818	12 1.5			
Chevellé 3.8 Concours	01.68-	UA916#	14 60	01.68-	US818	12 1.5			
Chevellé 3.8 Greenbrier	01.69-	UA916#	14 60	01.69-	US818	12 1.5			
Chevellé 3.8 Malibu	01.68- 01.69	UA916#	14 60	01.68- 01.69	US818	12 1.5			
Chevellé 3.8 Nomad	01.68- 01.69	UA916#	14 60	01.68- 01.69	US818	12 1.5			
Chevellé 4.1	01.67- 01.71	UA916#	14 60	01.67- 01.71	US818	12 1.5			
	01.72-	UA943IR	14 60						
Chevellé 4.1 300	01.68-	UA916#	14 60	01.68-	US818	12 1.5			
Chevellé 4.1 300 Deluxe	01.68-	UA916#	14 60	01.68-	US818	12 1.5			
Chevellé 4.1 Concours	01.68- 01.71	UA916#	14 60	01.68- 01.71	US818	12 1.5			
Chevellé 4.1 Deluxe	01.73-	UA943IR	14 60	01.73-	US818	12 1.5			
Chevellé 4.1 Greenbrier	01.69- 01.71	UA916#	14 60	01.69- 01.71	US818	12 1.5			
Chevellé 4.1 Malibu	01.68- 01.71	UA916#	14 60	01.68- 01.71	US818	12 1.5			
	01.72- 01.72	UA943IR	14 60						
Chevellé 4.1 Nomad	01.72- 01.72	UA943IR	14 60	01.68- 01.71	US818	12 1.5			
	01.68- 01.71	UA916#	14 60						
Chevellé 4.6	01.64- 01.67	UA916#	14 60	01.64- 01.67	US818	12 1.5			
Chevellé 5.0	01.70-	UA916#	14 60	01.70-	US818	12 1.5			
	01.72- 01.72	UA943IR	14 60						
Chevellé 5.0 300	01.68-	UA916#	14 60	01.68-	US818	12 1.5			
Chevellé 5.0 300 Deluxe	01.69-	UA916#	14 60	01.69-	US818	12 1.5			
Chevellé 5.0 Concours	01.72- 01.72	UA943IR	14 60	01.69-	US818	12 1.5			
	01.69-	UA916#	14 60						
Chevellé 5.0 Deluxe	01.73-	UA943IR	14 60	01.73-	US818	12 1.5			
Chevellé 5.0 Greenbrier	01.72- 01.72	UA943IR	14 60	01.69-	US818	12 1.5			
	01.69-	UA916#	14 60						
Chevellé 5.0 Malibu	01.72- 01.72	UA943IR	14 60	01.68-	US818	12 1.5			
	01.68-	UA916#	14 60						
Chevellé 5.0 Nomad	01.68-	UA916#	14 60	01.68-	US818	12 1.5			
	01.72- 01.72	UA943IR	14 60						
Chevellé 5.4	01.64- 01.67	UA916#	14 60	01.64- 01.67	US818	12 1.5			
Chevellé 5.4 300	01.68-	UA916#	14 60	01.68-	US818	12 1.5			
Chevellé 5.4 Malibu	01.68-	UA916#	14 60	01.68-	US818	12 1.5			
Chevellé 5.4 Nomad	01.68-	UA916#	14 60	01.68-	US818	12 1.5			



**CHEVROLET** *Continued*

Chevelle 5.7	01.72- 01.72	UA943IR	14	60					
	01.70- 01.71	UA916#	14	60					
Chevelle 5.7 300 Deluxe	01.69-	UA916#	14	60	01.69-	US818	12	1.5	
Chevelle 5.7 Concours	01.72- 01.72	UA943IR	14	60					
	01.69- 01.71	UA916#	14	60	01.69- 01.71	US818	12	1.5	
Chevelle 5.7 Deluxe	01.73-	UA943IR	14	60					
Chevelle 5.7 Greenbrier	01.69- 01.71	UA916#	14	60					
	01.72- 01.72	UA943IR	14	60	01.69- 01.71	US818	12	1.5	
Chevelle 5.7 Malibu	01.72- 01.72	UA943IR	14	60	01.69- 01.71	US818	12	1.5	
	01.69- 01.71	UA916#	14	60					
Chevelle 5.7 Nomad	01.69- 01.71	UA916#	14	60					
	01.72- 01.72	UA943IR	14	60	01.69- 01.71	US818	12	1.5	
Chevelle 6.5	01.67- 01.67	UA916#	14	60					
	01.67- 01.67	UA943IR	14	60					
Chevelle 6.5 300	01.68-	UA916#	14	60					
Chevelle 6.5 300 Deluxe	01.69-	UA916#	14	60					
Chevelle 6.5 Concours	01.69-	UA916#	14	60					
Chevelle 6.5 Greenbrier	01.69-	UA916#	14	60					
Chevelle 6.5 Malibu	01.68- 01.69	UA916#	14	60					
Chevelle 6.5 Nomad	01.68- 01.69	UA916#	14	60					
Chevelle 6.5 SS	01.66- 01.68	UA916#	14	60					
Chevelle 6.6	01.72- 01.72	UA943IR	14	60					
	01.70-	UA916#	14	60					
Chevelle 6.6 Concours	01.70-	UA916#	14	60					
	01.72- 01.72	UA943IR	14	60					
Chevelle 6.6 Greenbrier	01.72- 01.72	UA943IR	14	60					
	01.70-	UA916#	14	60					
Chevelle 6.6 Malibu	01.72-	UA943IR	14	60					
	01.70- 01.71	UA916#	14	60					
Chevelle 6.6 Nomad	01.72- 01.72	UA943IR	14	60					
	01.70-	UA916#	14	60					
Chevelle 6.6 SS	01.71- 01.71	UA916#	14	60					
Chevelle 7.4	01.72- 01.72	UA943IR	14	60					
Chevelle 7.4 Deluxe	01.73-	UA943IR	14	60					
Chevelle 7.4 Malibu	01.70- 01.71	UA916#	14	60					
	01.72- 01.72	UA943IR	14	60					
Chevy 2.5	01.62- 01.67	UA916#	14	60	01.62- 01.67	US818	12	1.5	
Chevy 2.5 Nova	01.68-	UA916#	14	60	01.68-	US818	12	1.5	
Chevy 3.2	01.62- 01.67	UA916#	14	60	01.62- 01.67	US818	12	1.5	
Chevy 3.8	01.64- 01.66	UA916#	14	60	01.64- 01.66	US818	12	1.5	
Chevy 3.8 Nova	01.68- 01.69	UA916#	14	60	01.68- 01.69	US818	12	1.5	
Chevy 4.1	01.67- 01.67	UA916#	14	60	01.67- 01.67	US818	12	1.5	
Chevy 4.1 Nova	01.68- 01.69	UA916#	14	60	01.68- 01.69	US818	12	1.5	
Chevy 4.6	01.62- 01.67	UA916#	14	60	01.62- 01.67	US818	12	1.5	
Chevy 5.0 Nova	01.68-	UA916#	14	60	01.68-	US818	12	1.5	
Chevy 5.4	01.65- 01.67	UA916#	14	60	01.65- 01.67	US818	12	1.5	
Chevy 5.4 Nova	01.68-	UA916#	14	60	01.68-	US818	12	1.5	
Chevy 5.7 Nova	01.68-	UA916#	14	60	01.68-	US818	12	1.5	
Chevy 6.5 Nova	01.68- 01.69	UA916#	14	60					
Citation 2.5	01.80- 01.83	UA943IR	14	60	01.80- 01.81	US810#	12		
Citation 2.8	01.83- 01.84	UA945IR	14	65	01.80- 01.85	US810#	12		
	01.80- 01.85	UA943IR	14	60					
Corsica 2.0									
Corsica 2.2	01.94- 01.95	UA939IR	14	100					
Corsica 2.2 LT	01.93-	UA939IR	14	100					
Corsica 2.8	01.87- 01.89	UA1109IR	14	105					
Corsica 2.8 LTZ	01.89-	UA1109IR	14	105					
Corsica 3.1 LT	01.90- 01.93	UA1109IR	14	105					
Corsica 3.1 LTZ	01.90-	UA1109IR	14	105					
Corvaire 2.7	01.64- 01.67	UA916#	14	60					
Corvaire 2.7 500	01.68- 01.69	UA916#	14	60					
Corvaire 2.7 Monza	01.68- 01.69	UA916#	14	60					
Corvaire 2.7 Turbo	01.64- 01.66	UA916#	14	60					
Corvette 3.9	01.55- 01.55	UA943IR	14	60					
Corvette 5.0	01.80- 01.80	UA943IR	14	60					
Corvette 5.4	01.63- 01.67	UA916#	14	60	01.62- 01.67	US818	12	1.5	
Corvette 5.7	01.69- 01.81	UA943IR	14	60	01.69- 01.87	US818	12	1.5	
	01.88- 01.91	UA958IR	14	105					
Corvette 7.0	01.68- 01.69	UA943IR	14	60	01.66- 01.69	US818	12	1.5	
	01.66- 01.67	UA916#	14	60					
Corvette 7.4	01.70- 01.74	UA943IR	14	60					
El Camino 3.3	01.78- 01.79	UA943IR	14	60					
El Camino 3.8	01.78- 01.84	UA943IR	14	60	01.64- 01.84	US818	12	1.5	
	01.64- 01.69	UA916#	14	60					
El Camino 3.8 Custom	01.68- 01.69	UA916#	14	60	01.68- 01.69	US818	12	1.5	
El Camino 4.1	01.72- 01.77	UA943IR	14	60	01.68- 01.77	US818	12	1.5	
	01.68- 01.71	UA916#	14	60					
El Camino 4.1 Custom	01.68- 01.71	UA916#	14	60	01.68- 01.73	US818	12	1.5	
	01.72- 01.73	UA943IR	14	60					
El Camino 4.3					01.85- 01.87	US818	12	1.5	
El Camino 4.4	01.79- 01.82	UA943IR	14	60					
El Camino 4.6	01.64- 01.67	UA916#	14	60	01.64- 01.67	US818	12	1.5	
El Camino 5.0	01.72- 01.87	UA943IR	14	60					
	01.68- 01.71	UA916#	14	60	01.68- 01.73	US818	12	1.5	
El Camino 5.0 Custom	01.68- 01.70	UA916#	14	60	01.68- 01.72	US818	12	1.5	
	01.72- 01.72	UA943IR	14	60					
El Camino 5.4	01.64- 01.67	UA916#	14	60	01.64- 01.67	US818	12	1.5	
El Camino 5.4 Custom	01.68-	UA916#	14	60	01.68-	US818	12	1.5	
El Camino 5.7	01.72- 01.79	UA943IR	14	60					
	01.69- 01.71	UA916#	14	60	01.69- 01.71	US818	12	1.5	
El Camino 5.7 Custom	01.72- 01.76	UA943IR	14	60					
	01.69- 01.71	UA916#	14	60	01.69- 01.71	US818	12	1.5	
El Camino 5.7	01.83-	UA945IR	14	65					
El Camino 6.5	01.66- 01.67	UA916#	14	60					
El Camino 6.5 Custom	01.69-	UA916#	14	60					
El Camino 6.6	01.72- 01.76	UA943IR	14	60					
	01.70- 01.71	UA916#	14	60					
El Camino 6.6 Custom	01.72- 01.76	UA943IR	14	60					
	01.70-	UA916#	14	60					
El Camino 7.4	01.73- 01.74	UA943IR	14	60					
	01.70-	UA916#	14	60					
El Camino 7.4 Custom	01.72- 01.75	UA943IR	14	60					
	01.70- 01.71	UA916#	14	60					



Express 6.5 Turbo 2500				01.99- 01.02	<b>US970</b>	12 2.5
Express 6.5 Turbo 3500				01.99- 01.02	<b>US970</b>	12 2.5
G10 2.5	01.64- 01.65	<b>UA916#</b>	14 60			
G10 3.8	01.66- 01.67	<b>UA916#</b>	14 60	01.66- 01.67	<b>US818</b>	12 1.5
G10 3.8 Sportvan	01.68- 01.69	<b>UA916#</b>	14 60	01.68- 01.69	<b>US818</b>	12 1.5
G10 4.1	01.72- 01.84	<b>UA943IR</b>	14 60	01.67- 01.75	<b>US818</b>	12 1.5
	01.67- 01.71	<b>UA916#</b>	14 60			
G10 4.1 Sportvan	01.68- 01.71	<b>UA916#</b>	14 60	01.68- 01.75	<b>US818</b>	12 1.5
	01.72- 01.84	<b>UA943IR</b>	14 60			
G10 4.3	01.85- 01.90	<b>UA943IR</b>	14 60			
	01.87- 01.95	<b>UA939IR</b>	14 100			
G10 4.3 Express				01.91- 01.97	<b>US858</b>	12
G10 4.3 Sportvan	01.87- 01.93	<b>UA939IR</b>	14 100	01.96- 01.97	<b>US858</b>	12
	01.85- 01.90	<b>UA943IR</b>	14 60			
G10 5.0	01.72- 01.86	<b>UA943IR</b>	14 60	01.91- 01.93	<b>US858</b>	12
	01.69- 01.69	<b>UA916#</b>	14 60			
	01.87- 01.95	<b>UA939IR</b>	14 100	01.96- 01.97	<b>US858</b>	12
G10 5.0 Express				01.70- 01.71	<b>US818</b>	12 1.5
G10 5.0 Sportvan	01.68- 01.71	<b>UA916#</b>	14 60			
	01.72- 01.86	<b>UA943IR</b>	14 60	01.70- 01.71	<b>US818</b>	12 1.5
	01.87- 01.93	<b>UA939IR</b>	14 100			
G10 5.7	01.72- 01.84	<b>UA943IR</b>	14 60			
	01.70- 01.71	<b>UA916#</b>	14 60			
G10 5.7 Sportvan	01.72- 01.86	<b>UA943IR</b>	14 60			
	01.87- 01.93	<b>UA939IR</b>	14 100			
	01.70- 01.71	<b>UA916#</b>	14 60			
G10 7.4	01.73- 01.74	<b>UA943IR</b>	14 60			
G20 3.8	01.67- 01.69	<b>UA916#</b>	14 60	01.67- 01.69	<b>US818</b>	12 1.5
G20 3.8 Sportvan	01.68- 01.69	<b>UA916#</b>	14 60	01.68- 01.69	<b>US818</b>	12 1.5
G20 4.1	01.72- 01.84	<b>UA943IR</b>	14 60	01.68- 01.75	<b>US818</b>	12 1.5
	01.68- 01.71	<b>UA916#</b>	14 60			
G20 4.1 Sportvan	01.68- 01.71	<b>UA916#</b>	14 60	01.68- 01.74	<b>US818</b>	12 1.5
	01.72- 01.84	<b>UA943IR</b>	14 60			
G20 4.3	01.85- 01.90	<b>UA943IR</b>	14 60			
	01.87- 01.95	<b>UA939IR</b>	14 100	01.91- 01.97	<b>US858</b>	12
G20 4.3 Sportvan	01.87- 01.95	<b>UA939IR</b>	14 100			
	01.85- 01.90	<b>UA943IR</b>	14 60	01.91- 01.95	<b>US858</b>	12
G20 4.8	01.73- 01.80	<b>UA943IR</b>	14 60			
G20 4.8 Sportvan	01.75- 01.78	<b>UA943IR</b>	14 60			
G20 4.8	01.74- 01.74	<b>UA943IR</b>	14 60			
G20 5.0	01.77- 01.86	<b>UA943IR</b>	14 60	01.96- 01.96	<b>US858</b>	12
	01.68- 01.69	<b>UA916#</b>	14 60			
	01.87- 01.95	<b>UA939IR</b>	14 100			
G20 5.0 Express				01.96- 01.97	<b>US858</b>	12
G20 5.0 Sportvan	01.87- 01.95	<b>UA939IR</b>	14 100			
	01.68- 01.69	<b>UA916#</b>	14 60			
	01.77- 01.86	<b>UA943IR</b>	14 60			
G20 5.7	01.72- 01.86	<b>UA943IR</b>	14 60			
	01.70- 01.71	<b>UA916#</b>	14 60			
	01.87- 01.95	<b>UA939IR</b>	14 100			
G20 5.7 Sportvan	01.72- 01.86	<b>UA943IR</b>	14 60			
	01.84- 01.86	<b>UA938IR</b>	14 100			
	01.84- 01.86	<b>UA945IR</b>	14 65			
	01.70- 01.71	<b>UA916#</b>	14 60			
	01.87- 01.95	<b>UA939IR</b>	14 100			
G20 6.2	01.83- 01.93	<b>UA943IR</b>	14 60			
G20 6.2 Sportvan	01.83- 01.93	<b>UA943IR</b>	14 60			
G20 6.5	01.94- 01.95	<b>UA939IR</b>	14 100	01.94- 01.95	<b>US970</b>	12 2.5
G20 6.5 Sportvan	01.94- 01.95	<b>UA939IR</b>	14 100	01.94- 01.95	<b>US970</b>	12 2.5
G20 6.5 Turbo				01.96- 01.97	<b>US970</b>	12 2.5
G20 6.5 Turbo Express				01.97-	<b>US970</b>	12 2.5
G20 6.6	01.75- 01.80	<b>UA943IR</b>	14 60			
G20 6.6 Sportvan	01.75- 01.80	<b>UA943IR</b>	14 60			
G20 7.4	01.73- 01.74	<b>UA943IR</b>	14 60			
G2500 6.5 Turbo				01.98- 01.98	<b>US970</b>	12 2.5
G30 4.1	01.72- 01.84	<b>UA943IR</b>	14 60	01.71- 01.74	<b>US818</b>	12 1.5
	01.71- 01.71	<b>UA916#</b>	14 60			
G30 4.1 Sportvan	01.71- 01.71	<b>UA916#</b>	14 60	01.71- 01.74	<b>US818</b>	12 1.5
	01.72- 01.74	<b>UA943IR</b>	14 60			
G30 4.3	01.85- 01.90	<b>UA943IR</b>	14 60	01.91- 01.95	<b>US858</b>	12
	01.87- 01.95	<b>UA939IR</b>	14 100			
G30 4.8	01.74- 01.79	<b>UA943IR</b>	14 60			
G30 4.8 Sportvan	01.75- 01.78	<b>UA943IR</b>	14 60			
G30 4.8	01.74- 01.74	<b>UA943IR</b>	14 60			
G30 5.0	01.78- 01.85	<b>UA943IR</b>	14 60			
G30 5.7	01.71- 01.71	<b>UA916#</b>	14 60			
	01.72- 01.88	<b>UA943IR</b>	14 60			
	01.87- 01.96	<b>UA939IR</b>	14 100			
G30 5.7 Sportvan	01.71-	<b>UA916#</b>	14 60			
	01.87- 01.96	<b>UA939IR</b>	14 100			
	01.72- 01.86	<b>UA943IR</b>	14 60			
G30 6.2	01.83- 01.93	<b>UA943IR</b>	14 60	01.92- 01.92	<b>US970</b>	12 2.5
	01.92- 01.92	<b>UA953IR#</b>	14 100			
G30 6.2 Sportvan	01.83- 01.93	<b>UA943IR</b>	14 60			
G30 6.5	01.94- 01.95	<b>UA939IR</b>	14 100	01.94- 01.95	<b>US970</b>	12 2.5
G30 6.5 Sportvan	01.94- 01.95	<b>UA939IR</b>	14 100	01.94- 01.95	<b>US970</b>	12 2.5
G30 6.5 Turbo				01.96- 01.97	<b>US970</b>	12 2.5
G30 6.5 Turbo Express				01.96- 01.97	<b>US970</b>	12 2.5
G30 6.6	01.75- 01.80	<b>UA943IR</b>	14 60			
G30 6.6 Sportvan	01.75- 01.80	<b>UA943IR</b>	14 60			
G30 7.4	01.88- 01.95	<b>UA953IR#</b>	14 100			
	01.73- 01.75	<b>UA943IR</b>	14 60			
G30 7.4 Sportvan	01.88- 01.95	<b>UA953IR#</b>	14 100			
G3500 6.5 Turbo				01.98- 01.98	<b>US970</b>	12 2.5
Impala 3.8	01.80- 01.84	<b>UA943IR</b>	14 60	01.63- 01.84	<b>US818</b>	12 1.5
	01.85-	<b>UA945IR</b>	14 65			
	01.63- 01.65	<b>UA916#</b>	14 60			
Impala 4.1	01.72- 01.79	<b>UA943IR</b>	14 60	01.65- 01.79	<b>US818</b>	12 1.5
	01.65- 01.71	<b>UA916#</b>	14 60			
Impala 4.1 Custom	01.77-	<b>UA943IR</b>	14 60	01.77-	<b>US818</b>	12 1.5
Impala 4.3	01.85- 01.85	<b>UA943IR</b>	14 60	01.85-	<b>US818</b>	12 1.5
Impala 4.4	01.80- 01.82	<b>UA943IR</b>	14 60			
Impala 4.6	01.63- 01.67	<b>UA916#</b>	14 60	01.63- 01.67	<b>US818</b>	12 1.5

**CHEVROLET Continued**

Impala 5.0	01.77- 01.85	UA943IR	14	60			
	01.68-	UA916#	14	60	01.68-	US818	12 1.5
Impala 5.0 Custom	01.77-	UA943IR	14	60			
Impala 5.4	01.63- 01.67	UA916#	14	60	01.62- 01.67	US818	12 1.5
Impala 5.7	01.72- 01.85	UA943IR	14	60			
	01.69- 01.71	UA916#	14	60	01.69- 01.71	US818	12 1.5
Impala 5.7 Custom	01.76- 01.77	UA943IR	14	60			
Impala 5.7 SS	01.94- 01.96	UA964IR	14	100			
Impala 5.7	01.84- 01.85	UA945IR	14	65			
	01.80- 01.83	UA943IR	14	60			
Impala 6.5	01.66- 01.69	UA916#	14	60			
Impala 6.6	01.72- 01.76	UA943IR	14	60			
	01.70- 01.71	UA916#	14	60			
Impala 6.6 Custom	01.76- 01.76	UA943IR	14	60			
Impala 6.7	01.63- 01.65	UA916#	14	60			
Impala 7.0	01.66- 01.69	UA916#	14	60			
Impala 7.4	01.72- 01.75	UA943IR	14	60			
	01.70- 01.71	UA916#	14	60			
Impala 7.4 Custom	01.76-	UA943IR	14	60			
K10 3.8	01.64- 01.69	UA916#	14	60	01.64- 01.65	US818	12 1.5
K10 4.1	01.66- 01.71	UA916#	14	60			
	01.72- 01.84	UA943IR	14	60	01.66- 01.75	US818	12 1.5
K10 4.1 Suburban	01.68- 01.71	UA916#	14	60	01.68- 01.75	US818	12 1.5
	01.72- 01.80	UA943IR	14	60			
K10 4.3	01.85- 01.86	UA943IR	14	60	01.85- 01.86	US818	12 1.5
K10 4.6	01.63- 01.67	UA916#	14	60	01.63- 01.67	US818	12 1.5
K10 4.8	01.75- 01.80	UA943IR	14	60			
	01.64- 01.66	UA916#	14	60			
K10 5.0	01.68- 01.69	UA916#	14	60			
	01.77- 01.86	UA943IR	14	60	01.85- 01.86	US858	12
					01.68- 01.86	US818	12 1.5
K10 5.0 Suburban	01.68- 01.71	UA916#	14	60			
	01.72- 01.86	UA943IR	14	60	01.68- 01.86	US818	12 1.5
					01.85- 01.86	US858	12
K10 5.4	01.62- 01.68	UA916#	14	60	01.62- 01.68	US818	12 1.5
K10 5.4 Suburban	01.68- 01.68	UA916#	14	60	01.68- 01.68	US818	12 1.5
K10 5.7	01.72- 01.86	UA943IR	14	60			
	01.69- 01.71	UA916#	14	60	01.82- 01.86	US818	12 1.5
K10 5.7 Suburban	01.69- 01.71	UA916#	14	60			
	01.72- 01.86	UA943IR	14	60	01.82- 01.86	US818	12 1.5
K10 6.2	01.82- 01.86	UA943IR	14	60			
K10 6.2 Suburban	01.82- 01.86	UA943IR	14	60			
K10 6.5	01.68- 01.69	UA916#	14	60			
K10 6.5 Suburban	01.68- 01.68	UA916#	14	60			
K10 6.6	01.75- 01.80	UA943IR	14	60			
K10 6.6 Suburban	01.70- 01.72	UA916#	14	60			
	01.75- 01.79	UA943IR	14	60			
K10 7.4	01.74- 01.80	UA943IR	14	60			
K1500 4.3	01.88- 01.95	UA939IR	14	100	01.88- 01.98	US858	12
K1500 5.0	01.88- 01.95	UA939IR	14	100			
					01.88- 01.95	US818	12 1.5
					01.96- 01.99	US858	12
K1500 5.7	01.88- 01.95	UA939IR	14	100			
					01.88- 01.95	US818	12 1.5
K1500 5.7 Suburban	01.92- 01.95	UA939IR	14	100	01.92- 01.95	US818	12 1.5
K1500 6.2	01.88- 01.93	UA939IR	14	100			
K1500 6.5	01.94-	UA939IR	14	100	01.94-	US970	12 2.5
K1500 6.5 Turbo	01.94- 01.98	UA939IR	14	100	01.94- 01.98	US970	12 2.5
K1500 6.5 Turbo Suburban	01.94- 01.95	UA939IR	14	100	01.96- 01.99	US970	12 2.5
K20 3.8	01.64- 01.65	UA916#	14	60	01.64- 01.65	US818	12 1.5
K20 4.1	01.66- 01.71	UA916#	14	60	01.66- 01.75	US818	12 1.5
	01.72- 01.80	UA943IR	14	60			
K20 4.1 Suburban	01.68- 01.71	UA916#	14	60	01.68- 01.74	US818	12 1.5
	01.72- 01.74	UA943IR	14	60			
K20 4.3	01.85- 01.85	UA943IR	14	60			
					01.85-	US818	12 1.5
K20 4.6	01.63- 01.67	UA916#	14	60	01.63- 01.67	US818	12 1.5
K20 4.8	01.64- 01.72	UA916#	14	60			
	01.73- 01.86	UA943IR	14	60	01.70- 01.72	US818	12 1.5
K20 4.8 Suburban	01.73- 01.86	UA943IR	14	60	01.69- 01.72	US818	12 1.5
	01.68- 01.72	UA916#	14	60			
K20 4.8	01.74- 01.74	UA943IR	14	60			
K20 5.0	01.77- 01.85	UA943IR	14	60			
	01.68- 01.69	UA916#	14	60	01.68- 01.85	US818	12 1.5
					01.85- 01.85	US858	12
K20 5.0 Suburban	01.72- 01.86	UA943IR	14	60	01.68- 01.86	US818	12 1.5
	01.68- 01.71	UA916#	14	60			
					01.85- 01.86	US858	12
K20 5.4	01.62- 01.68	UA916#	14	60	01.64- 01.68	US818	12 1.5
K20 5.4 Suburban	01.68- 01.68	UA916#	14	60	01.68- 01.68	US818	12 1.5
K20 5.7	01.72- 01.86	UA943IR	14	60			
	01.64- 01.71	UA916#	14	60			
K20 5.7 Suburban	01.72- 01.86	UA943IR	14	60			
	01.69- 01.71	UA916#	14	60	01.82- 01.86	US818	12 1.5
K20 6.0	01.66- 01.66	UA916#	14	60			
K20 6.2	01.82- 01.86	UA943IR	14	60			
K20 6.2 Suburban	01.82- 01.86	UA943IR	14	60			
K20 6.5	01.68- 01.69	UA916#	14	60			
K20 6.6	01.75- 01.80	UA943IR	14	60			
K20 6.6 Suburban	01.75- 01.80	UA943IR	14	60			
K20 6.7	01.64- 01.65	UA916#	14	60			
K20 7.4	01.73- 01.80	UA943IR	14	60			
K20 7.4 Suburban	01.73- 01.85	UA943IR	14	60			
					01.85- 01.85	US818	12 1.5
K2500 4.3	01.88- 01.95	UA939IR	14	100	01.88- 01.95	US858	12
K2500 5.0	01.88- 01.95	UA939IR	14	100			
					01.88- 01.95	US818	12 1.5
K2500 5.7	01.88- 01.95	UA939IR	14	100			
					01.88- 01.95	US818	12 1.5
K2500 5.7 Suburban	01.92- 01.95	UA939IR	14	100	01.92- 01.95	US818	12 1.5
K2500 6.2	01.88- 01.93	UA939IR	14	100	01.89- 01.93	US970	12 2.5
K2500 6.5	01.94-	UA939IR	14	100	01.94-	US970	12 2.5
K2500 6.5 Turbo	01.92- 01.00	UA939IR	14	100	01.92- 01.00	US970	12 2.5





K2500 6.5 Turbo Suburban	01.94- 01.95	UA939IR	14 100	01.96- 01.99	US970	12 2.5
K2500 7.4	01.94- 01.95	UA939IR	14 100			
	01.91- 01.93	UA953IR#	14 100	01.91- 01.93	US818	12 1.5
K2500 7.4 Suburban	01.94- 01.95	UA939IR	14 100	01.92- 01.93	US818	12 1.5
	01.92- 01.93	UA953IR#	14 100			
K30 4.1	01.72- 01.75	UA943IR	14 60	01.68- 01.75	US818	12 1.5
	01.68- 01.71	UA916#	14 60			
K30 4.8	01.73- 01.86	UA943IR	14 60	01.69- 01.72	US818	12 1.5
	01.68- 01.72	UA916#	14 60			
K30 4.8	01.74- 01.74	UA943IR	14 60			
K30 5.0	01.68- 01.71	UA916#	14 60	01.68- 01.73	US818	12 1.5
	01.72- 01.73	UA943IR	14 60			
K30 5.4	01.68- 01.68	UA916#	14 60	01.68- 01.68	US818	12 1.5
K30 5.7	01.72- 01.86	UA943IR	14 60			
	01.69- 01.71	UA916#	14 60	01.82- 01.85	US818	12 1.5
K30 6.2	01.82- 01.86	UA943IR	14 60			
K30 6.5	01.68- 01.69	UA916#	14 60			
K30 6.6	01.70- 01.71	UA916#	14 60			
	01.77- 01.80	UA943IR	14 60			
K30 7.4	01.73- 01.86	UA943IR	14 60			
K3500 5.7	01.88- 01.95	UA939IR	14 100			
				01.88- 01.95	US818	12 1.5
K3500 6.2	01.88- 01.93	UA939IR	14 100			
K3500 6.5 Turbo	01.92- 01.00	UA939IR	14 100	01.92- 01.00	US970	12 2.5
K3500 7.4	01.88- 01.93	UA953IR#	14 100			
	01.94- 01.95	UA939IR	14 100	01.88- 01.93	US818	12 1.5
Kingswood 5.7	01.69- 01.71	UA916#	14 60			
	01.72- 01.72	UA943IR	14 60	01.69- 01.71	US818	12 1.5
Kingswood 6.6	01.72- 01.72	UA943IR	14 60			
	01.70- 01.71	UA916#	14 60			
Kingswood 7.4	01.70-	UA916#	14 60			
	01.72- 01.72	UA943IR	14 60			
Laguna 5.0	01.76-	UA943IR	14 60			
Laguna 5.7	01.73- 01.76	UA943IR	14 60			
Laguna 6.6	01.74- 01.76	UA943IR	14 60			
Laguna 7.4	01.73- 01.74	UA943IR	14 60			
Lumina 2.5				01.90- 01.91	US810#	12
Lumina 3.1	01.90- 01.94	UA1113IR	14 100			
Lumina 3.1 APV	01.90- 01.95	UA1109IR	14 105			
Lumina 3.1 Euro	01.90- 01.94	UA1113IR	14 100			
Lumina 3.1	01.93-	UA1113IR	14 100			
Lumina 3.1 Euro	01.93-	UA1113IR	14 100			
Lumina 3.4 Euro	01.92- 01.94	UA938IR	14 100			
Lumina 3.8 APV	01.92- 01.95	UA964IR	14 100	01.92- 01.95	US810#	12
Luv 1.8	01.72- 01.81	JA100	14 35			
Luv 2.2 Diesel				01.81- 01.82	JS552	12 2.0
Malibu 3.2	01.64- 01.66	UA916#	14 60	01.64- 01.66	US818	12 1.5
Malibu 3.3	01.78- 01.79	UA943IR	14 60			
Malibu 3.8	01.78- 01.83	UA943IR	14 60	01.64- 01.83	US818	12 1.5
	01.64- 01.67	UA916#	14 60			
Malibu 4.1	01.67- 01.67	UA916#	14 60	01.73- 01.77	US818	12 1.5
	01.73- 01.77	UA943IR	14 60			
Malibu 4.4	01.79- 01.82	UA943IR	14 60			
Malibu 4.6	01.64- 01.67	UA916#	14 60	01.64- 01.67	US818	12 1.5
Malibu 5.0	01.73- 01.83	UA943IR	14 60			
				01.73-	US818	12 1.5
Malibu 5.4	01.64- 01.67	UA916#	14 60	01.64- 01.67	US818	12 1.5
Malibu 5.7	01.73- 01.81	UA943IR	14 60			
Malibu 5.7	01.83-	UA945IR	14 65			
	01.82- 01.82	UA943IR	14 60			
Malibu 6.5	01.66- 01.67	UA916#	14 60			
Malibu 6.6	01.74- 01.76	UA943IR	14 60			
Malibu 7.4	01.73- 01.75	UA943IR	14 60			
Metro 1.0	01.98- 01.00	JA682IR	14 50	01.98- 01.00	JS512	12 0.8
				01.98- 01.00	JS1092	12 1.2
Metro 1.3	01.99- 01.00	JA682IR	14 50	01.99- 01.00	JS512	12 0.8
				01.99- 01.00	JS1092	12 1.2
Metro 1.3 LSI	01.98- 01.01	JA682IR	14 50	01.98- 01.01	JS512	12 0.8
				01.98- 01.01	JS1092	12 1.2
Monte Carlo 3.3	01.78- 01.79	UA943IR	14 60			
Monte Carlo 3.8	01.78- 01.87	UA943IR	14 60	01.78- 01.87	US818	12 1.5
Monte Carlo 3.8 Turbo	01.80- 01.81	UA943IR	14 60	01.80- 01.81	US818	12 1.5
Monte Carlo 4.3				01.85- 01.88	US818	12 1.5
Monte Carlo 4.4	01.79- 01.82	UA943IR	14 60			
Monte Carlo 5.0	01.76- 01.88	UA943IR	14 60			
Monte Carlo 5.0 SS	01.87- 01.88	UA945IR	14 65	01.84- 01.88	US818	12 1.5
	01.84- 01.86	UA943IR	14 60			
Monte Carlo 5.7	01.72- 01.81	UA943IR	14 60			
	01.70- 01.71	UA916#	14 60			
Monte Carlo 5.7	01.84-	UA945IR	14 65			
	01.82- 01.83	UA943IR	14 60			
Monte Carlo 6.6	01.72- 01.76	UA943IR	14 60			
	01.70- 01.71	UA916#	14 60			
Monte Carlo 7.4	01.72- 01.75	UA943IR	14 60			
	01.70- 01.71	UA916#	14 60			
Monza 2.3	01.75- 01.77	UA943IR	14 60			
Monza 2.3 2+2	01.76- 01.77	UA943IR	14 60			
Monza 2.5	01.78- 01.80	UA943IR	14 60			
Monza 2.5 2+2	01.78- 01.80	UA943IR	14 60			
Monza 3.2	01.78- 01.79	UA943IR	14 60	01.78- 01.79	US818	12 1.5
Monza 3.2 2+2	01.78- 01.79	UA943IR	14 60	01.78- 01.79	US818	12 1.5
Monza 3.8	01.78- 01.80	UA943IR	14 60	01.78- 01.80	US818	12 1.5
Monza 3.8 2+2	01.78- 01.80	UA943IR	14 60	01.78- 01.80	US818	12 1.5
Monza 4.3	01.75- 01.76	UA943IR	14 60	01.75- 01.76	US818	12 1.5
Monza 4.3 2+2	01.76-	UA943IR	14 60	01.76-	US818	12 1.5
Monza 5.0	01.76- 01.78	UA943IR	14 60			
				01.79-	US818	12 1.5
Monza 5.0 2+2	01.76- 01.78	UA943IR	14 60			
				01.79-	US818	12 1.5
Monza 5.7	01.75-	UA943IR	14 60			
Nova 1.6	01.85- 01.88	JA189IR	14 55	01.88-	JS317	12 1.0
	01.88-	JA142IR	14 60			
Nova 2.5	01.62- 01.67	UA916#	14 60	01.62- 01.67	US818	12 1.5
Nova 3.2	01.62- 01.67	UA916#	14 60	01.62- 01.67	US818	12 1.5



**CHEVROLET** *Continued*

Nova 3.8	01.64- 01.66	UA916#	14 60	01.64- 01.66	US818	12 1.5
Nova 4.1	01.72- 01.79	UA943IR	14 60	01.67- 01.79	US818	12 1.5
	01.67- 01.71	UA916#	14 60			
Nova 4.1 Concours	01.76- 01.77	UA943IR	14 60			
				01.76- 01.77	US818	12 1.5
Nova 4.1 Custom	01.73- 01.79	UA943IR	14 60	01.73- 01.79	US818	12 1.5
Nova 4.3	01.75-	UA943IR	14 60	01.75-	US818	12 1.5
Nova 4.3 Custom	01.75-	UA943IR	14 60	01.75-	US818	12 1.5
Nova 4.6	01.62- 01.67	UA916#	14 60	01.62- 01.67	US818	12 1.5
Nova 5.0	01.70-	UA916#	14 60			
	01.72- 01.78	UA943IR	14 60	01.70- 01.73	US818	12 1.5
Nova 5.0 Concours	01.76-	UA943IR	14 60			
Nova 5.0 Custom	01.73-	UA943IR	14 60	01.73-	US818	12 1.5
Nova 5.4	01.65- 01.67	UA916#	14 60	01.65- 01.67	US818	12 1.5
Nova 5.7	01.72- 01.79	UA943IR	14 60			
	01.70- 01.71	UA916#	14 60			
Nova 5.7 Concours	01.78- 01.77	UA943IR	14 60			
Nova 5.7 Custom	01.73- 01.79	UA943IR	14 60			
Nova 6.5	01.70-	UA916#	14 60			
Nova 6.6	01.70-	UA916#	14 60			
One-fifty Series 3.9	01.55- 01.57	UA943IR	14 60			
One-fifty Series 4.3	01.55- 01.57	UA943IR	14 60			
One-fifty Series 4.6	01.57- 01.57	UA943IR	14 60			
P 10 4.1	01.68- 01.72	UA916#	14 60	01.68- 01.72	US818	12 1.5
	01.73- 01.74	UA943IR	14 60			
P 10 4.8	01.75- 01.80	UA943IR	14 60			
P 10 5.7	01.73- 01.78	UA943IR	14 60			
P 10 7.4	01.73-	UA943IR	14 60			
P 20 3.8	01.63- 01.65	UA916#	14 60			
P 20 4.1	01.73- 01.74	UA943IR	14 60			
	01.66- 01.66	UA916#	14 60	01.66- 01.66	US818	12 1.5
P 20 4.8	01.73- 01.89	UA943IR	14 60	01.64- 01.72	US818	12 1.5
	01.64- 01.72	UA916#	14 60			
P 20 5.0	01.68- 01.69	UA916#	14 60	01.68- 01.69	US818	12 1.5
P 20 5.7	01.73- 01.86	UA943IR	14 60			
	01.64- 01.72	UA916#	14 60			
P 20 6.2	01.82- 01.89	UA943IR	14 60			
P 20 6.7	01.64- 01.65	UA916#	14 60			
P 20 7.4	01.73-	UA943IR	14 60			
P10 2.5	01.63- 01.65	UA916#	14 60			
P10 3.2	01.66- 01.66	UA916#	14 60			
P10 3.8	01.63- 01.69	UA916#	14 60	01.63- 01.69	US818	12 1.5
P10 4.8	01.67- 01.67	UA916#	14 60	01.67- 01.67	US818	12 1.5
P20 4.1	01.70- 01.72	UA916#	14 60	01.70- 01.72	US818	12 1.5
P20 5.7	01.87- 01.89	UA953IR#	14 100			
P30 3.8	01.63- 01.65	UA916#	14 60			
P30 4.1	01.66- 01.72	UA916#	14 60			
	01.73- 01.74	UA943IR	14 60	01.66- 01.72	US818	12 1.5
P30 4.3				01.90- 01.95	US858	12
P30 4.8	01.64- 01.72	UA916#	14 60	01.64- 01.72	US818	12 1.5
	01.73- 01.89	UA943IR	14 60			
P30 5.0	01.68- 01.69	UA916#	14 60	01.68- 01.69	US818	12 1.5
P30 5.7	01.64- 01.72	UA916#	14 60			
	01.73- 01.86	UA943IR	14 60			
	01.87- 01.95	UA953IR#	14 100			
P30 6.2	01.82- 01.93	UA943IR	14 60			
P30 6.5	01.94- 01.97	UA939IR	14 100	01.94- 01.99	US970	12 2.5
P30 6.5 Turbo				01.94- 01.99	US970	12 2.5
P30 6.7	01.64- 01.65	UA916#	14 60			
P30 7.4	01.73- 01.89	UA943IR	14 60			
R10 4.3	01.87-	UA939IR	14 100			
R10 5.0	01.87- 01.87	UA939IR	14 100			
	01.87- 01.87	UA943IR	14 60			
R10 5.0 Suburban	01.87- 01.87	UA939IR	14 100			
	01.87- 01.87	UA943IR	14 60			
R10 5.7	01.87-	UA943IR	14 60			
	01.87-	UA953IR#	14 100			
R10 5.7 Suburban	01.87- 01.88	UA943IR	14 60			
	01.87- 01.88	UA953IR#	14 100			
R10 6.2	01.87- 01.87	UA943IR	14 60			
R10 6.2 Suburban	01.87- 01.88	UA943IR	14 60			
R1500 5.7 Suburban	01.89- 01.91	UA939IR	14 100			
R1500 6.2 Suburban	01.89- 01.91	UA943IR	14 60	01.89- 01.91	US970	12 2.5
R20 4.3	01.87-	UA939IR	14 100			
R20 4.8	01.87- 01.88	UA943IR	14 60			
	01.87- 01.88	UA945IR	14 65			
R20 5.0	01.87- 01.87	UA943IR	14 60			
	01.87- 01.87	UA939IR	14 100			
R20 5.7	01.87- 01.88	UA943IR	14 60			
	01.87- 01.88	UA953IR#	14 100			
R20 5.7 Suburban	01.87- 01.88	UA943IR	14 60			
	01.87- 01.88	UA953IR#	14 100			
R20 6.2	01.87- 01.88	UA943IR	14 60			
R20 6.2 Suburban	01.87- 01.88	UA943IR	14 60			
R20 7.4	01.87- 01.88	UA943IR	14 60			
R20 7.4 Suburban	01.87- 01.88	UA943IR	14 60			
	01.88- 01.88	UA953IR#	14 100			
R2500 5.7 Suburban	01.89- 01.91	UA939IR	14 100			
R2500 6.2 Suburban	01.89- 01.91	UA943IR	14 60	01.89- 01.91	US970	12 2.5
R2500 7.4 Suburban	01.89- 01.91	UA943IR	14 60			
R30 4.8	01.87- 01.88	UA943IR	14 60			
	01.87- 01.88	UA945IR	14 65			
R30 5.7	01.87- 01.88	UA943IR	14 60			
	01.87- 01.88	UA953IR#	14 100			
R30 6.2	01.87- 01.88	UA943IR	14 60			
R30 7.4	01.87- 01.88	UA943IR	14 60	01.87- 01.88	US818	12 1.5
R3500 5.7	01.89- 01.91	UA939IR	14 100			
R3500 6.2	01.89- 01.91	UA943IR	14 60	01.89- 01.91	US970	12 2.5
R3500 7.4	01.89- 01.91	UA943IR	14 60			
S10 1.9	01.82- 01.85	UA943IR	14 60	01.89-	US818	12 1.5
S10 1.9 Blazer	01.83- 01.84	UA943IR	14 60			



S10 2.0	01.83- 01.84	UA943IR	14 60		
S10 2.0 Blazer	01.83- 01.84	UA943IR	14 60		
S10 2.2	01.84- 01.85	UA945IR	14 65	01.84- 01.85	JS552 12 2.0
S10 2.2 Blazer	01.84-	UA945IR	14 65	01.84-	JS552 12 2.0
S10 2.5	01.85- 01.91	UA943IR	14 60		
	01.91- 01.93	UA938IR	14 100		
S10 2.5 Blazer	01.85- 01.88	UA943IR	14 60		
S10 2.8	01.82- 01.85	UA943IR	14 60	01.84- 01.93	US858 12
S10 2.8 Blazer	01.83- 01.85	UA943IR	14 60	01.84- 01.90	US858 12
S10 4.3	01.88- 01.95	UA939IR	14 100	01.88- 01.95	US858 12
S10 4.3 Blazer	01.91- 01.94	UA939IR	14 100	01.88- 01.94	US858 12
Silverado 4.3 1500				01.99- 01.99	US858 12
Sprint 1.0				01.85- 01.88	JS512 12 0.8
Sprint 1.0 ER	01.87- 01.88	JA188IR	14 45	01.87- 01.88	JS512 12 0.8
Sprint 1.0 Plus				01.86-	JS512 12 0.8
Sprint 1.0 Turbo	01.87- 01.88	JA188IR	14 45	01.87- 01.88	JS512 12 0.8
Suburban 3.8	01.63- 01.67	UA916#	14 60		
Suburban 3.9	01.61- 01.62	UA916#	14 60		
Suburban 4.1	01.66- 01.67	UA916#	14 60	01.66- 01.67	US818 12 1.5
Suburban 4.6	01.63- 01.67	UA916#	14 60	01.63- 01.67	US818 12 1.5
Suburban 4.8	01.63- 01.67	UA916#	14 60		
Suburban 5.4	01.62- 01.67	UA916#	14 60	01.62- 01.67	US818 12 1.5
Suburban 5.7	01.64- 01.65	UA916#	14 60		
Suburban 6.0	01.66- 01.66	UA916#	14 60		
Suburban 6.7	01.64- 01.65	UA916#	14 60		
Tahoe 5.7	01.95-	UA939IR	14 100		
Tahoe 6.5 Turbo	01.95- 01.98	UA1538IR	14 105	01.95- 01.99	US970 12 2.5
Townsmen 5.7	01.69- 01.71	UA916#	14 60	01.69- 01.71	US818 12 1.5
	01.72- 01.72	UA943IR	14 60		
Townsmen 6.6	01.72- 01.72	UA943IR	14 60	01.70- 01.71	US818 12 1.5
	01.70- 01.71	UA916#	14 60		
Townsmen 7.4	01.70-	UA916#	14 60	01.70-	US818 12 1.5
	01.72- 01.72	UA943IR	14 60		
Tracer 1.6	01.98- 01.98	JA682IR	14 50	01.99- 01.00	JS1153 12 1.4
				01.98- 01.98	JS380 12 1.0
Tracker 2.0	[J20A]			01.99- 01.03	JS1153 12 1.4
				01.99- 01.03	JS380 12 1.0
Truck 4.3	01.55- 01.59	UA943IR	14 60		
Truck 5.3	01.56- 01.59	UA943IR	14 60		
Two-Ten Series 3.9	01.55- 01.57	UA943IR	14 60		
Two-Ten Series 4.3	01.55- 01.57	UA943IR	14 60		
Two-Ten Series 4.6	01.57- 01.57	UA943IR	14 60		
V10 4.3	01.87- 01.87	UA939IR	14 100	01.87- 01.87	US818 12 1.5
V10 5.0	01.87- 01.87	UA939IR	14 100		
	01.87- 01.87	UA943IR	14 60	01.87- 01.87	US818 12 1.5
V10 5.7	01.87- 01.87	UA943IR	14 60		
	01.87- 01.87	UA953IR#	14 100	01.87- 01.87	US818 12 1.5
V10 5.7 Suburban	01.87- 01.88	UA953IR#	14 100		
	01.87- 01.88	UA943IR	14 60	01.87- 01.88	US818 12 1.5
V10 6.2	01.87- 01.87	UA943IR	14 60		
V10 6.2 Suburban	01.87- 01.88	UA943IR	14 60		
V1500 5.7 Suburban	01.89- 01.91	UA939IR	14 100		
				01.89- 01.91	US818 12 1.5
V1500 6.2 Suburban	01.91- 01.91	UA953IR#	14 100	01.89- 01.90	US970 12 2.5
	01.89- 01.90	UA943IR	14 60		
V20 4.8	01.87-	UA943IR	14 60		
	01.87-	UA945IR	14 65	01.87-	US818 12 1.5
V20 5.7	01.87-	UA943IR	14 60		
	01.87-	UA953IR#	14 100	01.87-	US818 12 1.5
V20 5.7 Suburban	01.87- 01.88	UA943IR	14 60		
	01.87- 01.88	UA953IR#	14 100	01.87- 01.88	US818 12 1.5
V20 6.2	01.87- 01.87	UA943IR	14 60		
V20 6.2 Suburban	01.87- 01.88	UA943IR	14 60		
V20 7.4 Suburban	01.87- 01.88	UA943IR	14 60		
				01.87- 01.88	US818 12 1.5
V2500 5.7 Suburban	01.89- 01.91	UA939IR	14 100		
				01.89- 01.91	US818 12 1.5
V2500 6.2 Suburban	01.91- 01.91	UA953IR#	14 100	01.89- 01.90	US970 12 2.5
	01.89- 01.90	UA943IR	14 60		
V2500 7.4 Suburban	01.89- 01.90	UA943IR	14 60		
				01.89- 01.90	US818 12 1.5
V30 4.8	01.87- 01.88	UA943IR	14 60		
	01.87- 01.88	UA945IR	14 65	01.87- 01.88	US818 12 1.5
V30 5.7	01.87- 01.88	UA943IR	14 60		
	01.87- 01.88	UA953IR#	14 100	01.87- 01.88	US818 12 1.5
V30 6.2	01.87- 01.88	UA943IR	14 60		
V30 7.4	01.87- 01.88	UA943IR	14 60		
				01.87- 01.88	US818 12 1.5
V3500 5.7	01.89- 01.91	UA939IR	14 100		
				01.89- 01.91	US818 12 1.5
V3500 6.2	01.91-	UA953IR#	14 100	01.89- 01.90	US970 12 2.5
	01.89- 01.90	UA943IR	14 60		
V3500 7.4	01.89- 01.91	UA943IR	14 60		
				01.89- 01.91	US818 12 1.5
Vega 2.0	01.75-	UA943IR	14 60		
Vega 2.0 Cosworth	01.76- 01.76	UA943IR	14 60		
Vega 2.3	01.71- 01.77	UA943IR	14 60		
Vega 2.3 Panel	01.74- 01.75	UA943IR	14 60		
<b>PASSENGER CARS AO</b>					
Corsa 1.6	[Z16SE]	08.01-	CA1581IR	14 100	
Corsa 1.7 DTi	[Y17DT]	08.01-	JA1526IR	14 70	08.01- JS1158 12 1.4
		AC 08.01-	JA1521IR	14 100	
Spark 0.8	[F8CV]	09.00-	JA1600IR	14 65	09.00- CS1210 12 1.0
Spark 1.0		11.02-	JA1600IR	14 65	11.02- CS1422 12 0.8
Spark 1.0 SX		05.05-	JA1600IR	14 65	05.05- CS1422 12 0.8
<b>Chrysler</b>					
<b>PASSENGER CARS EU</b>					
300 M 2.7 V6 24V	[EER]			11.98- 08.00	CS1189 12 1.1
300 M 3.5 V6 24V	[EGG]			07.98- 08.00	CS1189 12 1.1
Daytona 2.5 i Turbo GS	[EDT]			01.88- 01.90	CS979# 12 1.4
Lebaron 2.2 i Turbo	[EDG]	09.86- 12.90	UA1212	14 90	09.86- 12.90 CS979# 12 1.4
	[EDR]	09.86- 12.90	UA1212	14 90	09.86- 12.90 CS979# 12 1.4
Lebaron 2.2 i	[EDG]	01.90- 01.90	UA960	14 90	09.86- 08.95 CS979# 12 1.4



**CHRYSLER** *Continued*

Lebaron 2.5 i Turbo	[EDT]	01.89- 12.93	UA1212	14	90	01.89- 12.93	CS979#	12	1.4
Lebaron 2.5 i	[EDM]	09.86- 12.93	UA1212	14	90	09.86- 12.93	CS979#	12	1.4
Lebaron 3.0 i V6	[6G72]	01.90- 08.95	UA1212	14	90	01.90- 08.95	JS762	12	1.4
	[EFA]	01.90- 12.94	UA1212	14	90				
Neon 1.8 16V	[EBD]	09.97- 09.00	CA2099*	14	85	09.97- 09.00	CS1189	12	1.1
Neon 2.0	[ECC]					10.96- 09.00	CS990	12	1.1
Neon 2.0 16V	[420H]	08.99-	CA2099*	14	85	05.94- 08.99	CS1189	12	1.1
	[ECB]	10.02- 12.06	CA2099*	14	85				
	[ECC]					06.94- 08.99	CS990	12	1.1
	[ECH]	10.01-	CA2099*	14	85				
Neon 2.0 16V LE	[ECC 420T]					04.96- 08.99	CS1189	12	1.1
PT Cruiser 2.0 16V	[ECC]	06.00- 12.04	JA1791	14	120	06.00- 12.04	JS1316	12	1.2
PT Cruiser 2.2 CRD						08.05-	CS1481*	12	2.2
PT Cruiser 2.2 Diesel	[EDJ]					12.02-	CS1481*	12	2.2
PT Cruiser 2.4	[EDZ]					03.04-	JS1316	12	1.2
PT Cruiser 2.4 16V	[EDZ]					06.00-	JS1316	12	1.2
Saratoga 3.0	[6G72]	09.89- 12.95	UA1212	14	90	09.89- 12.95	JS762	12	1.4
Sebring 2.0	[ECC]					04.01-	JS1316	12	1.2
Sebring 2.4		04.01-	JA1805IR	14	90				
Stratus 2.0 LE	[420X]	06.96-	UA1215	14	90	06.96-	CS1189	12	1.1
	[C00]	01.97- 04.01	UA1215	14	90	01.97- 12.97	CS990	12	1.1
						01.98- 04.01	CS1189	12	1.1
Stratus 2.0 16V	[ECB]	12.95-	UA1215	14	90	12.95-	CS990	12	1.1
Stratus 2.4 16V	[EDZ]	01.97- 04.01	UA1215	14	90	12.95- 04.01	CS1189	12	1.1
Stratus 2.5 LX	[625H]					04.96-	CS1189	12	1.1
Stratus 2.5 V6 LX	[EEB]					01.98- 04.01	CS1189	12	1.1
Voyager 2.0 i	[C00]	01.95- 03.01	UA1215	14	90				
Voyager 2.4 i	[B00]	10.95- 12.00	JA1707	14	120	10.95- 12.00	CS1190	12	1.4
		10.95- 08.96	UA1215	14	90				
		08.96- 12.00	JA1706	14	90				
Voyager 2.5 i	[K]	04.92- 09.95	UA1212	14	90	04.92- 09.95	CS979#	12	1.4
		04.92- 09.95	UA1213	14	120				
Voyager 2.5 i SE	[K00]	04.92- 12.95	UA1214	14	120	01.88- 12.95	CS979#	12	1.4
Voyager 2.5 CRD	[ENC]	02.01-	CA2021*	14	160	02.00- 12.07	CS1454*	12	2.0
	[ENJ]	02.01-	CA2021*	14	160	02.00- 12.07	CS1454*	12	2.0
Voyager 2.5 TD	[425CLIRS/X]	01.97- 12.98	CA1478IR	14	115	01.95- 12.00	CS611	12	2.2
		01.97- 12.00	UA1213	14	120	BO			
		01.98- 03.01	CA1590IR	14	115				
Voyager 2.5 TD SE	[09B]	01.92- 08.93	UA1213	14	120	04.92- 12.95	CS611	12	2.2
		08.93- 12.95	UA1214	14	120				
	[M00]	01.92- 08.93	UA1214	14	120	04.92- 01.95	CS611	12	2.2
		09.93- 01.95	UA1213	14	120				
Voyager 2.8 CRD	[ENR]	06.04-	CA2021*	14	160	AT 06.04-	CS1482*	12	2.2
						10.07-	CS1482*	12	2.2
Voyager 2.8 CRDi	[ENS]					10.07-	CS1482*	12	2.2
Voyager 3.0		01.95- 03.01	JA1706	14	90	01.95- 01.96	JS762	12	1.4
		01.95- 03.01	JA1707	14	120				
Voyager 3.0 i	[300]	01.90- 01.93	UA960	14	90	01.88- 09.95	JS762	12	1.4
	[6G72]	01.90- 01.93	UA960	14	90	01.88- 09.95	JS762	12	1.4
Voyager 3.3	[EGA]	02.00-	CA2092*	14	160	02.00-	JS942	12	1.2
Voyager 3.3 AWD	[EGA]	02.00-	CA2092*	14	160	02.00-	CS1502*	12	1.4
Voyager 3.3 Flex-Fuel		02.00-	CA2092*	14	160	02.00-	CS1502*	12	1.4
Voyager 3.3 i	[R00]	10.95- 12.99	JA1706	14	90	10.95- 12.99	JS942	12	1.2
		10.95- 12.99	JA1707	14	120	ND			
		10.95- 12.99	UA1212	14	90	BO			
		10.95- 12.99	UA1213	14	120	BO			
Voyager 3.3 i LE	[EGA]	04.92- 09.95	UA1213	14	120	04.92- 09.95	JS942	12	1.2
		04.92- 09.95	UA960	14	90	ND			
Voyager 3.3 i LE AWD	[EGA]	04.92- 09.95	UA1213	14	120	04.92- 09.95	JS942	12	1.2
		04.92- 09.95	UA960	14	90	ND			
	[R00]	04.92- 09.95	UA1213	14	120	04.92- 09.95	JS942	12	1.2
		04.92- 09.95	UA960	14	90	ND			
Voyager 3.8 i	[EGH]					02.00-	CS1502*	12	1.4
Voyager 3.8 i AWD	[EGH]	01.95- 12.00	JA1706	14	90	02.00-	CS1502*	12	1.4
		01.95- 12.00	JA1707	14	120	AT 01.97- 12.00	JS942	12	1.2
		10.95- 12.00	JA1706	14	90	01.95- 12.00	JS942	12	1.2
	[L00]	10.95- 12.00	JA1707	14	120	ND			
<b>PASSENGER CARS US</b>									
Cirrus 2.4		01.00- 01.00	UA1215	14	90				
Cirrus 2.4 LX	[EDZ]	01.95- 01.97	UA1215	14	90				
Cirrus 2.4 LXi	[EDZ]	01.97-	UA1215	14	90				
E Class 2.6						01.83- 01.84	JS339	12	1.0
Fifthavenue 5.2						01.88- 01.89	JS762	12	1.4
Imperial 3.3						01.90-	JS942	12	1.2
Imperial 3.8						01.91- 01.93	CS1501*	12	1.4
						01.91- 01.93	JS942	12	1.2
Laser 2.2		01.84- 01.86	UA1212	14	90	BO			
Laser 2.2 XE		01.84- 01.85	UA1212	14	90	BO			
Laser 2.2 Turbo		01.84- 01.86	UA1212	14	90	BO			
Laser 2.2 Turbo XE		01.84- 01.86	UA1212	14	90	BO			
Laser 2.5		01.86-	UA1212	14	90	BO			
Laser 2.5 XE		01.86-	UA1212	14	90	BO	01.86-	CS979#	12 1.4
Lebaron 2.2 GTS		01.85- 01.88	UA1212	14	90	BO	01.86-	CS979#	12 1.4
Lebaron 2.2 Turbo GTC		01.90- 01.90	UA960	14	90		01.90- 01.90	CS979#	12 1.4
Lebaron 2.2 Turbo GTS		01.85- 01.88	UA1212	14	90	BO	01.89-	CS979#	12 1.4
Lebaron 2.5		01.92-	UA960	14	90		01.86- 01.93	CS979#	12 1.4
		01.86- 01.93	UA1212	14	90	BO			
Lebaron 2.5 GTS		01.86- 01.88	UA1212	14	90	BO	01.86- 01.88	CS979#	12 1.4
Lebaron 2.5 Landau		01.92-	UA960	14	90		01.92-	CS979#	12 1.4
Lebaron 2.5 LE		01.93-	UA960	14	90		01.93-	CS979#	12 1.4
Lebaron 2.5 Turbo		01.89- 01.92	UA1212	14	90	BO	01.89- 01.92	CS979#	12 1.4
Lebaron 2.5 Turbo GTC		01.89- 01.89	UA1212	14	90	BO	01.89- 01.92	CS979#	12 1.4
		01.90- 01.92	UA960	14	90				
Lebaron 2.5 Turbo GTS		01.89-	UA1212	14	90	BO	01.89-	CS979#	12 1.4
Lebaron 2.6						01.82- 01.85	JS339	12	1.0
Lebaron 2.6 Medallion						01.82- 01.82	JS339	12	1.0
Lebaron 3.0						01.90- 01.94	JS762	12	1.4
Lebaron 3.0 GTC						01.91- 01.95	JS762	12	1.4
Lebaron 3.0 Landau						01.91- 01.94	JS762	12	1.4
Lebaron 3.0 LE						01.93- 01.94	JS762	12	1.4
Lebaron 3.0 LX						01.91- 01.94	JS762	12	1.4
New Yorker 2.2 Turbo		01.88-	UA1212	14	90	BO	01.88-	CS979#	12 1.4
New Yorker 2.5		01.86- 01.87	UA1212	14	90	BO	01.86- 01.87	CS979#	12 1.4
New Yorker 2.6						01.83- 01.85	JS339	12	1.0



New Yorker 3.0					01.88- 01.89	JS762	12	1.4
New Yorker 3.0 Landau					01.88- 01.89	JS762	12	1.4
New Yorker 3.3					01.90- 01.93	JS942	12	1.2
New Yorker 3.3 Fifth Avenue					01.90- 01.93	JS942	12	1.2
New Yorker 3.3 Landau					01.90-	JS942	12	1.2
New Yorker 3.8 Fifth Avenue					01.91- 01.93	JS942	12	1.2
Sebring 2.4 JX	[EDZ]	01.96- 01.97	UA1215	14 90				
TC 2.2 Turbo Maserati		01.89- 01.90	UA1212	14 90	01.89- 01.90	CS979#	12	1.4
TC 3.0 Maserati					01.90- 01.91	JS762	12	1.4
Town & Country 2.2 Turbo		01.85- 01.88	UA1212	14 90 BO				
Town & Country 2.5		01.86- 01.88	UA1212	14 90 BO	01.86- 01.88	CS979#	12	1.4
Town & Country 2.6					01.82- 01.82	JS339	12	1.0
Town & Country 3.3					01.90- 01.00	JS942	12	1.2
Town & Country 3.3 LX					01.96- 01.98	JS942	12	1.2
Town & Country 3.3 SX					01.97- 01.98	JS942	12	1.2
Town & Country 3.3	[EGM]				01.98- 01.00	JS942	12	1.2
Town & Country 3.8					01.94- 01.00	JS942	12	1.2
Town & Country 3.8 LX					01.96- 01.98	JS942	12	1.2
Town & Country 3.8 LXI					01.96- 01.98	JS942	12	1.2
Town & Country 3.8 SX					01.97- 01.98	JS942	12	1.2
<b>PASSENGER CARS AO</b>								
Cirrus 2.0 LX	[ECB]	10.97- 09.00	UA1215	14 90	10.97- 09.00	CS1189	12	1.1
Cirrus 2.4 LX	[EDZ]	05.94- 09.00	UA1215	14 90				
Cirrus 2.5 LX	[EEB]							
PT Cruiser 2.0	[ECC]	10.04-	JA1791	14 120	10.04-	JS1316	12	1.2
Voyager 3.0	[EFA]	10.90- 09.95	UA960	14 90	10.90- 09.95	JS762	12	1.4
<b>Citroen</b>								
<b>PASSENGER CARS EU</b>								
2 CV 4 0.4	[A53]	03.63- 02.70	CA112	14 26 A30	03.63- 02.70	CS126	12	0.7
	[A79/1]	03.63- 02.70	CA115	14 28 A26				
		01.70- 12.75	CA112	14 26 A30	01.70- 12.75	CS126	12	0.7
		01.70- 12.75	CA115	14 28 A26				
2 CV 6 0.6	[A06/635]	02.70- 07.90	CA112	14 26 A30	02.70- 07.90	CS126	12	0.7
		02.70- 07.90	CA115	14 28 A26				
	[A06/664]	02.70- 07.90	CA112	14 26 A30	02.70- 07.90	CS126	12	0.7
		02.70- 07.90	CA115	14 28 A26				
	[M28/1]	09.75- 06.81	CA112	14 26 A30	09.75- 06.81	CS126	12	0.7
		09.75- 06.81	CA115	14 28 A26				
Acadiane 6 0.6	[A06/664]				08.78- 07.87	CS126	12	0.7
	[M28 (AM2)]	08.78- 10.88	CA115	14 28	08.78- 10.88	CS126	12	0.7
Ami 6 0.6	[M28]	05.68- 07.69	CA112	14 26 A30	05.68- 07.69	CS126	12	0.7
		05.68- 07.69	CA115	14 28 A26				
Ami 8 0.6	[M28]	07.69- 12.77	CA112	14 26 A30	07.69- 12.77	CS126	12	0.7
		07.69- 12.77	CA115	14 28 A26				
Ami Super 1.0	[G10]	03.73- 12.77	CA112	14 26 A30				
		03.73- 12.77	CA115	14 28 A26				
AX 1.0	[C1A]	09.86- 06.92	CA3591R	14 50	09.86- 06.92	CS390	12	0.9
		09.86- 06.92	CA5331R	14 70		CS581	12	1.0
AX 1.4	[K2A (TU3S)]	01.88- 12.92	CA3591R	14 50	01.88- 12.92	CS542	12	1.4
		01.88- 12.92	CA5331R	14 70	01.88- 12.92	CS581	12	1.0
		AC 01.88- 12.92	CA3691R	14 50	01.88- 12.92	CS390	12	0.9
AX 1.4 GT	[KDZ (TU3M/Z)]	01.89- 12.91	CA3591R	14 50	01.89- 12.91	CS542	12	1.4
		01.89- 12.91	CA5331R	14 70	01.89- 12.91	CS581	12	1.0
		AC 01.89- 12.91	CA3691R	14 50				
AX 10 1.0	[C3A]	12.86- 12.88	CA3591R	14 50	12.86- 12.88	CS390	12	0.9
		12.86- 12.88	CA5331R	14 70				
	[CDY (TU9M)]	07.86- 12.98	CA3591R	14 50	07.86- 12.98	CS390	12	0.9
		07.86- 12.98	CA5331R	14 70				
	[CDZ (TU9M)]	07.92- 12.98	CA3591R	14 50	07.92- 03.97	CS542	12	1.4
		07.92- 12.98	CA5331R	14 70	04.97- 12.98	CS581	12	1.0
		AC 07.92- 12.98	CA3691R	14 50				
		AC 07.92- 12.98	CA6391R	14 80				
AX 11 1.1	[H1B]	10.89- 07.96	CA3591R	14 50	05.91- 07.96	CS581	12	1.0
		10.89- 07.96	CA5331R	14 70	10.89- 04.91	CS390	12	0.9
	[H1B (TU1)]	12.86- 06.90	CA3591R	14 50	12.86- 06.90	CS390	12	0.9
		12.86- 06.90	CA5331R	14 70				
	[HAZ (TU1CP)]	09.88- 12.89	CA3591R	14 50	09.88- 12.89	CS390	12	0.9
		09.88- 12.89	CA5331R	14 70				
	[HDZ (TU1M)]	10.89- 07.96	CA3591R	14 50	10.89- 04.91	CS390	12	0.9
		10.89- 07.96	CA5331R	14 70	05.91- 07.96	CS581	12	1.0
AX 11 1.1 4x4	[H1A (TU1)]	06.91- 07.92	CA3591R	14 50	06.91- 07.92	CS1111	12	0.7
		06.91- 07.92	CA5331R	14 70	06.91- 07.92	CS542	12	1.4
		AC 06.91- 07.92	CA6391R	14 80	06.91- 07.92	CS581	12	1.0
AX 13 1.3 Sport	[M4A]	04.87- 12.88	CA3591R	14 50	04.87- 12.88	CS581	12	1.0
		04.87- 12.88	CA5331R	14 70	04.87- 12.88	CS390	12	0.9
AX 14 1.4	[K1F (TU3A)]	06.88- 12.89	CA3591R	14 50	06.88- 12.89	CS390	12	0.9
		06.88- 12.89	CA5331R	14 70				
	[K2A]	01.88- 12.92	CA3591R	14 50	01.88- 07.91	CS390	12	0.9
		01.88- 12.92	CA5331R	14 70	07.91- 12.92	CS581	12	1.0
	[K2B]	01.88- 12.92	CA3591R	14 50	01.88- 07.91	CS390	12	0.9
		01.88- 12.92	CA5331R	14 70	07.91- 12.92	CS581	12	1.0
	[KAY (TU3CP)]	12.86- 12.89	CA3591R	14 50	12.86- 12.89	CS390	12	0.9
		12.86- 12.89	CA5331R	14 70				
	[KDX (TU3M/Z)]	03.89- 12.96	CA3591R	14 50	05.91- 12.96	CS581	12	1.0
		03.89- 12.96	CA5331R	14 70	03.89- 04.91	CS390	12	0.9
	[KDY (TU3FM)]	03.89- 12.96	CA3591R	14 50	03.89- 04.91	CS390	12	0.9
		03.89- 12.96	CA5331R	14 70	05.91- 12.96	CS581	12	1.0
	[KDY (TU3M)]	06.90- 12.96	CA3591R	14 50	04.91- 12.96	CS581	12	1.0
		06.90- 12.96	CA5331R	14 70	06.90- 12.96	CS542	12	1.4
					06.90- 03.91	CS390	12	0.9
	[KDZ (TU3M/Z)]	06.88- 05.90	CA5331R	14 70	06.88- 05.90	CS542	12	1.4
		AC 06.88- 05.90	CA3591R	14 50	06.88- 05.90	CS390	12	0.9
AX 14 1.4 4x4	[KDX (TU3M/Z)]	01.93- 12.96	CA3591R	14 50	01.93- 12.96	CS581	12	1.0
		01.93- 12.96	CA5331R	14 70				
	[KDY (TU3FM)]	06.90- 12.96	CA3591R	14 50	06.90- 12.96	CS581	12	1.0
		06.90- 12.96	CA5331R	14 70				
	[KDY (TU3M)]	06.90- 12.96	CA3591R	14 50	06.90- 12.96	CS581	12	1.0
		06.90- 12.96	CA5331R	14 70				
	[KDZ (TU3M/Z)]	06.88- 05.90	CA3591R	14 50	06.88- 05.90	CS581	12	1.0
		06.88- 05.90	CA5331R	14 70				
AX 14 1.4 GTi	[KFZ (TU3FJ2)]	06.91- 12.92	CA3591R	14 50	06.91- 12.92	CS390	12	0.9
		06.91- 12.92	CA5331R	14 70	06.91- 12.92	CS581	12	1.0
AX 14 1.4 i	[KFY (TU3FJ2)]	08.91- 12.96	CA3591R	14 50	08.91- 12.96	CS581	12	1.0
		08.91- 12.96	CA5331R	14 70				



**CITROEN** Continued

	[KFZ (TU3FJ2)]	06.91-12.96	CA359IR	14 50	06.91-12.96	CS581	12 1.0
		06.91-12.96	CA533IR	14 70	06.91-12.96	CS390	12 0.9
AX 14 1.4 Diesel	[K9A (TUD3)]	09.88-06.92	CA359IR	14 50	09.88-06.92	CS542	12 1.4
		09.88-06.92	CA533IR	14 70			
		09.88-06.92	CA618IR	14 70			
	[K9Y (TUD3Y)]	08.91-12.97	CA359IR	14 50	08.91-12.97	CS542	12 1.4
		08.91-12.97	CA533IR	14 70			
		08.91-12.97	CA618IR	14 70			
AX 15 1.5 Diesel	[VJY (TUD5)]	08.94-12.97	CA1038IR	14 70	08.94-12.97	CS542	12 1.4
		08.94-12.97	CA1203IR	14 80			
	[VJZ (TUD5)]	08.94-12.97	CA1038IR	14 70	08.94-12.97	CS542	12 1.4
		08.94-12.97	CA1203IR	14 80			
Berlingo 1.1 i	[HDZ (TU1M)]	01.01-	CA1641IR	14 80	07.96-11.02	CS581	12 1.0
		07.96-11.02	CA1243IR	14 90			
		07.96-11.02	CA1305IR	14 65			
		07.96-11.02	CA618IR	14 70			
		07.96-11.02	CA715IR	14 80			
	[HFX (TU1JP)]	06.00-11.02	CA1243IR	14 90	06.00-11.02	CS581	12 1.0
		06.00-11.02	CA715IR	14 80	06.00-11.02	CS390	12 0.9
		07.96-11.02	CA1640IR	14 70	06.00-11.02	CS1111	12 0.7
		07.96-11.02	CA1641IR	14 80			
Berlingo 1.4		11.02-10.05	CA1589IR	14 90	11.02-10.05	CS581	12 1.0
		11.02-10.05	CA1499IR	14 80			
		11.02-10.05	CA1498IR	14 70			
Berlingo 1.4 i	[KFW (TU3JP)]	06.00-11.02	CA1305IR	14 65	06.00-11.02	CS1111	12 0.7
		06.00-11.02	CA618IR	14 70	06.00-11.02	CS390	12 0.9
		06.00-11.02	CA715IR	14 80	06.00-11.02	CS581	12 1.0
	[KFX (TU3JP)]	07.96-11.02	CA1243IR	14 90	07.96-11.02	CS581	12 1.0
		07.96-11.02	CA1305IR	14 65	07.96-	CS390	12 0.9
		07.96-11.02	CA618IR	14 70			
		07.96-11.02	CA715IR	14 80			
Berlingo 1.4 Bivalent		11.02-	CA1589IR	14 90	11.02-	CS581	12 1.0
		11.02-	CA1499IR	14 80			
		11.02-	CA1498IR	14 70			
Berlingo 1.4 i Bivalent	[KFW (TU3JP)]	11.02-	CA1498IR	14 70	11.02-	CS581	12 1.0
		11.02-	CA1499IR	14 80	11.02-	CS390	12 0.9
		11.02-	CA1589IR	14 90			
Berlingo 1.4		05.05-	CA1589IR	14 90	05.05-	CS581	12 1.0
		05.05-	CA1499IR	14 80			
		05.05-	CA1498IR	14 70			
Berlingo 1.4 GNC		11.02-	CA1589IR	14 90	11.02-	CS581	12 1.0
		11.02-	CA1499IR	14 80			
		11.02-	CA1498IR	14 70			
Berlingo 1.6	[5FK (EP6C)]	07.10-	CA1954IR	14 120	07.10-	CS1417	12 0.9
		11.09-	CA1954IR	14 120	11.09-	CS1417	12 0.9
	[5FS (EP6C)]	11.09-03.10	CA2006IR	14 150			
		11.09-	CA2087IR*	14 80			
	[TU5JP4]	04.08-	CA1499IR	14 80	04.08-	CS390	12 0.9
		04.08-	CA1589IR	14 90	04.08-	CS581	12 1.0
		AC 04.08-	CA1741IR	14 120			
		AC 04.08-	CA1761IR	14 150			
	[TU5JP4B]	04.08-	CA1499IR	14 80	04.08-	CS390	12 0.9
		AC 04.08-	CA1741IR	14 120	04.08-	CS581	12 1.0
Berlingo 1.6 16V	[NFU (TU5JP4)]	10.00-11.02	CA1640IR	14 70	10.00-	CS1111	12 0.7
		10.00-11.02	CA1641IR	14 80	10.00-	CS581	12 1.0
		10.00-11.02	CA1642IR	14 97			
		11.02-	CA1498IR	14 70			
		11.02-	CA1499IR	14 80			
	11.02-	CA1589IR	14 90				
Berlingo 1.6 VTI	[5FK (EP6C)]	07.10-	CA1954IR	14 120	07.10-	CS1417	12 0.9
Berlingo 1.6 VTI 120		11.09-	CA2087IR*	14 80	11.09-	CS1417	12 0.9
		11.09-	CA2006IR	14 150			
		11.09-	CA1954IR	14 120			
Berlingo 1.6 HDi	[9HR (DV6C)]	07.10-	CA2030IR	14 180	07.10-	CS1391	12 2.2
		07.10-	CA2033IR	14 150	07.10-	CS1329	12 1.5
	[9HT(DV6BTED4)]	04.08-	CA1761IR	14 150	04.08-	CS1391	12 2.2
		04.08-	CA1920IR	14 180			
	[9HT(DV6BUTED4)]	04.08-	CA1761IR	14 150	04.08-	CS1391	12 2.2
		04.08-	CA1920IR	14 180			
	[9HX (DV6ATED4)]	04.08-	CA1761IR	14 150	04.08-	CS1391	12 2.2
		04.08-	CA1920IR	14 180			
	[DV6ATED4]	07.05-	CA1761IR	14 150	09.05-	CS1260	12 1.1
		07.05-	CA1920IR	14 180	07.05-	CS1391	12 2.2
		AC 09.05-	CA1761IR	14 150			
	[DV6B]	07.05-	CA1674IR	14 150	07.05-	CS566	12 1.1
		07.05-	CA1761IR	14 150	01.06-	CS1260	12 1.1
					07.05-	CS594	12 1.4
[DV6TED4]	08.05-	CA1761IR	14 150	08.05-	CS1391	12 2.2	
	08.05-	CA1920IR	14 180				
Berlingo 1.6 HDi 110		07.10-	CA2030IR	14 180	07.10-	CS1391	12 2.2
		07.10-	CA2033IR	14 150	07.10-	CS1329	12 1.5
Berlingo 1.6 HDi 90	[9HP (DV6BTED)]	07.10-	CA2030IR	14 180	07.10-	CS1329	12 1.5
		07.10-	CA2033IR	14 150	07.10-	CS1391	12 2.2
				07.10-	CS1260	12 1.1	
				07.10-	CS1329	12 1.5	
				07.10-	CS1391	12 2.2	
				07.10-	CS1260	12 1.1	
Berlingo 1.8 i	[LFX (XU7JB)]	05.97-11.02	CA1052IR	14 90	05.97-11.02	CS566	12 1.1
		05.97-11.02	CA1151IR	14 70	A13 05.97-11.02	CS715	12 1.4
		05.97-11.02	CA1152IR	14 80			
		05.97-11.02	CA1156IR	14 120			
Berlingo 1.8 i 4WD	[LFX (XU7JB)]	05.97-11.02	CA1052IR	14 90	05.97-11.02	CS566	12 1.1
		05.97-11.02	CA1151IR	14 70	05.97-11.02	CS715	12 1.4
		05.97-11.02	CA1152IR	14 80			
		AC 05.97-11.02	CA1156IR	14 120			
Berlingo 1.8 Diesel	[A9A (XUD7)]	07.96-11.02	CA1043IR	14 80	A13 07.96-11.02	CS712	12 2.2
		07.96-11.02	CA1065IR	14 95	07.96-11.02	CS1177	12 1.7
		07.96-11.02	CA1098IR	14 120	07.96-11.02	CS594	12 1.4
		07.96-11.02	CA1155IR	14 70			
		07.96-11.02	CA637IR	14 70			
		07.96-11.02	CA638IR	14 80			
		PS 07.96-	CA1043IR	14 80			
		PS 07.96-	CA1065IR	14 95			
		PS 07.96-	CA1155IR	14 70			



Berlino 1.9 Diesel	[D9B (XUD9A/L)]	07.96- 11.02	CA1043IR	14 80	07.96- 11.02	CS1177	12 1.7		
		07.96- 11.02	CA637IR	14 70					
		07.96- 11.02	CA638IR	14 80					
		PS 07.96- 11.02	CA1155IR	14 70					
		AC 07.96- 11.02	CA1065IR	14 95					
	AC 07.96- 11.02	CA1098IR	14 120						
	[DJY (XUD9A)]	07.96- 11.02	CA637IR	14 70		07.96- 11.02	CS594	12 1.4	
		07.96- 11.02	CA638IR	14 80					
		PS 07.96- 11.02	CA1155IR	14 70			A13 07.96- 11.02	CS712	12 2.2
		ACPS 07.96- 11.02	CA1043IR	14 80					
		AC 07.96- 11.02	CA1065IR	14 95					
	AC 07.96- 11.02	CA1098IR	14 120						
	[WJY (DW8B)]	09.00- 11.02	CA1442IR	14 70		09.00- 11.02	CS594	12 1.4	
		ACPS 09.00- 11.02	CA1496IR	14 80					
		ACPS 09.00- 11.02	CA1564IR	14 90			09.00- 11.02	CS1177	12 1.7
	ACPS 09.00- 11.02	CA1646IR	14 120						
	[WJZ (DW8)]	07.98- 11.02	CA1442IR	14 70		07.98- 11.02	CS594	12 1.4	
PS 04.99- 11.02		CA1496IR	14 80						
PS 04.99- 11.02		CA1564IR	14 90						
PS 04.99- 11.02		CA1646IR	14 120						
ACPS 07.98- 11.02		CA1496IR	14 80						
ACPS 07.98- 11.02		CA1564IR	14 90						
ACPS 07.98- 11.02		CA1646IR	14 120						
Berlino 1.9 Diesel 4WD	[WJZ (DW8)]	07.98- 11.02	CA1442IR	14 70	07.98- 11.02	CS1177	12 1.7		
		07.98- 11.02	CA1496IR	14 80					
		07.98- 11.02	CA1564IR	14 90		CS594	12 1.4		
		07.98- 11.02	CA1646IR	14 120					
Berlino 2.0 HDi	[RHY (DW10TD)]	12.02- 11.02	CA1850IR	14 150	12.99- 11.02	CS594	12 1.4		
		12.99- 11.02	CA1509IR	14 150					
		12.99- 11.02	CA1564IR	14 90		CS1177	12 1.7		
		12.99- 11.02	CA1646IR	14 120					
12.99- 11.02	CA1674IR	14 150							
Berlino 2.0 HDi 4WD	[RHY (DW10TD)]	11.00- 11.02	CA1674IR	14 150	12.99- 11.02	CS1177	12 1.7		
		12.99- 11.02	CA1442IR	14 70					
		12.99- 11.02	CA1496IR	14 80		12.99- 11.02	CS594	12 1.4	
		12.99- 11.02	CA1509IR	14 150					
		12.99- 11.02	CA1564IR	14 90		12.99- 11.02	CS712	12 2.2	
		12.99- 11.02	CA1646IR	14 120					
BX 1.4	[150C]	01.87- 01.92	CA2911R	14 50	01.87- 01.92	CS142	12 0.85		
		01.87- 01.92	CA2911R	14 50					
BX 1.6	[B6D]	01.87- 01.92	CA2941R	14 50	01.87- 01.92	CS326	12 0.85		
BX 1.9 Diesel		01.87- 01.92	CA2941R	14 50					
BX 11 1.1	[XW7B]	10.86- 06.88	CA2911R	14 50	10.86- 06.88	CS355	12 0.85		
		07.88- 06.92	CA3591R	14 50					
BX 11	[HDZ (TU1M)]	10.88- 06.92	CA3591R	14 50	10.88- 06.92	CS581	12 1.0		
BX 14 1.4	[150A]	10.82- 06.88	CA2911R	14 50					
					10.82- 10.84	CS142	12 0.85		
					11.84- 06.88	CS355	12 0.85		
	[150C]	04.83- 07.88	CA2911R	14 50	11.84- 04.88	CS355	12 0.85		
		07.88- 02.93	CA3591R	14 50					
		07.88- 02.93	CA5331R	14 70					
					04.88- 02.93	CS390	12 0.9		
	[150F]	09.85- 07.88	CA2911R	14 50	09.85- 04.88	CS355	12 0.85		
		07.88- 02.93	CA3591R	14 50					
		07.88- 02.93	CA5331R	14 70					
					04.88- 02.93	CS390	12 0.9		
	[K1H (TU3A)]	01.89- 12.89	CA2941R	14 50	01.89- 12.89	CS390	12 0.9		
		01.89- 12.89	CA3591R	14 50					
		01.89- 12.89	CA5331R	14 70					
	[KDY (TU3M)]	01.89- 02.93	CA3591R	14 50	01.89- 09.93	CS390	12 0.9		
		01.89- 02.93	CA5331R	14 70					
	[KDZ (TU3M/Z)]	01.89- 02.93	CA3591R	14 50	01.89- 02.93	CS390	12 0.9		
		01.89- 02.93	CA5331R	14 70					
BX 15 1.6	[B1E (XU51C)]	10.87- 05.92	CA2941R	14 50	10.87- 05.92	CS326	12 0.85		
		10.87- 05.92	CA5321R	14 80					
BX 16 1.6	[171A]	10.82- 06.88	CA2941R	14 50	10.82- 06.88	CS326	12 0.85		
		10.82- 06.88	CA5321R	14 80					
		06.85- 06.88	CA3801R	14 70		06.85- 06.88	CS566	12 1.1	
	[171B]	10.82- 06.88	CA2941R	14 50	10.82- 06.88	CS326	12 0.85		
		10.82- 06.88	CA5321R	14 80					
		06.85- 06.88	CA3801R	14 70		06.85- 06.88	CS566	12 1.1	
	[171C]	07.84- 06.88	CA2941R	14 50	06.85- 06.88	CS566	12 1.1		
		07.84- 06.88	CA5321R	14 80					
		06.85- 06.88	CA3801R	14 70		07.84- 06.88	CS326	12 0.85	
	[171D]	07.85- 12.94	CA2941R	14 50	07.85- 12.94	CS326	12 0.85		
		07.85- 12.94	CA5321R	14 80					
	[180Z]	03.86- 12.94	CA2941R	14 50	03.86- 12.94	CS326	12 0.85		
		03.86- 12.94	CA5321R	14 80					
	[B1A (XU52C/K)]	09.87- 02.93	CA2941R	14 50	09.87- 02.93	CS326	12 0.85		
		09.87- 02.93	CA5321R	14 80					
	[B1E (XU51C)]	09.87- 12.94	CA2941R	14 50	09.87- 12.94	CS326	12 0.85		
		09.87- 12.94	CA5321R	14 80					
	[BAY (XU5CP)]	07.86- 02.93	CA2941R	14 50	07.86- 02.93	CS326	12 0.85		
A13 07.86- 02.93		CA5321R	14 80						
[BAZ (XU5CP)]	07.86- 03.91	CA2941R	14 50	07.86- 03.91	CS566	12 1.1			
	A13 07.86- 03.91	CA5321R	14 80						
[BDY (XU5M)]	05.89- 12.94	CA2941R	14 50	05.89- 12.94	CS326	12 0.85			
	05.89- 12.94	CA5321R	14 80						
[BDZ (XU5M)]	05.89- 03.91	CA2941R	14 50	05.89- 03.91	CS326	12 0.85			
	05.89- 03.91	CA5321R	14 80						
[XU52C]	10.82- 08.84	CA2941R	14 50	10.82- 08.84	CS326	12 0.85			
	10.82- 08.84	CA5321R	14 80						
BX 16 1.9	[BAY (XU5CP)]	07.86- 12.94	CA2941R	14 50	07.86- 12.94	CS326	12 0.85		
		07.86- 12.94	CA5321R	14 80					
	[BAZ (XU5CP)]	07.86- 12.94	CA2941R	14 50					
		07.86- 12.94	CA5321R	14 80	07.86- 12.94	CS373	12 1.7		
BX 17 1.7 TD	[A8A (XUD7TE)]	03.88- 12.94	CA5251R	14 50	A13 03.88- 12.94	CS570	12 3.1		
		03.88- 12.94	CA5831R	14 80					
BX 17 1.8 Diesel	[161 (XUD7)]	10.85- 09.93	CA2941R	14 50	10.85- 09.93	CS342#	12 1.5		
		10.85- 09.93	CA5321R	14 80					
	[161A (XUD7)]	10.85- 09.93	CA2941R	14 50		10.85- 09.93	CS373	12 1.7	
		10.85- 09.93	CA5321R	14 80					
BX 17 1.8 TD	[AJZ (XUD7TE)]	03.88- 12.94	CA5251R	14 50	A13 03.88- 12.94	CS570	12 3.1		
		03.88- 12.94	CA5831R	14 80					
BX 19 1.8 Turbo TRD	[AJZ (XUD7TE)]				A13 03.88- 04.91	CS570	12 3.1		
								02.88- 12.94	CS373

**CITROEN Continued**

BX 19 1.9	[159A]	07.86-05.89 CA294IR	14 50	07.86-05.89 CS326	12 0.85		
		07.86-05.89 CA532IR	14 80				
	[D2A (XU92C)]	07.86-12.94 CA294IR	14 50			07.86-12.94 CS326	12 0.85
		07.86-12.94 CA532IR	14 80			07.86-05.89 CS566	12 1.1
	[D2C (XU92C)]	09.86-12.89 CA294IR	14 50			09.86-12.89 CS326	12 0.85
		09.86-12.89 CA532IR	14 80				
	[DDZ (XU9M)]	06.88-12.94 CA294IR	14 50			06.88-12.94 CS326	12 0.85
	06.88-12.94 CA532IR	14 80					
BX 19 1.9 4x4	[DFZ (XU9J1)]	07.86-12.94 CA294IR	14 50	07.86-12.94 CS326	12 0.85		
		07.86-12.94 CA532IR	14 80				
	[DKZ (XU9JA)]	06.88-12.94 CA294IR	14 50			06.88-12.94 CS326	12 0.85
	06.88-12.94 CA532IR	14 80					
BX 19 1.9 4x4	[D2F]	04.89-02.93 CA294IR	14 50	04.89-02.93 CS373	12 1.7		
		04.89-02.93 CA532IR	14 80				
	[DDZ (XU9M)]	10.90-05.91 CA294IR	14 50			10.90-05.91 CS326	12 0.85
	10.90-05.91 CA532IR	14 80	A13 10.90-05.91 CS373	12 1.7			
BX 19 1.9 GTi 4x4	[DKZ (XU9JA)]	06.88-02.93 CA294IR	14 50	06.88-02.93 CS566	12 1.1		
	06.88-02.93 CA532IR	14 80					
BX 19 1.9 GTi 16V	[D6C (XU9J4)]	09.87-12.88 CA294IR	14 50	09.87-12.88 CS326	12 0.85		
		09.87-12.88 CA532IR	14 80				
	[DFW (XU9J4)]	03.88-02.93 CA294IR	14 50			03.88-02.93 CS326	12 0.85
	03.88-02.93 CA532IR	14 80					
BX 19 1.9 GTi	[D6A (XU9J2)]	07.86-02.93 CA294IR	14 50	07.86-02.93 CS566	12 1.1		
		07.86-02.93 CA532IR	14 80				
BX 19 1.9 Diesel	[162 (XUD9)]	09.83-12.87 CA294IR	14 50	09.85-12.87 CS373	12 1.7		
		09.83-12.87 CA532IR	14 80			A13 09.83-12.87 CS570	12 3.1
						09.83-08.95 CS342#	12 1.5
	[D9A (XUD9)]	09.83-12.87 CA294IR	14 50			09.85-12.87 CS373	12 1.7
		09.83-12.87 CA532IR	14 80			A13 09.83-12.87 CS570	12 3.1
						09.83-08.85 CS342#	12 1.5
	[D9B (XUD9A/U)]	03.87-12.94 CA294IR	14 50			03.87-12.94 CS373	12 1.7
	03.87-12.94 CA532IR	14 80	A13 03.87-12.94 CS570	12 3.1			
BX 19 1.9 Turbo TRD	[A8A (XUD7TE)]			A13 03.88-04.91 CS570	12 3.1		
				03.88-12.94 CS373	12 1.7		
C1 1.0	[CFA(384F)]	06.05- CA1949IR	14 80	06.05- CS1407	12 1.1		
		06.05- CA1978IR	14 70				
C1 1.4 HDi	[DV4D]	06.05- CA1674IR	14 150	06.05- CS1329	12 1.5		
		06.05- CA1850IR	14 150			06.05- CS1260	12 1.1
C15 1.0	[TU9]	05.88-06.95 CA359IR	14 50	05.88-06.95 CS390	12 0.9		
	[XV8]	05.88-06.95 CA359IR	14 50			05.88-06.95 CS390	12 0.9
C15 1.1		08.88-07.96 CA533IR	14 70	08.88-07.96 CS390	12 0.9		
		08.88-07.96 CA359IR	14 50				
	[109K]	10.84-07.87 CA291IR	14 50			10.84-07.87 CS355	12 0.85
			10.84-07.87 CS142	12 0.85			
	[E1A (TU1)]	10.84-07.88 CA369IR	14 50	10.84-07.88 CS306	12 1.05		
C15 1.1 i.e.	[HDZ (TU1M)]	07.88-12.96 CA359IR	14 50	07.88-12.96 CS390	12 0.9		
		07.88-12.96 CA533IR	14 70				
C15 1.3	[G1A]	07.87-05.88 CA359IR	14 50	07.87-05.88 CS306	12 1.05		
C15 1.4	[K1H (TU3A)]	07.87-12.96 CA359IR	14 50	07.87-12.96 CS390	12 0.9		
		07.87-12.96 CA533IR	14 70				
		05.87-10.92 CA533IR	14 70			05.87-07.96 CS390	12 0.9
		05.87-10.92 CA359IR	14 50				
C15 1.4 E	[150D (XY7)]	07.86-07.87 CA291IR	14 50	07.86-07.87 CS390	12 0.9		
C15 1.4 i	[K3A]	07.87-12.96 CA359IR	14 50	07.87-12.96 CS390	12 0.9		
		07.87-12.96 CA533IR	14 70				
C15 1.4 i.e.	[KDY (TU3FM)]	05.91- CA359IR	14 50	05.91- CS390	12 0.9		
		05.91- CA533IR	14 70				
	[KDY (TU3M)]	05.91- CA359IR	14 50			05.91- CS390	12 0.9
	05.91- CA533IR	14 70					
C15 1.8 Diesel	[161A (XUD7)]	07.86-08.00 CA294IR	14 50	07.86-08.00 CS373	12 1.7		
		07.86-08.00 CA380IR	14 70				
C15 1.9 Diesel		12.00-12.05 CA1496IR	14 80	12.00-12.05 CS1177	12 1.7		
		12.00-12.05 CA1442IR	14 70			12.00-12.05 CS594	12 1.4
C2 1.1	[HFX (TU1JP)]	09.03- CA1665IR	14 80	06.03- CS1111	12 0.7		
		09.03- CA1681IR	14 90			06.03- CS581	12 1.0
		09.03- CA1687IR	14 70			06.03- CS390	12 0.9
		09.03- CA1832IR	14 60				
C2 1.4	[KfV (TU3JP)]	09.03- CA1665IR	14 80	06.03- CS1111	12 0.7		
		09.03- CA1681IR	14 90			06.03- CS581	12 1.0
		09.03- CA1687IR	14 70			06.03- CS390	12 0.9
		09.03- CA1832IR	14 60				
C2 1.4 16V	[KfU (ET3J4)]	06.06- CA1665IR	14 80	06.06- CS390	12 0.9		
		06.06- CA1687IR	14 70			06.06- CS581	12 1.0
C2 1.4 HDi	[8HX (DV4TD)]	09.03- CA1674IR	14 150	09.03- CS1329	12 1.5		
		09.03- CA1761IR	14 150			06.03- CS1260	12 1.1
		09.03- CA1850IR	14 150				
		04.09- CA1671IR	14 85				
C2 1.6	[NFU (TU5JP4)]	09.03- CA1665IR	14 80	06.03- CS390	12 0.9		
		09.03- CA1681IR	14 90			06.03- CS1111	12 0.7
		09.03- CA1687IR	14 70			06.03- CS581	12 1.0
		09.03- CA1832IR	14 60				
C2 1.6 VTS	[NFS (TU5JP4S)]	10.04- CA1665IR	14 80	10.04- CS581	12 1.0		
C2 1.6 HDi	[DV6TED4]	09.05- CA1761IR	14 150	09.05- CS1391	12 2.2		
C25 1.9 Diesel	[D9B (XUD9A/U)]	07.87-02.94 CA294IR	14 50	07.87-02.94 CS373	12 1.7		
C25 1.9 DT		10.91-01.94 CA316IR	14 55	10.91-01.94 CS554	12 2.2		
		10.91-01.94 CA355IR	14 65				
		10.91-01.94 CA642IR	14 55				
C25 1.9 TD	[M705]	04.92- CA316IR	14 55	04.92-02.94 CS554	12 2.2		
		04.92-02.94 CA355IR	14 65				
		04.92-02.94 CA642IR	14 55				
C25 2.0	[170A (XN1T)]	09.81-03.94 CA150IR	14 50	09.81-03.94 CS352	12 0.85		
		09.81-02.94 CA229IR	14 70				
		09.81-03.94 CA377IR	14 70				
	[170B (XN1T)]	09.81-03.94 CA150IR	14 50			09.81-03.94 CS352	12 0.85
		09.81-03.94 CA229IR	14 70				
		09.81-03.94 CA377IR	14 70				
	[170C (XN1T)]	02.91-03.94 CA150IR	14 50			02.91-03.94 CS352	12 0.85
	02.91-03.94 CA229IR	14 70	02.91-03.94 CS129	12 0.9			
	02.91-03.94 CA377IR	14 70					
C25 2.5 Diesel	[CRD93L]	07.81-02.94 CA175IR	14 70	07.81-02.94 CS382	12 2.8		
						07.81-02.94 CS361	12 2.2
C25 2.5 Diesel 4x4	[CRD93L]	01.87-02.94 CA175IR	14 70	01.87-02.94 CS373	12 1.7		
		01.87-02.94 CA735IR	14 75			01.87-02.94 CS361	12 2.2
						01.87-02.94 CS342#	12 1.5





C25 2.5 TD	[CRD93LS]	08.87- 02.94	CA735IR	14 75	08.87- 02.94	CS361	12 2.2
C25 2.5 TD 4x4	[CRD93LS]	08.87- 02.94	CA735IR	14 75	08.87- 02.94	CS361	12 2.2
C25 E 1.8	[169 (XM7T)]	10.81- 02.94	CA150IR	14 50	10.81- 02.94	CS352	12 0.85
		10.81- 02.94	CA377IR	14 70			
C3 1.1 i	[HFX (TU1JP)]	02.02-	CA1665IR	14 80	02.02-	CS1111	12 0.7
		02.02-	CA1681IR	14 90	02.02-	CS390	12 0.9
		02.02-	CA1687IR	14 70	02.02-	CS581	12 1.0
		02.02-	CA1832IR	14 60			
C3 1.4	[KFT(TU3AE5)] [KFV (TU3JP)]	11.09-	CA2015IR	14 120	11.09-	CS581	12 1.0
		05.03-	CA1665IR	14 80	05.03-	CS1111	12 0.7
		05.03-	CA1681IR	14 90	05.03-	CS390	12 0.9
		05.03-	CA1687IR	14 70	05.03-	CS581	12 1.0
C3 1.4 Picasso	[EP3]	02.09-	CA1990IR*	14 120	02.09-	CS1417	12 0.9
		02.09-	CA2087IR*	14 80			
		AC 02.09-	CA1954IR	14 120			
C3 1.4 16V	[8FR (EP3C)]	11.09-	CA2087IR*	14 80	11.09-	CS1417	12 0.9
		AC 11.09-	CA1954IR	14 120			
		AC 11.09-	CA1990IR*	14 120			
	[KFU (ET3J4)]	12.03-	CA1665IR	14 80	12.03-	CS581	12 1.0
		12.03-	CA1681IR	14 90	12.03-	CS1111	12 0.7
		12.03-	CA1687IR	14 70			
12.03-		CA1832IR	14 60				
C3 1.4 i Bivalent	[KFV (TU3JP)]	02.02-	CA1665IR	14 80	02.02-	CS1111	12 0.7
		02.02-	CA1681IR	14 90	02.02-	CS390	12 0.9
		02.02-	CA1687IR	14 70	02.02-	CS581	12 1.0
		02.02-	CA1832IR	14 60			
C3 1.4 i	[KFV (TU3JP)]	02.02- 09.07	CA1665IR	14 80	02.02- 09.07	CS581	12 1.0
					02.02- 09.07	CS390	12 0.9
C3 1.4 HDi 16V	[8HY]	02.02- 08.05	CA1674IR	14 150	02.02- 08.05	CS1329	12 1.5
					02.02- 08.05	CS1260	12 1.1
C3 1.4 HDi	[8HX]	02.02- 08.05	CA1674IR	14 150	02.02- 08.05	CS1329	12 1.5
					02.02- 08.05	CS1260	12 1.1
	[8HX (DV4TD)]	04.04-	CA1674IR	14 150	04.04-	CS1329	12 1.5
		04.04-	CA1761IR	14 150	04.04-	CS1260	12 1.1
	[8HZ (DV4TD)]	11.09-	CA2008IR	14 150	11.09-	CS1329	12 1.5
C3 1.6	[NFU (TU5JP4)]	05.03-	CA1665IR	14 80	05.03-	CS581	12 1.0
		05.03-	CA1681IR	14 90	05.03-	CS1111	12 0.7
		05.03-	CA1687IR	14 70			
C3 1.6 Picasso	[EP6]	02.09-	CA1954IR	14 120	02.09-	CS1417	12 0.9
		02.09-	CA1990IR*	14 120			
C3 1.6 16V	[5FS (EP6C)]	11.09-	CA1954IR	14 120	11.09-	CS1417	12 0.9
		11.09-	CA1990IR*	14 120			
		11.09-	CA2087IR*	14 80			
	[NFU (TU5JP4)]	02.02-	CA1665IR	14 80	02.02-	CS581	12 1.0
		02.02-	CA1681IR	14 90	02.02-	CS1111	12 0.7
		02.02-	CA1687IR	14 70			
		02.02-	CA1832IR	14 60			
C3 1.6 HDi 16V	[9HX (DV6ATED4)]	10.05-	CA1761IR	14 150	10.05-	CS1260	12 1.1
					10.05-	CS1329	12 1.5
					10.05-	CS1391	12 2.2
	[9HZ (DV6TED4)]	09.05-	CA1761IR	14 150	09.05-	CS1391	12 2.2
				09.05-	CS1329	12 1.5	
C3 1.6 HDi	[9HX (DV6ATED4)]	10.05-	CA1761IR	14 150	10.05-	CS1260	12 1.1
		11.09-	CA2008IR	14 150	10.05-	CS1391	12 2.2
C3 1.6 HDi Picasso	[9HP (DV6DTE4)]	07.10-	CA2033IR	14 150	07.10-	CS1260	12 1.1
	[9HZ (DV6TED4)]	02.09-	CA1761IR	14 150	02.09-	CS1391	12 2.2
				02.09-	CS1329	12 1.5	
C3 1.6 HDi Picasso 110	[9HR (DV6C)]				05.10-	CS1329	12 1.5
C4 1.4	[8FP (EP3C)]	11.09-	CA1954IR	14 120	11.09-	CS1417	12 0.9
C4 1.4 16V	[KFU (ET3J4)]	11.04-	CA1665IR	14 80	11.04-	CS1111	12 0.7
		AC 11.04-	CA1741IR	14 120	11.04-	CS581	12 1.0
C4 1.6 Grand Picasso	[EP6DT]	07.08-	CA1954IR	14 120	07.08-	CS1417	12 0.9
		07.08-	CA1990IR*	14 120			
C4 1.6 Picasso	[EP6DT]	07.08-	CA1954IR	14 120	07.08-	CS1417	12 0.9
		07.08-	CA1990IR*	14 120			
C4 1.6 Picasso THP 155	[5FV (EP6CDT)]	09.10-	CA836IR	14 120	09.10-	CS1417	12 0.9
C4 1.6 THP 140	[EP6DT]	07.08-	CA1954IR	14 120	07.08-	CS1417	12 0.9
		07.08-	CA1990IR*	14 120			
		07.08-	CA2006IR	14 150			
C4 1.6 THP 150	[EP6DT]	07.08-	CA1954IR	14 120	07.08-	CS1417	12 0.9
		07.08-	CA1990IR*	14 120			
		07.08-	CA2006IR	14 150			
C4 1.6 16V Bio-Flex Bio-Flex	[TU5JP4]	09.07-	CA1665IR	14 80	09.07-	CS390	12 0.9
		09.07-	CA1741IR	14 120	09.07-	CS581	12 1.0
C4 1.6 16V	[5FS (EP6C)]	11.09-	CA1954IR	14 120	11.09-	CS1417	12 0.9
	[5FV (EP6CDT)]	11.09-	CA1954IR	14 120	11.09-	CS1417	12 0.9
	[NFU (TU5JP4)]	11.04-	CA1665IR	14 80	11.04-	CS1111	12 0.7
		07.06-	CA1741IR	14 120	11.04-	CS581	12 1.0
		AC 11.04-	CA1741IR	14 120			
C4 1.6 16V Grand Picasso	[EP6DT]	10.08-	CA1954IR	14 120	10.08-	CS1417	12 0.9
C4 1.6 16V Picasso	[5FX (EP6DT)]	07.08-	CA1954IR	14 120	07.08-	CS1417	12 0.9
C4 1.6 VTI	[EP6]	07.08-	CA1954IR	14 120	07.08-	CS1417	12 0.9
		07.08-	CA1990IR*	14 120			
C4 1.6 VTI Grand Picasso	[EP6]	07.08-	CA1954IR	14 120	07.08-	CS1417	12 0.9
		07.08-	CA1990IR*	14 120			
C4 1.6 VTI Picasso	[EP6]	07.08-	CA1954IR	14 120	07.08-	CS1417	12 0.9
		07.08-	CA1990IR*	14 120			
C4 1.6 HDi	[9HP (DV6DTE4)]	11.09-	CA2030IR	14 180	11.09-	CS1260	12 1.1
		11.09-	CA2033IR	14 150	11.09-	CS1391	12 2.2
				11.09-	CS1329	12 1.5	
				11.09-	CS1260	12 1.1	
	[9HX (DV6ATED4)]	11.04-	CA1761IR	14 150	11.04-	CS1329	12 1.5
					11.04-	CS1260	12 1.1
				11.04-	CS1391	12 2.2	
	[9HY (DV6ATED4)]	11.04-	CA1761IR	14 150	11.04-	CS1391	12 2.2
				11.04-	CS1260	12 1.1	
				11.04-	CS1329	12 1.5	
	[9HY (DV6TED4)]	11.04-	CA1761IR	14 150	11.04-	CS1391	12 2.2
				11.04-	CS1260	12 1.1	
				11.04-	CS1329	12 1.5	
	[9HZ (DV6ATED4)]	11.04-	CA1761IR	14 150	11.04-	CS1391	12 2.2
			11.04-	CS1260	12 1.1		
			11.04-	CS1329	12 1.5		



**CITROEN** *Continued*

	[9HZ (DV6TED4)]	11.04-	CA1761IR	14 150		11.04- 11.04- 11.04-	CS1391 CS1260 CS1329	12 2.2 12 1.1 12 1.5
C4 1.6 HDi Grand Picasso	[9HY (DV6TED4)]	10.06- 10.06-	CA1761IR CA1920IR	14 150 14 180		10.06-	CS1329	12 1.5
	[9HZ (DV6TED4)]	10.06- 10.06-	CA1761IR CA1920IR	14 150 14 180		10.06-	CS1329	12 1.5
C4 1.6 HDi Picasso	[9HY (DV6TED4)]	02.07- 02.07- 02.07-	CA1741IR CA1761IR CA1920IR	14 120 14 150 14 180		02.07- 02.07-	CS1329 CS1391	12 1.5 12 2.2
	[9HZ (DV6TED4)]	02.07- 02.07- 02.07-	CA1741IR CA1761IR CA1920IR	14 120 14 150 14 180		02.07- 02.07-	CS1329 CS1391	12 1.5 12 2.2
C4 1.6 HDi Picasso 110	[9HL (DV6C)]	09.10- 09.10-	CA2030IR CA2033IR	14 180 14 150		09.10- 09.10-	CS1391 CS1329	12 2.2 12 1.5
	[9HR (DV6C)]	09.10- 09.10-	CA2030IR CA2033IR	14 180 14 150		09.10- 09.10-	CS1329 CS1391	12 1.5 12 2.2
C4 1.8 16V Picasso	[6FY (EW7A)]	02.07- 02.07-	CA1914IR CA2015IR	14 150 14 120		02.07- 02.07- 02.07-	CS1277 CS566 CS1244 CS594	12 1.4 12 1.1 12 1.1 12 1.4
C4 1.8 i 16V Grand Picasso	[6FY (EW7A)]	10.06- 10.06-	CA1914IR CA2015IR	14 150 14 120		10.06- 10.06-	CS594 CS1244	12 1.4 12 1.1
C4 2.0 16V	[EW10J4S]	11.04-	CA1674IR	14 150		11.04- 11.04- 11.04-	CS566 CS1244 CS594	12 1.1 12 1.1 12 1.4
	[RFJ (EW10A)]	11.04- 11.04- 07.06-	CA1914IR CA2015IR CA1761IR	14 150 14 120 14 150		11.04- 07.06- 11.04-	CS1244 CS1277 CS594	12 1.1 12 1.4 12 1.4
	[RFK (EW10J4S)]	11.04-	CA1674IR	14 150		11.04- 11.04- 11.04- 11.04-	CS1177 CS1244 CS1277 CS594	12 1.7 12 1.1 12 1.4 12 1.4
	[RFN (EW10J4)]	11.04- 11.04-	CA1499IR CA1741IR	14 80 14 120		11.04- 11.04- 11.04- 11.04-	CS594 CS1244 CS1177 CS1277	12 1.4 12 1.1 12 1.7 12 1.4
C4 2.0 16V Picasso	[RFJ (EW10A)]	02.07- 02.07-	CA1914IR CA2015IR	14 150 14 120		02.07- 02.07- 02.07- 02.07-	CS1277 CS566 CS1244 CS594	12 1.4 12 1.1 12 1.1 12 1.4
C4 2.0 i 16V Grand Picasso	[RFJ (EW10A)]	10.06- 10.06-	CA1914IR CA2015IR	14 150 14 120		10.06- 10.06-	CS594 CS1244	12 1.4 12 1.1
C4 2.0 HDi	[DW10BTED4]	07.08- 07.08-	CA1761IR CA1920IR	14 150 14 180		07.08- AT 07.08- 07.08-	CS1177 CS1416 CS1342	12 1.7 12 2.5 12 1.9
	[RHE (DW10CTED4) DTR]	11.09- 11.09-	CA2030IR CA2033IR	14 180 14 150		11.09- 11.09-	CS1342 CS594	12 1.9 12 1.4
	[RHR (DW10BTED4)]	11.04- 11.04-	CA1761IR CA1920IR	14 150 14 180		11.04- 11.04- 11.04- 11.04-	CS712 CS1342 CS1177 CS594	12 2.2 12 1.9 12 1.7 12 1.4
C4 2.0 HDi Grand Picasso	[RHE (DW10CTED4)]	07.09- 07.09-	CA2030IR CA2033IR	14 180 14 150		07.09- 07.09- 07.09- 07.09-	CS594 CS373 CS1177 CS1342	12 1.4 12 1.7 12 1.7 12 1.9
	[RHJ (DW10BTED4)]	10.06- 10.06-	CA1761IR CA1920IR	14 150 14 180		10.06- 10.06-	CS373 CS1177	12 1.7 12 1.7
	[RHR (DW10BTED4)]	10.06- 10.06-	CA1761IR CA1920IR	14 150 14 180		10.06- 10.06-	CS1177 CS373	12 1.7 12 1.7
C4 2.0 HDi Picasso	[RHE (DW10CTED4)]	07.09- 07.09-	CA2030IR CA2033IR	14 180 14 150		07.09- 07.09- 07.09- 07.09- 07.09-	CS1342 CS594 CS1177 CS342# CS373	12 1.9 12 1.4 12 1.7 12 1.5 12 1.7
	[RHJ (DW10BTED4)]	02.07- 02.07-	CA1761IR CA1920IR	14 150 14 180		02.07- AT 02.07-	CS1342 CS1416	12 1.9 12 2.5
	[RHR (DW10BTED4)]	02.07- 02.07-	CA1761IR CA1920IR	14 150 14 180		02.07- AT 02.07-	CS1342 CS1416	12 1.9 12 2.5
C4 2.0 HDi Picasso 165	[RHH (DW10CTED4)]	09.10- 09.10-	CA2030IR CA2033IR	14 180 14 150		09.10- 09.10- 09.10-	CS1342 CS1416 CS594	12 1.9 12 2.5 12 1.4
C5 1.6 16V X7	[5FV (EP6CDT)]	04.09- 04.09- 04.09-	CA1954IR CA1990IR* CA2006IR	14 120 14 120 14 150		04.09-	CS1417	12 0.9
C5 1.6 VTi	[5FS (EP6C)]	07.10-	CA1954IR	14 120		07.10-	CS1417	12 0.9
C5 1.6 HDi	[9HL (DV6C)]	07.10- 07.10-	CA2030IR CA2033IR	14 180 14 150		07.10- 07.10-	CS1391 CS1329	12 2.2 12 1.5
	[9HR (DV6C)]	07.10- 07.10-	CA2030IR CA2033IR	14 180 14 150		07.10- 07.10-	CS1329 CS1391	12 1.5 12 2.2
	[9HY (DV6TED4)]	09.04-	CA1761IR	14 150		09.04- 09.04- 09.04-	CS1329 CS1260 CS1391	12 1.5 12 1.1 12 2.2
	[9HZ (DV6TED4)]	02.08- 02.08-	CA1761IR CA1920IR	14 150 14 180		02.08- 02.08-	CS1329	12 1.5
	[DV6TED4]	02.08- 02.08-	CA1761IR CA1920IR	14 150 14 180		02.08-	CS1329	12 1.5
C5 1.8 16V	[6FY (EW7A)]	09.05- 09.05-	CA1914IR CA2015IR	14 150 14 120		09.05- 02.08- 09.05- 09.05-	CS594 CS1277 CS1244 CS566	12 1.4 12 1.4 12 1.1 12 1.1
C5 1.8 16V X4	[6FZ (EW7J4)]	03.01- 09.04 03.01- 09.04 03.01- 09.04 03.01- 09.04	CA1499IR CA1589IR CA1674IR CA1741IR	14 80 14 90 14 150 14 120		03.01- 09.04 03.01- 09.04	CS1277 CS1244	12 1.4 12 1.1
C5 1.8 16V X7	[6FZ (EW7J4)]	10.04- 10.04- 10.04- 10.04-	CA1499IR CA1589IR CA1674IR CA1741IR	14 80 14 90 14 150 14 120		10.04- 10.04-	CS1244 CS1277	12 1.1 12 1.4
C5 2.0 16V Turbo	[RFN (EW10J4)]	06.01- 08.04	CA1589IR	14 90		06.01- 08.04	CS1277	12 1.4
C5 2.0 16V	[RFJ (EW10A)]	09.04-	CA1914IR	14 150		09.04-	CS1277	12 1.4
	[RFK (EW10J4S)]	09.04-	CA2015IR	14 120		09.04-	CS1244	12 1.1
	[RFN (EW10J4)]	03.01- 08.04	CA1589IR	14 90		03.01- 08.04	CS1277	12 1.4



C5 2.0 HPI 16V	[RLZ (EW10D)]	03.01- 08.04	CA1589IR	14 90	06.01- 08.04	CS1277	12 1.4
					03.01- 08.04	CS1244	12 1.1
C5 2.0 16V Bio-Flex BioFlex	[RFJ (EW10A)]	02.08-	CA1914IR	14 150	02.08-	CS1244	12 1.1
C5 2.0 HDi	[DW10BTED4]	02.08-	CA1761IR	14 150	AT 02.08-	CS1416	12 2.5
		02.08-	CA1920IR	14 180	02.08-	CS1342	12 1.9
					02.08-	CS1177	12 1.7
					02.08-	CS342#	12 1.5
					02.08-	CS373	12 1.7
					02.08-	CS594	12 1.4
	[RHR (DW10BTED4)]	09.04- 09.04-	CA1761IR	14 150	09.04-	CS1342	12 1.9
			CA1920IR	14 180	09.04-	CS594	12 1.4
					09.04-	CS1177	12 1.7
	[RHS (DW10ATED4)]	06.01- 08.04 06.01- 08.04	CA1509IR	14 150	06.01- 08.04	CS1177	12 1.7
			CA1564IR	14 90	06.01- 08.04	CS1326	12 2.3
	[RHY (DW10TD)]	03.01- 09.04 03.01- 09.04	CA1509IR	14 150	03.01- 09.04	CS1177	12 1.7
			CA1564IR	14 90	03.01- 09.04	CS594	12 1.4
			CA1646IR	14 120	03.01- 09.04	CS1326	12 2.3
	[RHZ (DW10ATED)]	03.01- 08.04 03.01- 08.04	CA1509IR	14 150	03.01- 08.04	CS1326	12 2.3
			CA1564IR	14 90	03.01- 08.04	CS594	12 1.4
					03.01- 08.04	CS1177	12 1.7
	[RHZ (DW10ATED4)]	06.01- 08.04 06.01- 08.04	CA1509IR	14 150	06.01- 08.04	CS1326	12 2.3
			CA1564IR	14 90	06.01- 08.04	CS1177	12 1.7
C5 2.0 HDi FAP	[RHS (DW10ATED4)]	03.01- 08.04 03.01- 08.04	CA1553IR	14 150	03.01- 08.04	CS1177	12 1.7
			CA1564IR	14 90	03.01- 08.04	CS1326	12 2.3
			CA1761IR	14 150			
C5 2.0 HDi X7	[DW10CTED4]	04.09- 04.09-	CA2030IR	14 180	04.09-	CS1416	12 2.5
			CA2033IR	14 150			
C5 2.2 HDi	[4HL (DW12C)]	07.10-	CA2030IR	14 180	07.10-	CS1416	12 2.5
	[4HT (DW12BTED4)]	04.06-	CA1920IR	14 180	AT 04.06-	CS373	12 1.7
					04.06-	CS1416	12 2.5
					04.06-	CS1177	12 1.7
					04.06-	CS1342	12 1.9
					04.06-	CS342#	12 1.5
					04.06-	CS594	12 1.4
	[4HX (DW12TED4)]	03.01- 08.04 03.01- 08.04	CA1509IR	14 150	09.04-	CS1342	12 1.9
			CA1553IR	14 150	03.01- 08.04	CS1326	12 2.3
			CA1564IR	14 90	03.01- 08.04	CS1177	12 1.7
			CA1674IR	14 150			
			CA1761IR	14 150			
	[4HX (DW12TED4/FAP)]	09.04- 09.04-	CA1674IR	14 150	09.04-	CS1342	12 1.9
			CA1761IR	14 150			
C5 2.7 HDi	[DT17ED4]	02.08-	CA1888IR	14 180	02.08-	JS1368*	12 2.2
	[UHZ (DT17BTED4)]	02.08-	CA1888IR	14 180	02.08-	JS1368*	12 2.2
C5 3.0 Carlsson		09.03- 08.04 09.03- 08.04	CA1388IR	14 150	09.03- 08.04	CS1290	12 1.3
			CA1392IR	14 120			
C5 3.0 V6	[ES9A]				02.08-	CS1290	12 1.3
	[XFU (ES9A)]	09.04-	CA1388IR	14 150	09.04-	CS1177	12 1.7
	[XFV (ES9A)]	09.04-	CA1388IR	14 150	09.04-	CS1177	12 1.7
	[XFX (ES9J4S)]	03.01- 08.04 03.01- 08.04	CA1388IR	14 150	03.01- 08.04	CS1290	12 1.3
			CA1392IR	14 120	09.04-	CS1177	12 1.7
C5 3.0 HDi X7	[DT20C]				04.09-	JS1368*	12 2.2
C5 Break 2.0 HDi	[RHZ (DW10ATED)]	06.01- 08.04 06.01- 08.04	CA1553IR	14 150	06.01- 08.04	CS1177	12 1.7
			CA1761IR	14 150			
C6 2.2 HDi	[DW12BTED4]	06.06-	CA1920IR	14 180	06.06-	CS1416	12 2.5
C6 2.7 HDi	[DT17TED4]	09.05-	CA1888IR	14 180	09.05-	JS1368*	12 2.2
C6 3.0 V6	[ES9J4S]	09.05-	CA1388IR	14 150	09.05-	CS1290	12 1.3
		09.05-	CA1392IR	14 120			
C6 3.0 HDi	[X8Z (DT20C)]				04.09-	JS1368*	12 2.2
C8 2.0	[RFN (EW10J4)]	07.02- 07.02- 07.02- 07.02-	CA1499IR	14 80	07.02-	CS1244	12 1.1
			CA1589IR	14 90	07.02-	CS1277	12 1.4
			CA1674IR	14 150			
			CA1741IR	14 120			
C8 2.0 16V	[RFJ (EW10A)]	09.05- 09.05-	CA1914IR	14 150	09.05-	CS1244	12 1.1
			CA2015IR	14 120	09.05-	CS594	12 1.4
C8 2.0 HDi	[RHK (DW10UTED4)]	07.02- 07.02- 07.02- 02.07-	CA1509IR	14 150	07.02-	CS1177	12 1.7
			CA1553IR	14 150	07.02-	CS1326	12 2.3
			CA1761IR	14 150	07.02-	CS594	12 1.4
			CA1920IR	14 180			
	[RHM (DW10ATED4)]	07.02- 07.02- 07.02-	CA1509IR	14 150	07.02-	CS1177	12 1.7
			CA1553IR	14 150	07.02-	CS1326	12 2.3
			CA1761IR	14 150	07.02-	CS594	12 1.4
	[RHR (DW10BTED4)]	03.06- 03.06-	CA1761IR	14 150	03.06-	CS373	12 1.7
			CA1920IR	14 180	03.06-	CS594	12 1.4
					03.06-	CS1342	12 1.9
	[RHT (DW10ATED4)]	07.02- 07.02- 07.02-	CA1509IR	14 150	07.02-	CS1177	12 1.7
			CA1553IR	14 150	07.02-	CS1326	12 2.3
			CA1761IR	14 150	07.02-	CS594	12 1.4
	[RHW (DW10ATED4)]	07.02- 07.02- 07.02-	CA1509IR	14 150	07.02-	CS1177	12 1.7
			CA1553IR	14 150	07.02-	CS1326	12 2.3
			CA1761IR	14 150	07.02-	CS594	12 1.4
C8 2.2	[3FZ]	07.02- 07.02- 07.02- 07.02-	CA1499IR	14 80	07.02-	CS1244	12 1.1
			CA1589IR	14 90	07.02-	CS1277	12 1.4
			CA1674IR	14 150			
			CA1741IR	14 120			
C8 2.2 HDi	[4HT (DW12BTED4)]	06.06- 06.06-	CA1761IR	14 150	06.06-	CS1416	12 2.5
			CA1920IR	14 180			
	[4HW (DW12TED4)]	07.02- 12.02 12.02-	CA1553IR	14 150	07.02-	CS594	12 1.4
			CA1761IR	14 150	07.02-	CS1326	12 2.3
					07.02-	CS1177	12 1.7
C8 3.0 V6	[XFX (ES9J4S)]	07.02- 07.02-	CA1388IR	14 150	07.02-	CS1290	12 1.3
			CA1392IR	14 120			
C-Crosser 2.0	[4B11]	11.10-	CA2013IR*	14 120			
C-Crosser 2.2 HDi	[DW12MTED4]	02.07-	CA2008IR	14 150	02.07-	CS1416	12 2.5
					02.07-	CS1177	12 1.7
					02.07-	CS373	12 1.7
					02.07-	CS594	12 1.4
C-Crosser 2.2 HDi Enterprise	[4HN (DW12METED4)]	01.09-	CA2008IR	14 150	01.09-	CS1416	12 2.5
C-Crosser 2.4 16V	[MMC]	08.08-	CA2013IR*	14 120			
CX 2.0	[829A5]	08.84- 08.86	CA229IR	14 70	08.84- 08.86	CS317	12 1.05
CX 2.2 2200	[J6TA500]	06.81- 08.85	CA229IR	14 70	07.85- 12.92	CS317	12 1.05
					05.85- 12.92	CS523	12 2.2
CX 2.2 TRS	[J6TA500]	07.85- 12.92	CA229IR	14 70	07.85- 12.92	CS317	12 1.05
					07.85- 12.92	CS523	12 2.2
CX 2.5 i Turbo	[M25-662]	06.84- 08.85	CA175IR	14 70			



**CITROEN** *Continued*

CX 2.5 TRI	[M25-659]	07.83- 08.85	CA175IR	14 70			
CX 2.5 TD 2500	[M25-648]	08.85- 12.86	CA175IR	14 70			
		08.85- 12.86	CA735IR	14 75			
CX 20 RE 2.0	[829A5]	08.85- 12.92	CA229IR	14 70		08.85- 12.92	CS317 12 1.05
CX 2000 2.0	[829A5]	06.79- 08.85	CA229IR	14 70			
	[M20-616]	09.74- 05.79	CA175IR	14 70			
CX 22 2.2 TRS	[J6TA500]	07.85- 12.92	CA229IR	14 70		A13 07.85- 12.92	CS523 12 2.2
						07.85- 12.92	CS317 12 1.05
CX 22 TRS 2.2	[J6TA500]	07.85- 12.92	CA229IR	14 70		07.85- 12.92	CS317 12 1.05
CX 2200 2.2	[M22-617]	09.74- 07.76	CA175IR	14 70			
CX 2200 2.2 Diesel	[M22-621]	10.75- 02.79	CA175IR	14 70		10.75- 02.79	CS155 12 2.4
CX 2400 2.4	[M23-639]	05.80- 05.82	CA175IR	14 70		05.80- 05.82	CS573 12 1.3
		05.80- 05.82	CA229IR	14 70			
CX 2400 2.4 GTi	[M23-622]	06.77- 06.83	CA175IR	14 70		06.77- 06.83	CS573 12 1.3
CX 25 2.5	[M25-668]	05.86- 12.92	CA735IR	14 75		05.86- 12.92	CS573 12 1.3
CX 25 2.5 TRI	[M25-659]	07.83- 12.92	CA175IR	14 70		07.83- 12.92	CS573 12 1.3
		07.83- 12.92	CA735IR	14 75			
CX 25 2.5 GTi Turbo	[M25-662]	06.84- 12.92	CA735IR	14 75		06.84- 12.92	CS573 12 1.3
	[M25-667]	09.86- 12.92	CA735IR	14 75		09.86- 12.92	CS573 12 1.3
CX 25 2.5 GTi	[M25-668]	05.86- 12.92	CA175IR	14 70		05.86- 12.92	CS573 12 1.3
		05.86- 12.92	CA735IR	14 75			
CX 25 2.5 Diesel	[M25-660]	08.85- 12.92	CA175IR	14 70		08.85- 12.92	CS382 12 2.8
		08.85- 12.92	CA735IR	14 75		08.85- 12.92	CS361 12 2.2
						05.86- 12.92	CS155 12 2.4
CX 25 2.5 TD	[M25-648]	04.83- 12.86	CA175IR	14 70		04.83- 12.86	CS361 12 2.2
	[M25-669]	01.87- 12.92	CA175IR	14 70		01.87- 12.92	CS361 12 2.2
		01.87- 12.92	CA735IR	14 75		01.87- 12.92	CS382 12 2.8
CX 2500 2.5 Diesel	[M25-629]	02.78- 08.85	CA175IR	14 70		02.78- 08.85	CS361 12 2.2
						02.78- 08.85	CS155 12 2.4
						02.78- 06.82	CS382 12 2.8
DS3 1.4 16V	[8FR (EP3C)]	04.10- AC 04.10- AC 04.10-	CA2087IR* CA1954IR CA1990IR*	14 80 14 120 14 120		04.10-	CS1417 12 0.9
DS3 1.6 Racing	[5FF (EP6DTS)]	02.11- 02.11-	CA1954IR CA1990IR*	14 120 14 120		02.11-	CS1417 12 0.9
DS3 1.6 16V	[5FS (EP6C)]	04.10- AC 04.10- AC 04.10-	CA2087IR* CA1954IR CA1990IR*	14 80 14 120 14 120		04.10-	CS1417 12 0.9
	[EP6DT]	04.10- AC 04.10- AC 04.10-	CA2087IR* CA1954IR CA1990IR*	14 80 14 120 14 120		04.10-	CS1417 12 0.9
DS3 1.6 HDi	[DV6DTED]	11.09-	CA2033IR	14 150		11.09- 11.09-	CS1329 12 1.5 CS1391 12 2.2
DS4 1.6 120	[5FS (EP6C)]	04.11-	CA1954IR	14 120		04.11-	CS1417 12 0.9
DS4 1.6 THP 155	[5FV (EP6CDT)]	04.11-	CA1954IR	14 120		04.11-	CS1417 12 0.9
DS4 1.6 THP 200	[5FU (EP6DTX)]	04.11-	CA1954IR	14 120		04.11- 04.11- 04.11-	CS1329 12 1.5 CS1391 12 2.2 CS1417 12 0.9
DS4 1.6 HDi 110	[9HR (DV6C)]	04.11- 04.11-	CA2030IR CA2033IR	14 180 14 150		04.11- 04.11- 04.11-	CS1260 12 1.1 CS1329 12 1.5 CS1391 12 2.2
DS4 2.0 HDi 160	[RHH (DW10CTED4)]	04.11-	CA2030IR	14 180		04.11- 04.11-	CS1342 12 1.9 CS594 12 1.4
Dyane 4 0.4	[A79/0] [A79/1]	08.67- 03.68 04.68- 07.75 04.68- 10.73	CA115 CA112 CA115	14 28 14 26 A30 14 28 A26		04.68- 07.75	CS126 12 0.7
Dyane 6 0.6	[M28] [M28/1]	12.68- 07.83 05.72- 10.73 10.73- 06.83	CA115 CA115 CA112	14 28 14 28 A26 14 26 A30		12.68- 07.83 05.72- 06.83	CS126 12 0.7 CS126 12 0.7
Evasion 1.8	[LFZ (XU7JP)]	06.96- 07.02 09.96- 07.02 09.96- 07.02 AC 09.96- 07.02 AC 09.96- 07.02 AC 02.96- 12.96 02.96- 12.96 AC 02.96- 12.96 02.96- 12.96 02.96- 12.96	CA730IR CA820IR CA825IR CA1086IR CA836IR CA1086IR CA820IR CA836IR CA825IR CA730IR	14 80 14 70 14 95 14 80 14 120 14 80 14 70 14 120 14 95 14 80		09.96- 07.02 09.96- 07.02	CS566 12 1.1 CS715 12 1.4 CS715 12 1.4 CS566 12 1.1
Evasion 1.9 TD	[D8B (XUD9TF)]	11.94- 07.02 11.94- 07.02 11.94- 07.02	CA1043IR CA1065IR CA1098IR	14 80 14 95 14 120		11.94- 07.02 11.94- 07.02 11.94- 07.02	CS712 12 2.2 CS594 12 1.4 CS373 12 1.7 CS1177 12 1.7
	[DHX (XUD9TF/BTF)]	11.94- 07.02 11.94- 07.02 11.94- 07.02	CA1043IR CA1065IR CA1098IR	14 80 14 95 14 120		11.94- 07.02 11.94- 07.02 11.94- 07.02	CS712 12 2.2 CS594 12 1.4 CS1177 12 1.7 CS373 12 1.7
Evasion 2.0 16V	[RFN (EW10J4)]	05.00- 07.02 05.00- 07.02 05.00- 07.02	CA1496IR CA1509IR CA1564IR	14 80 14 150 14 90		05.00- 07.02	CS1277 12 1.4
	[RFV (XU10J4R)]	05.98- 04.00 05.98- 04.00 05.98- 04.00	CA1052IR CA1151IR CA1152IR	14 90 14 70 14 80		05.98- 04.00	CS566 12 1.1 CS715 12 1.4
		05.98- 04.00	CA1156IR	14 120			
Evasion 2.0 i	[RFU (XU10J2/C)]	06.94- 07.02 06.94- 07.02 06.94- 07.02 06.94- 07.02	CA1086IR CA820IR CA825IR CA836IR	14 80 14 70 14 95 14 120		06.94- 07.02 06.94- 07.02	CS566 12 1.1 CS715 12 1.4
Evasion 2.0 Turbo	[RGX (XU10J2TE)]	06.94- 04.97 06.94- 04.97 06.94- 04.97 06.94- 04.97 04.97- 07.02 04.97- 07.02 04.97- 07.02 04.97- 07.02	CA1086IR CA730IR CA820IR CA825IR CA1052IR CA1151IR CA1152IR CA1156IR	14 80 14 80 14 70 14 95 14 90 14 70 14 80 14 120		06.94- 07.02 06.94- 07.02	CS715 12 1.4 CS566 12 1.1
Evasion 2.0 HDi 16V	[RHW (DW10ATED4)]	09.99- 07.02 09.99- 07.02 09.99- 07.02	CA1553IR CA1564IR CA1646IR	14 150 14 90 14 120		09.99- 07.02 09.99- 07.02	CS594 12 1.4 CS712 12 2.2
Evasion 2.0 HDi	[RHZ (DW10ATED)]	01.99- 07.02 01.99- 07.02 AC 01.99- 07.02 AC 01.99- 07.02	CA1564IR CA1646IR CA1509IR CA1553IR	14 90 14 120 14 150 14 150		01.99- 07.02 01.99- 07.02	CS594 12 1.4 CS1177 12 1.7



Evasion 2.0 TD	[XUD9TE]	10.94- 07.02	CA1043IR	14 80	10.94- 07.02	CS373	12 1.7	
		10.94- 07.02	CA1065IR	14 95	10.94- 07.02	CS594	12 1.4	
		10.94- 07.02	CA1098IR	14 120	10.94- 07.02	CS1177	12 1.7	
Evasion 2.1 TD	[P8C (XUD11BTE)]	05.96- 07.02	CA1043IR	14 80	05.96- 07.02	CS712	12 2.2	
		05.96- 07.02	CA1065IR	14 95	05.96- 07.02	CS1177	12 1.7	
		05.96- 07.02	CA1098IR	14 120	05.96- 07.02	CS594	12 1.4	
Jumper 1.9 Diesel	[D9B (XUD9A/U)]	02.94- 02.02	CA638IR	14 80	01.99- 04.02	CS1177	12 1.7	
					02.94- 12.98	CS373	12 1.7	
					02.94- 02.02	CS594	12 1.4	
					02.94- 02.02	CS712	12 2.2	
		[DJY (XUD9A)]	01.99- 04.02	CA638IR	14 80	01.99- 04.02	CS1177	12 1.7
Jumper 1.9 TD	[D8C (XUD9UTF)]	02.94- 04.02	CA638IR	14 80	01.99- 04.02	CS594	12 1.4	
					02.94- 04.02	CS1177	12 1.7	
					01.97- 04.02	CS373	12 1.7	
					02.94- 04.02	CS594	12 1.4	
		[DHX (XUD9TF/BTF)]	03.94- 04.02	CA638IR	14 80	02.94- 04.02	CS712	12 2.2
Jumper 1.9 TD 4x4	[D8C (XUD9UTF)]	02.94- 02.02	CA638IR	14 80	03.94- 04.02	CS594	12 1.4	
					01.99- 04.02	CS1177	12 1.7	
					03.94- 12.98	CS373	12 1.7	
					03.94- 04.02	CS712	12 2.2	
					02.94- 12.98	CS712	12 2.2	
Jumper 2.0	[RFW (XU10J2U)]	02.94- 04.02	CA1086IR	14 80	A13 02.94- 04.02	CS715	12 1.4	
		02.94- 04.02	CA825IR	14 95	02.94- 04.02	CS566	12 1.1	
		03.94- 04.02	CA836IR	14 120	03.94-	CS712	12 2.2	
		02.03-	CA1086IR	14 80	02.03-	CS715	12 1.4	
		[XU10J2]			02.03-	CS566	12 1.1	
Jumper 2.0 4x4	[RFW (XU10J2U)]	02.94- 02.02	CA1086IR	14 80	A13 02.94- 02.02	CS715	12 1.4	
		02.94- 02.02	CA825IR	14 95	02.94- 02.02	CS566	12 1.1	
		02.94- 02.02	CA836IR	14 120				
		02.03-	CA1086IR	14 80				
Jumper 2.0 bivalent	[XU10J2]	02.03-	CA1086IR	14 80	02.03-	CS326	12 0.85	
					02.03-	CS566	12 1.1	
					02.03-	CS715	12 1.4	
Jumper 2.0 HDi	[DW10UTD]	11.01- 04.02	CA1553IR	14 150	11.01-	CS1177	12 1.7	
		11.01- 04.02	CA1564IR	14 90				
	[RHW (DW10UTD)]	04.02- 05.04	CA1564IR	14 90	04.02-	CS1177	12 1.7	
		05.04-	CA1761IR	14 150	04.02-	CS594	12 1.4	
		05.04-	CA1879IR	14 90	04.02-	CS570	12 3.1	
		AC 04.02- 05.04	CA1509IR	14 150				
		AC 04.02- 05.04	CA1553IR	14 150				
		AC 04.02- 05.04	CA1564IR	14 90				
		AC 05.04-	CA1761IR	14 150				
		AC 05.04-	CA1879IR	14 90				
Jumper 2.2 HDi 16V	[4HY (DW12TED)]	04.02- 05.04	CA1564IR	14 90	04.02-	CS1326	12 2.3	
		05.04-	CA1879IR	14 90	04.02-	CS570	12 3.1	
		AC 04.02- 05.04	CA1509IR	14 150	04.02-	CS1177	12 1.7	
		AC 05.04-	CA1761IR	14 150				
		AC 05.04-	CA1879IR	14 90				
Jumper 2.2 HDi	[22DTPUMA]	04.06-	CA1928IR	14 150	04.06-	CS1421	12 2.0	
		04.06-	CA1928IR	14 150	04.06-	CS1421	12 2.0	
	[4HU (22DT)]	04.06-	CA1928IR	14 150	04.06-	CS1421	12 2.0	
		04.06-	CA1928IR	14 150	04.06-	CS1421	12 2.0	
	[4HV (22DT)]	04.02- 05.04	CA1564IR	14 90	04.02-	CS1326	12 2.3	
		05.04-	CA1879IR	14 90	04.02-	CS594	12 1.4	
		AC 04.02- 05.04	CA1509IR	14 150	04.02-	CS1177	12 1.7	
	[4HY (DW12UTED)]	AC 04.02- 05.04	CA1553IR	14 150	04.02-	CS570	12 3.1	
		AC 04.02-	CA1761IR	14 150				
		AC 05.04-	CA1879IR	14 90				
		02.02- 06.06	CA1761IR	14 150	02.02- 06.06	CS1326	12 2.3	
Jumper 2.5 Diesel	[T9A (DJ5)]	02.94- 04.02	CA825IR	14 95	02.94- 04.02	CS885	12 2.2	
		02.94- 04.02	CA836IR	14 120				
		02.94- 04.02	CA825IR	14 95				
		02.94- 04.02	CA836IR	14 120				
		10.96- 08.97	CA825IR	14 95	10.96- 08.97	CS885	12 2.2	
Jumper 2.5 Diesel 4x4	[T9A (DJ5)]	10.96- 08.97	CA836IR	14 120				
		10.96- 08.97	CA1086IR	14 80				
		10.96- 08.97	CA1086IR	14 80				
Jumper 2.5 TD	[T8A (DJ5T)]	02.94- 04.02	CA825IR	14 95	02.94- 04.02	CS885	12 2.2	
		02.94- 04.02	CA836IR	14 120				
Jumper 2.5 TD 4x4	[T8A (DJ5T)]	02.94- 04.02	CA825IR	14 95	02.94- 02.02	CS885	12 2.2	
		02.94- 04.02	CA836IR	14 120				
Jumper 2.5 TDi	[THX (DJ5TED)]	12.96- 02.02	CA825IR	14 95	12.96- 02.02	CS885	12 2.2	
		12.96- 02.02	CA836IR	14 120				
Jumper 2.5 TDi 4x4	[THX (DJ5TED)]	10.96- 04.02	CA825IR	14 95	10.96- 04.02	CS885	12 2.2	
		10.96- 04.02	CA836IR	14 120				
		10.96- 04.02	CA836IR	14 120				
Jumper 2.8 Diesel	[8140.63]	01.99-	CA1039IR	14 80	01.99-	CS973	12 2.2	
		01.99-	CA1157IR	14 110				
		AC 12.99-	CA1835IR	14 120				
		[8140.63 (F28D)]	01.99- 02.02	CA1039IR	14 80	01.99- 02.02	CS973	12 2.2
Jumper 2.8 HDi	[8140.43N]	05.04-	CA1643IR	14 120	05.04-	CS973	12 2.2	
		05.04-	CA2037IR	14 150	05.04-	CS1198	12 2.3	
	[8140.43S]	09.00-	CA1643IR	14 120	Chas. -17600143 09.00-	CS1198	12 2.3	
		09.00-	CA1781IR	14 90	Chas. 17600144- 04.02-	CS1389	12 2.5	
			09.00- 04.02	CA2037IR	14 150	04.02-	CS1109	12 2.6
			10.00- 01.02	CA2037IR	14 150	10.00- 01.02	CS1198	12 2.3
			10.00- 01.02	CA1781IR	14 90			
			10.00- 01.02	CA1643IR	14 120			
	Jumper 2.8 HDi 4x4	[8140.43S]	09.00-	CA1643IR	14 120	Chas. 17600144- 04.02-	CS1389	12 2.5
			09.00-	CA1781IR	14 90	04.02-	CS1109	12 2.6
09.00- 04.02			CA2037IR	14 150	Chas. -17600143 09.00-	CS1198	12 2.3	
[F28TDCR]		02.02- 06.06	CA1643IR	14 120	02.02- 06.06	CS1109	12 2.6	
		02.02- 06.06	CA1781IR	14 90	02.02- 06.06	CS1198	12 2.3	
		02.02- 06.06	CA2037IR	14 150				
Jumper 2.8 TD	[8140.43]	10.99-	CA1039IR	14 80	10.99-	CS973	12 2.2	
		10.99-	CA1157IR	14 110				
		AC 12.99-	CA1835IR	14 120				
Jumper 3.0 HDi	[F1CE3481M]	07.10-	CA1913IR	14 140	07.10-	CS1449	12 2.5	
Jumper 3.0 HDi 145	[F1CE348IN]	07.10-	CA1913IR	14 140	07.10-	CS1449	12 2.5	
Jumper 3.0 HDi 155	[F1CE348IN]	07.10-	CA1913IR	14 140	07.10-	CS1449	12 2.5	

**CITROEN Continued**

Jumper 3.0 HDi 180		07.11-	CA1913IR	14 140		07.11-	CS1449	12 2.5
Jumpy 1.6	[1580SPI]	10.95-	CA1084IR	14 65		10.95-	CS975	12 0.9
		10.95-	CA1199IR	14 100				
Jumpy 1.6 i	[1580SPI]	10.95-	CA1084IR	14 65		10.95-	CS975	12 0.9
		10.95-	CA1199IR	14 100				
Jumpy 1.6 i	[220A2.000]	10.95-	CA1084IR	14 65		10.95-	CS975	12 0.9
		10.95-	CA1199IR	14 100				
Jumpy 1.6 HDi	[9HU (DV6UTED4)]	01.07-	CA1761IR	14 150		01.07-	CS1391	12 2.2
		01.07-	CA1761IR	14 150		01.07-	CS1260	12 1.1
Jumpy 1.6 HDi	[DV6UTED4]	01.07-	CA1761IR	14 150		01.07-	CS1391	12 2.2
		01.07-	CA1761IR	14 150		01.07-	CS1260	12 1.1
Jumpy 1.9 Diesel	[D9B (XUD9A/U)]	10.95- 04.98	CA1043IR	14 80		10.95- 04.98	CS594	12 1.4
		10.95- 04.98	CA637IR	14 70				
		10.95- 04.98	CA638IR	14 80				
		PS 10.95- 04.98	CA1155IR	14 70				
		ACPS 10.95- 04.98	CA1065IR	14 95				
		AC 10.95- 04.98	CA1043IR	14 80				
	[VJZ (DW8)]	04.98- 08.01	CA1442IR	14 70		04.98- 08.01	CS594	12 1.4
		04.98- 08.01	CA1496IR	14 80		04.98- 08.01	CS1177	12 1.7
		04.98- 08.01	CA1564IR	14 90				
		04.98- 08.01	CA1646IR	14 120				
		04.98-	CA1932IR	14 60				
		AC 04.98-	CA1646IR	14 120				
Jumpy 1.9 TD	[D8B (XUD9TF)]	10.95-	CA1043IR	14 80		10.95- 02.01	CS1177	12 1.7
		10.95-	CA1098IR	14 120		10.95-	CS594	12 1.4
		10.95-	CA1155IR	14 70				
		04.96-	CA637IR	14 70				
		04.96-	CA638IR	14 80				
		PS 10.95-	CA1043IR	14 80				
	[DHX (XUD9TF/BTF)]	10.95-	CA1043IR	14 80		10.95-	CS712	12 2.2
		10.95-	CA1065IR	14 95		10.95-	CS1177	12 1.7
		10.95-	CA1098IR	14 120		10.95-	CS594	12 1.4
		10.95-	CA1155IR	14 70				
		10.95-	CA637IR	14 70				
		10.95-	CA638IR	14 80				
Jumpy 2.0	[RFN (EW10J4)]	04.00- 10.06	CA1553IR	14 150		04.00- 12.06	CS1277	12 1.4
		04.00- 12.06	CA1564IR	14 90		04.00- 12.06	CS1244	12 1.1
		04.00- 12.06	CA1646IR	14 120				
		04.00- 12.06	CA1932IR	14 60				
		AC 04.00- 12.06	CA1509IR	14 150				
	[RFN (EW10J4)]	03.00- 12.02	CA1553IR	14 150		03.00-	CS1244	12 1.1
		03.00-	CA1564IR	14 90		03.00-	CS1277	12 1.4
		03.00-	CA1646IR	14 120				
		03.00-	CA1932IR	14 60				
		AC 03.00-	CA1509IR	14 150				
Jumpy 2.0 i 16V	[RFN (EW10J4)]	03.00- 12.02	CA1553IR	14 150		03.00-	CS1244	12 1.1
		03.00-	CA1564IR	14 90		03.00-	CS1277	12 1.4
Jumpy 2.0 i	[RFH (EW10A)]	01.07-	CA1914IR	14 150		01.07-	CS1244	12 1.1
		01.07-	CA2015IR	14 120				
Jumpy 2.0 i	[RFJ (EW10A)]	01.07-	CA1914IR	14 150		01.07-	CS1244	12 1.1
		01.07-	CA2015IR	14 120				
Jumpy 2.0 HDi	[RHK (DW10UTED4)]	01.07-	CA1761IR	14 150		01.07-	CS1342	12 1.9
		01.07-	CA1920IR	14 180				
		01.07-	CA1761IR	14 150		01.07-	CS1342	12 1.9
	[RHR (DW10BTED4)]	01.07-	CA1761IR	14 150		01.07-	CS1342	12 1.9
		01.07-	CA1920IR	14 180				
		01.07-	CA1761IR	14 150		01.07-	CS1342	12 1.9
	[RHW (DW10ATED4)]	03.00- 10.06	CA1509IR	14 150		03.00- 10.06	CS712	12 2.2
		03.00- 10.06	CA1553IR	14 150		03.00- 10.06	CS594	12 1.4
		03.00- 10.06	CA1564IR	14 90		03.00- 10.06	CS1177	12 1.7
		03.00- 10.06	CA1761IR	14 150				
		01.03-	CA1761IR	14 150		10.99-	CS594	12 1.4
		10.99-	CA1509IR	14 150		10.99-	CS712	12 2.2
[RHX (DW10BTED)]	10.99- 12.02	CA1553IR	14 150		10.99-	CS1177	12 1.7	
	10.99-	CA1564IR	14 90					
	AC 10.99-	CA1509IR	14 150					
	03.00- 10.06	CA1564IR	14 90		10.99- 10.06	CS594	12 1.4	
	01.02-	CA1496IR	14 80		03.00-	CS712	12 2.2	
	01.02-	CA1646IR	14 120		10.99- 10.06	CS1177	12 1.7	
[RHZ (DW10ATED)]	01.03- 10.06	CA1761IR	14 150					
	10.99- 10.06	CA1553IR	14 150					
	AC 10.99- 10.06	CA1509IR	14 150					
	03.00- 10.06	CA1564IR	14 90		10.99- 10.06	CS594	12 1.4	
	01.02-	CA1496IR	14 80		03.00-	CS712	12 2.2	
	01.02-	CA1646IR	14 120		10.99- 10.06	CS1177	12 1.7	
Jumpy 2.0 HDi 165	[RHH (DW10CTED4)]	07.10-	CA1913IR	14 140		07.10-	CS1449	12 2.5
LNA 0.6	[R06627]	11.76- 07.79	CA112	14 26				
	[V06630]	11.78- 07.82	CA112	14 26	A30			
		11.78- 07.82	CA115	14 28	A26			
		11.78- 07.82	CA172IR#	14 35				
LNA 0.6	[V06644]	07.82- 04.85	CA172IR#	14 35		07.82- 04.85	CS355	12 0.85
						07.82- 04.85	CS142	12 0.85
LNA 1.0	[108C]	07.84- 10.86	CA291IR	14 50		07.84- 10.86	CS355	12 0.85
LNA 1.1	[109/5E]	07.82- 04.85	CA291IR	14 50		07.82- 04.85	CS142	12 0.85
						07.82- 04.85	CS355	12 0.85
Mehari 0.6	[A06/635]	10.79- 10.87	CA115	14 28		10.79- 10.87	CS126	12 0.7
	[M28/1]	05.68- 10.79	CA115	14 28		05.68- 10.79	CS126	12 0.7
	[M28/1 (AK2)]	10.79- 10.87	CA115	14 28		10.79- 10.87	CS126	12 0.7
Mehari 0.6 4x4	[A06/635]	10.79- 10.87	CA115	14 28		10.79- 10.87	CS126	12 0.7
Nemo 1.4	[KVF (TU3A)]	02.08-	CA1499IR	14 80		02.08-	CS581	12 1.0
		02.08-	CA1589IR	14 90		02.08-	CS390	12 0.9
	[KVF(TU3A)]	04.09-	CA1499IR	14 80		04.09-	CS390	12 0.9
		04.09-	CA1589IR	14 90		04.09-	CS581	12 1.0
Nemo 1.4 HDi	[8HS (DV4TED)]	04.09-	CA2031IR	14 90		04.09-	CS1329	12 1.5
		04.09-	CA2031IR	14 90		04.09-	CS1260	12 1.1
Nemo 1.4 HDi	[DV4TED]	02.08-	CA2031IR	14 90		02.08-	CS1329	12 1.5
		02.08-	CA2031IR	14 90		02.08-	CS1260	12 1.1



Relay 2.8 Diesel	[8140.63 (F28D)]	01.99- 02.02	CA1674IR	14 150	01.99- 02.02	CS973	12 2.2
		A39 01.99- 02.02	CA1157IR	14 110			
Saxo 1.0	[CDZ (TU9M)]	02.96- 06.03	CA618IR	14 70	02.96- 06.03	CS581	12 1.0
		02.96- 06.03	CA715IR	14 80	02.96- 06.03	CS1111	12 0.7
					02.96- 06.03	CS390	12 0.9
Saxo 1.1	[HDZ (TU1M)]	03.00- 09.03	CA1640IR	14 70	05.96- 09.03	CS581	12 1.0
		05.96- 09.03	CA618IR	14 70			
		05.96- 09.03	CA715IR	14 80			
		09.99- 09.03	CA1641IR	14 80			
		PS 03.00- 09.03	CA1642IR	14 97			
		AC 03.00- 09.03	CA1642IR	14 97			
	[HFX (TU1JP)]	03.00- 09.03	CA1641IR	14 80	03.00- 09.03	CS581	12 1.0
		03.00- 09.03	CA1642IR	14 97	03.00- 09.03	CS390	12 0.9
					03.00- 09.03	CS1111	12 0.7
	Saxo 1.4 VTS	[KFW (TU3JP)]	06.00- 06.03	CA1243IR	14 90	06.00- 06.03	CS581
06.00- 06.03			CA1305IR	14 65			
06.00- 06.03			CA618IR	14 70			
06.00- 06.03			CA715IR	14 80			
[KFX (TU3JP)]		05.96- 06.03	CA1243IR	14 90	05.96- 06.03	CS581	12 1.0
		05.96- 06.03	CA618IR	14 70			
		05.96- 06.03	CA715IR	14 80			
		09.99- 06.03	CA1305IR	14 65			
		09.99- 06.03	CA1641IR	14 80			
		PS 05.96- 06.03	CA1642IR	14 97			
Saxo 1.5 Diesel	[VJY (TUD5)]	09.96-	CA1038IR	14 70	09.96-	CS542	12 1.4
		09.96-	CA1203IR	14 80			
		09.96-	CA1583IR	14 90			
	[VJZ (TUD5)]	09.96- 06.01	CA1038IR	14 70	09.96- 06.01	CS542	12 1.4
		09.96- 06.01	CA1203IR	14 80			
		09.96- 06.01	CA1583IR	14 90			
		07.01- 04.04	CA1038IR	14 70			
		07.01- 04.04	CA1583IR	14 90			
		07.01- 04.04	CA1203IR	14 80			
Saxo 1.6	[NFT]	02.01- 04.04	CA1640IR	14 70	02.01- 04.04	CS581	12 1.0
		02.01- 04.04	CA1641IR	14 80			
	[NFX (TU5JP4)]	02.96- 04.04	CA1641IR	14 80	02.96- 04.04	CS581	12 1.0
		02.96- 04.04	CA715IR	14 80			
		AC 02.96- 04.04	CA1243IR	14 90			
	[NFZ (TU5JP)]	02.96- 06.03	CA1243IR	14 90	02.96- 06.03	CS581	12 1.0
		02.96- 06.03	CA1305IR	14 65			
		02.96- 06.03	CA1640IR	14 70			
		02.96- 06.03	CA1641IR	14 80			
		02.96- 06.03	CA618IR	14 70			
02.96- 06.03		CA715IR	14 80				
PS 02.96- 06.03		CA1642IR	14 97				
Saxo 1.6 16V	[NFX (TU5JP4)]	06.96- 09.03	CA715IR	14 80	06.96- 09.03	CS581	12 1.0
		09.99- 09.03	CA1641IR	14 80			
		AC 06.96- 09.03	CA1243IR	14 90			
Saxo 1.6 VTS	[NFT (TU5JP/L4)]	09.00- 09.03	CA1640IR	14 70	09.00-	CS581	12 1.0
		09.00- 09.03	CA1641IR	14 80			
Visa 0.6	[V06630]	09.78- 07.82	CA172IR#	14 35			
	[V06644]	07.82- 03.91	CA172IR#	14 35			
	[V06665]	07.82- 03.91	CA172IR#	14 35			
Visa 1.0	[108/5C]	09.84- 06.88	CA291IR	14 50	09.84- 06.88	CS355	12 0.85
Visa 1.1	[109/5]				09.78- 10.84	CS142	12 0.85
					09.84- 03.91	CS355	12 0.85
	[109/5F]	03.86- 10.88	CA291IR	14 50	03.83- 10.88	CS142	12 0.85
					07.82- 03.91	CS355	12 0.85
	[109K]				09.82- 10.84	CS142	12 0.85
				11.84- 06.88	CS355	12 0.85	
Visa 1.2 Super X	[129/5]				07.80- 06.82	CS142	12 0.85
Visa 1.4	[150D (XY7)]				07.84- 03.91	CS355	12 0.85
Visa 1.4 GT	[150B (XY8)]	03.82- 03.91	CA291IR	14 50	03.82- 03.91	CS355	12 0.85
	[KAZ (XY7CP)]				07.82- 03.91	CS142	12 0.85
					07.82- 03.91	CS355	12 0.85
Visa 1.6 GTi	[180A (XU5J)]	01.85- 06.86	CA294IR	14 50	01.85- 06.86	CS566	12 1.1
		01.85- 06.86	CA532IR	14 80			
	[B6D]	06.86- 03.91	CA294IR	14 50	06.86- 03.91	CS566	12 1.1
		06.86- 03.91	CA532IR	14 80			
Visa 1.7 Diesel	[161A (XUD7)]	04.84- 03.91	CA294IR	14 50	04.84- 03.91	CS594	12 1.4
		04.84- 03.91	CA532IR	14 80			
Xantia 1.6 i	[BFZ (XU5JP)]	03.93- 01.98	CA1086IR	14 80	A13 03.93- 01.98	CS715	12 1.4
		03.93- 01.98	CA825IR	14 95	03.93- 01.98	CS566	12 1.1
		03.93- 01.98	CA836IR	14 120			
Xantia 1.6 i SX	[XU5JP]	01.98- 03.01	CA1086IR	14 80	01.98- 03.01	CS566	12 1.1
		01.98- 03.01	CA730IR	14 80			
		01.98- 03.01	CA825IR	14 95			
Xantia 1.8 i 16V	[LFY (XU7JP4)]	06.95- 04.03	CA1052IR	14 90	A13 06.95- 04.03	CS566	12 1.1
		06.95- 04.03	CA1151IR	14 70			
		06.95- 04.03	CA1152IR	14 80			
		06.95- 01.98	CA1156IR	14 120			
		AC 06.95- 04.03	CA1156IR	14 120			
Xantia 1.8 i	[LFX (XU7JB)]	04.97- 04.03	CA1052IR	14 90	A13 04.97- 04.03	CS715	12 1.4
		04.97- 04.03	CA1151IR	14 70			
		04.97- 04.03	CA1152IR	14 80			
		04.97- 01.98	CA1156IR	14 120			
		AC 01.98- 04.03	CA1156IR	14 120			
	[LFZ (XU7JP)]	03.93- 01.98	CA1086IR	14 80	A13 03.93- 01.98	CS715	12 1.4
		03.93- 01.98	CA825IR	14 95			
		03.93- 01.98	CA836IR	14 120			
Xantia 1.9 Diesel	[D9B (XUD9A/L)]	07.93- 01.98	CA1065IR	14 95	07.93- 01.98	CS594	12 1.4
		07.93- 01.98	CA1098IR	14 120			
		07.93- 01.98	CA1312IR	14 150			
		07.93- 01.98	CA637IR	14 70			
		07.93- 01.98	CA638IR	14 80			
	[DHW (XUD9SD)]	02.96- 04.03	CA1065IR	14 95	02.96- 01.98	CS373	12 1.7
		02.96- 04.03	CA1098IR	14 120			
		09.96- 04.03	CA1312IR	14 150			
		09.96- 01.98	CA638IR	14 80			
[DJZ (XUD9Y)]	06.94- 01.98	CA1065IR	14 95	06.94- 01.98	CS594	12 1.4	
	06.94- 01.98	CA1098IR	14 120				
	06.94- 01.98	CA1312IR	14 150				
	06.94- 01.98	CA637IR	14 70				
	06.94- 01.98	CA638IR	14 80				

**CITROEN Continued**

Xantia 1.9 TD	[D8B (XUD9TF)]	09.95- 04.03 CA1065IR	14 95	09.95- 04.03 CS594	12 1.4	
		09.95- 04.03 CA1098IR	14 120	09.95- 12.96 CS712	12 2.2	
		09.95- 12.96 CA1312IR	14 150	09.95- 12.96 CS373	12 1.7	
	[DHX (XUD9TF/BTF)]	02.94- 12.01 CA1065IR	14 95	02.94- 12.01 CS594	12 1.4	
		02.94- 01.98 CA637IR	14 70	02.94- 01.98 CS712	12 2.2	
		02.94- 01.98 CA638IR	14 80	06.95- 12.01 CS1177	12 1.7	
		06.95- 12.01 CA1098IR	14 120			
		06.95- 04.03 CA1312IR	14 150			
		AC 02.94- 01.98 CA1098IR	14 120			
	[DHY (XUD9TE/Y)]	02.94- 11.01 CA1065IR	14 95	02.94- 01.98 CS712	12 2.2	
		02.94- 01.98 CA637IR	14 70	02.94- 11.01 CS594	12 1.4	
		02.94- 01.98 CA638IR	14 80	06.95- 11.01 CS1177	12 1.7	
06.95- 11.01 CA1098IR		14 120				
06.95- 01.98 CA1312IR		14 150				
AC 02.94- 01.98 CA1098IR		14 120				
Xantia 2.0		03.93- 05.95 CA825IR	14 95	03.93- 05.95 CS715	12 1.4	
		03.93- 05.95 CA1086IR	14 80	03.93- 05.95 CS566	12 1.1	
		03.93- 05.95 CA836IR	14 120			
Xantia 2.0 i16V	[RFT (XU10J4/Z)]	03.93- 12.98 CA1086IR	14 80			
		03.93- 12.98 CA825IR	14 95			
		03.93- 12.98 CA836IR	14 120			
	[RFV (XU10J4R)]	06.95- 04.03 CA1052IR	14 90	01.98- 04.03 CS715	12 1.4	
		06.95- 04.03 CA1152IR	14 80	01.98- 04.03 CS566	12 1.1	
		06.95- 04.03 CA1156IR	14 120			
		01.98- 04.03 CA1151IR	14 70			
	[RFY (XU10J4/Z)]	03.93- 12.98 CA1086IR	14 80			
		03.93- 12.98 CA825IR	14 95			
		03.93- 12.98 CA836IR	14 120			
	Xantia 2.0 i	[RFX (XU10J2)]	01.98- 04.03 CA825IR	14 95	01.98- 04.03 CS715	12 1.4
					01.98- 04.03 CS566	12 1.1
[RFX (XU10J2C)]		03.93- 01.98 CA1086IR	14 80	03.93- 04.03 CS566	12 1.1	
		03.93- 04.03 CA825IR	14 95	03.93- 04.03 CS715	12 1.4	
		03.93- 01.98 CA836IR	14 120			
		06.95- 01.98 CA1052IR	14 90			
Xantia 2.0 Turbo	[RGX (XU10J2TE)]	06.95- 04.03 CA1052IR	14 90	06.95- 04.03 CS566	12 1.1	
		06.95- 04.03 CA1151IR	14 70	06.95- 04.03 CS715	12 1.4	
		06.95- 04.03 CA1152IR	14 80			
Xantia 2.0 HDi	[RHY (DW10TD)]	03.99- 04.03 CA1564IR	14 90	03.99- 04.03 CS1177	12 1.7	
		03.99- 04.03 CA1646IR	14 120	03.99- 04.03 CS594	12 1.4	
		AC 03.99- 04.03 CA1509IR	14 150			
	[RHZ (DW10ATED)]	02.99- 04.03 CA1564IR	14 90	02.99- 04.03 CS1177	12 1.7	
		AC 02.99- 04.03 CA1509IR	14 150	02.99- 04.03 CS594	12 1.4	
Xantia 2.1 TD 12V	[P8C (XUD11BTE)]	06.95- 12.01 CA1065IR	14 95	06.95- 01.98 CS712	12 2.2	
		06.95- 12.01 CA1098IR	14 120	01.98- 12.01 CS1177	12 1.7	
		06.95- 12.01 CA1312IR	14 150	06.95- 12.01 CS594	12 1.4	
Xantia 3.0 i24V	[XFZ (ES9 J4)]	01.97- 01.98 CA1338IR	14 120	11.96- 01.98 CS1108	12 1.5	
		01.97- 01.98 CA1388IR	14 150			
		12.97- 01.98 CA1392IR	14 120			
Xantia 3.0 V6	[XFZ (ES9 J4)]	01.98- 04.03 CA1338IR	14 120	01.98- 04.03 CS1108	12 1.5	
		01.98- 04.03 CA1388IR	14 150			
	[XFZ (ES9J4)]	01.98- 04.03 CA1338IR	14 120	01.98- 04.03 CS1108	12 1.5	
		01.98- 04.03 CA1388IR	14 150			
XM 2.0	[R2A (XU102C)]	05.89- 04.94 CA729IR#	14 50	05.89- 04.94 CS715	12 1.4	
				05.89- 04.94 CS566	12 1.1	
				05.89- 06.94 CS715	12 1.4	
	[R6A (XU10J2K)]	05.89- 06.94 CA556IR	14 80	05.89- 06.94 CS566	12 1.1	
		05.89- 06.94 CA614IR	14 90	05.89- 06.94 CS715	12 1.4	
		05.89- 06.94 CA820IR	14 70			
	[RDZ (XU10MZ)]	05.89- 06.94 CA832IR	14 120			
		05.89- 04.94 CA556IR	14 80	05.89- 04.94 CS566	12 1.1	
		05.89- 04.94 CA587IR	14 70	A13 05.89- 04.94 CS712	12 2.2	
		05.89- 04.94 CA820IR	14 70			
	[XU102C]	11.91- 04.94 CA614IR	14 90			
		05.89- 04.94 CA556IR	14 80	A13 05.89- 04.94 CS712	12 2.2	
05.89- 04.94 CA587IR		14 70	05.89- 04.94 CS566	12 1.1		
05.89- 04.94 CA820IR		14 70				
XM 2.0 i16V	[RFV (XU10J4R)]	Chas. 6779- 05.95- 10.00 CA1052IR	14 90	05.94- 10.00 CS566	12 1.1	
		Chas. 6779- 05.95- 10.00 CA1151IR	14 70	A13 05.94- 10.00 CS715	12 1.4	
		Chas. 6779- 05.95- 10.00 CA1152IR	14 80			
		Chas. 6779- 06.95- 10.00 CA1156IR	14 120			
		Chas. -6778 05.94- 05.95 CA1086IR	14 80			
		Chas. -6778 05.94- 05.95 CA587IR	14 70			
		Chas. -6778 05.94- 05.95 CA825IR	14 95			
		Chas. -6778 05.94- 05.95 CA836IR	14 120			
XM 2.0 i Turbo	[RGY (XU10J2TE/Z)]	Chas. -6778 09.92- 06.94 CA556IR	14 80	A13 09.92- 06.94 CS715	12 1.4	
		Chas. -6778 09.92- 06.94 CA587IR	14 70	09.92- 06.94 CS566	12 1.1	
XM 2.0 i	[RDZ (XU10MZ)]	05.89- 04.94 CA556IR	14 80	05.89- 04.94 CS566	12 1.1	
		05.89- 04.94 CA587IR	14 70	A13 03.91- 04.94 CS715	12 1.4	
		05.89- 04.94 CA614IR	14 90			
	[RFZ (XU10J2)]	05.89- 06.94 CA556IR	14 80	05.89- 06.94 CS566	12 1.1	
		05.89- 06.94 CA587IR	14 70	A13 05.89- 06.94 CS715	12 1.4	
		Chas. -6778 11.91- 06.94 CA556IR	14 80			
XM 2.0 Turbo	[RGX (XU10J2TE)]	Chas. -6778 11.91- 06.94 CA587IR	14 70			
		05.94- 05.95 CA614IR	14 90	05.94- 10.00 CS566	12 1.1	
		05.94- 05.95 CA832IR	14 120	A13 05.94- 10.00 CS715	12 1.4	
		06.95- 10.00 CA1052IR	14 90			
		06.95- 10.00 CA1151IR	14 70			
		06.95- 10.00 CA1152IR	14 80			
		06.95- 10.00 CA1156IR	14 120			
		Chas. 6779- 05.95- 10.00 CA1052IR	14 90			
		Chas. 6779- 05.95- 10.00 CA1152IR	14 80			
		Chas. 6779- 05.95- 10.00 CA1156IR	14 120			
		Chas. -6778 05.94- 05.95 CA556IR	14 80			
		Chas. -6778 05.94- 05.95 CA587IR	14 70			
		Chas. -6778 05.94- 05.95 CA614IR	14 90			
		Chas. -6778 05.94- 05.95 CA832IR	14 120			
[RGY (XU10J2TE/Z)]	09.92- 06.94 CA556IR	14 80	A13 09.92- 09.95 CS715	12 1.4		
	09.92- 06.94 CA587IR	14 70	09.92- 09.95 CS566	12 1.1		
	07.94- 09.95 CA832IR	14 120				





		06.95-09.95	CA1151IR	14 70			
		06.95-09.95	CA1152IR	14 80			
		07.95-09.95	CA1156IR	14 120			
	Chas. -6778 05.94-05.95		CA5561R	14 80			
XM 2.1 Diesel	[P9A (XUD11A)]	05.89-07.93	CA5871R	14 70	11.91-04.94	CS712	12 2.2
		11.91-12.95	CA1238IR#	14 80	05.89-06.94	CS373	12 1.7
		11.91-12.95	CA5561R	14 80	11.91-04.94	CS594	12 1.4
		11.91-12.95	CA6141R	14 90	11.91-06.96	CS1177	12 1.7
		11.91-12.95	CA7291R#	14 50			
		11.91-12.95	CA8201R	14 70			
		11.91-12.95	CA8351R	14 90			
	AC 05.89-07.93		CA5561R	14 80			
XM 2.1 TD 12V	[P8A (XUD11ATE)]	05.89-06.94	CA5561R	14 80	05.89-06.94	CS1177	12 1.7
		05.89-06.94	CA5871R	14 70	05.89-06.94	CS373	12 1.7
		05.89-06.94	CA8201R	14 70			
		07.93-06.94	CA1238IR#	14 80			
		07.93-06.94	CA6141R	14 90			
	AC 05.89-06.94		CA5561R	14 80			
	[P8C (XUD11BTE)]	05.89-06.94	CA5561R	14 80	05.89-06.94	CS373	12 1.7
		05.89-06.94	CA5871R	14 70	A13 05.94-10.00	CS712	12 2.2
		07.94-06.95	CA1238IR#	14 80	05.94-10.00	CS594	12 1.4
		07.95-10.00	CA1065IR	14 95	05.89-10.00	CS1177	12 1.7
		07.95-10.00	CA1098IR	14 120			
	Chas. 6779-05.94-10.00		CA1065IR	14 95			
	Chas. 6779-05.94-10.00		CA1098IR	14 120			
	Chas. -6778 05.94-10.00		CA1238IR#	14 80			
	[PHZ (XUD11ATE)]	05.89-06.94	CA5561R	14 80	A13 05.89-10.00	CS712	12 2.2
		05.89-06.94	CA5871R	14 70	A13 05.89-06.94	CS373	12 1.7
		05.89-06.94	CA8201R	14 70	05.89-10.00	CS1177	12 1.7
		07.93-06.94	CA1238IR#	14 80	05.94-10.00	CS594	12 1.4
		07.93-06.94	CA6141R	14 90			
	Chas. 6779-07.95-10.00		CA1065IR	14 95			
	Chas. 6779-09.95-10.00		CA1098IR	14 120			
	Chas. -6778 05.94-06.95		CA1238IR#	14 80			
	AC 05.89-06.94		CA5561R	14 80			
	[PJZ (XUD11ATE)]	05.89-06.94	CA5871R	14 70	A13 09.93-12.96	CS712	12 2.2
		07.93-06.95	CA1238IR#	14 80	05.89-06.94	CS373	12 1.7
		07.93-06.94	CA6141R	14 90	09.93-12.96	CS594	12 1.4
		09.93-06.94	CA5561R	14 80	09.93-12.96	CS1177	12 1.7
		09.93-06.94	CA8201R	14 70			
		07.95-12.96	CA1065IR	14 95			
		07.95-12.96	CA1098IR	14 120			
	Chas. 6779-05.94-12.96		CA1065IR	14 95			
	Chas. 6779-05.94-12.96		CA1098IR	14 120			
	Chas. -6778 05.94-12.96		CA1238IR#	14 80			
	AC 05.89-06.94		CA5561R	14 80			
XM 2.5 TD	[THY (DK5ATE)]	05.94-10.00	CA8361R	14 120	05.94-10.00	CS715	12 1.4
					05.94-10.00	CS885	12 2.2
XM 3.0 V6 24V	[SKZ (ZPJ4/Z)]	05.89-06.94	CA5561R	14 80	05.89-06.94	CS551	12 1.4
		07.90-06.94	CA5871R	14 70			
	[UKZ (ZPJ4/Z)]	06.93-12.97	CA5561R	14 80	06.93-12.97	CS551	12 1.4
		06.93-06.94	CA5871R	14 70			
XM 3.0 V6	[SFZ (ZPJ/Z)]	05.89-06.94	CA5561R	14 80	05.89-06.94	CS551	12 1.4
		05.89-06.94	CA5871R	14 70			
	[UFZ (ZPJ/Z)]	05.89-12.97	CA5561R	14 80	05.89-12.97	CS551	12 1.4
		05.89-06.94	CA5871R	14 70			
	[XFZ (ES9J4)]	04.97-10.00	CA1338IR	14 120	04.97-10.00	CS1108	12 1.5
		04.97-10.00	CA1388IR	14 150			
		04.97-10.00	CA1392IR	14 120			
Xsara 1.4 i	[KFW (TU3JP)]	09.00-03.05	CA1305IR	14 65	09.00-08.05	CS1111	12 0.7
		09.00-08.05	CA1498IR	14 70	09.00-08.05	CS390	12 0.9
		09.00-08.05	CA1499IR	14 80	09.00-08.05	CS581	12 1.0
		09.00-08.05	CA1589IR	14 90			
		09.00-03.05	CA6181R	14 70			
		09.00-03.05	CA7151R	14 80			
	[KFX (TU3JP)]	04.97-08.00	CA6181R	14 70	04.97-08.00	CS1111	12 0.7
		04.97-08.00	CA7151R	14 80	07.97-08.00	CS390	12 0.9
		07.97-08.00	CA1305IR	14 65	04.97-08.00	CS581	12 1.0
	AC 04.97-08.00		CA1305IR	14 65			
Xsara 1.4 HDi	[8HX (DV4TD)]	01.03-03.05	CA1665IR	14 80	01.03-08.05	CS1260	12 1.1
		01.03-08.05	CA1674IR	14 150			
		01.03-03.05	CA1681IR	14 90			
		01.03-03.05	CA1687IR	14 70			
		01.03-03.05	CA1832IR	14 60			
Xsara 1.5 Diesel	[VJZ (TUD5)]	04.97-09.00	CA1038IR	14 70	04.97-09.00	CS542	12 1.4
		04.97-09.00	CA1203IR	14 80			
Xsara 1.6 Picasso	[NFV (TU5JP/L4)]	09.00-09.00	CA1498IR	14 70	09.00-09.00	CS1111	12 0.7
		09.00-09.00	CA1499IR	14 80	09.00-09.00	CS581	12 1.0
		09.00-09.00	CA1589IR	14 90			
	[NFZ (TU5JP)]	01.00-01.00	CA1498IR	14 70	01.00-01.00	CS581	12 1.0
		01.00-01.00	CA1499IR	14 80	01.00-01.00	CS1111	12 0.7
		01.00-01.00	CA1589IR	14 90			
		06.02-06.02	CA1496IR	14 80	06.02-06.02	CS390	12 0.9
		06.02-06.02	CA1442IR	14 70	06.02-06.02	CS581	12 1.0
					06.02-06.02	CS1111	12 0.7
Xsara 1.6 16V	[NFU (TU5JP4)]	09.00-03.05	CA1243IR	14 90	09.00-08.05	CS1111	12 0.7
		09.00-03.05	CA1305IR	14 65	09.00-08.05	CS581	12 1.0
		09.00-08.05	CA1498IR	14 70			
		09.00-03.05	CA1499IR	14 80			
		09.00-03.05	CA7151R	14 80			
	AC 09.00-08.05		CA1499IR	14 80			
Xsara 1.6 16V Picasso	[NFV (TU5JP4)]	09.05-09.05	CA1499IR	14 80	09.05-09.05	CS390	12 0.9
					09.05-09.05	CS581	12 1.0
Xsara 1.6 i	[NFZ (TU5JP)]	07.97-09.00	CA1305IR	14 65	07.97-09.00	CS1111	12 0.7
		07.97-09.00	CA6181R	14 70	07.97-09.00	CS581	12 1.0
		07.97-09.00	CA7151R	14 80			
		02.98-09.00	CA1243IR	14 90			
Xsara 1.6 HDi Picasso	[9HY (DV6TED4)]	05.04-05.04	CA1761IR	14 150	05.04-05.04	CS1391	12 2.2
					05.04-05.04	CS1260	12 1.1
					05.04-05.04	CS1329	12 1.5
	[DV6ATED4]	09.05-09.05	CA1674IR	14 150	09.05-09.05	CS1391	12 2.2
Xsara 1.8 16V Picasso	[6FZ (EW7J4)]	01.00-05.00	CA1496IR	14 80	01.00-01.00	CS1244	12 1.1
		01.00-05.00	CA1564IR	14 90	01.00-01.00	CS1277	12 1.4
		01.00-05.00	CA1646IR	14 120			



**CITROEN** Continued

		06.00-	CA1499IR	14	80			
		06.00-	CA1589IR	14	90			
		06.00-	CA1741IR	14	120			
	[LFY (XU7JP4)]	02.00-	CA1496IR	14	80	02.00-	CS1244	12 1.1
		02.00-	CA1509IR	14	150	02.00-	CS1277	12 1.4
		02.00-	CA1564IR	14	90			
Xsara 1.8 i 16V	[LFY (XU7JP4)]	07.97-	CA1052IR	14	90	07.97-	CS715	12 1.4
		07.97-	CA1151IR	14	70	07.97-	CS566	12 1.1
		07.97-	CA1152IR	14	80			
Xsara 1.8 i	[LFX (TU7JB)]	07.97-	CA1052IR	14	90	07.97-	CS715	12 1.4
		07.97-	CA1151IR	14	70	07.97-	CS566	12 1.1
		07.97-	CA1152IR	14	80			
	[LFX (XU7JB)]	07.97-	CA1052IR	14	90	07.97-	CS715	12 1.4
		07.97-	CA1151IR	14	70	07.97-	CS566	12 1.1
		07.97-	CA1152IR	14	80			
	[LFX (XU7JP)]	04.98-	CA1052IR	14	90	04.98-	CS715	12 1.4
		04.98-	CA1151IR	14	70	04.98-	CS566	12 1.1
		04.98-	CA1152IR	14	80			
	[LFX (XU7JP)]	04.97-	CA730IR	14	80	04.97-	CS566	12 1.1
		04.97-	CA820IR	14	70	04.97-	CS715	12 1.4
		04.97-	CA825IR	14	95			
		04.97-	CA836IR	14	120			
		02.98-	CA1086IR	14	80			
		AC 04.97-	CA1086IR	14	80			
		AC 02.98-	CA836IR	14	120			
Xsara 1.8 Diesel	[161A (XUD7)]	04.97-	CA637IR	14	70	04.97-	CS1177	12 1.7
		04.97-	CA638IR	14	80	04.97-	CS594	12 1.4
		PS 04.97-	CA1043IR	14	80	04.97-	CS373	12 1.7
		PS 04.97-	CA1065IR	14	95			
		PS 04.97-	CA1155IR	14	70			
		AC 04.97-	CA1098IR	14	120			
	[A9A (XUD7)]	07.97-	CA1065IR	14	95	07.97-	CS1177	12 1.7
		07.97-	CA1098IR	14	120	07.97-	CS594	12 1.4
		07.97-	CA637IR	14	70	07.97-	CS373	12 1.7
		07.97-	CA638IR	14	80			
		PS 07.97-	CA1043IR	14	80			
		PS 07.97-	CA1065IR	14	95			
		PS 07.97-	CA1155IR	14	70			
		ACPS 07.97-	CA1098IR	14	120			
Xsara 1.9 Diesel	[DHW (XUD9BSD)]	01.98-	CA637IR	14	70	01.98-	CS373	12 1.7
		01.98-	CA638IR	14	80	01.98-	CS594	12 1.4
		ACPS 01.98-	CA1043IR	14	80	01.98-	CS1177	12 1.7
		ACPS 01.98-	CA1065IR	14	95			
	[DJY (XUD9A)]	04.97-	CA637IR	14	70	04.97-	CS373	12 1.7
		04.97-	CA638IR	14	80	04.97-	CS594	12 1.4
		02.98-	CA1043IR	14	80	04.97-	CS1177	12 1.7
		02.98-	CA1065IR	14	95			
		PS 07.97-	CA1043IR	14	80			
		PS 07.97-	CA1065IR	14	95			
		PS 07.97-	CA1155IR	14	70			
		ACPS 04.97-	CA1043IR	14	80			
		ACPS 04.97-	CA1065IR	14	95			
		ACPS 07.97-	CA1098IR	14	120			
	[WJY (DW8B)]	09.00-	CA1646IR	14	120	02.99-	CS1177	12 1.7
		02.99-	CA1442IR	14	70	02.99-	CS594	12 1.4
		02.99-	CA1496IR	14	80			
	[WJZ (DW8)]	04.98-	CA1442IR	14	70	04.98-	CS1177	12 1.7
		04.98-	CA1496IR	14	80	04.98-	CS594	12 1.4
		04.98-	CA1646IR	14	120			
Xsara 1.9 TD	[DHY (XUD9TE/Y)]	04.97-	CA1065IR	14	95	04.97-	CS1177	12 1.7
		04.97-	CA637IR	14	70	04.97-	CS594	12 1.4
		04.97-	CA638IR	14	80	07.97-	CS373	12 1.7
		02.98-	CA1043IR	14	80			
		02.98-	CA1098IR	14	120			
		02.98-	CA1155IR	14	70			
		PS 04.97-	CA1043IR	14	80			
		PS 04.97-	CA1155IR	14	70			
		ACPS 07.97-	CA1043IR	14	80			
		AC 04.97-	CA1098IR	14	120			
		AC 07.97-	CA1065IR	14	95			
Xsara 2.0 16V	[RFN (EW10J4)]	09.00-	CA1496IR	14	80	09.00-	CS1244	12 1.1
		09.00-	CA1564IR	14	90			
	[RFS (XU10J4RS)]	04.97-	CA1052IR	14	90	04.97-	CS715	12 1.4
		04.97-	CA1151IR	14	70	04.97-	CS566	12 1.1
		04.97-	CA1152IR	14	80			
	[RFV (XU10J4R)]	07.97-	CA1052IR	14	90	07.97-	CS715	12 1.4
		07.97-	CA1151IR	14	70	07.97-	CS566	12 1.1
		07.97-	CA1152IR	14	80			
Xsara 2.0 16V Picasso	[RFN (EW10J4)]	03.01-	CA1496IR	14	80	03.01-	CS1277	12 1.4
		03.01-	CA1564IR	14	90	03.01-	CS1244	12 1.1
		03.01-	CA1646IR	14	120			
Xsara 2.0 i 16V	[RFS (XU10J4RS)]	02.98-	CA1052IR	14	90	02.98-	CS715	12 1.4
		02.98-	CA1151IR	14	70	02.98-	CS566	12 1.1
		02.98-	CA1152IR	14	80			
Xsara 2.0 HDi	[RHY (DW10TD)]	09.00-	CA1509IR	14	150	02.99-	CS594	12 1.4
		09.00-	CA1674IR	14	150	09.00-	CS712	12 2.2
		02.99-	CA1553IR	14	150	02.99-	CS1177	12 1.7
		02.99-	CA1564IR	14	90	09.00-	CS1342	12 1.9
		02.99-	CA1646IR	14	120			
		AC 02.99-	CA1509IR	14	150			
	[RHZ (DW10ATED)]	05.01-	CA1564IR	14	90	05.01-	CS1177	12 1.7
		AC 05.01-	CA1509IR	14	150			
Xsara 2.0 HDi Picasso	[RHY (DW10TD)]	12.99-	CA1564IR	14	90	12.99-	CS594	12 1.4
		12.99-	CA1646IR	14	120	12.99-	CS1177	12 1.7
		AC 12.99-	CA1509IR	14	150			
ZX 1.1	[H1A]	03.91-	CA617IR	14	50	03.91-	CS390	12 0.9
		03.91-	CA618IR	14	70			
	[HDZ (TU1M)]	03.91-	CA617IR	14	50	03.91-	CS581	12 1.0
		03.91-	CA618IR	14	70			
ZX 1.4	[KDZ (TU3M/Z)]	03.91-	CA617IR	14	50	03.91-	CS390	12 0.9
		03.91-	CA618IR	14	70	03.91-	CS581	12 1.0
		03.91-	CA715IR	14	80			



ZX 1.4 i	[KDX (TU3M/Z)]	03.91- 06.97	CA6171R	14 50	03.91- 06.97	CS581	12 1.0				
		03.91- 06.97	CA6181R	14 70							
		AC 03.91- 06.97	CA7151R	14 80							
	[KDY (TU3M)]	03.91- 08.92	CA6171R	14 50	03.91- 08.92	CS581	12 1.0				
		03.91- 08.92	CA6181R	14 70							
		03.91- 08.92	CA7151R	14 80							
	[KDZ (TU3M/Z)]	03.91- 06.97	CA6171R	14 50	03.91- 06.97	CS581	12 1.0				
		03.91- 06.97	CA6181R	14 70							
		AC 03.91- 06.97	CA7151R	14 80							
	[KFX (TU3JP)]	05.96- 10.97	CA6171R	14 50	05.96- 10.97	CS581	12 1.0				
		05.96- 10.97	CA6181R	14 70							
		06.96- 10.97	CA7151R	14 80							
AC 05.96- 10.97		CA7151R	14 80								
ZX 1.4 Diesel	[K9Y (TUD3Y)]	06.94- 06.97	CA10951R	14 70							
ZX 1.6 i	[BDY (XU5M)]	03.91- 12.94	CA6381R	14 80	03.91- 12.94	CS566	12 1.1				
		03.91- 12.94	CA7301R	14 80							
		03.91- 12.94	CA8201R	14 70							
	[BFZ (XU5JP)]	07.93- 01.94	CA6381R	14 80	07.93- 10.97	CS566	12 1.1				
		07.93- 10.97	CA7301R	14 80							
		07.93- 10.97	CA8201R	14 70							
		07.93- 10.97	CA8251R	14 95							
	ZX 1.8 i 16V	[LFY (XU7JP4)]	01.96- 02.98	CA10521R	14 90	01.96- 02.98	CS566	12 1.1			
			01.96- 06.97	CA11511R	14 70						
			01.96- 02.98	CA11521R	14 80						
ZX 1.8 i	[LFZ (XU7JP)]	07.92- 01.94	CA7301R	14 80	07.92- 10.97	CS566	12 1.1				
		07.92- 10.97	CA8201R	14 70							
		07.92- 10.97	CA8251R	14 95							
		01.94- 10.97	CA10861R	14 80							
		A13 07.92- 10.97	CA7151R	12 1.4							
ZX 1.8 Diesel	[161A (XUD7)]	06.93- 10.97	CA11521R	14 80	06.93- 10.97	CS712	12 2.2				
		06.93- 10.97	CA11551R	14 70							
		06.93- 10.97	CA11551R	14 70							
ZX 1.9	[D6E(XU9JA)]	03.91- 06.97	CA7301R	14 80	03.91- 06.97	CS715	12 1.4				
		03.91- 06.97	CA8201R	14 70							
		03.91- 06.97	CA8251R	14 95							
ZX 1.9 i	[DKZ (XU9JA)]	03.91- 10.97	CA10861R	14 80	A13 03.91- 10.97	CS715	12 1.4				
		03.91- 10.97	CA8201R	14 70							
		03.91- 10.97	CA8251R	14 95							
ZX 1.9 Diesel	[D9B (XUD9A/U)]	03.91- 02.95	CA6361R	14 50	03.91- 10.97	CS594	12 1.4				
		03.91- 06.95	CA6371R	14 70							
		02.95- 10.97	CA10431R	14 80							
		02.95- 10.97	CA10651R	14 95							
		02.95- 10.97	CA10981R	14 120							
		07.95- 10.97	CA11551R	14 70							
		Chas. 6779- 07.95- 10.97	CA11551R	14 70							
		Chas. -6778 03.91- 06.95	CA6371R	14 70							
		Chas. 6629- 02.95- 10.97	CA10431R	14 80							
		Chas. 6629- 02.95- 10.97	CA10651R	14 95							
		Chas. 6629- 02.95- 10.97	CA10981R	14 120							
		Chas. -6628 03.91- 02.95	CA6391R	14 80							
		ACPS 03.91- 02.95	CA6391R	14 80							
		[DJZ (XUD9Y)]	03.91- 04.94	CA6381R				14 80	03.91- 01.98	CS594	12 1.4
			06.95- 01.98	CA10981R				14 120			
			Eng. -6778 03.91- 01.98	CA6361R				14 50			
		Eng. -6778 03.91- 01.98	CA6371R	14 70				A13 03.91- 01.98	CS712	12 2.2	
Chas. -6778 03.91- 04.94	CA6361R	14 50									
Chas. -6628 03.91- 04.94	CA6371R	14 70									
ACPS 03.91- 01.98	CA6391R	14 80									
AC 03.91- 01.98	CA6381R	14 80									
ZX 1.9 TD	[DHY (XUD9TE/Y)]	07.92- 11.95	CA6361R	14 50	A13 07.92- 10.97	CS712	12 2.2				
		07.92- 06.95	CA6371R	14 70							
		07.92- 05.95	CA6381R	14 80							
		02.95- 10.97	CA10431R	14 80							
		02.95- 10.97	CA10651R	14 95							
		02.95- 10.97	CA10981R	14 120							
		07.95- 10.97	CA11551R	14 70							
		Chas. 6629- 07.92- 10.97	CA10431R	14 80							
		Chas. 6629- 07.92- 10.97	CA10651R	14 95							
		Chas. 6629- 07.92- 10.97	CA10981R	14 120							
		ACPS 07.92- 01.95	CA6391R	14 80							
		07.92- 06.97	CA10521R	14 90							
		05.96- 06.97	CA11521R	14 80							
05.96- 06.97	CA11561R	14 120									
[RFT (XU10J4/Z)]	07.92- 10.97	CA10521R	14 90								
	07.92- 10.97	CA11511R	14 70								
	07.92- 10.97	CA11521R	14 80								
	07.92- 10.97	CA11561R	14 120								
	07.92- 10.94	CA7301R	14 80								
	07.92- 10.97	CA8201R	14 70								
	07.92- 10.97	CA8251R	14 95								
[RFY (XU10J4/Z)]	01.94- 10.97	CA10861R	14 80								
	07.92- 10.94	CA10861R	14 80								
	07.92- 10.94	CA7301R	14 80								
	07.92- 10.94	CA8201R	14 70								
ZX 2.0 i	[RFX (XU10J2C)]	Chas. 7175- 06.96- 10.97	CA10521R	14 90	07.92- 10.97	CS715	12 1.4				
		Chas. 7175- 06.96- 10.97	CA11521R	14 80							
		Chas. 7175- 06.96- 10.97	CA11561R	14 120							
		Chas. -7174 07.92- 06.96	CA10861R	14 80							
		Chas. -7174 07.92- 06.96	CA7301R	14 80							
Chas. -7174 07.92- 06.96	CA8251R	14 95									
<b>PASSENGER CARS AO</b>											
AX 1.4 4x4	[K2A]	09.86- 07.92	CA3591R	14 50	09.86- 07.92	CS390	12 0.9				
		09.86- 07.92	CA5331R	14 70							
		AC 09.86- 07.92	CA3691R	14 50							
		AC 09.86- 07.92	CA6391R	14 80							
AX 1.4 Allure		08.92- 04.94	CA3591R	14 50	08.92- 04.94	CS390	12 0.9				
		08.92- 04.94	CA3591R	14 50							
AX 1.4 Diesel 4x4		06.91- 07.92	CA3591R	14 50	06.91- 07.92	CS390	12 0.9				
Berlingo 1.6		11.02-	CA14981R	14 70	11.02-	CS581	12 1.0				
					11.02-	CS390	12 0.9				



**CITROEN Continued**

Berlingo 1.8 Diesel X	[A9A (XUD7)]	11.96- 10.99	CA637IR	14 70	11.96- 10.99	CS1177	12 1.7			
		PS 11.96- 10.99	CA1043IR	14 80						
		PS 11.96- 10.99	CA1155IR	14 70						
		AC 11.96- 10.99	CA1098IR	14 120						
Berlingo 1.9 Diesel	[D9B (XUD9)]	07.96- 10.99	CA1043IR	14 80	07.96- 10.99	CS1177	12 1.7			
		07.96- 10.99	CA637IR	14 70						
		PS 07.96- 10.99	CA1155IR	14 70						
		AC 07.96- 10.99	CA1098IR	14 120						
Berlingo 2.0 HDI 4x4	[RHY (DW10TD)]	11.02- 10.05	CA1442IR	14 70	11.02- 10.05	CS591#	12 1.4			
		11.02- 10.05	CA1496IR	14 80	11.02- 10.05			CS1177		
		11.02- 10.05	CA1564IR	14 90						
		11.02- 10.05	CA1674IR	14 150						
		11.02- 10.05	CA1761IR	14 150						
BX 1.6	[B6D]	01.87- 01.92	CA294IR	14 50	01.87- 01.92	CS326	12 0.85			
BX 1.9 GTI		01.90- 01.92	CA294IR	14 50	01.87- 01.92	CS1177	12 1.7			
					01.90- 01.92	CS326	12 0.85			
BX 1.9 GTI 4x4		02.92- 06.94	CA294IR	14 50	01.90- 01.92	CS1177	12 1.7			
					02.92- 06.94	CS1177	12 1.7			
BX 1.9 TZI		02.92- 12.94	CA532IR	14 80	02.92- 12.94	CS1177	12 1.7			
								02.92- 12.94	CA294IR	14 50
BX 1.9 Diesel RD 4x4		01.87- 01.92	CA294IR	14 50	01.87- 01.92	CS373	12 1.7			
								01.87- 01.92	CA532IR	14 80
BX 1.9 DT TXD		02.92- 12.94	CA294IR	14 50	02.92- 12.94	CS570	12 3.1			
								02.92- 12.94	CA532IR	14 80
C15 1.0 E		11.92- 07.96	CA359IR	14 50	11.92- 07.96	CS390	12 0.9			
								11.92- 07.96	CA291IR	14 50
C15 1.1	[H1A]	11.88- 07.96	CA359IR	14 50	11.88- 07.96	CS390	12 0.9			
C25 1.8		11.81- 01.94	CA150IR	14 50	11.81- 01.94	CS352	12 0.85			
								11.81- 01.94	CA377IR	14 70
C25 2.5 Diesel		11.81- 01.94	CA175IR	14 70	11.81- 01.94	CS361	12 2.2			
C3 1.4 Pluriel Hybrid	[KfV (TU3JP)]	05.05-	CA1665IR	14 80	05.05-	CS581	12 1.0			
		05.05-	CA1681IR	14 90	05.05-	CS390	12 0.9			
		05.05-	CA1687IR	14 70						
C5 3.0	[ES9A]				02.08-	CS1290	12 1.3			
C5 3.0 Carlsson HP		09.04-	CA1388IR	14 150	09.04- 08.04	CS1177	12 1.7			
					09.04-	CS373	12 1.7			
XM 2.0		10.91- 07.94	CA729IR#	14 50	10.91- 07.94	CS566	12 1.1			
					10.91- 07.94	CA820IR	14 70			
					10.91- 07.94	CA556IR	14 80			
XM 2.1 Diesel D12 VSX	[P9A (XUD11A)]	03.96- 08.96	CA1043IR	14 80	03.96- 08.96	CS1177	12 1.7			
								03.96- 08.96	CA1098IR	14 120
XM 3.0		05.89- 07.94	CA556IR	14 80	05.89- 07.94	CS551	12 1.4			
XM 3.0 Pallas		01.90- 07.94	CA556IR	14 80	01.90- 07.94	CS551	12 1.4			
XM 3.0 Pullman		05.89- 07.94	CA556IR	14 80	05.89- 07.94	CS551	12 1.4			
Xsara 1.6 Picasso Chrono		04.01- 10.04	CA1442IR	14 70	04.01- 10.04	CS390	12 0.9			
								04.01- 10.04	CA1496IR	14 80
								04.01- 10.04	CA1499IR	14 80
ZX 1.4 Diesel	[K9Y (TUD3Y)]	07.94- 10.97	CA1095IR	14 70	07.94- 10.97	CS542	12 1.4			
ZX 1.5 Diesel SX	[VJY (TUD5)]	06.96- 02.98	CA1038IR	14 70						
								06.96- 02.98	CA1203IR	14 80
<b>Clark</b>										
<b>FORK LIFTS</b>										
Various Models					01.68-	US815#	12 2.5			
<b>Claas</b>										
<b>AGRICULTURE</b>										
48 3.9	[4.236]	06.78-	CA339IR	14 55						
56 4.1	[4.248]	12.83-	CA76IR	14 33						
66 5.8	[6.354]	12.83- 10.85	CA734IR	14 33						
76 6.1	[6.372]	06.78-	CA339IR	14 55						
85 6.1	[6.372]				10.74- 10.85	CS1121	12 2.4			
85	[OM352]				10.74- 05.76	CS186	12 3.0			
86 5.7	[OM352]	06.78-	CA339IR	14 55						
96 5.7	[OM352]	09.79- 10.85	CA339IR	14 55						
96	[OM352]	06.78-	CA339IR	14 55						
105	[OM360]	04.82-	CA339IR	14 55						
690 14.6	[OM422]				10.74- 10.89	CS191	24 5.4			
850			CA1831IR	14 150						
Combines		01.99-	CA1335IR	14 120						
Various Models						CS1123	12 3.0			
<b>Cummins</b>										
<b>MOTORS</b>										
Engine		01.91- 01.92	UA1620IR	28 70						
Various Models		01.87-	CA1193IR	28 55	01.87-	US857	24 4.5			
<b>Dacia</b>										
<b>PASSENGER CARS EU</b>										
1300 1.3	[810-02..]				12.72- 05.83	CS95	12 0.6			
1310 1.3	[810-02..]				05.83-	CS95	12 0.6			
Duster 1.5 DCi	[K9K796]	04.10-	CA1762IR	14 110	04.10-	CS1332	12 1.4			
		04.10-	CA1933IR	14 125						
		10.10-	CA1762IR	14 110						
		10.10-	CA1933IR	14 125						
		06.10-	CA1933IR	14 125						
Duster 1.5 DCi 4x4	[K9K894]	10.10-	CA1762IR	14 110						
		10.10-	CA1933IR	14 125						
		06.10-	CA1933IR	14 125						
Duster 1.6 16V	[K4M690]	04.10-	CA1762IR	14 110	04.10-	CS1276	12 0.85			
		04.10-	CA2043IR	14 110						
Duster 1.6 16V 4x4	[K4M696]	06.10-	CA1762IR	14 110	06.10-	CS1276	12 0.85			
		06.10-	CA2043IR	14 110						
		06.10-	CA2098IR*	14 90						
Duster 1.6 16V LPG	[K4M696]	04.11-	CA1762IR	14 110	04.11-	CS1276	12 0.85			
		04.11-	CA2043IR	14 110						
		04.11-	CA2098IR*	14 90						
Logan 1.1 16V	[D4F732]	02.06-	CA1976IR	14 95	02.06-	CS1385	12 0.85			
Logan 1.4	[K7J710]	02.07-	CA1470IR	14 98	02.07-	CS1186	12 1.0			
		02.07-	CA1484IR	14 75	02.07-	CS1442	12 0.8			
Logan 1.4 Express	[K7J710]	03.09-	CA1470IR	14 98	03.09-	CS1442	12 0.8			
		03.09-	CA1484IR	14 75						
Logan 1.4 i	[K7J710]	PS 07.04-	CA1484IR	14 75	09.04-	CS1442	12 0.8			
		ACPS 07.04-	CA1470IR	14 98						
Logan 1.4 MPi	[K7J710]	02.06-	CA1470IR	14 98	02.06-	CS1276	12 0.85			
		02.06-	CA1484IR	14 75	02.06-	CS1442	12 0.8			



Logan 1.5 DCi	[K9K790]	09.05-09.05-AC 09.05-	CA1881IR	14	120	09.05-	CS1273	12	1.1
			CA1948IR	14	110				
			CA1933IR	14	125				
	[K9K792]	01.06-01.06-03.08-AC 01.06-	CA1881IR	14	120	01.06-	CS1332	12	1.4
			CA1948IR	14	110				
			CA1933IR	14	125				
			CA1933IR	14	125				
	[K9K796]	09.07-	CA1933IR	14	125	09.07-	CS1332	12	1.4
	[K9K892]	05.10-05.10-	CA1762IR	14	110				
			CA1933IR	14	125				
Logan 1.5 DCi Express	[K9K792]	03.09-03.09-03.09-	CA1881IR	14	120	03.09-	CS1332	12	1.4
			CA1933IR	14	125				
			CA1948IR	14	110				
	[K9K796]	03.09-	CA1933IR	14	125	03.09-	CS1332	12	1.4
Logan 1.5 DCi MCV	[K9K796]	09.07-	CA1933IR	14	125	09.07-	CS1332	12	1.4
Logan 1.6	[K7M710]	02.07-02.07-	CA1470IR	14	98	02.07-	CS1442	12	0.8
			CA1484IR	14	75	02.07-	CS1186	12	1.0
Logan 1.6 Express	[K7M710]	03.09-	CA1470IR	14	98	03.09-	CS1442	12	0.8
Logan 1.6 16V	[K4M690]	02.06-02.06-	CA1628IR	14	98	02.06-	CS1186	12	1.0
			CA2043IR	14	110				
Logan 1.6 16V MCV	[K4M690]	02.07-02.07-	CA1470IR	14	98	02.07-	CS1276	12	0.85
			CA2043IR	14	110				
Logan 1.6 i	[K7M710]	PS 07.04-ACPS 07.04-	CA1484IR	14	75	09.04-	CS1186	12	1.0
			CA1470IR	14	98	09.04-	CS1442	12	0.8
Logan 1.6 MPI 85	[K7M800]	05.10-	CA2098IR*	14	90				
Logan 1.6 LPG	[K7M710]	11.08-11.08-	CA1470IR	14	98	11.08-	CS1276	12	0.85
			CA1484IR	14	75	11.08-	CS1442	12	0.8
Logan 1.6 16V Flexifuel	[K4M690]	11.09-11.09-	CA1762IR	14	110	11.09-	CS1276	12	0.85
			CA2043IR	14	110				
	[K4M694]	11.09-11.09-	CA1762IR	14	110	11.09-	CS1276	12	0.85
			CA2043IR	14	110				
Logan 1.6 Bifuel Express BiFuel		05.10-	CA2098IR*	14	90				
Sandero 1.2 16V	[D4F732]	11.08-	CA1976IR	14	95	11.08-	CS1385	12	0.85
Sandero 1.2 Flexifuel		11.08-	CA1976IR	14	95	11.08-	CS1385	12	0.85
Sandero 1.4	[K7J710]	06.08-06.08-	CA1470IR	14	98	06.08-	CS1442	12	0.8
			CA1484IR	14	75	06.08-	CS1186	12	1.0
Sandero 1.4 MPI LPG	[K7J714]	01.09-01.09-01.09-01.09-	CA1470IR	14	98	01.09-	CS1442	12	0.8
			CA1484IR	14	75				
			CA1628IR	14	98				
			CA2098IR*	14	90				
Sandero 1.5 DCi	[K9K792]	11.08-11.08-11.08-11.08-	CA1762IR	14	110	11.08-	CS1332	12	1.4
			CA1881IR	14	120				
			CA1933IR	14	125				
			CA1948IR	14	110				
	[K9K796]	11.08-11.08-	CA1762IR	14	110	11.08-	CS1332	12	1.4
			CA1933IR	14	125				
Sandero 1.6	[K7M710]	06.08-06.08-	CA1470IR	14	98	06.08-	CS1186	12	1.0
			CA1484IR	14	75	06.08-	CS1442	12	0.8
Sandero 1.6 MPI 85	[K7M800]	05.10-	CA2098IR*	14	90				
<b>PASSENGER CARS AO</b>									
1410 1.4		09.85-12.98	CA165IR	14	50	09.85-12.98	CS95	12	0.6
<b>Daewoo</b>									
<b>PASSENGER CARS EU</b>									
Espero 1.5						10.97-09.99	CS1183	12	0.9
Espero 1.5 16V	[A15MF]	02.95-02.95-	CA1385IR	14	80	02.95-	CS519	12	1.0
			CA1396IR	14	75				
						10.93-09.94	CS1183	12	0.9
Espero 1.8	[C18LE]	02.95-	CA1386IR	14	80	02.95-	CS727	12	1.1
Espero 2.0	[C20LE]	02.95-	CA1386IR	14	80	02.95-	CS727	12	1.1
	[C20LZ]					10.91-09.93	CS727	12	1.1
						10.93-09.94	CS727	12	1.1
Evanda 2.0	[L88]					08.02-01.05	CS879	12	1.1
Kalos 1.2	[B12S1]	04.03-02.05-04.03-02.05	CA2023IR	14	80	04.03-02.05	CS1422	12	0.8
			JA1600IR	14	65 ▲				
Kalos 1.4	[F14S3]					11.02-12.04	CS519	12	1.0
						09.02-	CS519	12	1.0
Kalos 1.4 16V	[F14D3]					04.03-	CS519	12	1.0
Korando 2.0 16V	[M161E20]	07.96-12.00-07.96-12.00	CA1057IR	14	120	07.96-12.00	CS327	12	1.4
			CA1685IR	14	75				
Korando 2.3	[M161E23]	07.96-12.00-07.96-12.00	CA1057IR	14	120	07.96-12.00	CS1075	12	1.2
			CA1685IR	14	75				
		02.99-	CA1685IR	14	75	02.99-	CS1075	12	1.2
Korando 2.9 Diesel	[OM662]	01.99-02.99-	CA1685IR	14	75	01.99-	CS331	12	2.2
			CA1062IR	14	90				
Korando 2.9 TD	[OM60129TD]	01.99-	CA1685IR	14	75	07.96-12.00	CS331	12	2.2
Korando 3.2	[M104.995]	01.99-	CA1685IR	14	75	01.99-	CS360	12	1.7
Lacetti 1.4	[F14D3]					03.04-01.05	CS519	12	1.0
Lacetti 1.6	[F16D3]					02.04-01.05	CS519	12	1.0
Lacetti 1.8	[T18SED]					02.04-01.05	CS879	12	1.1
Lanos 1.4	[A14SMS]	05.97-	CA1671IR	14	85	05.97-	CS519	12	1.0
Lanos 1.5	[A15SMS]	05.97-	CA1671IR	14	85	05.97-	CS519	12	1.0
	[Y15L]	05.97-	CA1671IR	14	85	05.97-	CS519	12	1.0
Lanos 1.6 16V	[A16DMS]	05.97-09.03	CA1671IR	14	85	05.97-09.03	CS519	12	1.0
Leganza 2.0		01.01-12.02	CA1745IR	14	85	01.01-12.02	CS879	12	1.1
Leganza 2.0 16V	[X20SED]	06.97-12.02	CA1745IR	14	85	06.97-12.02	CS879	12	1.1
Leganza 2.2 16V	[T22SED]					04.99-12.02	CS879	12	1.1
Matiz 0.8	[F8CV]	09.98-	JA1600IR	14	65	09.98-01.05	CS1210	12	1.0
Matiz 1.0	[B10S]	01.03-	JA1600IR	14	65	01.03-	CS1422	12	0.8
Musso 2.3	[M111.970]	01.99-	CA1685IR	14	75	01.99-	CS1075	12	1.2
Musso 2.3 TD	[OM601]	09.99-	CA1685IR	14	75	09.99-	CS331	12	2.2
Musso 2.9 Diesel	[OM662]	01.99-09.99	CA1685IR	14	75	01.99-09.99	CS331	12	2.2
Musso 2.9 TD	[OM60129TD]	01.99-	CA1685IR	14	75	01.99-	CS331	12	2.2
Musso 3.2	[M104.992]	01.99-	CA1685IR	14	75	01.99-	CS1075	12	1.2
Nexia 1.5	[G15MF]	02.95-08.97-02.95-08.97	CA1385IR	14	80	08.96-08.97	CS1183	12	0.9
			CA1396IR	14	75	02.95-08.97	CS519	12	1.0
Nexia 1.5 16V	[A15MF]	02.95-08.97-02.95-08.97	CA1385IR	14	80	02.95-08.97	CS519	12	1.0
			CA1396IR	14	75				
Nubira 1.4	[F14D3]					10.03-12.04	CS519	12	1.0
Nubira 1.6	[F16D3]					07.03-	CS519	12	1.0
Nubira 1.6 16V	[A16DMS]	05.97-09.99-06.97-	CA1672IR	14	85	05.97-07.03	CS519	12	1.0
			CA1672IR	14	85	06.97-	CS519	12	1.0
Nubira 1.8	[T18SED]					07.03-	CS879	12	1.1
		04.97-05.99	CA1745IR	14	85	04.97-05.99	CS519	12	1.0



**DAEWOO Continued**

Nubira 2.0 16V	[T20SED]	12.00-	CA1745IR	14 85	Chas. 730873- 12.00-	CS879	12 1.1
	[X20SED]	05.97-	CA1745IR	14 85	Chas. -730872 12.00-	CS519	12 1.0
	[Z20L]	05.97-	CA1745IR	14 85	05.97-	CS879	12 1.1
					05.97-	CS879	12 1.1
Rezzo 3.2 V6		04.02-	CA1685IR	14 75			
Rezzo/Tacuma 1.6	[A16DMS]				Chas. -732867 09.00- 01.05	CS1183	12 0.9
					Chas. 732868- 09.00- 01.05	CS1188	12 1.1
Rezzo/Tacuma 1.8	[A18DMS]				09.00- 01.05	CS519	12 1.0
	[F18D2]				09.00-	CS519	12 1.0
					09.00- 01.05	CS519	12 1.0
Rezzo/Tacuma 2.0	[X20SED]	09.01-	CA1745IR	14 85	09.01- 01.05	CS879	12 1.1
		09.00- 01.05	CA1745IR	14 85	09.00- 01.05	CS879	12 1.1
<b>PASSENGER CARS US</b>							
Leganza 2.2					01.99- 01.00	CS879	12 1.1
Nubira 2.0					01.99- 01.00	CS879	12 1.1
<b>PASSENGER CARS AO</b>							
Lacetti 1.8 CDX	[T18SED]				08.03- 12.04	CS519	12 1.0
Leganza 1.8 CD	[C18LE]				06.97- 07.03	CS519	12 1.0
					06.97- 07.03	CS879	12 1.1
Nubira 2.0	[C20SED]	06.99- 07.03	CA1745IR	14 85	Chas. -730872 06.99- 07.03	CS519	12 1.0
					Chas. 730873- 06.99- 07.03	CS879	12 1.1
Nubira 2.0 CDX	[T20SED]	08.02- 07.03	CA1745IR	14 85	Chas. -730872 08.02- 07.03	CS519	12 1.0
					Chas. 730873- 08.02- 07.03	CS879	12 1.1
Rezzo 1.6 SX					08.01- 12.04	CS519	12 1.0
					08.01- 12.04	CS1183	12 0.9
<b>DAF</b>							
<b>PASSENGER CARS EU</b>							
44 0.8	[B85]	07.72- 09.74	CA35IR	14 35			
55 1.1	[DBB110E]				10.67- 09.72	CS95	12 0.6
428-435 2.5 Diesel	[EN55]				04.89- 08.93	CS524	12 2.2
428-435 2.5 TD	[ET70]				04.89- 08.93	CS524	12 2.2
<b>TRUCKS EU</b>							
45.120 5.9	[CD85]	05.91-	CA1050IR	28 30	05.91- 12.00	CS989	24 4.0
45.130 5.9	[CN96]	05.91- 12.00	CA1050IR	28 30	05.91- 12.00	CS989	24 4.0
	[CS97M]	05.91- 12.00	CA1050IR	28 30	05.91- 12.00	CS989	24 4.0
	[CT97]	05.91- 12.00	CA1050IR	28 30	05.91- 12.00	CS989	24 4.0
45.150 5.9	[CB108]	05.91-	CA1050IR	28 30	05.91- 12.00	CS989	24 4.0
	[CS107M]	05.91-	CA1050IR	28 30	05.91- 12.00	CS989	24 4.0
	[CT108]	05.91-	CA1050IR	28 30	05.91- 12.00	CS989	24 4.0
45.160 5.9	[CS119]	05.91- 12.00	CA1050IR	28 30	05.91- 12.00	CS989	24 4.0
	[CT119]	05.91- 12.00	CA1050IR	28 30	05.91- 12.00	CS989	24 4.0
45.180 5.9	[CS133M]	05.95-	CA1050IR	28 30	05.95- 12.00	CS989	24 4.0
45.210 5.9	[CS158M]	05.95-	CA1050IR	28 30	05.95- 12.00	CS989	24 4.0
65.180 6.2	[NS133L]	03.93- 02.98	CA1035IR	28 80	03.93- 02.98	CS388	24 4.0
		03.93- 02.98	CA333IR	28 55			
	[NS133M]	03.93- 02.98	CA333IR	28 55	03.93- 02.98	CS388	24 4.0
65.210 6.2	[NS156L]	03.93- 02.98	CA1035IR	28 80	03.93- 02.98	CS388	24 4.0
		03.93- 02.98	CA333IR	28 55			
	[NS156M]	03.93- 02.98	CA333IR	28 55	03.93- 02.98	CS388	24 4.0
65.240 6.2	[NS177M]	05.96- 02.98	CA333IR	28 55	05.96- 02.98	CS388	24 4.0
75.240 8.7	[RS180]	07.92- 02.98	CA1035IR	28 80	07.92- 02.98	CS1129	24 5.2
		07.92- 02.98	CA333IR	28 55	07.92- 02.98	CS1331	24 4.0
	[RS180L]	07.92- 02.98	CA1035IR	28 80	07.92- 02.98	CS1331	24 4.0
		07.92- 02.98	CA333IR	28 55	07.92- 02.98	CS1129	24 5.2
	[RS180M]	07.92- 02.98	CA1035IR	28 80	07.92- 02.98	CS1129	24 5.2
75.270 8.7	[RS200]	07.92- 02.98	CA1035IR	28 80	07.92- 02.98	CS1331	24 4.0
		07.92- 02.98	CA333IR	28 55	07.92- 02.98	CS1129	24 5.2
	[RS200L]	07.92- 02.98	CA1035IR	28 80	07.92- 02.98	CS1129	24 5.2
		07.92- 02.98	CA333IR	28 55	07.92- 02.98	CS1331	24 4.0
	[RS200M]	07.92- 02.98	CA1035IR	28 80	07.92- 02.98	CS1129	24 5.2
75.300 8.7	[RS222]	07.92- 02.98	CA1035IR	28 80	07.92- 02.98	CS1129	24 5.2
		07.92- 02.98	CA333IR	28 55	07.92- 02.98	CS1331	24 4.0
	[RS222 L]	07.92- 02.98	CA1035IR	28 80	07.92- 02.98	CS1129	24 5.2
		07.92- 02.98	CA333IR	28 55	07.92- 02.98	CS1331	24 4.0
	[RS222L]	07.92- 02.98	CA1035IR	28 80	07.92- 02.98	CS1331	24 4.0
		07.92- 02.98	CA333IR	28 55	07.92- 02.98	CS1129	24 5.2
85.330 11.6	[WS242]	07.92- 02.98	CA1035IR	28 80	07.92- 02.98	CS617	24 5.4
		07.92- 02.98	CA333IR	28 55			
	[WS242L]	07.92- 02.98	CA1035IR	28 80	07.92- 02.98	CS617	24 5.4
		07.92- 02.98	CA333IR	28 55			
	[WS242M]	07.92- 02.98	CA1035IR	28 80	07.92- 02.98	CS617	24 5.4
85.360 11.6	[WS268]	07.92- 02.98	CA1035IR	28 80	07.92- 02.98	CS617	24 5.4
		07.92- 02.98	CA333IR	28 55			
	[WS268L]	07.92- 02.98	CA1035IR	28 80	07.92- 02.98	CS617	24 5.4
		07.92- 02.98	CA333IR	28 55			
	[WS268M]	07.92- 02.98	CA1035IR	28 80	07.92- 02.98	CS617	24 5.4
85.400 11.6	[WS295M]	03.95- 02.98	CA1035IR	28 80	03.95- 02.98	CS617	24 5.4
		03.95- 02.98	CA333IR	28 55			
95.310 11.6	[WS225]	09.87-	CA1035IR	28 80	09.87-	CS617	24 5.4
		09.87-	CA240IR	28 55			
		05.93-	CA1770IR#	28 140			
95.330 11.6	[WS242]	08.90- 04.97	CA1035IR	28 80	08.90- 04.97	CS617	24 5.4
		08.90- 04.97	CA240IR	28 55			
		05.93- 04.97	CA1770IR#	28 140			
95.350 11.6	[WS259]	09.87-	CA240IR	28 55	09.87-	CS617	24 5.4
		04.88-	CA1035IR	28 80			
		05.93-	CA1770IR#	28 140			
95.360 11.6	[WS268]	08.90- 04.97	CA1035IR	28 80	08.90- 01.98	CS617	24 5.4
		08.90- 01.98	CA1770IR#	28 140			
		08.90- 04.97	CA240IR	28 55			
		08.90- 01.98	CA333IR	28 55			
	[WS268G]	08.90- 04.97	CA1035IR	28 80	08.90- 04.97	CS617	24 5.4
		08.90- 04.97	CA240IR	28 55			
		05.93- 04.97	CA1770IR#	28 140			
	[WS268L]	08.90- 04.97	CA1035IR	28 80	09.87- 04.97	CS617	24 5.4
		08.90- 04.97	CA240IR	28 55			
		05.93- 04.97	CA1770IR#	28 140			



	[WS268M]	08.90- 04.97 08.90- 04.97 03.93- 04.97	CA1035IR 28 80 CA240IR 28 55 CA1770IR# 28 140		08.90- 04.97	CS617	24 5.4	
95.380 11.6	[WS282]	09.87- 08.90- 05.93-	CA240IR 28 55 CA1035IR 28 80 CA1770IR# 28 140		09.87- 09.90	CS617	24 5.4	
95.400 11.6	[WS295]	08.90- 04.97 08.90- 04.97 08.90- 01.98 05.93- 04.97	CA1035IR 28 80 CA240IR 28 55 CA333IR 28 55 CA1770IR# 28 140		08.90- 01.98	CS617	24 5.4	
	[WS295G]	08.90- 04.97 08.90- 04.97 05.93- 04.97	CA1035IR 28 80 CA240IR 28 55 CA1770IR# 28 140		08.90- 04.97	CS617	24 5.4	
	[WS295L]	08.90- 04.97 08.90- 04.97 05.93- 04.97	CA1035IR 28 80 CA240IR 28 55 CA1770IR# 28 140		08.90- 04.97	CS617	24 5.4	
	[WS295M]	08.90- 04.97 08.90- 04.97 03.93- 04.97	CA1035IR 28 80 CA240IR 28 55 CA1770IR# 28 140		03.93- 04.97	CS617	24 5.4	
95.430 11.6	[WS315]	02.92- 04.97 02.92- 04.97 02.92- 01.98 07.92- 04.97	CA1035IR 28 80 CA240IR 28 55 CA333IR 28 55 CA1770IR# 28 140		02.92- 01.98	CS617	24 5.4	
	[WS315G]	02.92- 02.92- 02.92-	CA1035IR 28 80 CA1770IR# 28 140 CA240IR 28 55		02.92-	CS617	24 5.4	
	[WS315L]	02.92- 04.97 02.92- 04.97 02.92- 04.97	CA1035IR 28 80 CA1770IR# 28 140 CA240IR 28 55		02.92- 04.97	CS617	24 5.4	
	[WS315M]	02.92- 04.97 02.92- 04.97 02.92- 04.97	CA1035IR 28 80 CA1770IR# 28 140 CA240IR 28 55		07.91- 04.97	CS617	24 5.4	
	55.180 B13 5.9	[CS133M]	11.95-	CA1050IR 28 30		11.95-	CS989	24 4.0
	55.180 B15 5.9	[CS133M]	11.95-	CA1050IR 28 30		11.95-	CS989	24 4.0
	55.210 B13 5.9	[CS158M]	11.95-	CA1050IR 28 30		11.95-	CS989	24 4.0
	55.210 B15 5.9	[CS158M]	11.95-	CA1050IR 28 30		11.95-	CS989	24 4.0
55.210 B21 5.9	[CS158M]	11.95-	CA1050IR 28 30		11.95-	CS989	24 4.0	
55.230 B13 5.9	[CS173M]	11.95-	CA1050IR 28 30		11.95-	CS989	24 4.0	
55.230 B15 5.9	[CS173M]	11.95-	CA1050IR 28 30		11.95-	CS989	24 4.0	
65 CF.180 6.2	[NS133M]	02.98-	CA333IR 28 55		02.98- 12.00	CS388	24 4.0	
65 CF.210 6.2	[NS156M]	02.98-	CA333IR 28 55		02.98- 12.00	CS388	24 4.0	
65 CF.240 6.2	[NS177M]	02.98-	CA333IR 28 55		02.98- 12.00	CS388	24 4.0	
75 CF.250 9.2	[PF183M]	01.98- 12.00 01.98- 12.00 01.98- 12.00 01.98- 12.00	CA1035IR 28 80 CA1693IR 28 110 CA1694IR 28 80 CA333IR 28 55		01.98- 12.00	CS1274 CS1331	24 6.2 24 4.0	
	[PF212M]	01.98- 12.00 01.98- 12.00	CA1035IR 28 80 CA333IR 28 55		01.98- 12.00	CS1331 CS1274	24 4.0 24 6.2	
	[PF212M]	01.98- 12.00 01.98- 12.00	CA1035IR 28 80 CA333IR 28 55		01.98- 12.00	CS1331 CS1274	24 4.0 24 6.2	
	[PF235M]	01.98- 12.00 01.98- 12.00	CA1035IR 28 80 CA333IR 28 55		01.98- 12.00	CS1331 CS1274	24 4.0 24 6.2	
	[XF250M]	01.98- 04.01 01.98- 04.01 01.98- 04.01 01.98- 04.01	CA1035IR 28 80 CA1693IR 28 110 CA1694IR 28 80 CA333IR 28 55		01.98- 12.00	CS1274	24 6.2	
85 CF.380 12.6	[XF280M]	01.98- 12.00 01.98- 12.00 01.98- 12.00 01.98- 12.00	CA1035IR 28 80 CA1693IR 28 110 CA1694IR 28 80 CA333IR 28 55		01.98- 12.00	CS1274	24 6.2	
	[XF315M]	01.98- 12.00 01.98- 12.00 01.98- 12.00 01.98- 12.00	CA1035IR 28 80 CA1693IR 28 110 CA1694IR 28 80 CA333IR 28 55		01.98- 12.00	CS1274	24 6.2	
	[BM74]	01.97- 09.02 01.97- 09.02	CA1035IR 28 80 CA333IR 28 55		01.97- 09.02	CS1274	24 6.2	
	[XF280M]	01.97- 09.02 01.97- 09.02	CA1035IR 28 80 CA333IR 28 55		01.97- 09.02	CS1274	24 6.2	
95 XF.430 12.6	[XF315M]	01.97- 09.02 01.97- 09.02	CA1035IR 28 80 CA333IR 28 55		01.97- 09.02	CS1274	24 6.2	
95 XF.480 12.6	[XF355M]	01.97- 09.02 01.97- 09.02	CA1035IR 28 80 CA333IR 28 55		01.97- 09.02	CS1274	24 6.2	
95 XF.530 12.6	[XE390C]	02.01- 09.02 02.01- 09.02	CA1035IR 28 80 CA333IR 28 55		02.01-	CS1380	24 5.5	
95 XF.530 14.0	[VF390M]	01.97- 09.02 01.97- 09.02	CA1035IR 28 80 CA333IR 28 55		01.97- 09.02	CS1274	24 6.2	
CF 65.180 5.9	[CE136C]				04.01-	CS1382	24 4.0	
CF 65.220 5.9	[CE162C]				04.01-	CS1382	24 4.0	
CF 65.220 6.7	[GR165S1]				05.06-	CS1382	24 4.0	
CF 65.250 5.9	[CE184C]				05.06-	CS388	24 4.0	
CF 65.250 6.7	[GR184S1]				04.01-	CS1382	24 4.0	
CF 65.290 6.7	[GR210S1]				05.06-	CS1382	24 4.0	
CF 75.250 9.2	[PE183C]	01.01- 01.01-	CA1693IR 28 110 CA1694IR 28 80		01.01- 01.01-	CS1331 CS1486*	24 4.0 24 4.0 A45	
	[PR183S]	01.01- 01.01-	CA1693IR 28 110 CA1694IR 28 80		01.01- 01.01-	CS1486* CS1331	24 4.0 A45 24 4.0	
	[PE228C]	01.01- 01.01-	CA1693IR 28 110 CA1694IR 28 80		01.01- 01.01-	CS1331 CS1486*	24 4.0 24 4.0 A45	
	[PR228S]	01.01- 01.01-	CA1693IR 28 110 CA1694IR 28 80		01.01- 01.01-	CS1486* CS1331	24 4.0 A45 24 4.0	
CF 75.310 9.2	[PR265S]				01.01- 01.01-	CS1331 CS1486*	24 4.0 24 4.0 A45	
	[PE265C]	01.01- 01.01-	CA1693IR 28 110 CA1694IR 28 80		01.01- 01.01-	CS1331	24 4.0	
CF 85.340 12.6	[XE250C]	01.01- 01.01- 01.97-	CA1693IR 28 110 CA1694IR 28 80 CA1035IR 28 80 CA333IR 28 55		01.01- 01.01-	CS1274 CS1380	24 6.2 24 5.5	
	[MX265]	04.07- 04.07-	CA1693IR 28 110 CA1694IR 28 80		04.07-	CS1380	24 5.5	



**DAF Continued**

CF 85.360 12.9	[MX265]	10.06-10.06-	CA1917IR 28 80 CA1939IR 28 110	10.06-	CS1420	24 5.5
CF 85.380 12.6	[XE280C]	01.01-01.01-04.01-12.05-12.05-	CA1693IR 28 110 CA1694IR 28 80 CA1035IR 28 80 CA1917IR 28 80 CA1939IR 28 110 CA333IR 28 55	01.01-01.01-12.05-	CS1380 CS1274 CS1420	24 5.5 24 6.2 24 5.5
CF 85.410 12.9	[MX300]	10.05-10.05-	CA1917IR 28 80 CA1939IR 28 110	10.05-	CS1420	24 5.5
CF 85.430 12.6	[XE315C]	01.01-04.01-	CA1694IR 28 80 CA333IR 28 55 CA1693IR 28 110	01.01-01.01-	CS1274 CS1380	24 6.2 24 5.5
CF 85.460 12.9	[MX340]	10.05-10.05-	CA1917IR 28 80 CA1939IR 28 110	10.05-	CS1420	24 5.5
CF 85.480 12.6	[XE356C]	01.01-	CA1694IR 28 80 CA1693IR 28 110	01.01-01.01-	CS1274 CS1380	24 6.2 24 5.5
CF 85.510 12.9	[MX375]	10.05-10.05-	CA1917IR 28 80 CA1939IR 28 110	10.05-	CS1420	24 5.5
F 1100 5.8	[DD575]			01.78- 12.81	CS388	24 4.0
F 1100 6.2	[DNTD620]	12.86- 11.90 12.86- 11.90	CA240IR 28 55 CA334IR 28 35	12.86- 11.90	CS388	24 4.0
F 1200 5.8	[DD575]	05.77- 12.81 05.77- 12.81	CA240IR 28 55 CA334IR 28 35	01.77- 12.81	CS388	24 4.0
F 1300 6.2	[DF615]	07.78- 10.88 07.78- 10.88	CA240IR 28 55 CA334IR 28 35	07.78- 10.88	CS388	24 4.0
	[DNT620]	12.86- 12.92	CA240IR 28 55	12.86- 12.92	CS388	24 4.0
	[DNTD620]	12.86- 12.92	CA240IR 28 55 CA334IR 28 35	12.86- 12.92	CS388	24 4.0
	[DT615]	07.78- 02.90 07.78- 02.90	CA240IR 28 55 CA334IR 28 35	07.78- 02.90	CS388	24 4.0
	[NT116]	12.86- 12.92	CA240IR 28 55	12.86- 12.92	CS388	24 4.0
	[NT133]	12.86- 12.92	CA240IR 28 55	12.86- 12.92	CS388	24 4.0
F 1305 6.2	[DT615]	07.78- 02.90 07.78- 02.90	CA240IR 28 55 CA334IR 28 35	07.78- 02.90	CS388	24 4.0
F 1400 5.8	[DD575]	02.72- 12.81 02.72- 12.81	CA240IR 28 55 CA334IR 28 35	02.72- 12.81	CS388	24 4.0
F 1500 6.2	[DF615]	07.78- 08.91 07.78- 08.91	CA240IR 28 55 CA334IR 28 35	07.78- 08.91	CS388	24 4.0
	[DT615]	07.78- 08.91 07.78- 08.91	CA240IR 28 55 CA334IR 28 35	07.78- 08.91	CS388	24 4.0
F 1600 6.2	[DF615]	01.70- 08.91 01.70- 08.91	CA240IR 28 55 CA334IR 28 35	01.70- 08.91	CS388	24 4.0
	[DT615]	05.77- 08.91 05.77- 08.91	CA240IR 28 55 CA334IR 28 35	11.73- 08.91	CS388	24 4.0
F 1700 6.2	[DNS620]	01.88- 02.95 01.88- 02.95	CA240IR 28 55 CA334IR 28 35	01.88- 02.95	CS388	24 4.0
	[DNT620]	12.86- 02.95	CA240IR 28 55	12.86- 02.95	CS388	24 4.0
	[DNTD620]	12.86- 02.95 12.86- 02.95	CA240IR 28 55 CA334IR 28 35	12.86- 02.95	CS388	24 4.0
	[NT116]	12.86- 02.95	CA240IR 28 55	12.86- 02.95	CS388	24 4.0
	[NT133]	12.86- 02.95 12.86- 02.95	CA1035IR 28 80 CA240IR 28 55 CA334IR 28 35	12.86- 02.95	CS388	24 4.0
F 1800 6.2	[DT615]	05.77- 08.91 05.77- 08.91	CA240IR 28 55 CA334IR 28 35	11.73- 08.91	CS388	24 4.0
F 1900 6.2	[DNS620]	12.86- 09.93 12.86- 09.93 12.86- 09.93	CA1035IR 28 80 CA240IR 28 55 CA334IR 28 35	12.86- 09.93	CS388	24 4.0
	[DNT620]	12.86- 09.93	CA240IR 28 55	12.86- 09.93	CS388	24 4.0
F 2000 8.3	[DH825]	12.79	CA334IR 28 35	02.75- 12.79	CS387	24 5.0
F 2100 6.2	[DF615]	07.78- 09.86 07.78- 09.86	CA240IR 28 55 CA334IR 28 35	07.78- 09.86	CS388	24 4.0
F 2100 8.3	[DH825]	07.78- 08.91 07.78- 08.91	CA240IR 28 55 CA334IR 28 35	07.78- 09.86	CS387	24 5.0
	[DHR825]	07.78- 08.91 07.78- 08.91	CA240IR 28 55 CA334IR 28 35	07.78- 08.91	CS387	24 5.0
F 2103 8.3	[DH825]	07.78- 08.91 07.78- 08.91	CA240IR 28 55 CA334IR 28 35	07.78- 08.91	CS387	24 5.0
	[DHT825]	07.81- 09.86 07.81- 09.86	CA240IR 28 55 CA334IR 28 35	07.81- 09.86	CS387 CS1129	24 5.0 24 5.2
	[DHTD825]	07.78- 08.91 07.78- 08.91	CA240IR 28 55 CA334IR 28 35	07.78- 08.91	CS387	24 5.0
F 2105 6.2	[DF615]	07.78- 08.91 07.78- 08.91	CA240IR 28 55 CA334IR 28 35	07.78- 08.91	CS388	24 4.0
F 2105 8.3	[DH825]	07.78- 08.91 07.78- 08.91	CA240IR 28 55 CA334IR 28 35	07.78- 08.91	CS387	24 5.0
	[DHR825]	07.78- 09.86 07.78- 09.86	CA240IR 28 55 CA334IR 28 35	07.78- 09.86	CS387	24 5.0
	[DHT825]	07.81- 08.91 07.81- 08.91	CA240IR 28 55 CA334IR 28 35	07.81- 08.91	CS387	24 5.0
	[DHTD825]	07.78- 08.91 07.78- 08.91	CA240IR 28 55 CA334IR 28 35	07.78- 08.91	CS387	24 5.0
F 2200 8.3	[DU825]	05.77- 11.80	CA334IR 28 35	02.75- 11.80	CS387	24 5.0
F 2205 8.3	[DU825]	05.77- 11.80	CA334IR 28 35	02.75- 11.80	CS387	24 5.0
F 2300 8.3	[DHR825]	07.78- 12.81 07.78- 12.81	CA240IR 28 55 CA334IR 28 35	07.78- 12.81	CS387	24 5.0
	[DHT825]	11.81- 08.91 11.81- 08.91	CA240IR 28 55 CA334IR 28 35	11.81- 08.91	CS387	24 5.0
	[DHTD825]	06.86- 08.91 06.86- 08.91	CA240IR 28 55 CA334IR 28 35			
	[DHU825]	07.78- 12.83 07.78- 12.83	CA240IR 28 55 CA334IR 28 35	07.78- 12.83	CS387	24 5.0
F 2305 8.3	[DH825]	07.78- 12.81 07.78- 12.81	CA240IR 28 55 CA334IR 28 35	07.78- 12.81	CS387	24 5.0
	[DHR825]	07.78- 08.91 07.78- 08.91	CA240IR 28 55 CA334IR 28 35	07.78- 08.91	CS387	24 5.0
	[DHT825]	07.78- 09.86 07.78- 09.86	CA240IR 28 55 CA334IR 28 35	07.78- 09.86	CS387	24 5.0
	[DHU825]	07.78- 08.91 07.78- 08.91	CA240IR 28 55 CA334IR 28 35	07.78- 08.91	CS387	24 5.0
F 2335 8.3	[DHT825]	07.78- 08.91 07.78- 08.91	CA240IR 28 55 CA334IR 28 35	07.78- 08.91	CS387	24 5.0





F 2500 8.3	[DHS825]	02.82- 08.91 02.82- 08.91	CA240IR CA334IR	28 55 28 35	02.82- 08.91	CS387	24 5.0
F 2503 8.3	[DHS825]	02.82- 09.86 02.82- 09.86	CA240IR CA334IR	28 55 28 35	02.82- 09.86	CS387	24 5.0
F 2505 8.3	[DHS825]	02.82- 08.91 02.82- 08.91	CA240IR CA334IR	28 55 28 35	02.82- 08.91	CS387	24 5.0
F 2525 8.3	[DHS825]	02.82- 08.91 02.82- 08.91	CA240IR CA334IR	28 55 28 35	02.82- 08.91	CS387	24 5.0
F 2535 8.3	[DHS825]	02.82- 08.91 02.82- 08.91	CA240IR CA334IR	28 55 28 35	02.82- 08.91	CS387	24 5.0
F 2600 11.6	[DKB1160]	02.72- 12.73	CA334IR	28 35			
F 2700 8.3	[HS825]	01.90- 10.93 01.90- 10.93	CA240IR CA334IR	28 55 28 35	01.90- 10.93	CS387	24 5.0
F 2800 11.6	[DKA1160]	05.77- 11.80 05.77- 11.80	CA240IR CA334IR	28 55 28 35			
	[DKS1160]	01.74- 09.91	CA240IR	28 55			
		01.74- 09.91	CA334IR	28 35			
	[DKS1160E]	05.77- 09.91	CA240IR	28 55			
		05.77- 09.91	CA334IR	28 35			
	[DKT1160]	05.77- 11.80	CA240IR	28 55			
		05.77- 11.80	CA334IR	28 35			
	[DKTD1160]	01.74- 09.91	CA240IR	28 55			
		01.74- 09.91	CA334IR	28 35			
	[DKV1160]	01.80- 09.91	CA240IR	28 55			
		01.80- 09.91	CA334IR	28 35			
	[DKXE1160]	01.80- 09.91	CA240IR	28 55			
		01.80- 09.91	CA334IR	28 35			
F 2803 11.6	[DKS1160]	05.77- 09.91	CA240IR	28 55			
		05.77- 09.91	CA334IR	28 35			
	[DKS1160E]	01.80- 07.90	CA240IR	28 55			
		01.80- 07.90	CA334IR	28 35			
	[DKTD1160]	01.74- 09.91	CA240IR	28 55			
		01.74- 09.91	CA334IR	28 35			
F 2804 11.6	[DKS1160E]	01.80- 09.86	CA240IR	28 55			
		01.80- 09.86	CA334IR	28 35			
	[DKT1160]	01.80- 09.86	CA334IR	28 35			
F 2805 11.6	[DKS1160]	05.77- 09.91	CA240IR	28 55			
		05.77- 09.91	CA334IR	28 35			
	[DKS1160E]	05.83- 09.91	CA240IR	28 55			
		05.83- 09.91	CA334IR	28 35			
	[DKTD1160]	01.74- 09.91	CA240IR	28 55			
		01.74- 09.91	CA334IR	28 35			
	[DKV1160]	05.83- 09.91	CA240IR	28 55			
		05.83- 09.91	CA334IR	28 35			
	[DKXE1160]	05.83- 09.91	CA240IR	28 55			
		05.83- 09.91	CA334IR	28 35			
F 2815 11.6	[DKS1160]	05.77- 12.81 05.77- 12.81	CA240IR CA334IR	28 55 28 35			
F 2825 11.6	[DKTD1160]	01.74- 09.91 01.74- 09.91	CA240IR CA334IR	28 55 28 35			
	[DKV1160]	05.83- 09.91	CA240IR	28 55			
		05.83- 09.91	CA334IR	28 35			
		05.83- 09.91	CA240IR	28 55			
F 3300 11.6	[DKX1160]	06.81- 09.86 06.81- 09.86	CA240IR CA334IR	28 55 28 35			
	[DKX1160 ATI]	06.85- 09.91	CA240IR	28 55			
		06.85- 09.91	CA334IR	28 35			
F 3303 11.6	[DKX1160]	06.81- 09.86 06.81- 09.86	CA240IR CA334IR	28 55 28 35			
	[DKX1160 ATI]	06.85- 09.91	CA240IR	28 55			
		06.85- 09.91	CA334IR	28 35			
F 3304 11.6	[DKX1160 ATI]	06.85- 09.91	CA334IR	28 35			
		06.85- 09.91	CA340IR	14 65			
F 3305 11.6	[DKX1160]	06.81- 09.91 06.81- 09.91	CA240IR CA334IR	28 55 28 35			
	[DKX1160 ATI]	06.85- 09.91	CA240IR	28 55			
		06.85- 09.91	CA334IR	28 35			
F 3325 11.6	[DKX1160]	06.81- 09.91 06.81- 09.91	CA240IR CA334IR	28 55 28 35			
	[DKX1160 ATI]	06.85- 09.91	CA240IR	28 55			
		06.85- 09.91	CA334IR	28 35			
F 3600 11.6	[DKZ1160 ATI]	06.85- 09.91	CA240IR	28 55			
		06.85- 09.91	CA334IR	28 35			
F 3603 11.6	[DKZ1160 ATI]	06.85- 09.91	CA240IR	28 55			
		06.85- 09.91	CA334IR	28 35			
	[DKZE1160]	06.85- 09.91	CA240IR	28 55			
		06.85- 09.91	CA334IR	28 35			
F 3604 11.6	[DKZ1160 ATI]	06.85- 09.91	CA240IR	28 55			
		06.85- 09.91	CA334IR	28 35			
F 3605 11.6	[DKZ1160 ATI]	06.85- 09.91	CA240IR	28 55			
		06.85- 09.91	CA334IR	28 35			
	[DKZE1160]	06.85- 09.91	CA240IR	28 55			
		06.85- 09.91	CA334IR	28 35			
F 3625 11.6	[DKZ1160 ATI]	06.85- 09.91	CA240IR	28 55			
		06.85- 09.91	CA334IR	28 35			
FA 85.360 12.9	[MX265]	10.06-	CA1939IR	28 110	10.06-	CS1420	24 5.5
FG 345 2.5 Diesel Leyland					01.72- 01.82	CS949	12 2.1
FG 350 2.5 Diesel Leyland					01.72- 01.82	CS949	12 2.1
FG 420 2.5 Diesel Leyland					01.72- 01.82	CS949	12 2.1
LF 45.130 3.9	[BE99C]				12.05-	CS1382	24 4.0
LF 45.140 4.5	[FR103S1]				05.06-	CS1382	24 4.0
LF 45.150 3.9	[BE110C]				01.01-	CS1382	24 4.0
LF 45.160 4.5	[FR118S1]				05.06-	CS1382	24 4.0
LF 45.170 3.9	[BE123C]				04.01-	CS1382	24 4.0
LF 45.180 4.5	[FR136S1]				05.06-	CS1382	24 4.0
LF 45.180 5.9	[CE136C]				04.01-	CS1382	24 4.0
LF 45.220 5.9	[CE162C]				04.01-	CS1382	24 4.0
LF 45.220 6.7	[GR165S1]				05.06-	CS1382	24 4.0
					05.06-	CS388	24 4.0
LF 45.250 6.7	[GR184S1]				03.06-	CS1382	24 4.0
					03.06-	CS388	24 4.0
LF 55.160 4.5	[FR118S1]	05.06- 05.06-	CA1035IR CA333IR	28 80 28 55	05.06- 05.06-	CS1274 CS1382	24 6.2 24 4.0

**DAF Continued**

LF 55.170 3.9	[BE123C]					01.01-	<b>CS1382</b>	24	4.0		
LF 55.180 4.5	[FR136S1]					05.06-	<b>CS1382</b>	24	4.0		
LF 55.180 5.9	[CE136C]					04.01-	<b>CS1382</b>	24	4.0		
LF 55.220 5.9	[CE162C]					04.01-	<b>CS1382</b>	24	4.0		
LF 55.220 6.7	[GR165S1]					05.06-	<b>CS1382</b>	24	4.0		
						05.06-	<b>CS388</b>	24	4.0		
LF 55.250 5.9	[CE184C]					04.01-	<b>CS1382</b>	24	4.0		
LF 55.250 6.7	[GR184S1]					05.06-	<b>CS1382</b>	24	4.0		
						05.06-	<b>CS388</b>	24	4.0		
LF 55.290 6.7	[GR210S1]					05.06-	<b>CS1382</b>	24	4.0		
						05.06-	<b>CS388</b>	24	4.0		
N 2826 11.6	[DKS1160]	01.81-	09.91	<b>CA240IR</b>	28	55					
		01.81-	09.91	<b>CA334IR</b>	28	35					
N 3326 11.6	[DKX1160]	01.81-	09.91	<b>CA240IR</b>	28	55					
		01.81-	09.91	<b>CA334IR</b>	28	35					
XF 105.410 12.9	[MX300]	10.05-		<b>CA1917IR</b>	28	80	10.05-	<b>CS1380</b>	24	5.5	
		10.05-		<b>CA1939IR</b>	28	110	10.05-	<b>CS1420</b>	24	5.5	
XF 105.460 12.9	[MX340]	10.05-		<b>CA1917IR</b>	28	80	10.05-	<b>CS1420</b>	24	5.5	
		10.05-		<b>CA1939IR</b>	28	110					
XF 105.510 12.9	[MX375]	10.05-		<b>CA1917IR</b>	28	80	10.05-	<b>CS1420</b>	24	5.5	
		10.05-		<b>CA1939IR</b>	28	110					
XF 95.380 12.6	[XE280C]	12.05-		<b>CA1917IR</b>	28	80	12.05-	<b>CS1420</b>	24	5.5	
		12.05-		<b>CA1939IR</b>	28	110	01.97-	<b>CS1274</b>	24	6.2	
		01.97-		<b>CA1694IR</b>	28	80	09.02-	<b>CS1380</b>	24	5.5	
				<b>CA1693IR</b>	28	110					
	[XF280M]	01.97-		<b>CA1694IR</b>	28	80	01.97-	<b>CS1274</b>	24	6.2	
				<b>CA1693IR</b>	28	110					
XF 95.430 12.6	[XE315C]	12.05-		<b>CA1917IR</b>	28	80	01.97-	12.06	<b>CS1274</b>	24	6.2
		12.05-		<b>CA1939IR</b>	28	110	12.05-		<b>CS1420</b>	24	5.5
		01.97-		<b>CA1035IR</b>	28	80					
		01.97-	12.06	<b>CA1694IR</b>	28	80					
			12.06	<b>CA1693IR</b>	28	110					
				<b>CA333IR</b>	28	55					
	[XF315M]			<b>CA1693IR</b>	28	110	01.97-		<b>CS1274</b>	24	6.2
				<b>CA1694IR</b>	28	80					
XF 95.480 12.6	[XE355C]	01.97-		<b>CA1694IR</b>	28	80	09.02-		<b>CS1380</b>	24	5.5
				<b>CA1693IR</b>	28	110	01.97-		<b>CS1274</b>	24	6.2
	[XF355M]	01.97-		<b>CA1694IR</b>	28	80	01.97-		<b>CS1274</b>	24	6.2
				<b>CA1693IR</b>	28	110					
XF 95.530 12.6	[XE390C]	09.02-	12.06	<b>CA1693IR</b>	28	110	01.97-	12.06	<b>CS1274</b>	24	6.2
		09.02-	12.06	<b>CA1694IR</b>	28	80	01.97-	12.06	<b>CS1380</b>	24	5.5
		01.97-	09.02	<b>CA1035IR</b>	28	80					
		01.97-	09.02	<b>CA333IR</b>	28	55					
XF 95.530 14.0	[VF390M]	01.97-	09.02	<b>CA1035IR</b>	28	80	01.97-	09.02	<b>CS1274</b>	24	6.2
		01.97-	09.02	<b>CA333IR</b>	28	55	01.97-	09.02	<b>CS1380</b>	24	5.5

**Daihatsu****PASSENGER CARS EU**

Applause 1.6 16V	[HD]	06.89-	09.89	<b>JA866IR</b>	14	50	06.89-	04.94	<b>JS657</b>	12	1.0
		10.90-	01.93	<b>JA1121IR</b>	14	50	03.90-	08.96	<b>JS998#</b>	12	0.8
	[HD-E]	06.89-	09.89	<b>JA866IR</b>	14	50	03.90-	08.96	<b>JS998#</b>	12	0.8
		10.90-	01.93	<b>JA1121IR</b>	14	50	06.89-	04.94	<b>JS657</b>	12	1.0
Applause 1.6 16V 4WD	[HD-E]	06.89-	09.89	<b>JA866IR</b>	14	50	03.90-	08.96	<b>JS998#</b>	12	0.8
		10.90-	01.93	<b>JA1121IR</b>	14	50	06.89-	04.94	<b>JS657</b>	12	1.0
Charade 1.0	[CB20]	11.78-	09.83	<b>JA131</b>	14	40	AT 04.83-	03.87	<b>JS661#</b>	12	0.8
		04.83-	03.87	<b>JA160IR</b>	14	45					
	[CB22]	04.83-	03.87	<b>JA160IR</b>	14	45	AT 04.83-	03.87	<b>JS661#</b>	12	0.8
	[CB23]	03.87-	11.90	<b>JA160IR</b>	14	45					
		11.90-	12.92	<b>JA978IR#</b>	14	45					
	[CB90]	04.89-	10.90	<b>JA160IR</b>	14	45					
Charade 1.0 GTi	[CB80T]	11.90-	12.92	<b>JA978IR#</b>	14	45					
Charade 1.0 Turbo	[CB60]	10.83-	03.87	<b>JA160IR</b>	14	45	AT 10.83-	03.87	<b>JS661#</b>	12	0.8
	[CB61]	03.87-	10.90	<b>JA160IR</b>	14	45					
Charade 1.05	[CB22]	02.81-	09.83	<b>JA131</b>	14	40					
Charade 1.3	[HC]	09.96-	11.99	<b>JA764IR</b>	14	45	09.96-	11.99	<b>JS657</b>	12	1.0
	[HCE]	11.90-	02.93	<b>JA763IR</b>	14	45	11.90-	02.93	<b>JS657</b>	12	1.0
Charade 1.3 16V	[HC]	01.93-	11.99	<b>JA764IR</b>	14	45	03.93-	04.94	<b>JS657</b>	12	1.0
	[HCE]	05.96-	11.99	<b>JA764IR</b>	14	45	05.96-	09.00	<b>JS657</b>	12	1.0
Charade 1.3 i	[HCE]	06.88-	10.91	<b>JA763IR</b>	14	45	06.88-	12.92	<b>JS657</b>	12	1.0
		11.90-	12.92	<b>JA1121IR</b>	14	50					
		11.90-	12.92	<b>JA764IR</b>	14	45					
Charade 1.3 i 4WD	[HCE]	06.88-	10.91	<b>JA763IR</b>	14	45	06.88-	01.93	<b>JS657</b>	12	1.0
		11.90-	01.93	<b>JA1121IR</b>	14	50					
		11.90-	01.93	<b>JA764IR</b>	14	45					
Charade 1.5	[HE]						06.94-	09.00	<b>JS657</b>	12	1.0
							06.94-	09.00	<b>JS998#</b>	12	0.8
Charade 1.5 16V	[HEE]						01.97-	11.99	<b>JS998#</b>	12	0.8
	[HEEG]						01.97-	11.99	<b>JS998#</b>	12	0.8
Charade 1.5 i 16V	[HEE]						08.94-		<b>JS657</b>	12	1.0
							08.94-		<b>JS998#</b>	12	0.8
Charade 1.6 GTi	[HD-E]	04.94-	08.96	<b>JA764IR</b>	14	45	03.93-	04.94	<b>JS657</b>	12	1.0
							04.94-	08.96	<b>JS998#</b>	12	0.8
Charmant 1.6	[2T]	12.81-	08.83	<b>JA137</b>	14	50					
	[4A]	08.83-	07.87	<b>JA138</b>	14	45	08.83-	07.87	<b>JS339</b>	12	1.0
Copen 0.7	[JB-DET]										
Copen 1.3	[K3-VE]						03.06-		<b>CS1498*</b>	12	0.8
Cuore 0.8	[ED10]	09.85-	12.90	<b>JA551IR</b>	14	40	09.85-	12.90	<b>JS661#</b>	12	0.8
Cuore 0.8 4WD	[ED10]	09.86-	10.88	<b>JA551IR</b>	14	40	09.86-	10.88	<b>JS661#</b>	12	0.8
Cuore 0.85	[ED10K]						10.90-	12.94	<b>JS661#</b>	12	0.8
	[ED20]	01.95-	11.96	<b>JA551IR</b>	14	40	01.95-	11.96	<b>JS661#</b>	12	0.8
Cuore 1.0		03.03-	08.05	<b>JA1609IR</b>	14	60					
Cuore 1.0 i	[EJDE]	10.98-	05.03	<b>JA1609IR</b>	14	60					
Feroza 1.6 16V	[HDC]	10.88-		<b>JA880IR</b>	14	45	10.88-		<b>JS1086</b>	12	0.8
							06.90-		<b>JS916</b>	12	1.0
Feroza 1.6 i 16V	[HD-E]	10.88-		<b>JA880IR</b>	14	45	10.88-		<b>JS1086</b>	12	0.8
							06.90-		<b>JS916</b>	12	1.0
Grand Move 1.5 16V	[HEEG]	11.96-	03.00	<b>JA764IR</b>	14	45	11.96-	09.97	<b>JS657</b>	12	1.0
							11.96-	03.00	<b>JS998#</b>	12	0.8
Grand Move 1.6	[HDEP]						05.98-	07.02	<b>JS998#</b>	12	0.8
Hijet 0.8	[CD]	06.86-		<b>JA551IR</b>	14	40	06.86-		<b>JS901</b>	12	0.8
Hijet 1.0	[CB]	06.86-	11.92	<b>JA551IR</b>	14	40	06.86-	11.92	<b>JS901</b>	12	0.8
	[CB41]	12.92-	05.98	<b>JA551IR</b>	14	40	12.92-	05.98	<b>JS901</b>	12	0.8
Hijet 1.0 i	[CB42]						09.96-	11.96	<b>JS901</b>	12	0.8
Materia 1.3	[K3-VE]						10.06-		<b>CS1498*</b>	12	0.8
Materia 1.5	[3SZ-VE]						10.06-		<b>CS1498*</b>	12	0.8



Materia 1.5 ECO 4WD	[3SZ-VE]					10.06-	CS1498*	12 0.8
Move 1.0 i	[EJDE]	10.98- 09.00	JA1609IR	14 60				
Rocky 2.0	[3Y]	02.87- 04.93	JA144	14 45		02.87- 04.93	JS385	12 1.0
		02.87- 04.93	JA657IR	14 60				
Rocky 2.8 Diesel	[DL]	12.87-	JA195	14 45		12.87-	JS521	12 2.5
						12.87-	JS1005#	12 2.2
Rocky 2.8 TD	[DL51]	12.87- 04.93	JA195	14 45		12.87- 04.93	JS1005#	12 2.2
	[DL52]	09.91- 04.93	JA195	14 45		12.87- 04.93	JS521	12 2.5
					A13	09.91- 05.93-	JS1005#	12 2.2
						09.91-	JS521	12 2.5
							JS521	12 2.5
Sirion 1.0 i	[EJDE]	04.98- 05.00	JA1609IR	14 60				
Sirion 1.0 i 4WD	[EJDE]	AT 04.98- 05.00	JA1609IR	14 60				
	[EJ-VE]	05.00- 12.01	JA1609IR	14 60				
Sirion 1.3	[K3-VE]					01.05-	CS1498*	12 0.8
Sirion 1.3 4WD	[K3-VE]					03.08-	CS1498*	12 0.8
Sirion 1.3 Sport	[K3-VE2]					08.00- 01.05	CS1498*	12 0.8
Sirion 1.3 Sport 4WD	[K3-VE2]	01.98- 08.04	JA1609IR	14 60		08.00- 01.05	CS1498*	12 0.8
Sirion 1.3 DVVT Executive 4WD	[K3-VE]					04.05-	CS1498*	12 0.8
Sirion 1.5	[3SZ-VE]					03.08-	CS1498*	12 0.8
Taft 1.6 Diesel 4WD	[12R]	09.76- 02.85	JA130	14 30		09.76- 02.85	JS336	12 0.8
		09.76- 02.85	JA131	14 40				
Taft 2.5 Diesel 4WD	[DG]					08.78- 08.82	JS521	12 2.5
Taft 2.8 Diesel 4WD	[DL]					08.82- 02.85	JS521	12 2.5
Terios 1.3	[K3-VE]					09.01- 10.05	JS1220	12 0.8
Terios 1.3 4WD	[HE-EJ]					10.97-	JS1220	12 0.8
	[K3-VE]					10.00- 10.05	JS1220	12 0.8
Terios 1.5	[3SZ-VE]					11.05-	CS1498*	12 0.8
Terios 1.5 16V 4WD	[3SZ-VE]					05.06-	CS1498*	12 0.8
Terios 1.5 DVVT						09.10-	CS1498*	12 0.8
Trevis 1.0	[EJ-VE]	06.06-	JA1609IR	14 60				
Wildcat 2.8 Diesel	[DL]	02.85- 03.87	JA195	14 45		02.85- 03.87	JS521	12 2.5
Wildcat 2.8 TD	[DL50]	09.85- 04.87	JA195	14 45		09.85- 04.87	JS521	12 2.5
YRV 1.0	[EJ-VE]	02.01-	JA1609IR	14 60				
YRV 1.3	[K3-VE]					02.01-	CS1498*	12 0.8
YRV 1.3 4WD	[K3-VE]					02.01-	CS1498*	12 0.8
YRV 1.3 Turbo	[K3-VET]					07.02-	CS1498*	12 0.8
<b>PASSENGER CARS AO</b>								
Charade 1.0	[EJ-VE]	03.03-	JA1609IR	14 60				
Charade 1.3		11.90- 12.92	JA764IR	14 45		04.98- 11.99	JS998#	12 0.8
		11.90- 12.92	JA1121IR	14 50		09.88- 01.92	JS657	12 1.0
		09.88- 10.91	JA763IR	14 45				
Charade 1.5 HG	[HEE]					06.94- 03.96	JS998#	12 0.8
	[HEEG]					06.94- 03.96	JS998#	12 0.8
Charade 1.6 GS	[HD-E]	03.93- 03.96	JA764IR	14 45		03.93- 03.96	JS998#	12 0.8
Cuore 1.0	[EJDE]	11.98- 09.00	JA1609IR	14 60				
	[EJ-VE]	03.03-	JA1609IR	14 60				
Gran Move 1.5 GLX	[HEEG]	10.96- 08.98	JA764IR	14 45		10.96- 08.98	JS998#	12 0.8
Gran Move 1.5 GX	[HEEG]	10.96- 08.98	JA764IR	14 45		10.96- 08.98	JS998#	12 0.8
Gran Move 1.6 GLX	[HDEP]					06.98- 07.02	JS998#	12 0.8
Gran Move 1.6 GX	[HD-EP]					06.98- 07.02	JS998#	12 0.8
Hijet 0.5	[AB30]	10.94- 12.95	JA118	14 35				
Hijet 1.0 4WD	[CB10]	07.86- 10.90	JA551IR	14 40		07.86- 10.90	JS901	12 0.8
Hijet 1.0 Touring 4WD	[CB10]	07.86- 10.90	JA551IR	14 40				
Sirion 1.0	[EJDE]	04.98- 10.00	JA1609IR	14 60				
Sirion 1.3 DVVT 16V	[K3-VE]					02.01- 04.05	CS1498*	12 0.8
Sirion 1.3 DVVT 16V CX 4WD	[K3-VE]					02.01- 10.02	CS1498*	12 0.8
Terios 1.3 DVVT Turbo 4WD						10.02- 10.05	CS1498*	12 0.8
Terios 1.3 DVVT	[K3-VE]					10.02- 10.05	CS1498*	12 0.8
Terios 1.3 DVVT 4x4	[K3-VE]					11.05-	CS1498*	12 0.8
<b>Daimler</b>								
<b>PASSENGER CARS EU</b>								
Six 4.0	[9JPFBR]	09.94-	CA324IR	14 90		09.94-	CS588#	12 1.4
Sovereign 3.6	[9DPANA]	10.86- 07.89	CA324IR	14 90		10.86- 07.89	CS588#	12 1.4
	[AJ6.4]	10.86- 09.89	CA324IR	14 90		10.86- 09.89	CS588#	12 1.4
Sovereign 4.0	[9EPCNA]	09.89- 09.94	CA324IR	14 90		09.89- 09.94	CS588#	12 1.4
Sovereign 4.2	[XK4.2]	09.73- 12.89	CA18h	14 43				
		10.69- 09.73	CA61IR	14 45				
<b>DeLorean</b>								
<b>PASSENGER CARS US</b>								
DMC 2.9 12						01.81- 01.83	CS280	12 1.1
<b>Deutz-Fahr</b>								
<b>AGRICULTURE</b>								
Agri 605						01.97-	CS1130	12 3.0
D 2807 1.9 Diesel	[F2L912]	06.86- 08.88	CA76IR	14 33		06.86-	CS707	12 1.9
		09.88-	CA238IR	14 55				
D 3607 1.9 Diesel	[F2L912]	06.86- 08.88	CA76IR	14 33		06.86-	CS707	12 1.9
		09.88-	CA238IR	14 55				
D 6807 3.8 Diesel	[F4L912]	06.86- 08.88	CA76IR	14 33		01.92-	CS887	12 3.1
		09.88-	CA238IR	14 55		06.86- 12.91	CS103	12 2.7
D 7007 3.8 Diesel	[F4L912]	06.86- 08.88	CA76IR	14 33		06.86- 12.91	CS103	12 2.7
		09.88-	CA238IR	14 55		01.92-	CS887	12 3.1
DX 3.10 2.8 Diesel	[F3L912]	06.86-	CA238IR	14 55		06.86- 12.91	CS103	12 2.7
						01.92- 06.01	CS887	12 3.1
DX 3.30 2.8 Diesel	[F3L912]	06.86-	CA238IR	14 55		06.86- 12.91	CS103	12 2.7
						01.92- 06.01	CS887	12 3.1
DX 3.50 3.1 Diesel	[F3L913]	06.86-	CA238IR	14 55		06.86- 12.91	CS103	12 2.7
						01.92- 06.01	CS887	12 3.1
DX 3.60 3.8 Diesel	[F4L912]	06.86-	CA238IR	14 55		06.86- 12.91	CS103	12 2.7
						01.92- 06.01	CS887	12 3.1
DX 3.70 3.8 Diesel	[F4L912]	06.86-	CA238IR	14 55		06.86- 12.91	CS103	12 2.7
						01.92- 06.01	CS887	12 3.1
DX 3.80 4.1 Diesel	[F4L913]	06.86-	CA238IR	14 55		06.86- 12.91	CS103	12 2.7
						01.92- 06.01	CS887	12 3.1
DX 3.90 4.1 Diesel	[F4L913]	06.86-	CA238IR	14 55		06.86- 12.91	CS103	12 2.7
						01.92- 06.01	CS887	12 3.1
DX 4.10 3.8 Diesel	[F4L912]	06.86-	CA238IR	14 55		06.86- 12.92	CS103	12 2.7
						01.92- 06.01	CS887	12 3.1
DX 4.30 4.1 Diesel	[F4L913]	06.86-	CA238IR	14 55		06.86- 12.91	CS103	12 2.7
						01.92- 06.01	CS887	12 3.1
DX 4.31 4.1 Diesel	[F4L913]	01.91-	CA238IR	14 55		01.91- 12.91	CS103	12 2.7
						01.92-	CS887	12 3.1
DX 4.50 4.1 Diesel	[BF4L913]	06.86-	CA238IR	14 55		06.86- 12.91	CS103	12 2.7
						01.92- 06.01	CS887	12 3.1

**DEUTZ-FAHR** *Continued*

DX 4.51 4.1 Diesel	[BF4L913]	01.90-	CA238IR	14 55	01.92- 01.90- 12.91 01.90- 06.94	CS887 CS114 CS398	12 3.1 12 2.4 12 3.7
DX 4.70 4.1 Diesel	[BF4L913]	06.86-	CA238IR	14 55	06.86- 12.91 01.92-	CS103 CS887	12 2.7 12 3.1
DX 6.05 5.7 Diesel	[F6L912]	06.86-	CA238IR	14 55	06.86- 12.91 01.92- 06.01	CS103 CS887	12 2.7 12 3.1
DX 6.30 6.1 Diesel	[F6L913]	06.86-	CA238IR	14 55	06.86- 12.91 01.92- 06.01	CS103 CS887	12 2.7 12 3.1
DX 6.31 6.0 Diesel	[BF6L913]	01.90-	CA1433IR	14 95	01.90- 12.91 01.90- 12.91 01.90- 06.94 01.92- 01.05	CS114 CS103 CS398 CS887	12 2.4 12 2.7 12 3.7 12 3.1
DX 6.50 6.1 Diesel	[BF6L913]	06.86-	CA1433IR	14 95	06.86- 12.91 01.92- 06.01	CS103 CS887	12 2.7 12 3.1
DX 6.60 6.0 Diesel	[BF6L913]				10.88- 12.91 01.92- 10.03	CS103 CS887	12 2.7 12 3.1
DX 7.10 6.1 Diesel	[BF6L913]	06.86-	CA1433IR	14 95	06.86- 12.91 06.86- 12.91 06.86- 06.94 01.92- 06.01	CS114 CS103 CS398 CS887	12 2.4 12 2.7 12 3.7 12 3.1
Intrac 6.30 6.0 TD	[BF6L913]	01.89-	CA1433IR	14 95	01.89- 12.91 01.92- 01.04	CS103 CS887	12 2.7 12 3.1
Intrac 6.60 6.0 TD	[BF6L913]	01.88-	CA1433IR	14 95	01.88- 01.03	CS398	12 3.7
M 1080 4.7 Diesel	[F5L912]	01.81- 08.88 09.88-	CA76IR CA238IR	14 33 14 55	01.81- 12.91 01.92- 01.96	CS103 CS887	12 2.7 12 3.1
M 1202 5.7 Diesel	[F6L912]	01.80- 08.88 09.88-	CA76IR CA238IR	14 33 14 55	01.80- 12.91 01.92- 01.95	CS103 CS887	12 2.7 12 3.1
M 2385 5.7 Diesel	[F6L912]	01.82- 01.82- 07.93	CA1433IR CA340IR	14 95 14 65	01.92- 01.97 01.82- 12.91	CS887 CS103	12 3.1 12 2.7
M 3330 2.8	[F3L912]				01.92- 03.02	CS887	12 3.1
M 3360 3.8	[F4L912]				03.87- 12.91	CS103	12 2.7
M 980 3.8 Diesel	[F4L912]	01.81- 08.88 09.88-	CA76IR CA238IR	14 33 14 55	01.81- 12.91 01.92- 01.96	CS103 CS887	12 2.7 12 3.1
<b>Dodge</b>							
<b>PASSENGER CARS EU</b>							
Avenger 2.0 CRD	[ECD]	06.07-	CA1763IR	14 150	06.07-	CS1460*	12 2.0
Caliber 2.0 CRD	[ECD]	06.06-	CA1763IR	14 150	06.06-	CS1460*	12 2.0
Caravan 2.4 i	[EDZ]	01.95- 03.01	UA1215	14 90	01.95- 03.01	CS1190	12 1.4
Caravan 2.5 TD	[ENC]	01.95- 12.98	CA1478IR	14 115	01.95- 12.98	CS611	12 2.2
Caravan 3.0	[EFA]	01.95-	JA1707	14 120			
Caravan 3.3	[EGA]	02.00-	CA2092*	14 160	02.00-	CS1502*	12 1.4
Caravan 3.3 4WD	[EGA]	02.00-	CA2092*	14 160	02.00-	CS1502*	12 1.4
Caravan 3.3 i	[EGP]	01.95- 12.98	JA1707	14 120	01.95- 03.01 01.95- 03.01	JS942 CS1501*	12 1.2 12 1.4
Caravan 3.8	[EGH]	02.00-	CA2092*	14 160	02.00-	CS1502*	12 1.4
Caravan 3.8 4WD	[EGH]	02.00-	CA2092*	14 160	02.00-	CS1502*	12 1.4
Caravan 3.8 i	[EGH]	01.95- 12.98	JA1707	14 120	01.95- 03.01 01.95- 03.01	JS942 CS1501*	12 1.2 12 1.4
Caravan 3.8 i 4WD	[EGH]	01.95- 12.98	JA1707	14 120	01.95- 03.01 01.95- 03.01	JS942 CS1501*	12 1.2 12 1.4
Journey 2.0 CRD	[ECE]	06.08-	CA1763IR	14 150	06.08-	CS1460*	12 2.0
Neon 2.0 16V	[ECB]	08.99- 12.02	CA2099*	14 85	05.94-	CS990	12 1.1
	[ECC]	04.96- 08.99	CA2099*	14 85	06.94- 08.99	CS990	12 1.1
	[ECH]	04.96-	CA2099*	14 85	04.96- 01.97	CS990	12 1.1
Stratus 2.0 16V	[ECB]	12.95-	UA1215	14 90	12.95-	CS990	12 1.1
Stratus 2.4 16V	[EDZ]	12.95-	UA1215	14 90			
<b>PASSENGER CARS US</b>							
400 2.6					01.82-	JS339	12 1.0
400 2.6 LS					01.82-	JS339	12 1.0
600 2.2		01.83- 01.88	UA1212	14 90 BO			
600 2.2 SE		01.85- 01.87	UA1212	14 90 BO			
600 2.2 Turbo		01.84- 01.89	UA1212	14 90 BO			
600 2.2 Turbo SE		01.85- 01.88	UA1212	14 90 BO			
600 2.5		01.86- 01.88	UA1212	14 90 BO	01.86- 01.88	CS979#	12 1.4
600 2.5 SE		01.86- 01.88	UA1212	14 90 BO	01.86- 01.88	CS979#	12 1.4
600 2.6					01.83- 01.85	JS339	12 1.0
600 2.6 ES					01.83- 01.84	JS339	12 1.0
600 2.6 SE					01.85-	JS339	12 1.0
Aries 2.2		01.85- 01.87	UA1212	14 90 BO			
Aries 2.2 LE		01.85- 01.89	UA1212	14 90 BO			
Aries 2.2 SE		01.85- 01.86	UA1212	14 90 BO			
Aries 2.5		01.86- 01.87	UA1212	14 90 BO	01.86- 01.87	CS979#	12 1.4
Aries 2.5 LE		01.86- 01.89	UA1212	14 90 BO	01.86- 01.89	CS979#	12 1.4
Aries 2.5 SE		01.86-	UA1212	14 90 BO	01.86-	CS979#	12 1.4
Aries 2.6					01.81- 01.85	JS339	12 1.0
Aries 2.6 Custom					01.81- 01.84	JS339	12 1.0
Aries 2.6 LE					01.85-	JS339	12 1.0
Aries 2.6 SE					01.81- 01.85	JS339	12 1.0
B150 3.9		01.88- 01.94	UA960	14 90	01.88- 01.94	JS762	12 1.4
B150 3.9 Sportsman		01.88- 01.94	UA960	14 90	01.88- 01.94	JS762	12 1.4
B150 5.2		01.88- 01.94	UA960	14 90	01.88- 01.94	JS762	12 1.4
B150 5.2 Sportsman		01.88- 01.94	UA960	14 90	01.88- 01.94	JS762	12 1.4
B250 3.9		01.88- 01.94	UA960	14 90	01.88- 01.94	JS762	12 1.4
B250 3.9 Sportsman		01.88- 01.94	UA960	14 90	01.88- 01.94	JS762	12 1.4
B250 5.2		01.88- 01.94	UA960	14 90	01.88- 01.94	JS762	12 1.4
B250 5.2 Sportsman		01.88- 01.94	UA960	14 90	01.88- 01.94	JS762	12 1.4
B250 5.9		01.88- 01.94	UA960	14 90	01.88- 01.94	JS762	12 1.4
B250 5.9 Sportsman		01.88- 01.94	UA960	14 90	01.88- 01.94	JS762	12 1.4
B350 3.9					01.90- 01.94	JS762	12 1.4
B350 5.2		01.88- 01.94	UA960	14 90	01.88- 01.94	JS762	12 1.4
B350 5.2 Sportsman		01.88- 01.94	UA960	14 90	01.88- 01.94	JS762	12 1.4
B350 5.9		01.88- 01.94	UA960	14 90	01.88- 01.94	JS762	12 1.4
B350 5.9 Sportsman		01.88- 01.94	UA960	14 90	01.88- 01.94	JS762	12 1.4
Caravan 2.5		01.92- 01.95	UA960	14 90	01.88- 01.95	CS979#	12 1.4
		01.88- 01.91	UA1212	14 90 BO			
Caravan 2.5 C/V		01.92- 01.95	UA960	14 90	01.89- 01.95	CS979#	12 1.4
		01.89- 01.91	UA1212	14 90 BO			



Caravan 2.5 LE	01.88- 01.91	UA1212	14	90	BO	01.88- 01.91	CS979#	12	1.4
Caravan 2.5 SE	01.88- 01.91	UA1212	14	90	BO	01.88- 01.93	CS979#	12	1.4
	01.92- 01.93	UA960			14	90			
Caravan 2.5 Turbo	01.89- 01.90	UA1212	14	90	BO	01.89- 01.90	CS979#	12	1.4
Caravan 2.5 Turbo C/V	01.89- 01.90	UA1212	14	90	BO	01.89- 01.90	CS979#	12	1.4
Caravan 2.5 Turbo LE	01.89- 01.90	UA1212	14	90	BO	01.89- 01.90	CS979#	12	1.4
Caravan 2.5 Turbo SE	01.89- 01.90	UA1212	14	90	BO	01.89- 01.90	CS979#	12	1.4
Caravan 2.6						01.84- 01.87	JS339	12	1.0
Caravan 2.6 LE						01.84- 01.87	JS339	12	1.0
Caravan 2.6 SE						01.84- 01.87	JS339	12	1.0
Caravan 3.0						01.90- 01.95	JS762	12	1.4
Caravan 3.0 C/V						01.89- 01.95	JS762	12	1.4
Caravan 3.0 ES						01.94- 01.95	JS762	12	1.4
Caravan 3.0 LE						01.87- 01.95	JS762	12	1.4
Caravan 3.0 SE						01.87- 01.95	JS762	12	1.4
Caravan 3.3						01.90- 01.00	JS942	12	1.2
						01.97- 01.00	CS1501*	12	1.4
Caravan 3.3 C/V						01.91- 01.92	JS942	12	1.2
Caravan 3.3 ES						01.93- 01.97	JS942	12	1.2
Caravan 3.3 LE						01.91- 01.97	JS942	12	1.2
Caravan 3.3 SE						01.91- 01.97	JS942	12	1.2
Caravan 3.3						01.94- 01.95	JS942	12	1.2
Caravan 3.3 C/V						01.94- 01.95	JS942	12	1.2
Caravan 3.3 SE						01.94- 01.95	JS942	12	1.2
Caravan 3.3 [EGM]						01.99- 01.00	CS1501*	12	1.4
						01.99- 01.00	JS942	12	1.2
Caravan 3.8						01.98- 01.98	JS942	12	1.2
						01.98- 01.99	JS942	12	1.2
						01.98- 01.99	CS1501*	12	1.4
Caravan 3.8 ES						01.96- 01.97	JS942	12	1.2
Caravan 3.8 LE						01.96- 01.97	JS942	12	1.2
Challenger 1.6						01.78- 01.79	JS350	12	0.7
Challenger 2.6	01.81- 01.83	JA148IR	14	45		01.78- 01.83	JS350	12	0.7
Charger 2.2	01.84- 01.86	UA1212	14	90	BO				
Charger 2.2 Turbo Shelby	01.85- 01.87	UA1212	14	90	BO				
Colt 1.4	01.79- 01.83	JA150IR	14	45		01.79- 01.83	JS350	12	0.7
Colt 1.4 Custom	01.79- 01.79	JA150IR	14	45		01.79- 01.79	JS350	12	0.7
Colt 1.4 Deluxe	01.82- 01.83	JA150IR	14	45		01.82- 01.83	JS350	12	0.7
Colt 1.4 DL	01.84- 01.84	JA150IR	14	45		01.84- 01.84	JS350	12	0.7
Colt 1.4 E	01.84- 01.84	JA150IR	14	45		01.84- 01.84	JS350	12	0.7
Colt 1.5	01.89- 01.94	JA689IR	14	75		01.89- 01.94	JS350	12	0.7
						01.91- 01.94	JS643	12	0.9
Colt 1.5 100 DL	01.89- 01.91	JA689IR	14	75		01.89- 01.91	JS350	12	0.7
						01.91- 01.91	JS643	12	0.9
Colt 1.5 100 E	01.89- 01.92	JA689IR	14	75		01.89- 01.92	JS350	12	0.7
						01.91- 01.92	JS643	12	0.9
Colt 1.5 100 LX	01.89- 01.90	JA689IR	14	75		01.89- 01.90	JS350	12	0.7
Colt 1.5 200 DL	01.89- 01.90	JA689IR	14	75		01.89- 01.90	JS350	12	0.7
Colt 1.5 200 E	01.89- 01.92	JA689IR	14	75		01.89- 01.92	JS350	12	0.7
						01.92- 01.92	JS643	12	0.9
Colt 1.5 200 GT	01.91- 01.92	JA689IR	14	75		01.91- 01.92	JS643	12	0.9
						01.91- 01.92	JS350	12	0.7
Colt 1.5 200 LX	01.89- 01.89	JA689IR	14	75		01.89- 01.89	JS350	12	0.7
Colt 1.5 DL	01.85- 01.88	JA159IR#	14	65		01.85- 01.85	JS349	12	0.9
	01.88- 01.90	JA689IR	14	75		01.85- 01.90	JS350	12	0.7
Colt 1.5 E	01.89- 01.89	JA689IR	14	75		01.85- 01.89	JS350	12	0.7
	01.85- 01.88	JA159IR#	14	65		01.85- 01.85	JS349	12	0.9
Colt 1.5 ES	01.94- 01.94	JA689IR	14	75		01.94- 01.94	JS350	12	0.7
						01.94- 01.94	JS643	12	0.9
Colt 1.5 GL	01.90- 01.93	JA689IR	14	75		01.90- 01.93	JS350	12	0.7
						01.91- 01.93	JS643	12	0.9
Colt 1.5 GT	01.89- 01.90	JA689IR	14	75		01.89- 01.90	JS350	12	0.7
Colt 1.5 Premier	01.85- 01.88	JA159IR#	14	65		01.85- 01.88	JS350	12	0.7
						01.85- 01.85	JS349	12	0.9
Colt 1.6	01.79- 01.80	JA150IR	14	45		01.79- 01.80	JS350	12	0.7
Colt 1.6 200 LX	01.89- 01.89	JA671IR	14	75		01.89- 01.89	JS628	12	1.2
Colt 1.6 Custom	01.79- 01.83	JA150IR	14	45		01.79- 01.83	JS350	12	0.7
Colt 1.6 Deluxe	01.82- 01.83	JA150IR	14	45		01.82- 01.83	JS350	12	0.7
Colt 1.6 DL	01.84- 01.84	JA150IR	14	45		01.84- 01.84	JS350	12	0.7
Colt 1.6 E	01.84- 01.84	JA150IR	14	45		01.84- 01.84	JS350	12	0.7
Colt 1.6 GT	01.90- 01.90	JA671IR	14	75		01.90- 01.90	JS628	12	1.2
Colt 1.6 Turbo 100 DL	01.89- 01.89	JA671IR	14	75		01.89- 01.89	JS628	12	1.2
Colt 1.6 Turbo 100 LX	01.89- 01.90	JA671IR	14	75		01.89- 01.90	JS628	12	1.2
Colt 1.6 Turbo DL	01.85- 01.88	JA159IR#	14	65		01.84- 01.88	JS350	12	0.7
	01.84- 01.84	JA150IR	14	45		01.85- 01.85	JS349	12	0.9
Colt 1.6 Turbo GT	01.89- 01.89	JA671IR	14	75		01.89- 01.89	JS628	12	1.2
Colt 1.6 Turbo Premier	01.85- 01.88	JA159IR#	14	65		01.85- 01.88	JS350	12	0.7
						01.85- 01.85	JS349	12	0.9
Colt 1.8	01.94- 01.94	JA1126IR	14	75		01.94- 01.94	JS1003	12	0.9
Colt 1.8 DL						01.89- 01.90	JS350	12	0.7
Colt 1.8 ES	01.94- 01.94	JA1126IR	14	75		01.94- 01.94	JS1003	12	0.9
Colt 1.8 GL						01.93- 01.93	JS1003	12	0.9
Colt 2.0 Vista	01.87- 01.91	JA598IR	14	60		01.87- 01.91	JS628	12	1.2
						01.84- 01.91	JS350	12	0.7
Colt 2.0 Vista Custom						01.86- 01.86	JS350	12	0.7
Colt 2.4	01.93- 01.94	JA1167IR	14	75		01.93- 01.94	JS350	12	0.7
Colt 2.4 4x4	01.93- 01.94	JA1167IR	14	75		01.93- 01.94	JS350	12	0.7
Colt 2.4 SE	01.93- 01.94	JA1167IR	14	75		01.93- 01.94	JS350	12	0.7
Colt 2.6	01.78- 01.80	JA148IR	14	45		01.78- 01.80	JS350	12	0.7
Conquest 2.6 Turbo	01.84- 01.86	JA151IR	14	50		01.84- 01.85	JS350	12	0.7
D100 3.9	01.88- 01.89	UA960	14	90		01.88- 01.89	JS762	12	1.4
D100 5.2	01.88- 01.89	UA960	14	90		01.88- 01.89	JS762	12	1.4
D100 5.9	01.88- 01.88	UA960	14	90		01.88- 01.88	JS762	12	1.4
D150 3.9	01.88- 01.90	UA960	14	90		01.88- 01.90	JS762	12	1.4
D150 3.9 S						01.90- 01.91	JS762	12	1.4
D150 5.2	01.88- 01.90	UA960	14	90		01.88- 01.90	JS762	12	1.4
D150 5.2 S						01.90- 01.91	JS762	12	1.4
D150 5.9	01.88- 01.90	UA960	14	90		01.88- 01.90	JS762	12	1.4
D250 3.9	01.88- 01.90	UA960	14	90		01.88- 01.90	JS762	12	1.4
D250 5.2	01.88- 01.90	UA960	14	90		01.88- 01.90	JS762	12	1.4
D250 5.9	01.88- 01.90	UA960	14	90		01.88- 01.91	JS762	12	1.4
D350 5.9	01.88- 01.90	UA960	14	90		01.88- 01.90	JS762	12	1.4
D50 2.0	01.79- 01.82	JA148IR	14	45		01.79- 01.82	JS350	12	0.7
D50 2.6	01.79- 01.82	JA148IR	14	45		01.79- 01.82	JS350	12	0.7



DODGE Continued

Table with columns for vehicle model, year range, trim code, and various codes. Includes models like Dakota, Daytona, Grand, Lancer, Mini Ram, Neon, Omni, Power Ram, Raider, Ram, Ramcharger, and Shadow.



Shadow 2.2 Turbo Shelby		01.89- 01.89	UA1212	14 90	BO	01.89- 01.89	CS979#	12 1.4
Shadow 2.5		01.92- 01.94	UA960	14 90		01.88- 01.94	CS979#	12 1.4
		01.88- 01.91	UA1212	14 90	BO			
Shadow 2.5 America		01.92- 01.92	UA960	14 90		01.92- 01.92	CS979#	12 1.4
Shadow 2.5 ES		01.91- 01.94	UA960	14 90		01.91- 01.94	CS979#	12 1.4
Shadow 2.5 Turbo		01.92- 01.92	UA960	14 90		01.89- 01.92	CS979#	12 1.4
		01.89- 01.91	UA1212	14 90	BO			
Shadow 2.5 Turbo ES		01.91- 01.92	UA960	14 90		01.91- 01.92	CS979#	12 1.4
Shadow 3.0						01.93-	JS762	12 1.4
Shadow 3.0 ES						01.92- 01.94	JS762	12 1.4
Spirit 2.2 Turbo R/T		01.91- 01.92	UA960	14 90		01.91- 01.92	CS979#	12 1.4
Spirit 2.5		01.92- 01.95	UA960	14 90		01.89- 01.95	CS979#	12 1.4
		01.89- 01.91	UA1212	14 90	BO			
Spirit 2.5 ES		01.93- 01.93	UA960	14 90		01.93- 01.93	CS979#	12 1.4
Spirit 2.5 LE		01.89- 01.91	UA1212	14 90	BO	01.89- 01.92	CS979#	12 1.4
		01.92- 01.92	UA960	14 90				
Spirit 2.5 Turbo		01.89- 01.91	UA1212	14 90	BO	01.89- 01.91	CS979#	12 1.4
Spirit 2.5 Turbo ES		01.92- 01.92	UA960	14 90		01.89- 01.92	CS979#	12 1.4
		01.89- 01.91	UA1212	14 90	BO			
Spirit 2.5 Turbo LE		01.92- 01.92	UA960	14 90		01.89- 01.92	CS979#	12 1.4
		01.89- 01.91	UA1212	14 90	BO			
Spirit 2.5		01.93- 01.94	UA960	14 90		01.93- 01.94	CS979#	12 1.4
Spirit 3.0						01.90- 01.95	JS762	12 1.4
Spirit 3.0 ES						01.89- 01.93	JS762	12 1.4
Spirit 3.0 LE						01.90- 01.92	JS762	12 1.4
Stealth 3.0						01.91- 01.96	JS658	12 1.2
Stealth 3.0 ES						01.91- 01.93	JS658	12 1.2
Stealth 3.0 R/T						01.91- 01.96	JS658	12 1.2
Stealth 3.0 R/T Sport						01.94- 01.95	JS658	12 1.2
Stealth 3.0 Turbo R/T		01.91- 01.96	JA995IR	14 110				
						01.91- 01.96	JS658	12 1.2
Stratus 2.0	[ECB]	01.95- 01.98	UA1215	14 90		01.95- 01.97	CS990	12 1.1
		01.99- 01.00	UA1215	14 90				
Stratus 2.0 ES	[ECB]	01.95- 01.97	UA1215	14 90		01.95- 01.97	CS990	12 1.1
Stratus 2.4	[EDZ]	01.95- 01.98	UA1215	14 90				
		01.99- 01.00	UA1215	14 90				
Stratus 2.4 ES	[EDZ]	01.96- 01.98	UA1215	14 90				
		01.95- 01.95	UA1215	14 90				
W100 3.9		01.89- 01.89	UA960	14 90		01.89- 01.89	JS762	12 1.4
W100 5.2		01.88- 01.89	UA960	14 90		01.88- 01.89	JS762	12 1.4
W100 5.9		01.88- 01.88	UA960	14 90		01.88- 01.88	JS762	12 1.4
W150 3.9		01.89- 01.90	UA960	14 90		01.89- 01.90	JS762	12 1.4
W150 3.9 S						01.90- 01.91	JS762	12 1.4
W150 5.2		01.88- 01.90	UA960	14 90		01.88- 01.90	JS762	12 1.4
W150 5.2 S						01.90- 01.91	JS762	12 1.4
W150 5.9		01.88- 01.90	UA960	14 90		01.88- 01.90	JS762	12 1.4
W250 5.2		01.88- 01.90	UA960	14 90		01.88- 01.90	JS762	12 1.4
W250 5.9		01.88- 01.90	UA960	14 90		01.88- 01.91	JS762	12 1.4
W350 5.9		01.88- 01.90	UA960	14 90		01.88- 01.90	JS762	12 1.4
<b>PASSENGER CARS AO</b>								
Caravan 3.8 Turbo 4WD	[EGH]	04.01-	CA2092*	14 160				
Caravan III 3.3	[EGM]	04.01- 05.07	CA2092*	14 160				
Caravan III 3.8	[EGH]	04.01- 05.07	CA2092*	14 160				
Caravan III 3.8 AWD		04.01- 05.07	CA2092*	14 160				
<b>Dongfeng (DFL)</b>								
<b>PASSENGER CARS AO</b>								
Teana 2.0	[QR20DE]	09.04-	JA1712IR	14 110				
<b>Dronningborg</b>								
<b>AGRICULTURE</b>								
7500	[Valmet]		CA626IR	14 75				
7800	[Valmet D620]	01.93	CA564IR	14 65				
8000	[Valmet]	01.90-	CA626IR	14 75				
8700 Jumbo	[Valmet]		CA564IR	14 65				
9000 Jumbo	[Valmet]		CA626IR	14 75				
<b>Eagle</b>								
<b>PASSENGER CARS US</b>								
2000 2.0 GTX		01.91- 01.93	JA684IR	14 90		01.91- 01.93	JS628	12 1.2
		01.91- 01.93	JA671IR	14 75				
2000 2.0 GTX 4x4		01.92- 01.92	JA684IR	14 90		01.92- 01.92	JS628	12 1.2
		01.92- 01.92	JA671IR	14 75				
Medallion 2.2 DL		01.88- 01.89	CA534IR	14 90		01.88- 01.89	CS523	12 2.2
Medallion 2.2 LX		01.88- 01.89	CA534IR	14 90		01.88- 01.89	CS523	12 2.2
Premier 2.5 LX						01.88- 01.89	CS1036	12 1.4
Summit 1.5		01.91- 01.92	JA689IR	14 75		01.91- 01.92	JS643	12 0.9
						01.91- 01.92	JS350	12 0.7
Summit 1.5 DL		01.89- 01.96	JA689IR	14 75		01.89- 01.96	JS350	12 0.7
						01.91- 01.96	JS643	12 0.9
Summit 1.5 ES		01.91- 01.96	JA689IR	14 75		01.91- 01.96	JS643	12 0.9
						01.91- 01.96	JS350	12 0.7
Summit 1.5 ESI						01.95- 01.96	JS350	12 0.7
						01.95- 01.96	JS643	12 0.9
Summit 1.5 LX		01.89- 01.90	JA689IR	14 75		01.89- 01.90	JS350	12 0.7
Summit 1.6 LX		01.89- 01.90	JA671IR	14 75		01.89- 01.90	JS628	12 1.2
Summit 1.8		01.92- 01.93	JA1126IR	14 75		01.92- 01.93	JS1003	12 0.9
Summit 1.8 DL		01.92- 01.96	JA1126IR	14 75		01.92- 01.96	JS1003	12 0.9
Summit 1.8 ES		01.93- 01.96	JA1126IR	14 75		01.93- 01.96	JS1003	12 0.9
Summit 1.8 ESI		01.94- 01.95	JA1126IR	14 75		01.94- 01.95	JS1003	12 0.9
Summit 1.8 LX		01.92- 01.96	JA1126IR	14 75		01.92- 01.96	JS1003	12 0.9
Summit 2.4		01.93- 01.96	JA1167IR	14 75		01.92- 01.94	JS350	12 0.7
		01.92- 01.92	JA671IR	14 75		01.95- 01.96	JS628	12 1.2
Summit 2.4 DL		01.92- 01.92	JA671IR	14 75		01.92- 01.94	JS350	12 0.7
		01.93- 01.96	JA1167IR	14 75		01.95- 01.96	JS628	12 1.2
Summit 2.4 LX		01.92- 01.92	JA671IR	14 75		01.95- 01.96	JS628	12 1.2
		01.93- 01.96	JA1167IR	14 75		01.92- 01.94	JS350	12 0.7
Talon 1.8 DL		01.93- 01.94	JA666IR	14 60		01.93- 01.94	JS350	12 0.7
						01.93- 01.94	JS643	12 0.9
Talon 2.0		01.90- 01.92	JA684IR	14 90		01.90- 01.92	JS628	12 1.2
		01.90- 01.92	JA671IR	14 75				
Talon 2.0 ES		01.93- 01.94	JA671IR	14 75		01.93- 01.94	JS628	12 1.2



## EAGLE Continued

Talon 2.0 Turbo TSI	[EBG]	01.93- 01.97	JA6711R	14 75	01.93- 01.97	JS628	12 1.2
		01.90- 01.92	JA6841R	14 90	01.90- 01.92	JS628	12 1.2
		01.90- 01.92	JA6711R	14 75			
<b>Eicher</b>							
<b>AGRICULTURE</b>							
330 2.0 Diesel	[EDK 2-9]	10.77- 12.80	CA7341R	14 33			
3026 5.9 Diesel	[EDL 6-1]	03.82- 03.82-	CA3391R CA7341R	14 55 14 33			
3028 5.9 Diesel	[EDL 6-5]	09.83- 09.83-	CA3391R CA7341R	14 55 14 33			
3030 5.9 Diesel	[EDL 6-6]	09.83- 09.83-	CA3391R CA7341R	14 55 14 33			
3357 3.0 Diesel	[EDL 3-8]	03.82- 12.87	CA7341R	14 33			
3358 3.0 Diesel	[EDL 3-8]	03.82- 12.87	CA7341R	14 33			
3457 3.0 Diesel	[EDL 3-9]	03.82- 12.87	CA7341R	14 33			
3458 3.0 Diesel	[EDL 3-9]	03.82- 12.87	CA7341R	14 33			
3559 3.9 Diesel	[EDL 4-4]	01.84-	CA7341R	14 33			
3560 3.9 Diesel	[EDL 4-4]	01.84-	CA7341R	14 33			
3659 3.9 Diesel	[EDL 4-5]	01.84-	CA7341R	14 33			
3660 3.9 Diesel	[EDL 4-6]	01.84-	CA7341R	14 33			
3257 S 3.0 Diesel	[EDL 3-7]	03.82- 12.87	CA7341R	14 33			
3258 A AS 3.0 Diesel	[EDL 3-7]	03.82- 12.87	CA7341R	14 33			
635 K KA 1.9 Diesel	[EDL 2-2]	01.86-	CA7341R	14 33			
642 K KA 1.9 Diesel	[EDL 2-4]	01.86-	CA7341R	14 33			
645 K KA 2.9 Diesel	[EDL 3-6]	01.86-	CA7341R	14 33			
648 V VA 2.9 Diesel	[EDL 3-7.2]	01.87-	CA7341R	14 33			
666 P PA 2.9 Diesel	[EDL 3-9.1]	01.87-	CA7341R	14 33			
666 V VA 2.9 Diesel	[EDL 3-9.1]	01.86-	CA7341R	14 33			
680 P PA 3.9 Diesel	[EDL 4-5.1]	01.87-	CA7341R	14 33			
<b>ERF</b>							
<b>TRUCKS EU</b>							
E6 6.0	[Cummins B]				01.88- 01.96	US1245#	24 4.5
EC6 6.0	[Cummins B]				01.88- 01.96	US1245#	24 4.5
ES6 6.0	[Cummins B]				01.88- 01.96	US1245#	24 4.5
<b>Evobus</b>							
<b>TRUCKS EU</b>							
S 415 GT 12.0	[OM457.941]	10.03-	CA16591R	28 140	10.03-	CS1333	24 6.2
	[OM457.944]	10.03-	CA16591R	28 140	10.03-	CS1333	24 6.2
S 415 GT-HD 12.0	[OM457.941]				10.03-	CS1333	24 6.2
	[OM457.944]	10.03-	CA16591R	28 140	10.03-	CS1333	24 6.2
S 416 GT-HD 12.0	[OM457.944]	10.03-	CA16591R	28 140	10.03-	CS1333	24 6.2
S 417 GT-HD 12.0	[OM457.944]	10.03-	CA16591R	28 140	10.03-	CS1333	24 6.2
<b>Fendt</b>							
<b>AGRICULTURE</b>							
204 3.8 Diesel	[F4L 912]	02.79- 08.88	CA761R	14 33			
		09.88-	CA2381R	14 55			
205 4.0 Diesel	[F4L 912]	02.79- 08.88	CA761R	14 33			
		09.88-	CA2381R	14 55			
600 5.7 Diesel	[D227-6]	08.89-	CA14801R	14 143	01.86- 02.80- 02.93	CS1173 CS550	12 2.9 12 2.4
610 5.7 Diesel	[D226-6]	08.89-	CA14801R	14 143	02.78- 02.93	CS550	12 2.4
					01.86-	CS1173	12 2.9
611 6.2 Diesel	[D226-6]	08.89-	CA14801R	14 143	01.86- 02.76- 02.91	CS1173 CS550	12 2.9 12 2.4
					02.76- 02.91	CS550	12 2.4
612 6.2 Diesel	[D226-6]	08.89-	CA14801R	14 143	01.86- 01.86-	CS1173	12 2.9
614 6.2 Diesel	[TD226-6]	01.96-	CA14801R	14 143	01.86- 02.78- 02.93	CS1173 CS550	12 2.9 12 2.4
615 6.2 Diesel	[TD226-6]	01.96-	CA14801R	14 143			
105S 4.2 Diesel	[D226-4]				02.77- 02.92	CS550	12 2.4
200 Series 2.8 Diesel	[F3L912]	02.74- 02.79	CA76	14 28			
		02.79- 08.88	CA761R	14 33			
		09.88-	CA2381R	14 55			
300 SERIES 4.2 Diesel	[D226.]	09.89-	CA12421R	14 65	02.80- 02.95	CS550	12 2.4
		09.89-	CA14801R	14 143			
626 LS 11.4 Diesel	[D2566ME]	01.96-	CA14801R	14 143			
800 Series 6.9 Diesel	[D286.]	06.93-	CA17361R#	14 95	06.93-	CS1280	24 4.0
Various Models			CA13351R	14 120	01.86-	CS1173	12 2.9
<b>Ferrari</b>							
<b>PASSENGER CARS EU</b>							
208 2.0 Turbo	[F106D.]	06.82- 10.89	CA5061R	14 65			
400 4.8 i	[F101.]	05.79- 03.85	CA1291R	14 55			
412 4.9 i	[F101E.]	04.85- 12.88	CA5061R	14 65			
F 40 3.0	[F120A]	02.88- 06.92	CA5061R	14 65			
Mondial 2.9	[F106B.]	07.80- 09.83	CA5061R	14 65			
<b>PASSENGER CARS US</b>							
308 3.0 GTB		01.80- 01.80	CA1951R	14 65			
308 3.0 GTS		01.80- 01.80	CA1951R	14 65			
308 3.0 i GTB		01.81- 01.82	CA1951R	14 65			
308 3.0 i GTS		01.81- 01.82	CA1951R	14 65			
<b>AGRICULTURE</b>							
86 2.5 Diesel	[LDA 833]	06.80-	CA6161R	14 32			
95 1.3 Diesel	[8LD665.2]	11.88-	CA6161R	14 32			
96 2.7 Diesel	[5LD 824-3]	09.89-	CA6161R	14 32			
1100 1.1 Diesel	[9LD 561]	12.85-	CA6161R	14 32			
1300 1.3 Diesel	[8LD665.2]	12.85-	CA6161R	14 32			
40 WDT 1.6 Diesel	[LDW1503]	04.91-	CA5931R	14 65			
95 RS 1.7 Diesel	[5LD 825.2]	11.88-	CA6161R	14 32			
95 RS 1.9 Diesel	[11LD 625.3]		CA6161R	14 32			
<b>Flat</b>							
<b>PASSENGER CARS EU</b>							
124 1.2 1200	[124A.000]	02.73- 07.75	CA1291R	14 55			
	[154E1.000]	08.71- 10.73	CA1291R	14 55			
124 1.4 1400 Special	[124B2.000]	12.68- 07.75	CA1291R	14 55			
124 1.4 1400 Special T	[132A.000]	01.71- 07.75	CA1291R	14 55			
124 1.6 1600 Spider Sport	[132AC.000]	11.69- 08.73	CA1291R	14 55			
124 1.6 1600 Sport	[132AC.000]	01.69- 12.75	CA1291R	14 55			
124 2.0 2000	[132C3.031]	06.79- 04.85	CA1291R	14 55	06.79- 04.85	CS275	12 1.0
124 2.0 2000 Spider Europa	[132C3.031]	06.79- 04.85	CA1291R	14 55	06.79- 04.85	CS275	12 1.0
		03.82- 09.85	CA5061R	14 65			
124 2.0 2000 Volumex	[232R14]	06.83- 04.85	CA1291R	14 55	06.83- 04.85	CS275	12 1.0
125 1.6	[125A.000]	07.71- 12.72	CA1291R	14 55			
125 1.6 Special	[125B.000]	07.71- 12.72	CA1291R	14 55			
126 0.6 600 Bambino	[126A.000]				09.72- 06.77	CS308	12 0.5





126 0.65 650 Bambino	[126A1.000]					12.84- 09.87	<b>CS692</b>	12 0.6
	[126A1.048]					07.77- 11.84	<b>CS308</b>	12 0.5
						12.84- 09.87	<b>CS692</b>	12 0.6
	[141A.000]					01.83- 06.96	<b>CS308</b>	12 0.5
126 0.7 700 Bambino	[126A2.000]	09.87- 06.91	<b>CA252IR</b>	14 55		09.87- 06.91	<b>CS692</b>	12 0.6
	[126A2.048]	09.87- 06.91	<b>CA252IR</b>	14 55		09.87- 06.91	<b>CS692</b>	12 0.6
127 0.9	[100GL.000]					06.71- 05.83	<b>CS90</b>	12 0.8
	[100GL.048]					06.71- 05.83	<b>CS90</b>	12 0.8
127 1.0	[127A.000]	04.77- 10.86	<b>CA127IR</b>	14 45		04.77- 12.86	<b>CS147</b>	12 0.8
		04.77- 05.83	<b>CA77IR</b>	14 33				
127 1.0 Panorama	[127A.000]	04.77- 05.86	<b>CA77IR</b>	14 33		04.77- 05.86	<b>CS147</b>	12 0.8
127 1.0 Sport	[127A1.000]	07.78- 11.81	<b>CA77IR</b>	14 33		07.78- 11.81	<b>CS147</b>	12 0.8
127 1.3 Sport	[127A3.000]	12.81- 05.83	<b>CA127IR</b>	14 45		12.81- 05.83	<b>CS147</b>	12 0.8
127 1.3 Diesel	[127A5.000]					07.82- 12.86	<b>CS368</b>	12 0.9
127 1.3 Diesel Panorama	[127A6.000]					06.83- 12.86	<b>CS368</b>	12 0.9
128 1.1 1100	[128A.000]	09.69- 12.84	<b>CA77IR</b>	14 33		09.69- 12.84	<b>CS91</b>	12 0.8
	[128A.048]	09.69- 09.81	<b>CA77IR</b>	14 33		09.69- 09.81	<b>CS91</b>	12 0.8
	[128AC5.000]	03.72- 02.81	<b>CA77IR</b>	14 33		03.72- 02.81	<b>CS91</b>	12 0.8
128 1.3 1300	[128A1.000]	01.71- 12.84	<b>CA77IR</b>	14 33		03.69- 12.84	<b>CS91</b>	12 0.8
	[128AC.000]	11.71- 12.75	<b>CA77IR</b>	14 33		11.71- 12.75	<b>CS91</b>	12 0.8
128 1.3 1300 Berlinetta	[128AC.000]	06.75- 12.79	<b>CA77IR</b>	14 33		06.75- 12.79	<b>CS91</b>	12 0.8
128 1.3 1300 Rally						09.71- 02.76	<b>CS91</b>	12 0.8
128 1.3 1300 Sport	[128A1.000]	10.78- 12.84	<b>CA77IR</b>	14 33		03.69- 12.84	<b>CS91</b>	12 0.8
	[131A.000]					10.74- 12.82	<b>CS141</b>	12 0.8
131 1.3 Mirafiori	[131A6.000]					10.74- 09.81	<b>CS141</b>	12 0.8
		10.74- 09.81	<b>CA119IR</b>	14 45				
131 1.3 Mirafiori Panorama	[131A.000]	03.75- 03.82	<b>CA119IR</b>	14 45		03.75- 03.82	<b>CS141</b>	12 0.8
		03.75- 03.82	<b>CA129IR</b>	14 55				
131 1.3 Panorama Mirafiori	[131A6.000]	10.74- 12.80	<b>CA129IR</b>	14 55		10.74- 12.80	<b>CS141</b>	12 0.8
		11.76- 12.80	<b>CA119IR</b>	14 45				
131 1.3 Super Mirafiori	[131B.000]	03.78- 12.80	<b>CA119IR</b>	14 45		03.78- 12.80	<b>CS141</b>	12 0.8
		03.78- 12.80	<b>CA129IR</b>	14 55				
131 1.4 Mirafiori	[131C.000]	11.80- 01.84	<b>CA119IR</b>	14 45		11.80- 01.84	<b>CS139</b>	12 1.3
		11.80- 01.84	<b>CA129IR</b>	14 55				
	[131C1.000]	11.80- 01.84	<b>CA119IR</b>	14 45		11.80- 01.84	<b>CS139</b>	12 1.3
		11.80- 01.84	<b>CA129IR</b>	14 55				
131 1.4 Super Mirafiori	[131C1.000]	04.81- 12.83	<b>CA119IR</b>	14 45		01.81- 12.83	<b>CS139</b>	12 1.3
		04.81- 12.83	<b>CA129IR</b>	14 55				
131 1.6 1600	[131A1.000]	10.74- 09.81	<b>CA119IR</b>	14 45		10.74- 06.80	<b>CS139</b>	12 1.3
		10.74- 09.81	<b>CA129IR</b>	14 55		07.80- 09.81	<b>CS275</b>	12 1.0
	[131C2.000]	11.76- 12.84	<b>CA119IR</b>	14 45		11.76- 12.84	<b>CS275</b>	12 1.0
		11.76- 12.84	<b>CA129IR</b>	14 55				
131 1.6 1600 Panorama	[131C2.000]	11.80- 01.84	<b>CA119IR</b>	14 45		11.80- 01.84	<b>CS275</b>	12 1.0
		11.80- 01.84	<b>CA129IR</b>	14 55				
131 1.6 1600 Super	[131C3.000]	03.78- 01.84	<b>CA119IR</b>	14 45		03.78- 06.80	<b>CS139</b>	12 1.3
		03.78- 01.84	<b>CA129IR</b>	14 55		07.80- 01.84	<b>CS275</b>	12 1.0
131 1.6 Panorama	[131A1.000]	03.75- 12.78	<b>CA119IR</b>	14 45		03.75- 12.78	<b>CS139</b>	12 1.3
		03.75- 12.78	<b>CA129IR</b>	14 55				
131 1.6 Panorama Super	[131C3.000]	12.79- 12.81	<b>CA119IR</b>	14 45		12.79- 12.81	<b>CS141</b>	12 0.8
		12.79- 12.81	<b>CA129IR</b>	14 55				
131 1.6 Super Mirafiori	[131B1.000]	03.79- 03.82	<b>CA119IR</b>	14 45		07.80- 03.82	<b>CS275</b>	12 1.0
		03.79- 03.82	<b>CA129IR</b>	14 55		03.79- 06.80	<b>CS139</b>	12 1.3
131 2.0 2000 Racing	[131B2.000]	06.78- 12.81	<b>CA119IR</b>	14 45		06.78- 08.79	<b>CS139</b>	12 1.3
		06.78- 12.81	<b>CA129IR</b>	14 55		07.80- 12.81	<b>CS275</b>	12 1.0
131 2.0 2000 Super	[131C4.000]	01.81- 01.84	<b>CA119IR</b>	14 45		01.81- 01.84	<b>CS275</b>	12 1.0
		01.81- 01.84	<b>CA129IR</b>	14 55				
131 2.0 Diesel	[8144.65]	03.78- 01.84	<b>CA255IR</b>	14 45		03.78- 01.84	<b>CS289</b>	12 2.0
		03.78- 01.84	<b>CA316IR</b>	14 55				
		03.78- 01.84	<b>CA355IR</b>	14 65				
131 2.0 Diesel Panorama	[8144.65]					07.78- 08.84	<b>CS289</b>	12 2.0
131 2.5 Diesel	[8144.61]	03.78- 02.84	<b>CA255IR</b>	14 45		06.78- 02.84	<b>CS289</b>	12 2.0
		03.78- 02.84	<b>CA316IR</b>	14 55				
		03.78- 02.84	<b>CA355IR</b>	14 65				
131 2.5 Diesel 2500 Super Mirafiori	[8144.61]	08.78- 01.84	<b>CA255IR</b>	14 45		08.78- 01.84	<b>CS289</b>	12 2.0
		08.78- 01.84	<b>CA316IR</b>	14 55				
		08.78- 01.84	<b>CA355IR</b>	14 65				
132 1.6 1600	[132BBOAO]	04.72- 05.81	<b>CA129IR</b>	14 55		07.80- 05.81	<b>CS275</b>	12 1.0
		11.76- 05.81	<b>CA119IR</b>	14 45				
	[132C.000]	05.72- 05.81	<b>CA129IR</b>	14 55		07.80- 05.81	<b>CS275</b>	12 1.0
		11.76- 05.81	<b>CA119IR</b>	14 45				
	[132C6.000]	03.77- 12.81	<b>CA119IR</b>	14 45				
		03.77- 12.81	<b>CA129IR</b>	14 55				
132 1.7 1700	[132B1.000]	11.75- 01.77	<b>CA129IR</b>	14 55				
		11.76- 01.77	<b>CA119IR</b>	14 45				
132 1.8 1800 GLS		02.74- 12.75	<b>CA129IR</b>	14 55				
		02.74- 12.75	<b>CA119IR</b>	14 45				
132 1.8 1800 Special		04.72- 01.74	<b>CA119IR</b>	14 45				
		04.72- 01.74	<b>CA129IR</b>	14 55				
132 2.0 2000	[132C2.000]	05.77- 06.81	<b>CA119IR</b>	14 45		07.80- 06.81	<b>CS275</b>	12 1.0
		05.77- 06.81	<b>CA129IR</b>	14 55				
132 2.0 i.e. 2000	[132C3.000]	01.80- 05.81	<b>CA119IR</b>	14 45		07.80- 05.81	<b>CS275</b>	12 1.0
		01.80- 05.81	<b>CA129IR</b>	14 55				
132 2.0 Diesel	[8144.65]	07.78- 07.82	<b>CA255IR</b>	14 45		07.78- 07.82	<b>CS289</b>	12 2.0
		07.78- 07.82	<b>CA316IR</b>	14 55				
132 2.5 Diesel	[8144.61]	07.78- 07.82	<b>CA255IR</b>	14 45		07.78- 07.82	<b>CS289</b>	12 2.0
		07.78- 07.82	<b>CA316IR</b>	14 55				
500 0.5	[110F.000]					11.72- 12.74	<b>CS308</b>	12 0.5
	[120.000]					11.72- 12.74	<b>CS308</b>	12 0.5
500 0.9	[312A2.000]	07.10-	<b>CA1969IR</b>	14 120				
500 1.2	[169A4.000]	10.07-	<b>CA1886IR</b>	14 70		10.07-	<b>CS1379</b>	12 0.8
		AC 10.07-	<b>CA1742IR</b>	14 85				
		AC 10.07-	<b>CA1998IR</b>	14 105				
		A13 10.07-	<b>CA2094IR*</b>	14 90				
500 1.2 LPG	[169A4.000]	12.10-	<b>CA1886IR</b>	14 70				
		A25 12.10-	<b>CA2070IR*</b>	14 140				
		A25 12.10-	<b>CA2096IR*</b>	14 105				
500 1.3 Multijet	[169A1.000]	10.07-	<b>CA1856IR</b>	14 75		10.07-	<b>CS1346</b>	12 1.3
		AC 10.07-	<b>CA1862IR</b>	14 90				
		AC 10.07-	<b>CA1934IR</b>	14 105				
500 1.4	[169A3.000]	10.07-	<b>CA1886IR</b>	14 70		10.07-	<b>CS1379</b>	12 0.8
		AC 10.07-	<b>CA1742IR</b>	14 85				
		AC 10.07-	<b>CA1998IR</b>	14 105				
		A13 10.07-	<b>CA2094IR*</b>	14 90				
500 1.4 Abarth	[312A1.000]				08.08-	<b>CS1379</b>	12 0.8	



**FIAT Continued**

500 1.4 16V Abarth	[312A3.000]				08.08-	CS1379	12	0.8
238-Series 1.4	[131AZ000]	06.76- 12.77	CA1291R	14 55				
		01.78- 06.82	CA3071R	14 45				
	[131BZ0C0]	06.80- 06.82	CA3071R	14 45				
	[131FZ]	06.80- 06.82	CA3071R	14 45				
242-Series 1.6	[124B3.000]				10.75- 07.82	CS147	12	0.8
242-Series 1.9	[132AZ2.000]				10.75- 07.82	CS147	12	0.8
500 C 0.9	[312A2.000]	09.09-	CA19691R	14 120				
	[169A4.000]	09.09-	CA18861R	14 70	09.09-	CS1379	12	0.8
		A25 09.09-	CA20701R*	14 140				
		A25 09.09-	CA20961R*	14 105				
	A13 09.09-	CA17421R	14 85					
500 C 1.3 Multijet	[169A1.000]	09.09-	CA18561R	14 75	09.09-	CS1346	12	1.3
		09.09-	CA18621R	14 90				
		09.09-	CA19341R	14 105				
500 C 1.4	[169A3.000]	09.09-	CA18861R	14 70	09.09-	CS1379	12	0.8
		09.09-	CA20941R*	14 90				
		A25 09.09-	CA20961R*	14 105				
	A13 09.09-	CA17421R	14 85					
500 C 1.4 Abarth	[312A3.000]				09.09-	CS1379	12	0.8
Albea 1.2 i.e. 16V	[188A5.000]	AC 01.02-	CA17661R	14 75				
Albea 1.2 i.e. 8V	[188A4.000]	AC 01.02-	CA17661R	14 75				
Albea 1.4	[350A1.000]	01.07-	CA17661R	14 75	01.07-	CS1379	12	0.8
		01.07-	CA18861R	14 70				
		01.07-	CA19981R	14 105				
Albea 1.6 i.e. 16V	[182A6.000]	01.02-	CA14851R	14 80				
		AC 01.02-	CA14711R	14 90				
Argenta 1.6 1600	[132D.000]	06.81- 11.85	CA1191R	14 45	06.81- 11.85	CS275	12	1.0
		06.81- 11.85	CA1291R	14 55				
		AC 06.81- 11.85	CA5061R	14 65				
Argenta 1.6 i.e. 1600		04.81- 12.85	CA1191R	14 45	04.81- 12.85	CS275	12	1.0
		04.81- 12.85	CA1291R	14 55				
Argenta 2.0 2000	[132C2.000]	06.81- 11.85	CA1191R	14 45	06.81- 11.85	CS275	12	1.0
		06.81- 11.85	CA1291R	14 55				
	[132D1.000]	AC 06.81- 11.85	CA5061R	14 65				
		06.81- 11.85	CA1191R	14 45	06.81- 05.83	CS275	12	1.0
		06.81- 11.85	CA1291R	14 55				
Argenta 2.0 2000 Volumax		AC 06.81- 11.85	CA5061R	14 65				
		06.84- 07.85	CA1291R	14 55	06.84- 07.85	CS275	12	1.0
		06.84- 07.85	CA1191R	14 45				
Argenta 2.0 i.e. 2000	[132C3.000]	06.81- 11.85	CA1191R	14 45	06.81- 11.85	CS275	12	1.0
		06.81- 11.85	CA1291R	14 55				
		AC 06.81- 11.85	CA5061R	14 65				
Argenta 2.5 Diesel 2500	[8144.61]	06.81- 11.85	CA3161R	14 55	06.81- 11.85	CS289	12	2.0
		06.81- 11.85	CA3551R	14 65				
		AC 06.81- 11.85	CA3551R	14 65				
Argenta 2.5 TD	[8144.61.500.81]	07.83- 11.85	CA3161R	14 55	07.83- 11.85	CS289	12	2.0
		07.83- 11.85	CA3551R	14 65				
		AC 07.83- 11.85	CA3551R	14 65				
Barchetta 1.8 16V	[183A1.000]	04.95- 09.00	CA11601R	14 65	04.95- 09.00	CS1042	12	1.4
		AC 04.95- 09.00	CA12161R	14 85	04.95- 09.00	CS1053	12	1.1
		AC 04.95- 09.00	CA12231R	14 100				
	[188A6.000]	Eng. -2988825 10.00- 12.04	CA11601R	14 65	10.00- 12.04	CS1053	12	1.1
AC, Eng. -2988825 10.00- 12.04		CA12231R	14 100	10.00- 12.04	CS1042	12	1.4	
AC 10.00- 12.04		CA17431R	14 90					
Brava 1.2 16V	[182B2.000]	12.98- 10.00	CA20601R*	14 75	12.98- 10.00	CS796	12	0.8
		PS 12.98- 10.00	CA13491R	14 65				
		AC 12.98- 10.00	CA13501R	14 85				
[188A5.000]	10.00- 10.01	CA20601R*	14 75	12.98-	CS796	12	0.8	
	12.98-	CA13491R	14 65					
	AC 10.00-	CA17421R	14 85					
Brava 1.4	[182A5.000]	PS 10.95- 10.01	CA11601R	14 65	10.95- 10.01	CS981	12	0.9
		ACPS 10.95- 10.01	CA11591R	14 85				
		AC 10.95- 10.01	CA11591R	14 85				
Brava 1.4 12V	[182A3.000]	PS 10.95- 10.01	CA11601R	14 65	10.95- 10.01	CS981	12	0.9
		ACPS 10.95- 10.01	CA11591R	14 85				
		AC 10.95- 10.01	CA11591R	14 85				
Brava 1.6 16V	[182B6.000]	01.99- 12.02	CA14711R	14 90	01.99- 12.02	CS1213	12	1.1
		01.99- 12.02	CA16481R	14 105				
Brava 1.6 16V EL	[182A6.000]	10.95- 10.01	CA12201R	14 75	AT 10.95- 10.01	CS1043	12	0.9
		10.95- 10.01	CA12211R	14 85	10.95- 10.01	CS975	12	0.9
		PS 10.95- 10.01	CA12201R	14 75	A13 01.97- 10.01	CS1191	12	1.4
		AC 10.95- 10.01	CA12211R	14 85				
Brava 1.6 16V SX	[182A4.000]	11.98- 10.01	CA14851R	14 80	AT 02.96- 10.98	CS1043	12	0.9
		PS 02.96- 10.98	CA12201R	14 75	A13 01.97- 10.01	CS1191	12	1.4
		AC 02.96- 10.98	CA12211R	14 85	11.98- 10.01	CS1213	12	1.1
		AC 11.98- 10.01	CA14711R	14 90	02.96- 10.98	CS975	12	0.9
		AC 11.98- 10.01	CA16481R	14 105				
Brava 1.8 16V GT	[182A2.000]	10.95- 01.01	CA11591R	14 85	10.95- 10.01	CS1042	12	1.4
		10.95- 11.98	CA11901R	14 75				
		11.98- 01.01	CA12231R	14 100				
		AC 10.95- 11.98	CA11891R	14 100				
		AC 12.95- 01.01	CA12231R	14 100				
Brava 1.9 Diesel	[160A7.000]	10.95- 10.01	CA10841R	14 65	10.95- 10.01	CS992	12	2.2
		AC 10.95- 10.01	CA11611R	14 85				
Brava 1.9 JTD	[182B4.000]	12.98- 10.01	CA12231R	14 100	12.98- 10.01	CS1045	12	2.0
		12.98- 10.01	CA15581R	14 100	12.98- 10.01	CS1124	12	2.2
	[182B9.000]	12.98- 10.01	CA16981R	14 120				
		09.00- 10.01	CA15581R	14 100	09.00- 10.01	CS1045	12	2.0
		09.00- 10.01	CA1124	12	2.2			
		AC 09.00- 10.01	CA1264	12	1.7			
Brava 1.9 TD	[182A7.000]	03.96- 10.01	CA11901R	14 75	03.96- 10.01	CS1045	12	2.0
		AC 03.96- 10.01	CA11891R	14 100	03.96- 10.01	CS1124	12	2.2
	[182A8.000]	03.96- 10.01	CA11901R	14 75	03.96- 10.01	CS1045	12	2.0
		AC 03.96- 10.01	CA11891R	14 100	03.96- 10.01	CS1124	12	2.2
Bravo 1.2 16V	[182B2.000]	12.98- 10.00	CA13491R	14 65	12.98- 10.00	CS796	12	0.8
		12.98- 10.00	CA20601R*	14 75				
		AC 12.98- 10.00	CA13501R	14 85				
	[188A5.000]	10.00- 10.01	CA20601R*	14 75	12.98-	CS796	12	0.8
12.98-		CA13491R	14 65					
AC 10.00-		CA17421R	14 85					
Bravo 1.4	[182A3.000]	PS 10.95- 10.01	CA11601R	14 65	10.95- 10.01	CS981	12	0.9
		ACPS 10.95- 10.01	CA11591R	14 85				
		AC 10.95- 10.01	CA11591R	14 85				



	[182A5.000]	PS 10.95-10.01 ACPS 10.95-10.01 AC 10.95-10.01	CA1160IR 14 65 CA1159IR 14 85 CA1159IR 14 85		10.95-10.01	CS981 12 0.9
	[192B2.000]	04.07- 04.07- AC 04.07- AC 04.07-	CA1886IR 14 70 CA2096IR* 14 105 CA1742IR 14 85 CA1998IR 14 105		04.07-	CS1379 12 0.8
Bravo 1.4 16V	[198A7.000]	03.08-05.09	CA1969IR 14 120		03.08-	CS1379 12 0.8
Bravo 1.4 T-Jet	[198A1.000]	09.07-	CA1969IR 14 120		09.07-	CS1379 12 0.8
	[198A4.000]	09.07- AC 09.07- A13 09.07-	CA1886IR 14 70 CA1969IR 14 120 CA2096IR* 14 105		09.07-	CS1379 12 0.8
Bravo 1.4 LPG	[192B2.000]	11.09- A39 11.09-	CA1886IR 14 70 CA1742IR 14 85		11.09-	CS1379 12 0.8
Bravo 1.6	[182A6.000]	10.95-10.01 10.95-10.01 PS 10.95-10.01 AC 10.95-10.01	CA1220IR 14 75 CA1221IR 14 85 CA1220IR 14 75 CA1221IR 14 85		10.95-10.01 10.95-10.01 A13 01.97-10.01 AT 10.95-10.01	CS975 12 0.9 CS1213 12 1.1 CS1191 12 1.4 CS1043 12 0.9
Bravo 1.6 SX	[182A4.000]	11.98-10.01 PS 03.96-10.98 AC 03.96-10.98 AC 11.98-10.01	CA1485IR 14 80 CA1220IR 14 75 CA1221IR 14 85 CA1471IR 14 90		03.96-11.98 AT 03.96-10.98 A13 01.97-10.01 11.98-10.01	CS975 12 0.9 CS1043 12 0.9 CS1191 12 1.4 CS1213 12 1.1
Bravo 1.6 Multijet	[198A2.000]	03.08- 03.08- A13 03.08-	CA2049IR* 14 100 CA2050IR* 14 120 CA1995IR 14 140		03.08- 03.08- A13 03.08-	CS1264 12 1.7 CS1045 12 2.0 CS1264 12 1.7 CS1335 12 2.2
	[198A3.000]	03.08- 03.08- A13 03.08-	CA2049IR* 14 100 CA2050IR* 14 120 CA1995IR 14 140		03.08- A13 03.08-	CS1264 12 1.7 CS1335 12 2.2
	[199A6.000]	03.08-	CA1995IR 14 140		03.08-	CS1264 12 1.7
Bravo 1.8 GT	[182A2.000]	10.95-10.01 10.95-10.01 AC 10.95-10.01 AC 10.95-10.01	CA1189IR 14 100 CA1190IR 14 75 CA1189IR 14 100 CA1216IR 14 85		10.95-10.01	CS1042 12 1.4
Bravo 1.9 Diesel	[160A7.000]	10.95-10.01 AC 10.95-10.01	CA1084IR 14 65 CA1161IR 14 85		10.95-10.01	CS992 12 2.2
Bravo 1.9 Diesel Multijet	[192A8.000]	04.07- A13 04.07-	CA2048IR 14 90 CA1698IR 14 120		04.07-	CS1335 12 2.2
	[937A5.000]	04.07-	CA1885IR 14 120		04.07- A13 04.07- 04.07-	CS1264 12 1.7 CS1335 12 2.2 CS1045 12 2.0
Bravo 1.9 JTD	[182B4.000]	12.98-10.01 12.98-10.01 12.98-10.01	CA1223IR 14 100 CA1558IR 14 100 CA1698IR 14 120		12.98-10.01 12.98-10.01	CS1045 12 2.0 CS1124 12 2.2
	[182B9.000]	09.00-10.01	CA1558IR 14 100		09.00-10.01 09.00-10.01 09.00-10.01	CS1264 12 1.7 CS1045 12 2.0 CS1124 12 2.2
Bravo 1.9 Multijet	[192B4.000]	AC 09.00-10.01	CA1698IR 14 120		09.00-10.01	CS1124 12 2.2
	[192B5.000]	A13 11.06- 04.07-12.08 A13 04.07-12.08	CA1698IR 14 120 CA2048IR 14 90 CA1698IR 14 120		04.07-12.08	CS1335 12 2.2
Bravo 1.9 TD	[182A7.000]	03.96-10.01 AC 03.96-10.01	CA1190IR 14 75 CA1189IR 14 100		03.96-10.01 03.96-10.01	CS1124 12 2.2 CS1045 12 2.0
Bravo 2.0 20V	[182A1.000]	10.95-10.01 AC 10.95-10.01 AC 10.95-10.01	CA1222IR 14 85 CA1218IR 14 85 CA1451IR 14 100		10.95-10.01	CS1042 12 1.4
	[182B7.000]	11.98-10.01	CA1222IR 14 85		11.98-10.01 11.98-10.01	CS1053 12 1.1 CS1042 12 1.4
Bravo 2.0 Multijet	[198A5.000]	09.08- 09.08- 09.08-	CA1995IR 14 140 CA2049IR* 14 100 CA2050IR* 14 120			
	[844A2.000]	09.08-	CA2049IR* 14 100			
Campagnola 2.0	[6132AZ2.000]	06.74-10.89	CA129IR 14 55		06.74-10.89	CS689 12 2.5
Campagnola 2.4 Diesel	[Sofim-8144.61.200]	06.74-10.89	CA316IR 14 55			
Cinquecento 0.7	[170A.000]				12.91-01.96	CS711 12 1.0
Cinquecento 0.7 i	[170A.046]				10.92-07.98	CS711 12 1.0
Cinquecento 0.9	[170A1.000]	07.91-12.93	CA893IR 14 55		07.91-12.93	CS1038 12 0.8
Cinquecento 0.9 i.e.	[1170A1.000]	07.91-07.99	CA893IR 14 55		07.91-07.99	CS1038 12 0.8
	[1170A1.046]	07.91-07.99	CA893IR 14 55		07.91-07.99	CS1038 12 0.8
	[170A1.046]	07.91-12.93	CA893IR 14 55		07.91-12.93	CS1038 12 0.8
Cinquecento 1.1 Sporting	[176B2.000]	10.94-01.98 AC 10.94-01.98	CA851IR 14 65 CA851IR 14 65 ▲		10.94-01.98	CS796 12 0.8
Coupe 1.8 16V	[183A1.000]	03.96-08.00	CA1223IR 14 100		03.96-08.00 03.96-08.00	CS1053 12 1.1 CS1042 12 1.4
Coupe 2.0 16V	[836A3.000]	11.93-08.96 AC 11.93-08.96	CA506IR 14 65 CA1233IR 14 100		11.93-08.96	CS584 12 1.4
Coupe 2.0 20V	[182A1.000]	08.96-04.98 AC 08.96-04.98	CA1222IR 14 85 CA1218IR 14 85		08.96-04.98 08.96-04.98	CS1053 12 1.1 CS1042 12 1.4
	[182B3.000]	04.98-08.00 AC 04.98-08.00	CA1222IR 14 85 CA1218IR 14 85		04.98-08.00	CS1053 12 1.1
Coupe 2.0 Turbo 16V	[175A1.000]	11.93-08.96 AC 11.93-08.96	CA506IR 14 65 CA1233IR 14 100		11.93-08.96	CS584 12 1.4
Coupe 2.0 Turbo 20V	[175A3.000]	08.96-08.00 RHD 08.96-08.00 AC 08.96-08.00 AC 08.96-08.00	CA1451IR 14 100 CA1222IR 14 85 CA1218IR 14 85 CA1451IR 14 100		08.96-08.00 08.96-08.00	CS1053 12 1.1 CS1042 12 1.4
Croma 1.6	[154A.048]	12.85-02.89 12.85-02.89	CA129IR 14 55 CA506IR 14 65 ▲		12.85-02.89	CS393 12 0.9 CS514 12 1.4
Croma 1.8 16V	[939A4.000]	12.05-	CA1833IR 14 120		12.05-	CS1438 12 1.1
Croma 1.9 Diesel Multijet	[939A1.000]	06.05- 06.05- 06.05-	CA1885IR 14 120 CA1995IR 14 140 CA2050IR* 14 120		06.05-	CS1264 12 1.7
	[939A2.000]	06.05- 06.05- 06.05-	CA1885IR 14 120 CA1995IR 14 140 CA2050IR* 14 120		06.05- A13 06.05-	CS1045 12 2.0 CS1335 12 2.2
Croma 1.9 Multijet	[939A7.000]	06.05- 06.05- 06.05-	CA1884IR 14 105 CA1995IR 14 140 CA2050IR* 14 120		06.05-	CS1264 12 1.7
Croma 1.9 TD	[154C6.000]	03.88-10.92 AC 03.88-10.92	CA506IR 14 65 CA644IR 14 90		03.88-10.92	CS351 12 2.2
Croma 1.9 TDDi	[154D1.000]	11.92-12.96 AC 11.92-12.96	CA506IR 14 65 CA644IR 14 90		11.92-12.96	CS350 12 2.2
Croma 2.0 2000 CHT	[154A1.000]	12.85-01.87 12.85-02.89	CA129IR 14 55 CA506IR 14 65		12.85-02.89	CS514 12 1.4 CS393 12 0.9



FIAT Continued

	[154C5.000]	01.91- 09.92 CA5061R 14 65		01.91- 09.92 CS514 12 1.4
		01.91- 09.92 CA7271R 14 90		
		AC 01.91- 09.92 CA7271R 14 90		
Croma 2.0 16V	[154E1.000]	08.92- 12.96 CA10391R 14 80		08.92- 12.96 CS514 12 1.4
		08.92- 12.96 CA12341R 14 90		
Croma 2.0 i.e. Turbo	[834C.146]	11.86- 09.90 CA5061R 14 65		11.86- 09.90 CS393 12 0.9
		AC 11.86- 09.90 CA5691R 14 85		
Croma 2.0 i.e. Turbo 2000	[154A2.000]	12.85- 06.90 CA5061R 14 65	AT 12.85- 06.90 CS514 12 1.4	
		AC 12.85- 06.90 CA5691R 14 85	12.85- 06.90 CS393 12 0.9	
	[154C4.046]	10.90- 08.96 CA5061R 14 65	01.92- 08.96 CS965 12 1.4	
		AC 10.90- 08.96 CA12341R 14 90	10.90- 11.91 CS514 12 1.4	
	[834C.146]	06.87- 09.90 CA5061R 14 65	A34 06.87- 09.90 CS514 12 1.4	
		AC 06.87- 07.90 CA5691R 14 85	06.87- 06.90 CS393 12 0.9	
		AC 07.90- 09.90 CA12341R 14 90		
Croma 2.0 i.e. 2000	[154C3.000]	03.87- 09.92 CA5061R 14 65	03.87- 09.92 CS393 12 0.9	
		AC 03.87- 09.92 CA5691R 14 85	AT 03.87- 09.90 CS514 12 1.4	
	[154C3.046]	10.87- 08.96 CA5061R 14 65	10.87- 06.90 CS393 12 0.9	
		AC 10.87- 07.90 CA5691R 14 85	AT 10.87- 12.91 CS514 12 1.4	
		AC 07.90- 08.96 CA12341R 14 90	01.92- 08.96 CS965 12 1.4	
	[834B.000]	03.87- 09.92 CA5061R 14 65	AT 03.87- 09.90 CS514 12 1.4	
		AC 03.87- 09.92 CA5691R 14 85	03.87- 09.92 CS393 12 0.9	
	[834B.048]	03.86- 09.90 CA5061R 14 65	AT 03.86- 09.90 CS514 12 1.4	
		AC 03.86- 09.90 CA5691R 14 85	03.86- 09.90 CS393 12 0.9	
	[834B.146]	11.92- 08.96 CA5061R 14 65	11.92- 08.96 CS965 12 1.4	
		AC 11.92- 08.96 CA12341R 14 90		
Croma 2.2 16V	[194A1.000]		06.05- 04.07 CS1291 12 1.8	
			04.07- CS1461* 12	
Croma 2.4 JTDM Multijet	[939A3.000]	06.05- CA20161R 14 150	06.05- CS1335 12 2.2	
Croma 2.5 V6	[834G.000]		06.93- 12.96 CS585 12 1.4	
Croma 2.5 Diesel	[8144.67]	12.85- 12.89 CA3551R 14 65	12.85- 12.89 CS351 12 2.2	
		AC 12.85- 12.89 CA5691R 14 85		
Croma 2.5 TD	[8144.97S]	12.91- 08.96 CA3551R 14 65	12.91- 08.96 CS338 12 2.5	
		AC 12.91- 08.96 CA5691R 14 85		
Croma 2.5 TD 2500	[8144.91.2000]	12.85- 08.89 CA3551R 14 65	12.85- 08.89 CS351 12 2.2	
		AC 12.85- 08.89 CA5691R 14 85		
	[8144.97]	05.89- 08.96 CA3551R 14 65	05.89- 08.96 CS351 12 2.2	
		AC 05.89- 08.96 CA12341R 14 90		
	[8144.97Y]	05.89- 08.96 CA3551R 14 65	11.92- 08.96 CS351 12 2.2	
		AC 05.89- 08.96 CA12341R 14 90		
Doblo 1.2 i.e. 8V	[223A5.000]	03.01- CA20601R* 14 75	03.01- CS1125 12 0.8	
		03.01- 10.01 CA8901R 14 65		
		10.01- CA18431R 14 60		
		04.02- CA18441R 14 70		
		PS 03.01- 04.03 CA11531R 14 65		
		PS 03.01- CA20611R* 14 75		
		AC 03.01- CA11541R 14 75		
Doblo 1.2 Multijet	[199A3.000]	A18 02.10- CA18621R 14 90	02.10- CS1346 12 1.3	
	[263A2.000]	A18 02.10- CA18621R 14 90	02.10- CS1346 12 1.3	
Doblo 1.3 16V JTD Cargo	[223A9.000]	08.06- CA18561R 14 75	08.06- CS1346 12 1.3	
		AC 08.06- CA18621R 14 90		
		AC 08.06- CA19341R 14 105		
Doblo 1.3 Diesel Multijet	[199A2.000]	10.05- CA18561R 14 75	10.05- CS1346 12 1.3	
		AC 10.05- CA18621R 14 90		
		AC 10.05- CA19341R 14 105		
	[223A9.000]	10.05- CA18561R 14 75	10.05- CS1346 12 1.3	
		AC 10.05- CA18621R 14 90		
		AC 10.05- CA19341R 14 105		
Doblo 1.3 JTD 16V	[188A9.000]	05.04- CA18561R 14 75	05.04- CS1346 12 1.3	
		AC 05.04- CA18621R 14 90		
		AC 05.04- CA19341R 14 105		
Doblo 1.3 Multijet	[199A3.000]	02.10- CA18561R 14 75		
		AC 02.10- CA18621R 14 90		
Doblo 1.4	[350A1.000]	10.05- CA18861R 14 70	10.05- CS1379 12 0.8	
		10.05- CA20941R* 14 90		
	[843A1.000]	02.10- CA18861R 14 70	02.10- CS1379 12 0.8	
		AC 02.10- CA17421R 14 85		
		A25 02.10- CA20701R* 14 140		
		A25 02.10- CA20961R* 14 105		
Doblo 1.4 Cargo	[843A1.000]	02.10- CA18861R 14 70	02.10- CS1379 12 0.8	
		AC 02.10- CA17421R 14 85		
		A25 02.10- CA20701R* 14 140		
		A25 02.10- CA20961R* 14 105		
Doblo 1.4 Cargo Natural Power	[198A4.000]		06.10- CS1379 12 0.8	
Doblo 1.4 Natural Power	[198A4.000]		02.10- CS1379 12 0.8	
Doblo 1.6	[182B6.000]	09.02- CA14711R 14 90	09.02- CS1213 12 1.1	
		09.02- CA14851R 14 80	09.02- CS1345 12 1.3	
		AC 09.02- CA16481R 14 105		
Doblo 1.6 i.e. 16V	[182B6.000]	10.01- CA14711R 14 90	10.01- CS1345 12 1.3	
		10.01- CA14851R 14 80	10.01- CS1213 12 1.1	
		10.01- CA16481R 14 105		
Doblo 1.6 16V Multijet	[263A4.000]	02.10- CA20491R* 14 100		
		A25 02.10- CA20501R* 14 120		
Doblo 1.6 16V Multijet Cargo	[182B6.000]	02.10- CA20491R* 14 100	02.10- CS1264 12 1.7	
		A25 02.10- CA20501R* 14 120		
Doblo 1.6 Multijet	[198A3.000]	02.10- CA20501R* 14 120		
	[263A4.000]	02.10- CA20491R* 14 100	02.10- CS1264 12 1.7	
		A25 02.10- CA20501R* 14 120		
		02.10- CA20491R* 14 100	02.10- CS1264 12 1.7	
		02.10- CA20501R* 14 120		
Doblo 1.6 Multijet Cargo	[263A4.000]	02.10- CA20491R* 14 100	02.10- CS1264 12 1.7	
Doblo 1.9 Diesel	[223A6.000]	03.01- CA16961R 14 65	03.01- CS1212 12 1.8	
		AC 03.01- CA15581R 14 100		
		AC 03.01- CA16971R 14 90		
Doblo 1.9 Diesel Multijet	[186A9.000]	10.05- CA16971R 14 90	10.05- CS1264 12 1.7	
		AC 10.05- CA15581R 14 100		
		AC 10.05- CA16981R 14 120		
Doblo 1.9 JTD	[182B9.000]	10.01- CA15581R 14 100	10.01- CS1045 12 2.0	
		10.01- CA16971R 14 90	10.01- CS1264 12 1.7	
		AC 10.01- CA15581R 14 100		
		AC 10.01- CA16971R 14 90		
	[223A7.000]	10.01- 09.05 CA15581R 14 100	02.02- 09.05 CS1264 12 1.7	
		10.01- 09.05 CA16971R 14 90	10.01- 09.05 CS1045 12 2.0	
	[223B1.000]	10.01- 09.05 CA15581R 14 100	02.02- 09.05 CS1264 12 1.7	
		10.01- 09.05 CA16971R 14 90	10.01- 09.05 CS1045 12 2.0	



	[223B2.000]	AC 10.01- AC 10.01-	CA1558IR 14 100 CA1697IR 14 90		10.01- 10.01-	CS1045 CS1264	12 2.0 12 1.7
Doblo 1.9 Multijet Cargo	[186A9.000]	12.06- AC 12.06- AC 12.06-	CA1697IR 14 90 CA1558IR 14 100 CA1698IR 14 120		12.06-	CS1264	12 1.7
Doblo 2.0 Multijet	[263A1.000]	02.10- 02.10- 02.10- 02.10-	CA2049IR* 14 100 CA2050IR* 14 120 CA2049IR* 14 100 CA2050IR* 14 120				
Ducato 1.8	[169B]	01.82- 12.90	CA1501R 14 50		01.82- 12.90 01.82- 12.90 07.82- 12.88	CS129 CS352 CS352	12 0.9 12 0.85 12 0.85
Ducato 1.9 Diesel	[149B1.000] [230A2.000]	01.88- 03.94 03.94- 04.02	CA129IR 14 55 CA1258IR 14 75		01.88- 03.94 03.94- 04.02	CS554 CS554	12 2.2 12 2.2
		AC 03.94- 04.02	CA1437IR# 14 85				
	[D9B]	04.98- 10.01	CA1086IR 14 80		04.98- 04.02	CS554	12 2.2
	[DJJ]	04.98- 04.02	CA638IR 14 80		04.98- 04.02	CS1177	12 1.7
Ducato 1.9 Diesel Combinato	[230A2.000]	06.95- 10.01	CA1258IR 14 75		06.95- 10.01	CS554	12 2.2
		AC 06.95- 10.01	CA1437IR# 14 85				
Ducato 1.9 Diesel Panorama	[149B1.000]	02.87- 03.94 02.87- 08.90 02.87- 08.90 07.90- 03.94	CA129IR 14 55 CA316IR 14 55 CA355IR 14 65 CA642IR 14 55		02.87- 03.94	CS554	12 2.2
Ducato 1.9 TD	[230A3.000]	03.94- 04.02	CA1258IR 14 75		03.94- 04.02	CS554	12 2.2
		AC 03.94- 04.02	CA1437IR# 14 85				
	[230A4.000]	08.94- 04.02	CA1258IR 14 75		08.94- 04.02	CS554	12 2.2
		AC 08.94- 04.02	CA1437IR# 14 85				
	[280A1.000]	03.89- 03.94 03.89- 03.94 03.89- 03.94 03.89- 03.94	CA129IR 14 55 CA316IR 14 55 CA355IR 14 65 CA642IR 14 55		03.89- 03.94	CS554	12 2.2
	[DHX (XUD9TF/L)]	04.98- 04.02 04.98- 04.98-	CA1086IR 14 80 CA1305IR 14 65 CA638IR 14 80		04.98- 04.98- 04.02	CS1177 CS594	12 1.7 12 1.4
Ducato 1.9 TD Panorama	[280A1.000]	03.89- 08.90 03.89- 03.94 03.89- 03.94 07.90- 03.94	CA129IR 14 55 CA316IR 14 55 CA355IR 14 65 CA642IR 14 55		03.89- 03.94	CS554	12 2.2
Ducato 2.0	[170B] [170D] [RFL]	07.85- 08.90 08.88- 03.94 04.02- 04.02- 04.02-	CA1501R 14 50 CA1501R 14 50 CA1086IR 14 80 CA825IR 14 95 CA836IR 14 120		07.85- 08.90 08.88- 03.94 04.02- 04.02-	CS352 CS352 CS566 CS715	12 0.85 12 0.85 12 1.1 12 1.4
	[RFW (XU10J2U)]	03.94- 04.02 03.94- 04.02 AC 03.94- 04.02 AC 03.94- 04.02	CA1086IR 14 80 CA825IR 14 95 CA825IR 14 95 CA836IR 14 120		03.94- 04.02 A13 03.94- 04.02	CS566 CS715	12 1.1 12 1.4
Ducato 2.0 4x4	[XN1T] [170D] [RFW (XU10J2U)]	01.82- 08.90 06.90- 05.94 06.98- 04.02	CA1501R 14 50 CA1501R 14 50 CA1086IR 14 80		01.82- 08.90 06.90- 05.94 A13 07.99- 04.02	CS352 CS352 CS715	12 0.85 12 0.85 12 1.4
		AC 06.98- 04.02 AC 06.98- 04.02	CA825IR 14 95 CA836IR 14 120		06.98- 04.02	CS566	12 1.1
Ducato 2.0 Panorama	[170B] [170D] [XN1T]	01.86- 08.90 09.88- 03.94 07.82- 05.85	CA1501R 14 50 CA1501R 14 50 CA1501R 14 50		01.86- 08.90 09.88- 03.94 07.82- 05.85	CS352 CS352 CS352	12 0.85 12 0.85 12 0.85
Ducato 2.0 BioPower Bipower	[RFL]	04.02- 04.02-	CA1086IR 14 80 CA836IR 14 120		04.02- 04.02-	CS715 CS566	12 1.4 12 1.1
Ducato 2.0 JTD	[RHV (DW10UTD)]	10.01- 05.04 05.04- AC 10.01- 05.04 AC 10.01- 05.04 AC 04.02- 05.04 AC 05.04-	CA1564IR 14 90 CA1879IR 14 90 CA1553IR 14 150 CA1646IR 14 120 CA1509IR 14 150 CA1761IR 14 150		04.02- 10.01- 04.02 04.02-	CS1177 CS594 CS570	12 1.7 12 1.4 12 3.1
Ducato 2.0 Multijet 115	[250A1.000]	06.11- 06.11-	CA2049IR* 14 100 CA2050IR* 14 120				
Ducato 2.2 JTD Multijet	[4HV]	07.06-	CA1928IR 14 150		07.06-	CS1421	12 2.0
Ducato 2.3 JTD	[F1AE0481C]	04.02- 04.02-	CA1700IR 14 110 CA1837IR 14 140		04.02- 01.05-	CS1198 CS1389	12 2.3 12 2.5
Ducato 2.3 JTD Multijet	[F1AE0481D]	07.06- 07.06- 07.06-	CA1700IR 14 110 CA1837IR 14 140 CA2090IR* 14 180	M38 Transmission type	07.06-	CS1434 CS1449	12 2.3 DR 12 2.5 BO
Ducato 2.3 Multijet	[F1AE0481D]	03.06- 03.06- 03.10-	CA1700IR 14 110 CA1837IR 14 140 CA2090IR* 14 180	M38 Transmission type	03.06-	CS1449	12 2.5
	[F1AE0481N]	01.07- 01.07- 01.07-	CA1700IR 14 110 CA1837IR 14 140 CA2090IR* 14 180	M38 Transmission type	01.07-	CS1434 CS1449	12 2.3 DR 12 2.5 BO
	[F1AE3481D]	01.07-	CA2090IR* 14 180				
Ducato 2.3 Multijet 150	[F1AE3481E]	06.11-	CA2090IR* 14 180				
Ducato 2.4 Diesel	[8144.61]	01.82- 12.85 01.82- 12.85 01.82- 12.85	CA255IR 14 45 CA316IR 14 55 CA355IR 14 65		01.82- 12.85	CS289	12 2.0
Ducato 2.4 Diesel 4x4	[8140.61]	09.86- 10.87 09.86- 10.87 09.86- 10.87	CA255IR 14 45 CA316IR 14 55 CA355IR 14 65		09.86- 10.87	CS289	12 2.0
	[8144.61]	09.86- 05.90 09.86- 05.90 09.86- 05.90	CA255IR 14 45 CA316IR 14 55 CA355IR 14 65		09.86- 05.90	CS289	12 2.0
Ducato 2.4 Diesel Panorama	[8144.61]	07.82- 12.85 07.82- 12.85 07.82- 12.85	CA255IR 14 45 CA316IR 14 55 CA355IR 14 65		07.82- 12.85	CS289	12 2.0
Ducato 2.5 Diesel	[8140.67]	03.94- 04.02 12.99- 04.02 Eng. 2976898- 12.99- 04.02 AC, Eng. 2976898- 12.99- 04.02 AC 03.94- 04.02	CA1039IR 14 80 CA1835IR 14 120 CA1835IR 14 120 CA1835IR 14 120 CA1157IR 14 110		03.94- 04.02 04.99- 04.02	CS973 CS1109	12 2.2 12 2.6



**FIAT Continued**

	[8144.67]		01.86- 08.90 CA255IR 14 45	01.86- 03.94 CS289 12 2.0
			01.86- 03.94 CA316IR 14 55	06.90- 08.90 CS510 12 2.2
			01.86- 03.94 CA355IR 14 65	
	[CRD93L]		01.82- 08.90 CA316IR 14 55	01.82- 08.90 CS289 12 2.0
			01.82- 08.90 CA355IR 14 65	01.82- 08.90 CS510 12 2.2
Ducato 2.5 Diesel 4x4	[8140.67]	Eng. 2976898- 12.99- 04.02 CA1835IR 14 120		03.94- 04.02 CS1109 12 2.6
		Eng. -2976897 03.94- 04.02 CA1039IR 14 80		Chas. -5546596 03.94- 04.02 CS973 12 2.2
		Eng. -2976897 03.94- 04.02 CA1157IR 14 110		
	[8144.67]		03.89- 08.90 CA316IR 14 55	06.90- 03.94 CS510 12 2.2
			03.89- 08.90 CA355IR 14 65	03.89- 03.94 CS289 12 2.0
			03.89- 03.94 CA642IR 14 55	
Ducato 2.5 Diesel Panorama	[8144.67]		01.86- 03.94 CA316IR 14 55	01.86- 03.94 CS289 12 2.0
			01.86- 03.94 CA355IR 14 65	
	[CRD93L]		01.86- 08.90 CA316IR 14 55	01.86- 06.90 CS289 12 2.0
Ducato 2.5 Diesel Panorama 4x4	[8144.67]		01.87- 03.94 CA316IR 14 55	01.87- 03.94 CS289 12 2.0
			01.87- 03.94 CA355IR 14 65	
Ducato 2.5 TD	[8140.27]		07.90- 03.94 CA316IR 14 55	07.90- 03.94 CS510 12 2.2
			07.90- 03.94 CA355IR 14 65	
	[8144.21]		01.86- 08.90 CA255IR 14 45	01.86- 08.90 CS510 12 2.2
			01.86- 08.90 CA316IR 14 55	
			01.86- 08.90 CA355IR 14 65	
Ducato 2.5 TD 4x4	[8140.27]		07.90- 03.94 CA316IR 14 55	07.90- 03.94 CS510 12 2.2
			07.90- 03.94 CA355IR 14 65	
			07.90- 03.94 CA642IR 14 55	
Ducato 2.5 TD Panorama	[8140.27]		08.90- 03.94 CA316IR 14 55	08.90- 03.94 CS510 12 2.2
			08.90- 03.94 CA355IR 14 65	
	[8144.21]		01.87- 08.90 CA316IR 14 55	01.87- 08.90 CS510 12 2.2
			01.87- 08.90 CA355IR 14 65	
Ducato 2.5 TD Panorama 4x4	[8140.27]		01.91- 03.94 CA316IR 14 55	01.91- 03.94 CS510 12 2.2
			01.91- 03.94 CA355IR 14 65	
	[8144.21]		01.86- 08.90 CA316IR 14 55	01.86- 08.90 CS510 12 2.2
			01.86- 08.90 CA355IR 14 65	
Ducato 2.5 TDi	[8140.47]		03.94- 04.02 CA1039IR 14 80	04.99- 04.02 CS1109 12 2.6
			12.99- 04.02 CA1835IR 14 120	03.94- 03.00 CS973 12 2.2
		Eng. 2976898- 12.99- 04.02 CA1835IR 14 120		03.00- 04.02 CS1198 12 2.3
		AC 03.94- 04.02 CA1157IR 14 110		
	[8140.47R]		03.94- 04.02 CA1039IR 14 80	03.94- 04.02 CS973 12 2.2
		Eng. 2976898- 12.99- 04.02 CA1835IR 14 120		03.00- 04.02 CS1109 12 2.6
		Eng. -2976897 03.94- 04.02 CA1039IR 14 80		
		Eng. -2976897 03.94- 04.02 CA1157IR 14 110		
		AC, Eng. 2976898- 12.99- 04.02 CA1835IR 14 120		
		AC 03.94- 04.02 CA1157IR 14 110		
Ducato 2.5 TDi 4x4	[8140.47]	Eng. 2976898- 12.99- 04.02 CA1835IR 14 120	Chas. 5546597- 03.94- 04.02 CS1109 12 2.6	
		Eng. -2976897 03.94- 04.02 CA1039IR 14 80	Chas. -5546596 03.94- 04.02 CS973 12 2.2	
		Eng. -2976897 03.94- 04.02 CA1157IR 14 110		
Ducato 2.5 TDi Maxi	[8140.47]	Eng. 2976898- 12.99- 04.02 CA1835IR 14 120	Chas. -5546596 03.94- 04.02 CS973 12 2.2	
		Eng. -2976897 03.94- 04.02 CA1039IR 14 80		
		Eng. -2976897 03.94- 04.02 CA1157IR 14 110		
Ducato 2.8 Diesel	[8140.63]	Eng. 2976898- 12.99- 04.02 CA1835IR 14 120	02.98- 04.02 CS1198 12 2.3	
		Eng. -2976897 02.98- 04.02 CA1039IR 14 80	02.98- 04.02 CS1109 12 2.6	
		Eng. -2976897 02.98- 04.02 CA1157IR 14 110		
Ducato 2.8 Diesel 4x4	[8140.63]		08.98- CA1039IR 14 80	08.98- CS1198 12 2.3
			08.98- CA1157IR 14 110	
Ducato 2.8 JTD	[8140.43N]		05.04- CA1643IR 14 120	05.04- CS1198 12 2.3
			05.04- CA1781IR 14 90	
		AT 05.04- CA2037IR 14 150		
	[8140.43S]		11.00- 04.02 CA1643IR 14 120	01.05- CS1389 12 2.5
			11.00- 04.02 CA1781IR 14 90	11.00- 04.02 CS1198 12 2.3
			11.00- 04.02 CA2037IR 14 150	
Ducato 2.8 JTD 4x4	[8140.43S]		11.00- 04.02 CA1643IR 14 120	01.05- CS1389 12 2.5
			11.00- 04.02 CA1781IR 14 90	11.00- 04.02 CS1198 12 2.3
			11.00- 04.02 CA2037IR 14 150	
Ducato 2.8 TDi	[8140.43]		10.97- 04.02 CA1039IR 14 80	10.97- 04.02 CS1109 12 2.6
			10.97- 12.99 CA1157IR 14 110	10.97- 03.00 CS973 12 2.2
			12.99- 04.02 CA1835IR 14 120	10.97- 04.02 CS1198 12 2.3
		Eng. 2976898- 12.99- 04.02 CA1835IR 14 120		
		Eng. -2976897 10.97- 04.02 CA1039IR 14 80		
		Eng. -2976897 10.97- 04.02 CA1157IR 14 110		
Ducato 2.8 TDi 4x4	[8140.43]		07.99- CA1039IR 14 80	07.99- 04.02 CS1198 12 2.3
			07.99- CA1157IR 14 110	07.99- CS1109 12 2.6
		Eng. 2976898- 06.99- 04.02 CA1835IR 14 120		
		Eng. -2976897 10.97- 04.02 CA1039IR 14 80		
		Eng. -2976897 10.97- 04.02 CA1157IR 14 110		
Ducato 3.0 140 Natural Power M90	[F1CE0441A]		04.09- CA1913IR 14 140	04.09- CS1449 12 2.5
			04.09- CA1915IR 14 110	
			04.09- CA2089IR* 14 180	
Ducato 3.0 Diesel 140 Natural Power	[F1CE0441A]		04.09- CA1913IR 14 140	04.09- CS1449 12 2.5
			04.09- CA1915IR 14 110	
			04.09- CA2089IR* 14 180	
Ducato 3.0 JTD 160 Multijet Power	[F1CE0481D]		07.06- CA1913IR 14 140	07.06- CS1449 12 2.5
			07.06- CA1915IR 14 110	
			07.06- CA2089IR* 14 180	
Ducato 3.0 JTD Multijet Power	[F1CE0481D]		07.06- CA1913IR 14 140	07.06- CS1449 12 2.5
			07.06- CA1915IR 14 110	
			07.06- CA2089IR* 14 180	
Ducato 3.0 Multijet	[F1CE3481E]		06.11- CA2089IR* 14 180	06.11- CS1449 12 2.5
Ducato 3.0 Multijet 150	[F1CE3481N]		04.10- CA1913IR 14 140	04.10- CS1449 12 2.5
			04.10- CA2089IR* 14 180	
Duna 1.1	[146A4.048]		07.91- 07.96 CA252IR 14 55	07.91- 07.96 CS368 12 0.9
			07.91- 07.96 CA909IR 14 45	07.91- 07.96 CS396 12 0.8
	[146A6.000]		10.86- 12.91 CA909IR 14 45	01.87- 12.91 CS368 12 0.9
			01.87- 12.91 CA252IR 14 55	10.86- 12.91 CS396 12 0.8
Duna 1.3	[146A5.000]		01.87- 12.91 CA909IR 14 45	01.87- 12.91 CS396 12 0.8
Duna 1.7 Diesel DS	[149B3.000]		01.87- 12.91 CA129IR 14 55	01.87- 12.91 CS374 12 1.7
Elba 1.3			04.86- 12.93 CA909IR 14 45	04.86- 12.93 CS396 12 0.8
			04.86- 12.93 CA252IR 14 55	
Elba 1.5	[149C3.000]		01.92- 12.96 CA254IR 14 65	01.92- 12.96 CS285 12 0.8
			01.92- 12.96 CA645IR 14 100	
			01.92- 12.96 CA254IR 14 65	04.86- 12.96 CS285 12 0.8
			01.92- 12.96 CA645IR 14 100	
Elba 1.6	[159A3.000]		04.89- 12.93 CA596IR 14 65	04.89- 12.93 CS285 12 0.8
			01.94- 12.96 CA596IR 14 65	01.94- 12.96 CS285 12 0.8
Elba 1.7 Diesel	[146B2.000]		04.89- 12.96 CA1435IR 14 55	04.89- 12.96 CS1059 12 1.7
Fiorino 0.9	[100GL.000]		10.77- 03.81 CA307IR 14 45	10.77- 03.81 CS90 12 0.8



Fiorino 1.0	[127A.000]	01.80- 12.87	CA1271R	14 45	01.80- 12.87	CS396	12 0.8
		01.80- 12.87	CA2521R	14 55	10.82- 10.87	CS147	12 0.8
		Eng. 1366252-	CA2521R	14 55			
	[156A.000]				12.86- 04.88	CS371	12 0.9
Fiorino 1.05	[127A.000]	01.80- 12.87	CA1271R	14 45	01.80- 12.87	CS396	12 0.8
		01.80- 12.87	CA771R	14 33			
Fiorino 1.1	[146A9.000]	Eng. 3319637-	CA2521R	14 55	11.86- 12.93	CS396	12 0.8
		Eng. -3319636	CA9091R	14 45			
Fiorino 1.3	[146A5.000]	09.93- 12.01	CA2521R	14 55	12.87- 06.95	CS396	12 0.8
		Eng. 3319637-	CA2521R	14 55			
		Eng. -3319636	CA9091R	14 45			
		Chas. 3319637-	CA2521R	14 55			
		Chas. -3319636	CA9091R	14 45			
		01.07-	CA14991R	14 80	01.07-	CS581	12 1.0
		01.07-	CA15891R	14 90	01.07-	CS390	12 0.9
	[127A5.000]				03.82- 12.88	CS368	12 0.9
Fiorino 1.3 Multijet	[199A2.000]	02.08-	CA1861R	14 75	02.08-	CS1346	12 1.3
		AC 02.08-	CA18621R	14 90			
		01.07-	CA18621R	14 90	01.07-	CS1346	12 1.3
			CA1861R	14 75			
Fiorino 1.3 Multijet QUBO	[199A2.000]	09.08-	CA1861R	14 75	09.08-	CS1346	12 1.3
		AC 09.08-	CA18621R	14 90			
Fiorino 1.4	[146C5.000] [146D5.000] [KFV]	09.93- 06.95	CA5961R	14 65	09.93- 06.95	CS285	12 0.8
		06.95- 12.01	CA5961R	14 65	06.95- 12.01	CS285	12 0.8
		02.08-	CA14991R	14 80	02.08-	CS390	12 0.9
					02.08-	CS581	12 1.0
Fiorino 1.4 QUBO	[KFV]	09.08-	CA14991R	14 80	09.08-	CS390	12 0.9
					09.08-	CS581	12 1.0
Fiorino 1.4 Natural Power		01.10-	CA17661R	14 75	01.10-	CS1379	12 0.8
Fiorino 1.5	[149C1.000]	01.88- 08.93	CA2521R	14 55	01.88- 08.93	CS285	12 0.8
		01.88- 08.93	CA2541R	14 65			
Fiorino 1.5 i.e.	[149C1.000]	05.88- 12.93	CA2521R	14 55	05.88- 12.93	CS285	12 0.8
		05.88- 12.93	CA2541R	14 65			
Fiorino 1.6	[146C6.000] [146D6.000]	10.93- 05.01	CA5961R	14 65	10.93- 12.96	CS285	12 0.8
					12.96- 05.01	CS975	12 0.9
		01.94- 12.01	CA5961R	14 65	01.94- 12.01	CS285	12 0.8
					12.96- 05.01	CS975	12 0.9
Fiorino 1.7 Diesel	[146B2.000] [149B2.000] [149B3.000]	05.88- 12.97	CA14351R	14 55	05.88- 12.97	CS374	12 1.7
					11.91- 10.96	CS1059	12 1.7
					05.88- 10.91	CS286	12 1.6
					11.91- 10.91	CS1059	12 1.7
					01.88- 10.91	CS286	12 1.6
			01.88- 10.91	CS374	12 1.7		
			12.87- 05.00	CA14351R	14 55		
					12.87- 10.91	CS286	12 1.6
					11.91- 05.00	CS1059	12 1.7
					12.87- 10.91	CS374	12 1.7
Fiorino 1.7 TD	[146D7.000]	01.97- 12.98	CA11991R	14 100	06.99- 12.01	CS1037	12 1.7
		01.97- 12.01	CA1291R	14 55	01.97- 12.01	CS1059	12 1.7
		01.97- 12.01	CA14351R	14 55 ▲			
Grande Punto 1.2	[169A4.000] [199A4.000]	09.10-	CA18861R	14 70	09.10-	CS1379	12 0.8
		10.05-	CA18861R	14 70	10.05-	CS1379	12 0.8
		AC 10.05-	CA20961R*	14 105			
		AC 10.05-	CA17661R	14 75			
		AC 10.05-	CA19981R	14 105			
Grande Punto 1.2 Multijet	[199A2.000]	AC 04.08-	CA18561R	14 75	04.08-	CS1346	12 1.3
Grande Punto 1.3 Diesel Multijet	[199A2.000] [199A3.000]	10.05-	CA18561R	14 75	10.05-	CS1346	12 1.3
		AC 10.05-	CA18551R	14 75			
		AC 10.05-	CA18621R	14 90			
		AC 10.05-	CA19341R	14 105			
		10.05-	CA18561R	14 75	10.05-	CS1346	12 1.3
		AC 10.05-	CA18551R	14 75			
		AC 10.05-	CA18621R	14 90			
		AC 10.05-	CA19341R	14 105			
Grande Punto 1.4	[199A7.000] [350A1.000]	06.06-	CA17661R	14 75	06.06-	CS1379	12 0.8
		06.06-	CA20961R*	14 105			
		10.05-	CA18861R	14 70	10.05-	CS1379	12 0.8
		10.05-	CA20961R*	14 105			
		AC 10.05-	CA17661R	14 75			
		AC 10.05-	CA19981R	14 105			
		A42 10.05-	CA17661R	14 75			
Grande Punto 1.4 Abarth	[199A8.000]	12.07-	CA19691R	14 120	12.07-	CS1379	12 0.8
Grande Punto 1.4 16V	[199A6.000] [955A6.000]	10.05-	CA17661R	14 75	10.05-	CS1379	12 0.8
		10.05-	CA18861R	14 70			
		10.05-	CA20961R*	14 105			
		A13 10.05-	CA19981R	14 105			
				10.09-	CS1379	12 0.8	
Grande Punto 1.4 T-Jet	[198A4.000]	09.07-	CA18861R	14 70	09.07-	CS1379	12 0.8
		09.07-	CA19691R	14 120			
		09.07-	CA20961R*	14 105			
Grande Punto 1.4 Natural Power	[350A1.000]	07.08-	CA17661R	14 75			
		07.08-	CA18861R	14 70			
		07.08-	CA20961R*	14 105			
Grande Punto 1.4 LPG	[350A1.000]	12.08-	CA18861R	14 70	12.08-	CS1379	12 0.8
		A39 12.08-	CA17661R	14 75			
Grande Punto 1.4 LPG	[350A1.000]	03.09-	CA18861R	14 70	03.09-	CS1379	12 0.8
		03.09-	CA20961R*	14 105			
		A42 03.09-	CA17661R	14 75			
Grande Punto 1.6 Multijet	[955A3.000]	07.08-	CA19951R	14 140	07.08-	CS1264	12 1.7
		07.08-	CA20491R*	14 100			
		07.08-	CA20501R*	14 120			
Grande Punto 1.9 Diesel Multijet	[199A5.000] [939A1.000]	10.05-	CA18851R	14 120	10.05-	CS1264	12 1.7
					10.05-	CS1045	12 2.0
Grande Punto 1.9 Multijet	[939A7.000]	06.06-	CA18841R	14 105	06.06-	CS1264	12 1.7
		06.06-	CA20491R*	14 100			
Idea 1.2 16V	[188A5.000]	01.04-	CA18431R	14 60	01.04-	CS1379	12 0.8
		AC 01.04-	CA17421R	14 85			
Idea 1.3 Diesel Multijet	[199A3.000]	10.05-	CA18561R	14 75	10.05-	CS1346	12 1.3
		AC 10.05-	CA18621R	14 90			
		AC 10.05-	CA19341R	14 105			
Idea 1.3 JTD	[188A9.000]	01.04-	CA18561R	14 75	01.04-	CS1346	12 1.3
		AC 01.04-	CA18621R	14 90			
		AC 01.04-	CA19341R	14 105			



**FIAT Continued**

Idea 1.4	[192B2.000]	12.03-	CA1742IR	14 85	12.03-	CS1379	12 0.8				
		12.03-	CA1766IR	14 75							
		12.03-	CA1886IR	14 70							
	[350A1.000]	10.05-	CA1886IR	14 70	10.05-	CS1379	12 0.8				
		AC 10.05-	CA1766IR	14 75							
Idea 1.4 16V	[843A1.000]	01.04-	CA1886IR	14 70	01.04-	CS1379	12 0.8				
		AC 01.04-	CA1742IR	14 85							
Idea 1.4 LPG	[350A1.000]	03.09-	CA1886IR	14 70	03.09-	CS1379	12 0.8				
		A39 03.09-	CA1766IR	14 75							
Idea 1.6 Multijet	[350A2.000]	05.08-	CA2049IR*	14 100	05.08-	CS1264	12 1.7				
Idea 1.9 JTD	[188B2.000]	01.04-	CA1558IR	14 100	01.04-	CS1264	12 1.7				
		01.04-	CA1698IR	14 120							
		01.04-	CA2048IR	14 90							
Linea 1.3 Multijet	[199A3.000]	06.07-	CA1856IR	14 75	06.07-	CS1346	12 1.3				
		AC 06.07-	CA1862IR	14 90							
		AC 06.07-	CA1934IR	14 105							
Linea 1.4	[350A1.000]	06.07-	CA1886IR	14 70	06.07-	CS1379	12 0.8				
		06.07-	CA2094IR*	14 90							
		AC 06.07-	CA1742IR	14 85							
		AC 06.07-	CA1998IR	14 105							
		A13 06.07-	CA2096IR*	14 105							
Linea 1.4 T-Jet	[198A4.000]	09.07-	CA1969IR	14 120	09.07-	CS1379	12 0.8				
Linea 1.6 Multijet	[198A3.000]	06.09-	CA2049IR*	14 100	06.09-	CS1264	12 1.7				
		06.09-	CA2050IR*	14 120							
		A13 06.09-	CA1995IR	14 140							
Marea 1.2 16V	[182B2.000]	10.98-	CA1349IR	14 65	10.98-	CS796	12 0.8				
		AC 10.98-	CA1350IR	14 85							
Marea 1.4 i 16V	[182A3.000]	09.96-	CA1160IR	14 65	09.96-	CS981	12 0.9				
		AC 09.96-	CA1159IR	14 85							
Marea 1.6	[182B6.000]	09.00- 08.02	CA1471IR	14 90	09.00- 08.02	CS975	12 0.9				
		09.00- 08.02	CA1485IR	14 80							
		09.00- 08.02	CA1648IR	14 105							
Marea 1.6 16V Bipower	[185A3.000]	04.99- 09.02	CA1485IR	14 80	03.99- 10.99	CS975	12 0.9				
		04.99- 09.02	CA1648IR	14 105							
		AC 04.99- 09.02	CA1471IR	14 90							
		04.99- 03.02	CA1485IR	14 80							
		AC 04.99- 03.02	CA1471IR	14 90							
Marea 1.6 16V	[185A3.000]	04.97- 02.99	CA1220IR	14 75	04.97- 02.99	CS1191	12 1.4				
		04.97- 02.99	CA1221IR	14 85							
Marea 1.6 i 16V	[182A4.000]	09.96- 02.99	CA1220IR	14 75	AT 09.96-	CS1043	12 0.9				
		03.99-	CA1471IR	14 90							
		03.99-	CA1485IR	14 80							
		03.99-	CA1648IR	14 105							
		AC 09.96- 02.99	CA1221IR	14 85							
		AC 03.99-	CA1471IR	14 90							
Marea 1.8 i 16V	[182A2.000]	09.96-	CA1190IR	14 75	09.96-	CS1042	12 1.4				
		ACPS 09.96-	CA1216IR	14 85							
		AC 09.96-	CA1189IR	14 100							
Marea 1.9 JTD	[182B4.000]	04.99- 01.01	CA1223IR	14 100	04.99- 01.01	CS1124	12 2.2				
		04.99- 01.01	CA1558IR	14 100							
		01.01-	CA1223IR	14 100							
		AC 01.01-	CA1558IR	14 100							
	[186A6.000]	AC 01.01-	CA1698IR	14 120	01.01-	CS1045	12 2.0				
Marea 1.9 TD	[182A7.000]	09.96-	CA1190IR	14 75	09.96-	CS1124	12 2.2				
		AC 09.96-	CA1189IR	14 100							
		AC 09.96-	CA1216IR	14 85							
		09.96-	CA1190IR	14 75							
	[182A8.000]	AC 09.96-	CA1189IR	14 100	09.96-	CS1045	12 2.2				
		AC 09.96-	CA1216IR	14 85							
Marea 1.9 TDi	[182A7.000]	09.96-	CA1190IR	14 75	09.96-	CS1045	12 2.0				
		AC 09.96-	CA1189IR	14 100							
		AC 09.96-	CA1216IR	14 85							
Marea 2.0 20V	[182A1.000]	09.96- 04.99	CA1222IR	14 85	09.96- 04.99	CS1042	12 1.4				
		AC 09.96- 04.99	CA1218IR	14 85							
		[182B7.000]	04.99- 09.02	CA1222IR				14 85	04.99- 09.02	CS1053	12 1.1
									04.99- 09.02	CS1042	12 1.4
	[185A8.000]	01.01-	CA1222IR	14 85	01.01-	CS1053	12 1.1				
Marea 2.0 i 20V	[182A1.000]	09.96- 04.99	CA1222IR	14 85	09.96- 04.99	CS1053	12 1.1				
		AC 09.96- 04.99	CA1218IR	14 85							
		[182B7.000]	04.99- 09.02	CA1222IR				14 85	04.99- 09.02	CS1042	12 1.4
									04.99- 09.02	CS1053	12 1.1
Marea 2.4 JTD	[185A6.000]	04.99-	CA1216IR	14 85	04.99-	CS1124	12 2.2				
		AC 04.99-	CA1452IR	14 120							
		[839A5.000]	04.99-	CA1216IR				14 85	04.99-	CS1124	12 2.2
		AC 04.99-	CA1452IR	14 120							
Marea 2.4 TD	[185A2.000]	09.96- 04.99	CA1159IR	14 85	09.96- 04.99	CS1124	12 2.2				
		AC 09.96- 04.99	CA1223IR	14 100							
Marengo 1.9 Diesel	[160A7.000]	02.90- 12.96	CA644IR	14 90	02.90- 12.96	CS376	12 2.2				
									10.91- 12.96	CS709	12 2.2
Marengo 1.9 JTD	[182B4.000]	03.99- 09.02	CA1216IR	14 85	03.99- 09.02	CS1045	12 2.0				
		[186A6.000]	08.00- 09.02	CA1558IR				14 100			
			AC 08.00- 09.02	CA1698IR				14 120			
Marengo 1.9 TD	[160A6.000]	02.90- 12.96	CA644IR	14 90	02.90- 12.96	CS709	12 2.2				
		[182A7.000]	01.97- 02.99	CA1190IR				14 75			
			AC 01.97- 02.99	CA1216IR				14 85			
		[182A8.000]	03.99- 09.02	CA1190IR				14 75	03.99- 09.02	CS1045	12 2.0
Multipla 1.6 16V Bipower	[186A4.000]	04.99-	CA1471IR	14 90	04.99-	CS1213	12 1.1				
		04.99-	CA1485IR	14 80							
		04.99-	CA1648IR	14 105							
		AC 04.99-	CA1471IR	14 90							
Multipla 1.6 16V	[182A4.000]	04.99-	CA1471IR	14 90	04.99-	CS1213	12 1.1				
		04.99-	CA1485IR	14 80							
		04.99-	CA1648IR	14 105							
		AC 04.99-	CA1471IR	14 90							
Multipla 1.6 16V Bipower	[182B6.000]	10.01-	CA1471IR	14 90	10.01-	CS1213	12 1.1				
		10.01-	CA1485IR	14 80							
		10.01-	CA1648IR	14 105							
		AC 10.01-	CA1471IR	14 90							
Multipla 1.6 16V Blupower	[182B6.000]	04.02- 12.10	CA1485IR	14 80	04.02- 12.10	CS1213	12 1.1				
		AC 04.02- 12.10	CA1471IR	14 90							





	[186A3.000]	04.99- 04.99- 04.99- AC 04.99-	CA1471IR CA1485IR CA1648IR CA1471IR	14 90 14 80 14 105 14 90	04.99- 04.99-	CS1213 CS1191	12 1.1 12 1.4
Multipla 1.9 JTD	[182B4.000]	04.99- 04.99- 04.99- AC 04.99-	CA1223IR CA1558IR CA1697IR CA1558IR	14 100 14 100 14 90 14 100	04.99-	CS1045	12 2.0
	[186A6.000]	03.01- AC 03.01- AC 03.01-	CA1223IR CA1558IR CA1698IR	14 100 14 100 14 120	03.01-	CS1045	12 2.0
	[186A8.000]	AC 07.02-	CA1558IR	14 100	07.02-	CS1045	12 2.0
	[186A9.000]	04.02- AC 04.02-	CA1697IR CA1558IR	14 90 14 100	04.02-	CS1264	12 1.7
Palio 1.0	[178A1.000]	AC 04.96-	CA1199IR	14 100	04.96-	CS1125	12 0.8
Palio 1.2	[178B5.000]	04.96- 02.01 09.97- 09.01 09.97- 09.01 PS 09.97- 09.01 ACPS 09.97- 09.01	CA2060IR* CA1844IR CA890IR CA1153IR CA1154IR	14 75 14 70 14 65 14 65 14 75	09.97- 10.99 11.99- 09.01	CS1125 CS1192	12 0.8 12 0.8
	[178E2.000]	01.97- 12.02 PS 01.97- 12.02 ACPS 01.97- 12.02	CA890IR CA1153IR CA1154IR	14 65 14 65 14 75	01.97- 12.02	CS1125	12 0.8
	[188A4.000]	PS 02.01- 09.01 AC 02.01- 09.01	CA1153IR CA1154IR	14 65 14 75	02.01-	CS1192	12 0.8
Palio 1.4	[178B2.000]	04.96- PS 04.96-	CA1220IR CA1196IR	14 75 14 65	04.96- 05.99	CS975	12 0.9
	[178B2.016]	04.96- PS 04.96-	CA1220IR CA1196IR	14 75 14 65	04.96- 05.99	CS975	12 0.9
Palio 1.5	[178A5.011]	04.96- 06.98	CA1084IR	14 65			
Palio 1.6 16V	[178B3.000]	04.96- 09.01 04.96- 10.99 11.99- 09.01 AC 04.96- 10.99 AC 11.99- 09.01	CA1196IR CA1220IR CA1485IR CA1219IR CA1471IR	14 65 14 75 14 80 14 85 14 90	04.96- 09.01	CS975	12 0.9
	[182B6.000]	02.01- AC 02.01-	CA1485IR CA1471IR	14 80 14 90			
Palio 1.7 TD	[176A3.000]	04.96- 03.01 AC 04.96- 03.01 AC 04.96- 03.01	CA1084IR CA1161IR CA1199IR	14 65 14 85 14 100	04.96- 03.01	CS1037	12 1.7
Palio 1.9 Diesel	[223A6.000]	03.01- AC 03.01-	CA1696IR CA1697IR	14 65 14 90	03.01-	CS1212	12 1.8
Panda 0.7	[141AE]	03.80- 12.85	CA255IR	14 45			
Panda 0.7 650	[141A.000]	01.82- 12.85	CA255IR	14 45			
Panda 0.8	[141B.000]	01.86- 01.95	CA307IR	14 45	01.86- 01.95	CS90	12 0.8
	[156A4.000]	01.86- 12.92 01.95- 12.97	CA350IR CA572IR	14 45 14 55	01.86- 12.97	CS371	12 0.9
	[156A4.048]	01.95- 12.97	CA572IR	14 55	01.95- 12.97	CS371	12 0.9
	[M020BS..]	02.81- 12.85	CA307IR	14 45	02.81- 12.85	CS90	12 0.8
Panda 0.9	[100GL3.000]	09.82- 12.85	CA307IR	14 45	09.82- 12.85	CS90	12 0.8
	[1170A1.046]	04.92- 10.96 10.96- 09.03	CA307IR CA893IR	14 45 14 55	04.92- 09.03	CS1038	12 0.8
	[146A.000]	09.82- 12.85	CA307IR	14 45	09.82- 12.85	CS90	12 0.8
Panda 1.0	[156A.3000]	07.90- 12.92 07.90- 12.92	CA572IR CA851IR	14 55 14 65	09.86- 12.92	CS371	12 0.9
	[156A2.100]	01.86- 06.90 07.89- 04.92	CA350IR CA572IR	14 45 14 55	01.86- 04.92	CS371	12 0.9
	[156A3.100]	01.86- 02.92	CA350IR	14 45	01.86- 02.92	CS371	12 0.9
	[A112B1.054]	09.82- 08.83	CA307IR	14 45	09.82- 08.83	CS90	12 0.8
Panda 1.0 4x4	[156A2.100]	03.89- 06.90	CA350IR	14 45	01.86- 06.90	CS371	12 0.9
	[156A3.000]	01.86- 06.90 07.90- 12.92	CA350IR CA572IR	14 45 14 55	01.86- 12.92	CS371	12 0.9
	[156A3.100]	03.89- 06.90	CA350IR	14 45	01.86- 06.90	CS371	12 0.9
	[A112B1.054]	09.83- 12.85	CA307IR	14 45	09.83- 12.85	CS90	12 0.8
Panda 1.0 i.e.	[141C2.000]	01.95- 09.03 01.95- 09.03	CA572IR CA851IR	14 55 14 65	03.97- 09.03	CS1125	12 0.8
	[156A2.246]	07.90- 02.04 07.90- 02.04 07.90- 02.04	CA350IR CA572IR CA851IR	14 45 14 55 14 65	07.90- 02.04	CS371	12 0.9
Panda 1.0 i.e. 4x4	[141C2.000]	Eng. -6996084, 6996085- 09.03- 09.03- 09.03- 09.03-	CA851IR CA350IR CA572IR CA572IR CA851IR	14 65 14 45 14 55 14 55 14 65	01.95- 09.03 10.95- 09.03 05.86- 04.92	CS371 CS1125 CS371	12 0.9 12 0.8 12 0.9
	[156A2.246]	05.86- 06.90 07.90- 04.92	CA350IR CA572IR	14 45 14 55	05.86- 04.92	CS371	12 0.9
	[176B2.000]	02.95- 09.03 02.95- 09.03	CA572IR CA851IR	14 55 14 65	09.97- 09.03 02.95- 09.03	CS1125 CS371	12 0.8 12 0.9
Panda 1.1	[187A.1000]	Eng. -2533528 09.03- Eng. -2533528 09.03- Eng. 2533528- 09.03- AC 09.03-	CA1843IR CA1844IR CA1886IR CA1766IR	14 60 14 70 14 70 14 75	09.03-	CS1379	12 0.8
Panda 1.1 4x4 trekking	[156C.046]	10.91- 07.04 10.91- 07.04	CA572IR CA851IR	14 55 14 65	10.91- 09.97 09.97- 07.04	CS371 CS1125	12 0.9 12 0.8
Panda 1.1 Selecta	[156C.046]	03.92- 03.97 01.95- 09.03	CA572IR CA851IR	14 55 14 65	09.97- 09.03 03.92- 09.97	CS1125 CS371	12 0.8 12 0.9
	[176B2.000]	02.95- 09.03 02.95- 09.03	CA572IR CA851IR	14 55 14 65	AT 02.95- 09.03 09.97- 09.03	CS371 CS1125	12 0.9 12 0.8
	[187A1.000]	02.95- 09.03 02.95- 09.03	CA572IR CA851IR	14 55 14 65	09.97- 09.03 AT 02.95- 09.03	CS1125 CS371	12 0.8 12 0.9
Panda 1.2	[169A4.000]	02.12- 02.12-	CA2070IR* CA2096IR*	14 140 14 105	02.12-	CS1379	12 0.8
	[188A.4000]	Eng. -2533528 09.03- Eng. -2533528 09.03- Eng. 2533528- 09.03- AC 09.03- AC 09.03-	CA1843IR CA1844IR CA1886IR CA1742IR CA1766IR	14 60 14 70 14 70 14 85 14 75	09.03-	CS1379	12 0.8
	[188A4.000]	Eng. -2533528 09.04- Eng. -2533528 09.04- AC 09.04- AC 09.04-	CA1843IR CA1844IR CA1742IR CA1766IR	14 60 14 70 14 85 14 75	09.04-	CS1379	12 0.8
Panda 1.2 4x4	[188A4.000]	Eng. -2533528 10.04- Eng. -2533528 10.04- Eng. 2533528- 10.04- AC 10.04- AC 10.04-	CA1843IR CA1844IR CA1886IR CA1742IR CA1766IR	14 60 14 70 14 70 14 85 14 75	10.04-	CS1379	12 0.8



**FIAT Continued**

Panda 1.2 X	[188A4.000]	Eng. -2533528 09.04-	CA1843IR	14 60	09.04-	CS1379	12 0.8
		Eng. -2533528 09.04-	CA1844IR	14 70			
		AC 09.04-	CA1742IR	14 85			
		AC 09.04-	CA1766IR	14 75			
Panda 1.2 LPG	[188A4.000]	04.09-	CA1766IR	14 75	04.09-	CS1379	12 0.8
Panda 1.2 Bi-Power	[188A4.000]	01.07-	CA1742IR	14 85	01.07-	CS1379	12 0.8
		01.07-	CA1766IR	14 75			
		01.07-	CA1886IR	14 70			
Panda 1.2 Multijet	[169A1.000]	06.06-	CA1856IR	14 75			
		06.06-	CA1862IR	14 90			
Panda 1.3 Diesel	[156A5.000]				04.86- 12.92	CS364	12 1.1
Panda 1.3 JTD	[169A1.000]	06.06-	CA1856IR	14 75	06.06-	CS1334	12 1.1
		AC 06.06-	CA1862IR	14 90			
		09.03-	CA1856IR	14 75			
	[188A9.000]	AC 09.03-	CA1862IR	14 90	09.03-	CS1346	12 1.3
Panda 1.3 JTD 4x4	[188A9.000]	10.04-	CA1856IR	14 75	10.04-	CS1346	12 1.3
		AC 10.04-	CA1862IR	14 90			
Panda 1.3 Multijet 4x4	[169A1.000]	01.06-	CA1856IR	14 75	01.06-	CS1346	12 1.3
		AC 01.06-	CA1862IR	14 90			
Panda 1.4	[169A3.000]	10.06-	CA1766IR	14 75	10.06-	CS1379	12 0.8
Panda 1.4 BiFuel Natural Power		01.10-	CA1766IR	14 75			
Panda 1.4 Natural Power	[350A1.000]	10.09-	CA1766IR	14 75			
Penny Van 1.1	[146A6.000]	01.86- 12.90	CA252IR	14 55	01.86- 12.90	CS368	12 0.9
		01.86- 12.90	CA909IR	14 45			
Penny Van 1.3	[146A5.000]	01.86- 12.90	CA252IR	14 55	01.86- 12.90	CS396	12 0.8
		01.86- 12.90	CA909IR	14 45			
Penny Van 1.7 Diesel	[149B3.000]	01.86- 12.90	CA129IR	14 55	01.86- 12.90	CS374	12 1.7
Premio 1.3					03.85- 06.92	CS368	12 0.9
Punto 1.1	[176B2.000]	01.95- 08.99	CA890IR	14 65	01.95- 08.99	CS796	12 0.8
		PS 01.95- 08.99	CA1153IR	14 65			
		ACPS 01.95- 08.99	CA1154IR	14 75			
Punto 1.1 i.e.	[176A6.000]	09.93- 09.99	CA890IR	14 65	09.93- 09.99	CS796	12 0.8
		PS 09.93- 09.99	CA1153IR	14 65			
		ACPS 09.93- 09.99	CA1154IR	14 75			
	[176B2.000]	05.97- 09.99	CA890IR	14 65	05.97- 09.99	CS796	12 0.8
		PS 05.97- 09.99	CA1153IR	14 65			
		ACPS 05.97- 09.99	CA1154IR	14 75			
Punto 1.2	[176A7.000]	01.94-	CA890IR	14 65	01.94-	CS796	12 0.8
		PS 01.94-	CA1153IR	14 65			
		ACPS 01.94-	CA1154IR	14 75			
	[176A8.000]	10.93- 09.99	CA2063IR*	14 85	01.94- 09.99	CS796	12 0.8
		01.94- 09.99	CA890IR	14 65			
		PS 01.94- 09.99	CA1153IR	14 65			
		ACPS 01.94- 09.99	CA1154IR	14 75			
	[176B1.000]	05.95-	CA890IR	14 65	AT 03.94- 04.97	CS1076	12 0.8
		PS 03.94- 04.97	CA1153IR	14 65			
		ACPS 03.94- 04.97	CA1154IR	14 75			
	[176B4.000]	05.95- 09.99	CA890IR	14 65	AT 05.95- 09.99	CS1076	12 0.8
		PS 05.95- 09.99	CA1153IR	14 65			
		ACPS 05.95- 09.99	CA1154IR	14 75			
	[188A4.000]	10.01-	CA1843IR	14 60	07.99-	CS796	12 0.8
		04.02-	CA1844IR	14 70			
		09.99-	CA1998IR	14 105			
		09.99-	CA890IR	14 65			
		AC 09.99-	CA1742IR	14 85			
		AC 09.99-	CA1766IR	14 75			
Punto 1.2 16V	[176B9.000]	04.97- 09.99	CA2060IR*	14 75	04.97-	CS796	12 0.8
		PS 04.97-	CA1349IR	14 65			
		ACPS 04.97-	CA1350IR	14 85			
	[188A5.000]	09.99-	CA1647IR	14 60	Chas. 0093414-, 09.99- 0582637-, 2051205-, Chas. -0093414-, 09.99- 0582637-, 2051205, -	CS1192	12 0.8
		AC 09.99-	CA1742IR	14 85			
		AC 09.99-	CA1766IR	14 75			
		A13 09.99-	CA1830IR#	14 75			
Punto 1.2 Natural Power	[188A4.000]	09.03-	CA1844IR	14 70	09.03- 02.05	CS1192	12 0.8
		AC 09.03-	CA1742IR	14 85			
		AC 09.03-	CA1766IR	14 75			
Punto 1.3 JTD	[188A9.000]	06.03- 10.05	CA1856IR	14 75	06.03- 10.05	CS1346	12 1.3
		AC 06.03-	CA1855IR	14 75			
		AC 06.03- 10.05	CA1862IR	14 90			
		AC 06.03- 10.05	CA1934IR	14 105			
Punto 1.4	[843A1.000]	AC 09.03-	CA1766IR	14 75	09.03-	CS1379	12 0.8
		AC 09.03-	CA1998IR	14 105			
Punto 1.4 Turbo GT	[176A4.000]	AC 01.94-	CA712IR	14 90	01.94- 03.95	CS883	12 0.9
		AC 09.96-	CA712IR	14 90			
	[176B6.000]	AC 09.96-	CA712IR	14 90	09.96-	CS975	12 0.9
Punto 1.6	[176A9.000]	01.94- 04.97	CA1196IR	14 65	01.94- 04.97	CS800	12 0.9
		AC 01.94- 04.97	CA1219IR	14 85			
Punto 1.7 Diesel	[176B3.000]	08.93- 08.99	CA1084IR	14 65	08.93- 08.99	CS1037	12 1.7
Punto 1.7 TD	[176A3.000]	01.94-	CA1084IR	14 65	01.94-	CS1037	12 1.7
		AC 01.94-	CA1199IR	14 100			
	[176A5.000]	01.94- 08.99	CA1084IR	14 65	01.94- 08.99	CS1037	12 1.7
		AC 01.94- 08.99	CA1199IR	14 100			
	[176B7.000]	09.96-	CA1084IR	14 65	09.96-	CS1037	12 1.7
		AC 09.96-	CA1199IR	14 100			
Punto 1.8 HGT	[183A1.000]	02.02-	CA1743IR	14 90	09.99-	CS1053	12 1.1
		09.99- 02.02	CA1223IR	14 100			
	[188A6.000]	02.02-	CA1743IR	14 90	09.99-	CS1053	12 1.1
		09.99- 02.02	CA1223IR	14 100			
Punto 1.9 Diesel	[188A3.000]	09.99-	CA1160IR	14 65	09.99-	CS1212	12 1.8
		09.99-	CA1697IR	14 90			
		09.99-	CA1698IR	14 120			
		AC 02.00-	CA1558IR	14 100			
		AC 02.00-	CA1697IR	14 90			
		AC 09.99-	CA1189IR	14 100			
Punto 1.9 JTD	[188A2.000]	09.99-	CA1223IR	14 100	09.99-	CS1045	12 2.0
		09.99-	CA1697IR	14 90			
		AC 09.99-	CA1558IR	14 100			
	[188A7.000]	06.01- 06.03	CA1558IR	14 100	Eng. -0413488 06.01- 06.03	CS1045	12 2.0
		10.01-	CA1697IR	14 90			
	[188B2.000]	06.03-	CA1558IR	14 100	06.03-	CS1264	12 1.7



Punto Evo 1.2	[199A.4000]	10.09-	CA1886IR	14 70	10.09-	CS1379	12 0.8	
		10.09-	CA2096IR*	14 105				
		AC 10.09-	CA1766IR	14 75				
		AC 10.09-	CA2070IR*	14 140				
		A13 10.09-	CA1742IR	14 85				
[199A4.000]		10.09-	CA1742IR	14 85	10.09-	CS1379	12 0.8	
		10.09-	CA1766IR	14 75				
		10.09-	CA1886IR	14 70				
		10.09-	CA2096IR*	14 105				
		AC 10.09-	CA2070IR*	14 140				
Punto Evo 1.3 Multijet	[199A2.000]	10.09-	CA1856IR	14 75	10.09-	CS1346	12 1.3	
		10.09-	CA1862IR	14 90				
		10.09-	CA1934IR	14 105				
	[199A2.000,199A9.000]		03.09-	CA1856IR	14 75	03.09-	CS1346	12 1.3
			03.09-	CA1862IR	14 90			
			03.09-	CA1934IR	14 105			
	[199A3.000]		10.09-	CA1862IR	14 90	10.09-	CS1346	12 1.3
	[199A9.000]		10.09-	CA1856IR	14 75			
			10.09-	CA1862IR	14 90			
	[199A9.000]		10.09-	CA1934IR	14 105			
10.09-			CA1862IR	14 90				
10.09-			CA1856IR	14 75				
Punto Evo 1.4	[199A7.000]	07.09-	CA1886IR	14 70	07.09-	CS1379	12 0.8	
		07.09-	CA2096IR*	14 105				
		03.09-	CA1886IR	14 70				
[350A1.000]		03.09-	CA2096IR*	14 105	03.09-	CS1379	12 0.8	
		03.09-	CA2096IR*	14 105				
Punto Evo 1.4 16V	[955A2.000]				10.09-	CS1379	12 0.8	
	[955A6.000]	AC 10.09-	CA1969IR	14 120	10.09-	CS1379	12 0.8	
Punto Evo 1.4 Natural Power	[350A1.000]	10.09-	CA1886IR	14 70				
		10.09-	CA2096IR*	14 105				
Punto Evo 1.4 LPG	[350A1.000]	06.09-	CA1886IR	14 70				
		06.09-	CA2096IR*	14 105				
Punto Evo 1.6 Multijet	[955A3.000]	10.09-	CA2049IR*	14 100				
		A25 10.09-	CA2050IR*	14 120				
Qubo 1.3 Multijet	[199B1.000]	07.10-	CA1935IR	14 120				
Qubo 1.4 Natural Power		01.10-	CA1766IR	14 75	01.10-	CS1379	12 0.8	
Regata 1.3	[138B2.000]	09.83- 07.86	CA252IR	14 55	09.83- 07.86	CS91	12 0.8	
		09.83- 07.86	CA254IR	14 65				
Regata 1.3 ES	[149A3.000]	09.83- 07.89	CA252IR	14 55	09.83- 07.89	CS91	12 0.8	
		09.83- 07.89	CA254IR	14 65				
	[149A7.000]		09.83- 07.89	CA252IR	14 55	09.83- 07.89	CS91	12 0.8
			09.83- 07.89	CA254IR	14 65			
Regata 1.5	[138B3.000]	09.83- 04.89	CA252IR	14 55	09.83- 04.85	CS285	12 0.8	
		09.83- 04.89	CA254IR	14 65				
	[138C2.048]		12.86- 07.89	CA254IR	14 65	12.86- 07.89	CS285	12 0.8
	[149A5.000]		05.85- 12.87	CA252IR	14 55			
			05.85- 12.87	CA254IR	14 65	05.85- 12.87	CS529	12 1.1
			05.85- 12.87	CA252IR	14 55			
Regata 1.5 Super	[138B3.000]	09.83- 04.85	CA252IR	14 55	09.83- 04.85	CS529	12 1.1	
		09.83- 04.85	CA254IR	14 65				
Regata 1.5 i.e.	[138B3.048]	04.85- 07.89	CA252IR	14 55	04.85- 07.89	CS285	12 0.8	
		04.85- 07.89	CA254IR	14 65				
	[138C2.048]		07.85- 04.87	CA252IR	14 55	07.85- 04.87	CS285	12 0.8
			07.85- 04.87	CA254IR	14 65			
	[138C3.048]		09.83- 03.85	CA252IR	14 55	09.83- 03.85	CS285	12 0.8
			09.83- 03.85	CA254IR	14 65			
	[149C1.000]		05.87- 06.90	CA252IR	14 55	05.87- 06.90	CS285	12 0.8
			05.87- 06.90	CA254IR	14 65			
	Regata 1.6	[149A.000]	10.83- 06.91	CA252IR	14 55	10.83- 06.91	CS285	12 0.8
			10.83- 06.91	CA254IR	14 65			
[149A2.000]			10.83- 05.86	CA129IR	14 55	12.84- 06.90	CS393	12 0.9
			06.86- 06.90	CA504IR	14 65			
			AC 10.83- 11.84	CA506IR	14 65	10.83- 11.84	CS275	12 1.0
[149A4.000]			12.84- 12.86	CA129IR	14 55			
		12.84- 06.90	CA504IR	14 65	12.84- 06.90	CS393	12 0.9	
		12.84- 06.90	CA504IR	14 65				
Regata 1.6 Super		AC 12.84- 05.86	CA504IR	14 65	10.83- 07.89	CS393	12 0.9	
Regata 1.6 i.e.	[149C2.000]	01.87- 07.89	CA129IR	14 55	01.87- 07.89	CS393	12 0.9	
	[149C3.000]	01.87- 12.90	CA504IR	14 65				
Regata 1.7 Diesel	[138B6.000]	09.83- 04.85	CA129IR	14 55	09.83- 04.85	CS286	12 1.6	
	[149B3.000]	01.84- 12.89	CA129IR	14 55				
					01.84- 12.89	CS374	12 1.7	
					01.84- 12.89	CS286	12 1.6	
Regata 1.9 Diesel	[149A1.000]	04.84- 07.89	CA129IR	14 55	04.84- 07.89	CS376	12 2.2	
		04.84- 07.89	CA506IR	14 65				
Regata 1.9 TD	[831D1.000]	05.86- 07.89	CA601IR	14 65	11.88- 07.89	CS709	12 2.2	
Ritmo 1.0	[127A6.000]	09.78- 09.82	CA127IR	14 45	09.78- 09.82	CS147	12 0.8	
		09.78- 09.82	CA252IR	14 55				
		10.82- 10.85	CA127IR	14 45				
Ritmo 1.1	[138B.000]	10.82- 10.85	CA127IR	14 45	10.82- 10.85	CS91	12 0.8	
		10.82- 10.85	CA252IR	14 55				
	[138B1.000]		10.82- 10.85	CA127IR	14 45	10.82- 10.85	CS91	12 0.8
			10.82- 10.85	CA252IR	14 55			
	[138C.1000]		10.82- 10.85	CA127IR	14 45	10.82- 10.85	CS91	12 0.8
		10.82- 10.85	CA252IR	14 55				
Ritmo 1.3	[146A4.048]	04.85- 12.87	CA252IR	14 55	04.85- 12.87	CS91	12 0.8	
	[138A1.000]	01.78- 09.82	CA127IR	14 45				
	[138A3.000]		01.81- 09.82	CA127IR				14 45
			01.81- 09.82	CA252IR				14 55
			01.81- 09.82	CA254IR				14 65
	[138B2.000]		01.83- 04.85	CA127IR				14 45
[149A3.000]		11.83- 08.85	CA252IR	14 55				
[149A7.000]		11.83- 08.85	CA252IR	14 55				
Ritmo 1.3 Bertone	[138A2.000]	10.85- 12.87	CA252IR	14 55	10.85- 12.87	CS91	12 0.8	
		09.85- 12.88	CA254IR	14 65				
Ritmo 1.5	[138A4.000]		01.81- 09.82	CA127IR	14 45	01.81- 09.82	CS285	12 0.8
			01.83- 12.87	CA127IR	14 45			
	[138B3.000]		01.83- 12.87	CA252IR	14 55	01.83- 12.87	CS285	12 0.8
			01.83- 12.87	CA254IR	14 65			
			01.83- 12.87	CA254IR	14 65			
	[138C2.048]		09.85- 12.88	CA127IR	14 45	09.85- 12.88	CS285	12 0.8
			09.85- 12.88	CA252IR	14 55			
			09.85- 12.88	CA254IR	14 65	01.78- 10.82	CS133	12 0.9
	[138C3.048]		01.78- 10.82	CA252IR	14 55			
	[149A5.000]		08.85- 05.87	CA252IR	14 55	08.85- 05.87	CS285	12 0.8
		08.85- 05.87	CA254IR	14 65				



FIAT Continued

	[149C1.000]	05.87- 12.88 CA1271R 14 45	05.87- 12.88 CA2521R 14 55	05.87- 12.88 CA2541R 14 65	05.87- 12.88 CS285 12 0.8	05.87- 12.88 CS91 12 0.8
Ritmo 1.5 Bertone	[138A4.000]	01.80- 07.89 CA1271R 14 45	01.80- 07.89 CA2521R 14 55	01.80- 07.89 CA2541R 14 65	01.80- 07.89 CS285 12 0.8	
	[138B3.000]	01.80- 07.89 CA1271R 14 45	01.80- 07.89 CA2521R 14 55	01.80- 07.89 CA2541R 14 65	01.80- 07.89 CS285 12 0.8	
Ritmo 1.5 i.e.	[138AR.000]	09.86- 12.87 CA1291R 14 55			05.87- 12.87 CS285 12 0.8	09.86- 12.87 CS275 12 1.0
	[138C2.048]	10.85- 10.87 CA1271R 14 45	10.85- 10.87 CA2521R 14 55	10.85- 10.87 CA2541R 14 65	10.85- 10.87 CS285 12 0.8	
	[149C1.000]	05.87- 12.88 CA1271R 14 45	05.87- 12.88 CA2521R 14 55	05.87- 12.88 CA2541R 14 65	05.87- 12.88 CS285 12 0.8	
Ritmo 1.6	[138AR.000]	01.83- 04.85 CA1291R 14 55	AC 01.83- 04.85 CA5061R 14 65		01.83- 04.85 CS275 12 1.0	
	[149A4.000]	AC 01.83- 12.87 CA5041R 14 65			01.83- 12.87 CS275 12 1.0	01.83- 12.87 CS393 12 0.9
Ritmo 1.6 Bertone	[138AR.000]	AC 10.85- 12.87 CA5041R 14 65			10.85- 12.87 CS285 12 0.8	
	[138AR.048]	AC 10.85- 12.87 CA5041R 14 65			10.85- 12.87 CS393 12 0.9	
Ritmo 1.6 Sport	[138AR.000]	05.81- 12.82 CA1291R 14 55			05.81- 12.82 CS275 12 1.0	
Ritmo 1.7 Diesel	[138A5.000]	10.79- 09.82 CA1291R 14 55			10.79- 09.82 CS286 12 1.6	
	[138B6.000]	10.82- 10.85 CA1291R 14 55			10.82- 10.85 CS286 12 1.6	
	[138C.000]	05.85- 12.87 CA1291R 14 55			05.85- 08.87 CS286 12 1.6	09.87- 12.87 CS374 12 1.7
	[149B3.000]	05.85- 12.87 CA1291R 14 55			09.87- 12.87 CS374 12 1.7	05.85- 08.87 CS286 12 1.6
Ritmo 1.9 TD	[831D1.000]	12.85- 12.87 CA6011R 14 65				
Ritmo 2.0 TC Abarth	[138AR1.000]	09.80- 09.88 CA1291R 14 55			09.80- 09.88 CS275 12 1.0	
	[138AR2.000]	04.83- 12.87 CA5061R 14 65			04.83- 12.87 CS275 12 1.0	
Scudo 1.6	[220A2.000]	02.96- CA15651R 14 75	AC 02.96- CA11991R 14 100		02.96- CS975 12 0.9	
Scudo 1.6 Diesel Multijet	[DV6UTED4]	01.07- CA17611R 14 150			01.07- CS1260 12 1.1	
Scudo 1.9 Diesel	[D9B]	02.96- 04.98 CA6371R 14 70	PS 02.96- 04.98 CA11551R 14 70	ACPS 02.96- 04.98 CA10431R 14 80	02.96- 04.98 CS594 12 1.4	
	[WJZ (DW8)]	04.98- CA14421R 14 70	04.98- CA14961R 14 80	04.98- CA15641R 14 90	04.98- CS1177 12 1.7	04.98- CS594 12 1.4
		04.98- CA19321R 14 60			04.98- CS712 12 2.2	
Scudo 1.9 Diesel Combinato	[WJZ (DW8)]	04.98- CA14421R 14 70	04.98- CA14961R 14 80	04.98- CA15641R 14 90	04.98- CS594 12 1.4	04.98- CS1177 12 1.7
		04.98- CA19321R 14 60				
Scudo 1.9 TD	[D8B]	02.96- CA6371R 14 70	PS 02.96- CA11551R 14 70	ACPS 02.96- CA10431R 14 80	02.96- CS594 12 1.4	
	[DHX (XUD9TF/L)]	02.96- CA6371R 14 70	PS 02.96- CA11551R 14 70	ACPS 02.96- CA10431R 14 80	02.96- CS594 12 1.4	
Scudo 1.9 TD Eco	[DHX (XUD9TF/L)]	02.95- CA6371R 14 70	PS 02.95- CA11551R 14 70	ACPS 02.95- CA10431R 14 80	02.95- CS594 12 1.4	
Scudo 2.0	[RFN]	05.00- CA16461R 14 120	09.02- CA19321R 14 60	06.04- CA15091R 14 150	05.00- A13 05.00- CS1244 12 1.1	09.02- CS1277 12 1.4
		06.04- CA15641R 14 90				
Scudo 2.0 16V Combinato	[RFN (EW10J4)]	06.00- CA14961R 14 80	06.00- CA15091R 14 150	06.00- CA15641R 14 90	06.00- A13 06.00- CS1244 12 1.1	06.00- CA16461R 14 120 CS1277 12 1.4
Scudo 2.0 Multijet	[RFH(EW10A)]	03.07- CA17611R 14 150			03.07- CS1342 12 1.9	
Scudo 2.0 Multijet 4x4	[RFH(EW10A)]	03.07- CA17611R 14 150			03.07- CS1342 12 1.9	
Scudo 2.0 Diesel Multijet	[DW10BTED4]	01.07- CA17611R 14 150			01.07- CS1342 12 1.9	
	[DW10UTED4]	01.07- CA19201R 14 180				
		01.07- CA17611R 14 150			01.07- CS1342 12 1.9	
	[RHK (DW10UTED4)]	01.07- CA17611R 14 150			01.07- CS1342 12 1.9	
	[RHR (DW10BTED4)]	01.07- CA19201R 14 180				
Scudo 2.0 JTD	[RHX (DW10BTED)]	12.99- CA15641R 14 90	AC 12.99- CA15091R 14 150		12.99- CS1177 12 1.7	12.99- CS712 12 2.2
	[RHZ]	06.04- CA15091R 14 150			12.02- CS1177 12 1.7	12.02- CS594 12 1.4
Scudo 2.0 JTD Combinato	[RHX]	01.04- CA15091R 14 150			01.04- CS1177 12 1.7	
	[RHZ (DW10ATED)]	12.99- CA15641R 14 90	AC 12.99- CA15091R 14 150		12.99- CS712 12 2.2	12.99- CS1177 12 1.7
Scudo 2.0 Multijet	[RH02]	04.11- CA17611R 14 150	04.11- CA19201R 14 180		05.11- CS1342 12 1.9	
	[RHH]	01.07- CA17611R 14 150	01.07- CA19201R 14 180		01.07- CS1342 12 1.9	
Scudo 2.0 Multijet 4x4	[RHK]	01.07- CA17611R 14 150			01.07- CS1342 12 1.9	
Sedici 1.9 Diesel Multijet	[D19AA]	06.06- CA19951R 14 140			06.06- CS1335 12 2.2	
Seicento 0.9	[1170A1.046]	01.98- CA8931R 14 55			01.98- CS1038 12 0.8	
Seicento 1.1	[176B2.000]	01.98- CA8511R 14 65	AC 04.02- CA18431R 14 60	AC 04.02- CA18441R 14 70	01.98- CS1125 12 0.8	01.98- CS796 12 0.8
		AC 01.98- CA8511R 14 65				
	[187A1.000]	01.98- CA8511R 14 65	10.99- CA20591R* 14 90	AC 04.02- CA18441R 14 70	01.98- CS1125 12 0.8	10.99- CS1192 12 0.8
		AC 10.99- 03.02 CA18431R 14 60				
Siena 1.2	[178B5.000]	09.98- CA12191R 14 85	09.98- CA12201R 14 75		09.98- CS796 12 0.8	09.98- CS1125 12 0.8
	[188A5.000]	09.01- CA8901R 14 65	PS 09.01- CA13491R 14 65		09.01- CS1192 12 0.8	09.01- CS1125 12 0.8
Siena 1.4	[178B2.000]	PS 04.96- CA11961R 14 65			04.96- CS975 12 0.9	
	[178B2.016]	PS 04.96- CA11961R 14 65			04.96- CS975 12 0.9	
	[350A1.000]	01.07- CA17661R 14 75	01.07- CA18861R 14 70	01.07- CA19981R 14 105	01.07- CS1379 12 0.8	



Siena 1.6 16V	[178B3.000]	09.98-	CA1219IR	14 85	09.98-	CS975	12 0.9				
		09.98-	CA1220IR	14 75							
		AC 09.98-	CA1485IR	14 80							
		AC 11.99-	CA1471IR	14 90							
Stilo 1.2 16V	[188A5.000]	10.01- 12.03	CA1830IR#	14 75	10.01- 12.03	CS1379	12 0.8				
		AC 10.01- 12.03	CA1742IR	14 85							
		AC 04.03-	CA1998IR	14 105							
Stilo 1.4 16V	[192B2.000]	03.05-	CA1886IR	14 70	03.05-	CS1379	12 0.8				
		03.05-	CA2096IR*	14 105							
		AC 03.05-	CA1742IR	14 85							
	[843A1.000]	AC 03.05-	CA1998IR	14 105	01.04-	CS1379	12 0.8				
		01.04-	CA1886IR	14 70							
AC 01.04-	CA1742IR	14 85	01.04-	CS1379	12 0.8						
	AC 01.04-	CA1998IR				14 105					
A13 01.04-	CA2096IR*	14 105									
Stilo 1.6 16V	[182B6.000]	10.01-	CA1485IR	14 80	10.01-	CS1213	12 1.1				
	AC 10.01-	CA1471IR	14 90	10.01-	CS1345	12 1.3					
[192B3.000]				05.05-	CS1257	12 1.1					
				05.05-	CS519	12 1.0					
Stilo 1.8 16V	[192A4.000]	01.03-	CA1743IR	14 90	10.01-	CS1053	12 1.1				
A13 10.01-	CA1648IR	14 105									
Stilo 1.9 Diesel	[192B5.000]	09.04-	CA1697IR	14 90	09.04-	CS1264	12 1.7				
		09.04-	CA2048IR	14 90							
		AC 09.04-	CA1558IR	14 100							
Stilo 1.9 Diesel Multijet	[192A8.000]	09.05-	CA1697IR	14 90	09.05-	CS1045	12 2.0				
		09.05-	CA2048IR	14 90							
	AC 09.05-	CA1558IR	14 100								
	[192A9.000]	09.05-	CA1558IR	14 100	Chas. -0100367 09.05-	CS1045	12 2.0				
	09.05-	CA1697IR	14 90	Chas. 0100368- 09.05-	CS1264	12 1.7					
09.05-	CA2048IR	14 90									
[937A5.000]	09.05-	CA1885IR	14 120	09.05-	CS1045	12 2.0					
Stilo 1.9 JTD	[192A1.000]	10.01-	CA1558IR	14 100	A13 10.01-	CS1335	12 2.2				
		10.01-	CA2048IR	14 90							
		10.01-	CA2062IR*	14 140							
		01.03-	CA1697IR	14 90							
		01.03-	CA1698IR	14 120							
		AC 10.01-	CA1698IR	14 120							
		AC 01.03-	CA1558IR	14 100							
		[192A3.000]	10.01-	CA1558IR				14 100	10.01-	CS1045	12 2.0
		02.02-	CA2048IR	14 90				10.01-	CS1264	12 1.7	
		AC 02.02-	CA1698IR	14 120							
		AC 01.03-	CA1558IR	14 100							
		[192A5.000]	01.04-	CA1885IR				14 120	01.04-	CS1335	12 2.2
		[192B1.000]	01.04-	CA1558IR				14 100	01.04-	CS1335	12 2.2
		[192B5.000]	09.04-	CA1697IR				14 90	09.04-	CS1264	12 1.7
		09.04-	CA2048IR	14 90				09.04-	CS1045	12 2.0	
		AC 09.04-	CA1558IR	14 100							
		[937A4.000]	01.04-	CA1885IR				14 120	01.04-	CS1335	12 2.2
[937A7.000]	10.01-	CA2048IR	14 90	01.03-	CS1264	12 1.7					
10.01-	CA2062IR*	14 140	A13 01.03-	CS1335	12 2.2						
01.03-	CA1558IR	14 100	01.03-	CS1045	12 2.0						
01.03-	CA1697IR	14 90									
01.03-	CA1698IR	14 120									
AC 01.03-	CA1558IR	14 100									
AC 01.03-	CA1698IR	14 120									
Stilo 2.4 20V	[192A2.000]	AC 10.01-	CA1698IR	14 120	10.01-	CS1042	12 1.4				
Strada 1.2	[178B5.000]	05.02-	CA1844IR	14 70	06.99-	CS1125	12 0.8				
		06.99- 04.02	CA890IR	14 65							
	ACPS 06.99-	CA1154IR	14 75								
	[188A4.000]	04.03-	CA1349IR	14 65	04.03-	CS1124	12 2.2				
AC 04.03-	CA1766IR	14 75									
Strada 1.3 Diesel Multijet	[223A9.000]	05.06-	CA1856IR	14 75	05.06-	CS1125	12 0.8				
		05.06-	CA1862IR	14 90							
		AC 05.06-	CA1934IR	14 105							
Strada 1.7 TD	[176A3.000]	06.99-	CA1084IR	14 65	06.99-	CS1037	12 1.7				
		AC 06.99-	CA1161IR	14 85							
		AC 06.99-	CA1199IR	14 100							
Strada 1.9 Diesel	[223A6.000]	11.00- 03.03	CA1160IR	14 65	11.00- 03.03	CS1212	12 1.8				
		AC 11.00- 03.03	CA1558IR	14 100							
		AC 11.00- 03.03	CA1697IR	14 90							
Strada 1.9 JTD	[188A2.000]	04.03-	CA1696IR	14 65	04.03-	CS1045	12 2.0				
		AC 04.03-	CA1697IR	14 90							
Talento 1.9 Diesel	[149B1.000]	03.89- 03.94	CA1291IR	14 55	03.89- 03.94	CS554	12 2.2				
Talento 2.0	[170B]	03.89- 03.94	CA1501IR	14 50	03.89- 03.94	CS352	12 0.85				
Tempra 1.4 i.e.	[159A2.000]	02.90- 12.96	CA252IR	14 55	02.90- 12.96	CS285	12 0.8				
		02.90- 12.96	CA254IR	14 65							
		AC 02.90- 12.96	CA712IR	14 90							
	[160A1.046]	03.92- 12.96	CA596IR	14 65	03.92- 12.96	CS536	12 1.0				
	ACPS 03.92- 12.96	CA712IR	14 90								
[836A4.000]	03.95- 12.96	CA596IR	14 65	03.95- 12.96	CS536	12 1.0					
ACPS 03.95- 12.96	CA712IR	14 90									
Tempra 1.6	[159A3.000]	02.90- 04.93	CA252IR	14 55	02.90- 04.93	CS536	12 1.0				
		ACPS 02.90- 04.93	CA712IR	14 90							
		AC 02.90- 04.93	CA712IR	14 90							
Tempra 1.6 i.e.	[159A3.046]	06.90- 08.96	CA596IR	14 65	06.90- 08.96	CS536	12 1.0				
		ACPS 06.90- 08.96	CA712IR	14 90							
		AC 06.90- 07.92	CA712IR	14 90							
	[159A3.048]	06.92- 03.93	CA596IR	14 65	06.92- 03.93	CS536	12 1.0				
	ACPS 06.92- 03.93	CA712IR	14 90								
[159B9.000]	Eng. -9606886 05.94- 12.96	CA596IR	14 65	05.94- 12.96	CS975	12 0.9					
AC 05.94- 12.96	CA712IR	14 90									
[835C1.000]	04.93- 12.96	CA596IR	14 65	04.93- 12.96	CS536	12 1.0					
ACPS 04.93- 12.96	CA712IR	14 90	06.90- 08.96	CS883	12 0.9						
Tempra 1.8 4x4	[159A4.000]	07.92- 06.93	CA727IR	14 90	07.92- 06.93	CS584	12 1.4				
		AC 07.92- 06.93	CA1233IR	14 100							
		AC 07.92- 06.93	CA1234IR	14 90							
Tempra 1.8 i.e.	[159A4.000]	03.90- 08.96	CA506IR	14 65	03.90- 08.96	CS584	12 1.4				
		03.90- 08.96	CA727IR	14 90							
		AC 03.93- 08.96	CA1233IR	14 100							
		AC 03.93- 08.96	CA1234IR	14 90							



FIAT Continued

	[159A4.046]	06.90- 12.96 CA1234IR 14 90 06.90- 12.96 CA506IR 14 65 03.92- 08.96 CA727IR 14 90 AC 03.93- 08.96 CA1233IR 14 100 AC 04.93- 08.96 CA1234IR 14 90		06.90- 12.96 CS584 12 1.4
	[835C2.000]	09.93- 08.96 CA506IR 14 65 09.93- 08.96 CA727IR 14 90 AC 09.93- 08.96 CA1233IR 14 100 AC 09.93- 08.96 CA1234IR 14 90		09.93- 08.96 CS584 12 1.4
	[835C4.000]	09.93- 08.96 CA506IR 14 65 09.93- 08.96 CA727IR 14 90 AC 09.93- 08.96 CA1233IR 14 100 AC 09.93- 08.96 CA1234IR 14 90		09.93- 08.96 CS584 12 1.4
	[836A5.000]	10.94- 08.96 CA506IR 14 65 10.94- 08.96 CA727IR 14 90 AC 10.94- 08.96 CA1233IR 14 100 AC 10.94- 08.96 CA1234IR 14 90		10.94- 08.96 CS584 12 1.4
Tempra 1.9 Diesel	[160A7.000]	AC 02.90- 12.96 CA644IR 14 90		02.90- 12.96 CS376 12 2.2
Tempra 1.9 TD	[160A6.000]	02.90- 12.96 CA601IR 14 65 AC 02.90- 12.96 CA644IR 14 90		02.90- 12.96 CS709 12 2.2
	[160A7.000]			07.91- 08.96 CS376 12 2.2 02.96- 08.96 CS992 12 2.2
	[160B6.046]	AC 07.91- 08.96 CA644IR 14 90 07.90- 08.96 CA601IR 14 65 AC 07.90- 08.96 CA644IR 14 90		07.90- 08.96 CS709 12 2.2
	[160D1.000]	04.93- 12.96 CA601IR 14 65 AC 04.93- 12.96 CA644IR 14 90		04.93- 12.96 CS709 12 2.2
Tempra 2.0 i.e.	[159A6.046]	10.90- 12.96 CA506IR 14 65 10.90- 08.96 CA727IR 14 90 AC 03.93- 12.96 CA1233IR 14 100 AC 03.93- 12.96 CA1234IR 14 90		10.90- 12.96 CS584 12 1.4
Tempra 2.0 i.e. 4x4	[159A6.046]	03.92- 03.95 CA506IR 14 65 03.92- 03.95 CA727IR 14 90 AC 03.93- 03.95 CA1233IR 14 100 AC 03.93- 03.95 CA1234IR 14 90		03.92- 03.95 CS584 12 1.4
Tipo 1.1 Digit	[160A3.000]	07.87- 03.93 CA572IR 14 55		07.87- 03.93 CS371 12 0.9
Tipo 1.4 Selecta	[160A1.000]	07.87- 12.89 CA127IR 14 45 07.87- 12.89 CA252IR 14 55 07.87- 12.89 CA254IR 14 65 AC 07.87- 12.89 CA712IR 14 90		07.87- 12.89 CS536 12 1.0
	[160A1.048]	03.89- 11.90 CA127IR 14 45 03.89- 11.90 CA252IR 14 55 03.89- 11.90 CA254IR 14 65 AC 03.89- 11.90 CA712IR 14 90		03.89- 11.90 CS536 12 1.0
Tipo 1.4 i.e.	[159A2.000]	05.89- 04.95 CA252IR 14 55 05.89- 04.95 CA596IR 14 65 AC 05.89- 02.90 CA712IR 14 90		05.89- 04.95 CS536 12 1.0
	[160A1.046]	05.89- 03.93 CA252IR 14 55 05.89- 03.93 CA254IR 14 65 05.89- 03.93 CA596IR 14 65 AC 05.89- 03.93 CA712IR 14 90		05.89- 03.93 CS536 12 1.0
	[836A4.000]	03.93- 10.95 CA596IR 14 65 AC 03.93- 10.95 CA712IR 14 90		03.93- 10.95 CS536 12 1.0
Tipo 1.6 Digit	[160A2.000]	01.88- 10.95 CA127IR 14 45 01.88- 10.95 CA252IR 14 55 ACPS 01.88- 10.95 CA712IR 14 90 AC 01.88- 10.95 CA712IR 14 90		01.88- 10.95 CS536 12 1.0
Tipo 1.6 i.e.	[149C2.046]	02.88- 06.90 CA506IR 14 65		02.88- 06.90 CS975 12 0.9
	[159A3.046]	03.90- 03.93 CA254IR 14 65 03.90- 03.93 CA596IR 14 65 ACPS 03.90- 03.93 CA712IR 14 90 AC 03.90- 03.93 CA712IR 14 90		03.90- 03.93 CS536 12 1.0
	[159A3.048]	03.93- 10.95 CA596IR 14 65 AC 03.93- 10.95 CA712IR 14 90		03.93- 10.95 CS536 12 1.0
	[835C1.000]	03.93- 10.95 CA596IR 14 65 AC 03.93- 10.95 CA712IR 14 90		03.93- 10.95 CS536 12 1.0
Tipo 1.7 Diesel	[149B4.000]	07.87- 01.89 CA129IR 14 55 01.89- 03.93 CA1435IR 14 55 AC 07.87- 03.93 CA644IR 14 90 AC 07.87- 03.93 CA644IR 14 90 07.87- 03.93 CA1435IR 14 55 07.87- 03.93 CA129IR 14 55		01.91- 10.95 CS1059 12 1.7 07.87- 03.93 CS374 12 1.7 07.87- 12.90 CS286 12 1.6 07.87- 12.90 CS286 12 1.6 07.87- 03.93 CS374 12 1.7
Tipo 1.8 i.e. 16V	[160A5.000]	11.89- 06.92 CA506IR 14 65		11.89- 06.92 CS584 12 1.4
Tipo 1.8 i.e.	[159A4.000]	10.90- 06.93 CA506IR 14 65 10.94- 04.95 CA1233IR 14 100		10.90- 04.95 CS584 12 1.4
	[835C2.000]	AC 03.93- 10.95 CA1233IR 14 100 AC 03.93- 10.95 CA1234IR 14 90		03.93- 10.95 CS584 12 1.4
	[835C4.000]	09.93- 10.95 CA506IR 14 65 AC 09.93- 12.94 CA1234IR 14 90 AC 12.94- 10.95 CA1233IR 14 100		09.93- 10.95 CS584 12 1.4
	[836A5.000]	03.93- 04.95 CA727IR 14 90		03.93- 04.95 CS584 12 1.4
Tipo 1.8 i.e. GT	[159A4.046]	10.90- 03.93 CA506IR 14 65		10.90- 03.93 CS584 12 1.4
Tipo 1.9 Diesel	[160A7.000]	07.89- 10.95 CA601IR 14 65 AC 07.89- 10.95 CA644IR 14 90		07.89- 09.91 CS376 12 2.2 10.91- 10.95 CS709 12 2.2
Tipo 1.9 TD	[160A6.000]	07.87- 09.93 CA601IR 14 65 AC 07.87- 09.93 CA644IR 14 90		07.87- 09.93 CS709 12 2.2
	[160A6.046]	06.90- 03.93 CA601IR 14 65 AC 06.90- 03.93 CA644IR 14 90		06.90- 03.93 CS709 12 2.2
	[160B6.046]	07.87- 10.95 CA601IR 14 65 AC 07.87- 10.95 CA644IR 14 90		02.89- 10.95 CS709 12 2.2
	[160D1.000]	03.93- 10.95 CA601IR 14 65 AC 03.93- 10.95 CA644IR 14 90		03.93- 10.95 CS709 12 2.2
Tipo 2.0 16V	[160A8.046]	12.90- 04.95 CA506IR 14 65 AC 12.90- 04.95 CA1233IR 14 100 AC 03.93- 04.95 CA1234IR 14 90		12.90- 04.95 CS584 12 1.4
Tipo 2.0 i.e. 16V Sport	[836A3.000]	03.93- 10.95 CA506IR 14 65 AC 03.93- 10.95 CA1233IR 14 100 AC 03.93- 10.95 CA1234IR 14 90		03.93- 10.95 CS584 12 1.4
Tipo 2.0 i.e.	[159A5.046]	06.90- 03.92 CA506IR 14 65 AC 06.90- 03.92 CA1233IR 14 100		06.90- 03.92 CS584 12 1.4
	[159A6.046]	03.90- 10.95 CA506IR 14 65 AC 03.90- 10.95 CA1233IR 14 100 AC 03.90- 10.95 CA1234IR 14 90		03.90- 10.95 CS584 12 1.4



Ulysse 1.8	[LFW]	05.96-05.00	CA729IR#	14 50	05.96-05.00	CS715	12 1.4		
		05.96-05.00	CA730IR	14 80	05.96-05.00	CS566	12 1.1		
		05.96-05.00	CA825IR	14 95					
		AC 05.96-05.00	CA1086IR	14 80					
		AC 05.96-05.00	CA820IR	14 70					
		AC 05.96-05.00	CA825IR	14 95					
		AC 05.96-05.00	CA836IR	14 120					
Ulysse 1.9 TD	[DHX (XUD9TF/L)]	10.94-12.99	CA1043IR	14 80	10.94-12.99	CS712	12 2.2		
		10.94-12.99	CA1065IR	14 95	10.94-12.99	CS594	12 1.4		
		10.94-12.99	CA1098IR	14 120	10.94-12.99	CS373	12 1.7		
		10.94-12.99	CA1312IR	14 150					
Ulysse 2.0	[RFN (EW10J4)]	08.02-08.02	CA1499IR	14 80	08.02-08.02	CS1244	12 1.1		
		08.02-08.02	CA1674IR	14 150	A13 08.02-08.02	CS1277	12 1.4		
	[RFU (XU10J2C)]	06.94-05.00	CA1086IR	14 80	06.94-05.00	CS715	12 1.4		
		06.94-05.00	CA820IR	14 70	06.94-05.00	CS566	12 1.1		
		06.94-05.00	CA825IR	14 95					
		AC 06.94-05.00	CA836IR	14 120					
Ulysse 2.0 16V	[RFN (EW10J4)]	03.00-08.02	CA1496IR	14 80	03.00-08.02	CS1244	12 1.1		
		03.00-08.02	CA1509IR	14 150	A13 03.00-08.02	CS1277	12 1.4		
		03.00-08.02	CA1564IR	14 90					
	[RFV]	05.98-05.00	CA1052IR	14 90	05.98-05.00	CS566	12 1.1		
		05.98-05.00	CA1151IR	14 70	05.98-05.00	CS715	12 1.4		
		05.98-05.00	CA1152IR	14 80					
		05.98-05.00	CA1156IR	14 120					
Ulysse 2.0 Turbo	[RGX (XU10J2CTE)]	06.94-02.97	CA1086IR	14 80	06.94-08.02	CS715	12 1.4		
		06.94-02.97	CA820IR	14 70	06.94-08.02	CS566	12 1.1		
		06.94-02.97	CA825IR	14 95					
		03.97-08.02	CA1052IR	14 90					
		03.97-08.02	CA1151IR	14 70					
		03.97-08.02	CA1152IR	14 80					
		03.97-08.02	CA1156IR	14 120					
		AC 06.94-02.97	CA836IR	14 120					
		Ulysse 2.0 JTD 16V	[RHW(DW10ATED4)]	05.99-08.02	CA1646IR	14 120	05.99-08.02	CS1177	12 1.7
				AC 05.99-08.02	CA1509IR	14 150			
Ulysse 2.0 JTD	[RHM (DW10ATED4)]	06.03-08.02	CA1761IR	14 150	05.03-08.02	CS1177	12 1.7		
		08.02-08.02	CA1553IR	14 150	A13 08.02-08.02	CS712	12 2.2		
	[RHW (DW10ATED4)]	08.02-08.02	CA1761IR	14 150	A13 08.02-08.02	CS570	12 3.1		
					08.02-08.02	CS594	12 1.4		
		10.99-08.02	CA1509IR	14 150	A13 10.99-08.02	CS712	12 2.2		
					A13 10.99-08.02	CS570	12 3.1		
			10.99-08.02	CS1177	12 1.7				
			10.99-08.02	CS594	12 1.4				
Ulysse 2.0 Multijet	[RHK]	05.06-05.06	CA1761IR	14 150	A13 05.06-05.06	CS1326	12 2.3		
		05.06-05.06	CA1920IR	14 180	A13 05.06-05.06	CS594	12 1.4		
	[RHR]	05.06-05.06	CA1761IR	14 150	A13 05.06-05.06	CS1326	12 2.3		
		05.06-05.06	CA1920IR	14 180	A13 05.06-05.06	CS594	12 1.4		
Ulysse 2.1 TD	[P8C]	03.96-10.99	CA1043IR	14 80	A13 03.96-10.99	CS570	12 3.1		
		03.96-10.99	CA1065IR	14 95	03.96-10.99	CS594	12 1.4		
		03.96-10.99	CA1098IR	14 120	A13 03.96-10.99	CS1177	12 1.7		
		03.96-10.99	CA1312IR	14 150	A13 03.96-10.99	CS712	12 2.2		
					A13 08.02-08.02	CS1177	12 1.7		
			08.02-08.02	CS594	12 1.4				
Ulysse 2.2 JTD	[4HW (DW12ATED4)]	08.02-08.02	CA1761IR	14 150	A13 08.02-08.02	CS1177	12 1.7		
Ulysse 2.2 Multijet	[4HT]	03.08-03.08	CA1761IR	14 150	03.08-03.08	CS1416	12 2.5		
Ulysse 3.0 V6	[XFW (ES9J4S)]	08.02-08.02	CA1388IR	14 150	08.02-08.02	CS1108	12 1.5		
		08.02-08.02	CA1392IR	14 120					
Uno 0.9 ES	[146A.000]	03.83-09.92	CA3071R	14 45	03.83-09.92	CS90	12 0.8 SM		
					03.83-09.92	CS1038	12 0.8 LM		
					03.83-09.92	CS90	12 0.8		
Uno 1.0	[156A2.048]	06.86-05.91	CA350IR	14 45	06.86-05.91	CS371	12 0.9		
		06.86-05.91	CA572IR	14 55					
	[156A2.100]	06.86-12.93	CA350IR	14 45	06.86-03.94	CS371	12 0.9		
		06.86-03.94	CA572IR	14 55					
			06.86-10.02	CA350IR	14 45	04.94-10.02	CS368	12 0.9	
			06.86-12.93	CA572IR	14 55	06.86-12.93	CS371	12 0.9	
Uno 1.0 i.e.	[156A2.246]	08.85-10.95	CA572IR	14 55	08.85-10.95	CS371	12 0.9		
Uno 1.1	[138B.000]	01.83-08.89	CA1271R	14 45	01.83-08.89	CS91	12 0.8		
		01.83-08.89	CA252IR	14 55					
	[146A4.044]	01.86-12.89	CA572IR	14 55	01.86-12.89	CS371	12 0.9		
		05.85-08.89	CA1271R	14 45	05.85-08.89	CS91	12 0.8		
	[146A4.048]	05.85-08.89	CA252IR	14 55					
		01.90-12.93	CA572IR	14 55	11.92-12.93	CS963	12 0.8		
				01.90-10.92	CS371	12 0.9			
				04.89-12.92	CS371	12 0.9			
Uno 1.1 i.e.	[146C3.000]	09.89-03.94	CA572IR	14 55	11.92-03.94	CS963	12 0.8		
				09.89-10.92	CS371	12 0.9			
Uno 1.3	[138B2.000]	01.83-04.85	CA1271R	14 45	01.83-04.85	CS91	12 0.8		
		01.83-04.85	CA252IR	14 55					
	[149A7.000]	05.85-08.89	CA1271R	14 45	05.85-08.89	CS91	12 0.8		
		05.85-08.89	CA252IR	14 55					
Uno 1.3 i.e. Turbo	[146A2.000]	04.85-08.89	CA254IR	14 65	04.85-08.89	CS285	12 0.8		
		10.87-08.89	CA254IR	14 65	10.87-08.89	CS285	12 0.8		
	[146A2.246]	09.89-03.91	CA254IR	14 65	09.89-03.91	CS285	12 0.8		
Uno 1.3 Diesel Super	[127A5.000]				06.83-03.92	CS364	12 1.1		
					09.89-03.92	CS364	12 1.1		
Uno 1.4 S	[160A1.048]	09.89-10.92	CA1271R	14 45	09.89-10.92	CS285	12 0.8		
		09.89-10.92	CA252IR	14 55					
		09.89-10.92	CA254IR	14 65					
Uno 1.4 i.e. Turbo	[146A8.000]	12.89-12.96	CA254IR	14 65	01.95-12.89-12.94	CS883	12 0.9		
					12.89-12.94	CS536	12 1.0		
		10.90-12.93	CA834IR#	14 65	10.90-12.93	CS285	12 0.8		
Uno 1.4 i.e.	[146C1.000]	09.89-12.93	CA834IR#	14 65	09.89-12.93	CS536	12 1.0		
		09.89-03.94	CA834IR#	14 65	09.89-03.94	CS536	12 1.0		
				09.89-12.93	CS285	12 0.8			
Uno 1.4 TD	[146B3.000]	03.86-09.92	CA1435IR	14 55	Chas. 796392-09.89-09.92	CS1059	12 1.7		
					Chas. -796391 09.89-04.91	CS374	12 1.7		
					03.86-08.89	CS286	12 1.6		
Uno 1.5 i.e.	[138C2.048]	10.85-08.87	CA252IR	14 55	10.85-08.87	CS285	12 0.8		
		10.85-08.87	CA254IR	14 65					



FIAT Continued

	[149C1.000]	09.87- 03.94 CA252IR	14 55	08.87- 03.94 CS285	12 0.8
		09.87- 03.94 CA254IR	14 65		
Uno 1.7 Diesel	[146B2.000]	09.89- 03.94 CA1435IR	14 55	09.89- 04.91 CS286	12 1.6
				05.91- 03.94 CS1059	12 1.7
				09.89- 04.91 CS374	12 1.7
	[149B3.000]	07.86- 08.89 CA1435IR	14 55	07.86- 08.89 CS374	12 1.7
				07.86- 08.89 CS286	12 1.6
Uno 1.9 Diesel	[149B5.046]	09.89- 03.94 CA1435IR	14 55		
X1/9 1.3	[128AS.000]			01.73- 12.79 CS91	12 0.8
X1/9 1.5 5-speed	[138AS.000]	11.78- 12.89 CA127IR	14 45	11.78- 12.89 CS133	12 0.9
	[138BS.031]	06.85- 12.89 CA127IR	14 45	06.85- 12.89 CS133	12 0.9
<b>PASSENGER CARS US</b>					
124 1.2				01.67- 01.69 CS141	12 0.8
124 1.4				01.68- 01.73 CS141	12 0.8
124 1.4 Spider				01.69- 01.70 CS141	12 0.8
124 2.0 Spider		01.79- 01.81 CA129IR	14 55		
		01.79- 01.81 CA195IR	14 65		
Brava 2.0		01.79- 01.81 CA129IR	14 55		
		01.79- 01.81 CA195IR	14 65		
Marea 1.6	[182B6.000]	09.00- 08.02 CA1471IR	14 90	09.00- 08.02 CS1213	12 1.1
		09.00- 08.02 CA1485IR	14 80	09.00- 08.02 CS975	12 0.9
		09.00- 08.02 CA1648IR	14 105		
Strada 1.5		01.79- 01.80 CA252IR	14 55	01.79- 01.82 CS133	12 0.9
		01.79- 01.80 CA127IR	14 45		
		01.81- 01.82 CA504IR	14 65		
Strada 1.5 Custom		01.81- 01.82 CA504IR	14 65	01.80- 01.82 CS133	12 0.9
		01.80- 01.80 CA252IR	14 55		
		01.80- 01.80 CA127IR	14 45		
X-1/9 1.5		01.79- 01.83 CA127IR	14 45	01.79- 01.83 CS133	12 0.9
		01.79- 01.80 CA252IR	14 55		
		01.81- 01.83 CA504IR	14 65		
X-1/9 2.0		01.83- 01.83 CA504IR	14 65	01.83- 01.83 CS133	12 0.9
<b>PASSENGER CARS AO</b>					
Bravo 1.6	[182B6.000]	09.00- 02.02 CA1471IR	14 90		
Doblo 1.3 JTD	[199A2.000]	05.05- CA1934IR	14 105		
Ducato 2.0 4x4	[RFW]	11.94- 11.01 CA1086IR	14 80	11.94- 11.01 CS715	12 1.4
		AC 11.94- 11.01 CA825IR	14 95	11.94- 11.01 CS566	12 1.1
Ducato 2.0 Panorama	[170D]	06.90- 05.94 CA150IR	14 50	06.90- 05.94 CS352	12 0.85
Ducato 2.5 TD	[8140.47]	06.94- 08.98 CA1039IR	14 80	06.94- 08.98 CS973	12 2.2
		06.94- 08.98 CA1157IR	14 110		
		AC 06.94- 08.98 CA1157IR	14 110		
Ducato 2.5 TD 4x4	[8140.47]	11.94- 04.98 CA1039IR	14 80	11.94- 04.98 CS973	12 2.2
		11.94- 04.98 CA1157IR	14 110	11.94- 04.98 CS1109	12 2.6
		AC 11.94- 04.98 CA1157IR	14 110		
Ducato 2.5 TD Panorama 4x4	[8140.27]	06.90- 05.94 CA316IR	14 55	06.90- 05.94 CS510	12 2.2
Ducato 2.8 4x4	[8140.43]	05.98- 09.01 CA1039IR	14 80	05.98- 09.01 CS1198	12 2.3
		AC 05.98- 09.01 CA1157IR	14 110	05.98- 09.01 CS1109	12 2.6
Ducato 2.8 Diesel	[8140.43]	11.03- 07.06 CA1835IR	14 120	Chas. 7600145- 11.03- 07.06 CS1389	12 2.5
				Chas. -7600144 11.03- 07.06 CS1198	12 2.3
Ducato 2.8 Diesel 4x4	[8140.43]	11.03- 07.06 CA1835IR	14 120	Chas. 7600145- 11.03- 07.06 CS1389	12 2.5
				Chas. -7600144 11.03- 07.06 CS1198	12 2.3
Ducato 2.8 JTD	[8140.43S]	03.01- 11.01 CA1643IR	14 120	03.01- 11.01 CS1109	12 2.6
		03.01- 11.01 CA2037IR	14 150	03.01- 11.01 CS1198	12 2.3
Ducato 2.8 TD 4x4	[8140.43]	05.98- 09.01 CA1157IR	14 110	05.98- 09.01 CS1109	12 2.6
				05.98- 09.01 CS1198	12 2.3
	[8140.63]	05.98- 11.01 CA1039IR	14 80	05.98- 11.01 CS1109	12 2.6
		05.98- 11.01 CA1835IR	14 120	05.98- 11.01 CS1198	12 2.3
		AC 05.98- 11.01 CA1157IR	14 110		
Elba 1.4	[146D5.000]	10.93- 02.95 CA596IR	14 65	10.93- 02.95 CS285	12 0.8
Fiorino 1.4	[146C5.000]	11.92- 10.96 CA596IR	14 65	11.92- 10.96 CS285	12 0.8
Fiorino 1.7 Diesel	[146B2.000]	01.88- 10.99 CA1435IR	14 55	01.88- 12.95 CS374	12 1.7
				06.99- CS1037	12 1.7
		AC 01.88- 10.99 CA1199IR	14 100	01.96- 05.99 CS1059	12 1.7
Fiorino 1.7 TD S	[146D7.000]	11.96- 05.00 CA1435IR	14 55	11.96- 05.99 CS1059	12 1.7
				11.96- CS1037	12 1.7
Marea 1.6	[185A3.000]	03.99- 08.00 CA1221IR	14 85	03.99- 10.99 CS975	12 0.9
		03.99- 08.00 CA1471IR	14 90	11.99- 08.00 CS1213	12 1.1
Marea 1.6 SX	[182B5.098]	09.00- 08.02 CA1221IR	14 85	09.00- 08.02 CS1213	12 1.1
		09.00- 08.02 CA1471IR	14 90	09.00- 08.02 CS975	12 0.9
		AC 09.00- 08.02 CA1648IR	14 105		
Multipia 1.6	[182B6.000]	05.04- 08.05 CA1485IR	14 80	05.04- 08.05 CS1345	12 1.3
		AC 05.04- 08.05 CA1471IR	14 90	05.04- 08.05 CS1213	12 1.1
Multipia 1.6 G	[182B6.000]	03.01- 08.05 CA1485IR	14 80	03.01- 08.05 CS1213	12 1.1
		AC 03.01- 08.05 CA1471IR	14 90	03.01- 08.05 CS1345	12 1.3
Palio 1.1	[178B9.033]			07.97- 10.03 CS1125	12 0.8
				07.97- 10.03 CS796	12 0.8
Palio 1.2	[178B7.045]	07.97- 08.02 CA1153IR	14 65	07.97- 08.02 CS1192	12 0.8
	[178C4.066]	07.97- 08.02 CA1153IR	14 65	07.97- 08.02 CS1192	12 0.8
	[178E2.000]	06.99- 10.00 CA890IR	14 65	06.99- 10.00 CS1125	12 0.8
		PS 06.99- 10.00 CA1153IR	14 65		
		ACPS 06.99- 10.00 CA1154IR	14 75		
	[188A4.000]	07.97- 08.02 CA1153IR	14 65	07.97- 08.02 CS1192	12 0.8
	[188A5.000]	09.01- CA890IR	14 65		
		AT 09.01- CA1349IR	14 65		
Palio 1.3				06.03- CS1124	12 2.2
Palio 1.3 JTD Multijet	[188A9.000]	06.03- CA1856IR	14 75	06.03- CS1346	12 1.3
		06.03- CA1862IR	14 90		
Palio 1.4 EL	[178B2.000]	07.97- 08.01 CA1196IR	14 65	07.97- 08.01 CS975	12 0.9
Palio 1.6	[178D2.011]	07.97- 10.03 CA1485IR	14 80	07.97- 10.03 CS1191	12 1.4
		AC 07.97- 10.03 CA1471IR	14 90		
		06.99- CA861IR	14 70		
Palio 1.7 TD ED	[176A5.000]	07.97- 10.03 CA1084IR	14 65	07.97- 10.03 CS1037	12 1.7
Palio 1.7 TD HL	[176A5.000]	09.01- CA1199IR	14 100	09.01- CS1037	12 1.7
Palio 1.9 Diesel	[223A6.000]	09.00- 09.01 CA1160IR	14 65	09.00- 09.01 CS1212	12 1.8
		AC 09.00- 09.01 CA1697IR	14 90		
Palio 1.9 JTD EL	[188A2.000]	09.01- CA1696IR	14 65	09.01- CS1264	12 1.7
		AC 09.01- CA1697IR	14 90		
Siena 1.2	[178C4.066]	09.01- CA1349IR	14 65	09.01- CS1192	12 0.8
	[188A4.000]	09.01- CA1349IR	14 65	09.01- CS1192	12 0.8
Siena 1.5	[178E5.022]			06.04- CS1192	12 0.8
Siena 1.6	[182B6.000]	11.00- CA1471IR	14 90	11.00- CS1213	12 1.1
				11.00- CS1345	12 1.3
Siena 1.7 Diesel GL	[176A3.000]	02.06- CA1084IR	14 65	02.06- CS1037	12 1.7
Siena 1.9 Diesel	[223A6.000]	11.00- CA1697IR	14 90		





Strada 1.2 Trekking		11.05-	CA1886IR	14 70				
Strada 1.6 Trekking		11.05-	CA1485IR	14 80				
		AC 11.05-	CA1471IR	14 90				
Tempra 1.6	[159A3.048]	04.90- 06.93	CA596IR	14 65	04.90- 06.93	CS285	12 0.8	
Tempra 1.6 S.W.	[159A3.048]	07.93- 07.96	CA596IR	14 65	07.93- 07.96	CS285	12 0.8	
Tipo 1.6 DGT SX	[159A3.000]	05.89- 10.92	CA1055IR	14 70	05.89- 10.92	CS285	12 0.8	
		AC 05.89- 10.92	CA326IR	28 55				
		AC 05.89- 10.92	CA727IR	14 90				
Uno 1.0	[146A2.166]	11.94- 08.00	CA350IR	14 45	11.94- 08.00	CS371	12 0.9	
		11.94- 08.00	CA572IR	14 55	11.94- 08.00	CS1125	12 0.8	
Uno 1.0 iE	[156A2.246]	05.98- 08.00	CA350IR	14 45	05.98- 08.00	CS371	12 0.9	
<b>AGRICULTURE</b>								
404 Diesel					01.84-	CS795#	12 2.5	
420 Diesel					01.84-	CS795#	12 2.5	
440 Diesel					01.84-	CS795#	12 2.5	
450 Diesel					01.84-	CS795#	12 2.5	
455 Diesel					01.84-	CS795#	12 2.5	
470 Diesel					01.84-	CS795#	12 2.5	
100.90 5.4 Diesel	[8065.06.200]				06.84- 08.88	CS682	12 3.0	
110.90 5.9 Diesel	[8065.05.220]				11.86- 08.88	CS682	12 3.0	
115.90 5.9 Diesel	[8065.05.000]				01.84- 08.88	CS682	12 3.0	
130.90 5.9 Diesel	[8065.25.010]				01.84- 08.88	CS682	12 3.0	
140.90 5.9 Diesel	[8065.25.000]				01.84- 08.88	CS682	12 3.0	
160.90 8.1 Diesel	[OM8365.25.5..]				01.84- 08.88	CS682	12 3.0	
180.90 8.1 Diesel	[OM8365.25.5..]				01.84- 08.88	CS682	12 3.0	
500S Diesel					01.78- 01.82	CS795#	12 2.5	
55.46 2.7 Diesel	[8035.06..]				01.85- 08.88	CS572	12 2.5	
55.65 2.7 Diesel	[8035.06..]				10.84- 08.88	CS572	12 2.5	
55.66 2.7 Diesel	[8035.06..]				09.84- 08.88	CS572	12 2.5	
55.90 2.7 Diesel	[8035.06.200]				03.84- 08.88	CS572	12 2.5	
60.46 2.9 Diesel	[8035.05..]				09.87- 08.88	CS572	12 2.5	
60.65 2.9 Diesel	[8035.05..]				10.84- 08.88	CS572	12 2.5	
60.66 2.9 Diesel	[8035.05..]				09.84- 08.88	CS572	12 2.5	
60.90 2.9 Diesel	[8035.05.200]				03.84- 08.88	CS572	12 2.5	
65.46 3.6 Diesel	[8045.06..]				04.85- 08.88	CS240	12 3.0	
65.66 3.6 Diesel	[8045.06..]				06.87- 08.88	CS240	12 3.0	
65.90 3.6 Diesel	[8045.06..]				09.87- 08.88	CS240	12 3.0	
70.65 3.6 Diesel	[8045.06..]				10.84- 08.88	CS240	12 3.0	
70.66 3.6 Diesel	[8045.06..]				09.84- 08.88	CS240	12 3.0	
70.90 3.6 Diesel	[8045.06..]				03.84- 08.88	CS240	12 3.0	
80.65 3.9 Diesel	[8045.05..]				10.84- 08.88	CS240	12 3.0	
80.66 3.9 Diesel	[8045.05..]				05.87- 08.88	CS240	12 3.0	
80.90 3.9 Diesel	[8045.05..]				03.84- 08.88	CS240	12 3.0	
85.55 3.9 Diesel	[8045.05..]				10.84- 08.88	CS240	12 3.0	
90.90 4.9 Diesel	[8055.05.200]				06.84- 08.88	CS682	12 3.0	
95.55 4.9 Diesel	[8055.05.205]				10.84- 08.88	CS682	12 3.0	
<b>Fiat-Allis</b>								
<b>AGRICULTURE</b>								
65 B 5.9 Diesel	[8061..]	01.86- 01.01	CA326IR	28 55	01.86- 01.01	CS232	24 4.0	
FA 150 8.1 Diesel	[8365.25.542]	03.84- 03.99	CA212IR	28 27				
FD 14E 8.1 Diesel	[8365.25.541]	12.88- 12.92	CA212IR	28 27				
FD 20 5.9 Diesel	[8215.02.520]	03.84- 03.99	CA212IR	28 27				
FD 30C 17.0 Diesel	[8285.22.004]	10.90-	CA326IR	28 55				
FR 130 5.9 Diesel	[8065.25..]	04.90- 04.05	CA326IR	28 55				
FR 160 8.1 Diesel	[8365.25..]	07.90-	CA326IR	28 55				
FR 220 9.5 Diesel	[8465.21..]	01.91-	CA326IR	28 55				
<b>Foden</b>								
<b>TRUCKS EU</b>								
2000 Series 6.0	[Cummins B]				01.96-	US1245#	24 4.5	
<b>Ford</b>								
<b>PASSENGER CARS EU</b>								
Aerostar 3.0 iV6		01.88- 01.90	UA1210IR#	14 75				
Aerostar 4.0 iV6 4WD					01.92- 01.93	US1028	12 1.4	
Capri 1.3	[J1E]	01.74- 08.77	CA126IR	14 45	01.74- 08.77	CS78	12 0.75	
		01.74- 06.85	CA190IR	14 35				
		02.74- 06.85	CA226IR	14 55				
		RHD 01.74- 08.77	CA60IR	14 45				
		RHD 01.74- 08.77	CA94IR	14 55				
Capri 1.3 1300	[TV13L]	12.68- 12.72	CA190IR	14 35	12.68- 12.72	CS72	12 1.1	
		RHD 12.68- 12.72	CA15h#	14 28	12.68- 12.72	CS69	12 0.8	
		01.69- 12.73	CA190IR	14 35	10.72- 12.73	CS78	12 0.75	
		10.72- 12.73	CA126IR	14 45				
		RHD 09.72- 12.73	CA60IR	14 45				
		RHD 10.72- 12.73	CA94IR	14 55				
		01.69- 12.73	CA226IR	14 55				
		RHD 01.69- 12.72	CA15h#	14 28				
		09.72- 12.72	CA94IR	14 55				
Capri 1.5 1500	[TV15H]				12.68- 02.74	CS69	12 0.8	
					12.68- 02.74	CS72	12 1.1	
	[TV15L]				12.68- 02.74	CS69	12 0.8	
					12.68- 02.74	CS72	12 1.1	
Capri 1.6	[LAC]	09.74- 12.77	CA126IR	14 45	AT 09.74- 12.77	CS86	12 1.0	
		09.74- 12.77	CA226IR	14 55	09.74- 12.77	CS78	12 0.75	
		RHD 09.74- 12.77	CA60IR	14 45				
		RHD 09.74- 12.77	CA94IR	14 55				
	[LCE]	01.74- 12.77	CA126IR	14 45	01.74- 12.77	CS78	12 0.75	
		01.74- 12.77	CA226IR	14 55	AT 01.74- 12.77	CS86	12 1.0	
		RHD 01.74- 12.77	CA60IR	14 45				
		RHD 01.74- 12.77	CA94IR	14 55				
	[LCN]	01.78- 04.87	CA126IR	14 45	AT 01.78- 04.87	CS86	12 1.0	
		01.78- 04.87	CA226IR	14 55	01.78- 04.87	CS78	12 0.75	
		RHD 01.78- 04.87	CA60IR	14 45				
		RHD 01.78- 04.87	CA94IR	14 55				
	[LEC]	01.74- 12.77	CA126IR	14 45	01.74- 12.77	CS78	12 0.75	
		01.74- 12.77	CA226IR	14 55	AT 01.74- 12.77	CS86	12 1.0	
		RHD 01.74- 12.77	CA60IR	14 45				
		RHD 01.74- 12.77	CA94IR	14 55				
Capri 1.6 1600	[LE]	08.72- 04.74	CA126IR	14 45	08.72- 04.74	CS78	12 0.75	
		08.72- 04.74	CA226IR	14 55				
		08.72- 02.74	CA94IR	14 55	08.72- 02.74	CS78	12 0.75	
		RHD 08.72- 02.74	CA60IR	14 45				
		08.72- 02.74	CA226IR	14 55				
		08.72- 02.74	CA126IR	14 45				



**FORD** *Continued*

Capri 1.6 1600 GT		01.69- 10.72	CA1261R	14 45				
		01.69- 10.72	CA2261R	14 55				
Capri 1.7 1700	[TV17H]	12.68- 08.72	CA1261R	14 45	12.68- 08.72	CS72	12 1.1	
		12.68- 08.72	CA2261R	14 55	12.68- 08.72	CS69	12 0.8	
Capri 2.0	[NEN]	01.78- 12.85	CA1261R	14 45	01.78- 12.85	CS72	12 1.1	
		01.78- 12.85	CA2261R	14 55				
		RHD 01.78- 12.85	CA601R	14 45				
		RHD 01.78- 12.85	CA941R	14 55				
	[NWN]	04.76- 12.77	CA1261R	14 45	04.76- 12.77	CS72	12 1.1	
		04.76- 12.77	CA2261R	14 55	04.76- 12.77	CS69	12 0.8	
	[NYL]	04.76- 12.82	CA1261R	14 45	04.76- 12.77	CS328	12 1.4	
		04.76- 12.82	CA2261R	14 55	04.76- 12.77	CS72	12 1.1	
	[OHCTL20H]	04.74- 12.85	CA1261R	14 45	01.78- 08.85	CS72	12 1.1	
		04.74- 12.85	CA2261R	14 55				
		RHD 01.78- 12.85	CA601R	14 45				
		RHD 01.78- 12.85	CA941R	14 55				
01.78- 12.85		CA1261R	14 45	01.78- 12.85	CS72	12 1.1		
11.81- 12.85		CA941R	14 55					
Capri 2.0 2000	[TV20H]	02.69- 08.72	CA1261R	14 45	02.69- 08.72	CS69	12 0.8	
		02.69- 08.72	CA2261R	14 55	02.69- 08.72	CS72	12 1.1	
		RHD 02.69- 08.72	CA17v	14 34				
		RHD 02.69- 08.72	CA18v	14 43				
	[TV20L]	02.69- 06.71	CA1261R	14 45	02.69- 06.71	CS72	12 1.1	
		02.69- 06.71	CA2261R	14 55	02.69- 06.71	CS69	12 0.8	
		RHD 02.69- 06.71	CA17v	14 34				
		RHD 02.69- 06.71	CA18v	14 43				
		02.69- 02.74	CA2261R	14 55				
		02.69- 02.74	CA1261R	14 45				
Capri 2.3	[YYE]	01.74- 12.77	CA1261R	14 45	01.74- 12.77	CS69	12 0.8	
		01.74- 12.77	CA2261R	14 55	01.74- 12.77	CS72	12 1.1	
Capri 2.3 2300	[TV232H]	02.69- 02.74	CA1261R	14 45	02.69- 02.74	CS69	12 0.8	
		02.69- 02.74	CA2261R	14 55	02.69- 02.74	CS72	12 1.1	
		RHD 09.72- 02.74	CA601R	14 45				
		RHD 09.72- 02.74	CA941R	14 55				
	[TV23S]	08.69- 04.74	CA1261R	14 45	08.69- 12.73	CS69	12 0.8	
		08.69- 04.74	CA2261R	14 55	08.69- 04.74	CS72	12 1.1	
Capri 2.3 Super	[YYN]	06.79- 12.85	CA1261R	14 45	06.79- 08.85	CS72	12 1.1	
		06.79- 12.85	CA2261R	14 55	08.85- 12.85	CS328	12 1.4	
		RHD 06.79- 12.85	CA941R	14 55				
Capri 2.6 2600	[UY]	08.70- 04.74	CA1261R	14 45	08.70- 12.73	CS69	12 0.8	
		08.70- 04.74	CA2261R	14 55	08.70- 04.74	CS72	12 1.1	
		RHD 09.72- 04.74	CA601R	14 45				
		RHD 09.72- 04.74	CA941R	14 55				
Capri 2.8 i Turbo	[PYN]				01.82- 08.85	CS72	12 1.1	
Capri 2.8 i Super	[PRN]				08.85- 04.87	CS328	12 1.4	
					01.81- 08.85	CS72	12 1.1	
Capri 3.0	[HYF]	01.74- 12.81	CA2261R	14 55				
		02.74- 12.81	CA941R	14 55				
		RHD 01.74- 12.77	CA941R	14 55				
Capri 3.0 3000	[HY]	RHD 08.72- 04.74	CA941R	14 55				
C-Max 1.6		02.07-	CA19251R	14 105	02.07-	CS1050	12 1.1	
C-Max 1.6 Ti-CVT	[IQD..]	12.10-	CA20441R*	14 120	12.10-	CS1050	12 1.1	
	[PND.A]	12.10-	CA20441R*	14 120	12.10-	CS1050	12 1.1	
C-Max 1.6 TDCi	[T1D..]				12.10-	CS1341	12 1.2	
					12.10-	CS1341	12 1.2	
	[T3D..]	02.07-	CA18341R	14 150	02.07-	CS1341	12 1.2	
		02.07-	CA18651R	14 120				
C-Max 1.8	[QDQC]	02.07-	CA19261R	14 120	02.07-	CS1402	12 1.2	
					02.07-	CS1402	12 1.2	
		02.07-	CA19261R	14 120	AT 02.07-	CS1403	12 1.2	
C-Max 1.8 FlexFuel					02.07-	CS1402	12 1.2	
					AT 02.07-	CS1403	12 1.2	
C-Max 1.8 TDCi	[KKDA]	AC, w/electrical heating system	02.07-	CA19991R	14 150	02.07-	CS1408	12 2.0
		AC 02.07-	CA19411R	14 120				
		AC 02.07-	CA19891R	14 105				
C-Max 2.0			02.07-	CA19261R	14 120	02.07-	CS1403	12 1.2
			AT 02.07-	CA18641R	14 120			
C-Max 2.0 CNG			04.09-	CA18641R	14 120	04.09-	CS1403	12 1.2
C-Max 2.0 LPG			06.08-	CA18641R	14 120	06.08-	CS1403	12 1.2
C-Max 2.0 TDCi	[TXDB]				12.10-	CS1377	12 2.2	
	[TYDA]				02.11-	CS1377	12 2.2	
			02.07-	CA18341R	14 150	02.07-	CS1377	12 2.2
			02.07-	CA18651R	14 120			
Consul 1.7 1700	[TV17H]	01.72- 02.76	CA1901R	14 35	01.72- 02.76	CS69	12 0.8	
		01.72- 02.76	CA961R	14 55				
		03.72- 02.75	CA611R	14 45				
			01.72- 12.75	CA1901R	14 35	01.72- 12.75	CS69	12 0.8
Consul 2.0 2000	[TL20H]	03.72- 02.75	CA601R	14 45	03.72- 02.75	CS86	12 1.0	
		03.72- 02.75	CA941R	14 55				
	[TV20H]	01.72- 12.74	CA941R	14 55	01.72- 12.74	CS72	12 1.1	
		01.72- 12.74	CA601R	14 45	01.72- 12.74	CS86	12 1.0	
Consul 2.3 2300	[TV23H]	03.72- 02.75	CA1901R	14 35	03.72- 02.75	CS72	12 1.1	
		03.72- 02.75	CA611R	14 45				
		03.72- 02.75	CA961R	14 55				
Consul 2.5 2500					01.72- 12.74	CS72	12 1.1	
Consul 3.0 3000					01.72- 12.75	CS119	12 1.5	
Cortina 1.3 1300		01.70- 03.72	CA17h	14 34	10.70- 03.72	CS78	12 0.75	
		RHD 01.70- 03.72	CA15h#	14 28				
		01.70- 03.72	CA17v	14 34				
Cortina 1.6 1600		01.70- 03.72	CA17v	14 34	10.70- 03.72	CS78	12 0.75	
		01.70- 03.72	CA17h	14 34				
Cortina 1.6 1600 GT		10.70- 03.72	CA17v	14 34	10.70- 03.72	CS78	12 0.75	
		10.70- 03.72	CA17h	14 34				
Cortina 2.0 2000		10.70- 03.72	CA17h	14 34				
		10.70- 03.72	CA17v	14 34				
		RHD 10.70- 03.72	CA15h#	14 28				



Cougar 2.0 16V	[EDBA]	08.98-	CA1482IR	14 105		AT 08.98-08.98-	CS1058	12 1.5
	[EDBB]	08.98-	CA1482IR	14 105		AT 08.98-12.00	CS1107	12 1.4
	[EDBC]	08.98-	CA1482IR	14 105		AT 08.98-12.00	CS1058	12 1.5
	[EDBD]	08.98-	CA1482IR	14 105		AT 08.98-12.00	CS1058	12 1.5
Cougar 2.5 i ST 200	[SGA]	01.00-	CA1316IR	14 130		01.00-	CS961	12 1.4
Cougar 2.5 V6 24V	[LCBA]	08.98-	CA1316IR	14 130		08.98-	CS961	12 1.4
	[LCBB]	08.98-12.00	CA1316IR	14 130		08.98-12.00	CS961	12 1.4
	[LCBC]	08.98-12.00	CA1316IR	14 130		08.98-12.00	CS961	12 1.4
	[LCBE]	08.98-12.00	CA1316IR	14 130		08.98-12.00	CS961	12 1.4
Econovan 1.4	[UC]	08.85-03.92	JA127IR	14 50				
Econovan 2.0 Diesel	[RF]	03.86-03.92	JA180IR	14 60		09.85-03.92	JS365	12 2.0
		03.86-03.92	JA577IR	14 50				
Escort 1.1	[G1]	10.74-08.80	CA190IR	14 35		10.74-08.80	CS78	12 0.75
		12.74-08.80	CA61IR	14 45				
		12.74-08.80	CA96IR	14 55				
		RHD 12.74-08.80	CA17h	14 34				
		RHD 12.74-08.80	CA18h	14 43				
	[G2]	10.74-08.80	CA190IR	14 35		10.74-08.80	CS78	12 0.75
		12.74-08.80	CA61IR	14 45				
		12.74-08.80	CA96IR	14 55				
		RHD 12.74-08.80	CA17h	14 34				
		RHD 12.74-08.80	CA18h	14 43				
	[GLB]	09.80-08.83	CA1227IR	14 55	A31	A13 09.80-12.85	CS278	12 0.85
		09.80-12.85	CA126IR	14 45		09.80-12.85	CS123	12 0.8
		09.80-12.85	CA190IR	14 35				
		09.80-08.83	CA305IR	14 55				
		09.80-12.85	CA61IR	14 45				
	[GMA]	09.82-12.85	CA96IR	14 55				
		09.80-08.83	CA1227IR	14 55	A31	A13 09.80-08.83	CS278	12 0.85
		09.80-08.83	CA126IR	14 45		09.80-08.83	CS592	12 0.9
		09.80-08.83	CA190IR	14 35		09.80-08.83	CS123	12 0.8
		09.80-08.83	CA226IR	14 55				
	[GPA]	09.80-08.83	CA61IR	14 45				
		09.80-08.83	CA96IR	14 55				
		09.80-08.83	CA126IR	14 45		09.80-12.82	CS123	12 0.8
		09.80-08.83	CA226IR	14 55		09.80-08.83	CS278	12 0.85
09.80-08.83		CA61IR	14 45					
[GSE]	08.83-12.85	CA1227IR	14 55	A31	08.83-06.85	CS278	12 0.85	
	08.83-12.85	CA305IR	14 55		08.83-12.85	CS592	12 0.9	
	08.83-12.85	CA61IR	14 45		08.83-12.85	CS123	12 0.8	
	08.83-12.85	CA96IR	14 55					
[GSG]	10.85-07.90	CA226IR	14 55		A13 01.86-07.90	CS592	12 0.9	
	01.86-07.90	CA1227IR	14 55	A31	10.85-12.88	CS123	12 0.8	
	01.86-07.90	CA1554IR	14 70	A31	10.85-07.90	CS278	12 0.85	
	01.86-07.90	CA305IR	14 55					
	01.86-07.90	CA325IR	14 70					
Escort 1.1 1100	[G1]	01.68-12.74	CA15h#	14 28		01.68-02.76	CS78	12 0.75
		01.68-12.74	CA17h	14 34				
		01.75-08.80	CA190IR	14 35				
		01.75-08.80	CA96IR	14 55				
		RHD 01.68-12.74	CG50	14 22				
	[G2]	RHD 01.75-02.76	CA17v	14 34				
		06.68-12.74	CA15h#	14 28		06.70-02.76	CS78	12 0.75
		06.68-12.74	CA17h	14 34				
		01.75-08.80	CA190IR	14 35				
		01.75-08.80	CA96IR	14 55				
Escort 1.1 Express	[GLB]	03.81-12.85	CA126IR	14 45		03.81-12.85	CS123	12 0.8
		03.81-05.83	CA190IR	14 35		03.81-06.85	CS278	12 0.85
		03.81-12.85	CA61IR	14 45				
		09.82-12.85	CA96IR	14 55				
	[GSG]	05.86-07.90	CA1227IR	14 55	A31	A13 05.86-07.90	CS592	12 0.9
05.86-07.90	CA1554IR	14 70	A31	05.86-07.90	CS278	12 0.85		
05.86-07.90	CA226IR	14 55						
05.86-07.90	CA305IR	14 55						
Escort 1.3	[J1]	01.75-08.80	CA190IR	14 35		01.75-08.80	CS78	12 0.75
		01.75-08.80	CA61IR	14 45				
		01.75-08.80	CA96IR	14 55				
		RHD 01.75-08.80	CA17h	14 34				
		RHD 01.75-08.80	CA18h	14 43				
	[J1F]	12.74-08.80	CA190IR	14 35		12.74-08.80	CS78	12 0.75
		12.74-08.80	CA61IR	14 45				
		12.74-08.80	CA96IR	14 55				
		RHD 12.74-08.80	CA17h	14 34				
		RHD 12.74-08.80	CA18h	14 43				
	[J2]	12.74-08.80	CA190IR	14 35		12.74-08.80	CS78	12 0.75
		12.74-08.80	CA61IR	14 45				
		12.74-08.80	CA96IR	14 55				
		RHD 12.74-08.80	CA17h	14 34				
		RHD 12.74-08.80	CA18h	14 43				
	[J3]	12.74-08.80	CA190IR	14 35		12.74-08.80	CS78	12 0.75
		12.74-08.80	CA61IR	14 45				
		12.74-08.80	CA96IR	14 55				
		RHD 12.74-08.80	CA17h	14 34				
		RHD 12.74-08.80	CA18h	14 43				
	[J4B]	07.90-09.01	CA1227IR	14 55	A31	07.90-09.01	CS971	12 1.1
		07.90-09.01	CA305IR	14 55		07.90-09.01	CS592	12 0.9
		09.92-09.01	CA1554IR	14 70	A31	01.95-09.01	CS278	12 0.85
		09.92-09.01	CA325IR	14 70				
01.95-09.01		CA226IR	14 55					
[J6A]	02.95-02.99	CA1508IR	14 70					
	07.90-09.01	CA1227IR	14 55	A31	07.90-09.01	CS592	12 0.9	
	07.90-09.01	CA1554IR	14 70	A31	01.95-10.98	CS278	12 0.85	
	07.90-12.94	CA226IR	14 55					
	07.90-09.01	CA305IR	14 55					
[JBA]	07.90-09.01	CA325IR	14 70					
	07.88-10.90	CA1227IR	14 55	A31	07.88-10.90	CS592	12 0.9	
	07.88-10.90	CA1554IR	14 70	A31				
	07.88-10.90	CA305IR	14 55					
	07.88-10.90	CA325IR	14 70					



**FORD** Continued

	[JBB]	08.88- 07.90 CA1227IR 14 55 A31	08.88- 07.90 CS278 12 0.85
		08.88- 07.90 CA1554IR 14 70 A31	A13 08.88- 07.90 CS592 12 0.9
		08.88- 07.90 CA226IR 14 55	
		08.88- 07.90 CA305IR 14 55	
		08.88- 07.90 CA325IR 14 70	
	[JLA]	01.86- 07.90 CA1227IR 14 55 A31	A13 01.86- 07.90 CS592 12 0.9
		01.86- 07.90 CA1554IR 14 70 A31	01.86- 07.90 CS278 12 0.85
		01.86- 07.90 CA226IR 14 55	
		01.86- 07.90 CA305IR 14 55	
		01.86- 07.90 CA325IR 14 70	
	[JLB]	01.86- 07.90 CA1227IR 14 55 A31	A13 01.86- 07.90 CS592 12 0.9
		01.86- 07.90 CA1554IR 14 70 A31	01.86- 07.90 CS278 12 0.85
		01.86- 07.90 CA226IR 14 55	
		01.86- 07.90 CA305IR 14 55	
		01.86- 07.90 CA325IR 14 70	
	[JPA]	09.80- 05.83 CA126IR 14 45	A13 09.80- 12.85 CS278 12 0.85
		09.80- 05.83 CA190IR 14 35	09.80- 12.85 CS123 12 0.8
		09.80- 05.83 CA611R 14 45	
		01.82- 12.85 CA226IR 14 55	
		01.82- 12.85 CA96IR 14 55	
		11.86- 07.88 CA1227IR 14 55 A31	11.86- 07.88 CS278 12 0.85
		11.86- 07.88 CA305IR 14 55	11.86- 07.88 CS592 12 0.9
Escort 1.3 1300	[J1F]	09.73- 12.74 CA15h# 14 28	09.73- 02.76 CS78 12 0.75
		09.73- 12.74 CA17h 14 34	
		01.75- 02.76 CA190IR 14 35	
		01.75- 02.76 CA96IR 14 55	
	RHD	09.73- 12.74 CG50 14 22	
	RHD	01.75- 02.76 CA17v 14 34	
	[J2]	06.70- 12.74 CA15h# 14 28	06.70- 02.76 CS78 12 0.75
		06.70- 12.74 CA17h 14 34	
		01.75- 02.76 CA190IR 14 35	
		01.75- 02.76 CA96IR 14 55	
	RHD	06.70- 12.74 CG50 14 22	
	RHD	01.75- 02.76 CA17v 14 34	
	[J3D]	06.70- 12.74 CA15h# 14 28	06.70- 02.76 CS78 12 0.75
		06.70- 12.74 CA17h 14 34	
		01.75- 02.76 CA190IR 14 35	
		01.75- 02.76 CA96IR 14 55	
	RHD	06.70- 12.74 CG50 14 22	
	RHD	01.75- 02.76 CA17v 14 34	
Escort 1.3 Express	[JBA]	07.88- 07.90 CA1227IR 14 55 A31	07.88- 07.90 CS592 12 0.9
		07.88- 07.90 CA1554IR 14 70 A31	
		07.88- 07.90 CA305IR 14 55	
		07.88- 07.90 CA325IR 14 70	
	[JBB]	02.86- 07.92 CA1227IR 14 55 A31	02.86- 07.92 CS278 12 0.85
		02.86- 07.92 CA226IR 14 55	A13 02.86- 07.92 CS592 12 0.9
		02.86- 07.92 CA305IR 14 55	
		02.86- 07.92 CA325IR 14 70	
	[JBD]	07.90- 12.94 CA1227IR 14 55 A31	07.90- 12.94 CS592 12 0.9
		07.90- 12.94 CA1554IR 14 70 A31	
		07.90- 12.94 CA305IR 14 55	
		07.90- 12.94 CA325IR 14 70	
	[JLA]	02.86- 07.92 CA1227IR 14 55 A31	02.86- 07.92 CS278 12 0.85
		02.86- 07.92 CA226IR 14 55	A13 02.86- 07.92 CS592 12 0.9
		02.86- 07.92 CA305IR 14 55	
		02.86- 07.92 CA325IR 14 70	
	[JLB]	02.86- 07.92 CA1227IR 14 55 A31	02.86- 07.92 CS278 12 0.85
		02.86- 07.92 CA226IR 14 55	A13 02.86- 07.92 CS592 12 0.9
		02.86- 07.92 CA305IR 14 55	
		02.86- 07.92 CA325IR 14 70	
	[JPA]	03.81- 05.83 CA126IR 14 45	A34 03.81- 12.85 CS278 12 0.85
		03.81- 05.83 CA190IR 14 35	03.81- 12.85 CS123 12 0.8
		03.81- 05.83 CA611R 14 45	
		01.82- 12.85 CA226IR 14 55	
		01.82- 12.85 CA96IR 14 55	
Escort 1.4	[F4B]	01.94- 09.01 CA1227IR 14 55 A31	01.94- 09.01 CS592 12 0.9
		01.94- 09.01 CA1554IR 14 70 A31	02.94- 09.01 CS685 12 1.4
		01.94- 09.01 CA305IR 14 55	
		01.94- 09.01 CA325IR 14 70	
	PS	02.94- 09.01 CA1037IR 14 70	
	[F6B]	01.86- 07.90 CA1227IR 14 55 A31	A13 01.86- 07.90 CS592 12 0.9
		01.86- 07.90 CA1554IR 14 70 A31	01.86- 07.90 CS278 12 0.85
		01.86- 07.90 CA226IR 14 55	AT 01.86- 07.90 CS357 12 1.4
		01.86- 07.90 CA305IR 14 55	01.86- 07.90 CS123 12 0.8
		01.86- 07.90 CA325IR 14 70	
		01.86- 08.88 CA96IR 14 55	
	[F6D]	01.86- 07.90 CA1227IR 14 55 A31	01.86- 07.90 CS123 12 0.8
		01.86- 07.90 CA1554IR 14 70 A31	01.86- 07.90 CS278 12 0.85
		01.86- 07.90 CA226IR 14 55	A13 01.86- 07.90 CS592 12 0.9
		01.86- 07.90 CA305IR 14 55	AT 01.86- 07.90 CS357 12 1.4
		01.86- 07.90 CA325IR 14 70	
		01.86- 08.88 CA96IR 14 55	
	[F6F]	07.90- 12.94 CA1227IR 14 55 A31	07.90- 12.94 CS123 12 0.8
		07.90- 12.94 CA1554IR 14 70 A31	07.90- 12.94 CS592 12 0.9
		07.90- 12.94 CA305IR 14 55	
		07.90- 12.94 CA325IR 14 70	
	PS	07.90- 09.92 CA738IR 14 70	
	ACPS	07.90- 09.92 CA738IR 14 70	
	AC	07.90- 09.92 CA738IR 14 70	
	[F6G]	07.90- 12.94 CA1227IR 14 55 A31	07.90- 12.94 CS592 12 0.9
		07.90- 12.94 CA1554IR 14 70 A31	07.90- 12.94 CS123 12 0.8
		07.90- 12.94 CA305IR 14 55	
		07.90- 12.94 CA325IR 14 70	
	PS	07.90- 09.92 CA738IR 14 70	
	ACPS	07.90- 09.92 CA738IR 14 70	
	AC	07.90- 09.92 CA738IR 14 70	
	[FUA]	01.86- 07.90 CA1227IR 14 55 A31	01.86- 07.90 CS278 12 0.85
		01.86- 07.90 CA1554IR 14 70 A31	AT 01.86- 07.90 CS357 12 1.4
		01.86- 07.90 CA226IR 14 55	A13 01.86- 07.90 CS592 12 0.9
		01.86- 07.90 CA305IR 14 55	01.86- 07.90 CS123 12 0.8
		01.86- 07.90 CA325IR 14 70	
		01.86- 08.88 CA96IR 14 55	



	[FUC]	01.86- 07.90	CA1227IR	14 55	A31	A13 01.86- 07.90	CS592	12 0.9
		01.86- 07.90	CA1554IR	14 70	A31	AT 01.86- 07.90	CS357	12 1.4
		01.86- 07.90	CA226IR	14 55		01.86- 07.90	CS123	12 0.8
		01.86- 07.90	CA305IR	14 55		01.86- 07.90	CS278	12 0.85
		01.86- 07.90	CA325IR	14 70				
	[FUH]	07.90- 12.94	CA1227IR	14 55	A31	08.90- 12.94	CS685	12 1.4
		07.90- 12.94	CA1554IR	14 70	A31	08.90- 12.94	CS724	12 1.1
		07.90- 12.94	CA305IR	14 55		08.90- 12.94	CS123	12 0.8
		07.90- 12.94	CA325IR	14 70		08.90- 12.94	CS592	12 0.9
	[FUAA]	10.85- 10.90	CA1227IR	14 55	A31	AT 10.85- 10.90	CS357	12 1.4
		10.85- 10.90	CA1554IR	14 70	A31	A13 10.85- 10.90	CS592	12 0.9
		10.85- 10.90	CA305IR	14 55		10.85- 10.90	CS278	12 0.85
		10.85- 10.90	CA325IR	14 70				
		10.85- 10.90	CA1554IR	14 70		10.85- 10.90	CS592	12 0.9
	[F4B]	01.95- 01.95	CA305IR	14 55		01.95-	CS592	12 0.9
		PS 01.95-	CA1037IR	14 70				
		07.90- 12.94	CA1227IR	14 55	A31	07.90- 12.94	CS592	12 0.9
		07.90- 12.94	CA1554IR	14 70	A31	07.90- 12.94	CS123	12 0.8
		07.90- 12.94	CA305IR	14 55				
	[F6G]	07.90- 12.94	CA1227IR	14 55	A31	07.90- 12.94	CS123	12 0.8
		07.90- 12.94	CA1554IR	14 70	A31	07.90- 12.94	CS592	12 0.9
		07.90- 12.94	CA305IR	14 55				
		07.90- 12.94	CA325IR	14 70				
		ACPS 07.90- 09.92	CA738IR	14 70				
Escort 1.4 i	[F4B]	07.93- 01.95	CA1227IR	14 55	A31	07.93- 01.95	CS592	12 0.9
		07.93- 01.95	CA1554IR	14 70	A31			
		07.93- 01.95	CA305IR	14 55				
		07.93- 01.95	CA325IR	14 70				
Escort 1.4 i Express	[F6B]	01.86- 07.90	CA1227IR	14 55	A31	A13 01.86- 07.90	CS592	12 0.9
		01.86- 07.90	CA226IR	14 55		01.86- 07.90	CS278	12 0.85
		01.86- 07.90	CA305IR	14 55		AT 01.86- 07.90	CS357	12 1.4
		01.86- 07.90	CA325IR	14 70				
	[F6D]	01.86- 07.90	CA1227IR	14 55	A31	01.86- 07.90	CS278	12 0.85
		01.86- 07.90	CA226IR	14 55		AT 01.86- 07.90	CS357	12 1.4
		01.86- 07.90	CA305IR	14 55		A13 01.86- 07.90	CS592	12 0.9
		01.86- 07.90	CA325IR	14 70				
	[FUC]	01.86- 07.90	CA1227IR	14 55	A31	01.86- 07.90	CS278	12 0.85
		01.86- 07.90	CA226IR	14 55		A13 01.86- 07.90	CS592	12 0.9
01.86- 07.90		CA305IR	14 55		AT 01.86- 07.90	CS357	12 1.4	
01.86- 07.90		CA325IR	14 70					
Escort 1.6	[LGA]	09.80- 12.85	CA61IR	14 45		01.83- 12.85	CS357	12 1.4
		01.82- 05.83	CA126IR	14 45		A34 09.80- 12.85	CS278	12 0.85
		01.82- 05.83	CA190IR	14 35				
		01.82- 12.85	CA96IR	14 55				
	[LJF]	07.90- 12.92	CA1227IR	14 55	A31	07.90- 09.92	CS592	12 0.9
		07.90- 12.92	CA1554IR	14 70	A31			
		07.90- 12.92	CA305IR	14 55				
		07.90- 12.92	CA325IR	14 70				
		PS 07.90- 09.92	CA738IR	14 70				
	[LP1]	09.80- 05.83	CA126IR	14 45		09.80- 12.85	CS278	12 0.85
		09.80- 05.83	CA190IR	14 35		AT 01.83- 12.85	CS357	12 1.4
		09.80- 12.85	CA61IR	14 45		09.80- 12.85	CS123	12 0.8
		01.82- 12.85	CA226IR	14 55				
		01.82- 12.85	CA96IR	14 55				
	[LP2]	01.86- 07.90	CA1227IR	14 55	A31	AT 01.86- 07.90	CS357	12 1.4
		01.86- 07.90	CA1554IR	14 70	A31	01.86- 07.90	CS278	12 0.85
		01.86- 07.90	CA226IR	14 55		A13 01.86- 07.90	CS592	12 0.9
		01.86- 07.90	CA305IR	14 55				
		01.86- 07.90	CA325IR	14 70				
	[LPA]	09.80- 05.83	CA126IR	14 45		09.80- 12.85	CS123	12 0.8
09.80- 05.83		CA190IR	14 35		AT 01.83- 12.85	CS357	12 1.4	
09.80- 12.85		CA61IR	14 45		09.80- 12.85	CS278	12 0.85	
01.82- 12.85		CA226IR	14 55					
01.82- 12.85		CA96IR	14 55					
[LUA]	09.80- 05.83	CA126IR	14 45		09.80- 02.85	CS278	12 0.85	
	09.80- 05.83	CA190IR	14 35		09.80- 02.85	CS123	12 0.8	
	09.80- 02.85	CA61IR	14 45		AT 01.83- 02.85	CS357	12 1.4	
	01.82- 02.85	CA226IR	14 55					
	01.82- 02.85	CA96IR	14 55					
[LUG]	01.86- 07.90	CA1227IR	14 55	A31	01.86- 07.90	CS278	12 0.85	
	01.86- 07.90	CA226IR	14 55		AT 01.86- 07.90	CS357	12 1.4	
	01.86- 07.90	CA305IR	14 55		A13 01.86- 07.90	CS592	12 0.9	
	01.86- 07.90	CA325IR	14 70					
	01.86- 08.88	CA96IR	14 55					
	04.89- 07.90	CA1554IR	14 70	A31				
[LUJ]	07.90- 12.94	CA1227IR	14 55	A31	07.90- 12.94	CS592	12 0.9	
	07.90- 12.94	CA1554IR	14 70	A31				
	07.90- 12.94	CA305IR	14 55					
	07.90- 12.94	CA325IR	14 70					
	PS 07.90- 08.92	CA738IR	14 70					
[LUK]	07.90- 12.94	CA1227IR	14 55	A31	07.90- 12.94	CS592	12 0.9	
	07.90- 12.94	CA1554IR	14 70	A31				
	07.90- 12.94	CA305IR	14 55					
	07.90- 12.94	CA325IR	14 70					
	PS 07.90- 08.92	CA738IR	14 70					
Escort 1.6 RS	[LC]	12.74- 08.80	CA190IR	14 35		12.74- 08.80	CS78	12 0.75
		12.74- 08.80	CA96IR	14 55				
Escort 1.6 XR3i	[LR1]	10.82- 12.85	CA126IR	14 45		01.83- 12.85	CS357	12 1.4
		10.82- 12.85	CA226IR	14 55		10.82- 12.85	CS278	12 0.85
		10.82- 12.85	CA305IR	14 55		10.82- 12.85	CS123	12 0.8
		10.82- 12.85	CA96IR	14 55				
		01.86- 07.90	CA1227IR	14 55	A31	01.86- 08.89	CS592	12 0.9
	[LR2]	01.86- 07.90	CA1554IR	14 70	A31	AT 01.86- 07.90	CS357	12 1.4
		01.86- 07.90	CA226IR	14 55		01.86- 08.89	CS278	12 0.85
		01.86- 07.90	CA305IR	14 55				
		01.86- 07.90	CA325IR	14 70				
		01.86- 07.90	CA96IR	14 55				



FORD Continued

		01.86- 07.90 CA325IR	14 70				
		01.86- 08.88 CA96IR	14 55				
	[LRA]	10.82- 12.85 CA126IR	14 45		10.82- 12.85 CS123	12 0.8	
		10.82- 12.85 CA226IR	14 55		10.82- 12.85 CS278	12 0.85	
		10.82- 12.85 CA305IR	14 55		01.83- 12.85 CS357	12 1.4	
		10.82- 12.85 CA96IR	14 55				
	[LRB]	01.86- 07.90 CA1227IR	14 55 A31		AT 01.86- 07.90 CS357	12 1.4	
		01.86- 07.90 CA1554IR	14 70 A31		01.86- 08.89 CS278	12 0.85	
		01.86- 07.90 CA226IR	14 55		01.86- 08.89 CS592	12 0.9	
		01.86- 07.90 CA305IR	14 55				
		01.86- 07.90 CA325IR	14 70				
		01.86- 08.88 CA96IR	14 55				
Escort 1.6 16V	[L1E]	02.95- 02.99 CA738IR	14 70		02.95- 07.00 CS719	12 1.4	
		02.95- 07.00 CA739IR	14 90				
		PS 02.95- 07.00 CA1037IR	14 70				
Escort 1.6 16V 4x4	[L1E]	02.95- 10.98 CA738IR	14 70		02.95- 10.98 CS719	12 1.4	
		02.95- 10.98 CA739IR	14 90				
		PS 02.95- 10.98 CA1037IR	14 70				
Escort 1.6 16V XR3i	[L1E]	02.93- 01.95 CA1227IR	14 55 A31		02.95- 09.01 CS719	12 1.4	
		02.93- 01.95 CA1554IR	14 70 A31		02.93- 01.95 CS724	12 1.1	
		02.93- 01.95 CA305IR	14 55				
		02.93- 01.95 CA325IR	14 70				
		02.93- 09.01 CA738IR	14 70				
		02.93- 09.01 CA739IR	14 90				
		PS 02.93- 01.95 CA1032IR	14 70				
		PS 02.95- 09.01 CA1037IR	14 70				
		ACPS 02.95- 09.01 CA1037IR	14 70				
		AC 02.95- 09.01 CA1037IR	14 70				
	[L1H]	02.95- 12.96 CA738IR	14 70		02.95- 12.96 CS719	12 1.4	
		02.95- 12.96 CA739IR	14 90				
		PS 02.95- 12.96 CA1037IR	14 70				
Escort 1.6 i 16V	[L1E]	09.92- 01.95 CA1227IR	14 55 A31		09.92- 01.95 CS685	12 1.4	
		09.92- 01.95 CA1554IR	14 70 A31		09.92- 01.95 CS724	12 1.1	
		09.92- 01.95 CA305IR	14 55				
		09.92- 01.95 CA325IR	14 70				
		09.92- 01.95 CA738IR	14 70				
		09.92- 01.95 CA739IR	14 90				
		PS 09.92- 01.95 CA1032IR	14 70				
	[L1H]	09.92- 01.95 CA1227IR	14 55 A31		09.92- 01.95 CS685	12 1.4	
		09.92- 01.95 CA1554IR	14 70 A31		09.92- 01.95 CS724	12 1.1	
		09.92- 01.95 CA305IR	14 55		01.95- 08.95 CS719	12 1.4	
		09.92- 01.95 CA325IR	14 70				
		09.92- 01.95 CA738IR	14 70				
		01.94- 08.95 CA739IR	14 90				
		PS 09.92- 01.95 CA1032IR	14 70				
		PS 01.95- 08.95 CA1037IR	14 70				
Escort 1.6 i	[L1E]	09.92- 01.95 CA1037IR	14 70		02.95- 09.01 CS719	12 1.4	
		09.92- 09.01 CA738IR	14 70		09.92- 01.95 CS724	12 1.1	
		09.92- 09.01 CA739IR	14 90				
		PS 02.95- 09.01 CA1037IR	14 70				
	[L1K]	08.93- 01.95 CA1554IR	14 70 A31		08.93- 02.99 CS685	12 1.4	
		08.93- 01.95 CA305IR	14 55		08.93- 09.01 CS719	12 1.4	
		08.93- 09.01 CA739IR	14 90				
		07.94- 01.95 CA1037IR	14 70				
		02.95- 09.01 CA738IR	14 70				
		PS 02.95- 09.01 CA1037IR	14 70				
	[L4B]	07.85- 12.85 CA126IR	14 45		AT 07.85- 07.90 CS357	12 1.4	
		07.85- 07.90 CA226IR	14 55		01.86- 05.90 CS592	12 0.9	
		07.85- 12.85 CA611R	14 45		07.85- 12.86 CS278	12 0.85	
		07.85- 08.88 CA96IR	14 55				
		01.86- 07.90 CA1227IR	14 55 A31				
		01.86- 07.90 CA1554IR	14 70 A31				
		01.86- 07.90 CA305IR	14 55				
		01.86- 07.90 CA325IR	14 70				
	[LJB]	08.89- 07.90 CA1227IR	14 55 A31		08.89- 07.90 CS357	12 1.4	
		08.89- 07.90 CA1554IR	14 70 A31				
		08.89- 07.90 CA226IR	14 55				
		08.89- 07.90 CA305IR	14 55				
		08.89- 07.90 CA325IR	14 70				
	[LR1]	09.83- 12.85 CA126IR	14 45		09.83- 12.85 CS278	12 0.85	
		09.83- 12.85 CA226IR	14 55		09.83- 12.85 CS357	12 1.4	
		09.83- 12.85 CA611R	14 45				
		09.83- 12.85 CA96IR	14 55				
	[LRA]	09.83- 12.85 CA126IR	14 45		09.83- 12.85 CS357	12 1.4	
		09.83- 12.85 CA226IR	14 55		09.83- 12.85 CS278	12 0.85	
		09.83- 12.85 CA611R	14 45				
		09.83- 12.85 CA96IR	14 55				
Escort 1.6 i 1600 RS	[LUAE]	05.82- 05.83 CA126IR	14 45		05.82- 12.85 CS278	12 0.85	
		05.82- 12.85 CA226IR	14 55				
		05.82- 12.85 CA96IR	14 55				
Escort 1.6 Turbo RS	[LNA]	11.84- 12.85 CA226IR	14 55		11.84- 12.85 CS278	12 0.85	
		11.84- 12.85 CA305IR	14 55				
	[LNB]	01.86- 07.90 CA1227IR	14 55 A31		01.86- 07.90 CS592	12 0.9	
		01.86- 07.90 CA1554IR	14 70 A31		AT 01.86- 07.90 CS357	12 1.4	
		01.86- 07.90 CA226IR	14 55		01.86- 07.90 CS278	12 0.85	
		01.86- 07.90 CA305IR	14 55				
		01.86- 07.90 CA325IR	14 70				
		01.86- 08.88 CA96IR	14 55				
Escort 1.6 Diesel	[LTA]	02.84- 12.85 CA306IR	14 55		02.84- 12.85 CS341	12 1.7	
		02.84- 12.85 CA650IR	14 70				
	[LTC]	01.86- 01.89 CA306IR	14 55		01.86- 01.89 CS341	12 1.7	
		01.86- 01.89 CA650IR	14 70				
		10.87- 08.88 CA560IR	14 70				
Escort 1.6 Diesel Express	[LTA]	02.84- 12.85 CA306IR	14 55		04.84- 12.85 CS341	12 1.7	
		02.84- 12.85 CA650IR	14 70				
Escort 1.8 16V	[RDA]	02.92- 08.95 CA738IR	14 70		02.92- 12.94 CS724	12 1.1	
		02.92- 08.95 CA739IR	14 90		02.92- 12.94 CS685	12 1.4	
		PS 09.92- 12.94 CA1032IR	14 70		01.95- 08.95 CS719	12 1.4	
		PS 01.95- 08.95 CA1037IR	14 70				
	[RKC]	01.95- 02.99 CA738IR	14 70		01.95- 02.99 CS719	12 1.4	
		01.95- 02.99 CA739IR	14 90				
		PS 01.95- 02.99 CA1037IR	14 70				



Escort 1.8 16V XR3i	[RDA]	02.92- 12.94	CA738IR	14 70	10.95-	CS719	12 1.4	
		02.92- 12.94	CA739IR	14 90	02.92- 12.94	CS685	12 1.4	
		PS 02.92- 12.94	CA1032IR	14 70	02.92- 12.94	CS724	12 1.1	
		PS 10.95-	CA1037IR	14 70				
	[RKC]	01.95- 08.98	CA738IR	14 70	01.95- 08.98	CS719	12 1.4	
		01.95- 08.98	CA739IR	14 90				
		PS 01.95- 08.98	CA1037IR	14 70				
	[RQB]	02.92- 08.00	CA738IR	14 70	02.92- 08.00	CS724	12 1.1	
		02.92- 08.00	CA739IR	14 90	02.92- 08.00	CS685	12 1.4	
		PS 02.92- 01.95	CA1032IR	14 70				
PS 01.95- 08.00		CA1037IR	14 70					
AC 09.92- 01.95		CA1032IR	14 70					
02.93- 01.95		CA739IR	14 90	02.93- 01.95	CS724	12 1.1		
Escort 1.8 16V XR3i 4x4	[RDA]	08.93- 01.95	CA738IR	14 70	08.93- 01.95	CS724	12 1.1	
		08.93- 01.95	CA739IR	14 90	08.93- 01.95	CS685	12 1.4	
		PS 08.93- 01.95	CA1032IR	14 70				
	[RQB]	08.93- 01.95	CA738IR	14 70	08.93- 01.95	CS724	12 1.1	
		08.93- 01.95	CA739IR	14 90	08.93- 01.95	CS685	12 1.4	
		PS 08.93- 01.95	CA1032IR	14 70				
	Escort 1.8 i 16V	[RDA]	09.92- 01.95	CA738IR	14 70	09.92- 01.95	CS724	12 1.1
			09.92- 01.95	CA739IR	14 90	09.92- 01.95	CS685	12 1.4
			PS 09.92- 01.95	CA1032IR	14 70			
		[RQB]	02.93- 01.95	CA738IR	14 70	02.93- 01.95	CS685	12 1.4
02.93- 01.95			CA739IR	14 90	02.93- 01.95	CS724	12 1.1	
PS 02.93- 01.95			CA1032IR	14 70				
Escort 1.8 Diesel	[RFD]	02.93- 01.95	CA561IR	14 55	02.93- 01.95	CS341	12 1.7	
		02.93- 01.95	CA856IR	14 70	02.93- 01.95	CS613	12 2.2	
		02.93- 01.95	CA561IR	14 55	02.93- 01.95	CS613	12 2.2	
	[RFK]	02.93- 01.95	CA856IR	14 70	02.93- 01.95	CS341	12 1.7	
		02.93- 01.95	CA561IR	14 55	02.93- 01.95	CS341	12 1.7	
		02.93- 01.95	CA856IR	14 70	02.93- 01.95	CS341	12 1.7	
	[RTA]	01.89- 07.90	CA306IR	14 55	01.89- 07.90	CS341	12 1.7	
		01.89- 07.90	CA561IR	14 55	A13 01.89- 07.90	CS613	12 2.2	
		01.89- 07.90	CA650IR	14 70				
		01.89- 07.90	CA717IR	14 70				
		RHD 01.89- 07.90	CA561IR	14 55				
	[RTB]	01.89- 07.90	CA306IR	14 55	01.89- 07.90	CS341	12 1.7	
		01.89- 07.90	CA561IR	14 55	A13 01.89- 07.90	CS613	12 2.2	
		01.89- 07.90	CA650IR	14 70				
		01.89- 07.90	CA717IR	14 70				
		RHD 01.89- 07.90	CA561IR	14 55				
	[RTE]	07.90- 12.94	CA306IR	14 55	07.90- 12.94	CS341	12 1.7	
		07.90- 12.94	CA561IR	14 55	07.90- 12.94	CS613	12 2.2	
		07.90- 12.94	CA650IR	14 70				
		01.95- 12.95	CA717IR	14 70				
[RTF]	07.90- 12.94	CA306IR	14 55	07.90- 02.99	CS341	12 1.7		
	07.90- 02.99	CA561IR	14 55	07.90- 02.99	CS613	12 2.2		
	07.90- 12.94	CA650IR	14 70					
	01.95- 02.99	CA717IR	14 70					
	PS 01.95- 02.99	CA1083IR	14 70					
	PS 01.95- 02.99	CA1217IR	14 70					
[RTH]	AC 01.95- 02.99	CA1083IR	14 70					
	07.90- 01.95	CA306IR	14 55	07.90- 12.95	CS341	12 1.7		
	07.90- 12.95	CA561IR	14 55	07.90- 12.95	CS613	12 2.2		
	07.90- 01.95	CA650IR	14 70					
	01.95- 12.95	CA717IR	14 70					
Escort 1.8 Diesel Express	[RTF]	01.95-	CA1083IR	14 70	01.95-	CS341	12 1.7	
		01.95-	CA561IR	14 55	01.95-	CS613	12 2.2	
		01.95-	CA717IR	14 70				
		01.95-	CA856IR	14 70				
	[RTH]	07.90- 12.94	CA306IR	14 55	07.90- 12.94	CS613	12 2.2	
		07.90- 12.94	CA561IR	14 55	07.90- 12.94	CS341	12 1.7	
		07.90- 12.94	CA650IR	14 70				
		01.95-	CA1083IR	14 70				
		01.95-	CA717IR	14 70				
		01.95-	CA856IR	14 70				
Escort 1.8 TD	[RFD]	02.93- 09.01	CA1083IR	14 70	02.93- 09.01	CS341	12 1.7	
		02.93- 09.01	CA561IR	14 55	02.93- 09.01	CS613	12 2.2	
		08.93- 09.01	CA717IR	14 70				
		08.93- 09.01	CA856IR	14 70				
		PS 01.95- 09.01	CA856IR	14 70				
		PS 01.97- 09.01	CA1217IR	14 70				
	[RFK]	AC 01.95- 09.01	CA856IR	14 70				
		02.93- 09.01	CA1083IR	14 70	02.93- 09.01	CS613	12 2.2	
		02.93- 09.01	CA561IR	14 55	02.93- 09.01	CS341	12 1.7	
		08.93- 09.01	CA717IR	14 70				
		08.93- 09.01	CA856IR	14 70				
		PS 01.95- 09.01	CA1217IR	14 70				
	[RFS]	PS 01.95- 09.01	CA856IR	14 70				
		AC 01.95- 09.01	CA856IR	14 70				
		02.93- 01.95	CA561IR	14 55	02.93- 01.95	CS341	12 1.7	
		PS 02.93- 01.95	CA1083IR	14 70	02.93- 01.95	CS613	12 2.2	
	[RVA]	AC 02.93- 01.95	CA1083IR	14 70				
		01.95- 09.99	CA1083IR	14 70	01.95- 09.01	CS613	12 2.2	
		01.95- 08.99	CA561IR	14 55	01.95- 09.01	CS341	12 1.7	
		PS 01.97- 09.01	CA1217IR	14 70				
AC 10.99- 09.01		CA856IR	14 70					
05.91- 12.92		CA1083IR	14 70	05.91- 12.92	CS613	12 2.2		
Escort 1.8 TD Express	[RVA]	05.91- 12.92	CA561IR	14 55	05.91- 12.92	CS341	12 1.7	
		12.95- 06.01	CA717IR	14 70	12.95- 10.98	CS341	12 1.7	
		PS 12.95- 06.01	CA1083IR	14 70	12.95- 06.01	CS613	12 2.2	
		PS 01.97- 06.01	CA1217IR	14 70				
		AC 12.95- 06.01	CA1083IR	14 70				
Escort 2.0 RS	[NE]	03.73- 08.80	CA60IR	14 45	03.73- 08.80	CS86	12 1.0	
		03.73- 08.80	CA94IR	14 55				
Escort 2.0 RS 2000	[N7A]	09.92- 02.98	CA1691IR	14 70	09.92- 02.98	CS357	12 1.4	
		09.92- 02.98	CA325IR	14 70				
Escort 2.0 RS 2000 4x4	[N7A]	08.93- 10.98	CA1691IR	14 70	01.95- 10.98	CS357	12 1.4	
		08.93- 10.98	CA325IR	14 70	08.93- 01.95	CS787	12 1.4	
Escort 2.0 16V RS 2000	[N7A]	05.91- 12.92	CA1691IR	14 70	05.91- 12.94	CS357	12 1.4	
		05.91- 12.94	CA325IR	14 70				
Escort 2.0 16V RS Cosworth 4x4	[N5F]	02.95- 10.98	CA299IR	14 70	02.95- 10.98	CS357	12 1.4	
Escort 2.0 16V RS Cosworth 4x4	[N5F]				04.92- 01.95	CS357	12 1.4	
					04.92- 01.95	CS787	12 1.4	



**FORD** *Continued*

Explorer 4.0 V6		01.93-	UA963IR	14 130		01.93-	US1028	12 1.4
Fiesta 0.9	[TKW]	05.76- 08.83	CA126IR	14 45		05.76- 08.83	CS123	12 0.8
		05.76- 08.83	CA611R	14 45				
		05.76- 08.83	CA961R	14 55				
Fiesta 1.0	[TKA]	05.76- 08.83	CA126IR	14 45		05.76- 11.86	CS123	12 0.8
		05.76- 08.83	CA611R	14 45				
		05.76- 08.83	CA961R	14 55				
		10.77- 11.86	CA226IR	14 55				
	[TKB]	08.83- 11.89	CA1227IR	14 55 A31		08.83- 11.89	CS278	12 0.85
		08.83- 11.89	CA305IR	14 55		08.83- 11.89	CS123	12 0.8
		09.83- 02.89	CA226IR	14 55		A13 08.83- 11.89	CS592	12 0.9
	[TLA]	05.76- 08.83	CA126IR	14 45		05.76- 08.83	CS123	12 0.8
		05.76- 08.83	CA611R	14 45				
		05.76- 08.83	CA961R	14 55				
	[TLB]	03.89- 12.95	CA1227IR	14 55 A31		03.89- 12.95	CS592	12 0.9
		03.89- 12.95	CA1554IR	14 70 A31		03.89- 12.95	CS123	12 0.8
		03.89- 12.95	CA305IR	14 55				
		03.89- 12.95	CA325IR	14 70				
Fiesta 1.0 i	[C4A]	02.97- 08.98	CA1087IR	14 70				
Fiesta 1.1	[G6A]	03.89- 12.95	CA1227IR	14 55 A31		03.89- 12.95	CS592	12 0.9
		03.89- 12.95	CA1554IR	14 70 A31		03.89- 12.95	CS278	12 0.85
		03.89- 12.95	CA305IR	14 55				
		03.89- 12.95	CA325IR	14 70				
	[GL1]	10.77- 08.83	CA126IR	14 45		10.77- 11.86	CS278	12 0.85
		10.77- 11.86	CA226IR	14 55		10.77- 11.86	CS123	12 0.8
		10.77- 08.83	CA611R	14 45				
		10.77- 08.83	CA961R	14 55				
	[GLA]	05.76- 08.83	CA126IR	14 45		05.76- 08.83	CS123	12 0.8
		05.76- 08.83	CA611R	14 45				
		05.76- 08.83	CA961R	14 55				
	[GLC]	09.83- 02.89	CA1227IR	14 55 A31		09.83- 02.89	CS278	12 0.85
		09.83- 02.89	CA226IR	14 55		A13 09.83- 02.89	CS592	12 0.9
		09.83- 02.89	CA305IR	14 55		09.83- 02.89	CS123	12 0.8
	[GLW]	08.81- 08.83	CA126IR	14 45		08.81- 08.83	CS123	12 0.8
		08.81- 08.83	CA611R	14 45				
		08.81- 08.83	CA961R	14 55				
	[GSF]	09.83- 02.89	CA1227IR	14 55 A31		09.83- 02.89	CS278	12 0.85
		09.83- 02.89	CA226IR	14 55		A13 09.83- 02.89	CS592	12 0.9
		09.83- 02.89	CA305IR	14 55		09.83- 02.89	CS123	12 0.8
	[GSH]	05.86- 02.89	CA1227IR	14 55 A31		A13 05.86- 02.89	CS592	12 0.9
		05.86- 02.89	CA226IR	14 55		05.86- 02.89	CS278	12 0.85
		05.86- 02.89	CA305IR	14 55				
	[GUD]	03.89- 12.95	CA1227IR	14 55 A31		03.89- 12.95	CS278	12 0.85
		03.89- 12.95	CA1554IR	14 70 A31		03.89- 12.95	CS592	12 0.9
		03.89- 12.95	CA305IR	14 55				
		03.89- 12.95	CA325IR	14 70				
	[GUE]	03.89- 12.95	CA1227IR	14 55 A31		03.89- 12.95	CS592	12 0.9
		03.89- 12.95	CA1554IR	14 70 A31		03.89- 12.95	CS278	12 0.85
		03.89- 12.95	CA305IR	14 55				
		03.89- 12.95	CA325IR	14 70				
Fiesta 1.2	[SNJA]	10.08-	CA2044IR*	14 120		10.08-	CS1050	12 1.1
	[STJA]	10.08-	CA2044IR*	14 120		10.08-	CS1050	12 1.1
Fiesta 1.2 16V	[FUJA]	12.02-	CA1737IR	14 70		12.02-	CS1050	12 1.1
		12.02-	CA1780IR	14 90				
	[FUJB]	12.02-	CA1737IR	14 70		12.02-	CS1050	12 1.1
		12.02-	CA1780IR	14 90				
	[M7JA]	12.02-	CA1737IR	14 70		12.02-	CS1050	12 1.1
		12.02-	CA1780IR	14 90				
	[M7JB]	12.02-	CA1737IR	14 70		12.02-	CS1050	12 1.1
		12.02-	CA1780IR	14 90				
Fiesta 1.2 i 16V	[DHA]	08.95- 07.98	CA1137IR	14 70		10.95- 01.02	CS960	12 0.9
		08.98- 01.02	CA1474IR	14 70		10.95- 01.02	CS1050	12 1.1
	[DHB]	08.95- 07.98	CA1137IR	14 70		10.98- 01.02	CS1050	12 1.1
		08.98- 01.02	CA1474IR	14 70		10.98- 01.02	CS960	12 0.9
	[DHC]	08.95- 07.98	CA1137IR	14 70		11.95- 01.02	CS960	12 0.9
		08.98- 01.02	CA1474IR	14 70		11.95- 01.02	CS1050	12 1.1
	[DHD]	08.95- 07.98	CA1137IR	14 70		08.95- 01.02	CS1050	12 1.1
		08.98- 01.02	CA1474IR	14 70		08.95- 01.02	CS960	12 0.9
	[DHE]	02.00- 01.02	CA1474IR	14 70		02.00- 01.02	CS960	12 0.9
						02.00- 01.02	CS1050	12 1.1
	[DHF]	02.00- 01.02	CA1474IR	14 70		02.00- 01.02	CS960	12 0.9
						02.00- 01.02	CS1050	12 1.1
	[DHG]	02.00- 01.02	CA1474IR	14 70		02.00- 01.02	CS960	12 0.9
						02.00- 01.02	CS1050	12 1.1
Fiesta 1.3	[A9JA]	11.01-	CA2034IR	14 90		11.01-	CS1289	12 1.1
	[A9JB]	11.01-	CA2034IR	14 90		11.01-	CS1289	12 1.1
	[BAJA]	11.01-	CA2034IR	14 90		11.01-	CS1289	12 1.1
	[J3E]	08.77- 08.83	CA126IR	14 45		08.77- 08.83	CS123	12 0.8
		08.77- 08.83	CA226IR	14 55				
		10.81- 08.83	CA305IR	14 55				
	[J4C]	01.98- 12.02	CA1552IR	14 70		02.96- 12.02	CS971	12 1.1
	PS	02.96- 12.02	CA1087IR	14 70				
	[J6B]	05.91- 01.97	CA1227IR	14 55 A31		05.91- 01.97	CS592	12 0.9
		05.91- 01.97	CA1554IR	14 70 A31				
		05.91- 01.97	CA305IR	14 55				
		05.91- 01.97	CA325IR	14 70				
	[JBC]	03.89- 12.92	CA1554IR	14 70 A31		03.89- 12.95	CS592	12 0.9
		03.89- 12.92	CA325IR	14 70				
		06.91- 12.95	CA1227IR	14 55 A31				
		06.91- 12.95	CA305IR	14 55				
	[JPC]	09.83- 01.87	CA226IR	14 55		09.83- 01.87	CS278	12 0.85
		09.83- 01.87	CA305IR	14 55		A13 01.86- 01.87	CS592	12 0.9
		09.83- 01.87	CA325IR	14 70		09.83- 01.87	CS123	12 0.8
		09.83- 01.87	CA961R	14 55				
	RHD	02.84- 01.87	CA306IR	14 55				
	RHD	02.84- 01.87	CA650IR	14 70				
		03.89- 12.95	CA325IR	14 70		03.89- 12.95	CS592	12 0.9
		03.89- 12.95	CA305IR	14 55				
		03.89- 12.95	CA1554IR	14 70 A31				
		03.89- 12.95	CA1227IR	14 55 A31				





Fiesta 1.3 i	[J4C]	08.95- 01.02	CA1227IR	14 55	A31	08.95- 01.02	CS971	12 1.1	
		01.98- 01.02	CA1552IR	14 70	▲				
		PS 03.00- 01.02	CA1087IR	14 70					
		AC 08.95- 02.00	CA1087IR	14 70					
			AC 09.96- 04.00	CA1145IR	14 90				
	[J4J]	08.95- 01.02	CA1227IR	14 55	A31	08.95- 01.02	CS986	12 1.1	
		10.98- 01.02	CA1552IR	14 70	▲				
		PS 03.00- 01.02	CA1087IR	14 70					
		AC 08.95- 02.00	CA1087IR	14 70					
			AC 09.96- 04.00	CA1145IR	14 90				
	[J4L]	08.95- 01.02	CA1227IR	14 55	A31	08.95- 01.02	CS971	12 1.1	
		01.98- 01.02	CA1552IR	14 70	▲				
		PS 03.00- 01.02	CA1087IR	14 70					
		AC 08.95- 02.00	CA1087IR	14 70					
			AC 09.96- 04.00	CA1145IR	14 90				
	[J4Q]	08.95- 01.02	CA1227IR	14 55	A31	08.95- 01.02	CS971	12 1.1	
		01.98- 01.02	CA1552IR	14 70	▲				
		PS 03.00- 01.02	CA1087IR	14 70					
		AC 08.95- 02.00	CA1087IR	14 70					
			AC 09.96- 04.00	CA1145IR	14 90				
	[J4R]	08.95- 01.02	CA1227IR	14 55	A31	08.95- 01.02	CS971	12 1.1	
		01.98- 01.02	CA1552IR	14 70	▲				
		PS 03.00- 01.02	CA1087IR	14 70					
		AC 08.95- 02.00	CA1087IR	14 70					
		AC 09.96- 04.00	CA1145IR	14 90					
[J4T]	08.95- 01.02	CA1227IR	14 55	A31	08.95- 01.02	CS971	12 1.1		
	01.98- 01.02	CA1552IR	14 70	▲					
	PS 03.00- 01.02	CA1087IR	14 70						
	AC 08.95- 02.00	CA1087IR	14 70						
		AC 09.96- 04.00	CA1145IR	14 90					
[JJA]	08.95- 01.02	CA1227IR	14 55	A31	08.95- 01.02	CS971	12 1.1		
	01.98- 01.02	CA1552IR	14 70	▲					
	PS 03.00- 01.02	CA1087IR	14 70						
	AC 01.96- 02.00	CA1087IR	14 70						
		AC 09.96- 04.44	CA1145IR	14 90					
[JJC]	08.95- 01.02	CA1227IR	14 55	A31	08.95- 01.02	CS971	12 1.1		
	10.98- 01.02	CA1552IR	14 70	▲					
	PS 10.98- 03.00	CA1087IR	14 70						
	AC 09.96- 04.00	CA1145IR	14 90						
		AC 10.98- 02.00	CA1087IR	14 70					
[JJE]	08.95- 01.02	CA1227IR	14 55	A31	08.95- 02.01	CS971	12 1.1		
	01.98- 01.02	CA1552IR	14 70	▲					
	PS 03.00- 01.02	CA1087IR	14 70						
	AC 08.95- 02.00	CA1087IR	14 70						
		AC 09.96- 04.00	CA1145IR	14 90					
[JJJ]	08.95- 01.02	CA1227IR	14 55	A31	08.95- 02.01	CS971	12 1.1		
	01.98- 01.02	CA1552IR	14 70	▲					
	PS 03.00- 01.02	CA1087IR	14 70						
	AC 08.95- 02.00	CA1087IR	14 70						
		AC 09.96- 04.00	CA1145IR	14 90					
[JJK]	08.95- 01.02	CA1227IR	14 55	A31	08.95- 01.02	CS971	12 1.1		
	01.98- 01.02	CA1552IR	14 70	▲					
	PS 03.00- 01.02	CA1087IR	14 70						
	AC 08.95- 02.00	CA1087IR	14 70						
		AC 09.96- 04.00	CA1145IR	14 90					
[JJM]	08.95- 01.02	CA1227IR	14 55	A31	08.95- 01.02	CS971	12 1.1		
	01.98- 01.02	CA1552IR	14 70	▲					
	PS 03.00- 01.02	CA1087IR	14 70						
	AC 08.95- 02.00	CA1087IR	14 70						
		AC 09.96- 04.00	CA1145IR	14 90					
Fiesta 1.4	[F4A]	01.94- 12.96	CA306IR	14 55		01.94- 12.96	CS724	12 1.1	
		01.94- 12.96	CA560IR	14 70		01.94- 12.96	CS592	12 0.9	
	[F6A]	10.86- 02.89	CA305IR	14 55		10.86- 02.89	CS123	12 0.8	
		10.86- 02.89	CA325IR	14 70		10.86- 02.89	CS278	12 0.85	
		RHD 10.86- 02.89	CA306IR	14 55		AT 10.86- 02.89	CS357	12 1.4	
		RHD 10.86- 02.89	CA650IR	14 70		A13 10.86- 02.89	CS592	12 0.9	
	[F6C]	10.86- 02.89	CA305IR	14 55		AT 10.86- 02.89	CS357	12 1.4	
		10.86- 02.89	CA325IR	14 70		10.86- 02.89	CS123	12 0.8	
		RHD 10.86- 02.89	CA306IR	14 55		A13 10.86- 02.89	CS592	12 0.9	
		RHD 10.86- 02.89	CA650IR	14 70		10.86- 02.89	CS278	12 0.85	
	[F6E]	03.89- 12.95	CA306IR	14 55		11.91- 12.95	CS724	12 1.1	
		03.89- 12.95	CA560IR	14 70		03.89- 12.95	CS592	12 0.9	
	[FUB]	09.83- 02.89	CA305IR	14 55		09.83- 02.89	CS123	12 0.8	
		09.83- 02.89	CA325IR	14 70		AT 01.86- 02.89	CS357	12 1.4	
		09.83- 01.87	CA96IR	14 55		A13 01.86- 02.89	CS592	12 0.9	
		RHD 09.83- 02.89	CA306IR	14 55		09.83- 02.89	CS278	12 0.85	
		RHD 09.83- 02.89	CA650IR	14 70					
	[FUBA]	09.83- 01.87	CA1554IR	14 70	A31	09.83- 01.87	CS724	12 1.1	
		09.83- 01.87	CA306IR	14 55		09.83- 01.87	CS278	12 0.85	
		09.83- 01.87	CA325IR	14 70					
	[FUD]	02.87- 02.89	CA305IR	14 55		A13 02.87- 02.89	CS592	12 0.9	
		02.87- 02.89	CA325IR	14 70		AT 02.87- 02.89	CS357	12 1.4	
		02.87- 02.89	CA96IR	14 55		02.87- 02.89	CS123	12 0.8	
		RHD 02.87- 02.89	CA306IR	14 55		02.87- 02.89	CS278	12 0.85	
	RHD 02.87- 02.89	CA650IR	14 70						
[FUG]	03.89- 12.95	CA306IR	14 55		03.89- 12.95	CS592	12 0.9		
	03.89- 12.95	CA560IR	14 70		11.91- 12.95	CS724	12 1.1		
[FUJ]	03.89- 12.95	CA306IR	14 55		03.89- 12.95	CS592	12 0.9		
	03.89- 12.95	CA560IR	14 70		11.91- 12.95	CS724	12 1.1		
		RHD 09.86- 09.89	CA650IR	14 70	10.08-	CS1050	12 1.1		
		09.86- 09.89	CA325IR	14 70	AT 09.86- 09.89	CS357	12 1.4		
		RHD 09.86- 09.89	CA306IR	14 55	09.86- 09.89	CS278	12 0.85		
		09.86- 09.89	CA305IR	14 55	09.86- 09.89	CS123	12 0.8		
		10.08-	CA2044IR*	14 120					
Fiesta 1.4 i 16V	[FHA]	10.95- 08.98	CA1137IR	14 70		10.95- 12.00	CS960	12 0.9	
		08.98- 12.00	CA1474IR	14 70		10.95- 12.00	CS1050	12 1.1	
[FHE]	04.96- 08.98	CA1137IR	14 70		04.96- 12.00	CS960	12 0.9		
	08.98- 12.00	CA1474IR	14 70		04.96- 12.00	CS1050	12 1.1		
[FXJA]	11.01-	CA1737IR	14 70		11.01-	CS1050	12 1.1		
	AC 11.01-	CA1780IR	14 90						
[FXJB]	11.01-	CA1737IR	14 70		11.01-	CS1050	12 1.1		
	AC 11.01-	CA1780IR	14 90						
Fiesta 1.4 i	[FHA]	04.96- 08.98	CA1137IR	14 70		04.96- 10.99	CS960	12 0.9	
		08.98- 10.99	CA1474IR	14 70		04.96- 10.99	CS1050	12 1.1	



**FORD** *Continued*

Fiesta 1.4 LPG		01.09-	CA2044IR*	14 120	01.09-	CS1050	12 1.1
Fiesta 1.4 TDCi	[F6JA]	11.01-	CA1777IR	14 80	11.01-	CS1275	12 1.4
		A19 11.01-	CA1778IR	14 150			
	[F6JB]	11.01-	CA1777IR	14 80	11.01-	CS1275	12 1.4
		A19 11.01-	CA1778IR	14 150			
	[F6JD]	07.10-	CA2091IR*	14 120	07.10-	CS1275	12 1.4
		A19 07.10-	CA1970IR	14 150			
A19 01.09-		CA1970IR	14 150				
Fiesta 1.6	[LP3]	01.09-	CA2091IR*	14 120	01.09-	CS1275	12 1.4
		01.85- 11.89	CA306IR	14 55	01.85- 11.89	CS724	12 1.1
		01.85- 11.89	CA560IR	14 70	01.85- 11.89	CS278	12 0.85
	[LUH]	01.89- 01.94	CA306IR	14 55	03.89- 01.94	CS724	12 1.1
		01.89- 01.94	CA560IR	14 70	01.89- 01.94	CS592	12 0.9
			10.08-	CA2044IR*	14 120	10.08-	CS1050
Fiesta 1.6 XR2	[L3E]	08.81- 08.83	CA126IR	14 45	08.81- 08.83	CS123	12 0.8
		08.81- 08.83	CA226IR	14 55			
		08.81- 08.83	CA305IR	14 55			
	[LUB]	04.84- 02.89	CA226IR	14 55	A32 04.84- 01.86	CS357	12 1.4
		04.84- 02.89	CA305IR	14 55	A34 01.86- 02.89	CS278	12 0.85
		04.84- 02.89	CA306IR	14 55			
	[LUD]	04.84- 02.89	CA325IR	14 70			
		04.84- 02.89	CA96IR	14 55			
		03.84- 02.89	CA226IR	14 55	A32 03.84- 01.86	CS357	12 1.4
		03.84- 02.89	CA305IR	14 55	A34 01.86- 02.89	CS278	12 0.85
		03.84- 02.89	CA306IR	14 55			
		03.84- 02.89	CA325IR	14 70			
Fiesta 1.6 XR2i	[LJC]	03.89- 12.95	CA306IR	14 55	03.89- 12.95	CS592	12 0.9
		03.89- 12.95	CA560IR	14 70	11.91- 12.95	CS724	12 1.1
	[LJD]	03.89- 12.95	CA306IR	14 55	11.91- 12.95	CS724	12 1.1
		03.89- 12.95	CA560IR	14 70	03.89- 12.95	CS592	12 0.9
Fiesta 1.6 16V	[FYJA]	11.01-	CA1737IR	14 70	11.01-	CS1050	12 1.1
		AC 11.01-	CA1737IR	14 70			
		AC 11.01-	CA1780IR	14 90			
	[FYJB]	11.01-	CA1737IR	14 70	11.01-	CS1050	12 1.1
		AC 11.01-	CA1737IR	14 70			
		AC 11.01-	CA1780IR	14 90			
Fiesta 1.6 16V Sport	[L1T]	02.00-	CA1474IR	14 70	02.00-	CS1050	12 1.1
	[L1V]	02.00-	CA1474IR	14 70	02.00-	CS1050	12 1.1
Fiesta 1.6 i 16V	[L1G]	01.94- 12.95	CA738IR	14 70	01.94- 12.95	CS685	12 1.4
		01.94- 12.95	CA739IR	14 90	01.94- 12.95	CS724	12 1.1
		PS 01.94- 12.95	CA1032IR	14 70			
		AC 01.94- 12.95	CA1032IR	14 70			
Fiesta 1.6 Turbo	[LHA]	03.90- 10.92	CA306IR	14 55	03.90- 10.92	CS592	12 0.9
		03.90- 10.92	CA560IR	14 70			
Fiesta 1.6 Diesel	[LTB]	09.83- 09.89	CA306IR	14 55	09.83- 09.89	CS341	12 1.7
		09.83- 09.89	CA350IR	14 45			
		04.84- 02.89	CA650IR	14 70			
Fiesta 1.6 TDCi	[HHJA]	11.04-	CA1834IR	14 150	11.04-	CS1275	12 1.4
		11.04-	CA1865IR	14 120			
	[HHJB]	11.04-	CA1834IR	14 150	11.04-	CS1275	12 1.4
		11.04-	CA1865IR	14 120			
	[HHJD]	10.08-	CA2091IR*	14 120	10.08-	CS1275	12 1.4
		A19 10.08-	CA1970IR	14 150			
	[HHJF]	10.08-	CA2091IR*	14 120	10.08-	CS1275	12 1.4
		A19 10.08-	CA1970IR	14 150			
		10.08-	CA2091IR*	14 120	10.08-	CS1275	12 1.4
Fiesta 1.8 16V	[RDB]	A19 10.08-	CA1970IR	14 150			
		02.92- 12.95	CA738IR	14 70	02.92- 12.95	CS685	12 1.4
		02.92- 12.95	CA739IR	14 90	02.92- 12.95	CS724	12 1.1
		ACPS 01.94- 12.95	CA1032IR	14 70			
Fiesta 1.8 16V XR2i	[RQC]	02.92- 12.95	CA738IR	14 70	02.92- 12.95	CS724	12 1.1
		02.92- 12.95	CA739IR	14 90	02.92- 12.95	CS685	12 1.4
		PS 02.92- 12.95	CA1032IR	14 70			
		AC 02.92- 12.95	CA1032IR	14 70			
Fiesta 1.8 Diesel	[RTC]	03.89- 02.96	CA306IR	14 55	03.89- 02.96	CS613	12 2.2
		03.89- 02.96	CA561IR	14 55	03.89- 02.96	CS341	12 1.7
		03.89- 02.96	CA717IR	14 70			
	[RTD]	03.89- 02.96	CA306IR	14 55	03.89- 02.96	CS613	12 2.2
		03.89- 02.96	CA561IR	14 55	03.89- 02.96	CS341	12 1.7
		03.89- 02.96	CA717IR	14 70			
	[RTG]	03.89- 02.96	CA306IR	14 55	03.89- 02.96	CS613	12 2.2
		03.89- 02.96	CA561IR	14 55	03.89- 02.96	CS341	12 1.7
	[RTJ]	03.89- 02.96	CA717IR	14 70			
		10.95- 04.00	CA1217IR	14 70	10.95- 04.00	CS341	12 1.7
					10.95- 04.98	CS613	12 2.2
	[RTK]	01.96- 10.00	CA1217IR	14 70	01.96- 10.00	CS613	12 2.2
					01.96- 10.00	CS341	12 1.7
	[RTN]	04.00- 01.02	CA1649IR	14 90	04.00- 01.02	CS341	12 1.7
		04.00- 01.02	CA1760IR	14 80	04.00- 01.02	CS613	12 2.2
		A17 04.00- 01.02	CA1772IR	14 90			
	[RTP]	04.00- 12.02	CA1649IR	14 90	04.00- 12.02	CS613	12 2.2
		04.00- 12.02	CA1760IR	14 80			
	A17 04.00- 12.02	CA1772IR	14 90				
[RTQ]	04.00- 12.02	CA1649IR	14 90	02.00- 12.02	CS613	12 2.2	
	04.00- 12.02	CA1760IR	14 80				
	A17 04.00- 12.02	CA1772IR	14 90				
Fiesta 1.8 TD	[RTN]	03.00-	CA1649IR	14 90	03.00-	CS613	12 2.2
		03.00-	CA1760IR	14 80			
		03.00-	CA1772IR	14 90			
	[RTP]	03.00-	CA1649IR	14 90	03.00-	CS613	12 2.2
		03.00-	CA1760IR	14 80			
		03.00-	CA1772IR	14 90			
	[RTQ]	03.00-	CA1649IR	14 90	03.00-	CS613	12 2.2
		03.00-	CA1760IR	14 80			
		03.00-	CA1772IR	14 90			
		03.93- 12.95	CA561IR	14 55	03.93- 12.95	CS613	12 2.2
		03.93- 12.95	CA717IR	14 70	03.93- 12.95	CS341	12 1.7
Focus 1.4	[ASDA]	11.04- 12.04	CA1340IR	14 80	11.04-	CS1050	12 1.1
		11.04-	CA1925IR	14 105	11.04-	CS1404	12 1.4
		11.04-	CA1962IR	14 120			



	[ASDB]	11.04-12.04	CA1340IR	14 80	11.04-	CS1404	12 1.4
		11.04-	CA1925IR	14 105	11.04-	CS1050	12 1.1
		11.04-	CA1962IR	14 120			
Focus 1.4 i 16V	[FXDA]	10.98-02.99	CA1474IR	14 70	10.98-10.98-	CS1050	12 1.1
			CA1340IR	14 80		CS960	12 0.9
	[FXDB]	10.98-10.98-	CA1340IR	14 80	10.98-10.98-	CS960	12 0.9
			CA1474IR	14 70		CS1050	12 1.1
	[FXDC]	10.98-02.99	CA1474IR	14 70	10.98-10.98-	CS960	12 0.9
			CA1340IR	14 80		CS1050	12 1.1
	[FXDD]	10.98-06.03	CA1340IR	14 80	10.98-10.98-	CS960	12 0.9
			CA1474IR	14 70		CS1050	12 1.1
Focus 1.6	[HWDA]	11.04-11.04-	CA1340IR	14 80	11.04-11.04-	CS1404	12 1.4
		11.04-	CA1925IR	14 105		CS1050	12 1.1
		11.04-	CA1962IR	14 120			
	[HWDB]	11.04-11.04-	CA1340IR	14 80	11.04-11.04-	CS1404	12 1.4
		11.04-	CA1925IR	14 105		CS1050	12 1.1
		11.04-	CA1962IR	14 120			
	[PNDA]	04.11-	CA2044IR*	14 120	04.11-	CS1050	12 1.1
	[SHDA]	11.04-11.04-	CA1340IR	14 80	11.04-11.04-	CS1404	12 1.4
		11.04-	CA1925IR	14 105		CS1050	12 1.1
		11.04-	CA1962IR	14 120			
		04.11-	CA2044IR*	14 120	04.11-	CS1050	12 1.1
Focus 1.6 C-Max	[HWDA]	10.03-03.07	CA1340IR	14 80	10.03-03.07	CS1050	12 1.1
		10.03-03.07	CA1925IR	14 105	10.03-03.07	CS1404	12 1.4
	[HWDB]	10.03-03.07	CA1340IR	14 80	10.03-03.07	CS1404	12 1.4
		10.03-03.07	CA1925IR	14 105	10.03-03.07	CS1050	12 1.1
Focus 1.6 FlexFuel	[FYDH]	01.02-11.04	CA1340IR	14 80	01.02-11.04	CS960	12 0.9
		01.02-11.04	CA1474IR	14 70		CS1050	12 1.1
		01.02-11.04	CA1925IR	14 105			
		01.02-11.04	CA2093IR*	14 90			
Focus 1.6 i 16V	[FYDA]	10.98-10.98-	CA1340IR	14 80	10.98-10.98-	CS1050	12 1.1
		02.99-11.04	CA1474IR	14 70		CS960	12 0.9
			CA2093IR*	14 90			
	[FYDB]	10.98-10.98-	CA1340IR	14 80	10.98-10.98-	CS1050	12 1.1
		10.98-11.04	CA1474IR	14 70		CS960	12 0.9
			CA2093IR*	14 90			
	[FYDC]	10.98-10.98-	CA1340IR	14 80	10.98-10.98-	CS1050	12 1.1
		10.98-11.04	CA1474IR	14 70		CS960	12 0.9
			CA2093IR*	14 90			
	[FYDD]	10.98-10.98-	CA1340IR	14 80	10.98-10.98-	CS1050	12 1.1
		10.98-11.04	CA1474IR	14 70		CS960	12 0.9
			CA2093IR*	14 90			
	[FYDH]	10.98-10.98-	CA1340IR	14 80	10.98-10.98-	CS1050	12 1.1
		10.98-11.04	CA1474IR	14 70		CS960	12 0.9
			CA2093IR*	14 90			
Focus 1.6 Ti	[HXDA]	11.04-11.04-	CA1340IR	14 80	11.04-11.04-	CS1404	12 1.4
		11.04-	CA1925IR	14 105		CS1050	12 1.1
		11.04-	CA1962IR	14 120			
Focus 1.6 Ti C-Max	[HXDA]	08.04-03.07	CA1340IR	14 80	08.04-03.07	CS1404	12 1.4
		08.04-03.07	CA1925IR	14 105	08.04-03.07	CS1050	12 1.1
		08.04-03.07	CA1962IR	14 120			
Focus 1.6 Ti-VCT	[PNDA]	04.11-	CA2044IR*	14 120	04.11-	CS1050	12 1.1
		04.11-	CA2044IR*	14 120	04.11-	CS1050	12 1.1
Focus 1.6 Flexfuel		04.11-	CA2044IR*	14 120	04.11-	CS1050	12 1.1
Focus 1.6 LPG		10.09-10.09-	CA1962IR	14 120	10.09-10.09-	CS1404	12 1.4
		10.09-	CA1925IR	14 105		CS1050	12 1.1
Focus 1.6 Ti-VCT Flexifuel	[PNDA]	04.11-	CA2044IR*	14 120	04.11-	CS1050	12 1.1
Focus 1.6 TDCi	[G8DA]	11.04-11.04-	CA1834IR	14 150	11.04-	CS1341	12 1.2
		11.04-	CA1865IR	14 120			
	[G8DB]	11.04-11.04-	CA1834IR	14 150	11.04-	CS1341	12 1.2
		11.04-	CA1865IR	14 120			
	[HHDA]	06.03-06.03-	CA1834IR	14 150	11.04-	CS1341	12 1.2
		06.03-	CA1865IR	14 120			
	[HHDB]	06.03-06.03-	CA1834IR	14 150	11.04-	CS1341	12 1.2
		06.03-	CA1865IR	14 120			
		12.07-12.07-	CA1834IR	14 150	12.07-	CS1341	12 1.2
			CA1865IR	14 120			
Focus 1.6 TDCi C-Max	[G8DA]	10.03-03.07	CA1834IR	14 150	10.03-03.07	CS1341	12 1.2
		10.03-03.07	CA1865IR	14 120			
	[G8DB]	10.03-03.07	CA1834IR	14 150	10.03-03.07	CS1341	12 1.2
		10.03-03.07	CA1865IR	14 120			
	[HHDA]	02.05-03.07	CA1834IR	14 150	06.05-03.07	CS1341	12 1.2
		02.05-03.07	CA1865IR	14 120			
	[HHDB]	02.05-03.07	CA1834IR	14 150	06.05-03.07	CS1341	12 1.2
		02.05-03.07	CA1865IR	14 120			
Focus 1.8		03.06-03.06-	CA1864IR	14 120	Transmission Type: MTX75, CVT	CS1403	12 1.2
		AT 03.06-	CA1926IR	14 120	Transmission Type: B5, IB5 03.06-	CS1402	12 1.2
Focus 1.8 C-Max	[CSDA]	10.03-03.07	CA1864IR	14 120	Transmission Type: B5, IB5 05.04-03.07	CS1402	12 1.2
		10.03-03.07	CA1926IR	14 120	Transmission Type: MTX75, CVT 10.03-03.07	CS1403	12 1.2
	[CSDB]	10.03-03.07	CA1864IR	14 120	Transmission Type: B5, IB5 05.04-03.07	CS1402	12 1.2
		10.03-03.07	CA1926IR	14 120	Transmission Type: MTX75, CVT 10.03-03.07	CS1403	12 1.2
	[Q7DA]	06.03-04.04-	CA1864IR	14 120	Transmission Type: B5, IB5 04.04-	CS1402	12 1.2
		04.04-	CA1926IR	14 120	Transmission Type: MTX75, CVT 04.04-	CS1403	12 1.2
	[QQDA]	06.03-04.04-	CA1864IR	14 120	Transmission Type: B5, IB5 04.04-03.07	CS1402	12 1.2
		04.04-03.07	CA1926IR	14 120	Transmission Type: MTX75, CVT 04.04-03.07	CS1403	12 1.2
	[QQDB]	06.03-04.04-	CA1864IR	14 120	Transmission Type: B5, IB5 04.04-	CS1402	12 1.2
		04.04-	CA1926IR	14 120	Transmission Type: MTX75, CVT 04.04-	CS1403	12 1.2
Focus 1.8 C-Max Flexifuel	[Q7DA]	01.06-03.07	CA1926IR	14 120	01.06-03.07	CS1402	12 1.2
Focus 1.8 FlexFuel	[Q7DA]	01.06-06.06-	CA1926IR	14 120	01.06-06.06-	CS1402	12 1.2
		AT 06.06-	CA1864IR	14 120	AT 06.06-	CS1403	12 1.2
			CA1926IR	14 120			
Focus 1.8 i 16V	[EYDB]	10.98-	CA1483IR	14 80	10.98-10.98-	CS1107	12 1.4
						CS790	12 1.0
	[EYDC]	10.98-	CA1483IR	14 80	10.98-10.98-	CS790	12 1.0
						CS1107	12 1.4
	[EYDD]	10.98-	CA1483IR	14 80	10.98-10.98-	CS790	12 1.0
						CS1107	12 1.4
	[EYDE]	10.98-	CA1483IR	14 80	10.98-10.98-	CS790	12 1.0
						CS1107	12 1.4
	[EYDF]	10.98-	CA1483IR	14 80	10.98-10.98-	CS1107	12 1.4
						CS790	12 1.0
	[EYDG]	10.98-	CA1483IR	14 80	10.98-10.98-	CS790	12 1.0
						CS1107	12 1.4



**FORD** Continued

	[EYDI]	10.98-	CA1483IR	14 80		10.98-	CS790	12 1.0
						10.98-	CS1107	12 1.4
	[EYDJ]	10.98-	CA1483IR	14 80		10.98-	CS790	12 1.0
						10.98-	CS1107	12 1.4
	[EYDL]	10.98-	CA1483IR	14 80		10.98-	CS1107	12 1.4
						10.98-	CS790	12 1.0
Focus 1.8 TDCi	[F9DA]	03.01-	CA1475IR	14 90		05.01- 05.05	CS1396	12 2.2
	[F9DB]	03.01-	CA1475IR	14 90		05.01- 05.05	CS1396	12 2.2
	[FFDA]	09.02-	CA1475IR	14 90		09.02- 05.05	CS1396	12 2.2
	[KKDA]	04.05- 01.08	CA1999IR	14 150		04.05- 01.08	CS1408	12 2.0
		AC 04.05- 12.07	CA1999IR	14 150				
		AC 11.04- 12.07	CA1941IR	14 120				
		AC 12.07- 03.08	CA1989IR	14 105				
Focus 1.8 TDCi C-Max	[KKDA]	AC, w/electrical heating system 04.05- 03.07	CA1999IR	14 150		04.05- 03.07	CS1408	12 2.0
		AC 01.05- 12.07	CA1941IR	14 120				
		AC 12.07- 03.08	CA1989IR	14 105				
Focus 1.8 TDDi	[BHDA]	08.99-	CA1475IR	14 90		08.99- 05.01	CS613	12 2.2
						05.01- 05.05	CS1396	12 2.2
	[BHDB]	08.99-	CA1475IR	14 90		05.01- 05.05	CS1396	12 2.2
						08.99- 05.01	CS613	12 2.2
	[C9DA]	01.99- 05.05	CA1475IR	14 90		01.99- 05.01	CS613	12 2.2
						05.01- 05.05	CS1396	12 2.2
	[C9DB]	01.99- 05.05	CA1475IR	14 90		05.01- 05.05	CS1396	12 2.2
						01.99- 05.01	CS613	12 2.2
	[C9DC]	01.99- 05.05	CA1475IR	14 90		05.01- 05.05	CS1396	12 2.2
						01.99- 05.01	CS613	12 2.2
Focus 2.0	[ALDA]	03.02- AT 03.02-	CA1483IR CA1475IR	14 80 14 90		03.02-	CS790	12 1.0
	[AODA]	11.04- 04.05-	CA1864IR CA1926IR	14 120 14 120	Transmission Type: MTX75, CVT 11.04-	11.04-	CS1403	12 1.2
	[AODB]	11.04-	CA1864IR	14 120	Transmission Type: MTX75, CVT 11.04-	05.05	CS1403	12 1.2
Focus 2.0 C-Max	[AODA]	04.04- 03.07	CA1864IR	14 120	Transmission Type: MTX75, CVT 04.04- 03.07	04.04- 03.07	CS1403	12 1.2
	[AODB]	04.04- 03.07	CA1864IR	14 120	Transmission Type: MTX75, CVT 04.04- 03.07	04.04- 03.07	CS1403	12 1.2
Focus 2.0 RS	[HMDA]	10.02-	CA1475IR	14 90		10.02- 05.05	CS1107	12 1.4
		10.02-	CA1483IR	14 80				
Focus 2.0 ST170	[ALDA]					09.02-	CS790	12 1.0
Focus 2.0 16V	[EDDB]	08.98- 05.05	CA1483IR	14 80		08.98- 05.05	CS790	12 1.0
		AT 10.98- 05.05	CA1475IR	14 90		08.98- 05.05	CS1107	12 1.4
	[EDDC]	10.98- 05.05	CA1483IR	14 80		10.98- 05.05	CS790	12 1.0
		AT 10.98- 05.05	CA1475IR	14 90		10.98- 05.05	CS1107	12 1.4
	[EDDD]	08.98- 05.05	CA1483IR	14 80		08.98- 05.05	CS1107	12 1.4
		AT 10.98- 05.05	CA1475IR	14 90		08.98- 05.05	CS790	12 1.0
	[EDDF]	10.98- 05.05	CA1483IR	14 80		10.98- 05.05	CS1107	12 1.4
		AT 10.98- 05.05	CA1475IR	14 90		10.98- 05.05	CS790	12 1.0
Focus 2.0 CNG		04.09-	CA1931IR	14 150		04.09-	CS1403	12 1.2
		04.09-	CA1864IR	14 120				
		AT 04.09-	CA1926IR	14 120				
Focus 2.0 LPG		06.08-	CA1931IR	14 150		06.08-	CS1403	12 1.2
		06.08-	CA1864IR	14 120				
		AT 06.08-	CA1926IR	14 120				
Focus 2.0 TDCi	[G6D_]	10.03- 03.07	CA1865IR	14 120		10.03- 03.07	CS1377	12 2.2
	[G6DA]	11.04-	CA1834IR	14 150		11.04-	CS1377	12 2.2
		11.04-	CA1865IR	14 120				
	[G6DB]	11.04-	CA1834IR	14 150		11.04-	CS1377	12 2.2
		11.04-	CA1865IR	14 120				
	[G6DD]	11.04-	CA1834IR	14 150		11.04-	CS1377	12 2.2
		11.04-	CA1865IR	14 120				
	[G6DE]	11.04-	CA1834IR	14 150		11.04-	CS1377	12 2.2
		11.04-	CA1865IR	14 120				
	[G6DF]	11.04-	CA1834IR	14 150		11.04-	CS1377	12 2.2
		11.04-	CA1865IR	14 120				
		11.04-	CA1934IR	14 105				
	[TXDB]					04.11-	CS1377	12 2.2
	[TYDA]					04.11-	CS1377	12 2.2
		02.08-	CA1834IR	14 150		02.08-	CS1377	12 2.2
		02.08-	CA1865IR	14 120				
Focus 2.0 TDCi C-Max	[G6DA]	10.03- 03.07	CA1834IR	14 150		10.03- 03.07	CS1377	12 2.2
		10.03- 03.07	CA1865IR	14 120				
	[G6DB]	10.03- 03.07	CA1834IR	14 150		10.03- 03.07	CS1377	12 2.2
		10.03- 03.07	CA1865IR	14 120				
	[G6DD]	10.03- 03.07	CA1834IR	14 150		10.03- 03.07	CS1377	12 2.2
		10.03- 03.07	CA1865IR	14 120				
Focus 2.5						01.09-	CS1430	12 1.4
Focus 2.5 ST	[HYDA]					10.05-	CS1398	12 1.4
Fusion 1.2	[FUJA]	03.05-	CA1737IR	14 70		03.05-	CS1050	12 1.1
		03.05-	CA1780IR	14 90				
	[FUJB]	03.05-	CA1737IR	14 70		03.05-	CS1050	12 1.1
		03.05-	CA1780IR	14 90				
Fusion 1.4	[FXJA]	08.02-	CA1737IR	14 70		08.02-	CS1050	12 1.1
		AC 08.02-	CA1780IR	14 90				
	[FXJB]	08.02-	CA1737IR	14 70		08.02-	CS1050	12 1.1
		AC 08.02-	CA1780IR	14 90				
Fusion 1.4 TDCi	[F6JA]	08.02-	CA1777IR	14 80		08.02-	CS1275	12 1.4
		A19 08.02-	CA1778IR	14 150				
	[F6JB]	08.02-	CA1777IR	14 80		08.02-	CS1275	12 1.4
		A19 08.02-	CA1778IR	14 150				
Fusion 1.6	[FYJA]	08.02-	CA1737IR	14 70		08.02-	CS1050	12 1.1
		AC 08.02-	CA1780IR	14 90				
	[FYJB]	08.02-	CA1737IR	14 70		08.02-	CS1050	12 1.1
		AC 08.02-	CA1780IR	14 90				
Fusion 1.6 TDCi	[HHJA]	11.04-	CA1834IR	14 150		11.04-	CS1275	12 1.4
		11.04-	CA1865IR	14 120				
	[HHJB]	11.04-	CA1834IR	14 150		11.04-	CS1275	12 1.4
		11.04-	CA1865IR	14 120				
Galaxy 1.8 TDCi	[FFWA]					03.06-	CS1429	12 1.4
		A22 03.06-	CA1919IR	14 150		A13 03.06-	CS1408	12 2.0
						03.06-	CS1429	12 1.4
	[QYWA]					A13 05.06-	CS1408	12 2.0
		A23 05.06-	CA1919IR	14 150		A13 05.06-	CS1408	12 2.0
Galaxy 1.9 TDi	[1Z]	02.95- 09.96	CA1089IR	14 120		02.95- 09.96	CS974	12 1.8
		02.95- 09.96	CA736IR	14 90				
		02.95- 09.96	CA827IR	14 70				
		02.95- 09.96	CA828IR	14 120				



	[AFN]	11.97- 09.98 11.97- 06.99 09.98- 06.99 06.99- 03.00 06.99- 03.00	CA1089IR CA736IR CA1260IR CA1394IR CA1446IR	14 120 14 90 14 120 14 120 14 90		AT 03.98- 03.00 11.97- 03.00	CS789 CS974	12 1.8 12 1.8
	[AHU]	09.96- 03.00 09.96- 03.00 09.96- 03.00 09.96- 03.00	CA1089IR CA736IR CA827IR CA828IR	14 120 14 90 14 70 14 120		09.96- 03.00	CS974	12 1.8
	[ANU]	09.99- 08.06 09.99- 08.06	CA1394IR CA1446IR	14 120 14 90		AT 09.99- 03.00 09.99- 03.00 04.00- 08.06	CS789 CS974 CS1181	12 1.8 12 1.8 12 2.0
	[ASZ]	02.03- 02.03-	CA1394IR CA1446IR	14 120 14 90		AT 02.03- 02.03-	CS1390 CS1181	12 2.3 12 2.0
	[AUU]	04.00- 04.00-	CA1394IR CA1446IR	14 120 14 90		AT 04.00- 04.00-	CS1181 CS1390	12 2.0 12 2.3
	[AVG]	06.99- 03.00 06.99- 03.00	CA1394IR CA1446IR	14 120 14 90		06.99- 03.00 AT 06.99- 03.00	CS974 CS789	12 1.8 12 1.8
	[BTB]	01.05-	CA1446IR	14 90		AT 05.05- 05.05-	CS1390 CS1181	12 2.3 12 2.0
Galaxy 2.0	[AOWA]	03.06-	CA1923IR	14 150		03.06-	CS1403	12 1.2
Galaxy 2.0 i	[NSE]	04.00- 04.00- 11.95- 03.00 11.95- 03.00	CA1394IR CA1446IR CA1076IR CA1149IR	14 120 14 90 14 115 14 90		A13 11.95- 03.00 04.00- AT 07.98- 03.00 A32 11.95- 03.00 AT 11.95- 03.00 11.95- 03.00	CS974 CS1181 CS1062 CS713 CS618 CS619	12 1.8 12 2.0 12 1.1 12 1.8 12 1.1 12 1.1
	[ZVSA]	01.01-	CA1836IR	14 120				
Galaxy 2.0 SCTi EcoBoost						03.10-	CS1403	12 1.2
Galaxy 2.0 TDCi	[AZWA]	03.06-	CA1970IR	14 150		03.06-	CS1377	12 2.2
	[QXWA]	03.06-	CA1970IR	14 150		03.06-	CS1377	12 2.2
	[QXWB]	03.06-	CA1970IR	14 150		03.06-	CS1377	12 2.2
	[UKWA]					05.06-	CS1377	12 2.2
		11.07-	CA1970IR	14 150		11.07-	CS1377	12 2.2
Galaxy 2.0 Flexifuel		05.06-	CA1923IR	14 150		05.06-	CS1403	12 1.2
Galaxy 2.2 TDCi	[Q4BA]					03.08-	CS1377	12 2.2
						07.10-	CS1377	12 2.2
Galaxy 2.3						07.07-	CS1403	12 1.2
Galaxy 2.3 16V	[E5SA]	04.00- 08.06	CA1836IR	14 120		AT 04.00- 08.06	CS1062	12 1.1
	[E5SB]	09.01- 08.06	CA1836IR	14 120		AT 09.01- AT 09.01- 09.01-	CS1062 CS789 CS1119	12 1.1 12 1.8 12 1.1
	[Y5B]	01.97- 03.00 01.97- 03.00	CA1076IR CA1149IR	14 115 14 90		AT 01.97- 03.00 01.97- 03.00	CS789 CS974	12 1.8 12 1.8
Galaxy 2.8 24V	[AYL]	04.00- 04.00-	CA1394IR CA1763IR	14 120 14 150		04.00-	CS1181	12 2.0
Galaxy 2.8 i	[AMY]	04.98- 03.02 04.98- 03.02	CA1142IR CA1143IR	14 120 14 150		04.98- 03.00 AT 04.98- 03.00	CS620 CS789	12 1.7 12 1.8
	[AAA]	02.95- 04.98 02.95- 04.98	CA1142IR CA1143IR	14 120 14 150		AT 11.95- 04.98 11.95- 04.98	CS789 CS620	12 1.8 12 1.7
Galaxy 2.8 i 4x4	[AMY]	04.98- 03.00 04.98- 03.00	CA1142IR CA1143IR	14 120 14 150		04.98- 03.00 04.98- 03.00	CS620 CS789	12 1.7 12 1.8
	[AAA]	04.96- 04.98 04.96- 04.98	CA1142IR CA1143IR	14 120 14 150		04.96- 04.98 04.96- 04.98	CS789 CS620	12 1.8 12 1.7
Granada 1.6	[LCK]	07.81- 08.85 07.81- 08.85	CA60IR CA94IR	14 45 14 55		07.81- 08.85	CS78	12 0.75
Granada 1.7	[MWB]	12.74- 12.76 12.74- 08.77	CA61IR CA96IR	14 45 14 55				
	[MY]	08.77- 06.79 08.77- 06.79 08.77- 06.79	CA226IR CA61IR CA96IR	14 55 14 45 14 55		08.77- 06.79 08.77- 06.79	CS69 CS72	12 0.8 12 1.1
	[MYE]	08.77- 07.81 08.77- 07.81 08.77- 07.81	CA226IR CA61IR CA96IR	14 55 14 45 14 55		08.77- 07.81 08.77- 07.81	CS72 CS69	12 1.1 12 0.8
	[TV17H]	03.72- 02.75	CA190IR	14 35		03.72- 02.75	CS69	12 0.8
		08.77- 08.81	CA226IR	14 55		08.77- 05.82	CS69	12 0.8
		08.77- 08.81	CA96IR	14 55		08.77- 05.82	CS72	12 1.1
		08.77- 08.81	CA61IR	14 45				
Granada 1.7 S	[MWB]	12.74- 12.76 12.74- 08.77	CA61IR CA96IR	14 45 14 55				
Granada 1.9 Diesel		08.77- 08.79	CA61IR	14 45				
		08.77- 08.82	CA226IR	14 55				
Granada 2.0	[NEK]	08.81- 08.85 08.81- 08.85 08.81- 08.85	CA293IR CA60IR CA94IR	14 55 14 45 14 55		08.81- 08.85 08.81- 08.85	CS78 CS86	12 0.75 12 1.0
	[NEP]	08.79- 08.85 08.81- 08.85	CA94IR CA293IR	14 55 14 55		08.79- 08.85	CS86	12 1.0
	[NY]	01.75- 08.77 01.75- 08.77 01.75- 08.77 01.75- 08.77	CA60IR CA61IR CA94IR CA96IR	14 45 14 45 14 55 14 55		AT 01.75- 08.77 01.75- 08.77	CS72 CS69	12 1.1 12 0.8
	[NYP]	08.77- 08.85 08.77- 08.85 08.77- 08.85	CA126IR CA226IR CA305IR	14 45 14 55 14 55		08.77- 08.85 08.77- 08.85	CS69 CS72	12 0.8 12 1.1
		01.76- 07.79	CA94IR	14 55		01.76- 07.79	CS72	12 1.1
		01.76- 07.79	CA61IR	14 45		03.75- 12.75	CS86	12 1.0
		01.76- 07.79	CA226IR	14 55				
Granada 2.1 Diesel	[WTA]	08.77- 08.82 08.77- 08.82	CA60IR CA94IR	14 45 14 55				
Granada 2.3	[YYH]	01.72- 12.74 01.72- 08.77 04.75- 08.77 08.77- 06.79 08.77- 06.79 08.77- 06.79	CA190IR CA96IR CA61IR CA126IR CA226IR CA305IR	14 35 14 55 14 45 14 45 14 55 14 55		08.77- 06.79 01.72- 06.79	CS69 CS72	12 0.8 12 1.1
	[YYP]	06.79- 02.81 06.79- 08.85 06.79- 08.85	CA126IR CA226IR CA305IR	14 45 14 55 14 55		06.79- 08.85 06.79- 08.85	CS72 CS69	12 1.1 12 0.8
	[YYU]	06.81- 08.85 06.81- 08.85	CA226IR CA305IR	14 55 14 55		06.81- 08.85	CS72 CS69	12 1.1 12 0.8
Granada 2.5 Diesel	[STP]	08.82- 08.85	CA96IR	14 55				



**FORD** *Continued*

Granada 2.6	[UY]	01.72- 02.76	CA226IR	14 55	01.72- 02.76	CS72	12 1.1
		01.72- 02.76	CA61IR	14 45			
		01.76- 08.77	CA96IR	14 55	12.75- 08.77	CS72	12 1.1
		12.75- 08.77	CA61IR	14 45			
Granada 2.8	[PYA]	08.77- 02.81	CA126IR	14 45	08.77- 08.85	CS69	12 0.8
		08.77- 08.85	CA226IR	14 55	08.77- 08.85	CS72	12 1.1
		08.77- 08.85	CA305IR	14 55			
	[PYU]	06.81- 08.85	CA226IR	14 55	06.81- 08.85	CS72	12 1.1
		06.81- 08.85	CA305IR	14 55	06.81- 08.85	CS69	12 0.8
Granada 2.8 i	[PRB]				08.77- 08.81	CS69	12 0.8
					08.77- 08.81	CS72	12 1.1
	[PRC]				10.82- 08.85	CS69	12 0.8
	[PRD]				10.82- 08.85	CS72	12 1.1
					08.77- 08.85	CS69	12 0.8
					08.77- 08.85	CS72	12 1.1
Granada 3.0	[HY]	01.72- 02.76	CA60IR	14 45			
		01.72- 02.76	CA94IR	14 55			
Grand C-Max 1.6 Ti-CVT		12.10-	CA2044IR*	14 120	12.10-	CS1050	12 1.1
Grand C-Max 1.6 TDCi	[T1DA]				12.10-	CS1341	12 1.2
					12.10-	CS1341	12 1.2
					12.10-	CS1377	12 2.2
Grand C-Max 2.0 TDCi							
Ka 1.0 i	[C4B]	07.97- 09.99	CA1087IR	14 70	07.97- 09.99	CS986	12 1.1
Ka 1.2	[169A4.000]	02.09-	CA1742IR	14 85	02.09-	CS1379	12 0.8
		02.09-	CA2070IR*	14 140			
Ka 1.3 i	[A9A]	08.02- 09.08	CA1993IR	14 80	08.02- 09.08	CS1289	12 1.1
		A22 08.02- 09.08	CA1758IR	14 90			
	[A9B]	08.02- 09.08	CA1993IR	14 80	08.02- 09.08	CS1289	12 1.1
		A22 08.02- 09.08	CA1758IR	14 90			
	[BAA]	01.98- 10.02	CA1552IR	14 70	09.96- 10.02	CS1289	12 1.1
		PS 09.96- 10.02	CA1087IR	14 70	09.96- 10.02	CS986	12 1.1
		AC 09.96- 10.02	CA1145IR	14 90			
	[J4D]	01.98- 10.02	CA1552IR	14 70	09.96- 10.02	CS986	12 1.1
		PS 09.96- 10.02	CA1087IR	14 70			
		AC 09.96- 10.02	CA1145IR	14 90			
	[J4K]	01.98- 10.02	CA1552IR	14 70	09.96- 10.02	CS986	12 1.1
		PS 09.96- 10.02	CA1087IR	14 70			
		AC 09.96- 10.02	CA1145IR	14 90			
	[J4M]	01.98- 10.02	CA1552IR	14 70	09.96- 10.02	CS986	12 1.1
		PS 09.96- 10.02	CA1087IR	14 70			
		AC 09.96- 10.02	CA1145IR	14 90			
	[J4N]	09.96- 10.02	CA1552IR	14 70	09.96- 10.02	CS986	12 1.1
		PS 09.96- 10.02	CA1087IR	14 70			
		AC 09.96- 10.02	CA1145IR	14 90			
	[J4P]	01.98- 10.02	CA1552IR	14 70	09.96- 10.02	CS986	12 1.1
		PS 09.96- 10.02	CA1087IR	14 70			
		AC 09.96- 10.02	CA1145IR	14 90			
	[J4S]	01.98- 10.02	CA1552IR	14 70	09.96- 10.02	CS986	12 1.1
		PS 09.96- 10.02	CA1087IR	14 70			
		AC 09.96- 10.02	CA1145IR	14 90			
	[JJB]	01.98- 10.02	CA1552IR	14 70	09.96- 10.02	CS986	12 1.1
		PS 09.96- 10.02	CA1087IR	14 70			
		AC 09.96- 10.02	CA1145IR	14 90			
	[JJD]	01.98- 10.02	CA1552IR	14 70	06.98-	CS986	12 1.1
		PS 06.98- 10.02	CA1087IR	14 70			
		AC 06.98- 10.02	CA1145IR	14 90			
	[JJF]	01.98- 10.02	CA1552IR	14 70	09.96- 10.02	CS986	12 1.1
	PS 06.98- 10.02	CA1087IR	14 70				
	AC 06.98- 10.02	CA1145IR	14 90				
[JJG]	01.98- 10.02	CA1552IR	14 70	09.98- 10.02	CS986	12 1.1	
	PS 06.98- 10.02	CA1087IR	14 70				
	AC 06.98- 10.02	CA1145IR	14 90				
[JUH]	01.98- 10.02	CA1552IR	14 70	09.96- 10.02	CS986	12 1.1	
	PS 06.98- 10.02	CA1087IR	14 70				
	AC 06.98- 10.02	CA1145IR	14 90				
[JUL]	01.98- 10.02	CA1552IR	14 70	09.96- 10.02	CS986	12 1.1	
	PS 06.98- 10.02	CA1087IR	14 70				
	AC 06.98- 10.02	CA1145IR	14 90				
Ka 1.6 Street	[CDRA]	05.03-	CA2034IR	14 90	02.03-	CS1289	12 1.1
	[CDRB]	05.03-	CA2034IR	14 90	02.03-	CS1289	12 1.1
Ka 1.6 i	[CDB]	07.03-	CA2034IR	14 90	07.03-	CS1289	12 1.1
	[CDC]	07.03-	CA2034IR	14 90	07.03-	CS1289	12 1.1
Kuga 2.0 TDCi		03.08-	CA1865IR	14 120	03.08-	CS1377	12 2.2
		03.08-	CA1834IR	14 150			
Kuga 2.0 TDCi 4x4		03.08-	CA1834IR	14 150	03.08-	CS1377	12 2.2
		03.08-	CA1865IR	14 120			
Kuga 2.5 4x4		03.09-	CA1967IR	14 150	03.09-	CS1430	12 1.4
Maverick 2.0 16V	[YF]				02.01-	CS1058	12 1.5
Maverick 2.3 16V	[GZ]				05.04-	CS1403	12 1.2
Maverick 2.4 i	[KA-24]	09.96- 04.98	JA991IR	14 65			
	[KA24-E]	02.93- 08.96	JA991IR	14 65	02.93- 08.96	JS939	12 1.2
Maverick 2.7 TD	[TD27]	02.93- 08.96	JA1117IR	14 60	02.93- 08.96	JS517	12 2.5
	[TD27E]	09.96-	JA1364IR	14 70	09.96-	JS1214	12 1.9
Maverick 3.0 V6 24V	[AJ]				02.01- 12.03	CS961	12 1.4
Mondeo 1.6 i 16V	[L1F]	02.93- 08.96	CA731IR	14 90	02.93- 02.94	CS790	12 1.0
					AT 06.93- 08.96	CS1058	12 1.5
					02.94- 08.96	CS1107	12 1.4
					02.93- 02.94	CS719	12 1.4
	[L1J]	02.93- 08.96	CA731IR	14 90	AT 07.94- 08.96	CS1058	12 1.5
					07.94- 08.96	CS1107	12 1.4
Mondeo 1.6 i	[L1J]	08.96- 05.98	CA731IR	14 90	08.96- 08.00	CS719	12 1.4
		05.98- 08.98	CA1482IR	14 105	08.96- 08.00	CS790	12 1.0
				AT 08.96- 08.98	CS1058	12 1.5	
				08.96- 08.98	CS1107	12 1.4	
	[L1L]	05.98- 11.00	CA1482IR	14 105	AT 05.98- 11.00	CS1058	12 1.5
					05.98- 11.00	CS1107	12 1.4
[L1N]	05.98- 11.00	CA1482IR	14 105	AT 05.98- 11.00	CS1058	12 1.5	
				05.98- 11.00	CS1107	12 1.4	
[L1Q]	05.98- 11.00	CA1482IR	14 105	05.98- 11.00	CS1107	12 1.4	
				AT 05.98- 11.00	CS1058	12 1.5	
Mondeo 1.6 Ti	[PNBA]	03.07-	CA2044IR*	14 120	03.07-	CS1050	12 1.1
	[RHBA]	03.07-	CA2044IR*	14 120	03.07-	CS1050	12 1.1
Mondeo 1.6 Ti-VCT	[RHBA]	03.07-	CA2044IR*	14 120	03.07-	CS1050	12 1.1
		07.10-	CA2044IR*	14 120	07.10-	CS1050	12 1.1



Mondeo 1.8 16V	[CGBA]	11.00- AT 11.00-	CA1635IR CA1638IR	14 115 14 115	11.00- 03.05	CS1246	12 1.4
	[CGBB]	11.00- AT 11.00-	CA1635IR CA1638IR	14 115 14 115	11.00-	CS1246	12 1.4
	[CHBA]	11.00- AT 11.00-	CA1635IR CA1638IR	14 115 14 115	11.00- 03.05	CS1246	12 1.4
	[CHBB]	11.00- AT 11.00-	CA1635IR CA1638IR	14 115 14 115	11.00- 03.05	CS1246	12 1.4
Mondeo 1.8 i 16V	[RKA]	02.93- 08.96	CA7311R	14 90	02.93- 02.94 AT 06.93- 08.96 02.94- 08.96 02.93- 02.94	CS719 CS1058 CS1107 CS790	12 1.4 12 1.5 12 1.4 12 1.0
	[RKB]	01.94- 08.96	CA7311R	14 90	02.94- 08.96 AT 01.94- 08.96	CS1107 CS1058	12 1.4 12 1.5
Mondeo 1.8 i 16V 4x4	[RKA]	02.93- 08.96	CA7311R	14 90	02.93- 02.94 AT 02.93- 08.96 03.94- 08.96 02.93- 02.94	CS790 CS1058 CS1107 CS719	12 1.0 12 1.5 12 1.4 12 1.4
Mondeo 1.8 i	[RKB]	08.96- 05.98 05.98- 09.00	CA7311R CA1482IR	14 90 14 105	08.96- 09.00 09.96- 09.00 AT 08.96- 09.00 09.96- 09.00	CS1107 CS719 CS1058 CS790	12 1.4 12 1.4 12 1.5 12 1.0
	[RKF]	08.98- 09.00	CA1482IR	14 105	09.96- 09.00 AT 09.96- 09.00	CS1107 CS1058	12 1.4 12 1.5
	[RKH]	08.98- 09.00	CA1482IR	14 105	09.96- 11.00 AT 09.96- 11.00	CS1107 CS1058	12 1.4 12 1.5
	[RKJ]	08.98- 09.00	CA1482IR	14 105	09.96- 09.00 AT 09.96- 09.00	CS1107 CS1058	12 1.4 12 1.5
	[RKK]	09.96- 05.98 06.98- 09.00	CA7311R CA1482IR	14 90 14 105	AT 09.96- 11.00 08.96- 11.00	CS1058 CS1107	12 1.5 12 1.4
	[CFBA]	06.03- AT 06.03-	CA1635IR CA1638IR	14 115 14 115	06.03-	CS1246	12 1.4
Mondeo 1.8 TD	[RFM]	06.93- 08.96	CA1034IR	14 95	06.93- 08.96 06.93- 08.96	CS613 CS341	12 2.2 12 1.7
	[RFN]	06.93- 09.00	CA1034IR	14 95	06.93- 09.00 06.93- 09.00	CS613 CS341	12 2.2 12 1.7
Mondeo 1.8 TDCi	[FFBA]	03.07- A22 03.07-	CA1919IR CA1919IR	14 150 14 150	A13 03.07- 03.07-	CS1408 CS1429	12 2.0 12 1.4
	[KHBA]	06.07-	CA1919IR	14 150	06.07-	CS1408	12 2.0
	[QYBA]	06.07-	CA1919IR	14 150	06.07-	CS1408	12 2.0
	[AOBA]	03.07-	CA1923IR	14 150	03.07-	CS1403	12 1.2
Mondeo 2.0	[TBBA]	03.07-	CA1923IR	14 150	03.07-	CS1403	12 1.2
	[CJBA]	11.00- AT 11.00-	CA1635IR CA1638IR	14 115 14 115	11.00- 03.05	CS1246	12 1.4
Mondeo 2.0 16V	[CJBB]	11.00- AT 11.00-	CA1635IR CA1638IR	14 115 14 115	11.00- 03.05	CS1246	12 1.4
	[NGA]	01.93- 08.96	CA7311R	14 90	01.93- 08.96 01.93- 08.96 01.93- 08.96	CS719 CS1107 CS790	12 1.4 12 1.4 12 1.0
	[NGB]	02.93- 08.96	CA7311R	14 90	02.94- 08.96 AT 06.93- 08.96 02.93- 02.94 02.93- 02.94	CS1107 CS1058 CS719 CS790	12 1.4 12 1.5 12 1.4 12 1.0
Mondeo 2.0 i 16V 4x4	[NGA]	04.93- 08.96	CA7311R	14 90	AT 04.93- 08.96 04.93- 02.94	CS1058 CS790	12 1.5 12 1.0
Mondeo 2.0 i	[NGA]	09.96- 05.98 05.98- 09.00	CA7311R CA1482IR	14 90 14 105	08.96- 09.00 AT 08.96- 09.00 09.96- 09.00 09.96- 09.00	CS1107 CS1058 CS719 CS790	12 1.4 12 1.5 12 1.4 12 1.0
	[NGB]	08.98- 09.00	CA1482IR	14 105	AT 08.98- 09.00 08.98- 09.00	CS1058 CS1107	12 1.5 12 1.4
	[NGC]	08.96- 05.98 05.98- 09.00	CA7311R CA1482IR	14 90 14 105	08.96- 09.00 AT 08.96- 09.00	CS1107 CS1058	12 1.4 12 1.5
	[NGD]	08.96- 05.98 05.98- 09.00	CA7311R CA1482IR	14 90 14 105	AT 08.96- 09.00 08.96- 09.00	CS1058 CS1107	12 1.5 12 1.4
	[TPBA]				07.10- 03.10-	CS1403 CS1403	12 1.2 12 1.2
	[TPBA]				03.10-	CS1403	12 1.2
Mondeo 2.0 SCTi EcoBoost	[TPBA]				03.10-	CS1403	12 1.2
Mondeo 2.0 SCTi EcoBooste	[TPBA]				03.10-	CS1403	12 1.2
Mondeo 2.0 LPG	[TBBA]	07.09-	CA1923IR	14 150	07.09-	CS1403	12 1.2
Mondeo 2.0 DI/ TDDi 16V	[D5BA]	11.00-	CA1638IR	14 115	11.00-	CS1245	12 2.1
	[SDBA]	11.00-	CA1638IR	14 115	11.00-	CS1245	12 2.1
Mondeo 2.0 TDCi	[AZBC]	03.07- 02.10	CA2000IR	14 150	03.07-	CS1377	12 2.2
	[FMBA]	10.01- 03.07	CA1638IR	14 115	10.01- 03.07	CS1245	12 2.1
	[KLBA]	11.07-	CA2000IR	14 150	11.07-	CS1377	12 2.2
	[LPBA]	11.07-	CA2000IR	14 150	11.07-	CS1377	12 2.2
	[N7BA]	10.01- 03.07	CA1638IR	14 115	10.01- 03.07	CS1245	12 2.1
	[N7BB]	05.07-	CA2000IR	14 150	03.07-	CS1377	12 2.2
	[QXBA]	05.07-	CA2000IR	14 150	03.07-	CS1377	12 2.2
	[TXBA]				03.10-	CS1377	12 2.2
Mondeo 2.0 TDCi/ TDDi 16V	[D6BA]	11.00- 08.02	CA1638IR	14 115	11.00- 08.02	CS1245	12 2.1
	[HJBA]	11.00-	CA1638IR	14 115	11.00-	CS1245	12 2.1
	[HJBB]	11.00-	CA1638IR	14 115	11.00-	CS1245	12 2.1
	[HJBC]	09.02-	CA1638IR	14 115	09.02-	CS1245	12 2.1
Mondeo 2.0 TDDi 16V	[D5BA]	11.00-	CA1638IR	14 115	11.00-	CS1245	12 2.1
	[SDBA]	11.00-	CA1638IR	14 115	11.00-	CS1245	12 2.1
Mondeo 2.0 FlexFuel		03.07-	CA1923IR	14 150	03.07-	CS1403	12 1.2
Mondeo 2.0 Flexifuel		03.07-	CA1923IR	14 150	03.07-	CS1403	12 1.2
Mondeo 2.2 TDCi	[Q4BA]				03.08-	CS1377	12 2.2
	[QJBA]	09.04-	CA1638IR	14 115	09.04-	CS1245	12 2.1
	[QJBB]	09.04-	CA1638IR	14 115	09.04-	CS1245	12 2.1
	[QJBC]	09.04- 08.07	CA1638IR	14 115	09.04- 08.07	CS1245	12 2.1
	[QJBD]	09.04- 08.07	CA1638IR	14 115	09.04- 08.07	CS1245	12 2.1
Mondeo 2.3	[SEBA]				07.10-	CS1377	12 2.2
Mondeo 2.5	[SGA]	05.99- 11.00	CA1316IR	14 130	07.07- 09.99- 09.00	CS1403 CS961	12 1.2 12 1.4
Mondeo 2.5 24V	[SEA]	08.96- 09.00	CA1316IR	14 130	08.96- 09.00	CS961	12 1.4
	[SEB]	06.00- 11.00	CA1316IR	14 130	06.00- 11.00	CS961	12 1.4
	[SEC]	06.00- 11.00	CA1316IR	14 130	06.00- 11.00	CS961	12 1.4
	[SEA]	07.94- 08.96	CA1316IR	14 130	07.94- 08.96	CS961	12 1.4
Mondeo 2.5 V5	[HUBA]	03.07-	CA1968IR	14 150	03.07-	CS1430	12 1.4
Mondeo 2.5 V6 24V	[LCBD]	11.00-	CA1638IR	14 115 ▲	11.00- 08.03 08.03-	CS961 CS1426	12 1.4 12 1.6



**FORD** Continued

Mondeo 3.0	[MEBA]	04.02-	CA1638IR	14 115 ▲	06.03- AT 04.02- 04.02- 06.03	CS1426 CS961 CS961	12 1.6 12 1.4 12 1.4
Mondeo 3.0 V6 24V	[REBA]				09.04-	CS1426	12 1.6
Orion 1.3	[J4B]	07.90- 12.93	CA1227IR	14 55 A31	07.90- 12.93	CS592	12 0.9
		07.90- 12.93	CA305IR	14 55			
		07.90- 12.93	CA1227IR	14 55 A31	07.90- 12.93	CS592	12 0.9
	[J6A]	07.90- 12.93	CA226IR	14 55			
		07.90- 12.93	CA305IR	14 55			
		07.90- 12.93	CA1227IR	14 55 A31	08.88- 07.90	CS123	12 0.8
	[JBB]	08.88- 07.90	CA226IR	14 55	08.88- 07.90	CS278	12 0.85
		08.88- 07.90	CA305IR	14 55	08.88- 07.90	CS592	12 0.9
		08.88- 07.90	CA1227IR	14 55 A31	08.88- 07.90	CS123	12 0.8
	[JLA]	08.88- 07.90	CA226IR	14 55	08.88- 07.90	CS278	12 0.85
		08.88- 07.90	CA305IR	14 55	08.88- 07.90	CS592	12 0.9
		08.88- 07.90	CA1227IR	14 55 A31	08.88- 07.90	CS123	12 0.8
	[JLB]	08.88- 07.90	CA226IR	14 55	08.88- 07.90	CS278	12 0.85
		08.88- 07.90	CA305IR	14 55	08.88- 07.90	CS592	12 0.9
		08.88- 07.90	CA1227IR	14 55 A31	08.88- 07.90	CS123	12 0.8
	[JPA]	08.88- 07.90	CA226IR	14 55	08.88- 07.90	CS278	12 0.85
		08.88- 07.90	CA305IR	14 55	08.88- 07.90	CS592	12 0.9
		09.83- 03.86	CA126IR	14 45	09.83- 03.86	CS123	12 0.8
		09.83- 03.86	CA190IR	14 35	09.83- 03.86	CS278	12 0.85
		09.83- 03.86	CA611R	14 45			
	Orion 1.4	[F6B]	02.87- 07.90	CA1227IR	14 55 A31	02.87- 07.90	CS278
02.87- 07.90			CA226IR	14 55	02.87- 07.90	CS592	12 0.9
02.87- 07.90			CA305IR	14 55	02.87- 07.90	CS123	12 0.8
02.87- 07.90			CA325IR	14 70	AT 02.87- 07.90	CS357	12 1.4
02.87- 08.88			CA96IR	14 55			
[F6D]	02.87- 07.90	CA1227IR	14 55 A31	02.87- 07.90	CS278	12 0.85	
	02.87- 07.90	CA226IR	14 55	02.87- 07.90	CS592	12 0.9	
	02.87- 07.90	CA305IR	14 55	AT 02.87- 07.90	CS357	12 1.4	
	02.87- 07.90	CA325IR	14 70	02.87- 07.90	CS123	12 0.8	
	02.87- 08.88	CA96IR	14 55				
[F6F]	07.90- 12.93	CA325IR	14 70	07.90- 12.93	CS592	12 0.9	
	ACPS 07.90- 01.92	CA738IR	14 70	07.90- 12.93	CS278	12 0.85	
[F6G]	07.90- 12.93	CA325IR	14 70	07.90- 12.93	CS592	12 0.9	
	ACPS 07.90- 01.92	CA738IR	14 70	07.90- 12.93	CS278	12 0.85	
[FUA]	12.85- 07.90	CA1227IR	14 55 A31	12.85- 07.90	CS123	12 0.8	
	12.85- 07.90	CA226IR	14 55	AT 12.85- 07.90	CS357	12 1.4	
	12.85- 07.90	CA305IR	14 55	12.85- 07.90	CS278	12 0.85	
	12.85- 07.90	CA325IR	14 70	12.85- 07.90	CS592	12 0.9	
	12.85- 08.88	CA96IR	14 55				
[FUC]	07.86- 07.90	CA1227IR	14 55 A31	AT 01.86- 07.90	CS357	12 1.4	
	07.86- 07.90	CA226IR	14 55	01.86- 07.90	CS123	12 0.8	
	07.86- 07.90	CA305IR	14 55	01.86- 07.90	CS278	12 0.85	
	07.86- 07.90	CA325IR	14 70	02.87- 07.90	CS592	12 0.9	
	07.86- 08.88	CA96IR	14 55				
[FUH]	07.90- 12.93	CA1554IR	14 70 A31	07.90- 12.93	CS592	12 0.9	
	07.90- 12.93	CA325IR	14 70 ▲				
Orion 1.6	[LP1]	07.83- 03.86	CA126IR	14 45	AT 07.83- 03.86	CS278	12 0.85
		07.83- 03.86	CA190IR	14 35	07.83- 03.86	CS123	12 0.8
		07.83- 03.86	CA226IR	14 55			
		07.83- 03.86	CA611R	14 45			
		07.83- 03.86	CA96IR	14 55			
	[LPA]	08.85- 03.86	CA325IR	14 70			
		07.83- 03.86	CA126IR	14 45	AT 07.83- 03.86	CS278	12 0.85
		07.83- 03.86	CA190IR	14 35	07.83- 03.86	CS123	12 0.8
		07.83- 03.86	CA226IR	14 55			
		07.83- 03.86	CA611R	14 45			
	[LUC]	07.83- 03.86	CA96IR	14 55			
		08.85- 03.86	CA325IR	14 70			
		12.85- 07.90	CA1227IR	14 55 A31	12.85- 07.90	CS278	12 0.85
		12.85- 07.90	CA226IR	14 55	AT 12.85- 07.90	CS357	12 1.4
		12.85- 07.90	CA305IR	14 55	12.85- 07.90	CS592	12 0.9
[LUJ]	12.85- 07.90	CA325IR	14 70				
	12.85- 08.88	CA96IR	14 55				
[LUK]	07.90- 12.92	CA1554IR	14 70 A31	07.90- 12.92	CS592	12 0.9	
	07.90- 12.92	CA325IR	14 70 ▲	07.90- 12.92	CS724	12 1.1	
Orion 1.6 i 16V	[L1E]	07.90- 12.93	CA325IR	14 70	07.90- 12.93	CS592	12 0.9
		09.92- 12.93	CA738IR	14 70	09.92- 12.93	CS724	12 1.1
09.92- 12.93		CA739IR	14 90				
[L1K]	07.90- 12.93	CA325IR	14 70	07.90- 12.93	CS592	12 0.9	
	09.92- 12.93	CA738IR	14 70	09.92- 12.93	CS724	12 1.1	
	09.92- 12.93	CA739IR	14 90				
Orion 1.6 i	[L4B]	03.86- 07.90	CA226IR	14 55	03.86- 07.90	CS357	12 1.4
		03.86- 07.90	CA305IR	14 55	03.86- 07.90	CS278	12 0.85
		03.86- 07.90	CA325IR	14 70			
		03.86- 08.88	CA96IR	14 55			
	[LJB]	08.89- 07.90	CA325IR	14 70	08.89- 07.90	CS357	12 1.4
		07.90- 09.92	CA325IR	14 70	07.90- 09.92	CS592	12 0.9
	[LJF]	PS 07.90- 09.92	CA738IR	14 70	07.90- 09.92	CS278	12 0.85
		AC 07.90- 09.92	CA738IR	14 70			
	[LR1]	07.83- 03.86	CA126IR	14 45	07.83- 03.86	CS357	12 1.4
		07.83- 03.86	CA226IR	14 55	AT 07.83- 03.86	CS278	12 0.85
		07.83- 03.86	CA305IR	14 55			
		07.83- 03.86	CA611R	14 45			
		07.83- 03.86	CA96IR	14 55			
	[LRA]	08.85- 03.86	CA325IR	14 70			
		07.83- 03.86	CA126IR	14 45	AT 07.83- 03.86	CS278	12 0.85
07.83- 03.86		CA226IR	14 55	07.83- 03.86	CS357	12 1.4	
07.83- 03.86		CA305IR	14 55				
07.83- 03.86		CA611R	14 45				
[LRB]	07.83- 03.86	CA96IR	14 55				
	08.85- 03.86	CA325IR	14 70				
	03.86- 07.90	CA226IR	14 55	03.86- 07.90	CS357	12 1.4	
	03.86- 07.90	CA305IR	14 55	03.86- 07.90	CS278	12 0.85	
	03.86- 07.90	CA325IR	14 70				
Orion 1.6 Diesel	[LTA]	03.86- 08.88	CA96IR	14 55			
		02.84- 03.86	CA306IR	14 55	02.84- 03.86	CS341	12 1.7
02.84- 03.86		CA650IR	14 70				
[LTC]	12.85- 07.90	CA306IR	14 55	12.85- 07.90	CS341	12 1.7	
	12.85- 07.90	CA650IR	14 70				





Orion 1.8 i 16V	[RDA]	02.92- 12.93	CA738IR	14 70	02.92- 12.93	CS685	12 1.4	
		02.92- 12.93	CA739IR	14 90	02.92- 12.93	CS724	12 1.1	
	[RQB]	01.92- 12.93	CA738IR	14 70	01.92- 12.93	CS685	12 1.4	
Orion 1.8 Diesel	[RTA]	01.92- 12.93	CA739IR	14 90	01.92- 12.93	CS724	12 1.1	
		01.89- 07.90	CA306IR	14 55	A13 01.89- 07.90	CS613	12 2.2	
		01.89- 07.90	CA561IR	14 55	01.89- 07.90	CS341	12 1.7	
	[RTB]	01.89- 07.90	CA650IR	14 70				
		01.89- 07.90	CA306IR	14 55	A13 01.89- 07.90	CS613	12 2.2	
		01.89- 07.90	CA561IR	14 55	01.89- 07.90	CS341	12 1.7	
	[RTE]	01.89- 07.90	CA650IR	14 70				
		07.90- 12.93	CA306IR	14 55	07.90- 12.93	CS613	12 2.2	
		07.90- 12.93	CA561IR	14 55				
	[RTF]	07.90- 12.93	CA650IR	14 70				
		07.90- 12.93	CA306IR	14 55	07.90- 12.93	CS613	12 2.2	
		07.90- 12.93	CA561IR	14 55				
	[RTH]	07.90- 12.93	CA650IR	14 70				
		07.90- 12.93	CA306IR	14 55	07.90- 12.93	CS613	12 2.2	
		07.90- 12.93	CA561IR	14 55				
Orion 1.8 TD	[RFD]	07.90- 12.93	CA650IR	14 70				
		03.92- 12.93	CA561IR	14 55	03.92- 12.93	CS341	12 1.7	
	[RFK]	03.92- 12.93	CA856IR	14 70	03.92- 12.93	CS613	12 2.2	
		03.92- 12.93	CA561IR	14 55	03.92- 12.93	CS613	12 2.2	
P 100 1.6	[LCR]	03.92- 12.93	CA856IR	14 70	03.92- 12.93	CS341	12 1.7	
		04.82- 09.87	CA17v	14 34	04.82- 09.87	CS329	12 1.4	
P 100 1.8 TD	[RFA]	04.82- 09.87	CA584IR	14 55	04.82- 09.87	CS86	12 1.0	
P 100 2.0	[NAE]	10.87- 12.92	CA94IR	14 55	10.87- 12.92	CS541	12 1.8	
Probe 2.0 16V	[FS]	10.87- 12.92	CA94IR	14 55	RHD 10.87- 12.92	CS709	12 2.2	
Probe 2.2		10.87- 12.92	CA94IR	14 55	10.87- 12.92	CS329	12 1.4	
Probe 2.2 GT		10.92- 09.96	JA755IR	14 80	10.92- 03.98	JS747	12 1.7	
Probe 2.5 V6 24V	[KL]	10.92- 07.93	JA755IR	14 80				
Probe 3.0 V6		03.91- 12.92	JA755IR	14 80				
Puma 1.4 16V	[FHD]	10.92- 03.98	JA806IR	14 90				
		09.89- 07.93	JA755IR	14 80				
	[FHF]	11.97- 08.98	CA1137IR	14 70	02.98- 11.00	CS1050	12 1.1	
Puma 1.6 16V	[L1W]	08.98- 11.00	CA1474IR	14 70	02.98- 11.00	CS960	12 0.9	
		11.97- 08.98	CA1137IR	14 70	01.98- 11.00	CS960	12 0.9	
	[ZH17]	01.98- 11.00	CA1474IR	14 70	01.98- 11.00	CS1050	12 1.1	
Puma 1.7 ST 160	[MHA]	08.00- 12.01	CA1474IR	14 70	08.00- 12.01	CS1050	12 1.1	
		06.99-	CA1137IR	14 70	06.99-	CS960	12 0.9	
Puma 1.7 16V	[MHB]	03.97-	CA1137IR	14 70	03.97-	CS1050	12 1.1	
		03.97-	CA1137IR	14 70	03.97-	CS1050	12 1.1	
Ranger 2.5 Diesel	[WL]	02.99- 04.02	CA1839IR	14 75	02.99- 04.02	JS1352	12 2.2	
		10.99- 04.02	JA1530IR	14 70				
Ranger 2.5 Diesel 4x4	[WL]	02.99- 04.02	CA1839IR	14 75	02.99- 04.02	JS1352	12 2.2	
		10.99- 04.02	JA1530IR	14 70				
Ranger 2.5 TD		04.02- 01.06	JA1530IR	14 70	04.02-	JS1352	12 2.2	
Ranger 2.5 TD 4x4	[WL-T]	10.99- 01.06	JA1530IR	14 70	10.99-	JS1352	12 2.2	
Ranger 2.5 TDCi 4x4	[WLAA]	04.02- 01.06	JA1530IR	14 70	04.02-	JS1352	12 2.2	
Ranger 3.0 TDCi 4x4	[WEAT]	05.06- 12.11	JA1530IR	14 70	05.06- 12.11	JS1352	12 2.2	
Scorpio 1.8	[REC]	05.06-	JA1530IR	14 70	05.06-	JS1352	12 2.2	
		04.85- 02.92	CA293IR	14 55	AT 04.85- 02.92	CS330	12 1.4	
		04.85- 02.92	CA322IR	14 90	09.85- 02.92	CS329	12 1.4	
		09.85- 02.92	CA299IR	14 70	04.85- 09.85	CS86	12 1.0	
Scorpio 2.0	[N8A]	11.88- 10.92	CA1682IR	14 70	AT 11.88- 10.92	CS330	12 1.4	
		11.88- 10.92	CA562IR	14 70				
		11.88- 10.92	CA563IR	14 90				
	[N8D]	05.89- 02.92	CA562IR	14 70	05.89- 02.92	CS330	12 1.4	
		05.89- 02.92	CA563IR	14 90				
	[N9D]	05.89- 02.92	CA562IR	14 70	05.89- 02.92	CS330	12 1.4	
		05.89- 02.92	CA563IR	14 90	05.89- 02.92	CS562	12 1.0	
	[NEL]	04.85- 08.89	CA293IR	14 55	09.85- 08.89	CS329	12 1.4	
		04.85- 08.89	CA322IR	14 90	04.85- 09.85	CS86	12 1.0	
		09.85- 08.89	CA299IR	14 70	AT 04.85- 08.89	CS330	12 1.4	
	Scorpio 2.0 i 16V	[N3A]	10.94- 12.98	CA1071IR	14 90	10.94- 12.98	CS562	12 1.0
	Scorpio 2.0 i	[N9B]	10.94- 12.98	CA1071IR	14 90	10.94- 12.98	CS330	12 1.4
05.89- 02.92			CA563IR	14 90	05.89- 02.92	CS330	12 1.4	
[N9D]		05.89- 02.92	CA562IR	14 70	05.89- 02.92	CS330	12 1.4	
		05.89- 02.92	CA563IR	14 90	05.89- 02.92	CS562	12 1.0	
[N9F]		09.91- 12.94	CA562IR	14 70	09.91- 12.94	CS330	12 1.4	
		09.91- 12.94	CA563IR	14 90	09.91- 12.94	CS562	12 1.0	
[NRA]		04.85- 02.92	CA322IR	14 90	AT 04.85- 02.92	CS330	12 1.4	
		09.85- 02.92	CA299IR	14 70	09.85- 02.92	CS329	12 1.4	
		04.85- 09.85	CS86	12 1.0				
[NRC]		10.85- 12.90	CA299IR	14 70	10.85- 12.90	CS329	12 1.4	
		10.85- 12.90	CA322IR	14 90	AT 10.85- 12.90	CS330	12 1.4	
[NRI]		09.85- 02.92	CA299IR	14 70	AT 09.85- 12.94	CS330	12 1.4	
		09.85- 02.92	CA322IR	14 90	02.92- 12.94	CS562	12 1.0	
[NSD]		02.92- 12.94	CA562IR	14 70	09.85- 02.92	CS329	12 1.4	
		02.92- 12.94	CA563IR	14 90				
	10.94- 12.98	CA1071IR	14 90	10.94- 12.98	CS330	12 1.4		
Scorpio 2.3 i 16V	[Y5A]	10.94- 12.98	CA1071IR	14 90	10.94- 12.98	CS562	12 1.0	
Scorpio 2.4 i	[ARC]	06.96- 08.98	CA1071IR	14 90	06.96- 08.98	CS330	12 1.4	
		09.86- 09.88	CA324IR	14 90	09.86- 09.88	CS328	12 1.4	
	[ARD]	10.88- 12.94	CA324IR	14 90	10.88- 12.94	CS328	12 1.4	
		10.88- 02.92	CA324IR	14 90	10.88- 02.92	CS328	12 1.4	
Scorpio 2.5 Diesel	[SCB]	10.88- 02.92	CA324IR	14 90				
		08.93- 09.94	CA94IR	14 55				
	[SFA]	02.92- 12.94	CA299IR	14 70				
		02.92- 12.94	CA322IR	14 90				
		02.92- 12.94	CA96IR	14 55				
	[SFB]	02.92- 12.94	CA299IR	14 70				
		02.92- 12.94	CA322IR	14 90				
		02.92- 12.94	CA96IR	14 55				
	[STR]	RHD	12.85- 12.94	CA299IR	14 70			
			12.85- 02.92	CA322IR	14 90			
			12.85- 12.94	CA96IR	14 55			
		RHD	12.89- 12.94	CA293IR	14 55			
			12.89- 12.94	CA306IR	14 55			
			12.89- 12.94	CA322IR	14 90			
			12.89- 12.94	CA650IR	14 70			
		10.90- 08.92	CA322IR	14 90				
		10.90- 08.92	CA299IR	14 70				
		10.90- 08.92	CA96IR	14 55				



**FORD** *Continued*

Scorpio 2.5 TD	[SCB]	08.93- 09.94	CA941R	14 55				
	[SFA]	06.88- 02.92	CA2991R	14 70				
		06.88- 02.92	CA3221R	14 90				
		06.88- 02.92	CA961R	14 55				
	[SFB]	06.88- 02.92	CA2991R	14 70				
		06.88- 02.92	CA3221R	14 90				
06.88- 02.92		CA961R	14 55					
[VM]	09.96- 08.98	CA10311R	14 70					
	09.96- 08.98	CA7191R	14 70					
Scorpio 2.8 i	[PRE]	04.85- 11.86	CA2261R	14 55	04.85- 11.86	CS328	12 1.4	
		04.85- 11.86	CA3051R	14 55				
		04.85- 11.86	CA3241R	14 90				
		04.85- 11.86	CA961R	14 55				
Scorpio 2.8 i 4x4	[PRE]	10.85- 11.86	CA2261R	14 55				
		10.85- 11.86	CA3051R	14 55				
		10.85- 11.86	CA3241R	14 90				
		10.85- 11.86	CA961R	14 55				
Scorpio 2.9 24V	[BOA]	08.93- 09.94	CA3241R	14 90	08.93- 09.94	CS328	12 1.4 BO	
		08.93- 09.94	CA5631R	14 90	08.93- 09.94	CS625#	12 1.1 LU	
Scorpio 2.9 i 24V	[BOA]	04.91- 09.94	CA3241R	14 90	04.91- 09.94	CS328	12 1.4 BO	
					04.91- 09.94	CS625#	12 1.1 LU	
Scorpio 2.9 i	[BOB]	10.94- 12.98	CA10851R	14 100				
	[BRC]	09.86- 02.92	CA3241R	14 90	09.86- 02.92	CS625#	12 1.1 LU	
				09.86- 02.92	CS328	12 1.4 BO		
09.86- 12.94		CA3241R	14 90	09.86- 12.94	CS328	12 1.4 BO		
02.92- 09.94		CA5631R	14 90	09.86- 12.94	CS625#	12 1.1 LU		
08.86- 02.92		CA3241R	14 90	09.86- 09.94	CS625#	12 1.1 LU		
				09.86- 02.92	CS328	12 1.4 BO		
09.91- 12.94		CA3241R	14 90	09.91- 12.94	CS328	12 1.4 BO		
Scorpio 2.9 i 4x4	[BRC]	02.95- 12.98	CA10851R	14 100	09.91- 12.94	CS625#	12 1.1 LU	
					02.95- 08.98	CS625#	12 1.1 LU	
					02.95- 12.98	CS328	12 1.4 BO	
		09.86- 02.92	CA3241R	14 90	09.86- 02.92	CS625#	12 1.1 LU	
Sierra 1.3	[JCT]	08.82- 12.86	CA2931R	14 55	AT 08.82- 12.86	CS329	12 1.4	
		08.82- 10.84	CA601R	14 45				
		08.82- 10.84	CA941R	14 55				
		10.84- 12.86	CA2991R	14 70				
Sierra 1.6	[LCS]	08.82- 12.86	CA2931R	14 55	A13 08.85- 12.86	CS329	12 1.4	
		08.82- 10.84	CA601R	14 45	A34 08.82- 10.84	CS86	12 1.0	
		08.82- 10.84	CA941R	14 55	A34 08.82- 12.86	CS78	12 0.75	
		10.84- 12.86	CA2991R	14 70	RHD 08.85- 12.86	CS708	12 0.85	
	[LCT]	08.82- 12.86	CA2931R	14 55	RHD 08.85- 12.86	CS708	12 0.85	
		08.82- 10.84	CA601R	14 45	A13 08.85- 12.86	CS329	12 1.4	
		08.82- 10.84	CA941R	14 55	A34 08.82- 12.86	CS78	12 0.75	
		10.84- 12.86	CA2991R	14 70	A34 08.82- 10.84	CS86	12 1.0	
	[LSD]	08.82- 12.86	CA2931R	14 55	RHD 08.85- 12.86	CS708	12 0.85	
		08.82- 10.84	CA601R	14 45	A34 08.82- 10.84	CS86	12 1.0	
		08.82- 10.84	CA941R	14 55	A13 08.85- 12.86	CS329	12 1.4	
		10.84- 12.86	CA2991R	14 70	A34 08.82- 12.86	CS78	12 0.75	
	[LSE]	01.87- 02.93	CA2931R	14 55	01.87- 02.93	CS329	12 1.4	
		01.87- 02.93	CA2991R	14 70				
		01.87- 02.93	CA3221R	14 90				
		01.87- 02.93	CA941R	14 55				
[LSF]	01.88- 02.93	CA2931R	14 55	01.88- 02.93	CS329	12 1.4		
	01.88- 02.93	CA2991R	14 70					
	01.88- 02.93	CA3221R	14 90					
	01.88- 02.93	CA941R	14 55					
Sierra 1.6 i	[L6B]			10.89- 02.93	CS562	12 1.0		
Sierra 1.8	[R2A (XU102C)]			A13 05.88- 02.93	CS330	12 1.4		
				05.88- 02.93	CS562	12 1.0		
	[R2C]			A13 05.88- 02.93	CS330	12 1.4		
				AT 05.88- 02.93	CS330	12 1.4		
	[R6A]			05.88- 02.93	CS562	12 1.0		
				A13 04.92- 02.93	CS330	12 1.4		
	[REB]			04.92- 02.93	CS330	12 1.4		
				04.92- 02.93	CS562	12 1.0		
	[RED]	10.84- 12.86	CA2931R	14 55	A13 10.84- 12.86	CS329	12 1.4	
		10.84- 12.86	CA2991R	14 70	10.84- 12.86	CS78	12 0.75	
	[REF]	01.87- 05.88	CA2931R	14 55	01.87- 05.88	CS329	12 1.4	
		01.87- 05.88	CA2991R	14 70	RHD 01.87- 05.88	CS708	12 0.85	
01.87- 05.88		CA3061R	14 55	AT 01.87- 05.88	CS330	12 1.4		
01.87- 05.88		CA3221R	14 90	01.87- 05.88	CS78	12 0.75		
01.87- 05.88		CA941R	14 55					
Sierra 1.8 TD	[RFA]	10.87- 05.88	CA2931R	14 55	RHD 10.87- 05.88	CS708	12 0.85	
		10.87- 05.88	CA2991R	14 70	10.87- 05.88	CS78	12 0.75	
		10.87- 05.88	CA3061R	14 55	10.87- 05.88	CS329	12 1.4	
		10.87- 05.88	CA3221R	14 90	AT 10.87- 05.88	CS330	12 1.4	
		10.87- 05.88	CA941R	14 55				
Sierra 2.0	[RFB]	08.88- 02.93	CA5841R	14 55	08.88- 02.93	CS541	12 1.8	
	[RFL]	08.88- 02.93	CA5841R	14 55	08.88- 02.93	CS541	12 1.8	
	[N5B]	01.87- 12.90	CA3221R	14 90	01.87- 12.90	CS685	12 1.4	
Sierra 2.0	[N8C]	01.87- 12.90	CA3241R	14 90				
		01.87- 02.93	CA16921R#	14 70	05.89- 08.90	CS562	12 1.0	
	05.89- 02.93	CA5621R	14 70	05.89- 02.93	CS330	12 1.4		
	05.89- 02.93	CA5631R	14 90					
	[NES]	01.87- 02.93	CA2931R	14 55	AT 01.87- 02.93	CS330	12 1.4	
		01.87- 02.93	CA2991R	14 70	01.87- 02.93	CS78	12 0.75	
		01.87- 02.93	CA3061R	14 55	RHD 01.87- 07.90	CS708	12 0.85	
		01.87- 02.93	CA3221R	14 90	01.87- 02.93	CS329	12 1.4	
	[NET]	[NET]	01.87- 02.93	CA941R	14 55			
			08.82- 10.84	CA601R	14 45	AT 08.82- 12.86	CS78	12 0.75
08.82- 10.84			CA941R	14 55	AT 08.85- 12.86	CS330	12 1.4	
10.84- 12.86			CA2931R	14 55	08.85- 12.86	CS329	12 1.4	
			10.84- 12.86	CA2991R	14 70	08.82- 10.84	CS86	12 1.0



	[NR2]	08.85- 12.86 08.85- 12.86	CA293IR CA299IR	14 55 14 70		08.85- 12.86 A13 08.85- 12.86 AT 08.85- 12.86	CS78 CS329 CS330	12 0.75 12 1.4 12 1.4
	[NRB]	03.85- 12.86 03.85- 12.86	CA293IR CA299IR	14 55 14 70		AT 08.85- 12.86 03.85- 12.86 A13 08.85- 12.86	CS330 CS78 CS329	12 1.4 12 0.75 12 1.4
	[NRD]	10.85- 12.86 10.85- 12.86	CA293IR CA299IR	14 55 14 70		AT 10.85- 12.86 10.85- 12.86	CS330 CS329	12 1.4 12 1.4
	[NYT]	08.82- 10.84 08.82- 10.84	CA126IR CA226IR	14 45 14 55		08.82- 10.84	CS69	12 0.8
Sierra 2.0 4x4	[N9C]	05.89- 02.93 05.89- 02.93 01.90- 02.93	CA1692IR# CA562IR CA563IR	14 70 14 70 14 90		01.90- 02.93 05.89- 02.93	CS786 CS330	12 1.4 12 1.4
Sierra 2.0 RS Cosworth	[N5B]	11.87- 01.90 11.87- 01.90	CA299IR CA322IR	14 70 14 90		11.87- 01.90	CS357	12 1.4
Sierra 2.0 XR4i	[N9C]	01.90- 02.93 01.90- 02.93	CA1692IR# CA562IR	14 70 14 70		01.90- 02.93	CS786	12 1.4
Sierra 2.0 16V 4x4 Cosworth	[N5C]	01.90- 02.93	CA299IR	14 70		01.90- 02.93	CS787	12 1.4
Sierra 2.0 16V Cosworth 4X4	[N5C]	01.90- 02.93 01.90- 02.93	CA299IR CA322IR	14 70 14 90		01.90- 12.92 01.93- 02.93	CS357 CS685	12 1.4 12 1.4
	[N5D]	01.90- 02.93 01.90- 02.93	CA299IR CA322IR	14 70 14 90		01.90- 12.92 01.93- 02.93	CS357 CS685	12 1.4 12 1.4
Sierra 2.0 i	[N4A]	01.87- 02.93 01.87- 02.93 01.87- 02.93 01.87- 02.93 01.87- 02.93	CA293IR CA299IR CA306IR CA322IR CA94IR	14 55 14 70 14 55 14 90 14 55		01.87- 10.89 01.87- 02.93 RHD 01.87- 07.90 AT 01.87- 02.93	CS78 CS329 CS708 CS330	12 0.75 12 1.4 12 0.85 12 1.4
	[N4B]	01.87- 02.93 01.87- 02.93 01.87- 02.93 01.87- 02.93 01.87- 02.93	CA293IR CA299IR CA306IR CA322IR CA94IR	14 55 14 70 14 55 14 90 14 55		AT 01.87- 02.93 01.87- 02.93	CS330 CS329	12 1.4 12 1.4
	[N4I]	01.87- 10.89 01.87- 10.89 01.87- 10.89 01.87- 10.89 01.87- 10.89	CA293IR CA299IR CA306IR CA322IR CA94IR	14 55 14 70 14 55 14 90 14 55		01.87- 10.89 RHD 01.87- 10.89 AT 01.87- 10.89 01.87- 10.89	CS78 CS708 CS330 CS329	12 0.75 12 0.85 12 1.4 12 1.4
	[N8A]	06.89- 02.93 06.89- 02.93 06.89- 02.93	CA1692IR# CA562IR CA563IR	14 70 14 70 14 90		06.89- 08.90 06.89- 02.93	CS562 CS330	12 1.0 12 1.4
	[N9B]	06.89- 02.93 06.89- 02.93	CA562IR CA563IR	14 70 14 90		06.89- 08.90 06.89- 02.93	CS562 CS330	12 1.0 12 1.4
	[N9C]	05.89- 02.93 05.89- 02.93 05.89- 02.93	CA1692IR# CA562IR CA563IR	14 70 14 70 14 90		05.89- 02.93 05.89- 08.90	CS330 CS562	12 1.4 12 1.0
	[N9E]	12.91- 02.93 12.91- 02.93	CA562IR CA563IR	14 70 14 90		12.91- 02.93	CS330	12 1.4
	[NE5]	01.87- 12.92 01.87- 12.92 01.87- 12.92 01.87- 12.92 01.87- 12.92	CA293IR CA299IR CA306IR CA322IR CA94IR	14 55 14 70 14 55 14 90 14 55		AT 01.87- 12.92 01.87- 12.92 AT 10.87- 02.93	CS330 CS329 CS562	12 1.4 12 1.4 12 1.0
	[NEJ]	01.87- 12.92 01.87- 12.92 01.87- 12.92 01.87- 12.92 01.87- 12.92	CA293IR CA299IR CA306IR CA322IR CA94IR	14 55 14 70 14 55 14 90 14 55		01.87- 12.92 AT 01.87- 12.92	CS329 CS330	12 1.4 12 1.4
	[NR2]	08.85- 12.86 08.85- 12.86	CA293IR CA299IR	14 55 14 70		AT 08.85- 12.86 08.85- 12.86 A13 08.85- 12.86	CS330 CS78 CS329	12 1.4 12 0.75 12 1.4
	[NRB]	03.85- 12.86 03.85- 12.86	CA293IR CA299IR	14 55 14 70		AT 08.85- 12.86 03.85- 12.86 A13 08.85- 12.86	CS330 CS78 CS329	12 1.4 12 0.75 12 1.4
Sierra 2.3	[YYT]	08.82- 12.86 08.82- 12.86	CA126IR CA305IR	14 45 14 55		08.82- 12.86	CS69	12 0.8
Sierra 2.3 Diesel	[YTR]	01.87- 09.89 01.87- 09.89 01.87- 09.89 01.87- 09.89	CA293IR CA299IR CA306IR CA650IR	14 55 14 70 14 55 14 70				
	[YTT]	08.82- 12.86 08.82- 12.86 04.85- 12.86	CA226IR CA96IR CA299IR	14 55 14 55 14 70				
Sierra 2.8 4x4	[PRG]	01.87- 08.88 01.87- 08.88 01.87- 08.88	CA226IR CA305IR CA324IR	14 55 14 55 14 90				
Sierra 2.8 XR 4x4	[PRT]	02.85- 12.86 02.85- 12.86	CA226IR CA305IR	14 55 14 55				
Sierra 2.8 XR4i	[PR5]	08.82- 12.86 08.82- 12.86	CA226IR CA305IR	14 55 14 55		08.82- 12.85 02.85- 12.86	CS72 CS328	12 1.1 12 1.4
	[PR6]	08.82- 12.86 08.82- 12.86	CA226IR CA305IR	14 55 14 55		02.85- 12.86 08.82- 12.85	CS328 CS72	12 1.4 12 1.1
	[PRT]	08.82- 02.85 08.82- 02.85	CA226IR CA305IR	14 55 14 55		08.82- 02.85	CS72	12 1.1
Sierra 2.8 i XR 4X4	[PR5]	09.83- 12.86 10.84- 08.85	CA226IR CA305IR	14 55 14 55				
	[PR7]	01.87- 02.93	CA226IR	14 55				
	[PRG]	01.87- 08.88 01.87- 08.88 01.87- 08.88	CA226IR CA305IR CA324IR	14 55 14 55 14 90				
Sierra 2.8 i XR4	[PR5]	08.82- 12.86	CA226IR	14 55		01.86- 12.86 08.82- 12.86	CS328 CS72	12 1.4 12 1.1
Sierra 2.8 i	[PR7]	01.87- 02.93 01.87- 02.93	CA226IR CA324IR	14 55 14 90				
	[PR8]	01.87- 02.93 01.87- 02.93	CA226IR CA324IR	14 55 14 90				
Sierra 2.8 i 4x4	[PR6]	08.82- 12.86	CA226IR	14 55		01.86- 12.86	CS328	12 1.4
	[PR7]	01.87- 02.93 01.87- 02.93	CA226IR CA324IR	14 55 14 90				
		08.82- 12.86	CA226IR	14 55		01.86- 12.86	CS328	12 1.4
Sierra 2.9	[B4B]	08.88- 02.93	CA324IR	14 90		08.88- 02.93 08.88- 02.93	CS328 CS625#	12 1.4 BO 12 1.1 LU
	[B4C]	08.88- 02.93	CA324IR	14 90		08.88- 02.93	CS625# CS328	12 1.1 LU 12 1.4 BO



**FORD** *Continued*

Sierra 2.9 4x4	[B4B]	08.88- 02.93	CA324IR	14 90	08.88- 02.93	CS328	12 1.4	BO
					08.88- 02.93	CS625#	12 1.1	LU
	[B4C]	08.88- 02.93	CA324IR	14 90	08.88- 02.93	CS787	12 1.4	
					08.88- 02.93	CS625#	12 1.1	LU
Sierra 2.9 iXR 4x4	[B4A]	08.88- 02.93	CA324IR	14 90	08.88- 02.93	CS328	12 1.4	BO
					08.88- 02.93	CS787	12 1.4	
	[B4B]	08.88- 02.93	CA324IR	14 90	08.88- 02.93	CS625#	12 1.1	LU
					08.88- 02.93	CS328	12 1.4	BO
	[B4C]	08.88- 02.93	CA324IR	14 90	08.88- 02.93	CS625#	12 1.1	LU
					08.88- 02.93	CS328	12 1.4	BO
Sierra 2.9 i	[B4B]	08.88- 02.93	CA324IR	14 90	08.88- 02.93	CS625#	12 1.1	LU
					08.88- 02.93	CS328	12 1.4	BO
	[B4C]	08.88- 02.93	CA324IR	14 90	08.88- 02.93	CS625#	12 1.1	LU
					08.88- 02.93	CS328	12 1.4	BO
S-Max 1.8 TDCi	[FFWA]	01.07-	CA1919IR	14 150	01.07-	CS1408	12 2.0	
	[QYWA]				A13 05.06-	CS1408	12 2.0	
S-Max 2.0	[AOWA]	A22 05.06-	CA1919IR	14 150	05.06-	CS1429	12 1.4	
S-Max 2.0 SCTi EcoBoost	[TPBA]				03.06-	CS1403	12 1.2	
					07.10-	CS1403	12 1.2	
S-Max 2.0 TDCi	[AZWA]	03.06-	CA1970IR	14 150	03.06-	CS1377	12 2.2	
	[QXWA]	03.06-	CA1970IR	14 150	03.06-	CS1377	12 2.2	
	[QXWB]	03.06-	CA1970IR	14 150	03.06-	CS1377	12 2.2	
	[UKWA]				05.06-	CS1377	12 2.2	
S-Max 2.0 FlexFuel		11.07-	CA1970IR	14 150	11.07-	CS1377	12 2.2	
S-Max 2.2 TDCi	[Q4BA]	05.06-	CA1923IR	14 150	05.06-	CS1403	12 1.2	
					03.08-	CS1377	12 2.2	
S-Max 2.3					07.10-	CS1377	12 2.2	
S-Max 2.5 ST	[HUWA]	05.06-	CA1968IR	14 150	07.07-	CS1403	12 1.2	
Streetka 1.6 i		12.02-	CA2034IR	14 90	03.06-	CS1430	12 1.4	
Taurus 1.3	[JAC]	01.70- 07.82	CA60IR	14 45	01.70- 07.82	CS78	12 0.75	
		01.70- 07.82	CA94IR	14 55				
	[JCC]	07.79- 07.82	CA60IR	14 45	07.79- 07.82	CS78	12 0.75	
		07.79- 07.82	CA94IR	14 55				
Taurus 1.6		08.70- 02.76	CA94IR	14 55	08.70- 02.76	CS78	12 0.75	
		08.70- 02.76	CA60IR	14 45				
	[LAD]	01.74- 05.79	CA60IR	14 45	AT 01.74- 05.79	CS86	12 1.0	
		01.74- 05.79	CA94IR	14 55	01.74- 05.79	CS78	12 0.75	
Taurus 1.6 1600	[LAR]	07.79- 07.82	CA60IR	14 45	AT 07.79- 07.82	CS86	12 1.0	
		07.79- 07.82	CA94IR	14 55	07.79- 07.82	CS78	12 0.75	
	[LCJ]	08.70- 07.82	CA60IR	14 45	AT 05.75- 07.82	CS86	12 1.0	
		08.70- 07.82	CA94IR	14 55	08.70- 07.82	CS78	12 0.75	
Taurus 2.0		08.70- 08.79	CA94IR	14 55	09.76- 08.79	CS86	12 1.0	
		08.70- 08.79	CA60IR	14 45	08.70- 08.79	CS78	12 0.75	
	[LCJ]	01.70- 05.75	CA60IR	14 45	01.70- 05.75	CS78	12 0.75	
		01.70- 05.75	CA94IR	14 55				
Taurus 2.0 V6	[NEE]	08.73- 02.76	CA60IR	14 45				
		08.73- 02.76	CA94IR	14 55				
	[NER]	07.79- 07.82	CA60IR	14 45	07.79- 07.82	CS78	12 0.75	
		07.79- 07.82	CA94IR	14 55	AT 07.79- 07.82	CS86	12 1.0	
	[NWR]	07.79- 07.82	CA126IR	14 45	07.79- 07.82	CS69	12 0.8	
		07.79- 07.82	CA226IR	14 55	07.79- 07.82	CS72	12 1.1	
		07.79- 07.82	CA305IR	14 55				
	[NYR]	05.75- 05.79	CA126IR	14 45	05.75- 05.79	CS69	12 0.8	
Taurus 2.0 V6		05.75- 05.79	CA226IR	14 55	05.75- 05.79	CS72	12 1.1	
		08.73- 07.79	CA94IR	14 45				
		08.73- 07.79	CA60IR	14 45				
		08.70- 02.76	CA226IR	14 55	08.70- 02.76	CS69	12 0.8	
Taurus 2.3	[YYF]	08.70- 02.76	CA126IR	14 45				
		05.75- 07.79	CA126IR	14 45	05.75- 07.79	CS72	12 1.1	
		05.75- 07.79	CA226IR	14 55	05.75- 05.79	CS69	12 0.8	
	[YYR]	07.79- 07.82	CA126IR	14 45	07.79- 07.82	CS72	12 1.1	
Taurus 2.3		07.79- 07.82	CA226IR	14 55	07.79- 07.82	CS69	12 0.8	
		08.71- 02.76	CA226IR	14 55	08.71- 02.76	CS69	12 0.8	
		08.71- 02.76	CA126IR	14 45				
Tourneo 1.8 TDCi Connect	[RWPA]	08.06-	CA1857IR	14 125	08.06-	CS1336	12 1.4	
Transit 1.5	[EX]	12.68- 05.73	CA15h#	14 28	11.65- 05.73	CS69	12 0.8	
		05.72- 05.73	CA190IR	14 35				
Transit 1.6					11.65- 05.73	CS69	12 0.8	
	[4RB]	04.78- 12.85	CA190IR	14 35	11.77- 12.85	CS972	12 1.4	
Transit 1.6		04.78- 12.85	CA60IR	14 45	12.77- 10.86	CS69	12 0.8	
		04.78- 12.85	CA94IR	14 55				
		04.78- 12.85	CA96IR	14 55				
	[B]				11.77- 10.86	CS324	12 1.1	
Transit 1.6					11.77- 10.86	CS972	12 1.4	
	[LAT]	11.85- 09.91	CA293IR	14 55	11.85- 08.86	CS86	12 1.0	
		11.85- 09.91	CA306IR	14 55	11.85- 12.89	CS78	12 0.75	
		11.85- 09.91	CA322IR	14 90	AT 08.86- 09.91	CS330	12 1.4	
Transit 1.6		11.85- 09.91	CA650IR	14 70	08.86- 09.91	CS972	12 1.4	
					08.86- 01.89	CS324	12 1.1	
Transit 1.7	[EY]	04.71- 03.78	CA15h#	14 28	04.71- 03.78	CS69	12 0.8	
		04.71- 03.78	CA190IR	14 35				
Transit 1.7		01.71- 07.73	CA15h#	14 28	11.65- 07.73	CS69	12 0.8	
		05.72- 05.73	CA190IR	14 35				
Transit 1.7 FT100	[EY]	04.71- 03.78	CA15h#	14 28	04.71- 03.78	CS69	12 0.8	
		05.72- 03.78	CA190IR	14 35				
Transit 1.8 16V Connect	[EYPA]	06.02-	CA1857IR	14 125	06.02- 05.05	CS1107	12 1.4	
		AC 06.02-	CA1857IR	14 125				
Transit 1.8 16V Connect	[EYPC]	06.02-	CA1857IR	14 125	06.02- 05.05	CS1107	12 1.4	
		AC 06.02-	CA1857IR	14 125				
Transit 1.8 TD Connect	[HCPA]	06.02-	CA1857IR	14 125	06.02-	CS1336	12 1.4	
	[HCPB]	06.02-	CA1857IR	14 125	06.02-	CS1336	12 1.4	
Transit 1.8 TDCi Connect	[HCPA]	06.02-	CA1857IR	14 125	06.02-	CS1336	12 1.4	
	[HCPB]	06.02-	CA1857IR	14 125	06.02-	CS1336	12 1.4	
Transit 1.8 TDCi Connect DPF	[RWPA]	08.06-	CA1857IR	14 125	08.06-	CS1336	12 1.4	
Transit 1.8 TDDi Connect	[BHPA]	06.02-	CA1857IR	14 125	06.02-	CS1336	12 1.4	
Transit 2.0	[4RC]	11.77- 10.86	CA293IR	14 55	11.77- 10.86	CS324	12 1.1	
		11.77- 10.86	CA60IR	14 45	AT 11.77- 10.86	CS86	12 1.0	
		11.77- 10.86	CA94IR	14 55				



	[N6T]	10.88- 09.91	CA293IR	14 55	01.91- 09.92	CS785#	12 0.9
		10.88- 09.91	CA306IR	14 55	10.88- 09.91	CS324	12 1.1
		10.88- 09.91	CA322IR	14 90	10.88- 09.91	CS972	12 1.4
		10.88- 09.91	CA650IR	14 70	AT 10.88- 09.91	CS330	12 1.4
	[NAT]	11.85- 09.91	CA293IR	14 55	AT 08.86- 09.91	CS330	12 1.4
		11.85- 09.91	CA306IR	14 55	11.85- 02.89	CS78	12 0.75
		11.85- 09.91	CA322IR	14 90	11.85- 08.86	CS86	12 1.0
		11.85- 09.91	CA650IR	14 70	08.86- 09.91	CS972	12 1.4
					08.86- 09.91	CS324	12 1.1
				01.91- 09.92	CS785#	12 0.9	
	[NAV]	11.85- 09.91	CA293IR	14 55	08.86- 09.91	CS972	12 1.4
		11.85- 09.91	CA306IR	14 55	08.86- 09.91	CS324	12 1.1
		11.85- 09.91	CA322IR	14 90	11.85- 02.89	CS78	12 0.75
		11.85- 09.91	CA650IR	14 70	AT 08.86- 09.91	CS330	12 1.4
01.91- 09.92	CS785#				12 0.9		
				11.85- 08.86	CS86	12 1.0	
		09.91- 10.94	CA1046IR	14 70	09.91- 10.94	CS972	12 1.4
				09.91- 10.94	CS324	12 1.1	
		09.91- 10.94	CA1046IR	14 70	09.91- 10.94	CS972	12 1.4
				09.91- 10.94	CS324	12 1.1	
		08.94- 07.00	CA1230IR	14 100	08.94- 07.00	CS562	12 1.0
				08.94- 07.00	CS330	12 1.4	
		08.94- 07.00	CA1230IR	14 100	08.94- 07.00	CS330	12 1.4
				08.94- 07.00	CS562	12 1.0	
Transit 2.0 Tourneo		11.94- 12.00	CA1230IR	14 100	11.94- 12.00	CS330	12 1.4
				11.94- 12.00	CS562	12 1.0	
Transit 2.0 i		09.91- 10.94	CA1046IR	14 70	09.91- 10.94	CS972	12 1.4
				AT 09.91- 10.94	CS330	12 1.4	
				09.91- 10.94	CS324	12 1.1	
Transit 2.0 CNG		06.94- 03.00	CA1230IR	14 100	06.94- 03.00	CS562	12 1.0
				06.94- 03.00	CS330	12 1.4	
Transit 2.0 Diesel Di	[ABFA]	08.00-	CA1636IR	14 105	08.00-	CS1245	12 2.1
	[D3FA]	08.00-	CA1636IR	14 105	08.00-	CS1245	12 2.1
	[F3FA]	08.00-	CA1636IR	14 105	08.00-	CS1245	12 2.1
Transit 2.0 TDCi		08.02-	CA1636IR	14 105	08.02-	CS1245	12 2.1
Transit 2.2 TDCi	[P8FA]	04.06-	CA1928IR	14 150	04.06-	CS1421	12 2.0
	[P8FB]	04.06-	CA1928IR	14 150	04.06-	CS1421	12 2.0
	[PGFA]	10.07-	CA1928IR	14 150	10.07-	CS1421	12 2.0
	[QVFA]	04.06-	CA1928IR	14 150	04.06-	CS1421	12 2.0
	[QWFA]	04.06-	CA1928IR	14 150	04.06-	CS1421	12 2.0
		10.08-	CA1928IR	14 150	10.08-	CS1421	12 2.0
Transit 2.2 TDCi Tourneo	[PGFA]	10.07-	CA1928IR	14 150	10.07-	CS1421	12 2.0
	[QVFA]	07.06-	CA1928IR	14 150	07.06-	CS1421	12 2.0
	[QWFA]	07.06-	CA1928IR	14 150	07.06-	CS1421	12 2.0
		10.08-	CA1928IR	14 150	10.08-	CS1421	12 2.0
Transit 2.3				03.01- 03.06	CS330	12 1.4	
				03.01- 03.06	CS330	12 1.4	
Transit 2.3 16V	[E5FA]				04.01-	CS330	12 1.4
	[E5FC]				04.01-	CS330	12 1.4
	[GZFA]				04.06-	CS1403	12 1.2
Transit 2.3 FT 100		05.72- 03.78	CA190IR	14 35	11.71- 03.78	CS69	12 0.8
		11.71- 03.78	CA15h#	14 28			
Transit 2.4 TDE		01.00-	CA1639IR	14 75	01.00-	CS1245	12 2.1
		10.02-	CA1779IR	14 110			
Transit 2.4 Diesel Di	[D2FA]	01.00-	CA1639IR	14 75	01.00-	CS1245	12 2.1
		01.00-	CA1779IR	14 110			
	[D2FB]	01.00-	CA1639IR	14 75	01.00-	CS1245	12 2.1
		01.00-	CA1779IR	14 110			
	[D2FE]	01.00-	CA1639IR	14 75	01.00-	CS1245	12 2.1
		10.02-	CA1779IR	14 110			
	[D4FA]	01.00-	CA1639IR	14 75	01.00-	CS1245	12 2.1
		10.02-	CA1779IR	14 110			
[F4FA]	01.00-	CA1639IR	14 75	01.00-	CS1245	12 2.1	
	10.02-	CA1779IR	14 110				
Transit 2.4 Diesel		01.77- 05.84	CA190IR	14 35	01.77- 05.84	CS337	12 2.5
		01.77- 05.84	CA96IR	14 55			
Transit 2.4 TD 4x4	[F4FA]	08.00- 08.03	CA1639IR	14 75	08.00- 08.03	CS1245	12 2.1
		08.00- 08.03	CA1779IR	14 110			
Transit 2.4 TDCi	[H9FA]	03.04-	CA1639IR	14 75	03.04-	CS1245	12 2.1
	[H9FB]	04.06-	CA1922IR	14 150	04.06-	CS1421	12 2.0
	[JXFA]	04.06-	CA1922IR	14 150	04.06-	CS1421	12 2.0
	[PHFA]	04.06-	CA1922IR	14 150	04.06-	CS1421	12 2.0
	[PHFC]	04.06-	CA1922IR	14 150	04.06-	CS1421	12 2.0
Transit 2.4 TDCi 4x4		07.06-	CA1922IR	14 150	07.06-	CS1421	12 2.0
Transit 2.4 TDDi		08.00- 08.03	CA1779IR	14 110	08.00- 08.03	CS1245	12 2.1
Transit 2.4 TDE	[DOFA]	01.00-	CA1639IR	14 75	01.00-	CS1245	12 2.1
		10.02-	CA1779IR	14 110			
	[FXFA]	03.04-	CA1639IR	14 75	03.04-	CS1245	12 2.1
Transit 2.5 Di Tourneo	[4FA]	11.94- 12.00	CA1030IR	14 55	11.94- 12.00	CS337	12 2.5
		11.94- 12.00	CA1031IR	14 70	11.94- 12.00	CS977	12 2.3
		11.94- 12.00	CA1317IR	14 95			
		11.94- 12.00	CA718IR	14 55			
		11.94- 12.00	CA719IR	14 70			
	[4FB]	11.94- 12.00	CA1030IR	14 55	11.94- 12.00	CS977	12 2.3
		11.94- 12.00	CA1031IR	14 70	11.94- 12.00	CS337	12 2.5
		11.94- 12.00	CA1317IR	14 95			
		11.94- 12.00	CA718IR	14 55			
		11.94- 12.00	CA719IR	14 70			
	[4FC]	11.94- 12.00	CA1030IR	14 55	11.94- 12.00	CS337	12 2.5
		11.94- 12.00	CA1031IR	14 70	11.94- 12.00	CS977	12 2.3
		11.94- 12.00	CA1317IR	14 95			
		11.94- 12.00	CA718IR	14 55			
		11.94- 12.00	CA719IR	14 70			
	[4FD]	11.94- 12.00	CA1030IR	14 55	11.94- 12.00	CS337	12 2.5
		11.94- 12.00	CA1031IR	14 70	11.94- 12.00	CS977	12 2.3
		11.94- 12.00	CA1317IR	14 95			
		11.94- 12.00	CA718IR	14 55			
		11.94- 12.00	CA719IR	14 70			
	[4HA]	11.94- 12.00	CA1030IR	14 55	11.94- 12.00	CS337	12 2.5
		11.94- 12.00	CA1031IR	14 70	11.94- 12.00	CS977	12 2.3
		11.94- 12.00	CA1317IR	14 95			
		11.94- 12.00	CA718IR	14 55			
11.94- 12.00		CA719IR	14 70				



**FORD** *Continued*

	[4HB]	11.94- 12.00 CA1030IR 14 55		11.94- 12.00 CS337 12 2.5
		11.94- 12.00 CA1031IR 14 70		11.94- 12.00 CS977 12 2.3
		11.94- 12.00 CA1317IR 14 95		
		11.94- 12.00 CA718IR 14 55		
		11.94- 12.00 CA719IR 14 70		
	[4HC]	11.94- 12.00 CA1030IR 14 55	11.94- 12.00 CS337 12 2.5	
		11.94- 12.00 CA1031IR 14 70	11.94- 12.00 CS977 12 2.3	
		11.94- 12.00 CA1317IR 14 95		
		11.94- 12.00 CA718IR 14 55		
		11.94- 12.00 CA719IR 14 70		
Transit 2.5 Diesel Di	[4BC]	05.91- 08.94 CA1030IR 14 55	08.91- 08.94 CS337 12 2.5	
		08.91- 08.94 CA1031IR 14 70		
		08.91- 08.94 CA718IR 14 55		
		08.91- 08.94 CA719IR 14 70		
	[4CC]	05.91- 08.94 CA1030IR 14 55	08.91- 08.94 CS337 12 2.5	
		08.91- 08.94 CA1031IR 14 70		
		08.91- 08.94 CA718IR 14 55		
		08.91- 08.94 CA719IR 14 70		
	[4DA]	08.91- 08.94 CA1030IR 14 55	08.91- 08.94 CS337 12 2.5	
		08.91- 08.94 CA1031IR 14 70		
		08.91- 08.94 CA718IR 14 55		
		08.91- 08.94 CA719IR 14 70		
	[4ED]	05.99- 03.00 CA1317IR 14 95	05.99- 03.00 CS977 12 2.3	
	[4FA]	08.91- 03.00 CA1030IR 14 55	08.91- 10.96 CS337 12 2.5	
		08.91- 07.97 CA1031IR 14 70	10.96- 08.00 CS977 12 2.3	
		08.91- 07.97 CA718IR 14 55		
		08.91- 07.97 CA719IR 14 70		
		08.97- 08.00 CA1317IR 14 95		
	[4FB]	08.94- 03.00 CA1030IR 14 55	10.96- 08.00 CS977 12 2.3	
		08.94- 07.97 CA1031IR 14 70	08.94- 10.96 CS337 12 2.5	
		08.94- 07.97 CA718IR 14 55		
		08.94- 07.97 CA719IR 14 70		
		08.97- 08.00 CA1317IR 14 95		
	[4FC]	08.94- 03.00 CA1030IR 14 55	10.96- 08.00 CS977 12 2.3	
		08.94- 07.97 CA1031IR 14 70	08.94- 10.96 CS337 12 2.5	
		08.94- 07.97 CA718IR 14 55		
		08.94- 07.97 CA719IR 14 70		
		08.97- 08.00 CA1317IR 14 95		
	[4FD]	06.94- 03.00 CA1030IR 14 55	06.94- 10.96 CS337 12 2.5	
		06.94- 07.97 CA1031IR 14 70	10.96- 08.00 CS977 12 2.3	
		06.94- 07.97 CA718IR 14 55		
		06.94- 07.97 CA719IR 14 70		
		08.97- 08.00 CA1317IR 14 95		
	[4GA]	10.92- 08.94 CA1030IR 14 55	10.92- 08.94 CS337 12 2.5	
		10.92- 08.94 CA1031IR 14 70		
		10.92- 08.94 CA718IR 14 55		
		10.92- 08.94 CA719IR 14 70		
	[4GB]	08.94- 07.97 CA1030IR 14 55	10.96- 08.00 CS977 12 2.3	
		08.94- 07.97 CA1031IR 14 70	08.94- 10.96 CS337 12 2.5	
		08.94- 07.97 CA718IR 14 55		
		08.94- 07.97 CA719IR 14 70		
		08.97- 08.00 CA1317IR 14 95		
	[4GC]	08.94- 07.97 CA1030IR 14 55	10.96- 08.00 CS977 12 2.3	
		08.94- 07.97 CA1031IR 14 70	08.94- 10.96 CS337 12 2.5	
		08.94- 07.97 CA718IR 14 55		
		08.94- 07.97 CA719IR 14 70		
		06.97- 08.00 CA1317IR 14 95		
	[4HB]	06.94- 03.00 CA1030IR 14 55	10.96- 08.00 CS977 12 2.3	
		06.94- 07.97 CA1031IR 14 70	06.94- 10.96 CS337 12 2.5	
		06.94- 07.97 CA718IR 14 55		
		06.94- 07.97 CA719IR 14 70		
		08.97- 08.00 CA1317IR 14 95		
	[4HC]	06.94- 07.97 CA1030IR 14 55	06.94- 10.96 CS337 12 2.5	
		06.94- 07.97 CA1031IR 14 70	10.96- 08.00 CS977 12 2.3	
		06.94- 07.97 CA718IR 14 55		
		06.94- 07.97 CA719IR 14 70		
		08.97- 08.00 CA1317IR 14 95		
Transit 2.5 Diesel	[4AB]	10.83- 02.86 CA190IR 14 35	10.83- 08.91 CS337 12 2.5	
		10.83- 02.86 CA96IR 14 55		
		01.86- 08.91 CA1028IR 14 55		
		01.86- 08.91 CA311IR 14 55		
		02.86- 08.91 CA1029IR 14 70		
		02.86- 08.91 CA611IR 14 70		
	[4BA]	02.86- 08.91 CA1028IR 14 55	02.86- 08.91 CS337 12 2.5	
		02.86- 08.91 CA1029IR 14 70		
		02.86- 08.91 CA311IR 14 55		
		02.86- 08.91 CA611IR 14 70		
	[4CA]	02.86- 08.91 CA1028IR 14 55	02.86- 08.91 CS337 12 2.5	
		02.86- 08.91 CA1029IR 14 70		
		02.86- 08.91 CA311IR 14 55		
		02.86- 08.91 CA611IR 14 70		
	[4ED]	08.97- 03.00 CA1317IR 14 95	10.96- 03.00 CS977 12 2.3	
Transit 2.5 Diesel Tourneo	[4HA]	08.94- 06.00 CA1317IR 14 95	08.94- 06.00 CS977 12 2.3	
Transit 2.5 DTi	[4HC]	07.94- 03.00 CA1030IR 14 55	10.96- 08.00 CS977 12 2.3	
		07.94- 07.97 CA1031IR 14 70	07.94- 10.96 CS337 12 2.5	
		07.94- 07.97 CA718IR 14 55		
		07.94- 07.97 CA719IR 14 70		
		08.97- 08.00 CA1317IR 14 95		
Transit 2.5 TD	[4EA]	08.91- 08.94 CA1030IR 14 55	08.91- 08.94 CS337 12 2.5	
		08.91- 08.94 CA1031IR 14 70		
		08.91- 08.94 CA718IR 14 55		
		08.91- 08.94 CA719IR 14 70		
	[4EB]	07.94- 03.00 CA1030IR 14 55	07.94- 10.96 CS337 12 2.5	
		07.94- 07.97 CA1031IR 14 70	10.96- 08.00 CS977 12 2.3	
		07.94- 07.97 CA718IR 14 55		
		07.94- 07.97 CA719IR 14 70		
		08.97- 08.00 CA1317IR 14 95		
	[4EC]	08.91- 07.97 CA1031IR 14 70	09.91- 10.96 CS337 12 2.5	
		08.91- 07.97 CA718IR 14 55	10.96- 08.00 CS977 12 2.3	
		08.91- 07.97 CA719IR 14 70		
		07.94- 03.00 CA1030IR 14 55		
		06.97- 08.00 CA1317IR 14 95		



	[4GA]	10.92- 03.00	CA1030IR	14 55	10.96- 08.00	CS977	12 2.3
		10.92- 07.97	CA1031IR	14 70	10.92- 10.96	CS337	12 2.5
		10.92- 07.97	CA718IR	14 55			
		10.92- 07.97	CA719IR	14 70			
		08.97- 08.00	CA1317IR	14 95			
	[4GB]	06.94- 03.00	CA1030IR	14 55	06.94- 10.96	CS337	12 2.5
		06.94- 07.97	CA1031IR	14 70	10.96- 08.00	CS977	12 2.3
		06.94- 07.97	CA718IR	14 55			
		06.94- 07.97	CA719IR	14 70			
		08.97- 08.00	CA1317IR	14 95			
	[4GC]	06.94- 03.00	CA1030IR	14 55	10.96- 08.00	CS977	12 2.3
		06.94- 07.97	CA1031IR	14 70	06.94- 10.96	CS337	12 2.5
		06.94- 07.97	CA718IR	14 55			
		06.94- 07.97	CA719IR	14 70			
		08.97- 08.00	CA1317IR	14 95			
	[4GD]	06.94- 03.00	CA1030IR	14 55	10.96- 08.00	CS977	12 2.3
		06.94- 07.97	CA1031IR	14 70	06.94- 10.96	CS337	12 2.5
		06.94- 07.97	CA718IR	14 55			
		06.94- 07.97	CA719IR	14 70			
		08.97- 08.00	CA1317IR	14 95			
	[4GE]	06.94- 03.00	CA1030IR	14 55	06.94- 10.96	CS337	12 2.5
		06.94- 07.97	CA1031IR	14 70	10.96- 08.00	CS977	12 2.3
		06.94- 07.97	CA718IR	14 55			
		06.94- 07.97	CA719IR	14 70			
		08.97- 08.00	CA1317IR	14 95			
	[4GF]	06.94- 03.00	CA1030IR	14 55	10.96- 08.00	CS977	12 2.3
		06.94- 07.97	CA1031IR	14 70	06.94- 10.96	CS337	12 2.5
		06.94- 07.97	CA718IR	14 55			
		06.94- 07.97	CA719IR	14 70			
		08.97- 08.00	CA1317IR	14 95			
	[4HA]	10.98-	CA1317IR	14 95	10.98-	CS977	12 2.3
	[4HD]	10.98-	CA1317IR	14 95	10.98-	CS977	12 2.3
Transit 2.5 TD Tourneo	[4EB]	04.98- 12.00	CA1030IR	14 55	04.98- 12.00	CS337	12 2.5
		04.98- 12.00	CA1031IR	14 70	04.98- 12.00	CS977	12 2.3
		04.98- 12.00	CA1317IR	14 95			
		04.98- 12.00	CA718IR	14 55			
		04.98- 12.00	CA719IR	14 70			
	[4EC]	04.98- 12.00	CA1030IR	14 55	04.98- 12.00	CS337	12 2.5
		04.98- 12.00	CA1031IR	14 70	04.98- 12.00	CS977	12 2.3
		04.98- 12.00	CA1317IR	14 95			
		04.98- 12.00	CA718IR	14 55			
		04.98- 12.00	CA719IR	14 70			
[4GA]	11.94- 12.00	CA1030IR	14 55	11.94- 12.00	CS337	12 2.5	
	11.94- 12.00	CA1031IR	14 70	11.94- 12.00	CS977	12 2.3	
	11.94- 12.00	CA1317IR	14 95				
	11.94- 12.00	CA718IR	14 55				
	11.94- 12.00	CA719IR	14 70				
Transit 2.5 TDi	[4EB]	06.94- 07.97	CA1030IR	14 55	09.95- 10.96	CS337	12 2.5
		09.95- 07.97	CA1031IR	14 70	10.96- 08.00	CS977	12 2.3
		09.95- 07.97	CA718IR	14 55			
		09.95- 07.97	CA719IR	14 70			
		08.97- 08.00	CA1317IR	14 95			
	[4EC]	06.94- 07.97	CA1030IR	14 55	09.95- 10.96	CS337	12 2.5
		09.95- 07.97	CA1031IR	14 70			
		09.95- 07.97	CA718IR	14 55			
		09.95- 07.97	CA719IR	14 70			
		08.97- 08.00	CA1317IR	14 95			
Transit 2.9 i	[BRT]	01.91-	CA324IR	14 90	01.91-	CS328	12 1.4
Transit 3.2 TDCi	[SAFA]	09.07-	CA1922IR	14 150	09.07-	CS1421	12 2.0
<b>PASSENGER CARS US</b>							
Aerostar 3.0		01.86- 01.91	UA1210IR#	14 75			
Aerostar 4.0					01.96- 01.96	US1028	12 1.4
Aspire 1.3		01.94- 01.97	JA694IR	14 65	01.94- 01.97	JS633	12 0.85
Aspire 1.3 SE		01.94- 01.95	JA694IR	14 65	01.94- 01.97	JS1000	12 0.9
					01.94- 01.95	JS1000	12 0.9
					01.94- 01.95	JS633	12 0.85
Bronco 2.8							
Bronco 2.9							
Bronco 4.9							
Bronco 5.0							
Bronco 5.8							
Bronco 6.6							
Contour 2.0					01.97- 01.00	CS1107	12 1.4
Contour 2.0 GL					01.97- 01.00	CS1058	12 1.5
					01.95- 01.98	CS1058	12 1.5
Contour 2.0 LX					01.95- 01.98	CS1107	12 1.4
					01.95- 01.98	CS1058	12 1.5
Contour 2.0 SE					01.95- 01.98	CS1107	12 1.4
					01.98- 01.98	CS1107	12 1.4
Contour 2.0 Sport					01.98- 01.98	CS1058	12 1.5
					01.96- 01.96	CS1107	12 1.4
					01.96- 01.96	CS1058	12 1.5
Contour 2.5					01.98- 01.00	CS961	12 1.4
Contour 2.5 GL					01.95- 01.98	CS961	12 1.4
Contour 2.5 LX					01.95- 01.98	CS961	12 1.4
Contour 2.5 SE					01.95- 01.98	CS961	12 1.4
Contour 2.5 Sport					01.96- 01.97	CS961	12 1.4
Contour 2.5 SVT					01.98- 01.00	CS961	12 1.4
Country 6.6							
Country 7.5							
Country Squire 5.0							
Country Squire 5.8							
Country Squire 6.6							
Country Squire 7.5							
Custom 5.8 500							
Custom 6.6							
Custom 6.6 500							
Custom 7.5 500							
E 5.8 Super Duty		01.96- 01.96	UA963IR	14 130			
E 7.3 Turbo Super Duty		01.96- 01.02	UA963IR	14 130			
E 100 4.9							
E 100 4.9 Club							
E 100 4.9							
E 100 5.0							



**FORD** *Continued*

E 100 5.0 Club					
E 100 5.8					
E 100 5.8 Club					
E 100 7.5					
E 150 4.2	01.97- 01.03	UA963IR	14 130		
E 150 4.2 Club	01.97- 01.98	UA963IR	14 130		
E 150 4.9					
E 150 4.9 Club					
E 150 4.9 Super					
E 150 4.9					
E 150 4.9 Super					
E 150 5.0					
E 150 5.0 Club					
E 150 5.0 Super					
E 150 5.8					
E 150 5.8 Club	01.88- 01.91	UA1210IR#	14 75		
E 150 5.8 Super	01.88- 01.91	UA1210IR#	14 75		
E 150 5.8 Super	01.88- 01.91	UA1210IR#	14 75		
E 150 6.9				01.84- 01.84	US845# 12 2.5
E 150 7.5					
E 150 7.5 Club					
E 150 7.5 Super					
E 200 4.9					
E 200 4.9 Club					
E 250 4.2	01.97- 01.03	UA963IR	14 130		
E 250 4.2 Super	01.97- 01.98	UA963IR	14 130		
E 250 4.9					
E 250 4.9 Club					
E 250 4.9 Super					
E 250 4.9					
E 250 5.0					
E 250 5.0 Club					
E 250 5.0 Super					
E 250 5.8					
E 250 5.8 Club	01.88- 01.91	UA1210IR#	14 75		
E 250 5.8 Super	01.88- 01.91	UA1210IR#	14 75		
E 250 5.8 Super	01.88- 01.91	UA1210IR#	14 75		
E 250 6.6					
E 250 6.6 Club					
E 250 6.6 Super					
E 250 6.9 Club				01.83- 01.87	US845# 12 2.5
E 250 6.9 Super				01.83- 01.84	US845# 12 2.5
E 250 7.3 Club				01.88- 01.91	US845# 12 2.5
E 250 7.5					
E 250 7.5 Club					
E 250 7.5 Super	01.88- 01.91	UA1210IR#	14 75		
E 300 4.9					
E 300 4.9 Club					
E 350 4.9					
E 350 4.9 Super					
E 350 4.9					
E 350 5.0					
E 350 5.0 Super					
E 350 5.8					
E 350 5.8 Super	01.88- 01.91	UA1210IR#	14 75		
E 350 5.8 Super	01.88- 01.91	UA1210IR#	14 75		
E 350 6.6					
E 350 6.6 Super					
E 350 6.9				01.83- 01.87	US845# 12 2.5
E 350 6.9 Super				01.83- 01.87	US845# 12 2.5
E 350 7.3				01.88- 01.94	US845# 12 2.5
E 350 7.3 HD Club	01.92- 01.94	UA963IR	14 130	01.92- 01.94	US845# 12 2.5
E 350 7.3 Super				01.88- 01.94	US845# 12 2.5
E 350 7.3 Turbo	01.95- 01.03	UA963IR	14 130		
E 350 7.3 Turbo HD Club	01.95- 01.98	UA963IR	14 130		
E 350 7.3 Turbo Super	01.95- 01.98	UA963IR	14 130		
E 350 7.5					
E 350 7.5 Super	01.87- 01.91	UA1210IR#	14 75		
E 350 7.5 Super	01.88- 01.91	UA1210IR#	14 75		
E 450 7.3 Turbo	01.03- 01.03	UA963IR	14 130		
Escape 2.0				01.03- 01.03	CS1107 12 1.4
Escape 2.0				01.01- 01.03	CS1058 12 1.5
Escape 3.0				01.01- 01.03	CS961 12 1.4
Escort 1.6					
Escort 1.6 GL					
Escort 1.6 GLX					
Escort 1.6 GT					
Escort 1.6 L					
Escort 1.6 GL					
Escort 1.6 L					
Escort 1.8 GT	01.91- 01.96	JA699IR	14 65		
Escort 1.8 GT	01.91- 01.96	JA599IR	14 65		
Escort 1.8 LX-E	01.92- 01.93	JA699IR	14 65		
Escort 2.0				01.02- 01.02	CS1058 12 1.5
EXP 1.6					
Explorer 4.0	01.97- 01.01	UA963IR	14 130		
F 100 4.2					
F 100 4.9					
F 100 4.9 Super Cab					
F 100 4.9					
F 100 5.0					
F 100 5.8					
F 100 5.8 Super Cab					
F 100 6.4					
F 100 6.6					
F 100 6.6 Super Cab					
F 100 7.5					





F 150 4.2	01.97- 01.03	UA963IR	14	130		
F 150 4.2 Super Cab	01.97- 01.97	UA963IR	14	130		
F 150 4.9						
F 150 4.9 Super Cab						
F 150 4.9						
F 150 4.9 Super Cab						
F 150 5.0	01.92- 01.96	UA1210IR#	14	75		
F 150 5.0 Super Cab						
F 150 5.8	01.92- 01.96	UA1210IR#	14	75		
F 150 5.8 Super Cab	01.88- 01.96	UA1210IR#	14	75		
F 150 5.8	01.88- 01.96	UA1210IR#	14	75		
F 150 5.9						
F 150 6.4						
F 150 6.6						
F 150 6.6 Super Cab						
F 150 6.9					01.84- 01.84	US845# 12 2.5
F 150 7.5						
F 150 7.5 Super Cab						
F 250 4.2	01.98- 01.98	UA963IR	14	130		
F 250 4.2 Super Cab	01.97- 01.97	UA963IR	14	130		
F 250 4.9						
F 250 4.9 Super Cab						
F 250 4.9						
F 250 5.0						
F 250 5.0 Super Cab	01.92- 01.96	UA1210IR#	14	75		
F 250 5.8						
F 250 5.8 Super Cab	01.88- 01.97	UA1210IR#	14	75		
F 250 6.4						
F 250 6.6						
F 250 6.6 Super Cab						
F 250 6.9					01.83- 01.87	US845# 12 2.5
F 250 6.9 Super Cab					01.83- 01.87	US845# 12 2.5
F 250 7.3	01.94- 01.94	UA963IR	14	130	01.88- 01.94	US845# 12 2.5
F 250 7.3 Super Cab	01.94- 01.94	UA963IR	14	130	01.88- 01.94	US845# 12 2.5
F 250 7.3 Turbo	01.93- 01.97	UA963IR	14	130	01.93- 01.93	US845# 12 2.5
F 250 7.3 Turbo Super Cab	01.93- 01.97	UA963IR	14	130	01.93- 01.93	US845# 12 2.5
F 250 7.5						
F 250 7.5 Super Cab	01.88- 01.96	UA1210IR#	14	75		
F 250 7.5	01.88- 01.96	UA1210IR#	14	75		
F 350 4.9						
F 350 4.9 Super Cab						
F 350 4.9						
F 350 5.0						
F 350 5.0 Super Cab						
F 350 5.8						
F 350 5.8 Super Cab	01.88- 01.97	UA1210IR#	14	75		
F 350 5.9						
F 350 6.4						
F 350 6.6						
F 350 6.6 Super Cab						
F 350 6.9					01.83- 01.87	US845# 12 2.5
F 350 7.3					01.88- 01.94	US845# 12 2.5
F 350 7.3 Super Cab	01.94- 01.94	UA963IR	14	130	01.88- 01.94	US845# 12 2.5
F 350 7.3	01.94- 01.94	UA963IR	14	130	01.88- 01.94	US845# 12 2.5
F 350 7.3 Turbo	01.93- 01.97	UA963IR	14	130	01.93- 01.93	US845# 12 2.5
F 350 7.3 Turbo Super Cab	01.93- 01.97	UA963IR	14	130	01.93- 01.93	US845# 12 2.5
F 350 7.5						
F 350 7.5 Super Cab	01.88- 01.96	UA1210IR#	14	75		
F 350 7.5	01.88- 01.96	UA1210IR#	14	75		
F 450 7.3 Super Duty	01.93- 01.94	UA963IR	14	130	01.90- 01.94	US845# 12 2.5
F 450 7.5 Super Duty	01.90- 01.94	UA1210IR#	14	75		
F 53 7.5	01.89- 01.96	UA1210IR#	14	75		
F 59 7.3	01.94- 01.94	UA963IR	14	130	01.89- 01.94	US845# 12 2.5
F 59 7.3 Turbo	01.93- 01.96	UA963IR	14	130	01.93- 01.93	US845# 12 2.5
Fairmont 2.3						
Fairmont 2.3 Futura						
Fairmont 3.3						
Fairmont 3.3 Futura						
Fairmont 4.2						
Fairmont 4.2 Futura						
Fairmont 5.0						
Fairmont 5.0 Futura						
Festiva 1.3 GL					01.91- 01.93	JS633 12 0.85
Festiva 1.3 L	01.88- 01.93	JA129IR	14	55	01.88- 01.93	JS1000 12 0.9
Festiva 1.3 L Plus					01.88- 01.93	JS633 12 0.85
Festiva 1.3 L Plus					01.90- 01.90	JS633 12 0.85
Festiva 1.3 L Plus					01.90- 01.90	JS1000 12 0.9
Festiva 1.3 LX	01.88- 01.90	JA129IR	14	55	01.88- 01.92	JS633 12 0.85
Festiva 1.3 LX					01.88- 01.92	JS1000 12 0.9
Fiesta 1.6	01.78- 01.80	CA126IR	14	45	01.78- 01.80	CS123 12 0.8
Focus 2.0 LE					01.00- 01.00	CS1107 12 1.4
Focus 2.0 LX					01.00- 01.02	CS1107 12 1.4
Focus 2.0 S2					01.01- 01.02	CS1107 12 1.4
Focus 2.0 SE					01.00- 01.02	CS1107 12 1.4
Focus 2.0 Street					01.01- 01.02	CS1107 12 1.4
Focus 2.0 SVT					01.02- 01.02	CS1107 12 1.4



**FORD** *Continued*

Focus 2.0 ZTS	01.00- 01.02	<b>CS1107</b>	12 1.4
Focus 2.0 ZTW	01.02- 01.02	<b>CS1107</b>	12 1.4
Focus 2.0 ZX3	01.00- 01.02	<b>CS1107</b>	12 1.4
Focus 2.0 ZX5	01.02- 01.02	<b>CS1107</b>	12 1.4
Galaxie 5.0 500			
Galaxie 6.6 500			
Galaxie 7.5 500			
Gran Torino 4.1			
Gran Torino 4.1 Elite			
Gran Torino 5.0			
Gran Torino 5.0 Brougham			
Gran Torino 5.0 Sport			
Gran Torino 5.0 Squire			
Gran Torino 5.8			
Gran Torino 5.8 Brougham			
Gran Torino 5.8 Elite			
Gran Torino 5.8 Sport			
Gran Torino 5.8 Squire			
Gran Torino 6.6			
Gran Torino 6.6 Brougham			
Gran Torino 6.6 Elite			
Gran Torino 6.6 Sport			
Gran Torino 6.6 Squire			
Gran Torino 7.0			
Gran Torino 7.0 Sport			
Gran Torino 7.0 Squire			
Gran Torino 7.5			
Gran Torino 7.5 Brougham			
Gran Torino 7.5 Elite			
Gran Torino 7.5 Sport			
Gran Torino 7.5 Squire			
Granada 2.3			
Granada 3.3			
Granada 3.3 Ghia			
Granada 4.1			
Granada 4.1 Ghia			
Granada 4.2			
Granada 5.0			
Granada 5.0 Ghia			
Granada 5.8			
Granada 5.8 Ghia			
LTD 2.3			
LTD 2.3 Brougham			
LTD 2.3			
LTD 2.3 Brougham			
LTD 3.3			
LTD 3.3 Brougham			
LTD 4.2			
LTD 4.2 Crown Victoria			
LTD 4.2 S			
LTD 5.0			
LTD 5.0 Brougham			
LTD 5.0 Country Squire			
LTD 5.0 Crown Victoria			
LTD 5.0 Landau			
LTD 5.0 LX			
LTD 5.0 S			
LTD 5.8			
LTD 5.8 Brougham			
LTD 5.8 Country Squire			
LTD 5.8 Crown Victoria			
LTD 5.8 Landau			
LTD 5.8 S			
LTD 5.8 Squire			
LTD 6.6			
LTD 6.6 Brougham			
LTD 6.6 Landau			
LTD 6.6 S			
LTD 6.6 Squire			
LTD 7.5			
LTD 7.5 Brougham			
LTD 7.5 Landau			
M 400 5.9			
M 450 5.9			
Maverick 3.3			
Maverick 4.1			
Maverick 5.0			
Mustang 2.3			
Mustang 2.3 2+2			
Mustang 2.3 Ghia			
Mustang 2.3 L			
Mustang 2.3 LX	01.87- 01.93	<b>UA1210IR#</b>	14 75
Mustang 2.3 Mach I			
Mustang 2.3 Turbo			
Mustang 2.3 Turbo Ghia			
Mustang 2.3 Turbo GT			
Mustang 2.3 Turbo L			
Mustang 2.3 Turbo SVO			
Mustang 2.8			
Mustang 2.8 2+2			
Mustang 2.8 Ghia			
Mustang 2.8 Mach I			
Mustang 3.3			
Mustang 3.3 Ghia			
Mustang 4.2			
Mustang 4.2 Ghia			
Mustang 5.0			
Mustang 5.0 Cobra	01.93- 01.94	<b>UA1210IR#</b>	14 75
Mustang 5.0 Ghia			
Mustang 5.0 GT	01.87- 01.93	<b>UA1210IR#</b>	14 75
Mustang 5.0 L			



Mustang 5.0 LX		01.87- 01.93	UA1210IR#	14 75			
Mustang 5.0 Mach I							
Mustang 5.8							
Mustang 5.8 Grande							
Mustang 5.8 Mach I							
P 350 4.9							
P 350 5.0							
P 350 5.9							
P 350 6.4							
Pinto 2.3							
Pinto 2.8							
Probe 2.0					01.97- 01.97	JS637	12 1.4
Probe 2.0 SE					01.93- 01.96	JS637	12 1.4
Probe 2.2 GL		01.89- 01.92	JA575IR	14 70	01.89- 01.92	JS637	12 1.4
Probe 2.2 LX		01.89- 01.89	JA575IR	14 70	01.89- 01.89	JS637	12 1.4
Probe 2.2 Turbo GT		01.89- 01.92	JA575IR	14 70	01.89- 01.92	JS637	12 1.4
Probe 2.5 GT		01.93- 01.97	JA806IR	14 90	01.93- 01.97	JS747	12 1.7
Ranch 6.6							
Ranch 7.5							
Ranchero 5.0 500							
Ranchero 5.0 GT							
Ranchero 5.0 Squire							
Ranchero 5.8 500							
Ranchero 5.8 GT							
Ranchero 5.8 Squire							
Ranchero 6.6 500							
Ranchero 6.6 GT							
Ranchero 6.6 Squire							
Ranchero 7.0 500							
Ranchero 7.0 GT							
Ranchero 7.0 Squire							
Ranchero 7.5 500							
Ranchero 7.5 GT							
Ranchero 7.5 Squire							
Ranger 2.0							
Ranger 2.2							
Ranger 2.3							
Ranger 2.3 Super							
Ranger 2.3 Turbo							
Ranger 2.8							
Ranger 2.9							
Ranger 2.9 Super							
Ranger 4.0		01.98- 01.03	UA963IR	14 130			
Ranger 4.0 Super		01.98- 01.98	UA963IR	14 130			
Thunderbird 2.3 Turbo							
Thunderbird 3.3		01.87- 01.87	UA1210IR#	14 75			
Thunderbird 3.8 LX		01.93- 01.93	UA1210IR#	14 75			
Thunderbird 4.2							
Thunderbird 5.0							
Thunderbird 5.8							
Thunderbird 6.6							
Thunderbird 7.5							
Torino 5.8							
Torino 7.0							
Torino 7.5							
ZX2 2.0					01.02- 01.03	CS1058	12 1.5
<b>PASSENGER CARS AO</b>							
Cortina 1.3	[JCC]	09.79- 08.82	CA126IR	14 45			
		09.79- 08.82	CA226IR	14 55			
Fiesta 1.4 TDCi	[F6J...]	01.09-	CA2091IR*	14 120			
Focus 1.8 FlexFuel	[QQDD]	12.05-	CA1926IR	14 120	12.05-	CS1402	12 1.2
					AT 12.05-	CS1403	12 1.2
Focus 1.8 Flexifuel		12.05-	CA1926IR	14 120	AT 12.05-	CS1403	12 1.2
					12.05-	CS1402	12 1.2
Mondeo 2.0 TDCi		02.03- 06.05	CA1638IR	14 115	02.03- 06.05	CS1245	12 2.1
Ranger 2.5 4x4		10.05-	JA1530IR	14 70	10.05-	JS1352	12 2.2
Ranger 2.5 TDDi		10.05-	JA1530IR	14 70	10.05-	JS1352	12 2.2
Ranger 3.0 TDDi 4x4		10.05-	JA1530IR	14 70	10.05-	JS1352	12 2.2
Scorpio 2.0	[N8B]	06.89- 03.93	CA563IR	14 90	06.89- 03.93	CS330	12 1.4
Sierra 2.0	[N8A]	AT 07.89- 12.92	CA1692IR#	14 70	07.89- 12.92	CS330	12 1.4
Transit 2.0 L	[NAW]	10.85- 03.91	CA299IR	14 70	AT 10.85- 03.91	CS329	12 1.4
	[NAX]	10.85- 03.91	CA299IR	14 70	AT 10.85- 03.91	CS329	12 1.4
		10.85- 03.91	CA322IR	14 90			
Transit 2.3					03.01- 03.06	CS330	12 1.4
Transit 2.4	[D2FE]	10.00- 03.06	CA1779IR	14 110	10.00- 03.06	CS1245	12 2.1
Transit 2.4 TDDi	[D4FA]	08.00- 08.03	CA1779IR	14 110	08.00- 08.03	CS1245	12 2.1
<b>TRUCKS EU</b>							
0609 4.2	[90/5AA-Dover]	02.92- 07.94	CA312IR	14 60	01.82- 07.94	CS339	12 3.0
0709 4.2	[90/5AA-Dover]	02.92- 07.94	CA312IR	14 60	01.82- 07.94	CS339	12 3.0
0711 5.9		01.82- 01.94	CA312IR	14 60	01.82- 01.96	CS345	12 3.0
					01.82- 07.94	CS339	12 3.0
0809 4.2	[90/5AA-Dover]	02.92- 07.94	CA312IR	14 60	01.82- 07.94	CS339	12 3.0
0811 5.9					01.82- 07.94	CS339	12 3.0
0913 6.2	[130/7AA-Dover]	01.92- 01.96	CA312IR	14 60	01.82- 01.96	CS339	12 3.0
0915 5.9	[150/6CA-Dover]	02.92- 01.96	CA312IR	14 60	01.82- 01.96	CS345	12 3.0
1013 6.2	[130/7AA-Dover]	01.92- 06.94	CA312IR	14 60	01.82- 06.94	CS339	12 3.0
1113 6.2	[130/7AA-Dover]	01.94- 01.96	CA312IR	14 60	01.82- 01.96	CS339	12 3.0
1115 6.0	[150/6CA-Dover]	01.94- 01.96	CA312IR	14 60	01.82- 01.96	CS345	12 3.0
1215 5.9	[150/6CA-Dover]	01.94- 01.96	CA312IR	14 60	01.82- 01.96	CS345	12 3.0
1315 6.0	[150/6CA-Dover]				01.82- 06.94	CS345	12 3.0
1515 6.0	[150/6CA-Dover]				01.82- 06.94	CS345	12 3.0
2115 6.0	[150/6CA-Dover]				01.82- 06.94	CS345	12 3.0
Cargo	[4 cyl]				05.81-	CS336	12 2.8
					05.81-	CS339	12 3.0
	[6 cyl]				05.81-	CS336	12 2.8
					05.81-	CS339	12 3.0
					05.81- 06.94	CS345	12 3.0



**FORD** Continued

AGRICULTURE							
1910		01.84- 01.88	JA100	14 35		01.84- 01.88	JS737 12 1.2
2000	[158CID]	01.69- 12.74	CA290IR	14 45		01.69- 12.74	CS200 12 2.8
3000	[175CID]	04.68- 12.74	CG58	14 22		04.68- 12.74	CS200 12 2.8
3600	[175CID]	01.75- 12.81	CA725IR	14 45		01.75- 12.81	CS200 12 2.8
3610	[192CID]	01.88- 01.96	CA1330IR	14 70		01.81- 01.96	CS200 12 2.8
		01.88- 01.96	CA725IR	14 45			
3910						01.82- 01.84	CS200 12 2.8
4000	[201CID]	01.68- 12.75	CG58	14 22		01.68- 12.75	CS200 12 2.8
		01.75- 01.86	CA290IR	14 45			
4100	[183CID]	01.75- 12.81	CA290IR	14 45		01.75- 12.81	CS200 12 2.8
4110		01.81- 01.88	CA290IR	14 45		01.81- 01.89	CS200 12 2.8
		01.88- 01.89	CA725IR	14 45			
4130		06.90- 06.05	CA1330IR	14 70		06.90- 06.05	CS200 12 2.8
		06.90- 06.05	CA725IR	14 45			
4600	[201CID]	01.75- 12.78	CA290IR	14 45		01.75- 12.78	CS200 12 2.8
4610		01.81- 01.88	CA290IR	14 45		01.81- 01.89	CS200 12 2.8
		01.88- 01.89	CA725IR	14 45			
4830						06.90- 06.05	CS200 12 2.8
5000	[256CID]	01.68- 01.71	CG58	14 22		01.68- 12.77	CS200 12 2.8
		01.75- 01.86	CA290IR	14 45			
5600	[233CID]	01.75- 12.77	CA290IR	14 45		01.75- 12.77	CS200 12 2.8
5610	[256CID]	01.81- 12.91	CA290IR	14 45		01.81- 12.91	CS200 12 2.8
5640		01.92- 01.97	CA1379IR	14 100		01.92- 01.97	CS200 12 2.8
6600	[256CID]	01.75- 01.81	CA290IR	14 45		01.75- 01.81	CS200 12 2.8
6610	[401CID]	01.81- 01.88	CA290IR	14 45		01.81- 01.96	CS200 12 2.8
		01.88- 01.96	CA1330IR	14 70			
		01.88- 01.96	CA707IR	14 75			
		01.88- 01.96	CA725IR	14 45			
6640		01.92- 01.97	CA1330IR	14 70		01.92- 01.97	CS200 12 2.8
		01.92- 01.97	CA1379IR	14 100			
7610		06.90- 06.05	CA725IR	14 45		06.90- 06.05	CS200 12 2.8
		06.90- 06.05	CA1330IR	14 70			
		01.86- 01.88	CA290IR	14 45			
7740		01.92- 01.97	CA1330IR	14 70		01.92- 01.97	CS200 12 2.8
		01.92- 01.97	CA1379IR	14 100		01.86- 01.97	CS1126 12 3.1
7810		06.90- 06.05	CA707IR	14 75		06.90- 06.05	CS200 12 2.8
						01.96- 06.05	CS1126 12 3.1
7840		01.92- 01.97	CA1379IR	14 100		01.92- 01.97	CS200 12 2.8
						01.96- 01.97	CS1126 12 3.1
8210						06.90- 06.05	CS200 12 2.8
8240		01.92- 01.96	CA1379IR	14 100		01.92- 01.96	CS200 12 2.8
						01.96- 01.96	CS1126 12 3.1
8340		01.92- 01.97	CA1379IR	14 100		01.92- 01.97	CS200 12 2.8
						01.96- 01.97	CS1126 12 3.1
8600	[401CID]	01.88-	CA725IR	14 45		01.75- 12.76	CS200 12 2.8
8630		06.90- 06.05	CA1330IR	14 70		06.90- 06.05	CS200 12 2.8
		06.90- 06.05	CA725IR	14 45			
8730						06.90- 06.05	CS200 12 2.8
8830						06.90- 06.05	CS200 12 2.8
9700						01.77- 01.79	CS200 12 2.8
TW 10						01.79- 01.82	CS200 12 2.8
TW 15						01.83- 01.87	CS200 12 2.8
TW 20						01.79- 01.82	CS200 12 2.8
TW 25						01.83- 01.89	CS200 12 2.8
TW 30						01.79- 01.82	CS200 12 2.8
TW 35						01.83- 01.89	CS200 12 2.8
Various Models		01.65-	CG58	14 22			JS1102 12 1.4
<b>FSO</b>							
<b>PASSENGER CARS EU</b>							
126P 0.65 650						07.81- 09.00	CS692 12 0.6
<b>GEO</b>							
<b>PASSENGER CARS US</b>							
Metro 1.0		01.89- 01.97	JA682IR	14 50		01.89- 01.97	JS1092 12 1.2
		01.89- 01.94	JA798IR	14 50		01.89- 01.97	JS512 12 0.8
Metro 1.0 LSI		01.89- 01.96	JA682IR	14 50		01.89- 01.96	JS1092 12 1.2
		01.89- 01.95	JA798IR	14 50		01.89- 01.96	JS512 12 0.8
Metro 1.0 XFI		01.90- 01.94	JA682IR	14 50		01.90- 01.94	JS1092 12 1.2
		01.90- 01.94	JA798IR	14 50		01.90- 01.94	JS512 12 0.8
Metro 1.3 LSI		01.95- 01.97	JA682IR	14 50		01.95- 01.97	JS1092 12 1.2
						01.95- 01.97	JS512 12 0.8
Prizm 1.6		01.89- 01.91	JA189IR	14 55			
Prizm 1.6 GSI		01.90- 01.92	JA142IR	14 60		01.90- 01.92	JS317 12 1.0
Prizm 1.6 LSI		01.90- 01.92	JA189IR	14 55		01.93- 01.95	JS560 12 1.0
		01.93- 01.95	JA987IR	14 80			
		01.93- 01.97	JA976IR	14 70			
Prizm 1.8 LSI		01.93- 01.97	JA976IR	14 70		01.93- 01.95	JS560 12 1.0
		01.93- 01.95	JA987IR	14 80			
Tracker 1.6		01.89- 01.97	JA682IR	14 50		01.89- 01.97	JS380 12 1.0
<b>Ginif</b>							
<b>TRUCKS EU</b>							
2120 N 5.9	[F4AE0681A]	09.03-	CA1699IR	28 70		09.03-	CS1268 24 4.0
		09.03-	CA1812IR	28 90			
<b>GMC</b>							
<b>PASSENGER CARS US</b>							
1000 Series 3.8		01.64- 01.65	UA916#	14 60		01.64- 01.65	US818 12 1.5
1500 Series 3.8		01.64- 01.65	UA916#	14 60		01.64- 01.65	US818 12 1.5
C15/C1500 3.8		01.66- 01.66	UA916#	14 60		01.66- 01.66	US818 12 1.5
C15/C1500 4.1		01.66- 01.71	UA916#	14 60		01.66- 01.75	US818 12 1.5
		01.72- 01.84	UA943IR	14 60			
C15/C1500 4.1 Big Ten		01.77- 01.80	UA943IR	14 60			
C15/C1500 4.1 Suburban		01.68- 01.71	UA916#	14 60		01.68- 01.75	US818 12 1.5
		01.72- 01.80	UA943IR	14 60			
C15/C1500 4.3		01.85- 01.86	UA943IR	14 60			
C15/C1500 4.6		01.67- 01.67	UA916#	14 60		01.67- 01.67	US818 12 1.5
C15/C1500 4.8		01.66- 01.71	UA916#	14 60		01.69- 01.71	US818 12 1.5
		01.73- 01.80	UA943IR	14 60			
C15/C1500 4.8 Big Ten		01.78- 01.80	UA943IR	14 60			
C15/C1500 4.8 Suburban		01.73- 01.74	UA943IR	14 60		01.69- 01.71	US818 12 1.5
		01.68- 01.71	UA916#	14 60			
C15/C1500 4.8		01.74- 01.74	UA943IR	14 60			
C15/C1500 4.8 Suburban		01.74- 01.74	UA943IR	14 60			



C15/C1500 5.0	01.72- 01.86	UA943IR	14 60				
	01.86- 01.86	UA945IR	14 65		01.68- 01.73	US818	12 1.5
	01.68- 01.71	UA916#	14 60		01.85- 01.86	US858	12
C15/C1500 5.0 Big Ten	01.78- 01.80	UA943IR	14 60				
C15/C1500 5.0 Suburban	01.68- 01.71	UA916#	14 60		01.68- 01.73	US818	12 1.5
	01.72- 01.86	UA943IR	14 60				
					01.85- 01.86	US858	12
C15/C1500 5.4	01.67- 01.68	UA916#	14 60		01.67- 01.68	US818	12 1.5
C15/C1500 5.4 Suburban	01.68- 01.68	UA916#	14 60		01.68- 01.68	US818	12 1.5
C15/C1500 5.7	01.72- 01.86	UA943IR	14 60				
	01.69- 01.71	UA916#	14 60				
C15/C1500 5.7 Big Ten	01.77- 01.80	UA943IR	14 60				
C15/C1500 5.7 Suburban	01.72- 01.86	UA943IR	14 60				
	01.69- 01.71	UA916#	14 60				
C15/C1500 5.7	01.78- 01.81	UA943IR	14 60				
C15/C1500 5.7 Suburban	01.78- 01.81	UA943IR	14 60				
C15/C1500 5.7	01.74- 01.74	UA943IR	14 60				
C15/C1500 5.7 Suburban	01.74- 01.74	UA943IR	14 60				
C15/C1500 6.2	01.82- 01.86	UA943IR	14 60				
C15/C1500 6.2 Suburban	01.82- 01.86	UA943IR	14 60				
C15/C1500 6.5	01.68- 01.69	UA916#	14 60				
C15/C1500 6.5 Suburban	01.68- 01.69	UA916#	14 60				
C15/C1500 6.6	01.72- 01.80	UA943IR	14 60				
	01.70- 01.71	UA916#	14 60				
C15/C1500 6.6 Big Ten	01.80- 01.80	UA943IR	14 60				
C15/C1500 6.6 Suburban	01.70- 01.72	UA916#	14 60				
C15/C1500 7.4	01.73- 01.80	UA943IR	14 60				
C15/C1500 7.4 Big Ten	01.77- 01.80	UA943IR	14 60				
C15/C1500 7.4 Suburban	01.73- 01.80	UA943IR	14 60				
C1500 4.3	01.88- 01.88	UA939IR	14 100		01.88- 01.88	US858	12
C1500 4.3 Sierra	01.89- 01.95	UA939IR	14 100		01.89- 01.97	US858	12
C1500 4.3 Sierra XC	01.89- 01.95	UA939IR	14 100		01.89- 01.97	US858	12
C1500 5.0	01.88- 01.88	UA939IR	14 100				
C1500 5.0 Sierra	01.89- 01.95	UA939IR	14 100				
					01.92- 01.97	US858	12
					01.89- 01.89	US818	12 1.5
C1500 5.0 Sierra XC	01.89- 01.95	UA939IR	14 100				
					01.92- 01.97	US858	12
					01.89- 01.89	US818	12 1.5
C1500 5.7	01.88- 01.88	UA939IR	14 100				
C1500 5.7 Sierra	01.89- 01.95	UA939IR	14 100				
C1500 5.7 Sierra XC	01.89- 01.95	UA939IR	14 100				
C1500 5.7 Suburban	01.92- 01.95	UA939IR	14 100				
C1500 6.2	01.88- 01.88	UA939IR	14 100				
C1500 6.2 Sierra	01.89- 01.93	UA939IR	14 100		01.89- 01.93	US970	12 2.5
C1500 6.2 Sierra XC	01.89- 01.93	UA939IR	14 100		01.89- 01.93	US970	12 2.5
C1500 6.5 Sierra	01.94- 01.95	UA939IR	14 100		01.94- 01.95	US970	12 2.5
C1500 6.5 Sierra XC	01.94- 01.95	UA939IR	14 100		01.94- 01.95	US970	12 2.5
C1500 6.5 Turbo					01.98- 01.98	US970	12 2.5
C1500 6.5 Turbo Sierra	01.94- 01.97	UA939IR	14 100		01.94- 01.97	US970	12 2.5
C1500 6.5 Turbo Sierra XC	01.94- 01.97	UA939IR	14 100		01.94- 01.97	US970	12 2.5
C1500 6.5 Turbo Suburban	01.94- 01.99	UA939IR	14 100		01.94- 01.99	US970	12 2.5
C25/C2500 3.8	01.66- 01.66	UA916#	14 60				
C25/C2500 4.1	01.72- 01.84	UA943IR	14 60		01.66- 01.75	US818	12 1.5
	01.66- 01.71	UA916#	14 60				
C25/C2500 4.1 Suburban	01.68- 01.71	UA916#	14 60		01.68- 01.74	US818	12 1.5
	01.72- 01.74	UA943IR	14 60				
C25/C2500 4.3	01.85- 01.86	UA943IR	14 60				
C25/C2500 4.6	01.67- 01.67	UA916#	14 60		01.67- 01.67	US818	12 1.5
C25/C2500 4.8	01.73- 01.86	UA943IR	14 60		01.69- 01.72	US818	12 1.5
	01.66- 01.72	UA916#	14 60				
C25/C2500 4.8 Suburban	01.73- 01.86	UA943IR	14 60		01.69- 01.72	US818	12 1.5
	01.68- 01.72	UA916#	14 60				
C25/C2500 4.8	01.74- 01.74	UA943IR	14 60				
C25/C2500 5.0	01.68- 01.71	UA916#	14 60		01.68- 01.73	US818	12 1.5
	01.72- 01.86	UA943IR	14 60		01.85- 01.86	US858	12
C25/C2500 5.0 Suburban	01.68- 01.71	UA916#	14 60		01.68- 01.73	US818	12 1.5
	01.72- 01.86	UA943IR	14 60				
					01.84- 01.86	US858	12
C25/C2500 5.4	01.67- 01.68	UA916#	14 60		01.67- 01.68	US818	12 1.5
C25/C2500 5.4 Suburban	01.68- 01.68	UA916#	14 60		01.68- 01.68	US818	12 1.5
C25/C2500 5.7	01.72- 01.86	UA943IR	14 60				
	01.69- 01.71	UA916#	14 60				
C25/C2500 5.7 Suburban	01.72- 01.86	UA943IR	14 60				
	01.69- 01.71	UA916#	14 60				
C25/C2500 5.7 Suburban	01.80- 01.80	UA943IR	14 60				
C25/C2500 5.7	01.74- 01.74	UA943IR	14 60				
C25/C2500 6.2	01.82- 01.86	UA943IR	14 60				
C25/C2500 6.2 Suburban	01.82- 01.86	UA943IR	14 60				
C25/C2500 6.5	01.68- 01.69	UA916#	14 60				
C25/C2500 6.5 Suburban	01.68- 01.69	UA916#	14 60				
C25/C2500 6.6	01.72- 01.79	UA943IR	14 60				
	01.70- 01.71	UA916#	14 60				
C25/C2500 6.6 Suburban	01.70- 01.72	UA916#	14 60				
	01.78- 01.80	UA943IR	14 60				
C25/C2500 7.4	01.73- 01.86	UA943IR	14 60				
C25/C2500 7.4 Suburban	01.74- 01.86	UA943IR	14 60				
C2500 4.3	01.88- 01.88	UA939IR	14 100		01.88- 01.88	US858	12
C2500 4.3 Sierra	01.89- 01.95	UA939IR	14 100		01.89- 01.95	US858	12
C2500 4.3 Sierra XC	01.89- 01.93	UA939IR	14 100		01.89- 01.93	US858	12
C2500 5.0	01.88- 01.88	UA939IR	14 100				
C2500 5.0 Sierra	01.89- 01.95	UA939IR	14 100		01.92- 01.96	US858	12
					01.89- 01.89	US818	12 1.5
C2500 5.0 Sierra XC	01.89- 01.95	UA939IR	14 100		01.92- 01.96	US858	12
					01.89- 01.89	US818	12 1.5
C2500 5.7	01.88- 01.88	UA939IR	14 100				
C2500 5.7 Sierra	01.89- 01.95	UA939IR	14 100				
C2500 5.7 Sierra XC	01.89- 01.95	UA939IR	14 100				
C2500 5.7 Suburban	01.92- 01.95	UA939IR	14 100				
C2500 6.2	01.88- 01.88	UA939IR	14 100				
C2500 6.2 Sierra	01.89- 01.93	UA939IR	14 100		01.89- 01.93	US970	12 2.5



**GMC Continued**

C2500 6.2 Sierra XC	01.89- 01.93	UA939IR	14 100	01.89- 01.93	US970	12 2.5
C2500 6.5 Sierra	01.94- 01.95	UA939IR	14 100	01.94- 01.95	US970	12 2.5
C2500 6.5 Sierra XC	01.94- 01.95	UA939IR	14 100	01.94- 01.95	US970	12 2.5
C2500 6.5 Turbo				01.99- 01.00	US970	12 2.5
C2500 6.5 Turbo Sierra	01.92- 01.98	UA939IR	14 100	01.92- 01.98	US970	12 2.5
C2500 6.5 Turbo Sierra XC	01.93- 01.98	UA939IR	14 100	01.93- 01.98	US970	12 2.5
C2500 6.5 Turbo Suburban	01.94- 01.99	UA939IR	14 100	01.94- 01.99	US970	12 2.5
C2500 7.4 Sierra	01.94- 01.95	UA939IR	14 100			
	01.91- 01.93	UA953IR#	14 100			
C2500 7.4 Sierra XC	01.94- 01.95	UA939IR	14 100			
	01.91- 01.93	UA953IR#	14 100			
C2500 7.4 Suburban	01.94- 01.95	UA939IR	14 100			
	01.92- 01.93	UA953IR#	14 100			
C35/C3500 4.1	01.67- 01.71	UA916#	14 60	01.67- 01.75	US818	12 1.5
	01.72- 01.80	UA943IR	14 60			
C35/C3500 4.6	01.67- 01.67	UA916#	14 60	01.67- 01.67	US818	12 1.5
C35/C3500 4.8	01.67- 01.72	UA916#	14 60			
	01.73- 01.86	UA943IR	14 60	01.69- 01.72	US818	12 1.5
C35/C3500 4.8	01.74- 01.74	UA943IR	14 60			
C35/C3500 5.0	01.72- 01.86	UA943IR	14 60			
	01.68- 01.71	UA916#	14 60	01.68- 01.73	US818	12 1.5
	01.86- 01.86	UA945IR	14 65			
C35/C3500 5.4	01.67- 01.68	UA916#	14 60	01.67- 01.68	US818	12 1.5
C35/C3500 5.7	01.72- 01.86	UA943IR	14 60			
	01.69- 01.71	UA916#	14 60			
C35/C3500 5.7	01.74- 01.74	UA943IR	14 60			
C35/C3500 6.2	01.82- 01.86	UA943IR	14 60			
C35/C3500 6.5	01.68- 01.69	UA916#	14 60			
C35/C3500 6.6	01.72- 01.79	UA943IR	14 60			
	01.70- 01.71	UA916#	14 60			
C35/C3500 7.4	01.73- 01.86	UA943IR	14 60			
C3500 5.7	01.88- 01.88	UA939IR	14 100			
C3500 5.7 Sierra	01.89- 01.95	UA939IR	14 100			
C3500 5.7 Sierra XC	01.89- 01.95	UA939IR	14 100			
C3500 6.2	01.88- 01.88	UA939IR	14 100			
C3500 6.2 Sierra	01.89- 01.93	UA939IR	14 100	01.89- 01.93	US970	12 2.5
C3500 6.2 Sierra XC	01.89- 01.93	UA939IR	14 100	01.89- 01.93	US970	12 2.5
C3500 6.5 Turbo				01.98- 01.00	US970	12 2.5
C3500 6.5 Turbo HD Chassis Cab				01.01- 01.02	US970	12 2.5
C3500 6.5 Turbo Sierra	01.92- 01.97	UA939IR	14 100	01.92- 01.97	US970	12 2.5
C3500 6.5 Turbo Sierra XC	01.92- 01.97	UA939IR	14 100	01.92- 01.97	US970	12 2.5
C3500 7.4	01.88- 01.88	UA953IR#	14 100			
C3500 7.4 Sierra	01.94- 01.95	UA939IR	14 100			
	01.89- 01.93	UA953IR#	14 100			
C3500 7.4 Sierra XC	01.94- 01.95	UA939IR	14 100			
	01.89- 01.93	UA953IR#	14 100			
Caballero 3.3	01.78- 01.79	UA943IR	14 60			
Caballero 3.8	01.78- 01.84	UA943IR	14 60	01.78- 01.84	US818	12 1.5
Caballero 4.3				01.85- 01.87	US818	12 1.5
Caballero 4.4	01.80- 01.82	UA943IR	14 60			
Caballero 5.0	01.78- 01.87	UA943IR	14 60	01.84- 01.87	US818	12 1.5
Caballero 5.7	01.78- 01.79	UA943IR	14 60			
Caballero 5.7	01.83- 01.84	UA945IR	14 65			
G1000 Series 3.8	01.64- 01.66	UA916#	14 60	01.64- 01.66	US818	12 1.5
G15/G1500 3.8	01.67- 01.67	UA916#	14 60	01.67- 01.67	US818	12 1.5
G15/G1500 3.8 Rally	01.68- 01.69	UA916#	14 60	01.68- 01.69	US818	12 1.5
G15/G1500 3.8 Vandura	01.68- 01.69	UA916#	14 60	01.68- 01.69	US818	12 1.5
G15/G1500 4.1	01.83- 01.84	UA943IR	14 60	01.67- 01.67	US818	12 1.5
	01.83- 01.84	UA945IR	14 65			
	01.67- 01.67	UA916#	14 60			
G15/G1500 4.1 Rally	01.72- 01.84	UA943IR	14 60			
	01.68- 01.71	UA916#	14 60	01.68- 01.75	US818	12 1.5
	01.83- 01.84	UA945IR	14 65			
G15/G1500 4.1 Vandura	01.72- 01.84	UA943IR	14 60			
	01.68- 01.71	UA916#	14 60	01.68- 01.75	US818	12 1.5
	01.83- 01.84	UA945IR	14 65			
G15/G1500 4.3 Rally	01.87- 01.93	UA939IR	14 100			
	01.85- 01.90	UA943IR	14 60	01.91- 01.93	US858	12
G15/G1500 4.3 Savana				01.96- 01.97	US858	12
G15/G1500 4.3 Vandura	01.87- 01.95	UA939IR	14 100			
	01.85- 01.90	UA943IR	14 60	01.91- 01.95	US858	12
G15/G1500 4.6	01.67- 01.67	UA916#	14 60			
G15/G1500 5.0	01.70- 01.71	UA916#	14 60			
	01.83- 01.86	UA943IR	14 60	01.70- 01.71	US818	12 1.5
				01.94-	US858	12
G15/G1500 5.0 Rally	01.72- 01.86	UA943IR	14 60	01.92- 01.93	US858	12
	01.87- 01.91	UA939IR	14 100			
	01.68- 01.69	UA916#	14 60	01.72- 01.73	US818	12 1.5
G15/G1500 5.0 Savana				01.96- 01.97	US858	12
G15/G1500 5.0 Vandura	01.72- 01.86	UA943IR	14 60			
	01.68- 01.69	UA916#	14 60	01.92- 01.95	US858	12
	01.87- 01.91	UA939IR	14 100	01.72- 01.73	US818	12 1.5
G15/G1500 5.4	01.67- 01.67	UA916#	14 60			
G15/G1500 5.7	01.71- 01.71	UA916#	14 60			
G15/G1500 5.7 Rally	01.72- 01.86	UA943IR	14 60			
	01.87- 01.93	UA939IR	14 100			
G15/G1500 5.7 Vandura	01.72- 01.81	UA943IR	14 60			
G15/G1500 6.6 Rally	01.79- 01.79	UA943IR	14 60			
G15/G1500 6.6 Vandura	01.76- 01.76	UA943IR	14 60			
G15/G1500 7.4 Rally	01.79- 01.79	UA943IR	14 60			
G25/G2500 3.8	01.67- 01.67	UA916#	14 60	01.67- 01.67	US818	12 1.5
G25/G2500 3.8 Rally	01.68- 01.69	UA916#	14 60	01.68- 01.69	US818	12 1.5
G25/G2500 3.8 Vandura	01.68- 01.69	UA916#	14 60	01.68- 01.69	US818	12 1.5
G25/G2500 4.1	01.67- 01.67	UA916#	14 60	01.67- 01.67	US818	12 1.5
G25/G2500 4.1 Rally	01.68- 01.71	UA916#	14 60	01.68- 01.74	US818	12 1.5
	01.72- 01.84	UA943IR	14 60			
	01.83- 01.84	UA945IR	14 65			
G25/G2500 4.1 Vandura	01.68- 01.71	UA916#	14 60	01.68- 01.74	US818	12 1.5
	01.72- 01.84	UA943IR	14 60			
	01.83- 01.84	UA945IR	14 65			
G25/G2500 4.3 Rally	01.87- 01.95	UA939IR	14 100			
	01.85- 01.90	UA943IR	14 60	01.91- 01.95	US858	12
G25/G2500 4.3 Vandura	01.87- 01.95	UA939IR	14 100			
	01.85- 01.90	UA943IR	14 60	01.91- 01.95	US858	12



G25/G2500 4.6	01.67- 01.67	UA916#	14 60				
G25/G2500 4.8 Rally	01.74- 01.78	UA943IR	14 60				
G25/G2500 4.8 Vandura	01.74- 01.78	UA943IR	14 60				
G25/G2500 5.0	01.72- 01.72	UA943IR	14 60				
	01.70- 01.71	UA916#	14 60		01.70- 01.72	US818	12 1.5
G25/G2500 5.0 Rally	01.73- 01.86	UA943IR	14 60		01.92- 01.95	US858	12
	01.68- 01.69	UA916#	14 60				
	01.87- 01.91	UA939IR	14 100		01.73- 01.73	US818	12 1.5
G25/G2500 5.0 Savana					01.96- 01.97	US858	12
G25/G2500 5.0 Vandura	01.87- 01.91	UA939IR	14 100				
	01.73- 01.86	UA943IR	14 60		01.73- 01.73	US818	12 1.5
	01.68- 01.69	UA916#	14 60		01.92- 01.95	US858	12
G25/G2500 5.4	01.67- 01.67	UA916#	14 60				
G25/G2500 5.7	01.71- 01.71	UA916#	14 60				
G25/G2500 5.7 Rally	01.72- 01.86	UA943IR	14 60				
	01.80- 01.86	UA938IR	14 100				
	01.80- 01.86	UA945IR	14 65				
	01.87- 01.93	UA939IR	14 100				
	01.71- 01.71	UA916#	14 60				
G25/G2500 5.7 Vandura	01.72- 01.86	UA943IR	14 60				
	01.87- 01.93	UA939IR	14 100				
	01.70- 01.71	UA916#	14 60				
G25/G2500 6.2 Rally	01.83- 01.90	UA943IR	14 60		01.91- 01.93	US970	12 2.5
	01.91- 01.93	UA953IR#	14 100				
G25/G2500 6.2 Vandura	01.83- 01.90	UA943IR	14 60		01.91- 01.93	US970	12 2.5
	01.91- 01.93	UA953IR#	14 100				
G25/G2500 6.5 Rally	01.94- 01.95	UA939IR	14 100		01.94- 01.95	US970	12 2.5
G25/G2500 6.5 Vandura	01.94- 01.95	UA939IR	14 100		01.94- 01.95	US970	12 2.5
G25/G2500 6.5 Turbo					01.98- 01.98	US970	12 2.5
G25/G2500 6.5 Turbo Cargo					01.97-	US970	12 2.5
G25/G2500 6.5 Turbo Savana					01.96- 01.96	US970	12 2.5
G25/G2500 6.5 Turbo XT					01.97-	US970	12 2.5
G25/G2500 6.6 Rally	01.75- 01.80	UA943IR	14 60				
G25/G2500 6.6 Vandura	01.75- 01.80	UA943IR	14 60				
G25/G2500 7.4 Rally	01.75- 01.76	UA943IR	14 60				
G35/G3500 4.1 Rally	01.72- 01.74	UA943IR	14 60		01.71- 01.74	US818	12 1.5
	01.71- 01.71	UA916#	14 60				
G35/G3500 4.1 Vandura	01.83- 01.84	UA945IR	14 65		01.71- 01.74	US818	12 1.5
	01.72- 01.84	UA943IR	14 60				
	01.71- 01.71	UA916#	14 60				
G35/G3500 4.3					01.92- 01.95	US858	12
G35/G3500 4.3 Rally					01.95- 01.96	US858	12
G35/G3500 4.3 Savana					01.96- 01.96	US858	12
G35/G3500 4.3 Special					01.96- 01.96	US858	12
G35/G3500 4.3 Vandura	01.85- 01.90	UA943IR	14 60				
	01.87- 01.96	UA939IR	14 100		01.91- 01.96	US858	12
G35/G3500 4.8	01.74- 01.78	UA943IR	14 60				
G35/G3500 4.8 Rally	01.76- 01.78	UA943IR	14 60				
G35/G3500 4.8 Vandura	01.76- 01.78	UA943IR	14 60				
G35/G3500 5.0 Vandura	01.81- 01.81	UA943IR	14 60				
G35/G3500 5.4	01.67- 01.67	UA916#	14 60				
G35/G3500 5.7	01.74- 01.86	UA943IR	14 60				
	01.71- 01.71	UA916#	14 60				
	01.87- 01.93	UA939IR	14 100				
G35/G3500 5.7 Rally	01.71- 01.71	UA916#	14 60				
	01.72- 01.86	UA943IR	14 60				
	01.87- 01.93	UA939IR	14 100				
G35/G3500 5.7 Vandura	01.72- 01.86	UA943IR	14 60				
	01.87- 01.93	UA939IR	14 100				
	01.71- 01.71	UA916#	14 60				
G35/G3500 6.2	01.83- 01.90	UA943IR	14 60		01.91- 01.93	US970	12 2.5
	01.91- 01.93	UA953IR#	14 100				
G35/G3500 6.2 Rally	01.83- 01.90	UA943IR	14 60		01.91- 01.93	US970	12 2.5
	01.91- 01.93	UA953IR#	14 100				
G35/G3500 6.2 Vandura	01.83- 01.90	UA943IR	14 60		01.91- 01.93	US970	12 2.5
	01.91- 01.93	UA953IR#	14 100				
G35/G3500 6.5	01.94- 01.96	UA939IR	14 100		01.94- 01.96	US970	12 2.5
G35/G3500 6.5 Rally	01.94- 01.96	UA939IR	14 100		01.94- 01.96	US970	12 2.5
G35/G3500 6.5 Vandura	01.94- 01.96	UA939IR	14 100		01.94- 01.96	US970	12 2.5
G35/G3500 6.5 Turbo					01.98- 01.98	US970	12 2.5
G35/G3500 6.5 Turbo Savana					01.96- 01.97	US970	12 2.5
G35/G3500 6.5 Turbo Special					01.96- 01.96	US970	12 2.5
G35/G3500 6.6	01.76- 01.80	UA943IR	14 60				
G35/G3500 6.6 Rally	01.75- 01.80	UA943IR	14 60				
G35/G3500 6.6 Vandura	01.75- 01.80	UA943IR	14 60				
G35/G3500 7.4	01.76- 01.79	UA943IR	14 60				
	01.88- 01.93	UA953IR#	14 100				
G35/G3500 7.4 Rally	01.89- 01.93	UA953IR#	14 100				
G35/G3500 7.4 Vandura	01.89- 01.93	UA953IR#	14 100				
Jimmy 4.1	01.70- 01.71	UA916#	14 60				
	01.72- 01.82	UA943IR	14 60		01.70- 01.75	US818	12 1.5
Jimmy 4.3					01.95- 01.95	US858	12
Jimmy 4.8	01.73- 01.73	UA943IR	14 60				
Jimmy 5.0	01.87- 01.87	UA939IR	14 100		01.70- 01.87	US818	12 1.5
	01.72- 01.87	UA943IR	14 60				
	01.70- 01.71	UA916#	14 60				
Jimmy 5.7	01.73- 01.91	UA943IR	14 60				
	01.70- 01.72	UA916#	14 60		01.82- 01.91	US818	12 1.5
	01.87- 01.91	UA953IR#	14 100				
Jimmy 6.2	01.82- 01.90	UA943IR	14 60		01.90- 01.91	US970	12 2.5
	01.91- 01.91	UA953IR#	14 100				
Jimmy 6.6	01.75- 01.79	UA943IR	14 60				
Jimmy 7.4	01.73- 01.76	UA943IR	14 60				
K15/K1500 3.8	01.66- 01.69	UA916#	14 60				
K15/K1500 4.1	01.72- 01.84	UA943IR	14 60		01.66- 01.75	US818	12 1.5
	01.66- 01.71	UA916#	14 60				
K15/K1500 4.1 Suburban	01.68- 01.71	UA916#	14 60				
	01.72- 01.80	UA943IR	14 60		01.68- 01.75	US818	12 1.5
K15/K1500 4.3	01.85- 01.86	UA943IR	14 60				
					01.85- 01.86	US818	12 1.5
K15/K1500 4.6	01.67- 01.67	UA916#	14 60		01.67- 01.67	US818	12 1.5
K15/K1500 4.8	01.66- 01.67	UA916#	14 60				
	01.75- 01.80	UA943IR	14 60				



GMC Continued

K15/K1500 5.0	01.76- 01.86 UA943IR	14 60		
	01.68- 01.70 UA916#	14 60		
K15/K1500 5.0 Suburban	01.72- 01.85 UA943IR	14 60	01.68- 01.86 US818	12 1.5
	01.68- 01.71 UA916#	14 60	01.85- 01.86 US858	12
K15/K1500 5.4	01.67- 01.68 UA916#	14 60	01.68- 01.85 US818	12 1.5
K15/K1500 5.4 Suburban	01.68- 01.68 UA916#	14 60	01.85- 01.85 US858	12
K15/K1500 5.7	01.72- 01.86 UA943IR	14 60	01.68- 01.68 US818	12 1.5
K15/K1500 5.7 Suburban	01.69- 01.71 UA916#	14 60		
	01.69- 01.71 UA916#	14 60	01.82- 01.86 US818	12 1.5
K15/K1500 6.2	01.72- 01.86 UA943IR	14 60	01.82- 01.86 US818	12 1.5
K15/K1500 6.2 Suburban	01.82- 01.86 UA943IR	14 60		
K15/K1500 6.5	01.68- 01.69 UA916#	14 60		
K15/K1500 6.6	01.75- 01.80 UA943IR	14 60		
K15/K1500 6.6 Suburban	01.70- 01.72 UA916#	14 60		
K15/K1500 7.4	01.75- 01.79 UA943IR	14 60		
K1500 4.3	01.76- 01.80 UA943IR	14 60		
K1500 4.3 Sierra	01.88- 01.88 UA939IR	14 100	01.88- 01.88 US858	12
K1500 4.3 Sierra XC	01.89- 01.95 UA939IR	14 100	01.89- 01.97 US858	12
K1500 5.0	01.89- 01.95 UA939IR	14 100	01.89- 01.97 US858	12
K1500 5.0 Sierra	01.88- 01.88 UA939IR	14 100		
	01.89- 01.95 UA939IR	14 100	01.88- 01.88 US818	12 1.5
K1500 5.0 Sierra XC			01.91- 01.98 US858	12
	01.89- 01.95 UA939IR	14 100	01.89- 01.93 US818	12 1.5
K1500 5.7			01.91- 01.98 US858	12
	01.88- 01.88 UA939IR	14 100	01.89- 01.93 US818	12 1.5
K1500 5.7 Sierra			01.88- 01.88 US818	12 1.5
	01.89- 01.95 UA939IR	14 100		
K1500 5.7 Sierra XC			01.89- 01.95 US818	12 1.5
	01.89- 01.95 UA939IR	14 100		
K1500 5.7 Suburban	01.92- 01.95 UA939IR	14 100	01.89- 01.95 US818	12 1.5
K1500 6.2	01.88- 01.88 UA939IR	14 100	01.92- 01.95 US818	12 1.5
K1500 6.2 Sierra	01.89- 01.93 UA939IR	14 100		
K1500 6.2 Sierra XC	01.89- 01.93 UA939IR	14 100	01.89- 01.93 US970	12 2.5
K1500 6.5 Sierra	01.89- 01.93 UA939IR	14 100	01.89- 01.93 US970	12 2.5
K1500 6.5 Sierra XC	01.94- 01.95 UA939IR	14 100	01.94- 01.95 US970	12 2.5
K1500 6.5 Turbo Sierra	01.94- 01.98 UA939IR	14 100	01.94- 01.98 US970	12 2.5
K1500 6.5 Turbo Sierra XC	01.94- 01.98 UA939IR	14 100	01.94- 01.98 US970	12 2.5
K1500 6.5 Turbo Suburban	01.94- 01.95 UA939IR	14 100	01.96- 01.99 US970	12 2.5
K25/K2500 4.1	01.67- 01.71 UA916#	14 60	01.67- 01.75 US818	12 1.5
K25/K2500 4.1 Suburban	01.72- 01.80 UA943IR	14 60		
	01.72- 01.74 UA943IR	14 60	01.68- 01.74 US818	12 1.5
K25/K2500 4.3	01.68- 01.71 UA916#	14 60		
	01.85- 01.85 UA943IR	14 60	01.85- 01.85 US818	12 1.5
K25/K2500 4.6	01.67- 01.67 UA916#	14 60	01.67- 01.67 US818	12 1.5
K25/K2500 4.8	01.67- 01.72 UA916#	14 60	01.70- 01.72 US818	12 1.5
K25/K2500 4.8 Suburban	01.73- 01.86 UA943IR	14 60		
	01.68- 01.72 UA916#	14 60	01.69- 01.72 US818	12 1.5
K25/K2500 4.8	01.73- 01.86 UA943IR	14 60		
K25/K2500 5.0	01.74- 01.74 UA943IR	14 60		
K25/K2500 5.0 Suburban	01.77- 01.78 UA943IR	14 60	01.68- 01.70 US818	12 1.5
	01.68- 01.70 UA916#	14 60		
K25/K2500 5.4	01.68- 01.71 UA916#	14 60		
K25/K2500 5.4 Suburban	01.72- 01.78 UA943IR	14 60	01.68- 01.73 US818	12 1.5
	01.67- 01.68 UA916#	14 60	01.67- 01.68 US818	12 1.5
K25/K2500 5.7	01.68- 01.68 UA916#	14 60	01.68- 01.68 US818	12 1.5
K25/K2500 5.7 Suburban	01.72- 01.86 UA943IR	14 60		
	01.69- 01.71 UA916#	14 60	01.82- 01.86 US818	12 1.5
K25/K2500 6.2	01.69- 01.71 UA916#	14 60		
	01.72- 01.86 UA943IR	14 60	01.82- 01.84 US818	12 1.5
K25/K2500 6.2 Suburban	01.82- 01.86 UA943IR	14 60		
K25/K2500 6.5	01.82- 01.86 UA943IR	14 60		
K25/K2500 6.6	01.68- 01.69 UA916#	14 60		
K25/K2500 6.6 Suburban	01.75- 01.80 UA943IR	14 60		
K25/K2500 7.4	01.75- 01.80 UA943IR	14 60		
K25/K2500 7.4 Suburban	01.73- 01.78 UA943IR	14 60		
K2500 4.3	01.77- 01.77 UA943IR	14 60		
K2500 4.3 Sierra	01.88- 01.88 UA939IR	14 100	01.88- 01.88 US858	12
K2500 4.3 Sierra XC	01.89- 01.95 UA939IR	14 100	01.89- 01.95 US858	12
K2500 5.0	01.89- 01.93 UA939IR	14 100	01.89- 01.93 US858	12
K2500 5.0 Sierra	01.88- 01.88 UA939IR	14 100		
	01.89- 01.95 UA939IR	14 100	01.88- 01.88 US818	12 1.5
K2500 5.0 Sierra XC			01.91- 01.95 US858	12
	01.89- 01.95 UA939IR	14 100	01.89- 01.93 US818	12 1.5
K2500 5.7			01.89- 01.93 US818	12 1.5
	01.88- 01.88 UA939IR	14 100		
K2500 5.7 Sierra			01.88- 01.88 US818	12 1.5
	01.89- 01.95 UA939IR	14 100		
K2500 5.7 Sierra XC			01.89- 01.95 US818	12 1.5
	01.89- 01.95 UA939IR	14 100		
K2500 5.7 Suburban	01.92- 01.95 UA939IR	14 100	01.89- 01.95 US818	12 1.5
K2500 6.2	01.88- 01.88 UA939IR	14 100	01.92- 01.95 US818	12 1.5
K2500 6.2 Sierra	01.89- 01.93 UA939IR	14 100		
K2500 6.2 Sierra XC	01.89- 01.93 UA939IR	14 100	01.89- 01.93 US970	12 2.5
K2500 6.5 Sierra	01.89- 01.93 UA939IR	14 100	01.89- 01.93 US970	12 2.5
K2500 6.5 Sierra XC	01.94- 01.95 UA939IR	14 100	01.94- 01.95 US970	12 2.5
K2500 6.5 Turbo	01.94- 01.95 UA939IR	14 100	01.94- 01.95 US970	12 2.5
K2500 6.5 Turbo Sierra	01.98- 01.00 US970	12 2.5		
K2500 6.5 Turbo Sierra XC	01.92- 01.97 UA939IR	14 100	01.92- 01.97 US970	12 2.5
K2500 6.5 Turbo Suburban	01.92- 01.97 UA939IR	14 100	01.92- 01.97 US970	12 2.5
K2500 7.4 Sierra	01.94- 01.95 UA939IR	14 100	01.96- 01.99 US970	12 2.5
	01.91- 01.93 UA953IR#	14 100		
	01.94- 01.95 UA939IR	14 100	01.91- 01.93 US818	12 1.5





K2500 7.4 Sierra XC	01.91- 01.93	UA953IR#	14	100			
	01.94- 01.95	UA939IR	14	100	01.91- 01.93	US818	12 1.5
K2500 7.4 Suburban	01.94- 01.95	UA939IR	14	100	01.92- 01.93	US818	12 1.5
	01.92- 01.93	UA953IR#	14	100			
K35/K3500 4.1	01.68- 01.71	UA916#	14	60	01.68- 01.75	US818	12 1.5
	01.72- 01.75	UA943IR	14	60			
K35/K3500 4.8	01.68- 01.72	UA916#	14	60			
	01.73- 01.86	UA943IR	14	60	01.69- 01.72	US818	12 1.5
K35/K3500 4.8	01.74- 01.74	UA943IR	14	60			
K35/K3500 5.0	01.68- 01.71	UA916#	14	60	01.68- 01.73	US818	12 1.5
	01.72- 01.73	UA943IR	14	60			
K35/K3500 5.4	01.67- 01.68	UA916#	14	60	01.67- 01.68	US818	12 1.5
	01.72- 01.86	UA943IR	14	60	01.82- 01.86	US818	12 1.5
K35/K3500 5.7	01.69- 01.71	UA916#	14	60			
	01.74- 01.74	UA943IR	14	60			
K35/K3500 6.2	01.82- 01.86	UA943IR	14	60			
	01.68- 01.69	UA916#	14	60			
K35/K3500 6.5	01.70- 01.71	UA916#	14	60			
	01.77- 01.80	UA943IR	14	60			
K35/K3500 7.4	01.73- 01.86	UA943IR	14	60			
					01.85- 01.86	US818	12 1.5
K3500 5.7	01.88- 01.88	UA939IR	14	100			
K3500 5.7 Sierra	01.89- 01.95	UA939IR	14	100	01.88- 01.88	US818	12 1.5
					01.89- 01.95	US818	12 1.5
K3500 5.7 Sierra XC	01.89- 01.95	UA939IR	14	100			
K3500 6.2	01.88- 01.88	UA939IR	14	100	01.89- 01.95	US818	12 1.5
K3500 6.2 Sierra	01.89- 01.93	UA939IR	14	100	01.89- 01.93	US970	12 2.5
K3500 6.2 Sierra XC	01.89- 01.93	UA939IR	14	100	01.89- 01.93	US970	12 2.5
K3500 6.5 Turbo					01.98- 01.00	US970	12 2.5
K3500 6.5 Turbo Sierra	01.92- 01.97	UA939IR	14	100	01.92- 01.97	US970	12 2.5
K3500 6.5 Turbo Sierra XC	01.93- 01.97	UA939IR	14	100	01.93- 01.97	US970	12 2.5
K3500 7.4	01.88- 01.88	UA953IR#	14	100			
K3500 7.4 Sierra	01.94- 01.95	UA939IR	14	100	01.88- 01.88	US818	12 1.5
	01.89- 01.93	UA953IR#	14	100	01.89- 01.93	US818	12 1.5
K3500 7.4 Sierra XC	01.94- 01.95	UA939IR	14	100			
P15/P1500 3.8	01.89- 01.93	UA953IR#	14	100	01.89- 01.93	US818	12 1.5
	01.67- 01.69	UA916#	14	60	01.67- 01.69	US818	12 1.5
P15/P1500 4.1	01.68- 01.72	UA916#	14	60	01.68- 01.72	US818	12 1.5
	01.73- 01.74	UA943IR	14	60			
P15/P1500 4.6	01.67- 01.67	UA916#	14	60			
P15/P1500 4.8	01.75- 01.80	UA943IR	14	60	01.67- 01.67	US818	12 1.5
	01.67- 01.67	UA916#	14	60			
P15/P1500 7.4	01.79- 01.79	UA943IR	14	60			
P25/P2500 4.1	01.72- 01.74	UA943IR	14	60	01.66- 01.72	US818	12 1.5
	01.66- 01.70	UA916#	14	60			
P25/P2500 4.6	01.67- 01.67	UA916#	14	60			
	01.73- 01.89	UA943IR	14	60			
P25/P2500 5.0	01.67- 01.72	UA916#	14	60	01.67- 01.72	US818	12 1.5
	01.68- 01.69	UA916#	14	60	01.68- 01.69	US818	12 1.5
P25/P2500 5.7	01.73- 01.86	UA943IR	14	60			
	01.70- 01.72	UA916#	14	60			
P25/P2500 6.2	01.87- 01.89	UA953IR#	14	100			
	01.82- 01.89	UA943IR	14	60	01.89- 01.89	US970	12 2.5
P35/P3500 4.1	01.73- 01.74	UA943IR	14	60	01.66- 01.72	US818	12 1.5
	01.66- 01.72	UA916#	14	60			
P35/P3500 4.3					01.90- 01.95	US858	12
P35/P3500 4.6	01.67- 01.67	UA916#	14	60			
P35/P3500 4.8	01.67- 01.72	UA916#	14	60			
	01.73- 01.89	UA943IR	14	60	01.67- 01.72	US818	12 1.5
P35/P3500 5.0	01.68- 01.69	UA916#	14	60	01.68- 01.69	US818	12 1.5
	01.70- 01.72	UA916#	14	60			
P35/P3500 5.7	01.73- 01.86	UA943IR	14	60			
	01.87- 01.93	UA953IR#	14	100			
P35/P3500 6.2	01.82- 01.93	UA943IR	14	60	01.89- 01.93	US970	12 2.5
P35/P3500 6.5	01.94- 01.97	UA939IR	14	100	01.94- 01.99	US970	12 2.5
P35/P3500 6.5 Turbo					01.98- 01.99	US970	12 2.5
	01.73- 01.86	UA943IR	14	60			
P35/P3500 7.4	01.87- 01.88	UA953IR#	14	100			
	01.94- 01.97	UA958IR	14	105			
	01.85- 01.85	UA938IR	14	100			
	01.74- 01.74	UA943IR	14	60			
P35/P3500 7.4 Motor Home	01.64- 01.65	UA916#	14	60			
PB1000 2.5	01.63- 01.63	UA916#	14	60			
PB1000 3.8	01.66- 01.66	UA916#	14	60	01.66- 01.66	US818	12 1.5
PB15 3.8	01.66- 01.66	UA916#	14	60	01.66- 01.66	US818	12 1.5
PB15 4.1	01.66- 01.66	UA916#	14	60	01.66- 01.66	US818	12 1.5
PB15 4.8	01.66- 01.66	UA916#	14	60	01.66- 01.66	US818	12 1.5
PB25 3.8	01.66- 01.66	UA916#	14	60	01.66- 01.66	US818	12 1.5
PB25 4.1	01.66- 01.66	UA916#	14	60	01.66- 01.66	US818	12 1.5
PB25 4.8	01.66- 01.66	UA916#	14	60	01.66- 01.66	US818	12 1.5
PB2500 3.8	01.63- 01.63	UA916#	14	60			
R1500 4.3	01.87- 01.87	UA939IR	14	100			
R1500 5.0	01.87- 01.87	UA939IR	14	100			
	01.87- 01.87	UA943IR	14	60			
R1500 5.0 Suburban	01.87- 01.87	UA939IR	14	100			
R1500 5.7	01.87- 01.87	UA943IR	14	60			
	01.87- 01.87	UA953IR#	14	100			
R1500 5.7 Suburban	01.87- 01.91	UA943IR	14	60			
	01.87- 01.91	UA953IR#	14	100			
R1500 6.2	01.87- 01.87	UA943IR	14	60			
R1500 6.2 Suburban	01.87- 01.90	UA943IR	14	60	01.91- 01.91	US970	12 2.5
	01.91- 01.91	UA953IR#	14	100			
R2500 4.3	01.87- 01.87	UA939IR	14	100			
R2500 4.8	01.87- 01.88	UA945IR	14	65			
	01.87- 01.88	UA943IR	14	60			
R2500 5.0	01.87- 01.87	UA939IR	14	100			
R2500 5.7	01.87- 01.87	UA943IR	14	60			
	01.87- 01.89	UA943IR	14	60			
R2500 5.7 Suburban	01.87- 01.89	UA953IR#	14	100			
	01.87- 01.91	UA943IR	14	60			
	01.87- 01.91	UA953IR#	14	100			



**GMC Continued**

R2500 6.2		01.87- 01.89	UA943IR	14 60				
R2500 6.2 Suburban		01.87- 01.90	UA943IR	14 60	01.91- 01.91	US970	12 2.5	
		01.91- 01.91	UA953IR#	14 100				
R2500 7.4		01.87- 01.89	UA943IR	14 60				
R2500 7.4 Suburban		01.87- 01.91	UA943IR	14 60				
		01.88- 01.91	UA953IR#	14 100				
R3500 4.8		01.87- 01.88	UA943IR	14 60				
		01.87- 01.88	UA945IR	14 65				
R3500 5.7		01.87- 01.91	UA943IR	14 60				
		01.87- 01.91	UA953IR#	14 100				
R3500 6.2		01.91- 01.91	UA953IR#	14 100	01.91- 01.91	US970	12 2.5	
		01.87- 01.90	UA943IR	14 60				
R3500 7.4		01.87- 01.91	UA943IR	14 60				
					01.87- 01.89	US818	12 1.5	
S15 1.9		01.82- 01.85	UA943IR	14 60				
S15 1.9 Jimmy		01.83- 01.84	UA943IR	14 60				
S15 2.0		01.83- 01.84	UA943IR	14 60				
S15 2.0 Jimmy		01.83- 01.84	UA943IR	14 60				
S15 2.2		01.84- 01.85	UA945IR	14 65	01.84- 01.85	JS552	12 2.0	
S15 2.5		01.85- 01.90	UA943IR	14 60				
S15 2.5 Jimmy		01.85- 01.88	UA943IR	14 60				
S15 2.8		01.82- 01.85	UA943IR	14 60	01.84- 01.90	US858	12	
S15 2.8 Jimmy		01.83- 01.85	UA943IR	14 60	01.84- 01.89	US858	12	
S15 4.3		01.88- 01.90	UA939IR	14 100	01.88- 01.90	US858	12	
S15 4.3 Jimmy		01.91- 01.94	UA939IR	14 100	01.88- 01.94	US858	12	
Safari 2.5		01.85- 01.90	UA943IR	14 60	01.85- 01.90	US810#	12	
Safari 4.3		01.85- 01.85	UA943IR	14 60	01.90- 01.94	US858	12	
		01.94- 01.94	UA967IR	14 105				
Safari 4.3 XT		01.94- 01.94	UA967IR	14 105	01.91- 01.96	US858	12	
Sierra 4.3 1500					01.99- 01.99	US858	12	
Sonoma 2.5		01.91- 01.93	UA938IR	14 100				
Sonoma 2.8					01.91- 01.93	US858	12	
Sonoma 2.8 GT					01.92- 01.92	US858	12	
Sonoma 4.3		01.91- 01.95	UA939IR	14 100	01.91- 01.95	US858	12	
Sonoma 4.3 GT		01.92- 01.92	UA939IR	14 100	01.92- 01.92	US858	12	
Sprint 4.1		01.71- 01.71	UA916#	14 60	01.71- 01.72	US818	12 1.5	
		01.72- 01.77	UA943IR	14 60				
Sprint 4.1 Custom		01.72- 01.77	UA943IR	14 60				
					01.72- 01.72	US818	12 1.5	
Sprint 5.0		01.77- 01.77	UA943IR	14 60				
Sprint 5.0 Custom		01.77- 01.77	UA943IR	14 60				
Sprint 5.7		01.72- 01.77	UA943IR	14 60				
		01.71- 01.71	UA916#	14 60				
Sprint 5.7 Custom		01.72- 01.77	UA943IR	14 60				
Sprint 6.6		01.74- 01.76	UA943IR	14 60				
Sprint 6.6 Custom		01.74- 01.76	UA943IR	14 60				
Sprint 7.4		01.74- 01.74	UA943IR	14 60				
Sprint 7.4 Custom		01.74- 01.75	UA943IR	14 60				
Syclone 4.3 Turbo		01.91- 01.91	UA939IR	14 100	01.91- 01.91	US858	12	
Truck 4.7		01.55- 01.55	UA943IR	14 60				
Truck 5.5		01.58- 01.59	UA943IR	14 60				
Truck 5.7		01.57- 01.57	UA943IR	14 60				
Typhoon 4.3 Turbo		01.92- 01.93	UA939IR	14 100	01.92- 01.93	US858	12	
V1500 4.3		01.87- 01.87	UA939IR	14 100				
					01.87- 01.87	US818	12 1.5	
V1500 5.0		01.87- 01.87	UA939IR	14 100				
V1500 5.7		01.87- 01.87	UA943IR	14 60				
		01.87- 01.87	UA953IR#	14 100	01.87- 01.87	US818	12 1.5	
V1500 5.7 Suburban		01.91- 01.91	UA939IR	14 100				
		01.87- 01.90	UA943IR	14 60	01.87- 01.91	US818	12 1.5	
		01.87- 01.90	UA953IR#	14 100				
V1500 6.2		01.87- 01.87	UA943IR	14 60				
V1500 6.2 Suburban		01.87- 01.90	UA943IR	14 60				
		01.91- 01.91	UA953IR#	14 100				
V2500 4.8		01.87- 01.87	UA943IR	14 60				
		01.87- 01.87	UA945IR	14 65	01.87- 01.87	US818	12 1.5	
V2500 5.7		01.87- 01.87	UA943IR	14 60				
		01.87- 01.87	UA953IR#	14 100	01.87- 01.87	US818	12 1.5	
V2500 5.7 Suburban		01.87- 01.90	UA943IR	14 60	01.87- 01.91	US818	12 1.5	
		01.87- 01.90	UA953IR#	14 100				
V2500 6.2		01.87- 01.87	UA943IR	14 60				
V2500 6.2 Suburban		01.91- 01.91	UA953IR#	14 100				
		01.87- 01.90	UA943IR	14 60				
V3500 4.8		01.87- 01.88	UA943IR	14 60				
		01.87- 01.88	UA945IR	14 65	01.87- 01.88	US818	12 1.5	
V3500 5.7		01.87- 01.91	UA943IR	14 60				
		01.87- 01.91	UA953IR#	14 100	01.87- 01.91	US818	12 1.5	
V3500 6.2		01.91- 01.91	UA953IR#	14 100	01.91- 01.91	US970	12 2.5	
		01.87- 01.90	UA943IR	14 60				
V3500 7.4		01.87- 01.91	UA943IR	14 60				
					01.87- 01.91	US818	12 1.5	
Yukon 5.7		01.92- 01.95	UA939IR	14 100				
					01.92- 01.94	US818	12 1.5	
Yukon 6.5 Turbo		01.94- 01.97	UA939IR	14 100	01.94- 01.99	US970	12 2.5	
3.8		01.63- 01.67	UA916#	14 60				
4.1		01.66- 01.67	UA916#	14 60				
4.8		01.66- 01.67	UA916#	14 60				
5.0		01.76- 01.76	UA943IR	14 60				
5.0 Custom		01.76- 01.76	UA943IR	14 60				
5.4		01.67- 01.67	UA916#	14 60				
<b>Goldoni</b>								
<b>AGRICULTURE</b>								
25 1.0 Diesel	[12LD475]	11.90- 12.91	CA616IR	14 32				
35 1.3 Diesel	[8LD665.2]	03.91-	CA616IR	14 32				
50 1.9 Diesel	[11LD626]	11.90-	CA616IR	14 32				
60 2.0 Diesel	[VM-RA 394]	11.90-	CA76IR	14 33	11.90-	CS1073	12 2.4	
238 1.6 Diesel		01.77-	CA616IR	14 32				
245 1.9 Diesel	[11LD 625.3]	01.89-	CA616IR	14 32				
938 1.7 Diesel	[5LD 825.2]	09.88- 04.90	CA616IR	14 32				
1038 1.7 Diesel		01.80- 12.85	CA616IR	14 32				
1055 1.8 Diesel	[VM-RA 394]	03.87- 04.90	CA76IR	14 33	03.87- 04.90	CS1073	12 2.4	
3050 1.8 Diesel	[VM-RA 394]	04.86- 06.91	CA76IR	14 33	04.86- 06.91	CS1073	12 2.4	



3050 2.1 Diesel	[VM-HR 394]	06.91-	CA631IR	14 55	06.91-	CS1073	12 2.4
3070 2.1 Diesel	[VM-HR 394]	06.91-	CA631IR	14 55	06.91-	CS1073	12 2.4
	[VM-RA 394]	06.90- 06.91	CA76IR	14 33	06.90- 06.91	CS1073	12 2.4
3445 1.9 Diesel	[11LD 625.3]	10.88-	CA616IR	14 32			
40 B 1.6 Diesel	[11LD 625.3]	06.91-	CA616IR	14 32			
50 B 1.9 Diesel	[11LD 626.3]	06.91-	CA616IR	14 32			
55 B 2.0 Diesel	[VM-HR 394HP]	09.91-	CA631IR	14 55			
933 DT 1.3 Diesel	[8LD665.2]	09.88-	CA616IR	14 32			
945 DT 1.9 Diesel	[11LD 625.3]	04.90-	CA616IR	14 32			
945 RS 1.9 Diesel	[11LD 625.3]	04.90-	CA616IR	14 32			
Cingolato C45 2.0 Diesel	[VM-RA 394]	04.91-	CA631IR	14 55	04.91-	CS1073	12 2.4
		04.91-	CA76IR	14 33			
Cingolato C60 3.0 Diesel	[VM-SUN 3105]	04.91-	CA631IR	14 55			
		04.91-	CA76IR	14 33			
<b>Hanomag</b>							
<b>INDUSTRY</b>							
44 C 7.2	[D943..]				02.80- 07.92	CS805	24 5.5
55C 10.8	[D963B]				01.81- 03.96	CS805	24 5.5
55C 9.5	[D962B]				02.80- 03.96	CS805	24 5.5
600 D 9.5	[D962K]				02.80- 03.96	CS805	24 5.5
66 C 10.8 Turbo	[D963A..]				02.80- 03.96	CS805	24 5.5
700 D 10.8 Turbo	[D963A..]				04.80- 03.96	CS805	24 5.5
77 C 10.8 Turbo	[D963A..]				02.80- 03.96	CS805	24 5.5
<b>Hatz</b>							
<b>MOTORS</b>							
Stationnaires 0.5 74	[1D60]				08.90-	CS1340	12 1.5
Stationnaires 0.7 73	[1D80]				08.90-	CS1340	12 1.5
Stationnaires 2.3			CA96IR	14 55			
Stationnaires 2.4			CA626IR	14 75			
Stationnaires 3.3			CA1048IR	14 50			
Stationnaires 4.3			CA1048IR	14 50			
<b>Hindustan</b>							
<b>PASSENGER CARS AO</b>							
Lancer 2.0 Diesel	[4D68]	11.02-	JA1133IR	14 75	11.02-	JS344	12 2.0
		11.02-	JA1360IR	14 90			
<b>Holden</b>							
<b>PASSENGER CARS AO</b>							
Astra 2.0 Turbo	[Z20LET]	06.02-	CA1581IR	14 100	06.02-	CS879	12 1.1
		06.02-	CA1765IR	14 120			
Vectra 2.2	[Z22SE]	04.02-	CA1765IR	14 120			
Vectra 2.6	[Y26SE]	07.00- 07.02	CA1730IR	14 140			
Vectra 3.2	[Z32SE]	08.02-	CA1730IR	14 140	08.02-	CS1247	12 1.7
Zafira 2.2	[Z22SE]	07.00- 02.06	CA1592IR	14 100	07.00- 02.06	CS1291	12 1.8
		07.00- 02.06	CA1740IR	14 120			
<b>Honda</b>							
<b>PASSENGER CARS EU</b>							
Accord 1.6	[A16A1]	11.85- 12.89	JA771IR	14 65			
	[D16B6]	12.99- 12.02	JA1415IR	14 90	12.99- 12.02	JS1216	12 1.0
Accord 1.6 L	[A16A1]	11.85- 12.89	JA771IR	14 65			
Accord 1.6 i	[D16B6]	10.98- 12.02	JA1415IR	14 90	10.98- 12.02	JS1216	12 1.0
Accord 1.8		01.90- 12.91	JA759IR	14 70	01.90- 12.91	JS648	12 1.0
					01.90- 12.91	JS1150	12 1.6
Accord 1.8 i	[F18A3]	02.96- 10.98	JA1129IR	14 70	AT 02.96- 10.98	JS645	12 1.4
					02.96- 10.98	JS648	12 1.0
	[F18B2]	10.98- 12.02	JA1415IR	14 90	AT 10.98- 12.02	JS1147	12 1.0
					10.98- 12.02	JS1216	12 1.0
Accord 2.0	[A20A1]	11.85- 12.89	JA771IR	14 65			
	[A20A2]	11.85- 12.89	JA771IR	14 65			
	[A20A3]	10.87- 12.89	JA771IR	14 65			
	[A20A4]	11.85- 12.89	JA696IR	14 65			
		11.85- 12.89	JA771IR	14 65			
	[F20B6]	12.99- 12.02	JA1415IR	14 90	AT 12.99- 12.02	JS1147	12 1.0
					12.99- 12.02	JS1216	12 1.0
	[K20A]	AC 02.03-	JA1726IR	14 100			
	[R20A]	07.08-	CA2078IR*	14 105	AT 07.08-	CS1458*	12
Accord 2.0 4WD	[K20A]	02.03-	JA1726IR	14 100			
Accord 2.0 16V	[F20A2]	01.90- 03.93	JA759IR	14 70	01.90- 03.93	JS648	12 1.0 MS
					01.90- 03.93	JS1150	12 1.6 ND
	[F20A6]	01.90- 03.93	JA759IR	14 70	01.90- 03.93	JS1150	12 1.6 ND
					01.90- 03.93	JS648	12 1.0 MS
Accord 2.0 i 16V	[B20A8]	10.87- 12.89	JA753IR	14 60			
	[F20A4]	01.90- 03.93	JA760IR	14 70	01.90- 03.93	JS1150	12 1.6 ND
					01.90- 03.93	JS648	12 1.0 MS
	[F20A7]	01.92- 09.93	JA760IR	14 70	01.92- 09.93	JS648	12 1.0
	[F20A8]	01.90- 03.93	JA760IR	14 70	01.90- 03.93	JS1150	12 1.6 ND
					01.90- 03.93	JS648	12 1.0 MS
	[F20Z1]	03.93- 09.95	JA1129IR	14 70	03.93- 09.95	JS648	12 1.0 MS
					03.93- 09.95	JS1150	12 1.6 ND
	[F20Z3]	03.93- 12.93	JA760IR	14 70	03.93- 12.93	JS1150	12 1.6
Accord 2.0 i	[A20A3]	10.87- 12.89	JA771IR	14 65			
	[F20B3]				09.93- 06.98	JS648	12 1.0
	[F20B5]	02.98- 06.03	JA1415IR	14 90	02.98- 06.03	JS1216	12 1.0
	[F20B6]	10.98- 02.03	JA1415IR	14 90	10.98- 02.03	JS1216	12 1.0
					AT 10.98- 02.03	JS1147	12 1.0
	[F20B7]	02.98- 06.03	JA1415IR	14 90	02.98- 06.03	JS1216	12 1.0
	[F20Z2]	03.93- 09.95	JA1129IR	14 70	03.93- 09.95	JS1150	12 1.6 ND
					03.93- 09.95	JS648	12 1.0 MS
Accord 2.0 i LS	[F20Z1]	02.96- 10.98	JA1129IR	14 70	02.96- 10.98	JS648	12 1.0
		02.96- 10.98	JA1426IR	14 70	AT 02.96- 10.98	JS645	12 1.4
Accord 2.0 TD	[20T2N]	02.99- 12.02	JA1415IR	14 90	02.99- 12.02	JS1216	12 1.0
Accord 2.0 TDi	[20T2N]	09.95- 10.98	JA1425IR	14 80	04.96- 10.00	JS1149	12 1.8
Accord 2.2 Type-R	[H22A7]				09.98- 12.02	JS1216	12 1.0
Accord 2.2 i 16V	[F22A3]	01.90- 03.93	JA760IR	14 70	01.90- 03.93	JS1150	12 1.6 ND
					01.90- 03.93	JS648	12 1.0 MS
	[F22A7]	01.91- 06.94	JA760IR	14 70	01.91- 06.94	JS648	12 1.0
					01.91- 06.94	JS1151	12 1.4
	[F22A8]	01.91- 06.94	JA760IR	14 70	01.91- 06.94	JS648	12 1.0
					01.91- 06.94	JS1151	12 1.4
Accord 2.2 i	[F22B5]				09.93- 06.98	JS648	12 1.0
Accord 2.2 i-VTEC	[F22Z2]	02.96- 10.98	JA1129IR	14 70	AT 02.96- 10.98	JS645	12 1.4
					02.96- 10.98	JS648	12 1.0
Accord 2.2 DTDi	[N22A1]	01.04- 06.08	CA1980IR*	14 120	01.04- 06.08	CS1427*	12 2.0
Accord 2.3	[F23Z5]	11.00- 12.02	JA1415IR	14 90	11.00- 12.02	JS1216	12 1.0
					AT 11.00- 12.02	JS1147	12 1.0



**HONDA** Continued

Accord 2.3 i	[H23A3]	03.93- 09.95	JA1129IR	14 70	03.93- 09.95	JS1150	12 1.6	ND
					03.93- 09.95	JS648	12 1.0	MS
Accord 2.4	[K24A]	AC 02.03-	JA1726IR	14 100				
Accord 2.4 Euro	[K24A3]	06.03-	JA1726IR	14 100				
Accord 2.4 VTEC		04.06- 07.08	JA1726IR	14 100				
City 1.4 VTEC	[L13Z1]	09.08-	CA2080IR*	14 90				
Civic 1.2	[D12B1]				12.83- 10.87	JS319	12 1.0	
	[Z2]				01.85- 10.87	JS645	12 1.4	
					12.83- 10.87	JS319	12 1.0	
					01.85- 10.87	JS645	12 1.4	
Civic 1.3	[D13B1]	10.87- 12.89	JA7511R	14 60	10.87- 12.89	JS319	12 1.0	
	[D13B2]	10.87- 12.89	JA7531R	14 60				
	[EV2]	10.87- 09.91	JA7531R	14 60	10.87- 09.91	JS319	12 1.0	
					10.83- 10.87	JS319	12 1.0	
					10.83- 10.87	JS645	12 1.4	
		01.92- 12.92	JA7531R	14 60	01.92- 12.92	JS319	12 1.0	
Civic 1.3 16V	[D13B2]				10.91- 11.95	JS319	12 1.0	
Civic 1.4	[D14A1]	10.87- 09.91	JA7511R	14 60	10.87- 09.91	JS319	12 1.0	
		10.87- 09.91	JA7531R	14 60				
	[D14Z5]	02.01- 09.05	JA1727IR	14 70	02.01- 09.05	JS1360	12 0.8	
	[L13A7]	01.06-	JA1897IR	14 80	01.06-	CS1489*	12 0.7	
	[L13Z1]	10.08-	CA2080IR*	14 90				
Civic 1.4 16V	[D14A7]	01.97- 02.01	JA1405IR	14 75	01.97- 02.01	JS1147	12 1.0	
	[D14A8]	01.97- 02.01	JA1405IR	14 75	01.97- 02.01	JS1147	12 1.0	
Civic 1.4 i 16V	[D14A1]				10.87- 09.91	JS319	12 1.0	
Civic 1.4 i S S	[D14Z5]	02.01- 09.05	JA1727IR	14 70	02.01- 09.05	JS1360	12 0.8	
	[D14Z6]	02.01- 09.05	JA1727IR	14 70	02.01- 09.05	JS1360	12 0.8	
Civic 1.4 i	[D14A2]	09.94- 01.97	JA1405IR	14 75	09.94- 01.97	JS1152	12 1.0	
	[D14A3]	11.95- 02.01	JA1405IR	14 75	11.95- 02.01	JS1215	12 0.8	
		11.95- 02.01	JA1520IR	14 70				
	[D14A4]	11.95- 10.98	JA1405IR	14 75	11.95- 10.98	JS1215	12 0.8	
		11.95- 10.98	JA1520IR	14 70				
	[D14A5]	09.95- 01.97	JA1405IR	14 75	09.95- 01.97	JS1152	12 1.0	
	[D14Z1]	11.95- 02.01	JA1405IR	14 75	11.95- 02.01	JS1215	12 0.8	
		11.95- 02.01	JA1520IR	14 70				
	[D14Z2]	11.95- 02.01	JA1405IR	14 75	11.95- 02.01	JS1215	12 0.8	
		11.95- 02.01	JA1520IR	14 70				
	[D14Z6]	02.01- 09.05	JA1727IR	14 70	02.01- 09.05	JS1360	12 0.8	
Civic 1.5	[EW2]				10.83- 10.87	JS319	12 1.0	
Civic 1.5 4WD	[EW2]				01.85- 10.87	JS319	12 1.0	
Civic 1.5 GL	[EW2]				10.83- 10.87	JS311#	12 0.8	
					10.83- 10.87	JS319	12 1.0	
Civic 1.5 GT	[EW3]				01.85- 10.87	JS311#	12 0.8	
					01.85- 10.87	JS319	12 1.0	
					01.85- 10.87	JS645	12 1.4	
Civic 1.5 16V	[D15Z8]	07.97- 02.01	JA1514IR	14 70	07.97- 02.01	JS1147	12 1.0	
Civic 1.5 GTi	[EW4]				03.86- 10.87	JS311#	12 0.8	
					03.86- 10.87	JS319	12 1.0	
					03.86- 10.87	JS645	12 1.4	
Civic 1.5 i 16V	[D15B2]	10.87- 11.91	JA7531R	14 60	AT 10.87- 09.91	JS645	12 1.4	
		10.91- 11.95	JA980IR	14 70	10.87- 11.95	JS319	12 1.0	
					10.87- 09.91	JS1022	12 1.2	
	[D15Z1]	10.91- 11.95	JA980IR	14 70	10.91- 11.95	JS319	12 1.0	
Civic 1.5 i	[D15B2]	10.88- 09.91	JA7531R	14 60	AT 10.88- 09.91	JS645	12 1.4	
		10.91- 11.95	JA980IR	14 70	10.88- 11.95	JS319	12 1.0	
	[D15B7]	01.94- 11.95	JA980IR	14 70	01.94- 11.95	JS319	12 1.0	
	[D15Z1]	10.91- 11.95	JA980IR	14 70	10.91- 11.95	JS319	12 1.0	
	[D15Z3]	09.94- 01.97	JA1405IR	14 75	09.94- 01.97	JS1152	12 1.0	
	[D15Z6]	11.95- 02.01	JA1405IR	14 75	11.95- 02.01	JS319	12 1.0	
Civic 1.6	[B16A2]	10.91- 11.95	JA1272IR	14 70				
	[D16V1]	02.01- 09.05	JA1727IR	14 70	02.01- 09.05	JS1353	12 1.0	
	[D16Y6]	01.96- 04.00	JA1520IR	14 70	01.96- 04.00	JS1022	12 1.2	
					01.96- 04.00	JS1152	12 1.0	
	[D16Z9]	01.94- 01.96	JA980IR	14 70	01.94- 01.96	JS1152	12 1.0	
					01.94- 01.96	JS1022	12 1.2	
Civic 1.6 16V	[B16A2]	10.91- 11.95	JA1272IR	14 70				
	[D16A7]	09.87- 09.91	JA7531R	14 60	09.87- 09.91	JS319	12 1.0	
	[D16A9]	09.87- 09.91	JA7531R	14 60	09.87- 09.91	JS319	12 1.0	
	[D16B2]	01.97- 02.01	JA1405IR	14 75	01.97- 02.01	JS1147	12 1.0	
	[D16Z6]	10.91- 11.95	JA980IR	14 70	10.91- 11.95	JS1022	12 1.2	
	[D16Z7]	10.91- 11.95	JA980IR	14 70	10.91- 11.95	JS1022	12 1.2	
Civic 1.6 16V ESi	[D16Z6]	10.91- 11.95	JA980IR	14 70	10.91- 11.95	JS1022	12 1.2	
Civic 1.6 i 16V	[D16A6]	10.89- 09.91	JA7531R	14 60	10.89- 09.91	JS319	12 1.0	
	[D16A7]	06.88- 09.91	JA7531R	14 60	AT 09.87- 09.91	JS645	12 1.4	
					09.87- 09.91	JS1022	12 1.2	
					09.87- 09.91	JS319	12 1.0	
	[D16Z2]	06.88- 09.91	JA7531R	14 60	10.87- 09.91	JS319	12 1.0	
Civic 1.6 i 16V 4WD	[D16A6]	01.88- 06.95	JA7531R	14 60	01.88- 12.89	JS319	12 1.0	
					12.89- 06.95	JS645	12 1.4	
Civic 1.6 i 16V 4WD	[D16A6]	01.88- 06.95	JA7531R	14 60	01.88- 09.91	JS319	12 1.0	
					12.89- 06.95	JS645	12 1.4	
Civic 1.6 i	[D16V1]	AC 02.01- 09.05	JA1727IR	14 70	02.01- 09.05	JS1353	12 1.0	
	[D16Y5]	11.95- 02.01	JA1405IR	14 75				
	[D16Y7]	01.94- 03.00	JA980IR	14 70	01.94- 03.00	JS319	12 1.0	
		10.98- 03.00	JA1272IR	14 70				
	[D16Z2]	06.88- 09.91	JA7531R	14 60	10.87- 09.91	JS319	12 1.0	
Civic 1.6 i GL	[D16A6]	06.88- 09.91	JA7531R	14 60	10.87- 09.91	JS319	12 1.0	
Civic 1.6 i LS	[D16Y3]	09.94- 01.97	JA1405IR	14 75	09.94- 01.97	JS1152	12 1.0	
Civic 1.6 i SR	[D16Y2]	09.94- 01.97	JA1405IR	14 75	09.94- 01.97	JS1152	12 1.0	
Civic 1.6 i-VTEC	[B16A1]	10.89- 09.91	JA1272IR	14 70	10.89- 09.91	JS319	12 1.0	
	[D16Y6]	11.95- 02.01	JA980IR	14 70	11.95- 02.01	JS319	12 1.0	
		10.98- 02.01	JA1272IR	14 70				
	[D16Y8]	03.96- 02.01	JA980IR	14 70	11.95- 02.01	JS319	12 1.0	
		10.98- 02.01	JA1272IR	14 70				
Civic 1.6 VTi	[B16A2]	11.95- 02.01	JA1405IR	14 75				
Civic 1.7	[D17A6]	02.01- 09.05	JA1727IR	14 70				
Civic 1.7 i	[D17A8]	05.01-	JA1727IR	14 70				
	[D17A9]	05.01-	JA1727IR	14 70				
Civic 1.7 CTDi	[4EE-2]	01.02- 09.05	JA1521IR	14 100	01.02- 09.05	JS1158	12 1.4	
Civic 1.8	[R18A2]	01.06-	CA1981IR	14 90	01.06-	CS1458*	12	
Civic 1.8 16V	[B18C4]				04.98- 02.01	JS1147	12 1.0	
	[D18C4]				01.97-	JS1147	12 1.0	
Civic 2.0 Type R	[K20Z4]	09.06-	JA1726IR	14 100				
Civic 2.0 i Sport	[K20A2]				01.04- 09.05	CS1456*	12 1.0	



Civic 2.0 Diesel	[20T2R]	01.97- 02.01	JA1425IR	14 80	01.97-	JS1314	12 1.7
Civic 2.0 TDiC	[20T2N]	04.98- 02.01	JA1424IR	14 90	04.98-	JS1314	12 1.7
		04.98- 02.01	JA1425IR	14 80	11.98- 10.00	JS1149	12 1.8
Civic 2.2 CTDi	[N22A2]	01.06-	CA1980IR*	14 120	01.06-	CS1457*	12 2.0
Civic CRX 1.6 i 16V Targa	[B16A2]	03.92- 12.98	JA1272IR	14 70			
	[D16Y8]	03.92- 12.95	JA980IR	14 70	03.92- 12.95	JS1022	12 1.2
Concerto 1.4	[D14A1]	08.89- 10.92	JA751IR	14 60	10.89- 10.92	JS319	12 1.0
Concerto 1.5 i 16V	[D15B2]	08.89- 03.95	JA753IR	14 60	AT 08.89- 03.95	JS319	12 1.0
					AT 08.89- 03.95	JS1022	12 1.2
Concerto 1.6 16V	[D16Z1]	08.89- 03.95	JA753IR	14 60	08.89- 03.95	JS319	12 1.0
Concerto 1.6 i 16V	[D16A8]	08.89- 03.95	JA753IR	14 60	08.89- 03.95	JS319	12 1.0
	[D16Z2]	08.89- 03.95	JA753IR	14 60	08.89- 03.95	JS319	12 1.0
CR-V 2.0	[K20A4]	AC 07.02- 09.06	JA1728IR	14 70	07.02- 09.06	CS1456*	12 1.0
CR-V 2.0 16V	[B20B]				10.95- 01.99	CS1455*	12 1.0
	[B20Z1]				01.99- 02.02	CS1455*	12 1.0
CR-V 2.0 i-VTEC	[R20A2]	01.07-	CA2078IR*	14 105	AT 01.07-	CS1458*	12
CR-V 2.2 CTDi	[N22A2]	02.05- 09.06	CA1980IR*	14 120	02.05- 09.06	CS1427*	12 2.0
CR-V 2.2 i CTDi	[N22A2]	01.07-	CA1980IR*	14 120	01.07-	CS1457*	12 2.0
CR-V 2.4 i-VTEC 4x4		10.06-	JA1726IR	14 100			
CR-V 2.4 VTEC	[K24A1]	03.02- 09.06	JA1728IR	14 70	03.02- 09.06	CS1456*	12 1.0
CRX 1.5 i	[EW3]				10.83- 11.86	JS311#	12 0.8
					10.83- 11.86	JS319	12 1.0
CRX 1.6 i 16V	[B16A1]	10.89- 02.92	JA1272IR	14 70			
	[D16A]				10.87- 05.88	JS319	12 1.0
	[D16A9]	10.87- 10.89	JA753IR	14 60	10.87- 10.89	JS319	12 1.0
	[D16Z5]	10.87- 02.92	JA753IR	14 60	10.87- 02.92	JS319	12 1.0
CRX 1.6 i	[ZC1]				03.86- 10.87	JS319	12 1.0
FR-V 1.8	[R18A1]	01.07-	CA1981IR	14 90	01.07-	CS1458*	12
FR-V 2.0	[K20A9]	02.05-	JA1728IR	14 70	02.05-	CS1456*	12 1.0
FR-V 2.2 i CTDi	[N22A1]	07.05-	CA1980IR*	14 120	07.05-	CS1427*	12 2.0
HR-V 1.6 16V	[D16W1]	03.99-	JA1720IR	14 75			
HR-V 1.6 16V 4WD	[D16W1]	03.99-	JA1720IR	14 75			
	[D16W5]	10.99-	JA1720IR	14 75			
Integra 1.5	[D15A1]				10.85- 09.89	JS311#	12 0.8
					10.85- 09.89	JS319	12 1.0
					10.85- 08.89	JS645	12 1.4
Integra 1.6	[D16A3]				03.86- 08.89	JS311#	12 0.8
					03.86- 08.89	JS319	12 1.0
					03.86- 08.89	JS645	12 1.4
Jazz 1.2	[L12A1]	03.02-	JA1897IR	14 80	12.05- 12.08	CS1489*	12 0.7
	[L12B1]	07.08-	CA2080IR*	14 90	03.02- 12.05	JS1364	12 0.7
Jazz 1.2 45	[ER2]				02.84- 10.86	JS319	12 1.0
Jazz 1.2 55	[ER4]				09.84- 10.86	JS319	12 1.0
Jazz 1.2 56	[ER1]				10.83- 10.86	JS319	12 1.0
Jazz 1.4	[L13A1]	03.02-	JA1897IR	14 80	01.06- 12.08	CS1489*	12 0.7
	[L13Z1]	07.08-	CA2080IR*	14 90	03.02- 12.05	JS1364	12 0.7
Legend 2.5 i	[C25A1]	01.86- 12.87	JA753IR	14 60			
	[C25A2]	02.87- 06.88	JA753IR	14 60			
Legend 2.7 i 24V	[C27A1]	10.87- 12.90	JA555IR#	14 70			
Logo 1.3 i	[D13B7]	03.99- 03.02	JA1520IR	14 70	03.99- 03.02	JS1215	12 0.8
		AT 03.99- 03.02	JA1514IR	14 70			
Prelude 2.0	[B20A3]	04.87- 01.92	JA759IR	14 70			
	[B20A4]	08.87- 01.92	JA759IR	14 70			
Prelude 2.0 16V	[F20A4]	10.96- 10.00	JA1719IR#	14 90			
Prelude 2.0 i 16V	[F20A4]				02.92- 09.96	JS1150	12 1.6 ND
					02.92- 09.96	JS648	12 1.0 MS
Prelude 2.0 i 16V EX	[B20A1]	04.87- 01.92	JA759IR	14 70			
	[B20A5]	04.87- 01.92	JA759IR	14 70			
	[B20A7]	10.87- 12.90	JA759IR	14 70			
	[B20A9]	04.87- 01.92	JA759IR	14 70			
Prelude 2.2 16V	[H22A5]	10.96- 10.00	JA1719IR#	14 90	10.96- 10.00	JS1150	12 1.6
Prelude 2.2 i 16V	[H22A2]				02.93- 09.96	JS1151	12 1.4
Prelude 2.3 i 16V	[H23A2]				02.92- 09.96	JS1150	12 1.6 ND
					02.92- 09.96	JS648	12 1.0 MS
Shuttle 2.3 16V	[F23A7]	AC 01.98- 05.01	JA1719IR#	14 90			
Stream 2.0 16V	[K20A1]	05.01-	JA1728IR	14 70	05.01-	CS1456*	12 1.0
<b>PASSENGER CARS US</b>							
Accord 1.6	[EF1]	01.76- 01.78	JA144	14 45			
Accord 1.6 LX	[EF1]	01.78- 01.78	JA144	14 45			
Accord 1.8	[EK1]	01.79- 01.80	JA144	14 45			
	[ES2]	01.84- 01.85	JA696IR	14 65			
		01.81- 01.82	JA144	14 45			
Accord 1.8 1800 LX		01.84- 01.85	JA696IR	14 65			
Accord 1.8 1800 SE-I		01.85- 01.85	JA696IR	14 65			
Accord 1.8 1800 STD		01.84- 01.85	JA696IR	14 65			
Accord 1.8 DX	[EK1]	01.79- 01.80	JA144	14 45			
Accord 1.8 LX	[EK1]	01.79- 01.82	JA144	14 45			
Accord 1.8 S	[ES2]	01.84- 01.85	JA696IR	14 65			
Accord 1.8 SE		01.81- 01.81	JA144	14 45			
Accord 2.0	[A20A3]	01.87- 01.87	JA696IR	14 65			
		01.87- 01.87	JA771IR	14 65			
Accord 2.0 DX	[A20A1]	01.87- 01.89	JA696IR	14 65			
		01.87- 01.89	JA771IR	14 65			
	[BS]	01.86- 01.86	JA696IR	14 65			
		01.86- 01.86	JA771IR	14 65			
Accord 2.0 EXI	[A20A3]	01.87- 01.89	JA696IR	14 65			
		01.87- 01.89	JA771IR	14 65			
Accord 2.0 LX	[A20A1]	01.87- 01.89	JA696IR	14 65			
		01.87- 01.89	JA771IR	14 65			
	[BS]	01.86- 01.86	JA696IR	14 65			
		01.86- 01.86	JA771IR	14 65			
Accord 2.0 LXI	[A20A3]	01.87- 01.89	JA696IR	14 65			
		01.87- 01.89	JA771IR	14 65			
	[BS]	01.86- 01.86	JA696IR	14 65			
		01.86- 01.86	JA771IR	14 65			
Accord 2.0 S	[A20A1]	01.88- 01.88	JA696IR	14 65			
		01.88- 01.88	JA771IR	14 65			
	[A20A3]	01.89- 01.89	JA696IR	14 65			
		01.89- 01.89	JA771IR	14 65			
Accord 2.0 SEI	[A20A3]	01.89- 01.89	JA696IR	14 65			
		01.89- 01.89	JA771IR	14 65			
Accord 2.2 10TH Anniversary	[F22A1]				01.93- 01.93	JS1150	12 1.6



**HONDA** *Continued*

Accord 2.2 25TH Anniversary EDI	[F22B2]				01.96- 01.96	<b>JS1151</b>	12	1.4
Accord 2.2 DX	[F22A1]				01.90- 01.93	<b>JS1150</b>	12	1.6
	[F22B2]				01.94- 01.97	<b>JS1151</b>	12	1.4
Accord 2.2 EX	[F22A1]				01.90- 01.91	<b>JS1150</b>	12	1.6
	[F22A4]				01.90- 01.91	<b>JS1150</b>	12	1.6
	[F22A6]				01.91- 01.93	<b>JS1150</b>	12	1.6
	[F22B1]				01.94- 01.97	<b>JS1151</b>	12	1.4
Accord 2.2 EX-R					01.91- 01.91	<b>JS1150</b>	12	1.6
Accord 2.2 LX	[F22A1]				01.90- 01.93	<b>JS1150</b>	12	1.6
	[F22B2]				01.94- 01.97	<b>JS1151</b>	12	1.4
Accord 2.2 SE	[F22A6]				01.91- 01.93	<b>JS1150</b>	12	1.6
	[F22B2]				01.97- 01.97	<b>JS1151</b>	12	1.4
Accord 2.3 DX	[F23A5]				01.98- 01.01	<b>JS1151</b>	12	1.4
Accord 2.3 EX	[F23A1]				01.98- 01.02	<b>JS1151</b>	12	1.4
	[F23A4]				01.98- 01.02	<b>JS1151</b>	12	1.4
Accord 2.3 LX	[F23A1]				01.98- 01.02	<b>JS1151</b>	12	1.4
	[F23A4]				01.99- 01.02	<b>JS1151</b>	12	1.4
Accord 2.3 SE	[F23A1]				01.00- 01.00	<b>JS1151</b>	12	1.4
	[F23A4]				01.00- 01.00	<b>JS1151</b>	12	1.4
Civic 1.3 DX	[D13A2]				01.87- 01.87	<b>JS311#</b>	12	0.8
	[EV1]				01.87- 01.87	<b>JS319</b>	12	1.0
					01.84- 01.86	<b>JS311#</b>	12	0.8
					01.84- 01.86	<b>JS319</b>	12	1.0
Civic 1.5		01.88- 01.91	<b>JA753IR</b>	14 60	01.88- 01.91	<b>JS645</b>	12	1.4
					01.88- 01.91	<b>JS311#</b>	12	0.8
					01.88- 01.91	<b>JS319</b>	12	1.0
Civic 1.5 1500					01.85- 01.87	<b>JS311#</b>	12	0.8
					01.85- 01.87	<b>JS319</b>	12	1.0
					01.85- 01.87	<b>JS645</b>	12	1.4
Civic 1.5 1500 DX		01.88- 01.88	<b>JA753IR</b>	14 60	01.84- 01.88	<b>JS645</b>	12	1.4
					01.84- 01.88	<b>JS319</b>	12	1.0
					01.84- 01.88	<b>JS311#</b>	12	0.8
Civic 1.5 1500 GL					01.84- 01.84	<b>JS645</b>	12	1.4
					01.84- 01.84	<b>JS311#</b>	12	0.8
					01.84- 01.84	<b>JS319</b>	12	1.0
Civic 1.5 1500 S					01.84- 01.87	<b>JS645</b>	12	1.4
					01.84- 01.87	<b>JS311#</b>	12	0.8
					01.84- 01.87	<b>JS319</b>	12	1.0
Civic 1.5 1500 SI					01.86- 01.87	<b>JS319</b>	12	1.0
					01.86- 01.87	<b>JS645</b>	12	1.4
Civic 1.5 CVCC	[ED2]	01.75- 01.76	<b>JA131</b>	14 40				
	[ED3]	01.76- 01.79	<b>JA131</b>	14 40				
	[ED4]	01.77- 01.79	<b>JA131</b>	14 40				
Civic 1.5 CX	[D15B8]	01.92- 01.95	<b>JA980IR</b>	14 70	01.92- 01.95	<b>JS319</b>	12	1.0
					01.92- 01.95	<b>JS311#</b>	12	0.8
		01.89- 01.91	<b>JA753IR</b>	14 60	01.89- 01.91	<b>JS645</b>	12	1.4
					01.89- 01.91	<b>JS319</b>	12	1.0
					01.89- 01.91	<b>JS311#</b>	12	0.8
Civic 1.5 Del Sol S	[D15B7]	01.93- 01.95	<b>JA980IR</b>	14 70	01.93- 01.95	<b>JS311#</b>	12	0.8
					01.93- 01.95	<b>JS319</b>	12	1.0
Civic 1.5 DX	[D15B2]	01.88- 01.91	<b>JA753IR</b>	14 60	01.88- 01.91	<b>JS311#</b>	12	0.8
					01.88- 01.91	<b>JS319</b>	12	1.0
					01.88- 01.91	<b>JS645</b>	12	1.4
	[D15B7]	01.92- 01.95	<b>JA980IR</b>	14 70	01.92- 01.95	<b>JS319</b>	12	1.0
					01.92- 01.95	<b>JS311#</b>	12	0.8
Civic 1.5 GL	[EW1]				01.86- 01.86	<b>JS311#</b>	12	0.8
					01.86- 01.86	<b>JS319</b>	12	1.0
					01.86- 01.86	<b>JS645</b>	12	1.4
Civic 1.5 LX	[D15B2]	01.88- 01.91	<b>JA753IR</b>	14 60	01.88- 01.91	<b>JS645</b>	12	1.4
					01.88- 01.91	<b>JS311#</b>	12	0.8
					01.88- 01.91	<b>JS319</b>	12	1.0
	[D15B7]	01.92- 01.95	<b>JA980IR</b>	14 70	01.92- 01.95	<b>JS319</b>	12	1.0
					01.92- 01.95	<b>JS311#</b>	12	0.8
Civic 1.5 SE		01.88- 01.88	<b>JA753IR</b>	14 60	01.88- 01.88	<b>JS319</b>	12	1.0
					01.88- 01.88	<b>JS311#</b>	12	0.8
					01.88- 01.88	<b>JS645</b>	12	1.4
Civic 1.5 VX	[D15Z1]	01.92- 01.95	<b>JA980IR</b>	14 70	01.92- 01.95	<b>JS311#</b>	12	0.8
					01.92- 01.95	<b>JS319</b>	12	1.0
Civic 1.6 4WD	[D16A6]	01.88- 01.91	<b>JA753IR</b>	14 60	01.88- 01.91	<b>JS319</b>	12	1.0
					01.88- 01.91	<b>JS645</b>	12	1.4
Civic 1.6 CX	[D16Y7]	01.96- 01.00	<b>JA1514IR</b>	14 70	01.96- 01.98	<b>JS319</b>	12	1.0
Civic 1.6 Del Sol S	[D16Y7]	01.96- 01.97	<b>JA1514IR</b>	14 70	01.96- 01.97	<b>JS319</b>	12	1.0
Civic 1.6 Del Sol SI	[D16Y8]	01.96- 01.97	<b>JA1514IR</b>	14 70	01.96- 01.97	<b>JS319</b>	12	1.0
	[D16Z6]	01.93- 01.95	<b>JA980IR</b>	14 70	01.93- 01.95	<b>JS319</b>	12	1.0
Civic 1.6 DX	[D16Y7]	01.96- 01.00	<b>JA1514IR</b>	14 70	01.96- 01.98	<b>JS319</b>	12	1.0
Civic 1.6 EX	[D16A6]	01.90- 01.91	<b>JA753IR</b>	14 60	01.90- 01.91	<b>JS319</b>	12	1.0
					01.90- 01.91	<b>JS645</b>	12	1.4
	[D16Y8]	01.96- 01.00	<b>JA1514IR</b>	14 70	01.96- 01.98	<b>JS319</b>	12	1.0
	[D16Z6]	01.92- 01.95	<b>JA980IR</b>	14 70	01.92- 01.95	<b>JS319</b>	12	1.0
Civic 1.6 HX	[D16Y5]	01.96- 01.00	<b>JA1514IR</b>	14 70	01.96- 01.97	<b>JS319</b>	12	1.0
Civic 1.6 LX	[D16Y7]	01.96- 01.00	<b>JA1514IR</b>	14 70	01.96- 01.98	<b>JS319</b>	12	1.0
Civic 1.6 SI	[B16A2]	01.99- 01.00	<b>JA1514IR</b>	14 70				
	[D16A6]	01.89- 01.91	<b>JA753IR</b>	14 60	01.89- 01.91	<b>JS645</b>	12	1.4
					01.89- 01.91	<b>JS319</b>	12	1.0
	[D16Z6]	01.92- 01.95	<b>JA980IR</b>	14 70	01.92- 01.95	<b>JS319</b>	12	1.0
Civic 1.6 GX	[D16B5]	01.99- 01.00	<b>JA1514IR</b>	14 70				
CRX 1.5	[D15B2]	01.91- 01.91	<b>JA753IR</b>	14 60	01.91- 01.91	<b>JS311#</b>	12	0.8
					01.91- 01.91	<b>JS319</b>	12	1.0
					01.91- 01.91	<b>JS645</b>	12	1.4
CRX 1.5 1500					01.84- 01.87	<b>JS311#</b>	12	0.8
					01.84- 01.87	<b>JS319</b>	12	1.0
					01.84- 01.87	<b>JS645</b>	12	1.4
CRX 1.5 1500 HF		01.88- 01.89	<b>JA753IR</b>	14 60	01.85- 01.89	<b>JS311#</b>	12	0.8
					01.85- 01.89	<b>JS319</b>	12	1.0
					01.85- 01.89	<b>JS645</b>	12	1.4
CRX 1.5 1500 SI					01.85- 01.87	<b>JS645</b>	12	1.4
					01.85- 01.87	<b>JS319</b>	12	1.0
CRX 1.5 DX	[D15B2]	01.88- 01.90	<b>JA753IR</b>	14 60	01.88- 01.90	<b>JS645</b>	12	1.4
					01.88- 01.90	<b>JS311#</b>	12	0.8
					01.88- 01.90	<b>JS319</b>	12	1.0
CRX 1.5 HF	[D15B6]	01.90- 01.91	<b>JA753IR</b>	14 60	01.90- 01.91	<b>JS319</b>	12	1.0
					01.90- 01.91	<b>JS311#</b>	12	0.8
					01.90- 01.91	<b>JS645</b>	12	1.4



CRX 1.6 SI	[D16A6]	01.88- 01.91	JA753IR	14 60	01.88- 01.91	JS319	12 1.0
					01.88- 01.91	JS645	12 1.4
Prelude 1.8	[A18A1]	01.87- 01.87	JA696IR	14 65			
	[EK1]	01.79- 01.82	JA144	14 45			
Prelude 2.0 2.0 S		01.88- 01.90	JA759IR	14 70			
Prelude 2.0 2.0 SI		01.88- 01.90	JA759IR	14 70			
		01.85- 01.87	JA696IR	14 65			
Prelude 2.0 2.0 SI 4WS		01.88- 01.89	JA759IR	14 70			
Prelude 2.0 SR		01.90- 01.90	JA759IR	14 70			
Prelude 2.2	[H22A4]				01.97- 01.98	JS1150	12 1.6
Prelude 2.2 S	[F22A1]				01.92- 01.96	JS1150	12 1.6
Prelude 2.2 SH	[H22A4]				01.97- 01.98	JS1150	12 1.6
Prelude 2.2 VTEC	[H22A1]				01.93- 01.96	JS1150	12 1.6
Prelude 2.3 4WS					01.93- 01.94	JS1150	12 1.6
Prelude 2.3 SE	[H23A1]				01.95- 01.95	JS1150	12 1.6
Prelude 2.3 SI	[H23A1]				01.92- 01.96	JS1150	12 1.6
Prelude 2.3 SI 4WS	[H23A1]				01.92- 01.92	JS1150	12 1.6
Wagovan 1.5	[D15A2]				01.87- 01.87	JS311#	12 0.8
					01.87- 01.87	JS319	12 1.0
					01.87- 01.87	JS645	12 1.4
	[EW1]				01.84- 01.85	JS311#	12 0.8
					01.84- 01.85	JS319	12 1.0
					01.84- 01.85	JS645	12 1.4
					01.86- 01.86	JS311#	12 0.8
					01.86- 01.86	JS319	12 1.0
					01.86- 01.86	JS645	12 1.4
<b>PASSENGER CARS AO</b>							
Accord 1.6 LS	[D16B7]				10.98- 12.02	JS1147	12 1.0
Accord 2.4	[K24A8]	09.06-	JA1726IR	14 100			
Accord 2.4 VTEC E	[K24A2]	09.03- 09.05	JA1726IR	14 100			
Accord 2.4 VTEC T	[K24A1]	09.03-	JA1726IR	14 100			
Airwave 1.5	[L15A2]	06.04-	JA1897IR	14 80			
Airwave 1.5 iDSi MDS 4WD	[L15A2]	06.04-	JA1897IR	14 80			
Civic 1.4	[D14A4]	11.95- 10.98	JA1405IR	14 75	11.95- 10.98	JS319	12 1.0
Civic 1.5	[D15B1]				01.88- 12.89	JS645	12 1.4
	[D15B2]				01.92- 12.92	JS645	12 1.4
Civic 1.6	[D16W4]	11.98- 10.00	JA1514IR	14 70	11.98- 10.00	JS319	12 1.0
					11.98- 10.00	JS1022	12 1.2
					11.98- 10.00	JS645	12 1.4
	[D16Z5]	01.88- 12.89	JA753IR	14 60	01.88- 12.89	JS319	12 1.0
	[R16A1]	09.05- 09.05	JA1727IR	14 70			
Civic 1.6 4WD	[D16A]	01.88- 12.92	JA753IR	14 60	01.88- 12.92	JS319	12 1.0
					01.88- 12.92	JS645	12 1.4
	[D16A7]	01.88- 12.92	JA753IR	14 60	01.88- 12.92	JS319	12 1.0
					01.88- 12.92	JS645	12 1.4
	[D16Z5]	01.89- 12.89	JA753IR	14 60	01.89- 12.89	JS319	12 1.0
	[D16Z7]	01.92- 10.95	JA980IR	14 70	01.92- 10.95	JS319	12 1.0
		01.88- 12.91	JA753IR	14 60	01.88- 12.91	JS319	12 1.0
Civic 1.6 EX	[D16A7]				08.93- 10.95	JS1022	12 1.2
					08.93- 10.95	JS319	12 1.0
					08.93- 10.95	JS645	12 1.4
Civic 1.8	[R18A1]	09.05-	JA1727IR	14 70			
Concerto 1.6	[D16A9]	10.89- 10.92	JA753IR	14 60			
CR-V 2.0	[B20Z1]				04.99- 02.02	CS1455*	12 1.0
CRX 1.4 GL	[D14A1]				01.90- 12.91	JS645	12 1.4
Fit 1.3	[L13A1]	05.03-	JA1897IR	14 80	05.03- 12.05	JS1364	12 0.7
					01.06- 12.08	CS1489*	12 0.7
Fit 1.5	[L15A2]	10.04-	JA1897IR	14 80			
		05.03-	JA1897IR	14 80			
Jazz 1.4	[L13A5]	04.05-	JA1897IR	14 80	04.05-	JS1364	12 0.7
Jazz 1.5	[L15A]	04.02-	JA1897IR	14 80			
<b>Hyster</b>							
<b>FORK LIFTS</b>							
30 40 50	[4.203]				01.71- 12.78	US835#	12
60 70 80 100	[4.203]				01.69- 12.76	US835#	12
60 70 80 90	[4.203]				01.69- 12.78	US835#	12
<b>Hyundai</b>							
<b>PASSENGER CARS EU</b>							
Accent 1.3	[G4E-A]	08.99- 08.03	JA1788IR	14 80	08.99- 08.03	JS1311	12 0.9
		08.99- 08.03	JA1789IR	14 90	AT 08.99- 08.03	JS1312	12 0.9
		08.99-	JA879IR	14 75			
	[G4EH]	07.94- 07.99	JA879IR	14 75	A13 07.94- 07.99	JS349	12 0.9
		07.94- 07.99	JA994IR	14 90	AT 07.94- 07.99	JS643	12 0.9
					07.94- 07.99	JS396#	12 0.7
		08.02-	JA1789IR	14 90	AT 08.02-	JS1312	12 0.9
					08.02-	JS1311	12 0.9
Accent 1.3 i 12V	[G4EH]	07.94- 07.99	JA1126IR	14 75	07.94- 07.99	JS396#	12 0.7
		10.94- 07.99	JA879IR	14 75	AT 07.94- 07.99	JS643	12 0.9
		10.94- 07.99	JA994IR	14 90	A13 07.94- 07.99	JS349	12 0.9
Accent 1.4 GL	[G4EE]	11.05-	JA1789IR	14 90	AT 11.05-	JS1312	12 0.9
					11.05-	JS1311	12 0.9
Accent 1.5	[G4EB]	01.00-	JA879IR	14 75	AT 01.00-	JS1312	12 0.9
		08.02-	JA1789IR	14 90	01.00-	JS1311	12 0.9
					A13 01.00-	JS396#	12 0.7
					AT 01.00-	JS643	12 0.9
					01.00-	JS349	12 0.9
	[G4EC-G]	09.00-	JA879IR	14 75	AT 09.00-	JS643	12 0.9
					A13 09.00-	JS396#	12 0.7
					AT 09.00-	JS1312	12 0.9
					09.00-	JS1311	12 0.9
					09.00-	JS349	12 0.9
Accent 1.5 i 12V	[G4EK]	07.94- 07.99	JA879IR	14 75	AT 07.94- 07.99	JS643	12 0.9
		10.94- 07.99	JA994IR	14 90	07.94- 07.99	JS396#	12 0.7
					A13 07.94- 07.99	JS349	12 0.9
Accent 1.5 i 16V	[G4FK]	10.95- 01.00	JA994IR	14 90	10.95- 01.00	JS349	12 0.9
					AT 10.95- 07.99	JS1003	12 0.9
Accent 1.5 CRDi	[D3-EA]	01.02- 11.02	JA1808IR	14 100	01.02-	JS1349	12 1.7
Accent 1.5 CRDi GLS	[D4FA]	11.05-	CA1906IR	14 120	AT 11.05-	JS1312	12 0.9
					11.05-	JS1365	12 1.7
Accent 1.6	[G4ED-G]	12.02-	JA1788IR	14 80	AT 12.02-	JS1312	12 0.9
		12.02-	JA1789IR	14 90	12.02-	JS1311	12 0.9
Accent 1.6 GLS	[G4ED]	11.05-	JA1789IR	14 90	AT 11.05-	JS1312	12 0.9
					11.05-	JS1311	12 0.9



**HYUNDAI** *Continued*

Atos 1.0 i	[G4HC]	02.98- 10.02	JA1715IR	14 60	02.98- 10.02	JS1303	12 0.8
	[G4HC-E]	03.01- 03.01	JA1715IR JA1798IR	14 60 14 70	03.01-	JS1303	12 0.8
Atos 1.1	[G4HG]	03.04-	JA1798IR	14 70	03.04-	JS1303	12 0.8
Atos 1.1 Prime	[G4HG]	09.05-	JA1715IR	14 60	09.05-	JS1303	12 0.8
		09.05-	JA1798IR	14 70			
Atos 1.3		08.03- 08.08	JA1798IR	14 70	08.03- 08.08	JS1303	12 0.8
Atos Prime 1.0 i	[G4HC]	02.98-	JA1715IR	14 60	02.98-	JS1303	12 0.8
	[G4HC-E]	03.01- 03.01	JA1715IR JA1798IR	14 60 14 70	03.01-	JS1303	12 0.8
Atos Prime 1.1	[G4HD]	06.03-	JA1798IR	14 70	06.03-	JS1312	12 0.9
Coupe 1.6 16V	[G4ED-G]	03.02-	CA2088IR*	14 95	03.02-	JS1311	12 0.9
		03.02-	JA1789IR	14 90			
	[G4GR]	05.00- 09.01	JA1788IR	14 80	05.96- 09.01	JS349	12 0.9
		05.96- 05.00	JA994IR	14 90	05.96- 05.00	JS923	12 1.2
				AT 06.00- 09.01	JS643	12 0.9	
				05.96- 05.00	JS922	12 1.2	
Coupe 1.6 i 16V	[4G61]	05.00- 09.01	JA1788IR	14 80	05.96- 09.01	JS923	12 1.2
		05.96- 05.00	JA994IR	14 90	AT 05.96- 09.01	JS922	12 1.2
Coupe 2.0	[G4DF]	08.99- 01.02	JA994IR	14 90	08.99- 01.02	JS922	12 1.2
	[G4GC-G]	08.01-	CA2088IR*	14 95	AT 08.01-	JS922	12 1.2
		08.01-	JA1788IR	14 80	08.01-	JS923	12 1.2
		08.01-	JA1789IR	14 90			
Coupe 2.0 GLS	[G4GC-G]	10.01- 07.02	JA1788IR	14 80			
		08.02- 02.03	JA1789IR CA2088IR*	14 90 14 95			
Coupe 2.0 16V	[G4GF]	08.96- 04.02	JA994IR	14 90	08.96- 04.02	JS923	12 1.2
					AT 08.96- 04.02	JS922	12 1.2
		08.02-	JA1789IR	14 90	AT 08.04- 09.04	JS922	12 1.2
		03.01- 07.02	JA1788IR	14 80	AT 10.04-	JS1370	12 1.2
					10.04-	CS1433	12 1.2
				08.04- 09.04	JS923	12 1.2	
Coupe 2.7	[G6BA-G]	01.07-	CA2088IR*	14 95			
		01.07-	JA1903IR	14 120			
Coupe 2.7 V6	[G6BA-G]	03.02-	CA2088IR*	14 95	03.02-	CS1492*	12 1.2
Elantra 1.6	[G4ED-G]	06.00-	JA1789IR	14 90	AT 06.00- 03.01	JS643	12 0.9
					AT 04.01-	JS1312	12 0.9
					06.00- 03.01	JS1311	12 0.9
		AC 06.00-	JA1788IR	14 80	06.00- 03.01	JS349	12 0.9
	[G4GA]	09.03-	JA1789IR	14 90	AT 03.01-	JS1312	12 0.9
					09.03-	JS1311	12 0.9
		08.02- 07.03	JA1789IR	14 90	06.00- 07.03	JS349	12 0.9
		06.00- 08.02	JA1788IR	14 80	AT 06.00- 07.03	JS643	12 0.9
Elantra 1.6 CVVT	[G4ED-G]	06.06-	CA2020IR	14 90	06.06-	CS1465	12 0.9
				06.06-	CS1462	12 0.9	
Elantra 1.6 CRDi	[D4FB]	02.06-	CA1906IR	14 120	02.06-	JS1365	12 1.7
Elantra 1.8	[G4BB]	06.00-	JA879IR	14 75	AT 06.00-	JS922	12 1.2
					06.00-	JS923	12 1.2
	[G4GB]	11.02-	JA1789IR	14 90	06.00- 07.04	JS923	12 1.2
				AT 06.00- 07.04	JS922	12 1.2	
Elantra 2.0	[G4GC]	06.00-	JA879IR	14 75	06.00-	JS923	12 1.2
		AC 10.03-	JA1789IR	14 90	AT 06.00-	JS922	12 1.2
	[G4GC-G]	06.00-	JA879IR	14 75	06.00-	JS923	12 1.2
				AT 06.00-	JS922	12 1.2	
Elantra 2.0 CRDi	[D4EA]	04.01-	JA1708IR	14 120	04.01-	JS1234	12 2.0
Excel 1.3	[G4DG]				01.90- 01.95	JS396#	12 0.7
Gallopier 2.5 Diesel Intercooler	[D4BH]	02.97- 09.02	JA1716IR	14 75	02.97- 09.02	JS770	12 2.0
		02.97- 09.02	JA1717IR	14 90	AT 02.97- 09.02	JS769	12 2.2
				A13 02.97- 09.02	JS892	12 2.2	
Gallopier 2.5 TCI Intercooler	[D4BH]	02.97-	JA1716IR	14 75	02.97- 09.02	JS770	12 2.0
		02.97-	JA1717IR	14 90	AT 02.97- 09.02	JS769	12 2.2
				A13 02.97- 09.02	JS892	12 2.2	
Gallopier 2.5 TD	[4D56T]	08.91-	JA1717IR	14 90	08.91- 07.98	JS344	12 2.0
					08.91- 07.98	JS769	12 2.2
	[D4BA]	02.97- 02.97	JA1716IR JA1717IR	14 75 14 90	02.97- 08.01	JS769	12 2.2
				02.97- 08.01	JS344	12 2.0	
Gallopier 2.5 TD Intercooler	[4D56T]	08.91-	JA1717IR	14 90	08.91- 07.98	JS770	12 2.0
					A13 08.91- 07.98	JS892	12 2.2
				AT 08.91- 07.98	JS769	12 2.2	
Gallopier 3.0 V6	[6G72]	08.91-	JA870IR	14 90			
	[G6AT]	08.98- 08.01	JA870IR	14 90	02.97- 08.01	JS770	12 2.0
				A13 02.97- 08.01	JS892	12 2.2	
Getz 1.1	[G4HD]	09.02- 12.06	JA1798IR	14 70	09.02-	JS1303	12 0.8
		12.06- 06.09	CA2103IR*	14 70			
		09.05- 12.06	JA1798IR	14 70	09.05-	JS1303	12 0.8
		12.06- 06.09	CA2103IR*	14 70			
Getz 1.3	[G4E-A]	09.02-	JA1789IR	14 90	09.02-	JS1311	12 0.9
					AT 09.02-	JS1312	12 0.9
Getz 1.4	[G4EE]	08.05-	JA1789IR	14 90	AT 08.05-	JS1312	12 0.9
					08.05-	JS1311	12 0.9
Getz 1.5 CRDi	[D3-EA]	08.05-	CA1938IR	14 90	03.03-	JS1349	12 1.7
		AC 03.03- 03.05	JA1808IR	14 100			
		08.05-	CA1906IR	14 120	08.05-	JS1365	12 1.7
		08.05-	CA1938IR	14 90			
Getz 1.5 CRDi GLS	[D4FA]	08.05-	JA1808IR	14 100	08.05-	JS1349	12 1.7
Getz 1.6	[G4ED-G]	09.02-	JA1789IR	14 90	09.02-	JS1311	12 0.9
					AT 09.02-	JS1312	12 0.9
Grandeur 2.2 CRDi	[D4EB]	06.06-	CA2018IR	14 120	06.06-	JS1234	12 2.0
H-1 2.4	[G4CS]	10.97-	JA870IR	14 90	10.97-	JS628	12 1.2
H-1 2.4 Starex	[G4CS]	10.97-	JA870IR	14 90	10.97-	JS628	12 1.2
H-1 2.4 Starex 4WD	[G4CS]	10.97-	JA888IR#	14 75	10.97-	JS628	12 1.2
H-1 2.5 CRDi	[D4CB]	11.02-	JA1804IR	14 110	11.02-	JS1355	12 2.2
		02.08-	JA1711IR	14 75			
		01.07-	JA1711IR	14 75	01.07-	JS1351	12 2.0
		01.07-	JA1518IR	14 110			
H-1 2.5 CRDi Starex		12.02-	JA1804IR	14 110	06.06-	JS1351	12 2.0
		06.06-	JA1518IR	14 110	12.02-	JS1355	12 2.2
		06.06-	JA1711IR	14 75			
H-1 2.5 CRDi Starex 4WD		12.02-	JA1804IR	14 110	12.02-	JS1355	12 2.2
H-1 2.5 Diesel Starex	[D4BB]	10.97-	JA1711IR	14 75	10.97-	JS769	12 2.2
		AC 10.97-	JA1518IR	14 110	10.97-	JS344	12 2.0
H-1 2.5 TD	[D4BF]	03.00- 09.00	JA1711IR	14 75	03.00- 09.00	JS344	12 2.0
		AC 03.00- 09.00	JA1518IR	14 110	A13 03.00- 09.00	JS769	12 2.2





	[D4BH]	03.00-03.00-	JA14191R JA17111R	14 90 14 75		03.00-07.03 AT 03.00-07.03	JS892 JS769 JS1351	12 2.2 12 2.2 12 2.0
		AC 03.00-	JA15181R	14 110		03.00-07.03	JS770	12 2.0
H-1 2.5 TD Starex	[D4BF]	10.97-10.97-	JA17111R JA15181R	14 75 14 110		A13 10.97-10.97-	JS769 JS344	12 2.2 12 2.0
	[D4BH]	10.99-	JA17111R	14 75		AT 10.99-07.03	JS769 JS1351	12 2.2 12 2.0
		AC 10.99-	JA15181R	14 110		06.02-07.03 10.99-05.02 11.01-	JS770 JS892 JS344	12 2.0 12 2.2 12 2.0
H-1 2.5 TD Starex 4WD	[D4BH]	03.01-03.01-11.01-AC 03.01-	JA14191R JA17111R JA15181R JA15181R	14 90 14 75 14 110 14 110		03.01-AT 03.01-11.01-03.01-	JS770 JS769 JS344 JS892	12 2.0 12 2.2 12 2.0 12 2.2
H-1 Starex 2.6 TDiC		AC 10.97-10.02-AC 10.97-03.08	JA17111R JA15181R	14 75 14 110		10.97-10.02 10.97-10.02	JS344 JS769	12 2.0 12 2.2
H100 2.4	[G4CS]	01.97-03.00	JA8701R	14 90		01.97-03.00	JS628	12 1.2
H100 2.5 Diesel	[D4BA]	07.93-09.96-w/o ABS 07.93-03.00-w/ABS 07.93-03.00	JA13661R JA16181R JA17161R	14 65 14 65 14 75		07.94-03.00 07.93-03.00	JS769 JS344	12 2.2 12 2.0
	[D4BB]	12.94-03.00-w/o ABS 07.94-08.02-w/ABS 07.94-08.02	JA13661R JA16181R JA17161R	14 65 14 65 14 75		12.94-08.02	JS769	12 2.2
	[D4BX]	07.93-12.94-07.93-12.94	JA13661R JA16181R	14 65 14 65		07.93-12.94	JS769	12 2.2
H100 2.5 TD	[D4BF]	07.93-03.00-07.93-03.00	JA13661R JA16181R	14 65 14 65		07.93-03.00	JS769	12 2.2
H-100 2.4	[G4CS]	05.96-12.97-05.96-12.97	JA8701R JA8881R#	14 90 14 75	▲	05.96-12.97	JS628	12 1.2
H-100 2.5 Diesel	[D4BA]	07.93-12.97-w/o ABS 07.93-12.97-w/ABS 07.93-12.97-w/ABS 05.96-12.97-w/o ABS 05.96-12.97	JA13661R JA16181R JA17161R JA17161R JA16181R	14 65 14 65 14 75 14 75 14 65		07.93-12.97 05.96-12.97	JS769 JS769	12 2.2 12 2.2
H100 P 2.4	[G4CS]	07.93-06.97-06.97-03.00	JA8881R# JA8701R	14 75 14 90	▲	07.93-03.00	JS628	12 1.2
H100 P 2.5 Diesel	[D4BA]	07.93-09.96-w/o ABS 07.93-03.00-w/ABS 07.93-03.00	JA13661R JA16181R JA17161R	14 65 14 65 14 75		07.93-03.00 07.93-03.00	JS769 JS344	12 2.2 12 2.0
	[D4BX]	07.93-12.94	JA13661R	14 65		07.93-12.94	JS769	12 2.2
i10 1.1	[G4HG]	01.08-01.08-	CA21031R* JA17981R	14 70 14 70	BO VA	01.08-	JS1303	12 0.8
i10 1.1 CRDi	[D3FA]	01.08-	CA19381R	14 90		04.11-01.08-	JS1303 JS1365	12 0.8 12 1.7
i20 1.4		09.08-	CA20201R	14 90		09.08-	CS1465	12 0.9
i20 1.6		09.08-	CA20201R	14 90		09.08-	CS1465	12 0.9
i20 1.6 CRDi						09.08-	JS1365	12 1.7
i30 1.4	[G4FA]	10.07-	CA20201R	14 90		10.07-11.11-	CS1462 CS1465	12 0.9 12 0.9
i30 1.6	[G4FC]	10.07-	CA20201R	14 90		07.08-10.07-06.08-01.12-	CS1465 CS1462 CS1465	12 0.9 12 0.9 12 0.9
i30 1.6 CRDi	[D4FB]	10.07-10.07-11.11-	CA19061R CA19061R	14 120 14 120		10.07-	JS1365	12 1.7
i30 2.0	[G4GC-G]	10.07-	CA19271R	14 90		AT 10.07-10.07-	JS1370 CS1433	12 1.2 12 1.2
i30 2.0 CRDi	[D4EA]	10.07-	CA20181R	14 120				
i30 CW 1.4	[G4FA]	10.07-	CA20201R	14 90		10.07-	CS1465	12 0.9
i30 CW 1.6	[G4FC]	02.08-	CA20201R	14 90		02.08-06.08-06.08-	CS1462 CS1465	12 0.9 12 0.9
i30 CW 1.6 CRDi	[D4FB]	02.08-	CA19061R	14 120		02.08-	JS1365	12 1.7
i30 CW 2.0	[G4GC-G]	02.08-	CA19271R	14 90		AT 02.08-02.08-	JS1370 CS1433	12 1.2 12 1.2
i30 CW 2.0 CRDi	[D4EA]	02.08-	CA20181R	14 120				
i40 CW 1.6 GDi						07.11-	CS1465	12 0.9
ix20 1.4 CVVT	[D4FA]					11.10-	CS1465	12 0.9
ix20 1.4 CRDi	[D4FC-M]					06.11-	JS1365	12 1.7
ix20 1.6 CVVT	[G4FC]					11.10-	CS1465	12 0.9
ix20 1.6 CRDi	[D4FB]					06.11-	JS1365	12 1.7
ix35 1.6						11.10-	CS1465	12 0.9
Lantra 1.5 12V	[G4EK]	12.96-09.00-12.96-09.00	JA8791R JA9941R	14 75 14 90		AT 12.96-09.00-12.96-09.00	JS643 JS349	12 0.9 12 0.9
Lantra 1.5 i	[G15B]	10.90-11.95-10.90-11.95	JA5981R JA6891R	14 60 14 75		10.90-11.95-10.90-11.95	JS643 JS349 JS350	12 0.9 12 0.9 12 0.7
	[G4DJ]	10.90-11.95-10.90-11.95	JA5981R JA6891R	14 60 14 75		10.90-11.95-10.90-11.95	JS349 JS643 JS350	12 0.9 12 0.9 12 0.7
Lantra 1.6	[G4GR]	11.95-09.00-11.95-09.00	JA8791R JA9941R	14 75 14 90		11.95-09.00-AT 11.95-09.00	JS923 JS922	12 1.2 12 1.2
Lantra 1.6 16V	[G4G1]	11.95-09.00-11.95-09.00	JA8791R JA9941R	14 75 14 90		AT 11.95-09.00-11.95-09.00	JS922 JS923	12 1.2 12 1.2
Lantra 1.6 i 16V	[G4CR]	10.90-11.95-10.90-11.95	JA6711R JA6841R	14 75 14 90		AT 11.91-04.95-AT 10.90-04.95	JS1004 JS628	12 1.2 12 1.2
Lantra 1.8 16V	[G4GM]	11.95-09.00-11.95-09.00	JA8791R JA9941R	14 75 14 90		AT 02.96-09.00-AT 11.95-09.00	JS1004 JS922	12 1.2 12 1.2
						11.95-09.00	JS923	12 1.2
Lantra 1.8 i 16V	[G4CN]	06.92-04.95-06.92-04.95	JA6711R JA6841R	14 75 14 90		AT 06.92-04.95-06.92-04.95	JS1004 JS628	12 1.2 12 1.2
Lantra 1.9 Diesel	[DJY]	03.98-09.00	CA10651R	14 95		03.98-09.00-03.98-09.00	CS594 CS1177	12 1.4 12 1.7
Lantra 2.0		04.97-05.00	JA9941R	14 90		AT 04.97-05.00-04.97-05.00	JS922 JS923	12 1.2 12 1.2
Lantra 2.0 16V	[G4GF]	08.96-09.00-08.96-09.00	JA8791R JA9941R	14 75 14 90		AT 08.96-09.00-08.96-09.00-AT 08.96-09.00	JS922 JS923 JS1004	12 1.2 12 1.2 12 1.2
Matrix 1.5 CRDi	[D3-EA]	10.01-	JA18081R	14 100		10.01-	JS1349	12 1.7
	[D4FA]					12.04-	JS1365	12 1.7
Matrix 1.5 CRDi VGT	[D4FA]	08.05-	CA19061R	14 120		08.05-	JS1365	12 1.7
Matrix 1.6	[G4ED-G]	06.01-06.01-	JA17881R JA17891R	14 80 14 90		AT 06.01-06.01-	JS1312 JS1311	12 0.9 12 0.9



HYUNDAI Continued

	[G4ED-L]	01.02- 12.05	JA1788IR	14 80		AT 01.02- 12.05	JS1312	12 0.9
		01.02- 12.05	JA1789IR	14 90		01.02- 12.05	JS1311	12 0.9
Matrix 1.8	[G4GB-G]	06.01-	JA1788IR	14 80		AT 06.01- 04.04	JS922	12 1.2
		06.01-	JA1789IR	14 90		06.01-	JS923	12 1.2
Pony 1.2		06.74- 09.85	JA150IR	14 45		06.74- 09.85	JS350	12 0.7
Pony 1.3	[G13B]	10.85- 09.89	JA150IR	14 45		10.85- 09.89	JS350	12 0.7
						10.85- 09.89	JS349	12 0.9
	[G4DG]	10.89- 01.95	JA598IR	14 60		10.89- 01.95	JS396#	12 0.7
		10.89- 01.95	JA689IR	14 75		01.90- 01.95	JS349	12 0.9
Pony 1.4		08.77- 09.85	JA150IR	14 45		08.77- 09.85	JS349	12 0.9
						08.77- 09.85	JS350	12 0.7
Pony 1.5	[G15B]	01.91- 01.95	JA598IR	14 60		A13 10.85- 01.95	JS349	12 0.9
		01.91- 01.95	JA689IR	14 75		10.85- 01.95	JS396#	12 0.7
						AT 12.91- 01.95	JS1003	12 0.9
						01.90- 01.95	JS643	12 0.9
	[G4DJ]	01.91- 01.95	JA598IR	14 60		10.85- 01.95	JS396#	12 0.7
		01.91- 01.95	JA689IR	14 75		AT 10.85- 11.91	JS349	12 0.9
						AT 11.91- 01.95	JS643	12 0.9
Pony 1.5 i	[G15B]	01.91- 01.95	JA598IR	14 60		AT 10.89- 01.95	JS349	12 0.9
		01.91- 01.95	JA689IR	14 75		AT 12.91- 01.95	JS1003	12 0.9
						AT 01.90- 01.95	JS643	12 0.9
						01.90- 01.95	JS396#	12 0.7
	[G4DJ]	01.91- 01.95	JA598IR	14 60		10.89- 01.95	JS396#	12 0.7
		01.91- 01.95	JA689IR	14 75		AT 11.91- 01.95	JS643	12 0.9
						AT 10.89- 11.91	JS349	12 0.9
Porter 2.4	[G4CS]	03.96- 04.04	JA870IR	14 90	▲	03.96- 04.04	JS628	12 1.2
		03.96- 04.04	JA888IR#	14 75				
Porter 2.5 CRDi		02.03- 04.04	JA1804IR	14 110		02.03- 04.04	JS1355	12 2.2
Porter 2.5 TD	[D4BA]	07.94- 04.04	JA1518IR	14 110		07.94- 04.04	JS1351	12 2.0
		07.94- 04.04	JA1711IR	14 75		07.94- 04.04	JS344	12 2.0
						AT 07.94- 04.04	JS769	12 2.2
	[D4BH]	07.94- 04.04	JA1518IR	14 110		AT 07.94- 04.04	JS769	12 2.2
		07.94- 04.04	JA1711IR	14 75		07.94- 04.04	JS344	12 2.0
						07.94- 04.04	JS1351	12 2.0
Santa Fe 2.0	[G4BP]	08.01- 09.02	JA1718IR	14 95		AT 08.01-	JS1313	12 1.2
		09.02-	JA1807IR	14 110		08.01-	JS1304	12 1.2
Santa Fe 2.0 CRDi	[D4EA]	08.01-	JA1708IR	14 120		08.01-	JS1234	12 2.0
Santa Fe 2.0 CRDi 4WD	[D4EA]	04.01-	JA1708IR	14 120		04.01-	JS1234	12 2.0
	[D4EA-V]	08.03-	JA1708IR	14 120		08.03-	JS1234	12 2.0
Santa Fe 2.0 CRDi 4x4		11.03- 02.06	JA1708IR	14 120		11.03- 02.06	JS1234	12 2.0
Santa Fe 2.2 CRDi	[D4EB]	03.06-	JA1708IR	14 120		03.06-	JS1234	12 2.0
		10.05-	JA1708IR	14 120		10.05-	JS1234	12 2.0
Santa Fe 2.2 CRDi 4WD	[D4EB]	10.05-	JA1708IR	14 120		10.05-	JS1234	12 2.0
Santa Fe 2.2 CRDi 4WD GLS	[D4EB]	03.06-	JA1708IR	14 120		03.06-	JS1234	12 2.0
Santa Fe 2.2 CRDi 4x4	[D4EB]	03.06-	JA1708IR	14 120		03.06-	JS1234	12 2.0
Santa Fe 2.2 CRDi GLS	[D4EB]	03.06-	JA1708IR	14 120		03.06-	JS1234	12 2.0
Santa Fe 2.4 16V	[G4JS-G]	02.00- 09.02	JA1718IR	14 95		02.00-	JS1304	12 1.2
		09.02-	JA1807IR	14 110		AT 02.00-	JS1313	12 1.2
Santa Fe 2.4 16V 4WD	[G4JS-G]	02.00- 09.02	JA1718IR	14 95		02.00-	JS1304	12 1.2
		09.02-	JA1807IR	14 110		AT 02.01-	JS1313	12 1.2
Santa Fe 2.7 V6 4WD	[G6BA-G]	08.00- 02.02	CA2088IR*	14 95		02.01-	CS1492*	12 1.2
		09.04-	JA1903IR	14 120				
Santa Fe 2.7 V6 4x4	[G6EA]	11.00- 03.06	CA2088IR*	14 95				
Santamo 2.0	[G4CP]	10.98- 10.02	JA671IR	14 75		10.98- 10.02	JS628	12 1.2
		10.98- 10.02	JA684IR	14 90		AT 10.98- 10.02	JS1004	12 1.2
						10.98- 10.02	JS349	12 0.9
Santamo 2.0 16V		05.99- 12.00	JA671IR	14 75		05.99- 12.02	JS628	12 1.2
		05.99- 12.02	JA684IR	14 90		05.99- 12.02	JS349	12 0.9
Santamo 2.0 16V 4WD		05.99- 12.02	JA671IR	14 75		05.99- 12.02	JS349	12 0.9
		05.99- 12.02	JA684IR	14 90		05.99- 12.02	JS628	12 1.2
Satellite 2.4 i	[G4CS]	10.97-	JA870IR	14 90		10.97-	JS628	12 1.2
Satellite 2.5 TD	[4D56TC]	10.97-	JA1518IR	14 110				
Scoupe 1.5 i Turbo	[G4EK-TC]	04.91- 05.95	JA879IR	14 75		04.91- 05.95	JS349	12 0.9
Scoupe 1.5 i	[G15B]	02.90-	JA598IR	14 60		AT 11.91- 06.92	JS1003	12 0.9
		02.90-	JA689IR	14 75		AT 02.90- 06.92	JS349	12 0.9
	[G4DJ]	02.90- 05.96	JA598IR	14 60		PS 02.90- 05.96	JS349	12 0.9
		02.90- 05.96	JA689IR	14 75		AT 11.91- 05.96	JS643	12 0.9
						02.90- 05.96	JS396#	12 0.7
	[G4EK]	04.92- 05.96	JA1126IR	14 75		04.92- 05.96	JS349	12 0.9
						AT 04.92- 05.96	JS643	12 0.9
						04.92- 05.96	JS396#	12 0.7
Solaris 1.4	[G4FA]					11.10-	CS1465	12 0.9
Solaris 1.6	[G4FC]					11.10-	CS1465	12 0.9
Sonata 1.8 i	[4G62]					AT 09.88- 10.93	JS1004	12 1.2
						08.88- 05.89	JS350	12 0.7
						05.89- 10.93	JS628	12 1.2
	[G4CM]	05.93- 06.98	JA671IR	14 75		AT 05.93- 06.98	JS1004	12 1.2
		05.93- 06.98	JA684IR	14 90		05.93- 06.98	JS628	12 1.2
Sonata 2.0	[G4JP-EG]	04.01- 11.04	JA1807IR	14 110		AT 04.01- 11.04	JS1313	12 1.2
						04.01- 11.04	JS1304	12 1.2
Sonata 2.0 16V	[G4JP-G]	06.98- 10.01	JA1522IR	14 100		06.98- 10.01	JS1304	12 1.2
						AT 06.98- 10.01	JS1313	12 1.2
Sonata 2.0 i 16V	[G4CP-D]	01.91- 06.98	JA684IR	14 90		AT 01.91- 06.98	JS1004	12 1.2
						01.91- 06.98	JS628	12 1.2
	[G4CP-DM]	06.96- 06.98	JA664IR	14 65		06.96- 06.98	JS628	12 1.2
		06.96- 06.98	JA671IR	14 75		AT 06.96- 06.98	JS1004	12 1.2
		06.96- 06.98	JA684IR	14 90				
Sonata 2.0 i	[G4CP]	06.94- 06.98	JA671IR	14 75		05.89- 06.98	JS628	12 1.2
		06.94- 06.98	JA684IR	14 90		AT 05.89- 06.98	JS1004	12 1.2
						09.88- 05.89	JS350	12 0.7
	[G4CP-U]					AT 01.91- 10.93	JS1004	12 1.2
						01.91- 10.93	JS350	12 0.7
						01.91- 10.93	JS628	12 1.2
Sonata 2.0 CRDi	[D4EA]	02.06-	JA1708IR	14 120		02.06-	JS1234	12 2.0
		03.09-	CA2018IR	14 120				
Sonata 2.4 16V	[G4CS]	03.98-	JA1807IR	14 110		03.98- 10.01	JS1304	12 1.2
						AT 03.98-	JS1313	12 1.2
Sonata 2.4 i	[G4CS]					09.88- 08.91	JS1004	12 1.2
Sonata 2.5 V6 24V	[G6BV-G]	06.98- 10.01	CA2088IR*	14 95				
Sonata 2.5 V6	[G6AV]	08.98- 09.01	CA2088IR*	14 95		AT 08.98- 09.01	CS1492*	12 1.2
Sonata 2.7 i V6	[G6BA]	10.01- 05.05	CA2088IR*	14 95		10.01- 05.05	CS1492*	12 1.2
Sonata 2.7 V6	[G6BA]	09.04- 11.04	JA1903IR	14 120		11.02- 07.04	JS923	12 1.2
						11.02-	CS1492*	12 1.2



	[G6BA-G]	04.01- 07.02 10.04- 11.04	CA2088IR* JA1903IR	14 95 14 120		04.01- 11.04	CS1492*	12 1.2
Sonata 3.0 i V6	[G6AT]	05.93- 06.98	JA995IR	14 110		01.91- 10.93	JS658	12 1.2
Starex 2.4	[G4CS]	06.97-	JA870IR	14 90		06.97-	JS628	12 1.2
Starex 2.4 4WD	[G4CS]	02.98-	JA870IR	14 90		02.98-	JS628	12 1.2
Starex 2.5 TD	[D4BF]	06.97- 06.97- AC 06.97-	JA1419IR JA1711IR JA1518IR	14 90 14 75 14 110		06.97- A13 06.97-	JS344 JS769	12 2.0 12 2.2
Starex 2.5 TD 4WD	[D4BF]	02.98- 02.98- AC 02.98-	JA1419IR JA1711IR JA1518IR	14 90 14 75 14 110		A13 02.98- 02.98-	JS769 JS344	12 2.2 12 2.0
Stellar 1.4	[G333]	10.83- 08.86	JA150IR	14 45				
Stellar 1.6	[G32B]	10.83- 12.91 10.86- 12.91	JA150IR JA159IR#	14 45 14 65				
Terracan 2.5 TD	[D4BH]					AT 01.01- 12.03 01.01- 12.03	JS769 JS892	12 2.2 12 2.2
Terracan 2.9 CRDi	[J3]	11.01- 10.06	JA1709IR	14 110		11.01- 10.06	CS1446	12 2.2
Terracan 3.5 iV6 4WD	[G6CU]					07.01- 10.06	JS658	12 1.2
Tiburon 2.0 CVVT		10.06-	JA1789IR	14 90		AT 10.06- 10.06-	JS1370 CS1433	12 1.2 12 1.2
Trajjet 2.0	[G4GC-G] [G4JP-G]	01.00- 01.00- 01.00- 09.02 09.02-	JA1718IR JA1807IR JA1718IR JA1807IR	14 95 14 110 14 95 14 110		03.04- AT 01.00- 02.04 AT 01.00- 02.04 01.00- 02.04	JS1304 JS1313 JS1313 JS1304	12 1.2 12 1.2 12 1.2 12 1.2
Trajjet 2.0 CRDi	[D4EA]	04.01-	JA1708IR	14 120		04.01-	JS1234	12 2.0
Trajjet 2.7 V6	[G6BA-G]	09.04-	JA1903IR	14 120		01.00-	CS1492*	12 1.2
Tucson 2.0	[G4GC]	08.04-	JA1789IR	14 90		04.04-	JS923	12 1.2
Tucson 2.0 4WD	[G4GC]	08.04-	JA1789IR	14 90		04.04-	JS923	12 1.2
Tucson 2.0 CRDi	[D4EA] [D4EA-V]	04.04- 01.06- 01.06-	JA1708IR JA1708IR JA1708IR	14 120 14 120 14 120		04.04- 02.08 01.06- 02.08 01.06- 02.08	JS1234 JS1234 JS1234	12 2.0 12 2.0 12 2.0
Tucson 2.0 CRDi 4WD	[D4EA]	04.04-	JA1708IR	14 120		04.04-	JS1234	12 2.0
Tucson 2.0 CRDi 4x4	[D4EA]	01.07- 01.06-	JA1708IR JA1708IR	14 120 14 120		01.09- 01.06- 02.08	JS1234 JS1234	12 2.0 12 2.0
Tucson 2.7 4WD	[G6BA-G]	04.04-	JA1903IR	14 120		04.04-	CS1492*	12 1.2
XG 2.5 V6	[G6BV]	12.98-	CA2088IR*	14 95		AT 04.99-	CS1492*	12 1.2
XG 3.0 V6	[G6CT-G]					04.99-	CS1492*	12 1.2
XG 3.5 350	[G6CU]					AT 04.03-	CS1492*	12 1.2
<b>PASSENGER CARS US</b>								
Accent 1.5	[G4EK]	01.98- 01.02 01.98- 01.01 01.95- 01.96	JA879IR JA994IR JA879IR	14 75 14 90 14 75		01.98- 01.01 01.98- 01.01 01.95- 01.96	JS350 JS643 JS350	12 0.7 12 0.9 12 0.7
Accent 1.5 GL		01.95- 01.97 01.97- 01.97	JA879IR JA994IR	14 75 14 90		01.95- 01.97 01.95- 01.97	JS643 JS350	12 0.9 12 0.7
Accent 1.5 GS		01.97- 01.97	JA994IR	14 90		01.97- 01.97	JS643	12 0.9
Accent 1.5 GT		01.97- 01.97	JA879IR	14 75		01.97- 01.97	JS350	12 0.7
Accent 1.5 GT		01.96- 01.97	JA879IR	14 75		01.96- 01.97	JS643	12 0.9
Accent 1.5 L		01.95- 01.97	JA879IR	14 75		01.95- 01.97 01.95- 01.97	JS350 JS643	12 0.7 12 0.9
Accent 1.6		01.01- 01.02	JA879IR	14 75		01.01- 01.01	JS643	12 0.9
Elantra 1.6		01.92- 01.95	JA671IR	14 75		01.92- 01.95	JS628	12 1.2
Elantra 1.6 GL		01.92- 01.95	JA671IR	14 75		01.92- 01.95	JS628	12 1.2
Elantra 1.6 GLS		01.92- 01.94	JA671IR	14 75		01.92- 01.94	JS628	12 1.2
Elantra 1.8	[G4CN]	01.98- 01.98	JA994IR	14 90		AT 01.98- 01.98 01.98- 01.98	JS922 JS923	12 1.2 12 1.2
		01.96- 01.97 01.93- 01.95	JA994IR JA671IR	14 90 14 75		01.93- 01.95 01.96- 01.97	JS628 JS923	12 1.2 12 1.2
						AT 01.96- 01.97	JS922	12 1.2
Elantra 1.8 GL		01.93- 01.95	JA671IR	14 75		01.93- 01.95	JS628	12 1.2
Elantra 1.8 GLS		01.93- 01.95 01.96- 01.97	JA671IR JA994IR	14 75 14 90		01.96- 01.97 AT 01.96- 01.97	JS923 JS922	12 1.2 12 1.2
						01.93- 01.95	JS628	12 1.2
Elantra 2.0	[G4CP]	01.99- 01.01	JA994IR	14 90		AT 01.99- 01.01 01.99- 01.01	JS922 JS923	12 1.2 12 1.2
Elantra 2.0 GLS	[G4CP]	01.02- 01.02 01.03- 01.03	JA879IR JA1789IR	14 75 14 90		01.02- 01.03 AT 01.02- 01.03	JS923 JS922	12 1.2 12 1.2
Elantra 2.0 GT	[G4CP]	01.02- 01.03- 01.03	JA879IR JA1789IR	14 75 14 90		AT 01.02- 01.03 01.02- 01.03	JS922 JS923	12 1.2 12 1.2
Excel 1.5		01.91- 07.94 01.91- 01.94	JA879IR JA689IR	14 75 14 75		AT 01.91- 01.94 01.91- 01.94	JS349 JS350	12 0.9 12 0.7
Excel 1.5 CX		01.93- 07.94	JA879IR	14 75		01.93- 01.94	JS643	12 0.9
						01.93- 01.94	JS350	12 0.7
Excel 1.5 CXL		01.92- 07.94 01.92- 01.94	JA879IR JA689IR	14 75 14 75		PS 01.92- 01.94 01.92- 01.94	JS349 JS643	12 0.9 12 0.9
						01.92- 01.94	JS350	12 0.7
Excel 1.5 GL		01.90- 07.94 01.90- 01.94 01.86- 01.89	JA879IR JA689IR JA150IR	14 75 14 75 14 45		01.86- 01.94 PS 01.90- 01.94	JS350 JS349	12 0.7 12 0.9
Excel 1.5 GLS		01.90- 01.91 01.90- 01.91 01.86- 01.89	JA879IR JA689IR JA150IR	14 75 14 75 14 45		01.86- 01.91 AT 01.90- 01.91	JS350 JS349	12 0.7 12 0.9
Excel 1.5 GS		01.92- 01.94 01.92- 07.94	JA689IR JA879IR	14 75 14 75		AT 01.92- 01.94 01.92- 01.94	JS349 JS350	12 0.9 12 0.7
						01.92- 01.94	JS643	12 0.9
Excel 1.5 L		01.86- 01.90 01.91- 01.92 01.91- 01.92	JA150IR JA689IR JA879IR	14 45 14 75 14 75		AT 01.91- 01.92 01.86- 01.92	JS349 JS350	12 0.9 12 0.7
Scoupe 1.5		01.91- 01.92 01.93- 01.95	JA689IR JA879IR	14 75 14 75		01.91- 01.95	JS350	12 0.7
Scoupe 1.5 LS		01.91- 01.92 01.93- 01.95	JA689IR JA879IR	14 75 14 75		01.91- 01.95	JS350	12 0.7
Scoupe 1.5 Turbo		01.93- 01.95	JA879IR	14 75		01.93- 01.95	JS350	12 0.7
Sonata 2.0	[G4CP]	01.98- 01.98 01.98- 01.98 01.92- 01.97 01.92- 01.97	JA671IR JA684IR JA671IR JA684IR	14 75 14 90 14 75 14 90		01.98- 01.98 01.92- 01.97	JS628 JS628	12 1.2 12 1.2
Sonata 2.0 GL		01.92- 01.97	JA671IR	14 75		01.92- 01.97	JS628	12 1.2
Sonata 2.0 GLS		01.92- 01.94 01.92- 01.94	JA684IR JA671IR	14 90 14 75		01.92- 01.94	JS628	12 1.2



## HYUNDAI Continued

Sonata 2.4		01.99- 01.03 JA1522IR	14	100	01.99- 01.03 JS1304	12	1.2
		01.89- 01.91 JA689IR	14	75	01.89- 01.91 JS628	12	1.2
Sonata 2.4 Deluxe		01.89- 01.89 JA689IR	14	75	01.89- 01.89 JS628	12	1.2
Sonata 2.4 GL		01.89- 01.91 JA689IR	14	75	01.89- 01.91 JS628	12	1.2
Sonata 2.4 GLS		01.89- 01.91 JA689IR	14	75	01.89- 01.91 JS628	12	1.2
Sonata 2.4 Sport Deluxe		01.89- 01.89 JA689IR	14	75	01.89- 01.89 JS628	12	1.2
Sonata 3.0	[G6AT]	01.98- 01.98 JA995IR	14	110			
					01.90- 01.94 JS658	12	1.2
Sonata 3.0 GL							
		01.95- 01.97 JA995IR	14	110	01.90- 01.94 JS658	12	1.2
Sonata 3.0 GLS		01.95- 01.97 JA995IR	14	110	01.90- 01.94 JS658	12	1.2
Tiburon 1.8					01.97- 01.97 JS923	12	1.2
					AT 01.97- 01.97 JS922	12	1.2
Tiburon 2.0	[G4CP]	01.98- 01.01 JA994IR	14	90	AT 01.98- 01.01 JS922	12	1.2
					01.98- 01.01 JS923	12	1.2
Tiburon 2.0 FX	[G4CP]	01.98- 01.98 JA994IR	14	90	AT 01.98- 01.98 JS922	12	1.2
					01.98- 01.98 JS923	12	1.2
		01.97- 01.97 JA994IR	14	90	AT 01.97- 01.97 JS922	12	1.2
					01.97- 01.97 JS923	12	1.2
<b>PASSENGER CARS AO</b>							
Accent 1.3		09.95- 05.98 JA879IR	14	75	09.95- 05.98 JS396#	12	0.7
		09.95- 05.98 JA994IR	14	90	AT 09.95- 05.98 JS643	12	0.9
					A13 09.95- 05.98 JS349	12	0.9
Atos 0.8		04.99- 07.03 JA1715IR	14	60	04.99- 07.03 JS1303	12	0.8
		04.99- 07.03 JA1798IR	14	70			
Atos 1.1	[G4HD]	08.03- 05.05 JA1715IR	14	60	08.03- 05.05 JS1303	12	0.8
		08.03- 05.05 JA1798IR	14	70			
Elantra 1.8		06.00- 07.03 JA1789IR	14	90	06.00- 07.03 JS923	12	1.2
		06.00- 07.03 JA1788IR	14	80	AT 06.00- 07.03 JS922	12	1.2
Getz 1.5 CRDi GLS	[D4FA]	07.04- 03.05 JA1808IR	14	100	07.04- 08.05 JS1349	12	1.7
H-1 2.5 Diesel	[D4BH]	06.00- 10.05 JA1711IR	14	75	06.00- 10.05 JS769	12	2.2
					06.00- 10.05 JS1351	12	2.0 A37
					06.00- 10.05 JS770	12	2.0 A36
					06.00- 10.05 JS892	12	2.2
H100 2.6 Diesel		AC 06.00- 10.05 JA1518IR	14	110	10.99- JS344	12	2.0
		w/ABS 10.99- JA1716IR	14	75	10.99- JS769	12	2.2
		w/o ABS 10.99- JA1618IR	14	65	10.99- JS769	12	2.2
Sonata 1.8 GLS	[G4DM]	07.96- 05.98 JA6711IR	14	75	AT 07.96- 05.98 JS1004	12	1.2
		07.96- 05.98 JA684IR	14	90	07.96- 05.98 JS628	12	1.2
Starex 2.5 CRDi					12.02- JS1355	12	2.2
Starex 2.5 TCI	[D4BH]	10.97- 04.04 JA1518IR	14	110	10.97- 04.04 JS344	12	2.0
		10.97- 04.04 JA1711IR	14	75	10.97- 04.04 JS769	12	2.2
Starex 2.6 TD					10.97- 04.04 JS769	12	2.2
					10.97- 04.04 JS344	12	2.0
Terracan 2.5 Diesel	[D4BH]				A13 06.01- 10.03 JS892	12	2.2
					AT 06.01- 10.03 JS769	12	2.2
					06.01- 10.03 JS770	12	2.0
					AT 06.01- 10.03 JS769	12	2.2
					06.01- 10.03 JS770	12	2.0
					A13 06.01- 10.03 JS892	12	2.2
Trajet 2.0		11.03- JA1807IR	14	110	11.03- JS1304	12	1.2
Trajet 2.0		08.05- JA1708IR	14	120	08.05- CS1492*	12	1.2
<b>Infiniti</b>							
<b>PASSENGER CARS US</b>							
G20 2.0	[SR20DE]				01.99- 01.02 JS1137	12	1.4
					01.91- 01.99 JS627	12	1.4
I30 3.0	[VQ30DE]	01.98- 01.99 JA990IR	14	110	01.96- 01.01 JS924	12	1.4
<b>Innocenti</b>							
<b>PASSENGER CARS EU</b>							
Elba 1.3	[146A5.000]	08.91- 09.93 CA909IR	14	45	08.91- 09.93 CS396	12	0.8
Elba 1.4 i.e.	[146C.5000]	09.94- 12.96 CA596IR	14	65	09.94- 12.96 CS285	12	0.8
	[146D.5000]	09.94- 12.96 CA596IR	14	65	09.94- 12.96 CS285	12	0.8
Elba 1.5 i.e.	[149C1.000]	03.92- 08.93 CA252IR	14	55	08.92- 09.94 CS285	12	0.8
Elba 1.6 i.e.	[146C6.000]	09.94- 12.96 CA596IR	14	65	09.94- 12.96 CS285	12	0.8
	[146D6.000]	09.94- 12.96 CA596IR	14	65	09.94- 12.96 CS285	12	0.8
Elba 1.7 Diesel	[146.B2.000]	08.91- 12.96 CA1435IR	14	55	08.91- 12.96 CS1059	12	1.7
<b>International</b>							
<b>PASSENGER CARS US</b>							
100 4.2		01.74- 01.74 UA943IR	14	60			
100 5.0		01.74- 01.74 UA943IR	14	60			
100 5.6		01.74- 01.74 UA943IR	14	60			
150 5.0		01.75- 01.75 UA943IR	14	60			
150 5.6		01.75- 01.75 UA943IR	14	60			
200 4.2		01.74- 01.74 UA943IR	14	60			
200 5.0		01.74- 01.75 UA943IR	14	60			
200 5.6		01.74- 01.75 UA943IR	14	60			
1000 3.8 B		01.69- 01.69 UA916#	14	60			
1000 3.8 C		01.69- 01.69 UA916#	14	60			
1000 3.8 D		01.69- 01.70 UA916#	14	60			
1000 3.9 C		01.69- 01.69 UA916#	14	60			
1000 3.9 D		01.69- 01.70 UA916#	14	60			
1000 4.4 B		01.68- 01.69 UA916#	14	60			
1000 4.4 C		01.68- 01.69 UA916#	14	60			
1000 4.4 D		01.69- 01.70 UA916#	14	60			
1000 5.0 B		01.69- 01.69 UA916#	14	60			
1000 5.0 C		01.69- 01.69 UA916#	14	60			
1000 5.0 D		01.69- 01.70 UA916#	14	60			
1010 3.8		01.71- 01.71 UA943IR	14	60			
1010 4.2		01.72- 01.73 UA943IR	14	60			
1010 5.0		01.72- 01.73 UA943IR	14	60			
1010 5.7		01.71- 01.73 UA943IR	14	60			
1100 3.8 B		01.69- 01.69 UA916#	14	60			
1100 3.8 C		01.69- 01.69 UA916#	14	60			
1100 3.8 D		01.69- 01.70 UA916#	14	60			
1100 3.9 D		01.69- 01.70 UA916#	14	60			
1100 4.4 B		01.68- 01.69 UA916#	14	60			
1100 4.4 C		01.68- 01.69 UA916#	14	60			
1100 4.4 D		01.69- 01.70 UA916#	14	60			
1100 5.0 B		01.69- 01.69 UA916#	14	60			
1100 5.0 C		01.69- 01.69 UA916#	14	60			
1100 5.0 D		01.69- 01.70 UA916#	14	60			
1110 3.8		01.71- 01.71 UA943IR	14	60			
1110 4.2		01.72- 01.73 UA943IR	14	60			
1110 5.0		01.72- 01.73 UA943IR	14	60			



1110 5.7	01.71- 01.73	UA943IR	14 60		
1200 3.9 D	01.69- 01.70	UA916#	14 60		
1200 4.4 B	01.68- 01.69	UA916#	14 60		
1200 4.4 C	01.68- 01.69	UA916#	14 60		
1200 4.4 D	01.69- 01.70	UA916#	14 60		
1200 5.0 B	01.69- 01.69	UA916#	14 60		
1200 5.0 C	01.69- 01.69	UA916#	14 60		
1200 5.0 D	01.69- 01.70	UA916#	14 60		
1210 3.8	01.71- 01.71	UA943IR	14 60		
1210 4.2	01.72- 01.73	UA943IR	14 60		
1210 5.0	01.72- 01.73	UA943IR	14 60		
1210 5.7	01.71- 01.73	UA943IR	14 60		
1300 3.9 D	01.69- 01.70	UA916#	14 60		
1300 4.4 B	01.68- 01.69	UA916#	14 60		
1300 4.4 C	01.68- 01.69	UA916#	14 60		
1300 4.4 D	01.69- 01.70	UA916#	14 60		
1300 5.0 B	01.69- 01.69	UA916#	14 60		
1300 5.0 C	01.69- 01.69	UA916#	14 60		
1300 5.0 D	01.69- 01.70	UA916#	14 60		
1310 3.8	01.71- 01.71	UA943IR	14 60		
1310 4.2	01.72- 01.73	UA943IR	14 60		
1310 5.0	01.72- 01.73	UA943IR	14 60		
1310 5.0	01.71- 01.72	UA943IR	14 60		
1310 5.7	01.71- 01.73	UA943IR	14 60		
908B 4.4	01.68- 01.68	UA916#	14 60		
908B 5.0	01.69- 01.69	UA916#	14 60		
908C 4.4	01.68- 01.68	UA916#	14 60		
908C 5.0	01.69- 01.69	UA916#	14 60		
DM10 4.2	01.72- 01.72	UA943IR	14 60		
DM10 5.0	01.72- 01.72	UA943IR	14 60		
M Series 2.5	01.61- 01.67	UA916#	14 60		
M Series 3.6	01.63- 01.65	UA916#	14 60		
M1100 2.5	01.68- 01.71	UA916#	14 60		
M1100 3.2	01.71- 01.71	UA943IR	14 60		
M1100 3.8	01.69- 01.70	UA916#	14 60		
M1100 4.2	01.72- 01.72	UA943IR	14 60		
M1100 5.0	01.69- 01.72	UA916#	14 60		
M1200 3.8	01.71- 01.71	UA943IR	14 60		
	01.69- 01.70	UA916#	14 60		
M1200 4.2	01.72- 01.72	UA943IR	14 60		
M1200 4.4	01.68- 01.68	UA916#	14 60		
M1200 5.0	01.69- 01.72	UA916#	14 60		
M1400 3.8	01.69- 01.69	UA916#	14 60		
M1400 5.0	01.69- 01.69	UA916#	14 60		
M800 2.5	01.68- 01.71	UA916#	14 60		
M800 2.5 Post office	01.71- 01.71	UA943IR	14 60		
M800 3.8	01.69- 01.70	UA916#	14 60		
M800 3.8 Navy	01.69- 01.69	UA916#	14 60		
M800 3.8 Post office	01.69- 01.70	UA916#	14 60		
M800 4.2 Post office	01.72- 01.72	UA943IR	14 60		
M800 5.0	01.69- 01.71	UA916#	14 60		
M800 5.0 Navy	01.69- 01.69	UA916#	14 60		
M800 5.0 Post office	01.69- 01.72	UA916#	14 60		
MA1200 3.8	01.71- 01.71	UA943IR	14 60		
	01.69- 01.70	UA916#	14 60		
MA1200 4.4	01.68- 01.68	UA916#	14 60		
MA1200 5.0	01.69- 01.71	UA916#	14 60		
MHC1310 4.2	01.74- 01.75	UA943IR	14 60		
MHC1310 5.0	01.74- 01.75	UA943IR	14 60		
MHC1310 5.0	01.74- 01.75	UA943IR	14 60		
MS1210 4.2	01.72- 01.75	UA943IR	14 60		
MS1210 5.0	01.72- 01.74	UA943IR	14 60		
MS1210 5.6	01.75- 01.75	UA943IR	14 60		
Scout 2.5	01.61- 01.71	UA916#	14 60		
Scout 3.2	01.71- 01.80	UA943IR	14 60		
	01.68- 01.68	UA916#	14 60		
Scout 3.2	01.76- 01.79	UA943IR	14 60		
Scout 3.8	01.71- 01.71	UA943IR	14 60		
Scout 4.3	01.69- 01.70	UA916#	14 60		
Scout 4.4	01.68- 01.68	UA916#	14 60		
Scout 5.0	01.71- 01.80	UA943IR	14 60		
	01.69- 01.70	UA916#	14 60		
Scout 5.0 SS2	01.78- 01.79	UA943IR	14 60		
Scout 5.0 Terra	01.76- 01.80	UA943IR	14 60		
Scout 5.6	01.71- 01.80	UA943IR	14 60		
Scout 5.6 SS2	01.78- 01.79	UA943IR	14 60		
Scout 5.6 Terra	01.76- 01.80	UA943IR	14 60		
Scout 5.7	01.72- 01.74	UA943IR	14 60		
<b>Iseki</b>					
<b>AGRICULTURE</b>					
530		JA551IR	14 40		
2140				JS895	12 1.2
4451				JS552	12 2.0
Various Models				JS895	12 1.2
<b>ISUZU</b>					
<b>PASSENGER CARS EU</b>					
Campo 2.2 Diesel	[C223]			04.86- 12.90	JS552 12 2.0
Campo 2.2 Diesel 4WD	[C223]			04.86- 12.90	JS552 12 2.0
Campo 2.5 Diesel 4WD	[4JA1]	08.89- 12.90	JA761IR	14 50	
Midi 2.0	[4ZC1]	06.88- 12.96	JA697IR#	14 55	
Midi 2.0 4WD	[4ZC1]	09.88- 12.96	JA697IR#	14 55	
Midi 2.0 TD	[4FC1T]	01.89- 12.93	JA680IR#	14 50	
Midi 2.2 Diesel	[4FD1]	01.89- 12.96	JA680IR#	14 50	
Midi 2.2 Diesel 4WD	[4FD1]	09.88- 12.96	JA680IR#	14 50	
Midi 2.4 Diesel	[4FG1T]	01.94- 12.99	JA680IR#	14 50	
Midi 2.4 TD	[4FG1T]	01.94- 12.99	JA680IR#	14 50	
NKR 2.8 Diesel	[4JB1]			01.85- 12.96	JS552 12 2.0
Rodeo 3.1 TD	[C4JG2]	10.93- 12.97	JA873IR	14 60	
Trooper 2.2 4WD	[C223]			05.84- 10.88	JS552 12 2.0
Trooper 2.2 Diesel	[C223T]			01.83- 12.83	JS552 12 2.0
Trooper 2.2 Diesel 4WD	[C223]			05.84- 10.88	JS552 12 2.0
Trooper 2.2 TD	[C223T]			03.84- 10.88	JS552 12 2.0
Trooper 2.3	[4ZD1]	01.87- 10.88	JA697IR#	14 55	
Trooper 2.6 i	[4ZE1]	10.87- 12.91	JA697IR#	14 55	



**ISUZU Continued**

Trooper 2.8 TD	[4JB1T]	10.87- 12.91	JA7611R	14 50		10.87- 12.91	JS639	12 2.0
	[4JB1-TC]	10.88- 12.91	JA7611R	14 50		10.88- 12.91	JS639	12 2.0
Trooper 3.1 TD		08.91- 07.98	JA1290IR	14 80		08.91- 07.98	JS999	12 2.8
		08.91- 07.98	JA8731R	14 60				
<b>PASSENGER CARS US</b>								
Amigo 2.2	[X22SE]	01.99- 01.00	CA10531R	14 100		01.99- 01.00	CS879	12 1.1
		01.98- 01.98	CA10531R	14 100		01.98- 01.98	CS879	12 1.1
I-Mark 1.6		01.89- 01.89	JA6971R#	14 55				
I-Mark 1.8		01.81- 01.84	JA144	14 45				
I-Mark 1.8 DLX		01.84- 01.85	JA144	14 45				
I-Mark 1.8		01.81- 01.84	JA144	14 45				
I-Mark 1.8 DLX		01.84- 01.84	JA144	14 45				
Pick Up 2.2						01.81- 01.87	JS552	12 2.0
Pick Up 2.2 Normal cab						01.87- 01.87	JS552	12 2.0
Pick Up 2.2 Turbo						01.86- 01.87	JS552	12 2.0
Rodeo 2.2	[X22SE]	01.98- 01.01	CA10531R	14 100		01.98- 01.00	CS879	12 1.1
Rodeo 2.2 Sport	[X22SE]	01.01- 01.01	CA10531R	14 100				
Rodeo 3.1						01.91- 01.92	US858	12
Trooper 2.2 Turbo						01.86- 01.87	JS552	12 2.0
<b>TRUCKS EU</b>								
NKR 3.3 Diesel	[4BC2]							
NPR 3.3 Diesel	[4BC2]							
WFR12 2.0	[4CZ1]	02.86- 12.96	JA6971R#	14 55				
WFR53 2.2 Diesel	[4FD1]	11.86- 12.93	JA6801R#	14 50				
WFS12 2.0	[4ZC1]	02.86- 12.96	JA6971R#	14 55				
WFS53 2.2 Diesel	[4FD1]	01.86- 12.96	JA6801R#	14 50				
<b>Iveco</b>								
<b>PASSENGER CARS EU</b>								
29 L 10 2.3 Diesel	[F1AE0481A]	09.02- 09.02	CA17001R	14 110		09.02-	CS1203	12 2.3
	[F1AE0481FA]	05.06- 05.06	CA17001R	14 110		05.06-	CS1203	12 2.3
		05.06- 06.06	CA18371R	14 140				
			CA20901R*	14 180				
29 L 11 2.8 Diesel	[8140.43B]	05.99- 09.02	CA15571R	14 90		05.99- 09.02	CS1203	12 2.3
		05.99- 09.02	CA16791R	14 120				
	[8140.43C]	05.99- 09.02	CA15571R	14 90		05.99-	CS1203	12 2.3
		05.99- 09.02	CA16791R	14 120				
29 L 12 2.3 Diesel	[F1AE0481B]	09.02- 09.02	CA17001R	14 110		09.02-	CS1203	12 2.3
	[F1AE0481GA]	05.06- 05.06	CA17001R	14 110		05.06-	CS1203	12 2.3
		05.06- 05.06	CA18371R	14 140				
			CA20901R*	14 180				
29 L 13 2.8 Diesel	[8140.43S]	05.01- 09.04	CA15571R	14 90		05.01- 09.04	CS1203	12 2.3
		05.01- 09.04	CA16791R	14 120				
29 L 14 2.3 Diesel	[F1AE0481HA]	05.06- 05.06	CA17001R	14 110		05.06-	CS1203	12 2.3
		05.06- 05.06	CA18371R	14 140				
		05.06-	CA20901R*	14 180				
	[F1AE0481M]	09.04- 04.06	CA17001R	14 110		09.04- 04.06	CS1203	12 2.3
		09.04- 04.06	CA18371R	14 140				
29 L 9 2.8 Diesel	[8140.43R]	11.01- 04.06	CA15571R	14 90		11.01- 04.06	CS1203	12 2.3
		11.01- 04.06	CA16791R	14 120				
	[8140.63]	05.99- 05.99	CA15571R	14 90		05.99-	CS1203	12 2.3
			CA16791R	14 120				
29 L 9 V 2.8 Diesel	[8140.43R]	11.01- 04.06	CA15571R	14 90		11.01- 04.06	CS1203	12 2.3
		11.01- 04.06	CA16791R	14 120				
35 C 10 2.3 Diesel	[F1AE0481A]	09.02- 09.02	CA17001R	14 110		09.02-	CS1203	12 2.3
	[F1AE0481FA]	05.06- 05.06	CA17001R	14 110		05.06-	CS1203	12 2.3
		05.06- 05.06	CA18371R	14 140				
			CA20901R*	14 180				
35 C 11 2.3	[F1AE0481FA]	07.09- 07.09	CA17001R	14 110		07.09-	CS1203	12 2.3
		07.09-	CA18371R	14 140				
		07.09-	CA20901R*	14 180				
35 C 11 2.8 Diesel	[8140.43C]	05.99- 03.06	CA15571R	14 90		05.99- 03.06	CS1203	12 2.3
		05.99- 03.06	CA16791R	14 120				
35 C 12 2.3 Diesel	[F1AE0481B]	09.02- 09.02	CA17001R	14 110		09.02-	CS1203	12 2.3
	[F1AE0481GA]	05.06- 05.06	CA17001R	14 110		05.06-	CS1203	12 2.3
		05.06- 05.06	CA18371R	14 140				
			CA20901R*	14 180				
35 C 13 2.3	[F1AE0481GA]	07.09- 07.09	CA17001R	14 110		07.09-	CS1203	12 2.3
		07.09-	CA18371R	14 140				
		07.09-	CA20901R*	14 180				
35 C 14 3.0	[F1CCNG]	07.09- 07.09	CA19131R	14 140		07.09-	CS1203	12 2.3
			CA20891R*	14 180				
35 C 14 3.0	[F1CE3481LC]	07.09- 07.09	CA19131R	14 140				
		07.09-	CA19151R	14 110				
		07.09-	CA20891R*	14 180				
35 C 14 3.0 Diesel	[F1CE0481A]	09.04- 04.06	CA19131R	14 140		09.04- 04.06	CS1203	12 2.3
		09.04- 04.06	CA19151R	14 110				
35 C 15 2.8 Diesel	[8140.43N]	11.01- 11.01	CA15571R	14 90		11.01-	CS1203	12 2.3
			CA16791R	14 120				
35 C 15 3.0 Diesel	[F1CE0481FA]	05.06- 05.06	CA19131R	14 140		05.06-	CS1203	12 2.3
			CA19151R	14 110				
35 C 17 3.0	[F1CE0481HA]	07.09- 07.09	CA19131R	14 140		07.09-	CS1203	12 2.3
			CA19151R	14 110				
35 C 17 3.0 Diesel	[F1CE0481B]	01.05- 04.06	CA19131R	14 140		01.05- 04.06	CS1203	12 2.3
		01.05- 04.06	CA19151R	14 110				
35 C 18 3.0 Diesel	[F1CE0481HA]	05.06- 05.06	CA19131R	14 140		05.06-	CS1203	12 2.3
			CA19151R	14 110				
35 C 9 2.8 Diesel	[8140.43R]	11.01- 11.01	CA15571R	14 90		11.01- 04.06	CS1203	12 2.3
		11.01- 04.06	CA16791R	14 120				
	[8140.63]	05.99- 12.01	CA15571R	14 90		05.99- 12.01	CS1203	12 2.3
		05.99- 12.01	CA16791R	14 120				
35 S 10 2.3 Diesel	[F1AE0481A]	09.02- 09.02	CA17001R	14 110		09.02-	CS1203	12 2.3
	[F1AE0481FA]	05.06- 05.06	CA17001R	14 110		05.06-	CS1203	12 2.3
		05.06- 05.06	CA18371R	14 140				
			CA20901R*	14 180				
35 S 11 2.3	[F1AE0481FA]	07.09- 07.09	CA17001R	14 110		07.09-	CS1203	12 2.3
		07.09-	CA18371R	14 140				
		07.09-	CA20901R*	14 180				
35 S 11 2.8 Diesel	[8140.43C]	05.99- 05.99	CA15571R	14 90		05.99-	CS1203	12 2.3
			CA16791R	14 120				
35 S 12 2.3 Diesel	[F1AE0481B]	09.02- 09.02	CA17001R	14 110		09.02-	CS1203	12 2.3
	[F1AE0481GA]	05.06- 05.06	CA17001R	14 110		05.06-	CS1203	12 2.3
		05.06- 05.06	CA18371R	14 140				
			CA20901R*	14 180				



35 S 13 2.3	[F1AE0481GA]	07.09- 07.09- 07.09-	CA1700IR CA1837IR CA2090IR*	14 110 14 140 14 180	07.09-	CS1203	12 2.3
35 S 13 2.8 Diesel	[8140.43S]	05.99- 05.99-	CA1557IR CA1679IR	14 90 14 120	05.99-	CS1203	12 2.3
35 S 14 2.3	[F1AE0481HA]	07.09- 07.09- 07.09-	CA1700IR CA1837IR CA2090IR*	14 110 14 140 14 180	07.09-	CS1203	12 2.3
35 S 14 2.3 Diesel	[F1AE0481HA]	05.06- 05.06- 05.06-	CA1700IR CA1837IR CA2090IR*	14 110 14 140 14 180	05.06-	CS1203	12 2.3
35 S 14 3.0	[F1CCNG]	07.09- 07.09-	CA1913IR CA1915IR	14 140 14 110	07.09-	CS1203	12 2.3
35 S 14 3.0	[F1CE3481LC]	07.09- 07.09-	CA1913IR CA1915IR	14 140 14 110			
35 S 15 2.8 Diesel	[8140.43N]	11.01- 11.01-	CA1557IR CA1679IR	14 90 14 120	11.01-	CS1203	12 2.3
35 S 17 3.0	[F1CE0481HA]	07.09- 07.09- 07.09-	CA1913IR CA1915IR CA2089IR*	14 140 14 110 14 180	07.09-	CS1203	12 2.3
35 S 17 3.0 Diesel	[F1CE0481B]	01.05- 04.06 01.05- 04.06	CA1913IR CA1915IR	14 140 14 110	01.05- 04.06	CS1203	12 2.3
35 S 18 3.0 Diesel	[F1CE0481HA]	05.06- 05.06-	CA1913IR CA1915IR	14 140 14 110	05.06-	CS1203	12 2.3
35 S 9 2.8 Diesel	[8140.43R]	11.01- 04.06 11.01- 04.06	CA1557IR CA1679IR	14 90 14 120	11.01- 04.06	CS1203	12 2.3
	[8140.63]	05.99- 12.01 05.99- 12.01	CA1557IR CA1679IR	14 90 14 120	05.99- 12.01	CS1203	12 2.3
35-10 2.4 Diesel	[8140.21.200]	02.85- 06.89 02.85- 12.89 02.85- 06.89	CA569IR CA641IR CA642IR	14 85 14 45 14 55	02.85- 06.89 02.85- 06.89	CS689 CS1118	12 2.5 12 2.2
35-10 2.5	[8140.47R]	01.89- 12.96	CA642IR	14 55	01.89- 12.96 01.89- 12.96	CS689 CS1118	12 2.5 12 2.2
	[8140.97.2781]	07.91- 04.96	CA642IR	14 55	07.91- 04.96	CS689	12 2.5
35-10 2.5 Diesel	[8140.47R]	07.92- 04.97	CA642IR	14 55	07.92- 04.97 01.89- 08.98	CS689 CS1118	12 2.5 12 2.2
	[8140.47R.2790]	07.92- 04.97	CA642IR	14 55	01.89- 04.97 01.89- 12.96	CS689 CS1118	12 2.5 12 2.2
	[8140.97.2781]	07.92- 12.96	CA642IR	14 55	01.89- 12.96 01.89- 12.96	CS1118 CS689	12 2.2 12 2.5
35-10 2.8 Diesel	[8140.23]	05.96- 05.99	CA1556IR	14 90	01.96- 05.99	CS1118	12 2.2
35-12 2.5 Diesel	[8140.47.2700]	01.90- 05.96 01.90- 05.96 01.90- 05.96 10.90- 04.96	CA316IR CA641IR CA642IR CA569IR	14 55 14 45 14 55 14 85	01.90- 04.96	CS1118 CS689	12 2.2 12 2.5
35-12 2.8 Diesel	[8140.43]	05.96- 05.99	CA1556IR	14 90	05.96- 05.99	CS1118	12 2.2
35-8 2.4 Diesel	[8140.61.200]	04.78- 06.89	CA316IR	14 55	04.78- 06.89	CS1118	12 2.2
35-8 2.5 Diesel	[8140.07.2700]	01.89- 08.98 01.89- 08.98 01.89- 08.98	CA641IR CA642IR CA642IR	14 45 14 55 14 55	01.89- 08.98 07.89- 04.96	CS1118 CS689	12 2.2 12 2.5
	[8140.07.2712]	01.89- 08.98 01.89- 08.98	CA641IR CA642IR	14 45 14 55	01.89- 08.98 07.89- 04.96	CS1118 CS689	12 2.2 12 2.5
	[8140.67F]	01.89- 08.98 01.89- 08.98	CA641IR CA642IR	14 45 14 55	05.96- 03.98	CS1118	12 2.2
35-8 2.8 Diesel	[8140.63.]	09.98- 05.99	CA1556IR	14 90	09.98- 05.99	CS1118	12 2.2
35S14 2.3	[F1AE0481HA]	05.06- 05.06- 05.06-	CA1700IR CA1837IR CA2090IR*	14 110 14 140 14 180	05.06-	CS1203	12 2.3
35S14G 3.0	[F1CE0441A]	07.09- 07.09-	CA1913IR CA2089IR*	14 140 14 180	07.09-	CS1203	12 2.3
40 C 10 2.3 Diesel	[F1AE0481FA]	05.06- 05.06-	CA1700IR CA1837IR	14 110 14 140	05.06-	CS1203	12 2.3
40 C 11 2.3	[F1AE0481FA]	07.09- 07.09- 07.09-	CA1700IR CA1837IR CA2090IR*	14 110 14 140 14 180	07.09-	CS1203	12 2.3
40 C 12 2.3 Diesel	[F1AE0481GA]	05.06- 05.06-	CA1700IR CA1837IR	14 110 14 140	05.06-	CS1203	12 2.3
40 C 13 2.3	[F1AE0481GA]	07.09- 07.09- 07.09-	CA1700IR CA1837IR CA2090IR*	14 110 14 140 14 180	07.09-	CS1203	12 2.3
40 C 14 2.3 Diesel	[F1AE0481GA]	05.06- 05.06-	CA1700IR CA1837IR	14 110 14 140	05.06-	CS1203	12 2.3
40 C 14 3.0	[F1CCNG]	07.09- 07.09-	CA1913IR CA2089IR*	14 140 14 180	07.09-	CS1203	12 2.3
40 C 14 3.0	[F1CE3481LC]	07.09- 07.09- 07.09- 07.09-	CA1837IR CA1913IR CA1915IR CA1938IR CA2089IR*	14 140 14 140 14 110 14 90 14 180	07.09-	CS1203	12 2.3
40 C 14 3.0 Diesel	[F1CE0481A]	09.04- 04.06 09.04- 04.06	CA1913IR CA1915IR	14 140 14 110	09.04- 04.06	CS1203	12 2.3
40 C 15 2.8 Diesel	[8140.43N]	11.01- 04.06 11.01- 04.06	CA1557IR CA1679IR	14 90 14 120	11.01- 04.06	CS1203	12 2.3
40 C 15 3.0 Diesel	[F1CE0481FA]	05.06- 05.06-	CA1913IR CA1915IR	14 140 14 110	05.06-	CS1203	12 2.3
40 C 17 3.0	[F1CE0481HA]	07.09- 07.09- 07.09-	CA1913IR CA1915IR CA2089IR*	14 140 14 110 14 180	07.09-	CS1203	12 2.3
40 C 17 3.0 Diesel	[F1CE0481B]	01.05- 04.06 01.05- 04.06	CA1913IR CA1915IR	14 140 14 110	01.05- 04.06	CS1203	12 2.3
40 C 18 3.0 Diesel	[F1CE0481HA]	05.06- 05.06-	CA1913IR CA1915IR	14 140 14 110	05.06-	CS1203	12 2.3
40 S 10 2.3 Diesel	[F1AE0481FA]	05.06- 05.06-	CA1700IR CA1837IR	14 110 14 140	05.06-	CS1203	12 2.3
40 S 11 2.3	[F1AE0481FA]	07.09- 07.09- 07.09-	CA1700IR CA1837IR CA2090IR*	14 110 14 140 14 180	07.09-	CS1203	12 2.3
40 S 13 2.3	[F1AE0481GA]	07.09- 07.09- 07.09-	CA1700IR CA1837IR CA2090IR*	14 110 14 140 14 180	07.09-	CS1203	12 2.3
40 S 14 3.0	[F1CCNG]	07.09- 07.09-	CA1913IR CA2089IR*	14 140 14 180	07.09-	CS1203	12 2.3
40 S 14 3.0	[F1CE3481LC]	07.09- 07.09- 07.09- 07.09-	CA1837IR CA1913IR CA1915IR CA2089IR*	14 140 14 140 14 110 14 180	07.09-	CS1203	12 2.3
40 S 17 3.0	[F1CE0481HA]	07.09- 07.09- 07.09-	CA1913IR CA1915IR CA2089IR*	14 140 14 110 14 180	07.09-	CS1203	12 2.3
40 S 17 3.0 Diesel	[F1CE0481B]	01.05- 04.06 01.05- 04.06	CA1913IR CA1915IR	14 140 14 110	01.05- 04.06	CS1203	12 2.3
40-10 2.4 Diesel	[8140.27S]	01.85- 12.89 01.85- 12.89	CA641IR CA642IR	14 45 14 55	01.85- 12.89 01.85- 12.89	CS230 CS689	12 2.5 12 2.5
40-10 2.5 Diesel	[8140.27.2720]	01.90- 12.96	CA641IR	14 45	02.85- 06.89	CS230	12 2.5



**IVECO Continued**

		01.90- 12.96	CA642IR	14 55		01.90- 12.96	CS689	12 2.5
40-10 2.8 Diesel	[8140.23]	09.96- 05.99	CA1556IR	14 90		09.96- 05.99	CS1118	12 2.2
	[8140.23.]					05.96- 05.99	CS1118	12 2.2
40-12 2.5 Diesel	[8140.47.2700]	10.90- 04.96	CA642IR	14 55		10.90- 04.96	CS689	12 2.5
						10.90- 04.96	CS230	12 2.5
40-12 2.8 Diesel	[8140.43]	05.96- 05.99	CA1556IR	14 90		05.96- 05.99	CS1118	12 2.2
40-8 2.4 Diesel	[8140.61.200]	01.83- 06.89	CA316IR	14 55		01.83- 06.89	CS1118	12 2.2
45 C 14 3.0	[F1CE3481LC]					07.09-	CS1203	12 2.3
45 C 15 3.0 Diesel	[F1CE0481FA]	05.06-	CA1913IR	14 140		05.06-	CS1203	12 2.3
			CA1915IR	14 110				
45 C 17 3.0	[F1CE0481HA]					07.09-	CS1203	12 2.3
45 C 18 3.0 Diesel	[F1CE0481HA]	05.06-	CA1913IR	14 140		05.06-	CS1203	12 2.3
		05.06-	CA1915IR	14 110				
45-10 2.4 Diesel	[8140.21.200]	02.85- 06.89	CA569IR	14 85		02.85- 06.89	CS689	12 2.5
		02.85- 06.89	CA642IR	14 55		02.85- 06.89	CS1118	12 2.2
45-10 2.5 Diesel	[8140.27.2720]	01.89- 04.96	CA642IR	14 55		09.89- 04.96	CS689	12 2.5
		09.89- 04.96	CA569IR	14 85				
		01.91- 04.96	CA641IR	14 45				
45-10 2.8 Diesel	[8140.23]	05.96- 05.99	CA1556IR	14 90		05.96- 05.99	CS1118	12 2.2
45-12 2.5 Diesel	[8140.47.2711]	06.90- 04.96	CA569IR	14 85		06.90- 04.96	CS689	12 2.5
		06.90- 04.96	CA642IR	14 55				
	[8140.47.2721]	06.90- 04.96	CA569IR	14 85		06.90- 04.96	CS689	12 2.5
		06.90- 04.96	CA642IR	14 55				
45-12 2.8 Diesel	[8140.43]	05.96- 05.99	CA1556IR	14 90		05.96- 05.99	CS1118	12 2.2
49-10 2.4 Diesel	[8140.21.200]	02.85- 06.89	CA569IR	14 85		02.85- 06.89	CS689	12 2.5
		02.85- 12.89	CA641IR	14 45		02.85- 06.89	CS1118	12 2.2
		02.85- 06.89	CA642IR	14 55				
49-10 2.5 Diesel	[8140.27.2700]	01.89- 04.96	CA641IR	14 45		01.89- 04.96	CS689	12 2.5
		01.89- 04.96	CA642IR	14 55				
	[8140.47R.2790]	01.89- 04.96	CA569IR	14 85		01.89- 04.97	CS689	12 2.5
		01.89- 04.96	CA641IR	14 45				
		01.89- 04.96	CA642IR	14 55				
49-10 2.8 Diesel	[8140.23]	05.96- 05.99	CA1556IR	14 90		05.96- 05.99	CS1118	12 2.2
49-12 2.5 Diesel	[8140.47.2711]	06.90- 04.96	CA569IR	14 85		06.90- 04.96	CS689	12 2.5
		06.90- 04.96	CA642IR	14 55				
	[8140.47.2721]	06.90- 04.96	CA569IR	14 85		06.90- 04.96	CS689	12 2.5
		06.90- 04.96	CA642IR	14 55				
49-12 2.8 Diesel	[8140.43]	05.96- 05.99	CA1556IR	14 90		05.96- 05.99	CS1118	12 2.2
50 C 11 2.8 Diesel	[8140.43C]	05.99-	CA1557IR	14 90		05.99-	CS1203	12 2.3
		05.99-	CA1679IR	14 120				
50 C 13 2.8 Diesel	[8140.43S]	05.99-	CA1557IR	14 90		05.99-	CS1203	12 2.3
		05.99-	CA1679IR	14 120				
50 C 14 3.0	[F1CCNG]	07.09-	CA1913IR	14 140		07.09-	CS1203	12 2.3
		07.09-	CA2089IR*	14 180				
50 C 14 3.0	[F1CE3481LC]	07.09-	CA1913IR	14 140		07.09-	CS1203	12 2.3
		07.09-	CA1915IR	14 110				
		07.09-	CA2089IR*	14 180				
50 C 14 3.0 Diesel	[F1CE0481A]	09.04- 04.06	CA1913IR	14 140		09.04- 04.06	CS1203	12 2.3
		09.04- 04.06	CA1915IR	14 110				
50 C 15 2.8 Diesel	[8140.43N]	05.01-	CA1557IR	14 90		05.01-	CS1203	12 2.3
		05.01-	CA1679IR	14 120				
50 C 15 3.0 Diesel	[F1CE0481FA]	05.06-	CA1913IR	14 140		05.06-	CS1203	12 2.3
		05.06-	CA1915IR	14 110				
50 C 17 3.0	[F1CE0481HA]	07.09-	CA1913IR	14 140		07.09-	CS1203	12 2.3
		07.09-	CA1915IR	14 110				
		07.09-	CA2089IR*	14 180				
50 C 17 3.0 Diesel	[F1CE0481B]	09.04- 04.06	CA1913IR	14 140		09.04- 04.06	CS1203	12 2.3
		09.04- 04.06	CA1915IR	14 110				
50 C 18 3.0 Diesel	[F1CE0481HA]	05.06-	CA1913IR	14 140		05.06-	CS1203	12 2.3
		05.06-	CA1915IR	14 110				
55 S 17 3.0	[F1CE0481HA]	07.09-	CA1913IR	14 140		07.09-	CS1203	12 2.3
		07.09-	CA1915IR	14 110				
		07.09-	CA2089IR*	14 180				
59-12 2.5 Diesel	[8140.47.2700]	05.91- 04.96	CA569IR	14 85		05.91- 04.96	CS689	12 2.5
		05.91- 04.96	CA642IR	14 55				
	[8140.47.2711]	05.91- 04.96	CA569IR	14 85		05.91- 04.96	CS689	12 2.5
		05.91- 04.96	CA642IR	14 55				
59-12 2.8 Diesel	[8140.43]	05.96- 05.99	CA1556IR	14 90		05.96- 05.99	CS1118	12 2.2
60 C 14 3.0	[F1CE3481LC]	07.09-	CA1915IR	14 110		07.09-	CS1203	12 2.3
		07.09-	CA2089IR*	14 180				
60 C 15 3.0 Diesel	[F1CE0481HC]	05.06-	CA1913IR	14 140		05.06-	CS1203	12 2.3
		05.06-	CA1915IR	14 110				
60 C 17 3.0	[F1CE0481HA]	07.09-	CA1913IR	14 140		07.09-	CS1203	12 2.3
		07.09-	CA1915IR	14 110				
60 C 18 3.0 Diesel	[F1CE0481HC]	05.06-	CA1913IR	14 140		05.06-	CS1203	12 2.3
		05.06-	CA1915IR	14 110				
65 C 14 3.0	[F1CCNG]	07.09-	CA1913IR	14 140		07.09-	CS1203	12 2.3
		07.09-	CA2089IR*	14 180				
65 C 14 3.0	[F1CE3481LC]	07.09-	CA1913IR	14 140				
		07.09-	CA1915IR	14 110				
		07.09-	CA2089IR*	14 180				
65 C 14 3.0 Diesel	[F1CE0481A]	09.04- 04.06	CA1913IR	14 140		09.04- 04.06	CS1203	12 2.3
		09.04- 04.06	CA1915IR	14 110				
65 C 15 2.8 Diesel	[8140.43N]	11.01- 09.04	CA1557IR	14 90		11.01- 09.04	CS1203	12 2.3
		11.01- 09.04	CA1679IR	14 120				
65 C 15 3.0 Diesel	[F1CE0481HC]	05.06-	CA1913IR	14 140		05.06-	CS1203	12 2.3
		05.06-	CA1915IR	14 110				
65 C 17 3.0	[F1CE0481HA]	07.09-	CA1913IR	14 140		07.09-	CS1203	12 2.3
		07.09-	CA1915IR	14 110				
		07.09-	CA2089IR*	14 180				
65 C 17 3.0 Diesel	[F1CE0481B]	09.04- 04.06	CA1913IR	14 140		09.04- 04.06	CS1203	12 2.3
		09.04- 04.06	CA1915IR	14 110				
65 C 18 3.0 Diesel	[F1CE0481HC]	05.06-	CA1913IR	14 140		05.06-	CS1203	12 2.3
		05.06-	CA1915IR	14 110				
70 C 14 3.0	[F1CE3481LC]	07.09-	CA1913IR	14 140		07.09-	CS1203	12 2.3
		07.09-	CA1915IR	14 110				
		07.09-	CA2089IR*	14 180				
70 C 17 3.0	[F1CE0481HA]	07.09-	CA2089IR*	14 180				
Massif 3.0 HPI	[F1CE0481F]	10.08-	CA1913IR	14 140		10.08-	CS1203	12 2.3
		10.08-	CA1915IR	14 110				
Massif 3.0 HPI Single Cab	[F1CE0481F]	10.08-	CA1913IR	14 140		10.08-	CS1203	12 2.3
		10.08-	CA1915IR	14 110				
Massif 3.0 HPT	[F1CE0481F]	10.08-	CA1913IR	14 140		10.08-	CS1203	12 2.3
		10.08-	CA1915IR	14 110				
Massif 3.0 HPT Single Cab	[F1CE0481F]	10.08-	CA1913IR	14 140		10.08-	CS1203	12 2.3
		10.08-	CA1915IR	14 110				
30-8 2.4 Diesel	[8140.61.200]	01.78- 06.89	CA316IR	14 55		04.78- 06.89	CS1118	12 2.2
30-8 2.5 Diesel	[8140.07.2700]	01.89- 08.98	CA641IR	14 45		01.89- 08.98	CS1118	12 2.2
		01.89- 08.98	CA642IR	14 55		02.91- 04.96	CS689	12 2.5





	[8140.07.2712]	01.89- 08.98	CA641IR	14 45		01.89- 08.98	CS1118	12 2.2
		01.89- 08.98	CA642IR	14 55		02.89- 04.96	CS689	12 2.5
	[8140.67F]	01.89- 08.98	CA641IR	14 45		01.89- 08.98	CS1118	12 2.2
		01.89- 08.98	CA642IR	14 55				
30-8 2.8 Diesel	[8140.63.]	09.98- 05.99	CA1556IR	14 90		09.98- 05.99	CS1118	12 2.2
30-10 2.8 Diesel	[8140.23.]	05.96- 05.99	CA1556IR	14 90		05.96- 05.99	CS1118	12 2.2
<b>TRUCKS EU</b>								
440 S 42 10.3	(Stralis)[F3A3681B]	07.06-	CA1633IR	28 90		07.06-	CS1432*	24 5.0
						07.06-	CS1292	24 5.0
100 E 15 6.0	(EuroCargo)[8060.25R.4200LTC]	01.91- 08.00	CA1336IR	28 55		01.00-	CS1248	24 4.0
		01.91- 08.00	CA1438IR	28 80		01.91-	CS394	24 4.0
		01.91- 08.00	CA1448IR	28 35				
	[8060.45R.5000]	01.91- 08.00	CA1336IR	28 55		01.91-	CS394	24 4.0
		01.91- 08.00	CA1438IR	28 80		01.00-	CS1248	24 4.0
		01.91- 08.00	CA1448IR	28 35				
	[8060.45R.5001]	01.91- 08.00	CA1336IR	28 55		01.00-	CS1248	24 4.0
		01.91- 08.00	CA1438IR	28 80		01.91-	CS394	24 4.0
		01.91- 08.00	CA1448IR	28 35				
	[8060.45R.5003]	01.91- 08.00	CA1336IR	28 55		01.00-	CS1248	24 4.0
		01.91- 08.00	CA1438IR	28 80		01.91-	CS394	24 4.0
		01.91- 08.00	CA1448IR	28 35				
	[8060.45R.5005]	01.91- 08.00	CA1336IR	28 55		01.91-	CS394	24 4.0
		01.91- 08.00	CA1438IR	28 80		01.00-	CS1248	24 4.0
		01.91- 08.00	CA1448IR	28 35				
100 E 17 3.9	(Tector)[F4AE0481A]	09.00-	CA1699IR	28 70		09.00-	CS1268	24 4.0
		09.00-	CA1812IR	28 90				
100 E 18 3.9	(Tector)[F4AE3481B]	09.06-	CA1699IR	28 70				
		09.06-	CA1812IR	28 90				
100 E 18 5.9	(Tector)[F4AE0681E]	09.00-	CA1699IR	28 70		09.00-	CS1268	24 4.0
		09.00-	CA1812IR	28 90				
100 E 18 6.0	(EuroCargo)[8060.25V.4000TC]	01.91- 11.00	CA1336IR	28 55		01.91-	CS394	24 4.0
			CA1448IR	28 35		01.00-	CS1248	24 4.0
100 E 21 5.9	(Tector)[F4AE0681D]	09.00-	CA1699IR	28 70		09.00-	CS1268	24 4.0
		09.00-	CA1812IR	28 90				
100 E 21 6.0	(EuroCargo)[8060.45.4100TCA]	01.91- 11.00	CA1336IR	28 55		01.00-	CS1248	24 4.0
		01.91- 11.00	CA1448IR	28 35		01.91-	CS394	24 4.0
	[8060.45.4180TCA]	01.91- 11.00	CA1336IR	28 55		01.00-	CS1248	24 4.0
		01.91- 11.00	CA1448IR	28 35		01.91-	CS394	24 4.0
100 E 22 5.9	(Tector)[F4AE3681B]	09.06-	CA1699IR	28 70				
		09.06-	CA1812IR	28 90				
109-14 5.5	(Zeta)[8060.04.689]	06.83- 12.85	CA212IR	28 27		06.83- 12.85	CS232	24 4.0
109-14 5.9	(Zeta)[8060.05.289]	11.85- 03.91	CA212IR	28 27		11.85- 03.91	CS232	24 4.0
110 E 18 3.9	(Tector)[F4AE3481A]	09.06-	CA1699IR	28 70				
		09.06-	CA1812IR	28 90				
110 E 22 5.9	(Tector)[F4AE3681B]	05.06-	CA1699IR	28 70				
		05.06-	CA1812IR	28 90				
110 E 25 5.9	(Tector)[F4AE3681D]	05.06-	CA1699IR	28 70				
		05.06-	CA1812IR	28 90				
120 E 15 6.0	(EuroCargo)[8060.25R.4280LTC]	12.91- 07.00	CA1336IR	28 55		12.91-	CS394	24 4.0
		12.91- 07.00	CA1448IR	28 35		01.00-	CS1248	24 4.0
	[8060.25R4200]	12.91- 07.00	CA1336IR	28 55		12.91-	CS394	24 4.0
		12.91- 07.00	CA1448IR	28 35		01.00-	CS1248	24 4.0
120 E 18 3.9	(Tector)[F4AE3481A]	09.06-	CA1699IR	28 70				
		09.06-	CA1812IR	28 90				
120 E 18 5.9	(Tector)[F4AE0681E]	09.00- 08.03	CA1699IR	28 70		09.00- 08.03	CS1268	24 4.0
		09.00- 08.03	CA1812IR	28 90				
120 E 18 6.0	(EuroCargo)[8060.25V.4080TC]	01.92- 07.00	CA1336IR	28 55		01.92- 07.00	CS394	24 4.0
			CA1448IR	28 35		01.00- 07.00	CS1248	24 4.0
120 E 21 5.9	(Tector)[F4AE0681D]	09.00-	CA1699IR	28 70		09.00-	CS1268	24 4.0
		09.00-	CA1812IR	28 90				
	[F4AE3681B]	09.00-	CA1699IR	28 70				
		09.00-	CA1812IR	28 90				
120 E 22 5.9	(Tector)[F4AE3681B]	09.06-	CA1699IR	28 70				
		09.06-	CA1812IR	28 90				
120 E 23 6.0	(EuroCargo)[8060.45.6090]	01.92- 08.00	CA1448IR	28 35		01.92- 08.00	CS394	24 4.0
						01.00- 08.00	CS1248	24 4.0
	[8060.45S.6800TCA]	01.92- 08.00	CA1448IR	28 35		01.00- 08.00	CS1248	24 4.0
						01.92- 08.00	CS394	24 4.0
120 E 24 5.9	(Tector)[F4AE0681B]	09.00-	CA1699IR	28 70		09.00-	CS1268	24 4.0
		09.00-	CA1812IR	28 90				
120 E 25 5.9	(Tector)[F4AE3681D]	09.06-	CA1699IR	28 70				
		09.06-	CA1812IR	28 90				
120 E 28 5.9	(Tector)[F4AE0681A]	09.00-	CA1699IR	28 70		09.00-	CS1268	24 4.0
		09.00-	CA1812IR	28 90				
120 EL 17 3.9	(Tector)[F4AE0481A]	09.00-	CA1699IR	28 70		09.00-	CS1268	24 4.0
		09.00-	CA1812IR	28 90				
120 EL 21 5.9	(Tector)[F4AE0681D]	09.00-	CA1699IR	28 70		09.00-	CS1268	24 4.0
		09.00-	CA1812IR	28 90				
130 E 15 6.0	(EuroCargo)[8060.25R.4280LTC]	01.94- 07.00	CA1336IR	28 55		01.00- 07.00	CS1248	24 4.0
		01.94- 07.00	CA1448IR	28 35		01.94- 07.00	CS394	24 4.0
130 E 18 3.9	(Tector)[F4AE3481A]	09.06-	CA1699IR	28 70				
		09.06-	CA1812IR	28 90				
130 E 18 5.9	(Tector)[F4AE0681E]	09.00- 08.03	CA1699IR	28 70		09.00- 08.03	CS1268	24 4.0
		09.00- 08.03	CA1812IR	28 90				
130 E 18 6.0	(EuroCargo)[8060.25V.4080TC]	01.92- 07.00	CA1336IR	28 55		01.92- 07.00	CS394	24 4.0
			CA1448IR	28 35		01.00- 07.00	CS1248	24 4.0
130 E 21 5.9	(Tector)[F4AE0681D]	09.00-	CA1699IR	28 70		09.00-	CS1268	24 4.0
		09.00-	CA1812IR	28 90				
130 E 23 6.0	(EuroCargo)[8060.45.6090]	01.92- 07.00	CA1448IR	28 35		01.00-	CS1248	24 4.0
						01.92-	CS394	24 4.0
	[8060.45S.6000TCA]	01.92- 07.00	CA1448IR	28 35		01.00-	CS1248	24 4.0
						01.92-	CS394	24 4.0
130 E 24 5.9	(Tector)[F4AE0681B]	09.00-	CA1699IR	28 70		09.00-	CS1268	24 4.0
		09.00-	CA1812IR	28 90				
130 E 25 5.9	(Tector)[F4AE3681D]	09.06-	CA1699IR	28 70				
		09.06-	CA1812IR	28 90				
130 E 28 5.9	(Tector)[F4AE0681A]	09.00-	CA1699IR	28 70		09.00-	CS1268	24 4.0
		09.00-	CA1812IR	28 90				
135 E 18 6.0	(EuroCargo)[8060.25VTC]	01.94- 07.00	CA1336IR	28 55		01.93- 07.00	CS394	24 4.0
		01.94- 07.00	CA1438IR	28 80		01.93- 07.00	CS1248	24 4.0
		01.94- 07.00	CA1448IR	28 35				



VECO Continued

135 E 23 6.0	(EuroCargo)[8060.45STCA]	01.93- 07.00	CA1336IR	28 55	01.00- 07.00	CS1248	24 4.0
		01.93- 07.00	CA1438IR	28 80	01.93- 07.00	CS394	24 4.0
		01.93- 07.00	CA1448IR	28 35			
140 E 18 3.9	(Tector)[F4AE3481A]	09.06- 09.06	CA1699IR	28 70			
		09.06- 09.06	CA1812IR	28 90			
140 E 18 5.9	(Tector)[F4AE0681E]	09.00- 09.00	CA1699IR	28 70	09.00-	CS1268	24 4.0
		09.00- 09.00	CA1812IR	28 90			
140 E 21 5.9	(Tector)[F4AE0681D]	05.05- 05.05	CA1699IR	28 70	05.05-	CS1268	24 4.0
		05.05- 05.05	CA1812IR	28 90			
140 E 22 5.9	(Tector)[F4AE3681B]	09.06- 09.06	CA1699IR	28 70			
		09.06- 09.06	CA1812IR	28 90			
140 E 24 5.9	(Tector)[F4AE0681B]	09.00- 09.00	CA1699IR	28 70	09.00-	CS1268	24 4.0
		09.00- 09.00	CA1812IR	28 90			
140 E 25 5.9	(Tector)[F4AE3681D]	09.06- 09.06	CA1699IR	28 70			
		09.06- 09.06	CA1812IR	28 90			
140 E 28 5.9	(Tector)[F4AE0681A]	09.06- 09.06	CA1699IR	28 70	09.06-	CS1268	24 4.0
		09.06- 09.06	CA1812IR	28 90			
	[F4AE3681E]	09.06- 09.06	CA1699IR	28 70			
		09.06- 09.06	CA1812IR	28 90			
150 E 15 6.0	(EuroCargo)[8060.25R.4280LTC]	01.92- 12.96	CA1336IR	28 55	01.92- 12.96	CS394	24 4.0
		01.92- 12.96	CA1448IR	28 35			
150 E 18 3.9	(Tector)[F4AE3481A]	09.06- 09.06	CA1699IR	28 70			
		09.06- 09.06	CA1812IR	28 90			
150 E 18 5.9	(Tector)[F4AE0681E]	09.00- 08.03	CA1699IR	28 70	09.00- 08.03	CS1268	24 4.0
		09.00- 08.03	CA1812IR	28 90			
150 E 18 6.0	(EuroCargo)[8060.25V.4000TC]	01.92- 07.00	CA1336IR	28 55	01.92- 07.00	CS394	24 4.0
		01.92- 07.00	CA1448IR	28 35			
		01.92- 07.00	CA1336IR	28 55	01.00- 07.00	CS1248	24 4.0
	[8060.25V.4080TC]	01.92- 07.00	CA1448IR	28 35	01.92- 07.00	CS394	24 4.0
		01.92- 07.00	CA1448IR	28 35	01.92- 07.00	CS1248	24 4.0
150 E 21 5.9	(Tector)[F4AE0681D]	09.00- 09.00	CA1699IR	28 70	09.00-	CS1268	24 4.0
		09.00- 09.00	CA1812IR	28 90			
150 E 22 5.9	(Tector)[F4AE3681B]	09.06- 09.06	CA1699IR	28 70			
		09.06- 09.06	CA1812IR	28 90			
150 E 23 6.0	(EuroCargo)[8060.45.6090]	01.92- 07.00	CA1448IR	28 35	01.92- 07.00	CS394	24 4.0
		01.92- 07.00	CA1448IR	28 35	01.00- 07.00	CS1248	24 4.0
	[8060.45S.6800TCA]	01.92- 07.00	CA1448IR	28 35	01.92- 07.00	CS394	24 4.0
		01.92- 07.00	CA1448IR	28 35	01.00- 07.00	CS1248	24 4.0
150 E 24 5.9	(Tector)[F4AE0681B]	09.00- 09.00	CA1699IR	28 70	09.00-	CS1268	24 4.0
		09.00- 09.00	CA1812IR	28 90			
150 E 25 5.9	(EuroCargo)[F4AE3681D]	09.06- 09.06	CA1699IR	28 70			
		09.06- 09.06	CA1812IR	28 90			
	(Tector)[F4AE3681D]	09.06- 09.06	CA1699IR	28 70			
		09.06- 09.06	CA1812IR	28 90			
150 E 27 7.7	(EuroCargo)[8360.46.417TCA]	09.91- 07.00	CA1336IR	28 55	01.92- 07.00	CS1261	24 4.0
		09.91- 07.00	CA1438IR	28 80			
150 E 28 5.9	(EuroCargo)[F4AE3681E]	09.06- 09.06	CA1699IR	28 70			
		09.06- 09.06	CA1812IR	28 90			
	(Tector)[F4AE0681A]	09.00- 09.00	CA1699IR	28 70	09.00-	CS1268	24 4.0
		09.00- 09.00	CA1812IR	28 90			
	[F4AE3681E]	09.06- 09.06	CA1699IR	28 70			
		09.06- 09.06	CA1812IR	28 90			
150 E 30 5.9	(Tector)[F4AE0681A]	09.06- 09.06	CA1699IR	28 70	09.06-	CS1268	24 4.0
		09.06- 09.06	CA1812IR	28 90			
	[F4AE3681A]	09.06- 09.06	CA1699IR	28 70			
		09.06- 09.06	CA1812IR	28 90			
160 E 18 3.9	(Tector)[F4AE3481A]	09.06- 09.06	CA1699IR	28 70			
		09.06- 09.06	CA1812IR	28 90			
160 E 21 5.9	(Tector)[F4AE0681D]	09.00- 09.00	CA1699IR	28 70	09.00-	CS1268	24 4.0
		09.00- 09.00	CA1812IR	28 90			
	[F4AE3681E]	09.00- 09.00	CA1699IR	28 70			
		09.00- 09.00	CA1812IR	28 90			
160 E 22 5.9	(Tector)[F4AE3681B]	09.06- 09.06	CA1699IR	28 70			
		09.06- 09.06	CA1812IR	28 90			
160 E 24 5.9	(Tector)[F4AE0681B]	09.00- 09.00	CA1699IR	28 70	09.00-	CS1268	24 4.0
		09.00- 09.00	CA1812IR	28 90			
160 E 25 5.9	(Tector)[F4AE3681D]	09.06- 09.06	CA1699IR	28 70			
		09.06- 09.06	CA1812IR	28 90			
160 E 28 5.9	(Tector)[F4AE0681A]	09.00- 09.00	CA1699IR	28 70	09.00-	CS1268	24 4.0
		09.00- 09.00	CA1812IR	28 90			
	[F4AE3681E]	09.06- 09.06	CA1699IR	28 70			
		09.06- 09.06	CA1812IR	28 90			
160 E 30 5.9	(Tector)[F4AE0681A]	09.06- 09.06	CA1699IR	28 70	09.06-	CS1268	24 4.0
		09.06- 09.06	CA1812IR	28 90			
	[F4AE3681A]	09.06- 09.06	CA1699IR	28 70			
		09.06- 09.06	CA1812IR	28 90			
170 E 18 5.8	(EuroCargo)[8060.25VTC]	01.94- 07.00	CA1336IR	28 55	01.94- 07.00	CS394	24 4.0
		01.94- 07.00	CA1438IR	28 80	01.00- 07.00	CS1248	24 4.0
		01.94- 07.00	CA1448IR	28 35			
170 E 23 5.8	(EuroCargo)[8060.45STCA]	01.94- 01.94	CA1336IR	28 55	01.94-	CS394	24 4.0
		01.94- 01.94	CA1438IR	28 80	01.00-	CS1248	24 4.0
		01.94- 01.94	CA1448IR	28 35			
170 E 27 7.7	(EuroCargo)[8360.46.417TCA]	01.94- 01.94	CA1336IR	28 55	01.94- 07.00	CS1261	24 4.0
		01.94- 01.94	CA1438IR	28 80			
175-17 5.9	[8060.25.60.]	09.86- 07.92	CA212IR	28 27	09.86- 07.92	CS1248	24 4.0
		09.86- 07.92	CA326IR	28 55			
180 E 18 5.8	(EuroCargo)[8060.25VTC]	01.94- 01.94	CA1336IR	28 55	01.94-	CS1248	24 4.0
		01.94- 01.94	CA1438IR	28 80	01.94-	CS394	24 4.0
		01.94- 01.94	CA1448IR	28 35			
180 E 21 5.9	(Tector)[F4AE0681D]	09.00- 08.03	CA1699IR	28 70	09.00- 08.03	CS1268	24 4.0
		09.00- 08.03	CA1812IR	28 90			
180 E 21 6.0	(EuroCargo)[8060.45.4100TCA]	04.92- 07.00	CA1336IR	28 55	04.92- 07.00	CS394	24 4.0
		04.92- 07.00	CA1448IR	28 35	01.00- 07.00	CS1248	24 4.0
180 E 22 5.9	(Tector)[F4AE3681B]	09.06- 09.06	CA1699IR	28 70			
		09.06- 09.06	CA1812IR	28 90			
180 E 23 5.8	(EuroCargo)[8060.45STCA]	01.94- 01.94	CA1336IR	28 55	01.94-	CS394	24 4.0
		01.94- 01.94	CA1438IR	28 80			
		01.94- 01.94	CA1448IR	28 35			
180 E 24 5.9	(Tector)[F4AE0681B]	09.00- 08.03	CA1699IR	28 70	09.00- 08.03	CS1268	24 4.0
		09.00- 08.03	CA1812IR	28 90			



180 E 24 7.7	(EuroTech)[8360.46R.416TCA]	07.92- 07.00	CA1336IR	28 55	07.92- 12.96	CS1261	24 4.0
		07.92- 07.00	CA1438IR	28 80			
180 E 24 7.8	(Cursor)[F2BE0681D]	09.99- 11.04	CA2040IR	28 90	09.99- 11.04	CS1383	24 4.5
180 E 25 5.9	(Tector)[F4AE3681D]	09.06- 09.06	CA1699IR CA1812IR	28 70 28 90			
180 E 25 9.5	(EuroTrakker)[8460.41T]	05.99- 11.04	CA1336IR	28 55	05.99- 11.04	CS502	24 5.4
		05.99- 11.04	CA1438IR	28 80			
180 E 27 7.7	(EuroCargo)[8360.46.417TCA]	01.94-	CA1336IR	28 55	01.94- 07.00	CS1261	24 4.0
		01.94-	CA1438IR	28 80			
	(EuroTech)[8360.46.417TCA]	07.92- 07.00	CA1336IR	28 55	07.92- 12.96	CS1261	24 4.0
		07.92- 07.00	CA1438IR	28 80			
180 E 28 5.9	(Tector)[F4AE0681A]	09.00- 09.00	CA1699IR CA1812IR	28 70 28 90	09.00-	CS1268	24 4.0
180 E 30 3.9	(Tector)[F4AE3481C]	09.06- 09.06	CA1699IR CA1812IR	28 70 28 90			
180 E 30 5.9	(Tector)[F4AE0681A]	08.06- 08.06	CA1699IR CA1812IR	28 70 28 90	08.06-	CS1268	24 4.0
	[F4AE3681A]	08.06- 08.06	CA1699IR CA1812IR	28 70 28 90			
180 E 30 9.5	(EuroTech)[8460.41C.320]	07.92- 07.00	CA1336IR	28 55	07.92- 12.96	CS502	24 5.4
		07.92- 07.00	CA1438IR	28 80			
180 E 34 9.5	(EuroTech)[8460.41K.406]	04.92- 07.00	CA1336IR	28 55	04.92- 07.00	CS502	24 5.4
		04.92- 07.00	CA1438IR	28 80			
180 E 38 9.5	(EuroTech)[8460.41L.5020]	02.92- 12.93	CA1336IR	28 55	09.92- 12.93	CS502	24 5.4
180 E 42 14.0	(EuroTech)[8210.42L.400]	04.92- 12.93	CA1336IR	28 55	04.92- 12.93	CS1163	24 6.6
180 T 27 7.8	(Trakker)[F2BE0681F]	06.05-	CA2040IR	28 90	06.05-	CS1383	24 4.5
190 E 24 7.7	(EuroTech)[8360.46R.416TCA]	01.97- 08.98	CA1336IR	28 55	01.97- 08.98	CS1261	24 4.0
		01.97- 08.98	CA1438IR	28 80			
190 E 24 7.8	(Cursor)[F2BE0681D]	09.99- 11.04	CA2040IR	28 90	09.99- 11.04	CS1383	24 4.5
190 E 25 5.9	(Tector)[F4AE3681D]	05.08- 05.08	CA1699IR CA1812IR	28 70 28 90			
190 E 27 7.7	(EuroTech)[8360.46.417TCA]	07.92- 07.00	CA1336IR	28 55	01.97- 08.98	CS1261	24 4.0
		07.92- 07.00	CA1438IR	28 80			
190 E 27 7.8	(Cursor)[F2BE0681C]	08.00- 08.03	CA2040IR	28 90	08.00- 08.03	CS1383	24 4.5
	[F2BE0681F]	08.00- 08.03	CA2040IR	28 90	08.00- 08.03	CS1383	24 4.5
190 E 28 5.9	(Tector)[F4AE3681E]	05.08- 05.08	CA1699IR CA1812IR	28 70 28 90			
190 E 30 5.9	(Tector)[F4AE3681A]	05.08- 05.08	CA1699IR CA1812IR	28 70 28 90			
190 E 30 9.5	(EuroTech)[8460.41C.320]	07.92- 07.00	CA1336IR	28 55	01.97- 07.02	CS502	24 5.4
		07.92- 07.00	CA1438IR	28 80			
	(EuroTrakker)[8460.41C]	01.93- 11.04	CA1336IR	28 55	01.93- 07.00	CS502	24 5.4
		01.93- 11.04	CA1438IR	28 80			
	[8460.41C.]	11.99- 11.04	CA1336IR	28 55	11.99- 11.04	CS502	24 5.4
		11.99- 11.04	CA1438IR	28 80			
190 E 31 7.8	(Cursor)[F2BE0681B]	08.00- 08.03	CA2040IR	28 90	08.00- 08.03	CS1383	24 4.5
190 E 34 9.5	(EuroTech)[8460.41K.406]	04.92- 07.00	CA1336IR	28 55	04.92- 07.00	CS502	24 5.4
		04.92- 07.00	CA1438IR	28 80			
	(EuroTrakker)[8460.41K]	01.93- 11.04	CA1336IR	28 55	01.93- 07.00	CS502	24 5.4
		01.93- 11.04	CA1438IR	28 80			
	[8460.41K.TCA]	11.99- 11.04	CA1336IR	28 55	11.99- 11.04	CS502	24 5.4
		11.99- 11.04	CA1438IR	28 80			
190 E 35 7.8	(Cursor)[F2BE0681A]	08.00-	CA2040IR	28 90	08.00-	CS1383	24 4.5
190 E 37 13.8	(EuroTrakker)[8210.42K(TCA)]	11.99- 11.04	CA1336IR	28 55	11.99- 11.04	CS526	24 6.5
		11.99- 11.04	CA1438IR	28 80	11.99- 11.04	CS564	24 6.5
					11.99- 11.04	CS1163	24 6.6
190 E 37 14.0	(EuroTrakker)[8210.42K]	04.93- 11.00	CA1336IR	28 55	04.93- 11.00	CS1163	24 6.6
190 E 38 12.9	(Cursor)[F3BE0681G]	08.00-	CA1633IR	28 90	08.00- 08.05	CS1292	24 5.0
					08.05-	CS1432*	24 5.0
190 E 38 9.5	(EuroStar)[8460.41LTCA]	01.93- 07.00	CA1336IR	28 55	01.93- 07.00	CS502	24 5.4
	(EuroTech)[8460.41LTCA]	01.93- 07.00	CA1336IR	28 55	01.93- 07.00	CS502	24 5.4
190 E 39 10.3	(EuroStar)[F3AE0681E]	11.99-	CA1633IR	28 90	11.99- 02.02	CS1292	24 5.0
	(EuroTech)[F3AE0681E]	11.99- 08.05	CA1633IR	28 90	08.05-	CS1432*	24 5.0
					11.99- 08.05	CS1292	24 5.0
190 E 40 10.3	(EuroStar)[F3AE0681B]	09.00-	CA1633IR	28 90	09.00-	CS1292	24 5.0
	(EuroTech)[F3AE0681B]	01.01-	CA1633IR	28 90	01.01-	CS1292	24 5.0
190 E 42 13.8	(EuroTrakker)[8210.42L(TCA)]	11.99- 11.04	CA1336IR	28 55	11.99- 11.04	CS526	24 6.5
		11.99- 11.04	CA1438IR	28 80	11.99- 11.04	CS564	24 6.5
					11.99- 11.04	CS1163	24 6.6
190 E 42 14.0	(EuroStar)[8210.42L.400]	01.95- 07.00	CA1336IR	28 55	01.95- 07.00	CS1163	24 6.6
	(EuroTech)[8210.42L.400]	01.93- 07.00	CA1336IR	28 55	01.93- 07.00	CS1163	24 6.6
	(EuroTrakker)[8210.42L]	01.95- 07.00	CA1336IR	28 55	01.95- 07.00	CS1163	24 6.6
190 E 43 10.3	(EuroStar)[F3AE0681D]	08.00- 08.03	CA1633IR	28 90	08.05-	CS1432*	24 5.0
					11.99- 08.05	CS1292	24 5.0
	(EuroTech)[F3AE0681D]	01.01- 08.03	CA1633IR	28 90	08.05-	CS1432*	24 5.0
					01.01- 08.05	CS1292	24 5.0
190 E 44 12.9	(Cursor)[F3BE0681C]	08.00-	CA1633IR	28 90	08.05-	CS1432*	24 5.0
					08.00- 08.05	CS1292	24 5.0
190 E 47 14.0	(EuroStar)[8210.42M.TCA]	01.93- 02.02	CA1336IR	28 55	01.93- 02.02	CS564	24 6.5
		01.95- 11.00	CA1438IR	28 80	01.93- 02.02	CS526	24 6.5
					01.95-	CS1163	24 6.6
190 E 52 17.2	(EuroStar)[8280.42S.TCA]	01.93- 11.00	CA1336IR	28 55	04.92- 11.00	CS564	24 6.5
190 S 27 7.8	(Stralis)[F2BE0681C]	05.05-	CA2040IR	28 90	05.05-	CS1383	24 4.5
	[F2BE0681F]	04.04-	CA2040IR	28 90	04.04-	CS1383	24 4.5
190 S 30 7.8	(Stralis)[F2BE0681E]	04.04-	CA2040IR	28 90	04.04-	CS1383	24 4.5
190 S 31 7.8	(Stralis)[F2BE0681B]	06.03-	CA2040IR	28 90	06.03-	CS1383	24 4.5
	[F2BE0681C]	06.03-	CA2040IR	28 90	06.03-	CS1383	24 4.5
	[F2BE0681E]	06.03-	CA2040IR	28 90	06.03-	CS1383	24 4.5



**VECO Continued**

	[F2BE3681C]	04.04-	CA2040IR	28 90	04.04-	CS1383	24 4.5
190 S 33 7.8	(Stralis)[F2BE3681B]	12.06-	CA2040IR	28 90	12.06-	CS1383	24 4.5
190 S 35 7.8	(Stralis)[F2BE0681A]	06.03-	CA2040IR	28 90	06.03-	CS1383	24 4.5
190 S 36 7.8	(Stralis)[F2BE3681A]	05.07-	CA2040IR	28 90	05.07-	CS1383	24 4.5
190 S 40 10.3	(Stralis)[F3AE0681B]	02.02-	CA1633IR	28 90	02.02- 08.05	CS1292	24 5.0
					08.05-	CS1432*	24 5.0
190 S 42 10.3	(Stralis)[F3A3681B]	12.06-	CA1633IR	28 90	12.06-	CS1432*	24 5.0
190 S 43 10.3	(Stralis)[F3AE0681D]	02.02-	CA1633IR	28 90	08.05-	CS1432*	24 5.0
					02.02- 08.05	CS1292	24 5.0
190 S 45 10.3	(Stralis)[F3A3681A]	12.06-	CA1633IR	28 90	12.06-	CS1432*	24 5.0
190 S 48 12.9	(Stralis)[F3BE0681E]	02.02-	CA1633IR	28 90	02.02- 08.05	CS1292	24 5.0
					08.05-	CS1432*	24 5.0
190 S 50 12.9	(Stralis)[F3B3681B]	12.06-	CA1633IR	28 90	12.06-	CS1432*	24 5.0
190 T 27 7.8	(Trakker)[F2BE0681F]	06.05-	CA2040IR	28 90	06.05-	CS1383	24 4.5
190 T 31 7.8	(Trakker)[F2BE0681B]	10.04-	CA2040IR	28 90	10.04-	CS1383	24 4.5
190 T 33 7.8	(Trakker)[F2BE3681B]	03.06-	CA2040IR	28 90	03.06-	CS1383	24 4.5
190 T 35 7.8	(Trakker)[F2BE0681A]	10.04-	CA2040IR	28 90	10.04-	CS1383	24 4.5
190 T 38 12.9	(Trakker)[F3BE0681G]	10.04-	CA1633IR	28 90	10.04-	CS1432*	24 5.0
					10.04-	CS1292	24 5.0
190 T 41 12.9	(Trakker)[F3BE3681D]	03.06-	CA1633IR	28 90	03.06-	CS1432*	24 5.0
					03.06-	CS1292	24 5.0
190 T 44 12.9	(Trakker)[F3B3681G]	06.05-	CA1633IR	28 90	06.05-	CS1292	24 5.0
					06.05-	CS1432*	24 5.0
	[F3BE0681C]	10.04-	CA1633IR	28 90	10.04-	CS1432*	24 5.0
190-26 9.5	(TurboTech)[8460.21.102]	09.86- 09.94	CA212IR	28 27	09.86- 09.94	CS502	24 5.4
190-32 9.5	(TurboTech)[8460.41.102]	10.88- 01.98	CA212IR	28 27	10.88- 01.98	CS502	24 5.4
190-33 13.8	(TurboStar)[8210.22.105]	07.84- 05.87	CA326IR	28 55	07.84- 05.87	CS526	24 6.5
190-36 13.8	[8210.42.101]				07.87- 06.90	CS526	24 6.5
	(TurboStar)[8210.42.101]	07.87- 06.90	CA326IR	28 55	07.87- 06.90	CS526	24 6.5
	[8210.42.152]	07.90- 12.93	CA1336IR	28 55	07.90- 12.93	CS526	24 6.5
		07.90- 12.93	CA1438IR	28 80			
	[8210.42.154]	07.90- 12.93	CA1438IR	28 80	07.90- 12.93	CS526	24 6.5
	[8210.42.162]	07.90- 12.93	CA1336IR	28 55	07.90- 12.93	CS526	24 6.5
		07.90- 12.93	CA1438IR	28 80			
	[8210.42.181]	07.90- 11.98	CA1438IR	28 80	07.90- 11.98	CS526	24 6.5
	[8210.42.182]	07.90- 11.98	CA1438IR	28 80	07.90- 11.98	CS526	24 6.5
	[8210.42.191]	07.90- 11.98	CA1438IR	28 80	07.90- 11.98	CS526	24 6.5
	(TurboTech)[8210.42.151]	01.90- 12.92	CA1336IR	28 55	01.90- 12.92	CS526	24 6.5
		01.90- 12.92	CA1438IR	28 80			
	[8210.42.161]	01.90- 12.92	CA1336IR	28 55	01.90- 12.92	CS526	24 6.5
		01.90- 12.92	CA1438IR	28 80			
	[8210.42.171]	01.90- 12.92	CA1336IR	28 55	01.90- 12.92	CS526	24 6.5
		01.90- 12.92	CA1438IR	28 80			
190-42 17.2	(TurboStar)[8280.22.201]	07.84- 09.86	CA326IR	28 55	07.84- 09.86	CS564	24 6.5
	[8280.22.205]	07.84- 09.86	CA326IR	28 55	07.84- 09.86	CS564	24 6.5
190-48 17.2	(TurboStar)[8280.42.001]	03.89- 12.93	CA326IR	28 55	03.89- 12.93	CS564	24 6.5
	[8280.42.050]	11.91- 11.00	CA1438IR	28 80	11.91- 11.00	CS564	24 6.5
		11.91- 11.00	CA326IR	28 55			
220-36 13.8	(TurboTech)[8210.42.152]	01.90- 12.92	CA1336IR	28 55	01.90- 12.92	CS526	24 6.5
	[8210.42.155]	01.90- 12.92	CA1336IR	28 55	01.90- 12.92	CS526	24 6.5
	[8210.42.172]	01.90- 12.92	CA1336IR	28 55	01.90- 12.92	CS526	24 6.5
240 E 30 9.5	(EuroTech)[8460.41C.TCA]	01.97-	CA1336IR	28 55	01.97-	CS502	24 5.4
		01.97-	CA1438IR	28 80			
240 E 34 9.5	(EuroTech)[8460.41K.TCA]	09.95- 12.96	CA1336IR	28 55	09.95- 12.96	CS502	24 5.4
		09.95- 12.96	CA1438IR	28 80			
240 E 38 9.5	(EuroStar)[8460.41L.5020]	01.93- 02.02	CA1336IR	28 55	01.93- 02.02	CS502	24 5.4
	(EuroTech)[8460.41L.5020]	09.92- 11.00	CA1336IR	28 55	09.92- 11.00	CS502	24 5.4
240 E 42 14.0	(EuroStar)[8210.42L.400]	01.93- 02.02	CA1336IR	28 55	01.93- 02.02	CS1163	24 6.6
	(EuroTech)[8210.42L.400]	04.92- 12.00	CA1336IR	28 55	04.92- 12.00	CS1163	24 6.6
		04.92- 12.00	CA1438IR	28 80			
240 E 47 14.0	(EuroStar)[8210.42M.TCA]	01.93- 02.02	CA1336IR	28 55	11.95- 12.02	CS564	24 6.5
		01.93- 02.02	CA1438IR	28 80			
240 E 52 17.2	(EuroStar)[8280.42S.TCA]	01.93- 02.02	CA1336IR	28 55	01.93- 12.00	CS526	24 6.5
		01.93- 12.00	CA1438IR	28 80			
240-36 13.8	(TurboTech)[8210.42.155]	01.90- 12.92	CA1336IR	28 55	01.90- 12.92	CS526	24 6.5
	[8210.42.165]	01.90- 12.92	CA1336IR	28 55	01.90- 12.92	CS526	24 6.5
		01.90- 12.92	CA1438IR	28 80			
	[8210.42.175]	01.90- 12.92	CA1336IR	28 55			
		01.90- 12.92	CA1438IR	28 80			
	[8210.42.185]	01.90- 12.92	CA1336IR	28 55	01.90- 12.92	CS526	24 6.5
		01.90- 12.92	CA1438IR	28 80			
	[8210.42.186]	01.90- 12.92	CA1336IR	28 55	01.90- 12.92	CS526	24 6.5
		01.90- 12.92	CA1438IR	28 80			
	[8210.42.195]	01.90- 12.92	CA1336IR	28 55	01.90- 12.92	CS526	24 6.5
		01.90- 12.92	CA1438IR	28 80			
260 E 23 5.9	(EuroCargo)[8060.45S.6000]	12.91- 07.00	CA1336IR	28 55	12.91- 07.00	CS394	24 4.0
		12.91- 07.00	CA1438IR	28 80			
		12.91- 07.00	CA1448IR	28 35			
	[8060.45STCA]	12.91- 07.00	CA1336IR	28 55	12.91- 07.00	CS394	24 4.0
		12.91- 07.00	CA1438IR	28 80			
		12.91- 07.00	CA1448IR	28 35			
260 E 23 6.0	(EuroCargo)[8060.45S.6000TCA]	01.92- 07.00	CA1336IR	28 55	01.92- 07.00	CS394	24 4.0
		01.92- 07.00	CA1448IR	28 35			
		01.92- 07.00	CA1438IR	28 80	01.00- 07.00	CS1248	24 4.0
260 E 23 KE 5.9	(EuroCargo)		CA1438IR	28 80			
260 E 24 7.8	(Cursor)[F2BE0681D]	08.00-	CA2040IR	28 90	08.00-	CS1383	24 4.5
260 E 27 7.7	(EuroCargo)[8360.46.417]	09.91- 07.00	CA1336IR	28 55	09.91- 07.00	CS1261	24 4.0
		09.91- 07.00	CA1438IR	28 80			
	[8360.46.417TCA]	09.91- 07.00	CA1336IR	28 55	09.91- 07.00	CS1261	24 4.0
		09.91- 07.00	CA1438IR	28 80			
260 E 27 7.8	(Cursor)[F2BE0681B]	11.99- 11.04	CA2040IR	28 90	11.99- 11.04	CS1383	24 4.5
	[F2BE0681C]	08.00-	CA2040IR	28 90	08.00-	CS1383	24 4.5
	[F2BE0681F]	08.00-	CA2040IR	28 90	08.00-	CS1383	24 4.5



260 E 28 5.9	(Tector)[F4AE0681A]		CA1699IR	28 70				
			CA1812IR	28 90			CS1268	24 4.0
260 E 30 9.5	(EuroTrakker)[8460.41C]	07.92- 07.00	CA1336IR	28 55		01.93- 07.00	CS502	24 5.4
		07.92- 07.00	CA1438IR	28 80				
	[8460.41C.TCA]	11.99- 11.04	CA1336IR	28 55		11.99- 11.04	CS502	24 5.4
		11.99- 11.04	CA1438IR	28 80				
260 E 31 7.8	(Cursor)[F2BE0681B]	08.00-	CA2040IR	28 90		08.00-	CS1383	24 4.5
260 E 34 9.5	(EuroTrakker)[8460.41K]	04.92- 07.00	CA1336IR	28 55		01.93- 07.00	CS502	24 5.4
		04.92- 07.00	CA1438IR	28 80				
	[8460.41K.TCA]	11.99- 11.04	CA1336IR	28 55		11.99- 11.04	CS502	24 5.4
		11.99- 11.04	CA1438IR	28 80				
260 E 35 7.8	(Cursor)[F2BE0681A]	08.00- 08.04	CA2040IR	28 90		08.00- 08.04	CS1383	24 4.5
260 E 37 13.8	(EuroTrakker)[8210.42K(TCA)]	11.99- 11.04	CA1336IR	28 55		11.99- 11.04	CS526	24 6.5
		11.99- 11.04	CA1438IR	28 80		11.99- 11.04	CS564	24 6.5
						11.99- 11.04	CS1163	24 6.6
260 E 37 14.0	(EuroTrakker)[8210.42K]	12.94- 12.01	CA1336IR	28 55		01.93- 12.01	CS564	24 6.5
		12.94- 12.01	CA1438IR	28 80		01.93- 12.01	CS1163	24 6.6
260 E 38 12.9	(Cursor)[F3BE0681G]	08.00-	CA1633IR	28 90		08.00- 08.05	CS1292	24 5.0
						08.05-	CS1432*	24 5.0
260 E 38 9.5	(EuroStar)[8460.41LTCA]	01.93- 02.02	CA1336IR	28 55		01.94-	CS502	24 5.4
		01.94-	CA1438IR	28 80				
	(EuroTech)[8460.41N]	01.94- 01.94	CA1336IR	28 55		01.94-	CS502	24 5.4
			CA1438IR	28 80				
260 E 39 10.3	(EuroStar)[F3AE0681E]	11.99-	CA1633IR	28 90		08.05-	CS1432*	24 5.0
						11.99- 08.05	CS1292	24 5.0
	(EuroTech)[F3AE0681E]	11.99-	CA1633IR	28 90		11.99- 08.05	CS1292	24 5.0
						08.05-	CS1432*	24 5.0
260 E 40 10.3	(EuroStar)[F3AE0681B]	09.00-	CA1633IR	28 90		08.01- 09.04	CS1292	24 5.0
	(EuroTech)[F3AE0681B]	01.01-	CA1633IR	28 90		01.01-	CS1292	24 5.0
260 E 42 13.8	(EuroTrakker)[8210.42L(TCA)]	11.99- 11.04	CA1336IR	28 55		11.99- 11.04	CS526	24 6.5
		11.99- 11.04	CA1438IR	28 80		11.99- 11.04	CS564	24 6.5
						11.99- 11.04	CS1163	24 6.6
260 E 42 14.0	(EuroStar)[8210.42L]	01.94- 12.00	CA1336IR	28 55		01.94- 12.00	CS1163	24 6.6
	(EuroTech)[8210.42L.400]	01.94- 12.00	CA1336IR	28 55		01.94- 12.00	CS1163	24 6.6
	(EuroTrakker)[8210.42L]	01.93- 12.00	CA1336IR	28 55		01.93- 12.00	CS1163	24 6.6
260 E 43 10.3	(EuroStar)[F3AE0681D]	08.00- 02.02	CA1633IR	28 90		11.99- 08.05	CS1292	24 5.0
						08.05-	CS1432*	24 5.0
	(EuroTech)[F3AE0681D]	08.00- 08.03	CA1633IR	28 90		11.99- 08.05	CS1292	24 5.0
						08.05-	CS1432*	24 5.0
260 E 44 12.9	(Cursor)[F3BE0681C]	08.00-	CA1633IR	28 90		08.00- 08.05	CS1292	24 5.0
						08.05-	CS1432*	24 5.0
260 E 47 13.8	(EuroTrakker)[8210.42M.TCA]	11.99- 11.04	CA1336IR	28 55		11.99- 11.04	CS526	24 6.5
		11.99- 11.04	CA1438IR	28 80		11.99- 11.04	CS564	24 6.5
						11.99- 11.04	CS1163	24 6.6
260 E 47 14.0	(EuroStar)[8210.42M.TCA]	01.93- 02.02	CA1336IR	28 55		01.93- 02.02	CS564	24 6.5
		01.95-	CA1438IR	28 80		01.95-	CS1163	24 6.6
260 E 48 12.9	(EuroStar)[F3BE0681E]	01.93- 02.02	CA1633IR	28 90		01.93- 02.02	CS1292	24 5.0
						01.93- 02.02	CS1432*	24 5.0
260 E 52 17.2	(EuroStar)[8280.42S.TCA]	01.95- 07.00	CA1336IR	28 55		01.95- 07.00	CS564	24 6.5
260 S 27 7.8	(Stralis)[F2BE0681F]	04.04-	CA2040IR	28 90		04.04-	CS1383	24 4.5
260 S 30 7.8	(Stralis)[F2BE0681E]	04.04-	CA2040IR	28 90		04.04-	CS1383	24 4.5
260 S 31 7.8	(Stralis)[F2BE0681B]	06.03-	CA2040IR	28 90		06.03-	CS1383	24 4.5
	[F2BE3681C]	04.04-	CA2040IR	28 90		04.04-	CS1383	24 4.5
260 S 33 7.8	(Stralis)[F2BE3681B]	12.06-	CA2040IR	28 90		12.06-	CS1383	24 4.5
260 S 35 7.8	(Stralis)[F2BE0681A]	06.03-	CA2040IR	28 90		06.03-	CS1383	24 4.5
260 S 36 7.8	(Stralis)[F2BE3681A]	07.07-	CA2040IR	28 90		07.07-	CS1383	24 4.5
260 S 40 10.3	(Cursor)[F3AE0681B]	02.02-	CA1633IR	28 90		08.05-	CS1432*	24 5.0
						02.02- 08.05	CS1292	24 5.0
	(Stralis)[F3AE0681B]	06.03-	CA1633IR	28 90		06.03- 08.05	CS1292	24 5.0
						08.05-	CS1432*	24 5.0
260 S 42 10.3	(Stralis)[F3A3681B]	12.06-	CA1633IR	28 90		12.06-	CS1432*	24 5.0
						05.07-	CS1292	24 5.0
260 S 43 10.3	(Cursor)[F3AE0681D]	02.02-	CA1633IR	28 90		02.02- 08.05	CS1292	24 5.0
						08.05-	CS1432*	24 5.0
	(Stralis)[F3AE0681D]	06.03-	CA1633IR	28 90		06.03- 08.05	CS1292	24 5.0
						08.05-	CS1432*	24 5.0
260 S 45 10.3	(Stralis)[F3A3681A]	12.06-	CA1633IR	28 90		05.07-	CS1432*	24 5.0
						12.06-	CS1292	24 5.0
260 S 48 12.9	(Cursor)[F3BE0681E]	02.02-	CA1633IR	28 90		02.02- 08.05	CS1292	24 5.0
						08.05-	CS1432*	24 5.0
	(Stralis)[F3BE0681E]	02.02-	CA1633IR	28 90		02.02- 08.05	CS1292	24 5.0
						08.05-	CS1432*	24 5.0
260 S 50 12.9	(Stralis)[F3B3681B]	07.06-	CA1633IR	28 90		07.06-	CS1292	24 5.0
						07.06-	CS1432*	24 5.0
260 S 54 12.9	(Cursor)[F3BE0681A]	02.02-	CA1633IR	28 90		08.05-	CS1432*	24 5.0
						02.02- 08.05	CS1292	24 5.0
	(Stralis)[F3BE0681A]	02.02-	CA1633IR	28 90		08.05-	CS1432*	24 5.0
						02.02- 08.05	CS1292	24 5.0
260 S 56 12.9	(Stralis)[F3B3681A]	07.06-	CA1633IR	28 90		07.06-	CS1292	24 5.0
						07.06-	CS1432*	24 5.0
260 T 31 7.8	(Trakker)[F2BE0681B]	10.04-	CA2040IR	28 90		10.04-	CS1383	24 4.5
260 T 33 7.8	(Trakker)[F2BE3681B]	03.06-	CA2040IR	28 90		03.06-	CS1383	24 4.5
260 T 35 7.8	(Trakker)[F2BE0681A]	10.04-	CA2040IR	28 90		10.04-	CS1383	24 4.5
260 T 36 7.8	(Trakker)[F2BE3681A]	10.04-	CA2040IR	28 90		10.04-	CS1383	24 4.5
260 T 38 12.9	(Trakker)[F3BE0681G]	09.04- 03.06	CA1633IR	28 90		10.04-	CS1432*	24 5.0
						09.04- 03.06	CS1292	24 5.0
260 T 41 12.9	(Trakker)[F3BE3681D]	03.06-	CA1633IR	28 90		03.06-	CS1292	24 5.0
						03.06-	CS1432*	24 5.0
260 T 44 12.9	(Trakker)[F3BE0681C]	06.05-	CA1633IR	28 90		06.05-	CS1292	24 5.0
260 T 45 12.9	(Trakker)[F3BE3681C]	03.06-	CA1633IR	28 90		03.06-	CS1292	24 5.0
						03.06-	CS1432*	24 5.0 MI
260 T 48 12.9	(Trakker)[F3BE0681E]	06.05-	CA1633IR	28 90		06.05-	CS1292	24 5.0
260 T 50 12.9	(Trakker)[F3BE3681B]	03.06-	CA1633IR	28 90		03.06-	CS1432*	24 5.0
						03.06-	CS1292	24 5.0
280 E 23 5.9	(EuroCargo)[8060.45S.6000]	12.91- 11.00	CA1336IR	28 55		12.91- 11.00	CS394	24 4.0
		12.91- 11.00	CA1438IR	28 80				
		12.91- 11.00	CA1448IR	28 35				



**VECO Continued**

	[8060.45STCA]	12.91- 11.00 CA1336IR 28 55	12.91- 11.00 CS394 24 4.0
		12.91- 11.00 CA1438IR 28 80	
		12.91- 11.00 CA1448IR 28 35	
280 E 23 6.0	(EuroCargo)[8060.45S.6000TCA]	01.92- 11.00 CA1336IR 28 55	01.00- 11.00 CS1248 24 4.0
		01.92- 11.00 CA1448IR 28 35	01.92- 11.00 CS394 24 4.0
320 E 27 7.7	(EuroCargo)[8360.46.417]	10.91- 08.00 CA1336IR 28 55	10.91- 08.00 CS1261 24 4.0
		10.91- 08.00 CA1438IR 28 80	
		01.92- 08.00 CA1448IR 28 35	
	[8360.46.417TCA]	10.91- 08.00 CA1336IR 28 55	10.91- 08.00 CS1261 24 4.0
		10.91- 08.00 CA1438IR 28 80	
320 E 28 5.9	(Tector)[F4AE0681A]	09.00- 08.03 CA1699IR 28 70	09.00- 08.03 CS1268 24 4.0
		09.00- 08.03 CA1812IR 28 90	
340 E 34 9.5	(EuroTrakker)[8460.41K]	04.92- 07.00 CA1336IR 28 55	04.92- 07.00 CS502 24 5.4
		04.92- 07.00 CA1438IR 28 80	
	[8460.41K.]	11.99- 11.04 CA1336IR 28 55	11.99- 11.04 CS502 24 5.4
		11.99- 11.04 CA1438IR 28 80	
340 E 35 7.8	(Cursor)[F2BE0681A]	08.00- CA2040IR 28 90	08.00- CS1383 24 4.5
340 E 37 13.8	(EuroTrakker)[8210.42K.]	11.99- 11.04 CA1336IR 28 55	11.99- 11.04 CS526 24 6.5
		11.99- 11.04 CA1438IR 28 80	11.99- 11.04 CS564 24 6.5
			11.99- 11.04 CS1163 24 6.6
340 E 37 14.0	(EuroTrakker)[8210.42K]	03.95- 12.02 CA1336IR 28 55	03.95- 12.02 CS1163 24 6.6
		03.95- 12.02 CA1438IR 28 80	
340 E 38 12.9	(Cursor)[F3BE0681G]	08.00- 11.04 CA1633IR 28 90	08.00- 08.05 CS1292 24 5.0
			08.05- CS1432* 24 5.0
340 E 42 13.8	(EuroTrakker)[8210.42L.]	11.99- 11.04 CA1336IR 28 55	11.99- 11.04 CS564 24 6.5
		11.99- 11.04 CA1438IR 28 80	11.99- 11.04 CS526 24 6.5
			11.99- 11.04 CS1163 24 6.6
340 E 42 14.0	(EuroTrakker)[8210.42L]	06.92- 12.00 CA1336IR 28 55	01.95- 12.00 CS564 24 6.5
		06.92- 12.00 CA1438IR 28 80	01.95- 12.00 CS526 24 6.5
340 E 44 12.9	(Cursor)[F3BE0681C]	08.00- CA1633IR 28 90	08.00- 08.05 CS1292 24 5.0
			08.05- CS1432* 24 5.0
340 T 35 7.8	(Trakker)[F2BE0681A]	06.05- CA2040IR 28 90	06.05- CS1383 24 4.5
340 T 36 7.8	(Trakker)[F2BE3681A]	03.06- CA2040IR 28 90	03.06- CS1383 24 4.5
340 T 38 12.8	(Trakker)[F3BE0681G]	09.05- CA1633IR 28 90	09.05- CS1292 24 5.0
340 T 38 12.9	(Trakker)[F3BE0681G]	06.05- CA1633IR 28 90	06.05- CS1292 24 5.0
340 T 41 12.9	(Trakker)[F3B3681D]	06.06- CA1633IR 28 90	06.06- CS1292 24 5.0
			06.06- CS1432* 24 5.0
	[F3BE3681D]	03.06- CA1633IR 28 90	03.06- CS1292 24 5.0
			03.06- CS1432* 24 5.0
340 T 44 12.8	(Trakker)[F3BE0681C]	06.05- CA1633IR 28 90	06.05- CS1292 24 5.0
340 T 44 12.9	(Trakker)[F3BE0681C]	06.05- CA1633IR 28 90	06.05- CS1292 24 5.0
340 T 45 12.9	(Trakker)[F3B3681C]	06.06- CA1633IR 28 90	06.06- CS1432* 24 5.0
			06.06- CS1292 24 5.0
	[F3BE3681C]	03.06- CA1633IR 28 90	03.06- CS1292 24 5.0
			03.06- CS1432* 24 5.0
340 T 50 12.9	(Trakker)[F3BE3681B]	03.06- CA1633IR 28 90	03.06- CS1432* 24 5.0
			03.06- CS1292 24 5.0
380 E 34 9.5	(EuroTrakker)[8460.41K]	04.92- 07.00 CA1336IR 28 55	01.93- 07.00 CS502 24 5.4
		04.92- 07.00 CA1438IR 28 80	
	[8460.41K.]	11.99- 11.04 CA1336IR 28 55	11.99- 11.04 CS502 24 5.4
		11.99- 11.04 CA1438IR 28 80	
380 E 35 7.8	(Cursor)[F2BE0681A]	01.00- 11.04 CA2040IR 28 90	01.00- 11.04 CS1383 24 4.5
380 E 37 13.8	(EuroTrakker)[8210.42K(TCA)]	11.99- 11.04 CA1336IR 28 55	11.99- 11.04 CS526 24 6.5
		11.99- 11.04 CA1438IR 28 80	11.99- 11.04 CS564 24 6.5
			11.99- 11.04 CS1163 24 6.6
380 E 37 14.0	(EuroTrakker)[8210.42K]	03.95- 12.02 CA1336IR 28 55	01.93- 12.02 CS1163 24 6.6
		03.95- 12.02 CA1438IR 28 80	
380 E 38 12.9	(Cursor)[F3BE0681G]	08.00- 11.04 CA1633IR 28 90	08.00- 11.04 CS1292 24 5.0
			08.04- CS1432* 24 5.0
380 E 42 13.8	(EuroTrakker)[8210.42L(TCA)]	11.99- 11.04 CA1336IR 28 55	11.99- 11.04 CS526 24 6.5
		11.99- 11.04 CA1438IR 28 80	11.99- 11.04 CS1163 24 6.6
			11.99- 11.04 CS564 24 6.5
	[8210.42L.]	01.93- 12.00 CA1336IR 28 55	01.93- 12.00 CS526 24 6.5
		01.93- 12.00 CA1438IR 28 80	01.93- 12.00 CS1163 24 6.6
			01.93- 12.00 CS564 24 6.5
380 E 42 14.0	(EuroTrakker)[8210.42L]	06.92- 12.00 CA1336IR 28 55	01.93- 12.00 CS526 24 6.5
		06.92- 12.00 CA1438IR 28 80	
380 E 44 12.9	(Cursor)[F3BE0681C]	08.00- 11.04 CA1633IR 28 90	08.00- 11.04 CS1292 24 5.0
380 E 47 13.8	(EuroTrakker)[8210.42M.TCA]	11.99- 11.04 CA1336IR 28 55	11.99- 11.04 CS564 24 6.5
		11.99- 11.04 CA1438IR 28 80	11.99- 11.04 CS526 24 6.5
			11.99- 11.04 CS1163 24 6.6
380 T 33 7.8	(Trakker)[F2BE3681B]	03.06- CA2040IR 28 90	03.06- CS1383 24 4.5
380 T 36 7.8	(Trakker)[F2BE3681A]	10.04- CA2040IR 28 90	10.04- CS1383 24 4.5
		04.06- CA1633IR 28 90	
380 T 38 12.9	(Trakker)[F3BE0681G]	06.05- CA1633IR 28 90	06.05- CS1292 24 5.0
380 T 41 12.8	(Trakker)[F3B3681D]	09.06- CA1633IR 28 90	09.06- CS1292 24 5.0
			09.06- CS1432* 24 5.0
380 T 41 12.9	(Trakker)[F3BE3681D]	03.06- CA1633IR 28 90	03.06- CS1432* 24 5.0
			03.06- CS1292 24 5.0
380 T 44 12.9	(Trakker)[F3BE0681C]	06.05- CA1633IR 28 90	06.05- CS1292 24 5.0
380 T 45 12.8	(Trakker)[F3B3681C]	09.06- CA1633IR 28 90	09.06- CS1432* 24 5.0
			09.06- CS1292 24 5.0
380 T 45 12.9	(Trakker)[F3BE3681C]	03.06- CA1633IR 28 90	03.06- CS1432* 24 5.0
			03.06- CS1292 24 5.0 ND
380 T 48 12.9	(Trakker)[F3BE0681E]	06.05- CA1633IR 28 90	06.05- CS1292 24 5.0
380 T 50 12.9	(Trakker)[F3BE3681B]	03.06- CA1633IR 28 90	03.06- CS1432* 24 5.0
			03.06- CS1292 24 5.0
400 E 30 9.5	(EuroTech)[8460.41C.320]	04.92- 12.00 CA1336IR 28 55	01.92- 08.98 CS502 24 5.4
		04.92- 12.00 CA1438IR 28 80	
400 E 31 7.8	(Cursor)[F2BE0681B]	08.00- CA2040IR 28 90	08.00- CS1383 24 4.5
400 E 34 9.5	(EuroTech)[8460.41K.406]	01.92- 12.00 CA1336IR 28 55	04.92- 12.00 CS502 24 5.4
		01.92- 12.00 CA1438IR 28 80	
	(EuroTrakker)[8460.41K]		01.93- 12.00 CS502 24 5.4
400 E 35 7.8	(Cursor)[F2BE0681A]	01.00- 11.04 CA2040IR 28 90	01.00- 11.04 CS1383 24 4.5
400 E 37 14.0	(EuroTrakker)[8210.42K]	07.94- 12.00 CA1336IR 28 55	07.94- 12.00 CS1163 24 6.6
		07.94- 12.00 CA1438IR 28 80	
400 E 38 9.5	(EuroStar)[8460.41L.5020]	01.94- 11.00 CA1336IR 28 55	01.94- 11.00 CS502 24 5.4
	[8460.41LTCA]	01.94- 11.00 CA1336IR 28 55	01.94- 11.00 CS502 24 5.4



	[8460.41N]	01.94- 11.00	CA1336IR	28 55	01.94- 11.00	CS502	24 5.4
	(EuroTech)[8460.41L.5020]	09.92- 11.00	CA1336IR	28 55	09.92- 11.00	CS502	24 5.4
	[8460.41N]	09.92- 11.00	CA1336IR	28 55	09.92- 11.00	CS502	24 5.4
400 E 42 14.0	(EuroStar)[8210.42L]	01.94- 12.00	CA1336IR	28 55	01.94- 12.00	CS1163	24 6.6
	(EuroTech)[8210.42L.400]	04.92- 12.00	CA1336IR	28 55	04.92- 12.00	CS1163	24 6.6
	(EuroTrakker)[8210.42L]	04.92- 12.00	CA1336IR	28 55	04.92- 11.04	CS526	24 6.5
		04.92- 12.00	CA1438IR	28 80	01.93- 11.04	CS1163	24 6.6
				01.95-	CS564	24 6.5	
400 T 35 7.8	(Trakker)[F2BE0681A]	06.05-	CA2040IR	28 90	06.05-	CS1383	24 4.5
400 T 36 7.8	(Trakker)[F2BE3681A]	10.04-	CA2040IR	28 90	10.04-	CS1383	24 4.5
400 T 38 12.9	(Trakker)[F3BE0681G]	06.05-	CA1633IR	28 90	06.05-	CS1292	24 5.0
400 T 41 12.9	(Trakker)[F3BE3681D]	03.06-	CA1633IR	28 90	03.06-	CS1292	24 5.0
					03.06-	CS1432*	24 5.0
400 T 42 12.9	(Trakker)[F3BE0681V]	06.05-	CA1633IR	28 90	06.05-	CS1432*	24 5.0
400 T 44 12.9	(Trakker)[F3BE0681C]	06.05-	CA1633IR	28 90	06.05-	CS1292	24 5.0
400 T 45 12.9	(Trakker)[F3BE3681C]	03.06-	CA1633IR	28 90	03.06-	CS1292	24 5.0 ND
					03.06-	CS1432*	24 5.0 MI
400 T 50 12.9	(Trakker)[F3BE3681B]	03.06-	CA1633IR	28 90	03.06-	CS1432*	24 5.0
					03.06-	CS1292	24 5.0
410 E 35 7.8	(Cursor)[F2BE0681A]	01.00- 11.04	CA2040IR	28 90	01.00- 11.04	CS1383	24 4.5
410 E 37 13.8	(EuroTrakker)[8210.42K(TCA)]	11.99- 11.04	CA1336IR	28 55	11.99- 11.04	CS526	24 6.5
		11.99- 11.04	CA1438IR	28 80	11.99- 11.04	CS564	24 6.5
					11.99- 11.04	CS1163	24 6.6
410 E 37 14.0	(EuroTrakker)[8210.42K]	04.92- 11.00	CA1336IR	28 55	01.94- 11.00	CS564	24 6.5
		04.92- 11.00	CA1438IR	28 80			
410 E 38 12.9	(Cursor)[F3BE0681G]	08.00- 11.04	CA1633IR	28 90	08.00- 08.05	CS1292	24 5.0
					08.05-	CS1432*	24 5.0
410 E 42 13.8	(EuroTrakker)[8210.42L(TCA)]	11.99- 11.04	CA1336IR	28 55	11.99- 11.04	CS526	24 6.5
		11.99- 11.04	CA1438IR	28 80	11.99- 11.04	CS1163	24 6.6
					11.99- 11.04	CS564	24 6.5
410 E 42 14.0	(EuroTrakker)[8210.42L]	04.92- 11.00	CA1336IR	28 55	04.92- 11.00	CS1163	24 6.6
		04.92- 11.00	CA1438IR	28 80			
410 E 44 12.9	(Cursor)[F3BE0681C]	08.00- 11.04	CA1633IR	28 90	08.00- 11.04	CS1292	24 5.0
					08.04-	CS1432*	24 5.0
410 T 36 7.8	(Trakker)[F2BE3681A]	03.06-	CA2040IR	28 90	03.06-	CS1383	24 4.5
410 T 38 12.9	(Trakker)[F3BE0681G]	04.05-	CA1633IR	28 90	04.05-	CS1292	24 5.0
410 T 41 12.9	(Trakker)[F3B3681D]	06.06-	CA1633IR	28 90	06.06-	CS1292	24 5.0
	[F3BE3681D]	03.06-	CA1633IR	28 90	06.06-	CS1432*	24 5.0
					03.06-	CS1432*	24 5.0
410 T 44 12.8	(Trakker)[F3BE0681C]	06.05-	CA1633IR	28 90	03.06-	CS1292	24 5.0
					06.05-	CS1432*	24 5.0
410 T 44 12.9	(Trakker)[F3BE0681C]	06.05-	CA1633IR	28 90	06.05-	CS1292	24 5.0
410 T 45 12.9	(Trakker)[F3B3681C]	06.06-	CA1633IR	28 90	06.06-	CS1292	24 5.0
	[F3BE3681C]	03.06-	CA1633IR	28 90	06.06-	CS1432*	24 5.0
					03.06-	CS1292	24 5.0
410 T 48 12.9	(Trakker)[F3BE0681E]	06.05-	CA1633IR	28 90	06.05-	CS1292	24 5.0
410 T 50 12.9	(Trakker)[F3BE0681B]	06.06-	CA1633IR	28 90	06.06-	CS1292	24 5.0
	[F3BE3681B]	03.06-	CA1633IR	28 90	06.06-	CS1432*	24 5.0
					03.06-	CS1292	24 5.0
410 T 54 12.9	(Trakker)[F3BE0681A]		CA1633IR	28 90		CS1292	24 5.0
440 E 31 7.8	(Cursor)[F2BE0681B]	08.00-	CA2040IR	28 90	08.00-	CS1383	24 4.5
440 E 34 9.5	(EuroTech)[8460.41K.406]	01.92-	CA1336IR	28 55	04.92- 12.00	CS502	24 5.4
	(EuroTrakker)[8460.41K]	01.92-	CA1438IR	28 80			
		01.94- 07.00	CA1336IR	28 55	01.94- 07.00	CS502	24 5.4
440 E 35 7.8	(Cursor)[F2BE0681A]	08.00-	CA2040IR	28 90	08.00-	CS1383	24 4.5
	(EuroTech)[F2BE0681A]	02.00-	CA2040IR	28 90	02.00-	CS1383	24 4.5
440 E 37 14.0	(EuroTrakker)[8210.42K]	04.92- 11.00	CA1336IR	28 55	01.93- 11.00	CS526	24 6.5
		04.92- 11.00	CA1438IR	28 80	01.93- 11.00	CS1163	24 6.6
					01.93- 11.00	CS564	24 6.5
440 E 38 12.9	(Cursor)[F3BE0681G]	01.01- 11.04	CA1633IR	28 90	01.01- 11.04	CS1292	24 5.0
440 E 38 9.5	(EuroStar)[8460.41L.5020]	01.94- 11.00	CA1336IR	28 55	01.94- 11.00	CS502	24 5.4
	[8460.41LTCA]	01.93- 02.02	CA1438IR	28 80	01.93- 02.02	CS502	24 5.4
		01.94- 02.02	CA1336IR	28 55			
	[8460.41N]	01.93- 02.02	CA1438IR	28 80	01.93- 02.02	CS502	24 5.4
		01.94- 02.02	CA1336IR	28 55			
	(EuroTech)[8460.41L.5020]	09.92- 11.00	CA1336IR	28 55	01.92- 11.00	CS502	24 5.4
	[8460.41LTCA]	04.93- 11.00	CA1336IR	28 55	01.93- 11.00	CS502	24 5.4
		04.93- 11.00	CA1438IR	28 80			
	[8460.41N]	01.92- 11.00	CA1336IR	28 55	01.92- 11.00	CS502	24 5.4
440 E 39 10.3	(EuroStar)[F3AE0681E]	11.99-	CA1633IR	28 90	11.99-	CS1292	24 5.0
	(EuroTech)[F3AE0681E]	11.99- 12.00	CA1336IR	28 55	11.99-	CS1432*	24 5.0
		11.99- 12.00	CA1438IR	28 80	11.99-	CS1292	24 5.0
		11.99-	CA1633IR	28 90	11.99-	CS1432*	24 5.0
440 E 40 10.3	(EuroStar)[F3AE0681B]	09.00-	CA1633IR	28 90	08.01- 09.04	CS1292	24 5.0
	(EuroTech)[F3AE0681B]	09.00-	CA1633IR	28 90	09.00-	CS1292	24 5.0
440 E 42 14.0	(EuroStar)[8210.42L]	01.93- 12.00	CA1336IR	28 55	01.93- 12.00	CS1163	24 6.6
	(EuroTech)[8210.42L.400]	04.92- 12.00	CA1336IR	28 55	04.92- 12.00	CS1163	24 6.6
	(EuroTrakker)[8210.42L]	04.92- 12.00	CA1336IR	28 55	01.97- 12.00	CS1163	24 6.6
		04.92- 12.00	CA1438IR	28 80			
440 E 43 10.3	(EuroStar)[F3AE0681D]	11.99- 02.02	CA1633IR	28 90	11.99- 02.02	CS1292	24 5.0
	(EuroTech)[F3AE0681D]	11.99- 08.03	CA1633IR	28 90	02.02-	CS1432*	24 5.0
					11.99- 08.03	CS1292	24 5.0
					08.03-	CS1432*	24 5.0
440 E 44 12.9	(Cursor)[F3BE0681C]	01.01- 11.04	CA1633IR	28 90	01.01- 11.04	CS1292	24 5.0
440 E 47 14.0	(EuroStar)[8210.42M.TCA]	01.93- 02.02	CA1336IR	28 55	01.93- 02.02	CS564	24 6.5
		01.93- 02.02	CA1438IR	28 80	01.93- 02.02	CS526	24 6.5
					01.95-	CS1163	24 6.6
440 E 48 12.9	(EuroStar)[F3BE0681E]	01.01-	CA1633IR	28 90	08.03-	CS1432*	24 5.0
					08.00- 08.03	CS1292	24 5.0



IVECO Continued

440 E 52 17.2	(EuroStar)[8280.42S.TCA]	01.93- 12.00	CA1336IR	28 55	01.93- 12.00	CS564	24 6.5
440 S 31 7.8	(Stralis)[F2BE0681B]	06.03-	CA2040IR	28 90	06.03-	CS1383	24 4.5
440 S 33 7.8	(Stralis)[F2BE3681B]	12.06-	CA2040IR	28 90	12.06-	CS1383	24 4.5
440 S 35 7.8	(Stralis)[F2BE0681A]	06.03-	CA2040IR	28 90	06.03-	CS1383	24 4.5
440 S 40 10.3	(Cursor)[F3AE0681B]	02.02-	CA1633IR	28 90	08.05- 02.02- 08.05	CS1432* CS1292	24 5.0 24 5.0
	(Stralis)[F3AE0681B]	06.03-	CA1633IR	28 90	06.03- 08.05	CS1292	24 5.0
440 S 42 10.3	(Stralis)[F3A3681B]	07.06-	CA1633IR	28 90	08.05- 07.06-	CS1432* CS1292	24 5.0 24 5.0
440 S 43 10.3	(Cursor)[F3AE0681D]	02.02-	CA1633IR	28 90	07.06- 02.02- 08.05	CS1432* CS1292	24 5.0 24 5.0
	(Stralis)[F3AE0681D]	06.03-	CA1633IR	28 90	08.05- 06.03- 08.05	CS1432* CS1292	24 5.0 24 5.0
440 S 45 10.3	(Stralis)[F3A3681A]	07.06-	CA1633IR	28 90	07.06- 07.06-	CS1432* CS1292	24 5.0 24 5.0
440 S 48 12.8	(Stralis)[F3BE0681E]	02.02-	CA1633IR	28 90	02.02-	CS1292	24 5.0
440 S 48 12.9	(Cursor)[F3BE0681E]	02.02-	CA1633IR	28 90	02.02- 08.05	CS1292	24 5.0
	(Stralis)[F3BE0681E]	02.02-	CA1633IR	28 90	08.05- 02.02- 08.05	CS1432* CS1292	24 5.0 24 5.0
440 S 50 12.9	(Stralis)[F3B3681B]	07.06-	CA1633IR	28 90	07.06- 07.06-	CS1432* CS1292	24 5.0 24 5.0
440 S 54 12.8	(Stralis)[F3BE0681A]	02.02-	CA1633IR	28 90	02.02-	CS1292	24 5.0
440 S 54 12.9	(Cursor)[F3BE0681A]	02.02-	CA1633IR	28 90	08.05- 02.02- 08.05	CS1432* CS1292	24 5.0 24 5.0
	(Stralis)[F3BE0681A]	02.02-	CA1633IR	28 90	02.02- 08.05	CS1292	24 5.0
440 S 56 12.9	(Stralis)[F3B3681A]	07.06-	CA1633IR	28 90	08.05- 07.06-	CS1432* CS1292	24 5.0 24 5.0
440 T 38 12.9	(Trakker)[F3BE0681G]	06.05-	CA1633IR	28 90	06.05-	CS1292	24 5.0
440 T 41 12.9	(Trakker)[F3BE3681D]	03.06-	CA1633IR	28 90	03.06- 03.06-	CS1292 CS1432*	24 5.0 24 5.0
440 T 44 12.9	(Trakker)[F3BE0681C]	06.05-	CA1633IR	28 90	06.05-	CS1292	24 5.0
440 T 45 12.9	(Trakker)[F3BE3681C]	03.06-	CA1633IR	28 90	03.06- 03.06-	CS1432* CS1292	24 5.0 24 5.0
440 T 50 12.9	(Trakker)[F3BE3681B]	03.06-	CA1633IR	28 90	03.06- 03.06-	CS1432* CS1292	24 5.0 24 5.0
50-10 4.6	(Zeta)[8340.04.200]	01.79- 10.83	CA212IR	28 27	01.79- 10.83	CS394	24 4.0
	[8340.04.250]	01.79- 10.83	CA212IR	28 27	01.79- 10.83	CS394	24 4.0
	[8340.04.300]	01.79- 10.83	CA212IR	28 27	01.79- 10.83	CS394	24 4.0
	[8340.04.362]	01.79- 10.83	CA212IR	28 27	01.79- 10.83	CS394	24 4.0
50-8 3.7	(Zeta)[8040.04.200]	01.83- 12.86	CA212IR	28 27	01.83- 12.86	CS231	24 3.2
50-9 3.9	(Zeta)[8040.05.230]	01.87- 03.91	CA212IR	28 27	01.87- 03.91	CS231	24 3.2
60 E 10 4.0	(EuroCargo)[8040.25B.4200LTC]	01.91- 05.96	CA1336IR	28 55	01.91- 05.96	CS231	24 3.2
		01.91- 05.96	CA1448IR	28 35			
60 E 12 4.0	(EuroCargo)[8040.25X.4000TC]	01.91- 05.96	CA1336IR	28 55	01.91- 05.96	CS231	24 3.2
		01.91- 05.96	CA1448IR	28 35			
60 E 13 3.9	(Tector)[F4AE0481D]	09.00- 09.00-	CA1699IR CA1812IR	28 70 28 90	09.00-	CS1268	24 4.0
60 E 14 3.9	(Tector)[F4AE3481C]	09.06- 09.06-	CA1699IR CA1812IR	28 70 28 90			
60 E 14 4.0	(EuroCargo)[8040.45.4000TCA]	01.91- 05.96	CA1336IR	28 55	01.91- 05.96	CS231	24 3.2
		01.91- 05.96	CA1448IR	28 35			
60 E 15 3.9	(Tector)[F4AE0481C]	09.00- 09.00-	CA1699IR CA1812IR	28 70 28 90	09.00-	CS1268	24 4.0
60 E 16 3.9	(Tector)[F4AE3481D]	09.06- 09.06-	CA1699IR CA1812IR	28 70 28 90			
60-10 4.6	(Zeta)[8340.04.200]	05.82- 12.86	CA212IR	28 27	05.82- 12.86	CS394	24 4.0
	[8340.04.250]	05.82- 12.86	CA212IR	28 27	05.82- 12.86	CS394	24 4.0
60-11 3.9	(Zeta)[8040.25.230R]	01.87- 03.91	CA212IR	28 27	01.87- 03.91	CS231	24 3.2
60-8 3.7	(Zeta)[8040.04.200]	01.79- 04.83	CA212IR	28 27	11.79- 04.83	CS231	24 3.2
60-9 3.9	(Zeta)[8040.05.200]	09.88- 12.92	CA326IR	28 55	09.88- 12.92	CS231	24 3.2
65 E 10 4.0	(EuroCargo)[8040.25B.4200LTC]	01.91- 05.96	CA1336IR	28 55	01.91- 05.96	CS231	24 3.2
		01.91- 05.96	CA1448IR	28 35			
65 E 12 4.0	(EuroCargo)[8040.25X.4000TC]	01.91- 05.96	CA1336IR	28 55	01.91- 05.96	CS231	24 3.2
		01.91- 05.96	CA1448IR	28 35			
65 E 13 3.9	(Tector)[F4AE0481D]	08.00- 08.03 09.00- 08.03	CA1699IR CA1812IR	28 70 28 90	09.00- 08.03	CS1268	24 4.0
65 E 14 3.9	(EuroCargo)[F4AE3481C]	09.06-	CA1699IR	28 70			
	(Tector)[F4AE3481C]	09.06- 09.06-	CA1812IR CA1699IR	28 90 28 70			
65 E 14 4.0	(EuroCargo)[8040.45.4000TCA]	01.91- 06.96	CA1336IR	28 55	01.91- 06.96	CS231	24 3.2
		01.91- 06.96	CA1448IR	28 35			
65 E 15 3.9	(Tector)[F4AE0481C]	09.00- 08.03 09.00- 08.03	CA1699IR CA1812IR	28 70 28 90	08.00- 08.03	CS1268	24 4.0
65 E 16 3.9	(EuroCargo)[F4AE3481D]	09.06-	CA1699IR	28 70			
	(Tector)[F4AE3481D]	09.06- 09.06-	CA1812IR CA1699IR	28 90 28 70			
65-10 4.6	(Zeta)[8340.04.200]	05.82- 01.87	CA212IR	28 27	05.82- 01.87	CS394	24 4.0
	[8340.04.250]	05.82- 01.87	CA212IR	28 27	05.82- 01.87	CS394	24 4.0
	[8340.04.300]	05.82- 01.87	CA212IR	28 27	05.82- 01.87	CS394	24 4.0
	[8340.04.350]	05.82- 01.87	CA212IR	28 27	05.82- 01.87	CS394	24 4.0
65-12 3.9	(Zeta)[8040.25.200]	01.87- 03.91	CA212IR	28 27	01.87- 03.91	CS231	24 3.2
65-9 3.9	(Zeta)[8040.05.230]	01.87- 03.91	CA212IR	28 27	01.87- 03.91	CS231	24 3.2
70-12 5.4	(Zeta)[8340.05.200]	01.83- 01.85	CA212IR	28 27	01.83- 01.85	CS394	24 4.0
70-14 5.7	(Zeta)[8060.05.246]	05.88- 06.91	CA212IR	28 27	05.88- 06.91	CS394	24 4.0
	[8060.05.285]	05.88- 06.91	CA212IR	28 27	05.88- 06.91	CS394	24 4.0
720 E 37 14.0	(EuroTrakker)[8210.42K]	09.93- 12.95	CA1336IR	28 55	09.93- 12.95	CS1163	24 6.6
		09.93- 12.95	CA1438IR	28 80			
720 E 42 14.0	(EuroTrakker)[8210.42L]	09.93- 12.00	CA1336IR	28 55	01.93- 11.04	CS1163	24 6.6
		09.93- 12.00	CA1438IR	28 80	01.93- 11.04	CS564	24 6.5
					01.94-	CS526	24 6.5
720 E 44 12.9	(Cursor)[F3BE0681C]	01.01- 11.04	CA1633IR	28 90	01.01- 11.04	CS1292	24 5.0
720 E 47 17.2	(EuroTrakker)[8210.42M.TCA]	04.92- 12.00	CA1336IR	28 55	04.92- 12.00	CS1163	24 6.6
		04.92- 12.00	CA1438IR	28 80			
720 E 48 12.9	(Cursor)[F3BE0681E]	01.01- 11.04	CA1633IR	28 90	01.01- 11.04	CS1292	24 5.0
720 T 38 12.9	(Trakker)[F3BE0681G]	06.05-	CA1633IR	28 90	06.05-	CS1292	24 5.0





720 T 41 12.9	(Trakker)[F3BE3681D]	03.06-	CA1633IR	28 90	03.06-	CS1292	24 5.0
					03.06-	CS1432*	24 5.0 MI
720 T 42 12.9	(Trakker)[F3BE0681V]	04.05-	CA1633IR	28 90	04.05-	CS1432*	24 5.0
720 T 44 12.9	(Trakker)[F3BE0681C]	06.05-	CA1633IR	28 90	06.05-	CS1292	24 5.0
720 T 45 12.9	(Trakker)[F3BE3681C]	03.06-	CA1633IR	28 90	03.06-	CS1432*	24 5.0 MI
					03.06-	CS1292	24 5.0 ND
720 T 48 12.9	(Trakker)[F3BE0681E]	06.05-	CA1633IR	28 90	06.05-	CS1292	24 5.0
720 T 50 12.9	(Trakker)[F3BE3681B]	03.06-	CA1633IR	28 90	03.06-	CS1432*	24 5.0
					03.06-	CS1292	24 5.0
75 E 12 4.0	(EuroCargo)[8040.25X.4000TC]	01.91- 05.96	CA1336IR	28 55	01.91- 05.96	CS231	24 3.2
		01.91- 05.96	CA1448IR	28 35			
		01.97-	CA1438IR	28 80			
75 E 13 3.9	(Tector)[F4AE0481D]	09.00- 08.03	CA1699IR	28 70	09.00- 08.03	CS1268	24 4.0
		09.00- 08.03	CA1812IR	28 90			
75 E 14 3.9	(Tector)[F4AE3481C]	09.06-	CA1699IR	28 70			
		09.06-	CA1812IR	28 90			
75 E 14 4.0	(EuroCargo)[8040.45.4000TCA]	01.91- 12.93	CA1336IR	28 55	01.91- 12.93	CS232	24 4.0
		01.91- 12.93	CA1448IR	28 35	01.91- 08.00	CS231	24 3.2
	[8040.45.4180TCA]	01.91- 08.00	CA1336IR	28 55	01.91- 08.00	CS231	24 3.2
					01.91- 12.93	CS232	24 4.0
75 E 15 3.9	(Tector)[F4AE0481C]	09.00- 08.03	CA1699IR	28 70	09.00- 08.03	CS1268	24 4.0
		09.00- 08.03	CA1812IR	28 90			
75 E 15 6.0	(EuroCargo)[8060.25R.4200LTC]	01.91- 09.00	CA1336IR	28 55	01.00- 09.00	CS1248	24 4.0
		01.91- 09.00	CA1448IR	28 35	01.91- 09.00	CS394	24 4.0
75 E 16 3.9	(EuroCargo)[F4AE3481D]	05.06-	CA1699IR	28 70			
		05.06-	CA1812IR	28 90			
	(Tector)[F4AE3481D]	09.06-	CA1699IR	28 70			
		09.06-	CA1812IR	28 90			
75 E 17 3.9	(Tector)[F4AE0481A]	09.00- 08.03	CA1699IR	28 70	09.00- 08.03	CS1268	24 4.0
		09.00- 08.03	CA1812IR	28 90			
75 E 18 5.9	(Tector)[F4AE0681E]	09.00- 08.03	CA1699IR	28 70	09.00- 08.03	CS1268	24 4.0
		09.00- 08.03	CA1812IR	28 90			
79-10 4.6	(Zeta)[8340.04.200]	01.83- 01.87	CA212IR	28 27	01.83- 01.87	CS394	24 4.0
	[8340.04.300]	01.83- 01.87	CA212IR	28 27	01.83- 01.87	CS394	24 4.0
79-12 3.9	(Zeta)[8040.25.200]	01.87- 03.91	CA212IR	28 27	01.87- 03.91	CS231	24 3.2
	[8040.25.220]	01.87- 03.91	CA212IR	28 27	01.87- 03.91	CS231	24 3.2
79-13 5.5	(Zeta)[8060.04.060]	01.83- 06.83	CA212IR	28 27	01.83- 06.83	CS232	24 4.0
	[8060.04.660]	01.83- 06.83	CA212IR	28 27	01.83- 06.83	CS232	24 4.0
79-14 5.5	(Zeta)[8060.04.660]	07.83- 11.85	CA212IR	28 27	07.83- 11.85	CS232	24 4.0
79-14 5.9	(Zeta)[8060.05.280]	12.85- 03.91	CA212IR	28 27	12.85- 06.88	CS232	24 4.0
					07.88- 03.91	CS394	24 4.0
80 E 15 3.9	(Tector)[F4AE0481C]	09.00- 08.03	CA1699IR	28 70	09.00- 08.03	CS1268	24 4.0
		09.00- 08.03	CA1812IR	28 90			
80 E 15 6.0	(EuroCargo)[8060.25R.4200LTC]	01.91- 08.00	CA1336IR	28 55	01.00- 08.00	CS1248	24 4.0
		01.91- 08.00	CA1448IR	28 35	01.91- 08.00	CS394	24 4.0
80 E 17 3.9	(Tector)[F4AE0481A]	09.00- 08.03	CA1699IR	28 70	09.00- 08.03	CS1268	24 4.0
		09.00- 08.03	CA1812IR	28 90			
80 E 18 3.9	(Tector)[F4AE3481B]	09.06-	CA1699IR	28 70			
		09.06-	CA1812IR	28 90			
80 E 18 5.9	(Tector)[F4AE0681E]	09.00- 08.03	CA1699IR	28 70	09.00- 08.03	CS1268	24 4.0
		09.00- 08.03	CA1812IR	28 90			
80 E 18 6.0	(EuroCargo)[8060.25V.4000TC]	01.91- 08.00	CA1336IR	28 55	01.91- 08.00	CS394	24 4.0
		01.91- 08.00	CA1448IR	28 35	01.00- 08.00	CS1248	24 4.0
80 E 21 5.9	(Tector)[F4AE0681D]	09.00- 08.03	CA1699IR	28 70	09.00- 08.03	CS1268	24 4.0
		09.00- 08.03	CA1812IR	28 90			
80 E 21 6.0	(EuroCargo)[8060.45.4100TCA]	01.91- 08.00	CA1336IR	28 55	01.00- 08.00	CS1248	24 4.0
		01.91- 08.00	CA1448IR	28 35	01.91- 08.00	CS394	24 4.0
	[8060.45.4180TCA]	01.91- 08.00	CA1336IR	28 55	01.91- 08.08	CS394	24 4.0
		01.91- 08.00	CA1448IR	28 35	01.00- 08.00	CS1248	24 4.0
80 EL 16 3.9	(EuroCargo)[F4AE3481D]	05.06-	CA1699IR	28 70			
		05.06-	CA1812IR	28 90			
80 EL 17 3.9	(Tector)[F4AE0481A]	09.00-	CA1699IR	28 70	09.00-	CS1268	24 4.0
		09.00-	CA1812IR	28 90			
80 EL 18 3.9	(Tector)[F4AE3481B]	09.06-	CA1699IR	28 70			
		09.06-	CA1812IR	28 90			
90 E 17 3.9	(Tector)[F4AE0481A]	09.00- 08.03	CA1699IR	28 70	09.00- 08.03	CS1268	24 4.0
		09.00- 08.03	CA1812IR	28 90			
90 E 18 5.9	(Tector)[F4AE0681E]	09.00- 08.03	CA1699IR	28 70	09.00- 08.03	CS1268	24 4.0
		09.00- 08.03	CA1812IR	28 90			
90 E 21 5.9	(Tector)[F4AE0681D]	09.00- 08.03	CA1699IR	28 70	09.00- 08.03	CS1268	24 4.0
		09.00- 08.03	CA1812IR	28 90			
90 E 22 5.9	(Tector)[F4AE3681B]	09.06-	CA1699IR	28 70			
		09.06-	CA1812IR	28 90			
95 E 15 6.0	(EuroCargo)[8060.25R.4750]	11.93- 12.94	CA1336IR	28 55	11.93- 12.94	CS394	24 4.0
		11.93- 12.94	CA1438IR	28 80			
		11.93- 12.94	CA1448IR	28 35			
	[8060.25R.4755]	11.93- 12.94	CA1336IR	28 55	11.93- 12.94	CS394	24 4.0
		11.93- 12.94	CA1438IR	28 80	01.00-	CS1248	24 4.0
		11.93- 12.94	CA1448IR	28 35			
	[8060.25R.4760]	11.93- 12.94	CA1336IR	28 55	11.93- 12.94	CS394	24 4.0
		11.93- 12.94	CA1438IR	28 80	01.00-	CS1248	24 4.0
		11.93- 12.94	CA1448IR	28 35			
	[8060.25R.4764]	11.93- 12.94	CA1336IR	28 55	11.93- 12.94	CS394	24 4.0
		11.93- 12.94	CA1438IR	28 80	01.00-	CS1248	24 4.0
		11.93- 12.94	CA1448IR	28 35			
	[8060.45.4702]				01.00-	CS1248	24 4.0
					11.93- 12.94	CS394	24 4.0
	[8060.45R.5050]	01.93- 08.00	CA1336IR	28 55	11.93- 08.00	CS394	24 4.0
		01.93- 08.00	CA1438IR	28 80	01.00- 08.00	CS1248	24 4.0
		01.93- 08.00	CA1448IR	28 35			
	[8060.45R.5051]	01.93- 08.02	CA1336IR	28 55	11.93- 08.02	CS394	24 4.0
		01.93- 08.02	CA1438IR	28 80	01.00- 08.02	CS1248	24 4.0
		01.93- 08.02	CA1448IR	28 35			
95 E 21 6.0	(EuroCargo)[8060.45.4700]	01.91- 12.00	CA1336IR	28 55	11.93- 12.00	CS394	24 4.0
		01.91- 12.00	CA1448IR	28 35	01.00- 12.00	CS1248	24 4.0
	[8060.45.4704]	01.91- 12.00	CA1336IR	28 55	11.93- 12.00	CS394	24 4.0
		01.91- 12.00	CA1448IR	28 35	01.00- 12.00	CS1248	24 4.0
	[8060.45.4706]	01.91- 12.00	CA1336IR	28 55	01.00- 12.00	CS1248	24 4.0
		01.91- 12.00	CA1448IR	28 35	11.93- 12.00	CS394	24 4.0
	[8060.45.4708]	01.91- 12.00	CA1336IR	28 55	01.00- 12.00	CS1248	24 4.0
		01.91- 12.00	CA1448IR	28 35	11.93- 12.00	CS394	24 4.0



VECO Continued

	[8060.45.5250]	01.91- 08.00 CA1336IR 28 55	01.00- 08.00 CS1248 24 4.0
		01.91- 08.00 CA1438IR 28 80	11.93- 08.00 CS394 24 4.0
		01.91- 08.00 CA1448IR 28 35	
	[8060.45.5251]	01.91- 08.00 CA1336IR 28 55	01.00- 08.00 CS1248 24 4.0
		01.91- 08.00 CA1438IR 28 80	11.93- 08.00 CS394 24 4.0
		01.91- 08.00 CA1448IR 28 35	
	[8060.45.5255]	01.91- 08.00 CA1336IR 28 55	11.93- 08.00 CS394 24 4.0
		01.91- 08.00 CA1438IR 28 80	01.00- 08.00 CS1248 24 4.0
		01.91- 08.00 CA1448IR 28 35	
95-14 5.5	(Zeta)[8060.04.669]	07.83- 10.85 CA212IR 28 27	07.83- 10.85 CS232 24 4.0
AS 260 12.9	(Stralis)[F3BE0681A]	02.02- CA1633IR 28 90	02.02- CS1292 24 5.0
M 115-17 5.5	[8060.24.601]	09.83- 12.85 CA212IR 28 27	09.83- 12.85 CS394 24 4.0
M 115-17 5.7	[8060.25.600]	01.86- 12.99 CA212IR 28 27	01.86- 12.99 CS394 24 4.0
M 115-17 5.9	[8060.25.600]	01.86- 12.99 CA212IR 28 27	01.86- 12.99 CS394 24 4.0
M 135-17 5.5	[8060.24.601]	09.83- 12.85 CA212IR 28 27	09.83- 12.85 CS394 24 4.0
M 135-17 5.9	[8060.25.600]	01.86- 08.92 CA212IR 28 27	01.86- 08.92 CS394 24 4.0
M 145-17 5.9	[8060.25.600]	02.86- 07.92 CA212IR 28 27	02.86- 07.92 CS394 24 4.0
M 159-17 8.1	[8360.05.254]	07.82- 09.86 CA212IR 28 27	07.82- 09.86 CS394 24 4.0
M 165-24 9.6	[8220.22.002]		06.82- 09.86 CS502 24 5.4
	[8220.22.102]		06.82- 09.86 CS502 24 5.4
M 175-17 5.9	[8060.25.600]	07.86- 12.92 CA212IR 28 27	09.86- 07.92 CS394 24 4.0
M 175-24 9.5	[8460.21.002]	09.86- 07.92 CA212IR 28 27	09.86- 07.92 CS502 24 5.4
	[8460.21.010]	09.86- 07.92 CA212IR 28 27	09.86- 07.92 CS502 24 5.4
MK 110-13 6.1	[BF6L913T]	01.83- 02.86 CA339IR 14 55	01.83- 03.85 CS114 12 2.4
		01.83- 02.86 CA340IR 14 65	04.85- 02.86 CS398 12 3.7
		03.86- 12.89 CA702IR 28 35	03.86- 12.91 CS530 24 4.0
			01.83- 03.85 CS103 12 2.7
	[F6L913]	01.83- 02.86 CA339IR 14 55	01.83- 03.85 CS114 12 2.4
		01.83- 02.86 CA340IR 14 65	01.83- 03.85 CS103 12 2.7
			04.85- 02.86 CS398 12 3.7
			03.86- 12.91 CS530 24 4.0
MK 110-16 6.1	[BF6L913]	01.83- 02.86 CA339IR 14 55	01.83- 02.86 CS398 12 3.7
		01.83- 02.86 CA340IR 14 65	03.86- 12.91 CS530 24 4.0
		03.86- 12.89 CA702IR 28 35	
		01.91- 12.91 CA501IR 28 55	
	[BF6L913T]	01.83- 12.85 CA1433IR 14 95	01.83- 12.85 CS530 24 4.0
		01.83- 12.85 CA339IR 14 55	01.83- 12.85 CS398 12 3.7
		01.83- 12.85 CA340IR 14 65	
		01.83- 12.85 CA501IR 28 55	
		01.83- 12.85 CA702IR 28 35	
	[F6L913]	01.83- 12.85 CA1433IR 14 95	01.83- 12.85 CS398 12 3.7
		01.83- 12.85 CA339IR 14 55	01.83- 12.85 CS530 24 4.0
		01.83- 12.85 CA340IR 14 65	
		01.83- 12.85 CA501IR 28 55	
		01.83- 12.85 CA702IR 28 35	
MK 130-13 6.1	[BF6L913T]	01.83- 02.86 CA339IR 14 55	04.85- 02.86 CS398 12 3.7
		01.83- 02.86 CA340IR 14 65	03.86- 05.89 CS530 24 4.0
		03.86- 05.89 CA341IR 28 27	01.83- 03.85 CS114 12 2.4
		03.86- 05.89 CA702IR 28 35	01.83- 03.85 CS103 12 2.7
	[F6L913]	01.83- 02.86 CA339IR 14 55	04.85- 02.86 CS398 12 3.7
		01.83- 02.86 CA340IR 14 65	01.83- 03.85 CS103 12 2.7
			01.83- 03.85 CS114 12 2.4
MK 130-16 6.1	[BF6L913]	01.83- 02.86 CA339IR 14 55	03.86- 12.91 CS530 24 4.0
		01.83- 02.86 CA340IR 14 65	01.83- 02.86 CS398 12 3.7
		03.86- 12.91 CA341IR 28 27	
		03.86- 10.91 CA702IR 28 35	
MK 75-9 4.1	[BF4L913T]	11.85- 10.87 CA341IR 28 27	11.85- 05.89 CS530 24 4.0
		11.87- 05.89 CA702IR 28 35	
	[F4L913]	01.83- 02.86 CA339IR 14 55	01.83- 02.86 CS114 12 2.4
		01.83- 02.86 CA340IR 14 65	
MK 80-13 6.1	[BF6L913T]	01.83- 02.86 CA339IR 14 55	01.83- 03.85 CS114 12 2.4
		01.83- 02.86 CA340IR 14 65	04.85- 02.86 CS398 12 3.7
		03.86- 12.89 CA702IR 28 35	03.86- 12.91 CS530 24 4.0
	[F6L913]	01.83- 02.86 CA339IR 14 55	01.83- 03.85 CS114 12 2.4
		01.83- 02.86 CA340IR 14 65	04.85- 02.86 CS398 12 3.7
		03.86- 12.89 CA702IR 28 35	03.86- 12.91 CS530 24 4.0
MK 80-16 6.1	[BF6L913]	01.83- 02.86 CA339IR 14 55	03.86- 12.91 CS530 24 4.0
		01.83- 02.86 CA340IR 14 65	01.83- 02.86 CS398 12 3.7
		03.86- 12.89 CA702IR 28 35	
MK 80-9 4.1	[F4L913]	01.83- 02.86 CA339IR 14 55	01.83- 02.86 CS114 12 2.4
		01.83- 02.86 CA340IR 14 65	
MK 90-13 6.1	[BF6L913T]	01.83- 02.86 CA339IR 14 55	03.86- 12.91 CS530 24 4.0
		01.83- 02.86 CA340IR 14 65	01.83- 03.85 CS114 12 2.4
		03.86- 12.91 CA702IR 28 35	04.85- 12.91 CS398 12 3.7
P/PA 120-13 6.2	[BF6L913T]	08.83- 02.88 CA341IR 28 27	08.83- 09.90 CS530 24 4.0
		03.88- 12.89 CA702IR 28 35	
	[F6L913]	01.83- 02.86 CA341IR 28 27	01.83- 02.86 CS530 24 4.0
P/PA 120-16 6.2	[BF6L913]	01.83- 02.88 CA341IR 28 27	01.83- 11.89 CS501 24 4.8
		03.88- 11.89 CA702IR 28 35	
P/PA 120-17 6.2	[BF6L913]	01.83- 11.89 CA341IR 28 27	01.83- 11.89 CS501 24 4.8
		03.88- 11.89 CA702IR 28 35	
P/PA 150-16 6.2	[BF6L913]	01.83- 02.88 CA341IR 28 27	01.83- 12.91 CS501 24 4.8
		03.88- 12.89 CA702IR 28 35	
P/PA 159-17 8.1	[8360.05.254]	07.82- 09.86 CA212IR 28 27	07.82- 09.86 CS394 24 4.0
P/PA 160-17 6.2	[BF6L913]	07.89- 07.96 CA702IR 28 35	07.89- 12.93 CS501 24 4.8
	[BF6L913/U]	07.89- 07.96 CA702IR 28 35	07.89- 07.96 CS501 24 4.8
P/PA 160-23 12.8	[BF8L513]	06.86- 05.89 CA341IR 28 27	06.86- 05.89 CS384 24 5.5
		06.86- 05.89 CA702IR 28 35	
	[F8L413F]	04.84- 05.89 CA341IR 28 27	
		01.85- 05.89 CA702IR 28 35	
P/PA 160-30 12.8	[BF8L513]	06.86- 02.88 CA341IR 28 27	06.86- 05.89 CS384 24 5.5
		03.88- 05.89 CA702IR 28 35	
P/PA 170-23 13.4	[F8L513]	04.88- 07.96 CA702IR 28 35	
			04.88- 07.91 CS384 24 5.5
P/PA 170-25 13.4	[F8L513]	03.89- 12.93 CA702IR 28 35	03.89- 07.91 CS384 24 5.5
P/PA 170-34 12.8	[BF8L513]	04.89- 07.91 CA702IR 28 35	04.89- 07.91 CS384 24 5.5
P/PA 180-23 13.4	[F8L513]	01.91- 12.93 CA501IR 28 55	07.91- 07.00 CS384 24 5.5
		01.91- 12.93 CA702IR 28 35	
P/PA 180-25 13.4	[F8L513]	01.91- 07.00 CA501IR 28 55	07.91- 07.00 CS384 24 5.5
		01.91- 07.00 CA702IR 28 35	
P/PA 180-34 12.8	[BF8L513]	07.91- 07.00 CA501IR 28 55	07.91- 07.00 CS384 24 5.5
P/PA 190-25 12.8	[F8L413F]	07.83- 06.86 CA341IR 28 27	07.83- 09.90 CS384 24 5.5
P/PA 190-30 13.8	[8210.22.175]	04.87- 01.99 CA1336IR 28 55	04.87- 01.99 CS526 24 6.5
		04.87- 01.99 CA212IR 28 27	
		04.87- 01.99 CA326IR 28 55	
	[8210.22.210]	04.87- 12.90 CA1336IR 28 55	04.87- 12.92 CS121 24 6.0
		04.87- 09.97 CA212IR 28 27	
		Eng. 461335- 09.87- 09.97 CA1336IR 28 55	
		Eng. -461334 09.87- 09.97 CA326IR 28 55	



[8210.22.236]		04.87- 12.90	CA1336IR	28 55		04.87- 12.92	CS121	24 6.0
		04.87- 09.97	CA212IR	28 27				
		Eng. 461335- 09.87- 09.97	CA1336IR	28 55				
		Eng. -461334 09.87- 09.97	CA326IR	28 55				
[8210.22.511]		09.87- 09.97	CA212IR	28 27		09.87- 09.97	CS526	24 6.5
		Eng. 461335- 09.87- 09.97	CA1336IR	28 55				
		Eng. -461334 09.87- 09.97	CA326IR	28 55				
[8210.22.521]		09.87- 09.97	CA212IR	28 27		01.87- 09.97	CS526	24 6.5
		Eng. 461335- 09.87- 09.97	CA1336IR	28 55				
		Eng. -461334 09.87- 09.97	CA326IR	28 55				
[8210.22.523]		09.87- 09.97	CA212IR	28 27		09.87- 09.97	CS526	24 6.5
		Eng. 461335- 09.87- 09.97	CA1336IR	28 55				
		Eng. -461334 08.87- 09.97	CA326IR	28 55				
[8210.22.525]		09.87- 09.97	CA212IR	28 27		09.87- 09.97	CS526	24 6.5
		Eng. 461335- 09.87- 09.97	CA1336IR	28 55				
		Eng. -461334 09.87- 09.97	CA326IR	28 55				
[8210.22.535]		09.87- 09.97	CA212IR	28 27		09.87- 09.97	CS526	24 6.5
		Eng. 461335- 09.87- 09.97	CA1336IR	28 55				
		Eng. -461334 09.87- 09.97	CA326IR	28 55				
[8210.22.537]		09.87- 09.97	CA212IR	28 27		09.87- 09.97	CS526	24 6.5
		Eng. 461335- 09.87- 09.97	CA1336IR	28 55				
		Eng. -461334 09.87- 09.97	CA326IR	28 55				
P/PA 190-32 16.0	[F10L413F]	01.83- 12.85	CA341IR	28 27				
P/PA 260-25 12.8	[F8L413F]	07.83- 06.86	CA341IR	28 27		07.83- 06.86	CS384	24 5.5
P/PA 260-25 13.4	[F8L513]	04.89- 12.99	CA702IR	28 35		04.89- 12.99	CS384	24 5.5
P/PA 260-30 12.8	[BF8L513]	06.86- 02.88	CA341IR	28 27		06.86- 05.90	CS384	24 5.5
		06.86- 05.90	CA501IR	28 55				
		03.88- 12.89	CA702IR	28 35				
P/PA 260-32 16.0	[F10L413F]	01.83- 12.85	CA341IR	28 27				
P/PA 260-34 12.8	[BF8L513]	04.89- 12.99	CA702IR	28 35		04.89- 12.99	CS384	24 5.5
P/PA 300-30 12.8	[BF8L513]	04.87- 05.89	CA501IR	28 55		04.87- 05.89	CS384	24 5.5
P/PA 330-30 12.8	[BF8L513]	05.86- 02.88	CA341IR	28 27		05.86- 09.90	CS384	24 5.5
		03.88- 12.89	CA702IR	28 35				
P/PA 330-30 13.8	[8210.22X.069]	10.87- 12.95	CA212IR	28 27		10.87- 12.95	CS121	24 6.0
	[8210.22X.235]	01.84- 07.96	CA212IR	28 27		06.84- 12.92	CS121	24 6.0
		02.90- 12.92	CA326IR	28 55				
		01.91- 12.92	CA1336IR	28 55				
	[8210.22X.523]	06.84- 12.92	CA212IR	28 27		06.84- 12.92	CS121	24 6.0
		02.90- 12.92	CA326IR	28 55				
	[8210.22X.575]	10.87- 12.95	CA212IR	28 27		10.87- 12.95	CS121	24 6.0
P/PA 330-36 13.8	[8210.42.210]	10.91- 12.99	CA326IR	28 55		10.91- 12.99	CS526	24 6.5
	[8210.42.235]	10.91- 12.99	CA326IR	28 55		10.91- 12.99	CS526	24 6.5
	[8210.42.237]	10.91- 12.99	CA326IR	28 55		10.91- 12.99	CS526	24 6.5
	[8210.42.269]	10.91- 12.99	CA326IR	28 55		10.91- 12.99	CS526	24 6.5
	[8210.42.270]	10.91- 12.99	CA326IR	28 55		10.91- 12.99	CS526	24 6.5
	[8210.42.271]	10.91- 12.99	CA326IR	28 55		10.91- 12.99	CS526	24 6.5
P/PA 340-34 12.8	[BF8L513]	03.89- 12.98	CA702IR	28 35		03.89- 12.98	CS384	24 5.5
<b>MARINE</b>								
8041 3.9	[8041SRM15.10]					01.90- 12.00	CS572	12 2.5
8141 2.4	[8141SRM1300]					09.91- 12.01	CS572	12 2.5
8210 13.9	[8210M22.10]	01.90- 12.00	CA212IR	28 27		01.90- 12.00	CS564	24 6.5
		01.90- 12.00	CA326IR	28 55				
8281 17.0	[8281M32.10]	01.90- 12.00	CA326IR	28 55		01.90- 12.00	CS564	24 6.5
8282 17.0	[8282.02... 22...]	01.92- 12.02	CA326IR	28 55		01.92- 12.02	CS564	24 6.5
8361 8.0	[8361.25.540...]	01.92- 12.02	CA326IR	28 55		01.92- 12.02	CS394	24 4.0
8460 9.5	[5460.41.970]	10.89- 12.99	CA326IR	28 55		10.89- 12.99	CS502	24 5.4
<b>MOTORS</b>								
8040 3.9	[8040.25.900]					06.87- 12.99	CS572	12 2.5
8041 3.7	[8041.04...]					07.83- 12.84	CS231	24 3.2
						07.83- 12.84	CS572	12 2.5
8041 3.9	[8041.05...]	06.86- 09.88	CA355IR	14 65		06.86- 09.88	CS240	12 3.0
						10.89- 12.00	CS231	24 3.2
						06.86- 08.88	CS232	24 4.0
						06.87- 12.00	CS572	12 2.5
8051 4.9	[8051.05...]					01.84- 12.00	CS232	24 4.0
						01.84- 12.00	CS240	12 3.0
8061 5.5	[8061.04...]					06.83- 09.86	CS232	24 4.0
						06.83- 09.86	CS240	12 3.0
8061 5.9	[8061...]	01.86- 12.00	CA326IR	28 55		01.86- 12.00	CS240	12 3.0
		01.86- 12.00	CA326IR	28 55		01.86- 12.00	CS572	12 2.5
8141 2.4	[8141...]	01.90- 08.93	CA255IR	14 45		01.90- 12.01	CS230	12 2.5
8210 13.0	[8210.22.170]					01.90- 12.00	CS564	24 6.5
8210 13.8	[8210...]	03.85- 12.00	CA212IR	28 27		03.85- 12.00	CS564	24 6.5
8215 13.8	[8215.22.545]	01.87- 12.00	CA212IR	28 27				
8217 13.8	[8217.32.036]					01.91- 12.01	CS564	24 6.5
8281 17.0	[8281.22... 42...]	03.90- 12.00	CA212IR	28 27		03.90- 12.02	CS564	24 6.5
8281 17.2	[8281.02... 22...]	06.83- 12.05	CA326IR	28 55		06.83- 12.05	CS564	24 6.5
8360 8.1	[8360.05.200]					06.83- 12.00	CS394	24 4.0
8361 8.1	[8361.25...]	06.83- 12.00	CA326IR	28 55		06.83- 12.00	CS682	12 3.0
		07.86- 12.00	CA355IR	14 65				
8460 9.5	[8460SI...]	10.89- 12.99	CA212IR	28 27		10.89- 12.99	CS502	24 5.4
<b>Jeep</b>								
<b>PASSENGER CARS EU</b>								
S-type 2.5 V6		AT 04.02- 12.99	CA2073IR*	14 120				
S-type 3.0 V6	[AJ-V6]	AT 10.98- 12.99	CA2073IR*	14 120				
XJ 12 5.3	[7P]	10.86- 12.92	CA626IR	14 75				
	[V12]	09.81- 12.92	CA626IR	14 75				
		08.86- 09.89	CA626IR	14 75				
XJ 12 5.3 Sovereign	[V12]	07.85- 12.92	CA626IR	14 75				
XJ 6 2.9	[AJ6]	10.86- 08.90	CA324IR	14 90		10.86- 08.90	CS588#	12 1.4
XJ 6 3.0	[AJ-V6]	05.03- 12.99	CA2073IR*	14 120				
XJ 6 3.2 24V	[9BPMNA]					09.90- 11.94	CS588#	12 1.4
XJ 6 3.4	[XK3.4]					05.75- 10.86	CS591#	12 1.4
XJ 6 3.6	[9DPANA]					10.86- 08.89	CS588#	12 1.4
	[AJ6]					10.86- 08.89	CS588#	12 1.4
	[AJ6.4]	10.86- 08.89	CA324IR	14 90		10.86- 08.89	CS588#	12 1.4
XJ 6 4.2	[8L]	09.85- 12.86	CA626IR	14 75		09.85- 12.86	CS591#	12 1.4
	[XK4.2]	01.82- 01.86	CA626IR	14 75		01.75- 12.87	CS591#	12 1.4
		09.85- 12.86	CA626IR	14 75		10.69- 12.86	CS591#	12 1.4
XJ S 3.6	[9DPALA]	01.88- 05.91	CA626IR	14 75		01.88- 05.91	CS588#	12 1.4
	[9DPANA]	01.88- 05.91	CA626IR	14 75		01.88- 05.91	CS588#	12 1.4
	[AJ6]	10.83- 12.89	CA626IR	14 75		10.86- 12.89	CS588#	12 1.4
XJ S 4.0	[9LPFRB]					07.94- 03.96	CS588#	12 1.4
XJ S 5.3	[8C]	01.88- 06.91	CA626IR	14 75				
		01.86- 12.89	CA626IR	14 75				
XJ S 5.3 HE	[8S]	01.86- 12.89	CA626IR	14 75				
	[V12]	07.81- 12.87	CA626IR	14 75				
XJ SC 3.6	[AJ6]	10.86- 12.88	CA626IR	14 75		10.86- 12.88	CS588#	12 1.4
XJ SC 4.0	[9EPCNA]					05.91- 09.94	CS588#	12 1.4



**JAGUAR Continued**

XJ SC 5.3	[V12]	01.88- 05.92	CA626IR	14 75			
XJ SC 5.3 HE	[8S]	07.85- 05.92	CA626IR	14 75			
	[V12]	09.85- 12.90	CA626IR	14 75			
		01.86- 05.88	CA626IR	14 75			
X-type 2.0 V6					03.02-	CS961	12 1.4
X-type 2.0 Diesel	[R4-X404]	07.03- 10.05	CA1638IR	14 115	07.03-	CS1245	12 2.1
X-type 2.2 Diesel		10.05-	CA1638IR	14 115	10.05-	CS1245	12 2.1
X-type 2.5 V6					06.01-	CS961	12 1.4
X-type 3.0 V6					06.01-	CS961	12 1.4
<b>PASSENGER CARS US</b>							
Vanden Plas 3.6		01.88- 01.89	CA626IR	14 75			
Vanden Plas 4.2		01.82- 01.87	CA626IR	14 75			
XJ 4.2		01.71- 01.71	CA17v	14 34			
XJ 6 4.2		01.72- 01.74	CA17v	14 34			
XJ 6 4.2 C		01.75- 01.77	CA17v	14 34			
XJ 6 4.2 L		01.75- 01.77	CA17v	14 34			
XJS 5.3		01.81- 01.81	CA626IR	14 75			
XJS 5.3 C		01.86- 01.88	CA626IR	14 75			
X-type 2.5					01.02- 01.03	CS961	12 1.4
X-type 3.0					01.02- 01.03	CS961	12 1.4
<b>JCB</b>							
<b>INDUSTRY</b>							
Various Models					01.85-	CS1471	12 2.0
<b>Jeep</b>							
<b>PASSENGER CARS EU</b>							
Cherokee 2.1 TD	[J8S]				10.84- 12.86	CS353	12 3.1
Cherokee 2.5 i	[EPE]	12.91- 05.02	UA960	14 90	06.94- 11.96	CS1175	12 1.2
	[HX]	12.91- 11.96	UA960	14 90	12.91- 05.02	CS1036	12 1.4
					12.91- 05.94	CS1036	12 1.4
					06.94- 11.96	CS1175	12 1.2
		11.96- 01.98	UA960	14 90	11.96-	CS1175	12 1.2
Cherokee 2.5 TD	[VMHR425CLR[X]				09.96-	CS1180	12 2.2
					09.94- 08.96	CS611	12 2.2
Cherokee 2.5 CRD					03.01- 12.02	CS1507*	12 2.2
Cherokee 2.8 CRD					11.02-	CS1507*	12 2.2
Cherokee 4.0 i	[ERH]	01.88- 01.91	UA923IR	14 100	01.88- 04.01	JS1006	12 1.2
		01.91- 04.01	UA960	14 90 ▲			
	[MX]	12.91- 08.96	UA960	14 90	12.91- 08.96	JS1006	12 1.2
					07.98-	JS1006	12 1.2
CJ5 - CJ8 2.5		01.81- 01.86	UA943IR	14 60			
		AC 01.83- 01.86	UA945IR	14 65			
Comanche 4.0					10.90- 09.96	JS1006	12 1.2
Grand Cherokee 2.5 TD	[M51]				10.95- 04.99	CS611	12 2.2
	[M52]				10.95- 04.99	CS611	12 2.2
Grand Cherokee 2.7 CRD 4x4	[ENF]				10.01-	CS1481*	12 2.2
Grand Cherokee 4.0	[ERH]				04.99-	JS1006	12 1.2
Grand Cherokee 4.0 AWD	[ERH]	09.92- 04.99	UA960	14 90	09.91-	JS1006	12 1.2
Grand Cherokee 4.0 i	[MX]	09.91- 04.99	UA960	14 90	09.91- 12.96	JS1006	12 1.2
	[S01]	10.95- 04.99	UA960	14 90	10.95- 04.99	JS1006	12 1.2
Grand Cherokee 5.2	[Y01]	10.95- 04.99	UA960	14 90			
Grand Cherokee 5.2 AWD	[ELF]	01.98- 04.99	UA960	14 90			
Grand Cherokee 5.2 i	[Y]	01.92- 04.99	UA960	14 90			
Wrangler 2.5	[P00]	08.96- 01.98	UA960	14 90	08.96- 01.98	CS1175	12 1.2
		01.91- 08.96	UA960	14 90	01.88- 05.94	CS1036	12 1.4
		01.88- 01.91	UA945IR	14 65	06.94- 08.96	CS1175	12 1.2
Wrangler 4.0	[ERH]				01.97- 12.02	JS1006	12 1.2
	[S01]	08.96- 01.98	UA960	14 90	08.96- 01.98	JS1006	12 1.2
		12.91- 08.96	UA960	14 90	12.91- 08.96	JS1006	12 1.2
Wrangler 4.2	[6L<C2V>]	01.86- 01.89	UA945IR	14 65			
<b>PASSENGER CARS US</b>							
Cherokee 2.1 Turbo					01.85- 01.87	CS353	12 3.1
Cherokee 2.1 Turbo Chief					01.86- 01.87	CS353	12 3.1
Cherokee 2.1 Turbo Laredo					01.86- 01.87	CS353	12 3.1
Cherokee 2.1 Turbo Pioneer					01.86- 01.87	CS353	12 3.1
Cherokee 2.5		01.84- 01.87	UA945IR	14 65	01.86- 01.93	CS1036	12 1.4
		01.84- 01.87	UA943IR	14 60	01.98- 01.98	CS1175	12 1.2
		01.88- 01.90	UA947IR	14 60			
Cherokee 2.5 Chief		01.88-	UA947IR	14 60	01.86- 01.87	CS1036	12 1.4
		01.86- 01.87	UA943IR	14 60			
		01.86- 01.87	UA945IR	14 65			
Cherokee 2.5 Laredo		01.86- 01.87	UA945IR	14 65	01.86- 01.89	CS1036	12 1.4
		01.86- 01.87	UA943IR	14 60			
		01.88- 01.89	UA947IR	14 60			
Cherokee 2.5 Pioneer		01.86- 01.87	UA943IR	14 60	01.86- 01.89	CS1036	12 1.4
		01.86- 01.87	UA945IR	14 65			
		01.88- 01.89	UA947IR	14 60			
Cherokee 2.5 SE					01.94- 01.97	CS1175	12 1.2
					01.94- 01.97	CS1036	12 1.4
Cherokee 2.8		01.84- 01.86	UA945IR	14 65	01.84- 01.86	US858	12
		01.84- 01.86	UA943IR	14 60			
Cherokee 2.8 Chief		01.86- 01.86	UA943IR	14 60	01.86- 01.86	US858	12
		01.86- 01.86	UA945IR	14 65			
Cherokee 2.8 Laredo		01.86- 01.86	UA943IR	14 60	01.86- 01.86	US858	12
		01.86- 01.86	UA945IR	14 65			
Cherokee 2.8 Pioneer		01.86- 01.86	UA943IR	14 60	01.86- 01.86	US858	12
		01.86- 01.86	UA945IR	14 65			
Cherokee 4.0		01.87- 01.90	UA923IR	14 100	01.87- 01.98	JS1006	12 1.2
Cherokee 4.0 Briarwood					01.91- 01.92	JS1006	12 1.2
Cherokee 4.0 Chief		01.87- 01.88	UA923IR	14 100	01.87- 01.88	JS1006	12 1.2
Cherokee 4.0 Country					01.93- 01.97	JS1006	12 1.2
Cherokee 4.0 Laredo		01.87- 01.90	UA923IR	14 100	01.87- 01.92	JS1006	12 1.2
Cherokee 4.0 Limited		01.87- 01.90	UA923IR	14 100	01.87- 01.92	JS1006	12 1.2
Cherokee 4.0 Pioneer		01.87- 01.90	UA923IR	14 100	01.87- 01.90	JS1006	12 1.2
Cherokee 4.0 SE					01.94- 01.97	JS1006	12 1.2
Cherokee 4.0 Sport		01.90- 01.90	UA923IR	14 100	01.90- 01.97	JS1006	12 1.2
Cherokee 4.2		01.77- 01.83	UA943IR	14 60			
Cherokee 5.9							
		01.81- 01.83	UA943IR	14 60			
Cherokee 6.6							
CJ3 3.7		01.66- 01.66	UA916#	14 60	01.66- 01.66	US818	12 1.5
CJ5 2.5		01.80- 01.83	UA943IR	14 60			
CJ5 3.7		01.66- 01.71	UA916#	14 60	01.66- 01.71	US818	12 1.5
CJ5 3.8		01.77- 01.78	UA943IR	14 60			
CJ5 4.2		01.77- 01.83	UA943IR	14 60			



CJ5 5.0	01.81- 01.81	UA943IR	14 60				
CJ6 3.7	01.66- 01.71	UA916#	14 60		01.66- 01.71	US818	12 1.5
CJ7 2.5	01.83- 01.86	UA945IR	14 65				
	01.80- 01.86	UA943IR	14 60				
CJ7 3.8	01.76- 01.78	UA943IR	14 60				
CJ7 4.2	01.76- 01.86	UA943IR	14 60				
CJ7 5.0							
	01.78- 01.81	UA943IR	14 60				
Comanche 2.1 Turbo					01.87- 01.87	CS353	12 3.1
Comanche 2.1 Turbo Custom					01.86- 01.86	CS353	12 3.1
Comanche 2.1 Turbo Laredo					01.87- 01.87	CS353	12 3.1
Comanche 2.1 Turbo Pioneer					01.87- 01.87	CS353	12 3.1
Comanche 2.1 Turbo X					01.86- 01.86	CS353	12 3.1
Comanche 2.1 Turbo XLS					01.86- 01.86	CS353	12 3.1
Comanche 2.5	01.87- 01.90	UA947IR	14 60		01.87- 01.92	CS1036	12 1.4
Comanche 2.5 Chief	01.87- 01.88	UA947IR	14 60		01.87- 01.88	CS1036	12 1.4
Comanche 2.5 Custom	01.86- 01.86	UA943IR	14 60		01.86- 01.86	CS1036	12 1.4
	01.86- 01.86	UA945IR	14 65				
Comanche 2.5 Laredo	01.87- 01.88	UA947IR	14 60		01.87- 01.88	CS1036	12 1.4
Comanche 2.5 Pioneer	01.87- 01.90	UA947IR	14 60		01.87- 01.91	CS1036	12 1.4
Comanche 2.5 X	01.86- 01.86	UA943IR	14 60		01.86- 01.86	CS1036	12 1.4
	01.86- 01.86	UA945IR	14 65				
Comanche 2.5 XLS	01.86- 01.86	UA945IR	14 65		01.86- 01.86	CS1036	12 1.4
	01.86- 01.86	UA943IR	14 60				
Comanche 2.8 Custom					01.86- 01.86	US858	12
Comanche 2.8 X					01.86- 01.86	US858	12
Comanche 2.8 XLS					01.86- 01.86	US858	12
Comanche 4.0	01.87- 01.90	UA923IR	14 100		01.87- 01.92	JS1006	12 1.2
Comanche 4.0 Chief	01.87- 01.88	UA923IR	14 100		01.87- 01.88	JS1006	12 1.2
Comanche 4.0 Eliminator	01.88- 01.90	UA923IR	14 100		01.88- 01.92	JS1006	12 1.2
Comanche 4.0 Laredo	01.87- 01.88	UA923IR	14 100		01.87- 01.88	JS1006	12 1.2
Comanche 4.0 Pioneer	01.87- 01.90	UA923IR	14 100		01.87- 01.92	JS1006	12 1.2
Commando 3.7	01.66- 01.67	UA916#	14 60				
Dispatcher 3.7	01.66- 01.67	UA916#	14 60				
DJ5 2.2	01.68- 01.71	UA916#	14 60				
DJ5 3.7	01.66- 01.70	UA916#	14 60		01.68- 01.70	US818	12 1.5
DJ6 3.7	01.66- 01.68	UA916#	14 60		01.68- 01.68	US818	12 1.5
FC150 3.7	01.66- 01.66	UA916#	14 60				
FC170 3.7	01.66- 01.66	UA916#	14 60				
Gladiator 5.4					01.65- 01.67	US818	12 1.5
Grand Cherokee 4.0					01.93- 01.93	JS1006	12 1.2
Grand Cherokee 4.0 Laredo					01.93- 01.98	JS1006	12 1.2
Grand Cherokee 4.0 Limited					01.93- 01.98	JS1006	12 1.2
Grand Cherokee 4.0 Orvis					01.95- 01.97	JS1006	12 1.2
Grand Cherokee 4.0 SE					01.94- 01.95	JS1006	12 1.2
Grand Wagoneer 4.2	01.84- 01.86	UA943IR	14 60				
	01.84- 01.86	UA945IR	14 65				
Grand Wagoneer 5.9	01.84- 01.91	UA945IR	14 65		01.89- 01.91	JS1006	12 1.2
J10 4.2	01.77- 01.87	UA943IR	14 60				
J10 5.9	01.82- 01.88	UA943IR	14 60		01.88- 01.88	JS1006	12 1.2
	01.88- 01.88	UA945IR	14 65				
J10 6.6							
J-100 5.4					01.68- 01.68	US818	12 1.5
J-100 5.7					01.69- 01.71	US818	12 1.5
J20 5.9	01.88- 01.88	UA945IR	14 65		01.88- 01.88	JS1006	12 1.2
	01.82- 01.88	UA943IR	14 60				
J20 6.6							
J-2500 5.4					01.68- 01.68	US818	12 1.5
J-2500 5.7					01.69- 01.71	US818	12 1.5
J-2600 5.4					01.68- 01.68	US818	12 1.5
J-2600 5.7					01.69- 01.70	US818	12 1.5
J-2700 5.4					01.68- 01.68	US818	12 1.5
J-2700 5.7					01.69- 01.70	US818	12 1.5
J-2800 5.4					01.68- 01.68	US818	12 1.5
J-3500 5.4					01.68- 01.68	US818	12 1.5
J-3500 5.7					01.69- 01.70	US818	12 1.5
J-3600 5.4					01.68- 01.68	US818	12 1.5
J-3600 5.7					01.69- 01.70	US818	12 1.5
J-3700 5.4					01.68- 01.68	US818	12 1.5
J-3700 5.7					01.69- 01.70	US818	12 1.5
J-3800 5.4					01.68- 01.68	US818	12 1.5
J-3800 5.7					01.69- 01.70	US818	12 1.5
Jeepster 2.2	01.67- 01.69	UA916#	14 60				
Jeepster 2.2 Commando	01.68- 01.71	UA916#	14 60				
Jeepster 3.7	01.66- 01.67	UA916#	14 60		01.66- 01.69	US818	12 1.5
Jeepster 3.7 Commando					01.68- 01.71	US818	12 1.5
Scrambler 2.5	01.83- 01.85	UA945IR	14 65				
	01.81- 01.85	UA943IR	14 60				
Scrambler 4.2	01.81- 01.85	UA943IR	14 60				
Universal 3.7	01.66- 01.67	UA916#	14 60				
Wagoneer 2.1 Turbo					01.85- 01.85	CS353	12 3.1
Wagoneer 2.5	01.84- 01.87	UA943IR	14 60		01.86- 01.93	CS1036	12 1.4
	01.84- 01.90	UA945IR	14 65				
Wagoneer 2.5 Islander	01.89- 01.90	UA945IR	14 65		01.89- 01.91	CS1036	12 1.4
Wagoneer 2.5 Laredo	01.87- 01.88	UA945IR	14 65		01.87- 01.88	CS1036	12 1.4
Wagoneer 2.5 Limited	01.86- 01.87	UA943IR	14 60		01.86- 01.87	CS1036	12 1.4
	01.86- 01.87	UA945IR	14 65				
Wagoneer 2.5 Rio Grande					01.95- 01.95	CS1175	12 1.2
Wagoneer 2.5 S	01.88- 01.88	UA945IR	14 65		01.88- 01.94	CS1036	12 1.4
Wagoneer 2.5 Sahara	01.88- 01.90	UA945IR	14 65		01.88- 01.91	CS1036	12 1.4
Wagoneer 2.5 SE					01.94- 01.97	CS1036	12 1.4
					01.94- 01.97	CS1175	12 1.2
Wagoneer 2.5 Sport	01.87- 01.88	UA945IR	14 65		01.87- 01.88	CS1036	12 1.4
Wagoneer 2.8	01.84- 01.86	UA943IR	14 60				
	01.84- 01.86	UA945IR	14 65				
Wagoneer 2.8 Limited	01.86- 01.86	UA943IR	14 60				
	01.86- 01.86	UA945IR	14 65				
Wagoneer 4.0	01.87- 01.87	UA923IR	14 100		01.87- 01.93	JS1006	12 1.2
Wagoneer 4.0 Islander					01.91- 01.92	JS1006	12 1.2
Wagoneer 4.0 Limited	01.87- 01.90	UA923IR	14 100		01.87- 01.90	JS1006	12 1.2
Wagoneer 4.0 Renegade					01.91- 01.94	JS1006	12 1.2



**JEEP Continued**

Wagoneer 4.0 S						01.92- 01.92	JS1006	12	1.2
Wagoneer 4.0 Sahara						01.91- 01.97	JS1006	12	1.2
Wagoneer 4.0 SE						01.94- 01.95	JS1006	12	1.2
Wagoneer 4.0 Sport						01.97- 01.97	JS1006	12	1.2
Wagoneer 4.2		01.87- 01.90	UA945IR	14	65	01.88- 01.90	JS1006	12	1.2
		01.80- 01.90	UA943IR	14	60				
Wagoneer 4.2 Islander		01.88- 01.90	UA943IR	14	60	01.88- 01.90	JS1006	12	1.2
		01.88- 01.90	UA945IR	14	65				
Wagoneer 4.2 Laredo		01.87- 01.90	UA943IR	14	60	01.88- 01.90	JS1006	12	1.2
		01.87- 01.90	UA945IR	14	65				
Wagoneer 4.2 S		01.88- 01.88	UA945IR	14	65	01.88- 01.88	JS1006	12	1.2
		01.88- 01.88	UA943IR	14	60				
Wagoneer 4.2 Sahara		01.88- 01.90	UA943IR	14	60	01.88- 01.90	JS1006	12	1.2
		01.88- 01.90	UA945IR	14	65				
Wagoneer 4.2 Sport		01.87- 01.88	UA945IR	14	65				
		01.87- 01.88	UA943IR	14	60				
Wagoneer 5.4						01.65- 01.67	US818	12	1.5
Wagoneer 5.9		01.81- 01.83	UA943IR	14	60				
Wagoneer 6.6									
Wrangler 2.5						01.98- 01.98	CS1175	12	1.2
Wrangler 4.0						01.98- 01.98	JS1006	12	1.2
Wrangler 4.2		01.89- 01.89	UA943IR	14	60	01.89- 01.89	JS1006	12	1.2
		01.89- 01.89	UA945IR	14	65				
Wrangler 4.2 Islander		01.89- 01.89	UA943IR	14	60	01.89- 01.89	JS1006	12	1.2
		01.89- 01.89	UA945IR	14	65				
Wrangler 4.2 Laredo		01.89- 01.89	UA943IR	14	60	01.89- 01.89	JS1006	12	1.2
		01.89- 01.89	UA945IR	14	65				
Wrangler 4.2 Sahara		01.89- 01.89	UA945IR	14	65	01.89- 01.89	JS1006	12	1.2
		01.89- 01.89	UA943IR	14	60				
<b>John Deere</b>									
<b>AGRICULTURE</b>									
955						01.96-	JS1239	12	1.4
1032 4.0		10.83- 06.89	CA522IR	14	55	10.92- 10.98	CS395	12	3.0
						10.83- 10.92	CS706	12	2.7
1042 4.0		10.83- 06.89	CA522IR	14	55	10.92- 10.98	CS395	12	3.0
						10.83- 10.92	CS706	12	2.7
1052 4.0		10.83- 06.89	CA522IR	14	55	10.83- 10.92	CS706	12	2.7
						10.92- 10.98	CS395	12	3.0
1055 5.9		10.83- 06.89	CA522IR	14	55	10.83- 10.92	CS706	12	2.7
						10.92- 10.98	CS395	12	3.0
1065 5.9		03.94- 11.96	CA847IR	14	85	11.81- 11.96	CS706	12	2.7
		03.94- 11.96	CA1068IR	14	120				
1068 5.9		03.94- 10.96	CA847IR	14	85	10.81- 10.92	CS706	12	2.7
		03.94- 10.96	CA1068IR	14	120	01.92- 10.96	CS395	12	3.0
1072 5.9		03.94- 10.96	CA847IR	14	85	10.81- 10.96	CS706	12	2.7
		03.94- 10.96	CA1068IR	14	120				
1075 5.9		03.94- 12.96	CA847IR	14	85	10.81- 12.96	CS395	12	3.0
		03.94- 12.96	CA1068IR	14	120				
1085 7.6		03.94- 02.97	CA847IR	14	85	02.82- 02.97	CS395	12	3.0
		03.94- 02.97	CA1068IR	14	120				
2254						01.85- 01.92	CS395	12	3.0
2256						01.85- 01.92	CS395	12	3.0
2264						01.85- 01.92	CS395	12	3.0
2266						01.85- 01.92	CS395	12	3.0
2450						01.85- 01.92	CS395	12	3.0
2650			CA847IR	14	85	01.85- 01.92	CS395	12	3.0
2850			CA847IR	14	85	01.85- 01.92	CS395	12	3.0
3350			CA847IR	14	85	01.85- 01.92	CS395	12	3.0
3650			CA847IR	14	85	01.85- 01.92	CS395	12	3.0
6020		01.94-	CA1062IR	14	90				
6100 4.5		01.97-	CA1493IR	14	115				
6110 4.5		01.97-	CA1493IR	14	115				
6120 4.5		01.94-	CA1062IR	14	90				
		01.97-	CA1493IR	14	115				
		01.01-	CA1831IR	14	150				
6200 3.9		01.97-	CA1493IR	14	115				
6205						Eng. -551900 01.94-	CS1205	12	3.0
						Eng. 551901- 01.94-	CS1376	12	3.0
6220 3.9		01.94-	CA1062IR	14	90				
		01.97-	CA1493IR	14	115				
		01.01-	CA1831IR	14	150				
6310		01.98- 01.01	CA1493IR	14	115				
6320 3.9		01.94-	CA1062IR	14	90				
		01.97-	CA1493IR	14	115				
		01.01-	CA1831IR	14	150				
6420 4.5		01.94-	CA1062IR	14	90				
		01.97-	CA1493IR	14	115				
		01.01-	CA1831IR	14	150				
6505						Eng. 551901- 01.94-	CS1376	12	3.0
						Eng. -551900 01.94-	CS1205	12	3.0
6506						01.94-	CS1205	12	3.0
6510		01.94- 01.01	CA1493IR	14	115	Eng. 551901- 01.94-	CS1376	12	3.0
						Eng. -551900 01.94-	CS1205	12	3.0
6520		01.97-	CA1493IR	14	115	Eng. -551900 01.94-	CS1205	12	3.0
		01.94-	CA1062IR	14	90	Eng. 551901- 01.94-	CS1376	12	3.0
		01.01-	CA1831IR	14	150				
6610						Eng. 551901- 01.94-	CS1376	12	3.0
						Eng. -551900 01.94-	CS1205	12	3.0
6620		01.01-	CA1831IR	14	150	Eng. -551900 01.94-	CS1205	12	3.0
		01.94-	CA1062IR	14	90	Eng. 551901- 01.94-	CS1376	12	3.0
		01.97-	CA1493IR	14	115				
6810 10.0						Eng. -551900 01.94-	CS1205	12	3.0
						Eng. 551901- 01.94-	CS1376	12	3.0
6820		01.97-	CA1493IR	14	115	Eng. -551900 01.94-	CS1205	12	3.0
		01.94-	CA1062IR	14	90	Eng. 551901- 01.94-	CS1376	12	3.0
		01.01-	CA1831IR	14	150				
6910		01.94-	CA1493IR	14	115	Eng. -551900 01.94-	CS1205	12	3.0
						Eng. 551901- 01.94-	CS1376	12	3.0
6920		01.94-	CA1062IR	14	90	Eng. -551900 01.94-	CS1205	12	3.0
		01.97-	CA1493IR	14	115	Eng. 551901- 01.94-	CS1376	12	3.0
		01.01-	CA1831IR	14	150				
7710		01.96-	JA1616IR	14	140				



7800 7.6		09.92- 01.96	JA864IR	14 120				
		09.92- 01.96	JA1616IR	14 140				
7810		01.96-	JA1616IR	14 140				
8120 7.6	[6076 HRW35]	01.01- 08.94-	CA1984IR JA1616IR	14 150 14 140				
8120 8.1	[6081 HRW06]	01.01- 03.96-	CA1984IR JA1616IR	14 150 14 140				
8220 7.6	[6076 HRW35]	01.01- 08.94-	CA1984IR JA1616IR	14 150 14 140				
8320		01.01-	CA1984IR	14 150				
8420		01.01-	CA1984IR	14 150				
8520		01.01-	CA1984IR	14 150				
6420 S 4.5		01.94- 01.97-	CA1062IR CA1493IR	14 90 14 115				
		01.01-	CA1831IR	14 150				
Various Models						JS909	12 1.0	
						JS737	12 1.2	
<b>INDUSTRY</b>								
853G 8.3	[6CTA]	01.98-	UA1620IR	28 70				
<b>KHD</b>								
<b>TRUCKS EU</b>								
Various Models								
						CS1471	12 2.0	
<b>MOTORS</b>								
Engine 0.6 Diesel	[F1L410]				01.67- 06.73	CS804	12 2.4	
Engine 1.3 Diesel	[F2L410]				01.67- 06.73	CS804	12 2.4	
Engine 1.4 Diesel	[F2L1011]				06.89- 12.94	CS1184	12 2.2	
					01.95-	CS1185	12 2.2	
					07.73- 12.75	CS804	12 2.4	
Engine 2.0 Diesel	[F3L1011]				06.89- 12.94	CS1184	12 2.2	
					01.95-	CS1185	12 2.2	
Engine 2.7 Diesel	[BF4L1011]				06.89- 12.94	CS1184	12 2.2	
					01.95-	CS1185	12 2.2	
					06.89- 12.94	CS1184	12 2.2	
					01.95-	CS1185	12 2.2	
Engine 2.8 Diesel	[F3L912..]				07.88- 12.91	CS114	12 2.4	
					01.92-	CS887	12 3.1	
Engine 3.8 Diesel	[F4L912]				07.89- 12.91	CS114	12 2.4	
					01.92-	CS887	12 3.1	
Engine 4.7 Diesel	[F5L912.F]	10.89-	CA702IR	28 35				
Engine 5.7 Diesel	[F6L912]	05.90-	CA702IR	28 35				
					05.90- 11.91	CS114	12 2.4	
					06.92-	CS501	24 4.8	
					12.91-	CS887	12 3.1	
Engine 6.1 Diesel	[F6L913]	01.87-	CA702IR	28 35				
Engine 8.0 Diesel	[F5L413FR]	08.89-	CA702IR	28 35				
Engine 9.6 Diesel	[BF6L513..]	10.87-	CA501IR	28 55				
	[F6L413]	12.88-	CA702IR	28 35				
<b>Kia</b>								
<b>PASSENGER CARS EU</b>								
Besta 2.2 Diesel	[R2]	02.96-	JA180IR	14 60		02.96-	JS365	12 2.0
Carens 1.6	[S6D]					07.02- 08.06	JS1098	12 0.9
Carens 1.6 CVVT	[G4FC]	08.09-	CA2020IR	14 90		08.09-	CS1465	12 0.9
Carens 1.8	[TB]	11.00-	JA1784IR	14 90		11.00- 08.06	JS640	12 0.85
Carens 2.0	[G4GC]	08.04-	JA1789IR	14 90		AT 08.04- 08.06	JS922	12 1.2
						08.04- 08.06	JS923	12 1.2
Carens 2.0 CRDi	[D4EA]	11.05-	CA2018IR	14 120		11.05-	JS1234	12 2.0
						07.02-	JS1234	12 2.0
Carens 2.0 CRDi 115	[D4EA]	05.07-	CA2018IR	14 120		05.07-	JS1234	12 2.0
Carnival 2.9 CRDi	[J3]	AC 10.01-	JA1709IR	14 110		10.01-	JS1298	12 2.2
Carnival 2.9 HPDi		AC 10.01-	JA1709IR	14 110		10.01-	JS1298	12 2.2
Carnival 2.9 TD	[J3]	06.98- 10.01	JA1539IR	14 85		06.98- 10.01	JS1298	12 2.2
Carnival 3.5						07.02-	CS1492*	12 1.2
Cee'd 1.4	[G4FA]	12.06-	CA2020IR	14 90		12.06-	CS1465	12 0.9
		10.10-	CA2020IR	14 90				
Cee'd 1.4 CVVT	[G4FA-L]	06.10-	CA2020IR	14 90		06.10-	CS1465	12 0.9
Cee'd 1.6	[G4FC]	12.06-	CA2020IR	14 90		12.06-	CS1465	12 0.9
Cee'd 1.6 CVVT	[G4FC]	10.10-	CA2020IR	14 90		10.10-	CS1465	12 0.9
Cee'd 1.6 CRDi	[D4FB]	12.06-	CA1906IR	14 120		12.06-	JS1365	12 1.7
	[D4FB-L]	12.06-	CA1906IR	14 120		12.06-	JS1365	12 1.7
Cee'd 2.0	[G4GC]	12.06-	CA1927IR	14 90		12.06-	CS1433	12 1.2
						AT 12.06-	JS1370	12 1.2
Cee'd 2.0 CRDi	[D4EA-F]	09.07-	CA2018IR	14 120		09.07-	CS1441	12 2.0
Cerato 1.5 CRDi	[D4FA]	07.05-	CA1906IR	14 120		07.05-	JS1365	12 1.7
Cerato 1.6	[G4ED]	04.04-	JA1789IR	14 90		04.04-	JS1311	12 0.9
						AT 04.04-	JS1312	12 0.9
Cerato 1.6 CRDi	[D4FB]	06.05-	CA1906IR	14 120		06.05-	JS1365	12 1.7
Cerato 2.0	[G4GC]	04.04-	JA1789IR	14 90		04.04-	JS923	12 1.2
						AT 04.04-	JS922	12 1.2
Cerato 2.0 CRDi	[D4EA]	04.04-	JA1708IR	14 120		04.04- 09.06	JS1234	12 2.0
Clarus 1.8 i16V	[T8]	07.96- 11.01	JA1786IR	14 80 ▲		07.96- 11.01	JS1000	12 0.9
						AT 07.96- 11.01	JS637	12 1.4
						07.96-	JS640	12 0.85
Clarus 2.0 i16V	[FE]	07.96- 11.01	JA1786IR	14 80 ▲		AT 07.96- 11.01	JS637	12 1.4
						07.96- 11.01	JS1000	12 0.9
						07.96-	JS640	12 0.85
Joice 2.0	[G4CP]	08.99- 09.01	JA684IR	14 90		08.99- 09.01	JS349	12 0.9
						A13 02.00- 09.01	JS628	12 1.2
						AT 08.99- 09.01	JS1004	12 1.2
						02.00- 09.01	JS1311	12 0.9
		09.01- 03.03	JA684IR	14 90		AT 09.01- 03.03	JS1004	12 1.2
						09.01- 03.03	JS1311	12 0.9
						09.01- 03.03	JS349	12 0.9
K2500 2.5 TCI	[D4BH]	09.01-	JA1711IR	14 75		08.02-	JS1351	12 2.0
						A13 09.01- 08.02	JS892	12 2.2
						09.01- 08.02	JS770	12 2.0
Magentis 2.0	[G4JP]	12.00- 05.03	JA1522IR JA1807IR	14 100 14 110		05.01-	JS1304	12 1.2
Magentis 2.0 CRDi	[D4EA]	02.06-	CA2018IR	14 120		04.06-	JS1234	12 2.0
Magentis 2.5 V6	[G6BV]	05.01-	CA2088IR*	14 95		AT 09.00-	CS1492*	12 1.2
Opirus 3.5	[G6CU]					09.03-	CS1492*	12 1.2
Picanto 1.0	[G4HE]	02.04-	JA1798IR	14 70		02.04-	JS1303	12 0.8
Picanto 1.1	[G4HG]	04.04-	JA1798IR	14 70 ▲		04.04-	JS1303	12 0.8
Picanto 1.1 CRDi	[D3FA]	11.05-	CA1938IR	14 90		11.05-	JS1365	12 1.7



**KIA Continued**

Pregio 2.5 Diesel	[D4BH]	08.95- 09.04	JA1711R	14 75		08.95- 09.04	JS1351	12 2.0	A37	
						08.95- 09.04	JS770	12 2.0	A36	
						08.95- 09.04	JS892	12 2.2		
Pregio 2.5 Tci	[D4BH]	08.01-	JA1711R	14 75		08.01- 08.02	JS770	12 2.0		
						08.02-	JS1351	12 2.0		
						08.01- 08.02	JS892	12 2.2		
Pride 1.1 i	[B1]					01.91- 01.00	JS633	12 0.85		
Pride 1.3	[B3]	08.99-	JA1276R	14 50		08.99-	JS633	12 0.85		
		08.99-	JA1731R	14 60		AT 08.99-	JS1000	12 0.9		
Pride 1.3 GLXi	[B3]	01.90- 02.00	JA1276R	14 50		01.90- 02.00	JS633	12 0.85		
Pride 1.3 16V	[B3]	10.96- 02.00	JA1276R	14 50		AT 10.96- 02.00	JS1098	12 0.9		
						10.96- 02.00	JS633	12 0.85		
Pride 1.3 16V GLXi	[B3]	01.90- 02.00	JA1276R	14 50		01.90- 02.00	JS633	12 0.85		
		01.90-	JA1731R	14 60						
Pride 1.3 i	[B3]	01.90-	JA1731R	14 60		AT 01.90-	JS1098	12 0.9		
		10.94- 02.00	JA1276R	14 50		01.90-	JS633	12 0.85		
Pro Cee'd 1.4	[G4FA]	02.08-	CA2020R	14 90		02.08-	CS1465	12 0.9		
Pro Cee'd 1.6	[G4FC]	02.08-	CA2020R	14 90		02.08-	CS1465	12 0.9		
Pro Cee'd 1.6 CVVT	[G4FC]	10.10-	CA2020R	14 90		10.10-	CS1465	12 0.9		
Pro Cee'd 1.6 CRDi	[D4FB]	02.08-	CA1906R	14 120		02.08-	JS1365	12 1.7		
	[D4FB-L]	02.08-	CA1906R	14 120		02.08-	JS1365	12 1.7		
Pro Cee'd 2.0	[G4GC]	02.08-	CA1927R	14 90		AT 02.08-	JS1370	12 1.2		
						02.08-	CS1433	12 1.2		
Pro Cee'd 2.0 CRDi	[D4EA-F]	02.08-	CA2018R	14 120		02.08-	CS1441	12 2.0		
Retona 2.0 16V	[FE-DI]	01.97- 12.02	JA1537R	14 70						
Retona 2.0 TD		01.97- 12.02	JA1795R	14 60						
Rio 1.3	[A3E]	08.00- 02.05	JA1785R	14 80		08.00- 02.05	JS640	12 0.85		
		08.02- 02.05	JA1785R	14 80		08.02- 02.05	JS1098	12 0.9		
Rio 1.4 16V	[G4EE]	03.05-	JA1789R	14 90		03.05-	JS1311	12 0.9		
Rio 1.4 CVVT	[G4FA]					09.11-	CS1465	12 0.9		
Rio 1.5	[A5D]	08.00- 02.05	JA1785R	14 80		09.02- 02.05	JS1098	12 0.9		
						08.00- 02.05	JS640	12 0.85		
		09.00- 02.05	JA1785R	14 80		09.00- 02.05	JS640	12 0.85		
Rio 1.5 CRDi	[D4FA]	03.05-	CA1906R	14 120		03.05-	JS1365	12 1.7		
Rio 1.6 16V	[G4ED]	03.05-	JA1789R	14 90		03.05-	JS1311	12 0.9		
Sephia 1.5 i 16V	[B5]	02.96- 12.97	JA877R	14 70		02.96- 12.97	JS1000	12 0.9		
Sephia 1.6	[B6]	09.93- 12.97	JA877R	14 70		09.93- 12.97	JS1000	12 0.9		
Sephia 1.6 i	[B6]	01.95- 12.97	JA877R	14 70		01.95- 12.97	JS1000	12 0.9		
Sephia 1.8 i 16V	[T8D]	01.98- 12.00	JA877R	14 70		01.95- 12.00	JS637	12 1.4		
Shuma 1.5	[B6]	03.96- 01.97	JA877R	14 70		03.96- 12.98	JS640	12 0.85		
Shuma 1.5 i 16V	[B5D]	10.97- 12.00	JA877R	14 70		10.97- 10.01	JS640	12 0.85		
Shuma 1.6	[GA6D]	01.01-	JA1785R	14 80		01.01- 08.04	JS1098	12 0.9		
		01.01- 12.01	JA1785R	14 80		01.01- 12.01	JS1098	12 0.9		
Shuma 1.8		01.01- 08.04	JA877R	14 70		AT 01.01- 08.04	JS637	12 1.4		
Shuma 1.8 i 16V	[T8D]	10.97- 01.01	JA877R	14 70		10.97- 01.01	JS640	12 0.85		
Sorento 2.4	[4G64]	03.03-	JA1807R	14 110		03.03-	JS1304	12 1.2		
Sorento 2.5 CRDi	[D4CB]	08.02-	JA1804R	14 110		05.02-	JS1355	12 2.2		
Sorento 3.5 V6	[6G74]					08.02-	JS658	12 1.2		
Soul 1.6	[G4FC]	02.09-	CA2020R	14 90		02.09-	CS1465	12 0.9		
Soul 1.6 CVVT	[G4FC]	02.09-	CA2020R	14 90		02.09-	CS1465	12 0.9		
Soul 1.6 CRDi						02.09- 04.09	JS1365	12 1.7		
Sportage 1.6 GDi	[G4FD]					02.11-	CS1465	12 0.9		
Sportage 2.0	[FE]	10.00- 08.03	JA1537R	14 70		10.00- 08.03	JS640	12 0.85		
Sportage 2.0 4WD	[FE]	10.00- 08.03	JA1537R	14 70		10.00- 08.03	JS640	12 0.85		
Sportage 2.0 16V	[G4GC]	09.04-	JA1789R	14 90		09.04-	CS1433	12 1.2		
		09.04-	JA1807R	14 110						
Sportage 2.0 16V 4WD	[G4GC]	09.04-	JA1789R	14 90		09.04-	CS1433	12 1.2		
		09.04-	JA1807R	14 110						
Sportage 2.0 i 16V	[FE]	11.98- 08.03	JA1537R	14 70		10.00- 08.03	JS640	12 0.85		
Sportage 2.0 i 16V 4WD	[FE]	04.94- 02.01	JA1537R	14 70		04.94- 02.01	JS1000	12 0.9		
Sportage 2.0 i 4WD	[FE]	04.94- 08.99	JA1537R	14 70		04.94- 08.99	JS1000	12 0.9		
Sportage 2.0 CRDi	[D4EA]	02.05- 03.08	JA1708R	14 120		02.05- 03.08	JS1234	12 2.0		
	[D4EA-V]	01.06-	JA1708R	14 120		01.06-	JS1234	12 2.0		
		09.08-	JA1708R	14 120		09.08-	CS1441	12 2.0		
Sportage 2.0 CRDi 4WD	[D4EA]	09.04- 03.08	JA1708R	14 120		09.04- 03.08	JS1234	12 2.0		
		09.08-	JA1708R	14 120		09.08-	CS1441	12 2.0		
Sportage 2.0 CRDi AWD	[D4EA-V]	01.06-	JA1708R	14 120		01.06-	JS1234	12 2.0		
Sportage 2.0 TD 4WD	[RF]	10.97- 08.04	JA1795R	14 60		10.97- 08.04	JS365	12 2.0		
Sportage 2.7 V6 4WD	[G6BA]	09.04-	JA1903R	14 120		09.04-	CS1492*	12 1.2		
Venga 1.4 16V		02.10-	CA2020R	14 90		02.10-	CS1465	12 0.9		
Venga 1.4 CRDi	[D4FC]	02.10-	CA1906R	14 120						
		02.10-	CA1906R	14 120						
Venga 1.4 CRDi 75	[D4FC]	02.10-	CA1906R	14 120						
Venga 1.6 16V	[G4FC]	02.10-	CA2020R	14 90						
Venga 1.6 CRDi	[D4FB]	02.10-	CA1906R	14 120						
		02.10-	CA1906R	14 120						
<b>PASSENGER CARS US</b>										
Optima 2.4		01.01- 01.03	JA1522R	14 100		01.01- 01.03	JS1304	12 1.2		
Rio 1.5		01.01- 01.02	JA1785R	14 80						
Rio 1.5 CINCO		01.02- 01.02	JA1785R	14 80						
Sephia 1.6 GS		01.95- 01.97	JA877R	14 70		01.93- 01.97	JS1000	12 0.9		
Sephia 1.6 LS		01.95- 01.97	JA877R	14 70		01.93- 01.97	JS1000	12 0.9		
Sephia 1.6 RS		01.95- 01.97	JA877R	14 70		01.93- 01.97	JS1000	12 0.9		
Sephia 1.8	[5BP]	01.99- 01.99	JA877R	14 70		01.99- 01.01	JS637	12 1.4		
		01.98- 01.98	JA877R	14 70		01.99- 01.01	JS1000	12 0.9		
						01.98- 01.98	JS1000	12 0.9		
						01.98- 01.98	JS637	12 1.4		
Sephia 1.8 GS						01.95- 01.97	JS1000	12 0.9		
						01.95- 01.97	JS637	12 1.4		
Sephia 1.8 LS		01.98- 01.98	JA877R	14 70		01.95- 01.98	JS637	12 1.4		
						01.95- 01.98	JS1000	12 0.9		
Sephia 1.8 RS		01.97- 01.97	JA1283	14 70		01.96- 01.97	JS637	12 1.4		
						01.96- 01.97	JS1000	12 0.9		
Spectra 1.8	[5BP]	01.00- 01.03	JA877R	14 70		01.00- 01.03	JS637	12 1.4		
						01.00- 01.03	JS1000	12 0.9		
Sportage 2.0	[3FE]	01.99- 01.02	JA1537R	14 70		01.99- 01.02	JS637	12 1.4		
						01.99- 01.02	JS1000	12 0.9		
		01.95- 01.98	JA1537R	14 70		01.98- 01.98	JS637	12 1.4		
						01.95- 01.98	JS1000	12 0.9		
Sportage 2.0 4-Door		01.95- 01.97	JA1537R	14 70		01.96- 01.97	JS637	12 1.4		
						01.95- 01.97	JS1000	12 0.9		





PASSENGER CARS AO							
Cerato 1.6	[G4FC]	05.06-	CA2020IR	14	90		
		05.06-	CA2020IR	14	90		
<b>Komatsu</b>							
<b>FORK LIFTS</b>							
605	[H20]					JS343	12 0.8
D11	[Nissan]					JS340	12 0.8
DT11						JS329	12 0.8
FG10-10	[D11PU]					JS340	12 0.8
FG10-12	[Toyota 4P]					JS336	12 0.8
FG15-12	[Toyota 4P]					JS336	12 0.8
FG18-12	[Toyota 4P]					JS336	12 0.8
FG20-6	[Nissan H20PU]					JS329	12 0.8
						JS343	12 0.8
FG20-7	[Nissan H20PU]					JS329	12 0.8
						JS343	12 0.8
FG20-8	[Nissan H20PU]					JS329	12 0.8
						JS343	12 0.8
PC300HD	[SA6D114E-1]		UA1620IR	28	70		
Various Models	[Nippondenso equipped]		JA792IR#	14	40		
WA180	[S6D102E-1]		UA1620IR	28	70		
<b>Kubota</b>							
<b>INDUSTRY</b>							
RX502 Excavator						JS734	12 1.4
<b>MOTORS</b>							
Engine	[D1302]					JS734	12 1.4
	[D1402]					JS734	12 1.4
	[D850]					JS908	12 1.4
	[D950]					JS673	12 0.8
	[DM1102]					JS730	12 1.0
	[F2302]	01.85- 01.93	JA130	14	30		
	[V1502]	01.86- 01.89	JA971IR	14	35	01.86- 01.89	JS734 12 1.4
	[Z600.]					01.81-	JS673 12 0.8
<b>Kässbohrer</b>							
<b>TRUCKS EU</b>							
S210H 11.0	[OM421.900]	10.83- 03.95	CA333IR	28	55	10.83- 06.96	CS198 24 6.0
		10.83- 09.89	CA823IR#	28	120		
		10.89- 06.96	CA1235IR	28	120		
	[OM421A]	09.85- 03.95	CA333IR	28	55	09.85- 06.96	CS198 24 6.0
		09.85- 09.89	CA823IR#	28	120		
		10.89- 06.96	CA1235IR	28	120		
	[OM441A]	03.89- 06.96	CA1235IR	28	120		
		03.89- 09.89	CA823IR#	28	120		
S2115HDH 14.6	[OM422LA]	06.96- 06.01	CA1236IR	28	140		
S211H 11.0	[OM421A]	09.85- 03.95	CA333IR	28	55	09.85- 06.96	CS198 24 6.0
		09.85- 09.89	CA823IR#	28	120		
		10.89- 06.96	CA1235IR	28	120		
S211H 14.6	[OM422.900]	01.80- 03.95	CA333IR	28	55	01.80- 06.96	CS198 24 6.0
		02.83- 09.89	CA823IR#	28	120		
		10.89- 06.96	CA1235IR	28	120		
S213H 14.6	[OM422.900]	01.80- 03.95	CA333IR	28	55	01.80- 06.96	CS198 24 6.0
		02.83- 06.96	CA823IR#	28	120		
		10.89- 06.96	CA1235IR	28	120		
	[OM422.901]	09.83- 06.96	CA1235IR	28	120	09.83- 06.96	CS198 24 6.0
		09.83- 03.95	CA333IR	28	55		
S213HR 14.6	[OM422.900]	09.83- 03.95	CA333IR	28	55	09.83- 06.96	CS198 24 6.0
		09.83- 09.89	CA823IR#	28	120		
		10.89- 06.96	CA1235IR	28	120		
S213RL 14.6	[OM422.900]	09.83- 03.95	CA333IR	28	55	09.83- 06.96	CS198 24 6.0
		09.83- 09.89	CA823IR#	28	120		
		10.89- 06.96	CA1235IR	28	120		
S214H 12.0	[D2866KOH]	08.87- 01.95	CA1235IR	28	120		
	[D2866LOH]	09.86- 01.95	CA1235IR	28	120		
S214HD 14.6	[OM422.900]	09.83- 03.95	CA333IR	28	55	09.83- 06.96	CS198 24 6.0
		09.83- 09.89	CA823IR#	28	120		
		10.89- 06.96	CA1235IR	28	120		
	[OM422.901A]	09.83- 03.95	CA333IR	28	55	09.83- 06.96	CS198 24 6.0
		09.83- 09.89	CA823IR#	28	120		
		10.89- 06.96	CA1235IR	28	120		
S215H 12.0	[D2866KOH]	08.87- 01.95	CA1235IR	28	120		
	[D2866LOH]	09.86- 01.95	CA1235IR	28	120		
S215H 14.6	[OM422.900]	01.80- 03.95	CA333IR	28	55	01.80- 06.96	CS198 24 6.0
		02.83- 09.89	CA823IR#	28	120		
		10.89- 06.96	CA1236IR	28	140		
	[OM422.901A]	09.83- 03.95	CA333IR	28	55	09.83- 06.96	CS198 24 6.0
		09.83- 09.89	CA823IR#	28	120		
		10.89- 06.96	CA1235IR	28	120		
	[OM422A]	07.88- 06.96	CA1235IR	28	120		
S215HR 14.6	[OM422.900]	09.83- 03.95	CA333IR	28	55	09.83- 06.96	CS198 24 6.0
		09.83- 09.89	CA823IR#	28	120		
		10.89- 06.96	CA1235IR	28	120		
S215RL 14.6	[OM422.900]	09.83- 03.95	CA333IR	28	55	09.83- 06.96	CS198 24 6.0
		09.83- 09.89	CA823IR#	28	120		
		10.89- 06.96	CA1235IR	28	120		
S215SL 12.0	[OM427H]	09.85- 03.95	CA333IR	28	55	09.85- 06.96	CS198 24 6.0
		09.85- 09.89	CA823IR#	28	120		
		10.89- 06.96	CA1235IR	28	120		
S215UL 12.0	[OM427H.]	09.85- 03.95	CA333IR	28	55	09.85- 06.96	CS198 24 6.0
		09.85- 09.89	CA823IR#	28	120		
		10.89- 06.96	CA1235IR	28	120		
S216HDS 12.0	[D2866KOH]	09.86- 01.95	CA1235IR	28	120		
S216HDS 14.6	[OM422.901A]					07.80- 06.96	CS198 24 6.0
S217HDH 14.6	[OM422LA]	01.89- 06.96	CA1236IR	28	140	01.89- 06.96	CS191 24 5.4
S228DT 14.6	[OM442A]	01.89- 06.96	CA1235IR	28	120		
	[OM442LA]	01.89- 06.96	CA1236IR	28	140	01.89- 06.96	CS191 24 5.4
S250 Spezial 12.0	[D2866LOH22]	07.94- 06.96	CA1235IR	28	120		
		07.94- 06.96	CA1236IR	28	140		
	[D2866LOH23]	06.96- 06.01	CA1236IR	28	140	06.96- 06.01	CS191 24 5.4
S300N 12.0	[D2866OH]	03.92-	CA1235IR	28	120		
S300NC 12.0	[D2866OH]	03.92-	CA1235IR	28	120		
S309HD 11.0	[OM441LA]	09.92-	CA1236IR	28	140	09.92-	CS191 24 5.4
S309HD 9.5	[OM401LA]	09.91-	CA1235IR	28	120		
S312HD 11.0	[OM441LA]	09.91-	CA1235IR	28	120		
		09.91-	CA1236IR	28	140		



**KÄSSBOHRER Continued**

S312HD 14.6	[OM442LA]	09.91- 09.91-	CA1235IR CA1236IR	28 120 28 140				
S313UL 12.0	[D2866LUH21]	03.95- 03.95-	CA1235IR CA1236IR	28 120 28 140				
	[OM447HLA]	03.95-	CA1236IR	28 140				
	[OM457HLA]	07.01-	CA1236IR	28 140	07.01-	CS1333	24 6.2	
S315GT 11.0	[OM441LA]	09.94-	CA1236IR	28 140	09.94-	CS191	24 5.4	
S315GT 14.6	[OM442LA]	09.94-	CA1236IR	28 140	09.94-	CS191	24 5.4	
S315GT-HD 11.0	[OM441LA]	07.96-	CA1236IR	28 140	07.96-	CS191	24 5.4	
	[OM442LA]	07.96-	CA1236IR	28 140	07.96-	CS191	24 5.4	
S315H 11.0	[OM441LA]	09.94-	CA1236IR	28 140	09.94-	CS191	24 5.4	
S315H 12.0	[OM457HLA]	07.01-	CA1236IR	28 140	07.01-	CS1333	24 6.2	
S315HD 12.0	[D2866LOH23]	03.95-	CA1236IR	28 140	03.95-	CS191	24 5.4	
S315HD HDH 11.0	[OM441LA]	09.91-	CA1236IR	28 140	09.91-	CS191	24 5.4	
S315HD HDH 14.6	[OM442LA]	09.91-	CA1236IR	28 140				
	[OM442LA]	09.91-	CA1236IR	28 140	09.91-	CS191	24 5.4	
S315NF 12.0	[OM447HLA]	03.96-	CA1236IR	28 140				
	[OM457HLA]	07.01-	CA1236IR	28 140	07.01-	CS1333	24 6.2	
S315UL 12.0	[D2866LUH21]	09.94-	CA1236IR	28 140				
	[OM447HLA]	09.94-	CA1236IR	28 140				
	[OM457HLA]	07.01-	CA1236IR	28 140	07.01-	CS1333	24 6.2	
S316HDS 14.6	[OM442LA]	01.97-	CA1236IR	28 140	01.97-	CS191	24 5.4	
S316UL 12.0	[OM457HLA]	07.01-	CA1236IR	28 140	07.01-	CS1333	24 6.2	
S317HDH 14.6	[OM442LA]	10.97-	CA1236IR	28 140	10.97-	CS191	24 5.4	
S317UL 12.0	[OM457HLA]	07.01-	CA1236IR	28 140	07.01-	CS1333	24 6.2	
S319GT-HD 11.0	[OM442LA]	07.98-	CA1236IR	28 140	07.98-	CS191	24 5.4	
S319NF 12.0	[OM447HLA]	12.97-	CA1236IR	28 140				
	[OM457HLA]	07.01-	CA1236IR	28 140	07.01-	CS1333	24 6.2	
S319UL 12.0	[D2866LUH21]	03.95-	CA1236IR	28 140				
	[OM447HLA]	03.95-	CA1236IR	28 140				
	[OM457HLA]	07.01-	CA1236IR	28 140	07.01-	CS1333	24 6.2	
S328DT 14.6	[OM442LA]	04.93-	CA1236IR	28 140	04.93-	CS191	24 5.4	
S415GT 12.0	[OM457.941]				10.03-	CS1333	24 6.2	
S415GT-HD 12.0	[OM457.944]	10.03-	CA1659IR	28 140	10.03-	CS1333	24 6.2	
S416GT-HD 12.0	[OM457.944]	10.03-	CA1659IR	28 140	10.03-	CS1333	24 6.2	
S417GT-HD 12.0	[OM457.944]	10.03-	CA1659IR	28 140	10.03-	CS1333	24 6.2	
SG321UL 12.0	[D2866LUH21]	03.95-	CA1236IR	28 140				
	[OM447HLA]	03.95-	CA1236IR	28 140				
	[OM457HLA]	07.01-	CA1236IR	28 140	07.01-	CS1333	24 6.2	
<b>Lada</b>								
<b>PASSENGER CARS EU</b>								
110 1.5	[VAZ-2111]	01.95-	CA1347IR	14 80	01.96- 12.00 01.95-	CS332# CS1182	12 1.3 12 1.4	
110 1.5 16V	[VAZ-2112]	01.95- 10.00-	CA1347IR CA1472IR	14 80 14 80	01.95-	CS1182	12 1.4	
110 1.6	[VAZ-21114]	01.00- 01.00-	CA1347IR CA1347IR	14 80 14 80	01.00- 01.00-	CS1182 CS1182	12 1.4 12 1.4	
111 1.5	[VAZ-2111]	01.95- 10.00-	CA1347IR CA1472IR	14 80 14 80	01.96-	CS1182	12 1.4	
111 1.5 16V	[VAZ-2112]	01.95- 10.00-	CA1347IR CA1472IR	14 80 14 80	01.95-	CS1182	12 1.4	
111 1.6		01.05- 01.05-	CA1347IR	14 80	01.05- 01.05-	CS332# CS1182	12 1.3 12 1.4	
112 1.5	[VAZ-2111]	01.95-	CA1347IR	14 80	01.95-	CS1182	12 1.4	
112 1.5 16V	[VAZ-2112]	01.95- 10.00-	CA1347IR CA1472IR	14 80 14 80	01.95-	CS1182	12 1.4	
112 1.6		01.05-	CA1347IR	14 80				
1200 1.2	[BA32101]				01.70- 06.86	CS139	12 1.3	
1300 1.3	[BA321011]	01.80- 01.87	CA295IR	14 55	05.78- 01.87	CS139	12 1.3	
	[BA32105]				08.74- 08.84	CS139	12 1.3	
1300 1.3 1300					08.74- 08.84	CS139	12 1.3	
1500 1.5	[BA32103]	01.80- 10.86	CA295IR	14 55	09.72- 10.86	CS139	12 1.3	
1600 1.6	[BA32106]	01.80- 10.86	CA295IR	14 55	09.72- 10.86	CS139	12 1.3	
Kalina 1.4 16V 1117	[VAZ-11194]				11.08-	CS1182	12 1.4	
Kalina 1.4 16V 1118	[VAZ-11194]				11.08-	CS1182	12 1.4	
Kalina 1.4 16V 1119	[VAZ-11194]				11.08-	CS1182	12 1.4	
Kalina 1.6	[VAZ-21114]				10.04-	CS1182	12 1.4	
Niva 1.6 1600	[BA32121]				12.76- 03.95	CS139	12 1.3	
Niva 1.7 i 1700	[BA321214]	01.93-	CA1472IR	14 80	07.96- 12.99	CS139	12 1.3	
Niva 1.7 i 4x4		10.00-	CA1472IR	14 80	10.00-	CS139	12 1.3	
Niva 1.9 Diesel	[XUD9A]				01.93-	CS712	12 2.2	
Niva 1.9 Diesel 1900	[XUD9SD]				01.99-	CS712	12 2.2	
Nova 1.2 1200 Junior	[BA32101]	09.81- 12.93	CA295IR	14 55	09.81- 12.93	CS139	12 1.3	
Nova 1.3 1300	[BA32105]	09.85- 12.90	CA295IR	14 55	09.85- 12.90	CS139	12 1.3	
Nova 1.3 1300 Spezial	[BA32105]	05.81- 12.93	CA295IR	14 55	05.81- 12.93	CS139	12 1.3	
Nova 1.5 1500	[BA32103]	03.85- 12.00	CA295IR	14 55	03.85- 12.00	CS139	12 1.3	
		06.89- 12.93	CA295IR	14 55				
Nova 1.6 1600	[BA32106]	01.88- 12.93	CA295IR	14 55	01.88- 12.93	CS139	12 1.3	
Nova 1.7 1700	[ECE]	08.94- 12.00	CA295IR	14 55	08.94- 12.00	CS332#	12 1.3	
Priora 1.6 16V					11.08-	CS1182	12 1.4	
Samara 1.1 1100	[BA321081]	02.88- 12.94	CA295IR	14 55	02.88- 12.94	CS332#	12 1.3	
Samara 1.1 1100 Forma	[BA321081]	07.91- 12.00	CA295IR	14 55	07.91- 12.00	CS332#	12 1.3	
Samara 1.3 1300	[BA32108]	01.86- 12.94	CA295IR	14 55	01.86- 12.94	CS332#	12 1.3	
	[BA321115]	02.96-	CA295IR	14 55	02.96-	CS332#	12 1.3	
Samara 1.3 1300 Forma	[BA32108]	05.89- 07.97	CA295IR	14 55	05.89- 07.97	CS332#	12 1.3	
Samara 1.5					11.98-	CS1182	12 1.4	
Samara 1.5 1500	[BA321083]	01.88-	CA295IR	14 55	01.88-	CS332#	12 1.3	
	[BA32111]	09.91- 10.91-	CA1347IR CA295IR	14 80 14 55	01.99- 09.91-	CS1182 CS332#	12 1.4 12 1.3	
	[BA321083]	07.91-	CA295IR	14 55	07.91-	CS332#	12 1.3	
Samara 1.5 1500 Forma	[BA32111]	11.94-	CA1347IR	14 80	11.94- 01.99-	CS332# CS1182	12 1.3 12 1.4	
Toscana 1.3	[BA32105]	12.85-	CA295IR	14 55	12.85-	CS139	12 1.3	
Toscana 1.5 1500	[BA32103]	09.83- 02.93	CA295IR	14 55	09.83- 02.93	CS139	12 1.3	
<b>PASSENGER CARS AO</b>								
Samara 1.5	[VAZ-2111]	04.96-	CA1347IR	14 80	04.96-	CS332#	12 1.3	
Samara 1.5 Forma	[VAZ-2111]	01.00-	CA1347IR	14 80	01.00-	CS332#	12 1.3	
<b>Lamborghini</b>								
<b>PASSENGER CARS EU</b>								
Jalpa 3.5 P 350		01.82- 03.84	CA70#	14 55				
Urraco 2.5 P250		11.75- 12.80	CA70#	14 55				
<b>AGRICULTURE</b>								
105 Diesel Formula	[1004.4]	03.89- 12.99	CA316IR	14 55	03.89- 12.99	CS718	12 3.0	
115 6.0 Diesel Formula	[1000.6]	12.89- 12.99	CA355IR	14 65	12.89- 12.99	CS718	12 3.0	



135 6.0 Diesel Formula	[1000.6]	12.89- 12.99	CA3551R	14 65	12.89- 12.99	CS335	12 3.0
165 6.0 Diesel Racing	[1000.6]	05.91- 12.99	CA3551R	14 65	05.91- 12.99	CS335	12 3.0
190 6.0 Diesel Rasing	[1000.6]	01.92- 12.99	CA3551R	14 65	01.92- 12.99	CS335	12 3.0
660 3.1 Diesel	[105.3]	01.87- 12.99	CA3161R	14 55	01.87- 12.99	CS718	12 3.0
775 4.0 Diesel	[1000.4]	06.87- 12.99	CA2551R	14 45	06.87- 12.99	CS335	12 3.0
1106 5.5 Diesel 2RM	[916.6]	01.84- 05.85	CA2551R	14 45	01.84- 12.99	CS718	12 3.0
		06.85- 12.99	CA3161R	14 55			
1306 5.5 TD DT	[916.6]	01.84- 05.85	CA2551R	14 45	01.84- 12.99	CS718	12 3.0
		06.85- 12.99	CA3161R	14 55			
1506 6.8 TD	[1106HT]	01.84- 05.85	CA2551R	14 45	01.84- 12.99	CS718	12 3.0
		06.85- 12.99	CA3161R	14 55			
1706 6.8 TD	[1106]	01.84- 05.85	CA2551R	14 45	01.84- 12.99	CS718	12 3.0
		06.85- 12.99	CA3161R	14 55			
660 F 3.0 Diesel	[1000.3]	06.87- 12.99	CA3161R	14 55	06.87- 12.99	CS718	12 3.0
674-70 4.0 Diesel	[1000.4]	06.86- 12.99	CA2551R	14 45	06.86- 12.99	CS335	12 3.0
674-70 N 4.0 Diesel	[1000.4]	06.86- 12.95	CA2551R	14 45	06.86- 12.95	CS335	12 3.0
674-70 N 4.0 Diesel Bosso	[1000.4]	06.86- 12.95	CA2551R	14 45	06.86- 12.95	CS335	12 3.0
774-80 4.0 Diesel	[1000.4]	06.86- 12.99	CA2551R	14 45	06.86- 12.99	CS335	12 3.0
774-80 DT 4.0 Diesel	[1000.4]	06.86- 12.99	CA2551R	14 45	06.86- 12.99	CS335	12 3.0
774-80 N 4.0 Diesel	[1000.4]	06.86- 12.99	CA2551R	14 45	06.86- 12.99	CS335	12 3.0
775 F 3.0 Diesel Plus	[1000.3]	05.91- 12.99	CA3551R	14 65	05.91- 12.99	CS718	12 3.0
874-90 4.0 Diesel	[1000.4]	06.86- 12.99	CA2551R	14 45	06.86- 12.99	CS335	12 3.0
956 DT 5.5 Diesel	[916.6]	01.84- 05.85	CA2551R	14 45	01.84- 12.99	CS718	12 3.0
		06.85- 12.99	CA3161R	14 55			
956-2 RM 5.5 Diesel	[916.6]	01.84- 05.85	CA2551R	14 45	01.84- 12.99	CS718	12 3.0
		06.85- 12.99	CA3161R	14 55			
C 554 2.8 Diesel	[100.3P]	06.87- 12.00	CA771R	14 33			
C 664 3.1 Diesel		06.87- 12.00	CA3161R	14 55	06.87- 12.00	CS718	12 3.0
C 774-80 4.0 Diesel	[1000.4]	06.86- 12.00	CA2551R	14 45	06.86- 12.00	CS335	12 3.0
C 874-90 4.0 Diesel	[1000.4]	09.90- 12.00	CA2551R	14 45			
R 235 F 1.8 Diesel		10.90- 12.99	CA7341R	14 33			
R 235 S 1.8 Diesel		01.83- 09.90	CA7341R	14 33			
R 513 2.7 Diesel	[983L]	03.83- 12.95	CA7341R	14 33			
		03.83- 12.95	CA771R	14 33			
<b>MOTORS</b>							
	[1000.3W]	01.87- 12.99	CA2551R	14 45	01.87- 12.99	CS335	12 3.0
		01.87- 12.99	CA3161R	14 55			
		01.87- 12.99	CA3551R	14 65			
	[1000.4W]	01.87- 12.99	CA2551R	14 45	01.87- 12.99	CS335	12 3.0
		01.87- 12.99	CA3161R	14 55			
		01.87- 12.99	CA3551R	14 65			
	[1000.6..]	09.90- 12.99	CA2551R	14 45	09.90- 12.99	CS335	12 3.0
		09.90- 12.99	CA3161R	14 55			
		09.90- 12.99	CA3551R	14 65			
<b>Lancia</b>							
<b>PASSENGER CARS EU</b>							
A 112 0.9 Junior	[112A.000]				03.78- 06.86	CS90	12 0.8
	[112A5.000]				03.78- 06.86	CS90	12 0.8
	[112B2.000]				03.78- 06.86	CS90	12 0.8
A 112 1.0 Abarth	[A112A.2000]	03.78- 02.84	CA3071R	14 45	03.78- 02.84	CS90	12 0.8
Ardea Berlina 0.9		11.88- 08.94	CA13801R	14 100 ▲	11.88- 08.94	CS589	12 1.4
					11.88- 08.94	CS1049	12 1.7
Beta 1.3		04.76- 04.78	CA1191R	14 45			
		04.76- 07.82	CA1291R	14 55			
Beta 1.4	[828A2.000]	08.73- 07.76	CA1291R	14 55			
Beta 1.6	[828B.000]	06.73- 04.82	CA1291R	14 55			
Beta 1.6 Spider	[828B.000]	01.73- 04.78	CA1191R	14 45			
		01.73- 12.84	CA1291R	14 55			
Beta 1.8	[828A1.000]	08.73- 07.76	CA1191R	14 45			
		08.73- 12.84	CA1291R	14 55			
Beta 2.0	[828B1.000]	04.76- 07.78	CA1191R	14 45			
		04.76- 07.82	CA1291R	14 55			
Beta 2.0 HPE Volumex	[828CB8A]	04.83- 12.84	CA1291R	14 55			
Beta 2.0 Spider	[828B1.000]	01.75- 01.81	CA1291R	14 55			
Beta 2.0 VX	[828CB8A]	04.83- 12.84	CA1291R	14 55			
Beta 2.0 i.e. HPE	[828B4.000]	05.81- 09.84	CA1291R	14 55			
Dedra 1.6	[159B9.000]	10.94- 07.99	CA5961R	14 65	10.94- 07.99	CS975	12 0.9
		AC 10.94- 07.99	CA7121R	14 90	10.94- 07.99	CS285	12 0.8
Dedra 1.6 LE	[159B9.000]	07.94- 04.98	CA5961R	14 65	07.94- 04.98	CS975	12 0.9
		AC 07.94- 04.98	CA7121R	14 90			
Dedra 1.6 16V	[182A4.000]	04.98- 10.99	CA12201R	14 75	04.98- 10.99	CS1191	12 1.4
		AC 04.98- 10.99	CA12211R	14 85			
Dedra 1.6 i.e.	[835A1.000]	08.89- 06.94	CA5961R	14 65	08.89- 06.94	CS536	12 1.0
	[835A1.046]	08.89- 03.93	CA5961R	14 65	08.89- 03.93	CS536	12 1.0
		AC 08.89- 03.93	CA7121R	14 90			
	[835C1.000]	04.93- 12.99	CA5961R	14 65	04.95- 07.99	CS975	12 0.9
		AC 04.93- 12.99	CA7121R	14 90	04.93- 04.95	CS536	12 1.0
Dedra 1.8 16V GT	[183A1.000]	03.96- 07.99	CA11891R	14 100	03.96- 07.99	CS1042	12 1.4
					03.96- 07.99	CS1053	12 1.1
Dedra 1.8 16V LE	[182A2.000]	03.96- 07.99	CA11891R	14 100	03.96- 07.99	CS1053	12 1.1
		03.96- 07.99	CA12161R	14 85			
Dedra 1.8 i.e.	[835A2.000]	09.89- 06.94	CA5061R	14 65	09.89- 06.94	CS584	12 1.4
		AC 09.89- 12.90	CA12341R	14 90			
		AC 12.90- 06.94	CA7271R	14 90			
	[835A2.046]	09.89- 10.94	CA5061R	14 65	09.89- 10.94	CS584	12 1.4
		AC 09.89- 10.94	CA12341R	14 90			
		AC 09.89- 10.94	CA7271R	14 90			
	[836A5.000]	07.94- 07.99	CA5061R	14 65	07.94- 07.99	CS584	12 1.4
		AC 07.94- 07.99	CA12331R	14 100			
Dedra 1.8 i.e. LE	[835C5.000]	08.93- 07.94	CA5061R	14 65	08.93- 07.94	CS584	12 1.4
		AC 08.93- 07.94	CA12341R	14 90			
		AC 08.93- 07.94	CA7271R	14 90			
Dedra 1.9 TDS	[160D1.000]	07.94- 10.99	CA10551R	14 70	07.94- 10.99	CS709	12 2.2
		AC 07.94- 10.99	CA6441R	14 90			
	[835A4.000]	04.89- 07.99	CA10551R	14 70	04.89- 07.99	CS709	12 2.2
		AC 04.89- 07.99	CA6441R	14 90			
	[835A4.046]	04.89- 07.99	CA5061R	14 65	AT 03.89- 10.94	CS709	12 2.2
		AC 10.89- 10.99	CA6441R	14 90			
Dedra 2.0 4WD Integrale	[836A3.000]	07.94- 07.99	CA5061R	14 65	07.94- 07.99	CS584	12 1.4
		AC 07.94- 12.94	CA12341R	14 90			
		AC 12.94- 07.99	CA12331R	14 100			
Dedra 2.0 HF Integrale	[835A7.000]	06.90- 07.92	CA5061R	14 65	06.90- 07.92	CS584	12 1.4
		AC 06.90- 07.92	CA12341R	14 90			



**LANCIA** *Continued*

	[835A7.046]	04.91- 10.94 AC 04.91- 10.94	CA5061R CA1234IR	14 65 14 90		04.91- 10.94	CS584	12 1.4
Dedra 2.0 16V	[836A3.000]	07.94- 07.99 AC 07.94- 12.94 AC 12.94- 07.99	CA5061R CA1234IR CA1233IR	14 65 14 90 14 100		07.94- 07.99	CS584	12 1.4
Dedra 2.0 i.e. Turbo	[835A8.046]	04.91- 10.94 AC 04.91- 10.94	CA5061R CA1234IR	14 65 14 90		04.91- 10.94	CS514	12 1.4
Dedra 2.0 i.e.	[835A5.000]	09.89- 07.92 AC 09.89- 07.92 AC 09.89- 07.92	CA5061R CA1234IR CA7271R	14 65 14 90 14 90		09.89- 07.92	CS514	12 1.4
	[835A5.046]	09.89- 10.99 AC 09.89- 10.99 AC 10.94- 10.99	CA5061R CA1234IR CA1233IR	14 65 14 90 14 100		09.89- 10.94	CS584	12 1.4
Dedra 2.0 i.e. Integrale	[835A7.000]	05.90- 07.94 AC 05.90- 07.94 AC 05.90- 07.94	CA5061R CA1234IR CA7271R	14 65 14 90 14 90		06.90- 07.92	CS584	12 1.4
Dedra 2.0 Turbo	[835A8.000]	11.90- 06.94 AC 11.90- 06.94	CA5061R CA1234IR	14 65 14 90		07.92- 07.92	CS584	12 1.4
Delta 1.1	[831B8.000]	01.86- 12.90	CA2521R	14 55		01.86- 12.90 01.86- 12.90	CS285 CS91	12 0.8 12 0.8
Delta 1.3	[831A2.000]	09.79- 08.92 09.79- 08.92	CA1271R CA2521R	14 45 14 55		09.79- 08.92	CS91	12 0.8
	[831B.000]	09.79- 08.92 09.79- 08.92	CA1271R CA2521R	14 45 14 55		09.79- 08.92	CS91	12 0.8
Delta 1.4	[198A1.000]	09.08-	CA1969IR	14 120		09.08-	CS1379	12 0.8
	[198A4.000]	09.08-	CA1969IR	14 120		09.08-	CS1379	12 0.8
Delta 1.4 16V		07.10-	CA1969IR	14 120		07.10-	CS1379	12 0.8
Delta 1.4 i.e.	[160A1.046]	01.93- 04.94	CA5961R	14 65		01.93- 04.94	CS393	12 0.9
	[836A4.000]	AC 01.93- 04.94 04.94- 12.99 AC 04.94- 12.99	CA7121R CA5961R CA7121R	14 90 14 65 14 90		04.95- 12.99 04.94- 04.95	CS975 CS393	12 0.9 12 0.9
Delta 1.5	[831A1.000]	09.79- 12.92 09.79- 12.92 09.79- 12.92	CA1271R CA2521R CA2541R	14 45 14 55 14 65		09.79- 12.92	CS285	12 0.8
	[831B1.000]	09.79- 12.92 09.79- 12.92 09.79- 12.92	CA1271R CA2521R CA2541R	14 45 14 55 14 65		09.79- 12.92	CS285	12 0.8
Delta 1.6 GT	[831A4.000]	11.82- 04.86 11.82- 04.86	CA1291R CA5061R	14 55 14 65		11.82- 04.86	CS275	12 1.0
Delta 1.6 i.e.	[835C1.000]	06.93- 12.99 AC 06.93- 12.99	CA5961R CA7121R	14 65 14 90		06.93- 04.95 04.95- 12.99	CS393 CS975	12 0.9 12 0.9
Delta 1.6 i.e. GT	[831B7.000]	05.86- 08.92 AC 05.86- 08.92	CA5041R CA5041R	14 65 14 65		05.86- 08.92	CS393	12 0.9
Delta 1.6 i.e. GT Super	[149C2.000]	05.87- 08.92	CA5041R	14 65		05.87- 08.92	CS393	12 0.9
Delta 1.6 i.e. LE	[182A4.000]	01.96- 08.99 AC 01.96- 08.99	CA1220IR CA1221IR	14 75 14 85		01.96- 08.99	CS285	12 0.8
	[182A6.000]	03.96- 08.99 AC 03.96- 08.99	CA1220IR CA1221IR	14 75 14 85		03.96- 08.99	CS975	12 0.9
Delta 1.6 Turbo HF	[831A7.000]	06.83- 04.86	CA1291R	14 55		06.83- 04.86	CS275	12 1.0
	[831B3.000]	05.86- 08.92 AC 05.86- 08.92	CA5041R CA5041R	14 65 14 65		05.86- 08.92	CS393	12 0.9
	[831B7.046]	04.87- 08.92	CA5041R	14 65		04.87- 08.92	CS393	12 0.9
Delta 1.6 Multijet	[198A2.000]	09.08- 09.08- 09.08-	CA1995IR CA2049IR* CA2050IR*	14 140 14 100 14 120		09.08-	CS1264	12 1.7
Delta 1.8	[835C4.000]	02.96- 09.99 AC 02.96- 09.99 AC 02.96- 09.99	CA5061R CA1233IR CA1234IR	14 65 14 100 14 90		02.96- 09.99 02.96- 09.99	CS364 CS584	12 1.1 12 1.4
	[939B1.000]					01.09-	CS1264	12 1.7
Delta 1.8 i.e.	[835C2.000]	06.93- 12.95 AC 06.93- 12.95 AC 06.93- 12.95	CA5061R CA1234IR CA7271R	14 65 14 90 14 90		06.93- 04.94 04.94- 12.95	CS364 CS584	12 1.1 12 1.4
	[835C4.000]	01.93- 12.99 AC 01.93- 12.99 AC 01.93- 12.99	CA5061R CA1233IR CA1234IR	14 65 14 100 14 90		01.93- 04.94 04.94- 12.99	CS364 CS584	12 1.1 12 1.4
	[836A6.000]	01.93- 12.99 AC 01.93- 12.99 AC 01.93- 12.99	CA5061R CA1233IR CA1234IR	14 65 14 100 14 90		01.93- 04.94 04.94- 12.99	CS364 CS584	12 1.1 12 1.4
	[836C4.000]	01.93- 12.99 AC 01.93- 12.99 AC 01.93- 12.99	CA5061R CA1233IR CA1234IR	14 65 14 100 14 90		01.93- 04.94 04.94- 12.99	CS364 CS584	12 1.1 12 1.4
Delta 1.8 i.e. GT	[183A1.000]	03.96- 12.99	CA1189IR	14 100		03.96- 08.99 03.96- 12.99	CS1042 CS1053	12 1.4 12 1.1
Delta 1.8 i.e. LE	[182A2.000]	03.96- 12.99 03.96- 12.99	CA1189IR CA1216IR	14 100 14 85		03.96- 12.99	CS1053	12 1.1
Delta 1.9 Multijet	[844A1.000]	01.09- 01.09- 01.09-	CA1995IR CA2049IR* CA2050IR*	14 140 14 100 14 120				
Delta 1.9 TD	[160D1.000]	10.95- 12.99 AC 10.95- 12.99	CA1055IR CA644IR	14 70 14 90		10.95- 12.99	CS709	12 2.2
	[835A4.000]	07.94- 10.95 AC 07.94- 10.95	CA1055IR CA644IR	14 70 14 90		07.94- 10.95	CS709	12 2.2
Delta 1.9 Turbo DS	[831D1.000]					01.89- 06.91	CS709	12 2.2
Delta 2.0 HF 4WD	[831B5.000]	05.86- 09.87	CA5041R	14 65		05.86- 09.87	CS393	12 0.9
Delta 2.0 HF Integrale 4WD	[831C5.000]	10.87- 02.89 03.89- 12.92	CA5041R CA5061R	14 65 14 65		10.87- 02.89 03.89- 12.92	CS393 CS514	12 0.9 12 1.4
	[831C5.046]	06.93- 12.99 AC 06.93- 12.99 AC 10.94- 12.99	CA5061R CA1233IR CA1234IR	14 65 14 100 14 90		04.94- 12.99 06.93- 04.94	CS584 CS364	12 1.4 12 1.1
Delta 2.0 16V	[836A3.000]	06.93- 12.99 AC 06.93- 12.99 AC 10.94- 12.99	CA5061R CA1233IR CA1234IR	14 65 14 100 14 90		06.93- 04.94 06.93- 04.94	CS584 CS364	12 1.4 12 1.1
Delta 2.0 16V HF Integrale 4WD	[831D5.000]	03.89- 09.91	CA5041R	14 65		03.89- 09.91	CS393	12 0.9
	[831E5.000]	06.91- 12.94	CA5061R	14 65		06.91- 12.94	CS584	12 1.4
	[831E5.046]	06.91- 12.94	CA5061R	14 65		06.91- 12.94	CS514	12 1.4
Delta 2.0 Turbo 16V	[836A2.000]	06.93- 12.99 AC 06.93- 12.99 AC 06.93- 12.99	CA5061R CA1233IR CA1234IR	14 65 14 100 14 90		06.93- 04.94 04.94- 12.99	CS364 CS584	12 1.1 12 1.4
Delta 2.0 Turbo 16V HPE	[175A4.000]	09.96- 12.99 AC 09.96- 12.99	CA5061R CA7271R	14 65 14 90		09.96- 12.99	CS584	12 1.4
Delta 2.0 Multijet	[198A5.000]	09.08- 09.08- 09.08-	CA1995IR CA2049IR* CA2050IR*	14 140 14 100 14 120		AT 09.08-	CS1335	12 2.2
	[844A2.000]	09.08- 09.08-	CA2049IR* CA2050IR*	14 100 14 120		09.08-	CS1335	12 2.2
Delta Iii 1.4 BiFuel	[198A4.000]					07.11-	CS1379	12 0.8



Gamma 2.5	[830A.000]	08.81- 02.82	CA991R	14 55		08.81- 12.84	CS286	12 1.6
		03.82- 12.84	CA3531R	14 65				
	[830A4.000]	08.81- 02.82	CA991R	14 55		08.81- 12.84	CS286	12 1.6
		03.82- 12.84	CA3531R	14 65				
Kappa 2.0 20V	[838A1.000]	10.94- 10.01	CA1223IR	14 100	Chas. 2011951-	10.94- 10.01	CS1195	12 1.4
		AC 10.94- 10.01	CA1452IR	14 120	Chas. 2076973-	10.94- 10.01	CS1042	12 1.4
	[838A6.000]	07.96- 10.01	CA1216IR	14 85	Chas. 2076973-	07.96- 10.01	CS1042	12 1.4
					Chas. 2011951-	07.96- 10.01	CS1195	12 1.4
					07.96- 02.98		CS1195	12 1.4
Kappa 2.0 20V LE	[838A6.000]	07.96- 12.00	CA1216IR	14 85	Chas. 2076973-	07.96- 12.00	CS1042	12 1.4
		07.96- 12.00	CA1223IR	14 100	Chas. 2011951-	07.96- 12.00	CS1195	12 1.4
Kappa 2.0 Turbo 16V	[838A4.000]	11.94- 06.98	CA1216IR	14 85		07.96- 10.01	CS965	12 1.4
		11.94- 06.98	CA1223IR	14 100		02.95- 10.01	CS514	12 1.4
		AC 11.94- 06.98	CA1452IR	14 120				
Kappa 2.0 Turbo 20V	[175A3.000]	06.98- 12.00	CA1216IR	14 85		06.98- 03.01	CS1042	12 1.4
		AC 06.98- 12.00	CA1452IR	14 120				
Kappa 2.4 20V	[838A2.000]	01.94- 01.01	CA1216IR	14 85	Chas. 2076973-	08.94- 11.01	CS1042	12 1.4
		08.94- 11.01	CA1223IR	14 100	Chas. 2011951-	08.94- 11.01	CS1195	12 1.4
		11.96-	CA1452IR	14 120				
		AC 01.94- 01.01	CA1452IR	14 120				
	[838A2.027]	08.94- 11.01	CA1223IR	14 100	Chas. 2011951-	08.94- 10.01	CS1195	12 1.4
				Chas. 2076973-	08.94- 10.01	CS1042	12 1.4	
Kappa 2.4 JTD	[838A8.000]	06.98- 10.01	CA1216IR	14 85	Chas. 2095583-	06.98- 10.01	CS1335	12 2.2
					Chas. -2095582	06.98- 10.01	CS1124	12 2.2
Kappa 2.4 TD	[838A3.000]	08.94- 06.96	CA1311IR	14 100		08.94- 11.01	CS1170	12 2.2
		11.94- 10.01	CA1216IR	14 85				
		11.94- 10.01	CA1223IR	14 100				
		11.94- 10.01	CA1698IR	14 120				
	[838A7.000]	06.96- 10.01	CA1223IR	14 100		06.96- 11.01	CS1170	12 2.2
	07.96- 10.01	CA1216IR	14 85					
Kappa 3.0 24V	[838B.000]	01.94- 11.01	CA1492IR	14 120		08.94- 11.01	CS585	12 1.4
Lybra 1.6	[182B6.000]	10.00- 10.05	CA1485IR	14 80		10.00- 10.05	CS1213	12 1.1 BO
		10.00- 10.05	CA1648IR	14 105		10.00- 10.05	CS1345	12 1.3 VA
		AC 10.00- 10.05	CA1471IR	14 90				
Lybra 1.6 SW	[182B6.000]	10.00- 10.05	CA1485IR	14 80		10.00- 10.05	CS1345	12 1.3
		10.00- 10.05	CA1648IR	14 105		10.00- 10.05	CS1213	12 1.1
		AC 10.00- 10.05	CA1471IR	14 90				
Lybra 1.6 16V	[182A4.000]	07.99- 09.00	CA1485IR	14 80		07.99- 09.00	CS1191	12 1.4
		07.99- 09.00	CA1648IR	14 105		07.99- 09.00	CS1213	12 1.1
		AC 07.99- 09.00	CA1471IR	14 90				
Lybra 1.8 16V	[839A4.000]	07.99- 09.00	CA1223IR	14 100		07.99- 09.00	CS1053	12 1.1
		07.99- 09.00	CA1743IR	14 90				
	[839A7.000]	09.00- 02.02	CA1223IR	14 100		09.00- 02.02	CS1053	12 1.1
		09.00- 02.02	CA1743IR	14 90				
	[839A9.000]	02.02-	CA1743IR	14 90		07.99-	CS1053	12 1.1
		07.99- 02.02	CA1223IR	14 100				
Lybra 1.9 JTD	[937A2.000]	05.01-	CA1558IR	14 100		05.01-	CS1045	12 2.0
		AC 05.01-	CA1698IR	14 120				
	[AR32302]	07.99- 09.00	CA1189IR	14 100		07.99- 09.00	CS1045	12 2.0
		07.99- 09.99	CA1216IR	14 85				
		07.99- 09.00	CA1558IR	14 100				
		AC 07.99- 09.99	CA1223IR	14 100				
		AC 07.99- 09.00	CA1698IR	14 120				
	A17 07.99- 09.00	CA1698IR	14 120					
	[AR37101]	09.00-	CA1558IR	14 100		09.00-	CS1045	12 2.0
		09.00-	CA1698IR	14 120				
Lybra 1.9 JTD SW	[AR37101]	09.00-	CA1558IR	14 100		09.00-	CS1045	12 2.0
		09.00-	CA1698IR	14 120				
Lybra 2.0 20V	[182B7.000]	07.99- 09.00	CA1222IR	14 85		07.99- 09.00	CS1053	12 1.1
		AC 07.99- 09.00	CA1451IR	14 100				
	[185A8.000]	09.00-	CA1222IR	14 85		09.00-	CS1053	12 1.1
	[185A8.000]	09.00-	CA1222IR	14 85		09.00-	CS1053	12 1.1
Lybra 2.4 JTD	[839A5.000]	10.99- 09.00	CA1698IR	14 120		10.99- 09.00	CS1335	12 2.2
						10.99- 09.00	CS1045	12 2.0
	[839A6.000]	09.00-	CA1698IR	14 120		09.00- 05.02	CS1335	12 2.2
						09.00- 05.02	CS1045	12 2.0
	[841C.000]	06.02-	CA1698IR	14 120		05.02-	CS1335	12 2.2
	[AR32501]	10.99- 09.00	CA1698IR	14 120		10.99- 09.00	CS1335	12 2.2
					10.99- 09.00	CS1045	12 2.0	
Lybra 2.4 JTD SW	[839A6.000]	09.00-	CA1698IR	14 120		09.00- 05.02	CS1335	12 2.2
						09.00- 05.02	CS1045	12 2.0
Musa 1.3 Diesel Multijet	[188A9.000]	10.04-	CA1856IR	14 75		10.04-	CS1346	12 1.3
		10.04-	CA1934IR	14 105				
		AC 10.04-	CA1862IR	14 90				
Musa 1.3 Multijet	[199A3.000]	09.06-	CA1856IR	14 75		09.06-	CS1346	12 1.3
		AC 09.06-	CA1862IR	14 90		09.06-	CS1334	12 1.1
		AC 09.06-	CA1934IR	14 105				
	[199B1.000]	08.09-	CA1862IR	14 90				
	A25 08.09-	CA1935IR	14 120					
Musa 1.4	[192B2.000]	10.07-	CA1742IR	14 85		10.07-	CS1379	12 0.8
		A25 10.07-	CA2070IR*	14 140				
	[350A1.000]	09.05-	CA1766IR	14 75		09.05-	CS1379	12 0.8
	[843A1.000]	10.04-	CA1742IR	14 85		10.04-	CS1379	12 0.8
	[350A1.000]	11.10-	CA1766IR	14 75		11.10-	CS1379	12 0.8
Musa 1.6 Multijet	[350A2.000]	07.08-	CA2049IR*	14 100		07.08-	CS1264	12 1.7
		07.08-	CA2050IR*	14 120				
	[350A3.000]	07.08-	CA2049IR*	14 100		07.08-	CS1264	12 1.7
	A25 07.08-	CA2050IR*	14 120					
Musa 1.9 Diesel Multijet	[188B2.000]	10.04-	CA1558IR	14 100		10.04-	CS1264	12 1.7
		10.04-	CA1698IR	14 120				
		10.04-	CA2048IR	14 90				
Phedra 2.0	[RFN (EW10J4)]	09.02-	CA1674IR	14 150		09.02-	CS1244	12 1.1
						A13 09.02-	CS1277	12 1.4
Phedra 2.0 JTD	[RHK]	06.06-	CA1761IR	14 150		06.06-	CS1326	12 2.3
						06.06-	CS1177	12 1.7
	[RHM]	07.03-	CA1553IR	14 150		A13 07.03-	CS712	12 2.2
						07.03-	CS1177	12 1.7
						07.03-	CS594	12 1.4
	[RHW (DW10ATED4)]	09.02-	CA1553IR	14 150		09.02-	CS1177	12 1.7
						09.02-	CS373	12 1.7
						09.02-	CS594	12 1.4
Phedra 2.0 Multijet	[RHR]	07.06-	CA1761IR	14 150		07.06-	CS1177	12 1.7
		07.06-	CA1920IR	14 180		A13 07.06-	CS1326	12 2.3
						A13 07.06-	CS570	12 3.1



**LANCIA** *Continued*

						07.06-	CS373	12 1.7
						07.06-	CS594	12 1.4
Phedra 2.2 JTD	[4HW (DW12ATED4)]	09.02-	CA1761IR	14 150		09.02-	CS594	12 1.4
		09.02-	CA1920IR	14 180		09.02-	CS1177	12 1.7
Phedra 2.2 Multijet		03.08-	CA1761IR	14 150		03.08-	CS1416	12 2.5
		03.08-	CA1920IR	14 180				
Phedra 3.0 V6	[ES9J4S]	09.02-	CA1388IR	14 150		09.02-	CS1290	12 1.3
		09.02-	CA1392IR	14 120				
Prisma 1.3		12.82-	CA252IR	14 55		12.82- 04.86	CS91	12 0.8
Prisma 1.5	[138C2.048]	09.85-	CA252IR	14 55		09.85- 02.92	CS285	12 0.8
		09.85-	CA254IR	14 65				
	[831A1.000]	12.82-	CA254IR	14 65		AT 12.82- 04.86	CS133	12 0.9
						12.82- 04.86	CS285	12 0.8
	[831B1.000]	05.86-	CA252IR	14 55		05.86- 12.89	CS285	12 0.8
		05.86-	CA254IR	14 65		AT 05.86- 12.89	CS133	12 0.9
	[831B1.048]	05.86-	CA252IR	14 55		05.86- 12.89	CS285	12 0.8
		05.86-	CA254IR	14 65				
Prisma 1.6	[831A4.000]	12.82-	CA129IR	14 55		12.82- 04.86	CS275	12 1.0
		12.82-	CA254IR	14 65				
	[831B6.000]	05.86-	CA504IR	14 65		05.86- 12.89	CS393	12 0.9
Prisma 1.6 i.e.	[831B7.000]	05.86-	CA504IR	14 65		05.86- 12.89	CS393	12 0.9
Prisma 1.6 i.e. Super	[149C2.000]	05.87-	CA504IR	14 65		05.87- 12.89	CS393	12 0.9
Prisma 1.9 Diesel	[831D.000]	06.84-	CA129IR	14 55		02.89- 12.89	CS709	12 2.2
		06.84-	CA1435IR	14 55				
		AC 06.84-	CA506IR	14 65				
Prisma 1.9 TD	[831D1.000]	05.85-	CA601IR	14 65		02.89- 12.89	CS709	12 2.2
Prisma 2.0 i.e. 4WD	[831B4.000]	04.86-	CA596IR	14 65		04.86- 12.89	CS393	12 0.9
Thema 2.0 16V	[834F1.000]	05.92-	CA1234IR	14 90		05.92- 07.94	CS393	12 0.9
		05.92-	CA727IR	14 90		AT 05.92- 11.94	CS514	12 1.4
		AC 05.92-	CA700IR	14 115				
Thema 2.0 i.e. 16V	[834B2.000]	05.88-	CA506IR	14 65		AT 05.88- 08.92	CS514	12 1.4
		05.88-	CA569IR	14 85		05.88- 08.92	CS393	12 0.9
		AC 05.88-	CA727IR	14 90				
	[834B2.246]	02.89-	CA727IR	14 90		AT 02.89- 05.92	CS514	12 1.4
						02.89- 05.92	CS393	12 0.9
Thema 2.0 i.e. Turbo 16V	[834C1.000]	12.88-	CA506IR	14 65		AT 12.88- 06.90	CS514	12 1.4
		12.88-	CA569IR	14 85		12.88- 06.90	CS393	12 0.9
		AC 12.88-	CA727IR	14 90				
	[834C1.246]	04.89-	CA727IR	14 90		04.89- 05.92	CS393	12 0.9
						AT 04.89- 05.92	CS514	12 1.4
						04.89- 05.92	CS514	12 1.4
Thema 2.0 i.e. Turbo	[834B2.246]	02.89-	CA506IR	14 65		AT 02.89- 05.92	CS514	12 1.4
		02.89-	CA569IR	14 85		02.89- 05.92	CS393	12 0.9
	[834C.000]	11.84-	CA506IR	14 65		11.84- 09.88	CS393	12 0.9
		11.84-	CA569IR	14 85		11.84- 12.87	CS514	12 1.4
		AT 12.85-	CA506IR	14 65				
		AC 04.88-	CA727IR	14 90				
	[834C.146]	07.86-	CA506IR	14 65		07.86- 05.90	CS393	12 0.9
		07.86-	CA569IR	14 85		AT 07.86- 05.90	CS514	12 1.4
		AC 04.88-	CA727IR	14 90				
Thema 2.0 i.e.	[834B.000]	11.84-	CA506IR	14 65		AT 11.84- 09.88	CS514	12 1.4
		11.84-	CA569IR	14 85		11.84- 09.88	CS393	12 0.9
		AT 12.85-	CA506IR	14 65				
	[834B.048]	03.86-	CA506IR	14 65		03.86- 09.88	CS393	12 0.9
						AT 03.86- 09.88	CS514	12 1.4
	[834B.146]	09.87-	CA506IR	14 65		09.87- 09.88	CS393	12 0.9
						AT 09.87- 09.88	CS514	12 1.4
						09.87- 05.92	CS514	12 1.4
	[834B1.000]	09.88-	CA506IR	14 65		AT 09.88- 05.92	CS514	12 1.4
		AC 09.88-	CA727IR	14 90		09.88- 05.92	CS393	12 0.9
Thema 2.0 Turbo 16V	[834C.1000]	06.88-	CA506IR	14 65		AT 06.88- 05.92	CS514	12 1.4
		AC 06.88-	CA700IR	14 115		06.88- 05.92	CS393	12 0.9
		AC 06.88-	CA727IR	14 90				
	[834C.146]	06.88-	CA569IR	14 85		AT 06.88- 03.92	CS514	12 1.4
						01.89- 03.92	CS393	12 0.9
	[834C1.246]	04.89-	CA506IR	14 65		04.89- 05.92	CS393	12 0.9
		AC 04.89-	CA700IR	14 115		AT 04.89- 03.93	CS514	12 1.4
		AC 04.89-	CA727IR	14 90				
	[834F2.000]	05.92-	CA1234IR	14 90		10.92- 07.94	CS393	12 0.9
		05.92-	CA727IR	14 90		AT 05.92- 11.94	CS514	12 1.4
		AC 05.92-	CA700IR	14 115				
Thema 2.5 TD	[8144.91]	11.84-	CA355IR	14 65		11.84- 09.88	CS351	12 2.2
		11.84-	CA569IR	14 85				
	[8144.97]	06.88-	CA355IR	14 65		06.88- 05.92	CS351	12 2.2
		06.88-	CA569IR	14 85				
	[8144.97S]	05.88-	CA355IR	14 65		05.88- 07.92	CS351	12 2.2
		05.88-	CA569IR	14 85				
	[8144.97Y]	05.92-	CA569IR	14 85		05.92- 11.94	CS351	12 2.2
Thema 2.5 TDS	[8144.97]	06.88-	CA355IR	14 65		06.88- 05.92	CS351	12 2.2
		06.88-	CA569IR	14 85				
	[8144.97S]	05.92-	CA569IR	14 85		05.92- 07.94	CS351	12 2.2
Thema 2.8 i.e. V6	[834E.000]	11.84-	CA569IR	14 85				
		AC 11.84-	CA700IR	14 115				
	[834E.146]	06.88-	CA569IR	14 85				
		AC 06.88-	CA700IR	14 115				
Thema 2.9	[F105L]	09.87-	CA569IR	14 85				
	[F105L.046]	10.87-	CA569IR	14 85				
Thema 3.0 V6	[834F.000]					05.92- 11.94	CS585	12 1.4
Thesis 2.0 Turbo	[841E.000]					04.02-	CS1042	12 1.4
Thesis 2.4	[841D.000]					07.02-	CS1042	12 1.4
Thesis 2.4 Diesel Multijet	[841P.000]	04.06-	CA2062IR*	14 140		04.06-	CS1042	12 1.4
Thesis 2.4 JTD	[841C.000]	07.02-	CA2062IR*	14 140		04.02-	CS1335	12 2.2
						04.02-	CS1045	12 2.0
	[841G.000]	05.03-	CA2062IR*	14 140		05.03-	CS1335	12 2.2
Thesis 3.0 V6	[841A.000]					04.02-	CS585	12 1.4
Thesis 3.2 V6	[841L.000]					06.03-	CS585	12 1.4
Trevi 1.6	[828B.000]	05.80-	CA129IR	14 55				
Trevi 2.0 Iniezione	[828B4.000]	05.80-	CA129IR	14 55				
Trevi 2.0 Volumex	[828B7.000]	06.82-	CA129IR	14 55				
Y 1.1	[176B2.000]	11.95-	CA890IR	14 65		11.95- 06.00	CS796	12 0.8
		ACPS 11.95-	CA1154IR	14 75				
Y 1.2	[188A4.000]	03.96-	CA2061IR*	14 75		06.00- 06.03	CS1192	12 0.8
		03.96-	CA890IR	14 65		03.00- 06.00	CS796	12 0.8
		PS 03.96-	CA1153IR	14 65				



		ACPS 03.96- 09.03	CA1154IR	14 75					
		AC 06.00- 06.03	CA1766IR	14 75					
	[840A3.000]	03.96- 09.03	CA2061IR*	14 75		03.96- 09.03	CS796	12 0.8	
		03.96- 09.03	CA890IR	14 65		AT 03.96- 09.03	CS1076	12 0.8	
		PS 03.96- 09.03	CA1153IR	14 65					
		ACPS 03.96- 09.03	CA1154IR	14 75					
Y 1.2 16V	[176B9.000]	04.97- 06.00	CA1349IR	14 65		04.97- 06.00	CS796	12 0.8	
		04.97- 06.00	CA1350IR	14 85					
	[188A5.000]	AC 10.00- 09.03	CA1742IR	14 85		10.00- 09.03	CS1192	12 0.8	
		AC 10.00- 09.03	CA1766IR	14 75					
Y 1.4 12V	[840A2.000]	01.96- 06.00	CA1160IR	14 65		01.96- 06.00	CS1052	12 0.9	
		AC 01.96- 06.00	CA1159IR	14 85					
	[840A4.000]	03.96- 09.03	CA1160IR	14 65		03.96- 09.03	CS1052	12 0.9	
		ACPS 03.96- 09.03	CA1159IR	14 85					
Y10 1.0 Fire	[156A2.000]	03.85- 06.89	CA350IR	14 45		03.85- 06.89	CS371	12 0.9	
		03.85- 06.89	CA572IR	14 55					
	[156A2.100]	03.89- 06.91	CA350IR	14 45		03.89- 06.91	CS371	12 0.9	
	[156A2.246]	10.87- 02.92	CA350IR	14 45		10.87- 02.92	CS371	12 0.9	
		10.87- 02.92	CA572IR	14 55					
Y10 1.0 Fire 4WD	[156A2.000]	Eng. 10058449- 09.86- 02.89	CA572IR	14 55		09.86- 02.89	CS371	12 0.9	
		Eng. -10058448 09.86- 02.89	CA350IR	14 45					
	[156A2.100]	03.89- 06.91	CA350IR	14 45		03.89- 06.91	CS371	12 0.9	
	[156A2.246]	Eng. 10058449- 12.87- 02.92	CA572IR	14 55		12.87- 02.92	CS371	12 0.9	
		Eng. -10058448 12.87- 02.92	CA350IR	14 45					
Y10 1.0 Turbo	[156A1.000]	03.85- 02.89	CA252IR	14 55		03.85- 02.89	CS975	12 0.9	
Y10 1.1 Avenue	[176B2.000]	09.92- 12.95	CA572IR	14 55		09.92- 09.95	CS371	12 0.9	
		AC 09.92- 12.95	CA504IR	14 65		09.95- 12.95	CS796	12 0.8	
Y10 1.1 Avenue 4WD	[176B2.000]	09.92- 12.95	CA572IR	14 55		09.95- 12.95	CS796	12 0.8	
		AC 09.92- 12.95	CA504IR	14 65		09.92- 09.95	CS371	12 0.9	
Y10 1.1 i.e.	[156C.000]	01.89- 09.92	CA572IR	14 55		01.89- 09.92	CS371	12 0.9	
Y10 1.1 i.e. 4WD	[156C.000]	01.89- 09.92	CA572IR	14 55		01.89- 09.92	CS371	12 0.9	
Y10 1.1 i.e. Fire	[156C.046]	07.89-	CA851IR	14 65	▲	10.92-	CS963	12 0.8	
						07.89-	CS371	12 0.9	
						10.92-	CS796	12 0.8	
Y10 1.1 i.e. Fire 4WD	[156C.046]	09.92- 12.95	CA851IR	14 65	▲	09.92- 12.95	CS796	12 0.8	
		AC 09.92- 12.95	CA504IR	14 65		09.92- 12.95	CS963	12 0.8	
Y10 1.3 i.e. Fire	[146A5.046]	11.87-	CA254IR	14 65		11.87-	CS147	12 0.8	
	[156B.000]	11.87-	CA254IR	14 65		11.87-	CS147	12 0.8	
Ypsilon 1.2	[169A4.000]	05.11-	CA1766IR	14 75					
		05.11-	CA2070IR*	14 140					
		05.11-	CA2096IR*	14 105					
	[169A5.000]	08.10-	CA1742IR	14 85		08.10-	CS1379	12 0.8	
	[188A4.000]	06.03-	CA1844IR	14 70		06.03-	CS1379	12 0.8	
		AC 06.03-	CA1742IR	14 85					
	[188A5.000]	10.03-	CA1843IR	14 60		10.03-	CS1379	12 0.8	
		10.03-	CA1844IR	14 70					
		AC 10.03-	CA1742IR	14 85					
Ypsilon 1.3 Diesel Multijet	[199A2.000]	09.06-	CA1856IR	14 75		09.06-	CS1346	12 1.3	
		AC 09.06-	CA1855IR	14 75					
		AC 09.06-	CA1862IR	14 90					
	[199A3.000]	09.06-	CA1856IR	14 75		09.06-	CS1346	12 1.3	
		AC 09.06-	CA1855IR	14 75					
		AC 09.06-	CA1862IR	14 90					
Ypsilon 1.3 JTD	[188A9.000]	10.03-	CA1856IR	14 75		10.03-	CS1346	12 1.3	
		AC 10.03-	CA1862IR	14 90					
Ypsilon 1.3 Multijet	[199A3.000]	05.07-	CA1855IR	14 75		05.07-	CS1346	12 1.3	
Ypsilon 1.4	[350A1.000]	02.06-	CA1886IR	14 70		02.06-	CS1379	12 0.8	
		AC 02.06-	CA1766IR	14 75					
	[843A1.000]	AC 10.03-	CA1742IR	14 85		10.03-	CS1379	12 0.8	
Ypsilon 1.4 LPG	[350A1.000]	11.10-	CA1766IR	14 75					
		11.10-	CA1886IR	14 70					
Zeta 2.0 16V	[RFN (EW10J4)]	07.00- 09.02	CA1151IR	14 70		A13 07.00- 09.02	CS1277	12 1.4	
		07.00- 09.02	CA1152IR	14 80		07.00- 09.02	CS1244	12 1.1	
	[RFV]	06.99- 10.00	CA1151IR	14 70		05.98- 07.00	CS566	12 1.1	
		06.99- 10.00	CA1152IR	14 80					
Zeta 2.0 Turbo	[RGX]	05.95- 11.96	CA1086IR	14 80		05.95- 06.99	CS566	12 1.1	
		05.95- 11.96	CA820IR	14 70					
		05.95- 11.96	CA825IR	14 95					
		05.95- 11.96	CA836IR	14 120					
		12.96- 09.02	CA1052IR	14 90					
		12.96- 09.02	CA1152IR	14 80					
		12.96- 09.02	CA1156IR	14 120					
		02.97- 06.99	CA1151IR	14 70					
Zeta 2.0 JTD	[RHW (DW10ATED4)]	10.00- 06.02	CA1509IR	14 150		10.00- 06.02	CS1177	12 1.7	
		10.00- 06.02	CA1564IR	14 90					
	[RHZ]	04.00- 09.02	CA1509IR	14 150		04.00- 09.02	CS594	12 1.4	
		04.00- 09.02	CA1564IR	14 90		04.00- 09.02	CS342#	12 1.5	
		04.00- 09.02	CA1646IR	14 120		04.00- 09.02	CS1177	12 1.7	
Zeta 2.1 TD	[P8C]	05.96- 06.99	CA1043IR	14 80		05.96- 09.99	CS373	12 1.7	
		05.96- 09.99	CA1065IR	14 95					
		05.96- 09.99	CA1098IR	14 120					
<b>PASSENGER CARS US</b>									
Beta 1.8		01.76- 01.78	CA129IR	14 55					
Beta 1.8 HPE		01.76- 01.78	CA129IR	14 55					
Beta 2.0		01.79- 01.81	CA129IR	14 55					
		01.81- 01.81	CA195IR	14 65					
Beta 2.0 HPE		01.79- 01.79	CA129IR	14 55					
Zagato 2.0		01.81- 01.82	CA195IR	14 65					
		01.81- 01.82	CA129IR	14 55					
<b>Land Rover</b>									
<b>PASSENGER CARS EU</b>									
Defender 2.4 TD TD4		05.07-	CA1922IR	14 150		Chas. -8A766665 05.07-	CS1421	12 2.0	
Defender 2.5 4WD	[TD5]	06.98-	JA1710IR	14 120		06.98-	CS1242	12 2.2	
Defender 2.5 Diesel 4x4						09.90- 09.01	CS1201	12 2.2	
Defender 2.5 TD5 4WD		06.98-	JA1710IR	14 120		06.98-	CS1242	12 2.2	
Defender 2.5 TDi 90	[23L]	09.90- 12.01	CA126IR	14 45		10.95- 12.01	CS543	12 3.1	
		09.90- 12.01	CA560IR	14 70		09.90- 12.01	CS590#	12 2.1	
						09.90- 12.01	CS1201	12 2.2	
Defender 2.5 TDi 90 110	[23L]	09.90- 12.01	CA126IR	14 45		10.95- 12.01	CS543	12 3.1	
		09.90- 12.01	CA560IR	14 70		09.90- 12.01	CS590#	12 2.1	
						09.90- 12.01	CS1201	12 2.2	
Defender 3.5 4x4	[22D]					09.90- 12.98	CS1049	12 1.7	
						09.90- 12.98	CS589	12 1.4	



LAND ROVER *Continued*

						09.90- 12.98	<b>CS589</b>	12	1.4		
						09.90- 12.98	<b>CS1049</b>	12	1.7		
Defender 3.5 V8			08.90- 12.98	<b>CA325IR</b>	14	70		01.93- 12.98	<b>CS1049</b>	12	1.7
			08.90- 12.98	<b>CA629IR#</b>	14	45		08.90- 01.93	<b>CS589</b>	12	1.4
Defender 3.9 V8			09.95- 12.01	<b>CA1380IR</b>	14	100		09.95- 12.01	<b>CS1049</b>	12	1.7
Discovery 2.0 16V		Chas. -MA 163103	10.93- 06.98	<b>CA1380IR</b>	14	100		10.93- 06.98	<b>CS329</b>	12	1.4
Discovery 2.5 TD	[10P]		01.99-	<b>JA1710IR</b>	14	120		01.99-	<b>CS1242</b>	12	2.2
Discovery 2.5 TDi	[12L]		09.89- 09.94	<b>CA1191IR</b>	14	100		09.89- 09.94	<b>CS543</b>	12	3.1
								09.89- 09.94	<b>CS1201</b>	12	2.2
	[21L]		09.89- 09.94	<b>CA1191IR</b>	14	100		09.89- 09.94	<b>CS543</b>	12	3.1
								09.89- 09.94	<b>CS1201</b>	12	2.2
Discovery 2.7 TD			10.04-	<b>CA1958IR</b>	14	150		10.04-	<b>CS1468*</b>	12	2.0
Discovery 2.7 TD TDV6	[276DT]							09.09-	<b>CS1468*</b>	12	2.0
Discovery 3.5	[22D]		09.89- 06.94	<b>CA325IR</b>	14	70		09.89- 06.94	<b>CS589</b>	12	1.4
								09.89- 06.94	<b>CS587#</b>	12	1.4
Discovery 3.9 V8	[35D]		09.93- 06.94	<b>CA1380IR</b>	14	100		09.93- 06.94	<b>CS587#</b>	12	1.4
								09.93- 06.94	<b>CS589</b>	12	1.4
	[36D]		09.93- 06.94	<b>CA1380IR</b>	14	100		09.93- 06.94	<b>CS587#</b>	12	1.4
								09.93- 06.94	<b>CS589</b>	12	1.4
Discovery 4.0 V6 4x4	[406PN]							10.04-	<b>CS1049</b>	12	1.7
Discovery 4.0 V8	[OHV]							11.98-	<b>CS1049</b>	12	1.7
Freelander 1.8 16V	[18K4F]	Chas. -YA999999	11.00-	<b>CA2074IR*</b>	14	100		11.00-	<b>JS1350</b>	12	1.2
		Chas. 1A000001-	11.00-	<b>JA1723IR</b>	14	90					
		AC 11.00-		<b>CA2075IR*</b>	14	105					
Freelander 1.8 i 16V	[18K4F]	Chas. -YA999999	09.97- 11.00	<b>CA2074IR*</b>	14	100		09.97-	<b>JS1350</b>	12	1.2
		Chas. 1A000001-	02.98- 11.00	<b>JA1723IR</b>	14	90					
		AC 02.98-	11.00	<b>CA2075IR*</b>	14	105					
Freelander 2.0 Diesel Di			09.97- 09.03	<b>JA1425IR</b>	14	80		09.97- 09.03	<b>JS1314</b>	12	1.7
			09.97- 09.03	<b>JA1424IR</b>	14	90		02.98- 11.00	<b>JS1149</b>	12	1.8
Freelander 2.0 TD4	[M47]		11.00-	<b>CA1559IR</b>	14	120		11.00-	<b>JS1321</b>	12	2.0
			11.00-	<b>CA1631IR</b>	14	110					
		Chas. 3A259336-	11.00-	<b>CA1757IR</b>	14	150	▲				
		Chas. -3A259335	11.00-	<b>CA1756IR</b>	14	150					
			11.01-	<b>CA1631IR</b>	14	110		11.01-	<b>JS1321</b>	12	2.0
		Chas. -3A259335	11.01-	<b>CA1756IR</b>	14	150					
			11.01-	<b>CA1559IR</b>	14	120					
		Chas. 3A259336-	11.01-	<b>CA1757IR</b>	14	150	▲				
Freelander 2.5 V6	[25K4F]							11.00-	<b>JS1320</b>	12	2.0
Land Rover 2.5			09.85- 01.87	<b>CA18h</b>	14	43					
			01.87- 07.90	<b>CA126IR</b>	14	45					
Land Rover 2.5 TD			09.86- 07.90	<b>CA126IR</b>	14	45		09.86- 07.90	<b>CS1201</b>	12	2.2
			09.86- 07.90	<b>CA629IR#</b>	14	45		09.86- 07.90	<b>CS543</b>	12	3.1
								09.86- 07.90	<b>CS590#</b>	12	2.1
Land Rover 3.5 V8								09.83- 01.85	<b>CS587#</b>	12	1.4
								01.86- 07.90	<b>CS589</b>	12	1.4
LR 109 DP 2.3 Diesel			09.63- 12.86	<b>CA17h</b>	14	34					
			01.82- 12.86	<b>CA18h</b>	14	43					
LR 109 OL 2.3			09.63- 12.86	<b>CA17h</b>	14	34					
LR 109 OP 2.3			09.63- 12.86	<b>CA17h</b>	14	34					
LR 88 DL 2.3 Diesel			09.63- 12.86	<b>CA17h</b>	14	34					
			01.82- 12.86	<b>CA18h</b>	14	43					
Range Rover 2.4 Diesel	[11A]		04.86- 12.90	<b>CA560IR</b>	14	70		04.86- 12.90	<b>CS1073</b>	12	2.4
Range Rover 2.4 TD 4x4			04.86- 07.94	<b>CA627IR</b>	14	65		04.86- 07.94	<b>CS1073</b>	12	2.4
			04.86- 07.94	<b>CA1191IR</b>	14	100					
			04.86- 07.94	<b>CA629IR#</b>	14	45					
Range Rover 2.5 Diesel	[14L]		08.94- 12.95	<b>CA1191IR</b>	14	100		08.94- 04.96	<b>CS1201</b>	12	2.2
	[256T]		01.96- 04.96	<b>CA1337IR</b>	14	100					
			07.94- 09.02	<b>CA1191IR</b>	14	100		07.94- 09.02	<b>CS378</b>	12	2.2
			07.94- 09.02	<b>CA1337IR</b>	14	100					
Range Rover 2.7 TDVM Sport	[276DT]		02.05-	<b>CA1958IR</b>	14	150		02.05-	<b>CS1468*</b>	12	2.0
Range Rover 3.0 TD			03.02-	<b>CA1584IR</b>	14	150		03.02-	<b>CS1171</b>	12	2.2
Range Rover 3.5	[31D]		01.87- 09.90	<b>CA305IR</b>	14	55		01.87- 09.90	<b>CS589</b>	12	1.4
			01.87- 09.90	<b>CA325IR</b>	14	70		01.87- 09.90	<b>CS1049</b>	12	1.7
			01.87- 09.90	<b>CA626IR</b>	14	75					
			01.87- 09.90	<b>CA627IR</b>	14	65					
			07.70- 01.76	<b>CA17v</b>	14	34		07.70-	<b>CS587#</b>	12	1.4
			01.72- 01.79	<b>CA18v</b>	14	43					
Range Rover 3.5 Vogue	[11D]		08.81- 09.90	<b>CA305IR</b>	14	55		08.81- 09.90	<b>CS1049</b>	12	1.7
			08.81- 09.90	<b>CA325IR</b>	14	70		08.81- 09.90	<b>CS589</b>	12	1.4
			08.81- 09.90	<b>CA626IR</b>	14	75					
			08.81- 09.90	<b>CA627IR</b>	14	65					
	[24D]		10.85- 09.90	<b>CA305IR</b>	14	55		10.85- 09.90	<b>CS589</b>	12	1.4
			10.85- 09.90	<b>CA325IR</b>	14	70					
			10.85- 09.90	<b>CA626IR</b>	14	75					
	[25D]		10.85- 09.90	<b>CA305IR</b>	14	55		10.85- 09.90	<b>CS589</b>	12	1.4
			10.85- 09.90	<b>CA325IR</b>	14	70					
			10.85- 09.90	<b>CA626IR</b>	14	75					
Range Rover 3.9	[37D]							11.88- 04.96	<b>CS1049</b>	12	1.7
								11.88- 09.94	<b>CS589</b>	12	1.4
	[38D]		11.88- 08.94	<b>CA1380IR</b>	14	100	▲	11.88- 04.96	<b>CS1049</b>	12	1.7
								11.88- 09.94	<b>CS589</b>	12	1.4
	[42D]		07.94- 09.02	<b>CA1380IR</b>	14	100	▲	07.94- 09.02	<b>CS1049</b>	12	1.7
Range Rover 3.9 Vogue SEI	[35D]		09.94- 04.96	<b>CA1380IR</b>	14	100	▲	09.94- 04.96	<b>CS1049</b>	12	1.7
								09.94- 04.96	<b>CS589</b>	12	1.4
	[36D]		09.94- 04.96	<b>CA1380IR</b>	14	100	▲	09.94- 04.96	<b>CS589</b>	12	1.4
								09.94- 04.96	<b>CS1049</b>	12	1.7
Range Rover 4.0	[42D]		09.94- 09.02	<b>CA1380IR</b>	14	100		09.94- 09.02	<b>CS1049</b>	12	1.7
Range Rover 4.3 Vogue LSE	[40D]							09.92- 04.96	<b>CS1049</b>	12	1.7
Range Rover 4.6	[46D]		07.94- 09.02	<b>CA1380IR</b>	14	100	▲	07.94- 09.02	<b>CS1049</b>	12	1.7
<b>PASSENGER CARS US</b>											
Defender 3.9								01.93- 01.95	<b>CS589</b>	12	1.4
Discovery 3.9			01.94- 01.95	<b>CA1380IR</b>	14	100		01.94- 01.95	<b>CS589</b>	12	1.4
Range Rover 3.5								01.87- 01.88	<b>CS589</b>	12	1.4
Range Rover 3.9								01.89- 01.94	<b>CS589</b>	12	1.4
Range Rover 4.2 LWB								01.93- 01.94	<b>CS589</b>	12	1.4
<b>PASSENGER CARS AO</b>											
Defender 2.5 Country 4WD	[17H]		09.90- 12.94	<b>CA1191IR</b>	14	100		09.90- 12.94	<b>CS1201</b>	12	2.2
			09.90- 12.94	<b>CA126IR</b>	14	45					
			09.90- 12.94	<b>CA560IR</b>	14	70					
Defender 3.5 4WD	[11D]		09.90- 08.93	<b>CA325IR</b>	14	70		09.90- 08.93	<b>CS589</b>	12	1.4
			09.90- 08.93	<b>CA629IR#</b>	14	45		09.90- 08.93	<b>CS1049</b>	12	1.7
Range Rover 2.4 TD Classic 4WD			10.89- 02.92	<b>CA560IR</b>	14	70		10.89- 02.92	<b>CS1073</b>	12	2.4





Range Rover 2.5 Diesel 4WD	[14L]	09.91- 04.94	CA1191IR	14 100	09.91- 04.94	CS1201	12 2.2
		09.91- 04.94	CA560IR	14 70			
		10.89- 04.94	CA560IR	14 70	10.89- 04.94	CS1073	12 2.4
		10.89- 04.94	CA1191IR	14 100			
<b>LDV</b>							
<b>PASSENGER CARS EU</b>							
200 2.0 Diesel		11.86- 12.98	CA627IR	14 65			
		11.86- 12.98	CA600IR	14 55			
400 2.5 TD					11.95-	CS524	12 2.2
Convoy 2.5 TDi	[ET70]	10.98-	CA1317IR	14 95	10.98-	CS977	12 2.3
Sherpa 1.6	[KB16]	03.74- 09.78	CA17h	14 34			
		03.74- 09.78	CA18h	14 43			
Sherpa 1.7	[KB17]	10.78- 12.82	CA18h	14 43			
Sherpa 1.8	[G18A]	01.83- 01.84	CA18h	14 43			
		01.84- 09.88	CA629IR#	14 45			
		01.87- 09.88	CA627IR	14 65			
Sherpa 1.8 Diesel	[KD18]	03.74- 12.82	CA17h	14 34			
		03.74- 12.82	CA18h	14 43			
Sherpa 2.0	[G20A]	01.83- 01.84	CA18h	14 43			
		01.84- 09.88	CA627IR	14 65			
		01.84- 09.88	CA629IR#	14 45			
Sherpa 2.0 Diesel		01.86- 01.89	CA600IR	14 55			
		01.86- 01.89	CA627IR	14 65			
Sherpa 2.6 Diesel	[K25D]	01.83- 01.86	CA18h	14 43			
		01.86- 09.88	CA627IR	14 65			
Sherpa 3.5		01.83- 09.88	CA627IR	14 65			
<b>LDV International</b>							
<b>TRUCKS EU</b>							
6.13					08.88- 09.90	CS889	12 2.8
<b>Lexus</b>							
<b>PASSENGER CARS EU</b>							
ES 250 2.5	[2VZ-FE]				12.89- 09.91	JS632	12 1.4
IS 2.2 Diesel	[2AD-FTV]	07.10-	CA2029IR	14 130	07.10-	JS1369	12 2.0
IS 200 2.0	[1G-FE]	04.99-	CA2022IR	14 100			
IS 220 2.2 Diesel	[2AD-FHV]	10.05-	CA2029IR	14 130	10.05-	JS1369	12 2.0
<b>PASSENGER CARS US</b>							
ES 250 2.5	[2VZ-FE]				01.90- 01.91	JS632	12 1.4
					01.90- 01.91	JS652	12 1.0
ES 300 3.0	[1MZ-FE]				01.94- 01.95	JS632	12 1.4
	[3UZ-FE]				01.92- 01.93	JS632	12 1.4
<b>Lincoln</b>							
<b>PASSENGER CARS US</b>							
Continental 5.0							
Continental 5.0 Town car							
Continental 5.8							
Continental 6.6							
Continental 7.5							
Mark 5.0							
Mark 5.8							
Mark 6.6							
Mark 7.5							
Town Car 5.0							
Versailles 5.0							
Versailles 5.8							
<b>Lombardini</b>							
<b>MOTORS</b>							
Various Models 0.5 Diesel	[LDW502]				06.89-	CS807	12 1.1
Various Models 0.6 Diesel	[LDW602]				06.89-	CS807	12 1.1
Various Models 0.7 Diesel	[8LD740.2]	05.83-	CA616IR	14 32	03.92-	CS515	12 1.7
Various Models 0.8 Diesel	[10LD400.2]	01.84-	CA616IR	14 32			
Various Models 0.9 Diesel	[12LD435.2]	06.87-	CA616IR	14 32			
	[LDW903]				06.89-	CS807	12 1.1
Various Models 1.1 Diesel	[9LD561.2]	01.84-	CA616IR	14 32	03.92-	CS515	12 1.7
Various Models 1.2 Diesel	[LDW1204]				06.89-	CS807	12 1.1
Various Models 1.3 Diesel	[5LD675.2]	01.69- 12.90	CA616IR	14 32			
	[9LD625.2]	06.87-	CA616IR	14 32	06.87-	CS515	12 1.7
Various Models 1.6 Diesel	[11LD535.3]	04.84-	CA616IR	14 32			
	[LDW1503]				06.89- 05.93	CS356	12 2.2
Various Models 1.7 Diesel	[5LD825.2]	11.86-	CA616IR	14 32			
Various Models 1.9 Diesel	[11LD625.3]	04.84-	CA616IR	14 32			
	[11LD626.3]	01.89-	CA616IR	14 32			
Various Models 2.0 Diesel	[5LD675.3]	01.69- 12.90	CA616IR	14 32			
Various Models 2.1 Diesel	[LDW2004]				01.90-	CS356	12 2.2
Various Models 2.5 Diesel	[5LD825.3]	11.86-	CA616IR	14 32			
Various Models 2.7 Diesel	[5LD825.3T]	01.87-	CA616IR	14 32			
Various Models 2.8 Diesel	[5LD930.3]	04.83-	CA616IR	14 32			
Various Models 3.0 Diesel	[5LD825.4]	11.86-	CA616IR	14 32			
Various Models 3.7 Diesel	[5LD930.4]	04.83-	CA616IR	14 32			
<b>Lotus</b>							
<b>PASSENGER CARS EU</b>							
Elise 1.8 16V	[18K4F]				08.95- 11.00	CS1270	12 1.4
<b>PASSENGER CARS US</b>							
Eclat 2.0	[907]	01.76- 01.79	CA17h	14 34			
Elan 1.6		01.69- 01.71	CA17h	14 34	01.69- 01.73	CS18	12 0.8
		01.72- 01.73	CA17v	14 34			
		01.66- 01.68	CG50	14 22			
Elan 1.6 2		01.68- 01.73	CG50	14 22	01.68- 01.73	CS18	12 0.8
Elan 1.6 2S		01.69- 01.70	CA17h	14 34	01.69- 01.70	CS18	12 0.8
Elan 1.6 2S 130		01.72- 01.73	CA17v	14 34	01.72- 01.73	CS18	12 0.8
Elan 1.6 S4		01.68- 01.71	CG50	14 22	01.68- 01.71	CS18	12 0.8
Elan 1.6 Sprint		01.71- 01.73	CA17h	14 34	01.71- 01.73	CS18	12 0.8
Elise 1.2		01.61- 01.65	CS18	12 0.8			
Elise 2.0	[907]	01.76- 01.79	CA17h	14 34			
Esprit 2.0	[907]	01.76- 01.79	CA17h	14 34			
Esprit 2.2		01.80- 01.84	CA17h	14 34			
Esprit 2.2 Turbo	[910]	01.83- 01.84	CA17h	14 34			
		01.81- 01.82	CA17h	14 34			
Europa 1.5		01.67- 01.70	CG50	14 22			
Europa 1.5 S1		01.68- 01.70	CG50	14 22			
Europa 1.6		01.69- 01.71	CA17h	14 34			
Europa 1.6 S2		01.69- 01.70	CA17h	14 34			
Super Seven 1.1					01.61- 01.61	CS18	12 0.8
Super Seven 1.3					01.62- 01.68	CS18	12 0.8
Super Seven 1.5					01.62- 01.68	CS18	12 0.8



MAN TRUCKS EU									
6.100 4.6	(G 90)[D0824GF]	09.87- 10.93	CA3271R	28 27	09.87- 10.93	CS269	24 4.0		
		09.87- 03.92	CA7101R	28 35	09.87- 10.93	CS595	24 4.0		
		04.92- 10.93	CA2221R	28 35					
	[D0824GF01]	09.87- 10.93	CA3271R	28 27	09.87- 10.93	CS595	24 4.0		
		09.87- 03.92	CA7101R	28 35	09.87- 10.93	CS269	24 4.0		
		04.92- 10.93	CA2221R	28 35					
	[D0824GF02]	09.87- 10.93	CA3271R	28 27	09.87- 10.93	CS269	24 4.0		
		09.87- 03.92	CA7101R	28 35	09.87- 10.93	CS595	24 4.0		
		04.92- 10.93	CA2221R	28 35					
	7.150 4.6	(TGL)[D0834LFL40]	04.05-	CA18701R	28 80				
			04.05-	CA18711R	28 110				
			04.05-	CA18701R	28 80				
[D0834LFL50]	04.05-	CA18711R	28 110						
	04.05-	CA18701R	28 80						
	04.05-	CA18711R	28 110						
7.180 4.6	(TGL)[D0834LFL41]	04.05-	CA18701R	28 80					
		04.05-	CA18711R	28 110					
		04.05-	CA18701R	28 80					
[D0834LFL51]	04.05-	CA18711R	28 110						
	04.05-	CA18701R	28 80						
	04.05-	CA18711R	28 110						
7.220 4.6	(TGL)[D0834LFL62]	04.05-	CA18701R	28 80					
		04.05-	CA18711R	28 110					
		04.05-	CA18701R	28 80					
[D0834LFL65]	04.05-	CA18711R	28 110						
	04.05-	CA18701R	28 80						
	04.05-	CA18711R	28 110						
8.100 4.6	(G 90)[D0824GF]	09.87- 10.93	CA3271R	28 27	09.87- 10.93	CS269	24 4.0		
		09.87- 03.92	CA7101R	28 35	09.87- 10.93	CS595	24 4.0		
		04.92- 10.93	CA2221R	28 35					
	[D0824GF01]	09.87- 10.93	CA3271R	28 27	09.87- 10.93	CS595	24 4.0		
		09.87- 03.92	CA7101R	28 35	09.87- 10.93	CS269	24 4.0		
		04.92- 10.93	CA2221R	28 35					
	[D0824GF02]	09.87- 10.93	CA3271R	28 27	09.87- 10.93	CS269	24 4.0		
		09.87- 03.92	CA7101R	28 35	09.87- 10.93	CS595	24 4.0		
		04.92- 10.93	CA2221R	28 35					
	8.103 4.6	(L 2000)[D0824FL01]	10.93- 06.96	CA10351R	28 80	10.93- 06.96	CS1267	24 4.0	
			10.93- 06.96	CA3331R	28 55	10.93- 06.96	CS1243	24 4.0	
			10.93- 06.96	CA7101R	28 35				
10.93- 06.96			CA8541R	28 35					
10.93- 06.96			CA8541R	28 35					
8.113 4.6	(L 2000)[D0824LFL04]	08.95- 03.97	CA10351R	28 80	08.95- 05.00	CS595	24 4.0		
		08.95- 03.97	CA3331R	28 55	05.00-	CS1267	24 4.0		
		08.95- 03.97	CA8541R	28 35	08.95- 05.00	CS269	24 4.0		
	[D0824LFL08]	03.97- 09.01	CA10351R	28 80	05.00-	CS1243	24 4.0		
		03.97- 09.01	CA3331R	28 55	03.97- 09.01	CS595	24 4.0		
		03.97- 09.01	CA8541R	28 35					
8.136 5.7	(G)[D0226MF]	10.79- 08.88	CA3271R	28 27	10.79- 08.88	CS595	24 4.0		
		10.79- 08.88	CA7101R	28 35	10.79- 08.88	CS269	24 4.0		
8.145 4.6	(L 2000)[D0834LFL02]	07.01- 08.02	CA16631R	28 90	07.01- 08.02	CS1243	24 4.0		
		07.01- 08.02	CA16951R	28 55	07.01- 08.02	CS1267	24 4.0		
8.150 4.6	(L 2000)[D0824LFO]	02.95- 07.98	CA10351R	28 80	05.00-	CS1243	24 4.0		
		02.95- 07.98	CA3331R	28 55	02.95- 07.98	CS595	24 4.0		
		02.95- 07.98	CA8541R	28 35	02.95- 07.98	CS269	24 4.0		
	[D0824LFO]	04.05-	CA18701R	28 80	05.00-	CS1267	24 4.0		
		04.05-	CA18711R	28 110					
		10.06-	CA18701R	28 80					
[D0834LFL50]	10.06-	CA18711R	28 110						
	10.06-	CA18711R	28 110						
8.150 5.7	(G 90)[D0226MF]	05.90- 10.93	CA3271R	28 27	05.90- 10.93	CS269	24 4.0		
		05.90- 03.92	CA7101R	28 35	05.90- 10.93	CS595	24 4.0		
		04.92- 10.93	CA2221R	28 35					
8.150 6.9	(G 90)[D0826GF]	09.87- 10.93	CA3271R	28 27	09.87- 05.95	CS1267	24 4.0		
		09.87- 03.92	CA7101R	28 35	09.87- 05.95	CS1243	24 4.0		
		04.92- 10.93	CA2221R	28 35	09.87- 05.95	CS595	24 4.0		
	[D0826GF01]	07.88- 10.93	CA3271R	28 27	09.87- 05.95	CS269	24 4.0		
		07.88- 03.92	CA7101R	28 35	07.88- 10.93	CS269	24 4.0		
		04.92- 10.93	CA2221R	28 35	07.88- 10.93	CS595	24 4.0		
	[D0826GF03]	09.87- 05.95	CA3271R	28 27	07.88- 10.93	CS1243	24 4.0		
		09.87- 05.95	CA7101R	28 35	09.87- 05.95	CS269	24 4.0		
		05.88- 05.95	CA3331R	28 55	09.87- 05.95	CS595	24 4.0		
	8.153 4.6	(L 2000)[D0824LFL01]	10.93- 06.96	CA10351R	28 80	10.93- 09.96	CS1267	24 4.0	
			10.93- 06.96	CA3331R	28 55	10.93- 09.96	CS1243	24 4.0	
			10.93- 07.94	CA7101R	28 35				
08.94- 06.96			CA8541R	28 35					
08.94- 06.96			CA8541R	28 35					
[D0824LFL05]		01.95- 07.97	CA10351R	28 80	01.95- 07.97	CS1267	24 4.0		
		01.95- 07.97	CA3331R	28 55	01.95- 07.97	CS1243	24 4.0		
		01.95- 07.97	CA8541R	28 35					
8.163 4.6		(L 2000)[D0824LFL02]	05.94- 09.01	CA10351R	28 80	05.94- 09.01	CS1243	24 4.0	
			05.94- 09.01	CA3331R	28 55	05.94- 09.01	CS269	24 4.0	
			05.94- 07.94	CA7101R	28 35	05.00- 09.01	CS1267	24 4.0	
			08.94- 09.01	CA8541R	28 35	05.94- 09.01	CS595	24 4.0	
	08.94- 09.01		CA8541R	28 35	05.94- 09.01	CS595	24 4.0		
	[D0824LFL06]	05.94- 03.97	CA10351R	28 80	08.95- 03.97	CS1267	24 4.0		
		05.94- 03.97	CA3331R	28 55	05.94- 03.97	CS269	24 4.0		
		05.94- 03.97	CA8541R	28 35	05.94- 03.97	CS595	24 4.0		
	[D0824LFL07]	08.95- 03.01	CA10351R	28 80	08.95- 03.97	CS1243	24 4.0		
		08.95- 03.01	CA3331R	28 55	08.95- 03.01	CS595	24 4.0		
		08.95- 03.01	CA8541R	28 35	08.95- 03.01	CS1267	24 4.0		
	[D0824LFL09]	03.97- 09.02	CA10351R	28 80	08.95- 03.01	CS269	24 4.0		
03.97- 09.02		CA3331R	28 55	03.97- 09.02	CS595	24 4.0			
03.97- 09.02		CA8541R	28 35	03.97- 09.02	CS1267	24 4.0			
03.97- 09.02		CA8541R	28 35	03.97- 09.02	CS269	24 4.0			
8.170 5.7	(G 90)[D0226MCF0/170]	02.89- 10.93	CA2401R	28 55	02.89- 10.93	CS595	24 4.0		
		02.89- 10.93	CA3271R	28 27	02.89- 10.93	CS269	24 4.0		
		02.89- 10.93	CA3331R	28 55					
		02.89- 03.92	CA7101R	28 35					
		04.92- 10.93	CA2221R	28 35					
		04.92- 10.93	CA2221R	28 35					
8.180 4.6	(TGL)[D0834LFL41]	04.05- 09.06	CA18701R	28 80					
		04.05- 09.06	CA18711R	28 110					
		04.05- 09.06	CA18701R	28 80					
[D0834LFL51]	04.05- 09.06	CA18711R	28 110						
	04.05- 09.06	CA18701R	28 80						
	04.05- 09.06	CA18711R	28 110						
8.185 4.6	(L 2000)[D0834LFL03]	09.00- 08.02	CA16631R	28 90	09.00- 08.02	CS1267	24 4.0		
		09.00- 08.02	CA16951R	28 55	09.00- 08.02	CS1243	24 4.0		
8.210 4.6	(TGL)[D0834LFL42]	04.05-	CA18701R	28 80					
8.220 4.6	(TGL)[D0834LFL65]	04.05-	CA18711R	28 110					
		04.05-	CA18701R	28 80					
		04.05-	CA18711R	28 110					



8.220 6.9	(L 2000)[D0826LFL03]	04.95- 09.01	CA1035IR	28 80	04.95- 09.01	CS269	24 4.0
		04.95- 09.01	CA333IR	28 55	04.95- 09.01	CS595	24 4.0
		04.95- 09.01	CA854IR	28 35			
8.223 6.9	(L 2000)[D0826LFL02]	10.93- 06.96	CA1035IR	28 80	10.93- 06.96	CS595	24 4.0
		10.93- 06.96	CA222IR	28 35	10.93- 06.96	CS269	24 4.0
		10.93- 06.96	CA333IR	28 55			
		10.93- 06.96	CA854IR	28 35			
		05.94- 07.94	CA710IR	28 35			
	[D0826LFL06]	10.93- 06.96	CA1035IR	28 80	05.94- 06.96	CS269	24 4.0
		10.93- 06.96	CA333IR	28 55	10.93- 06.96	CS191	24 5.4
		10.93- 06.96	CA710IR	28 35	10.93- 06.96	CS1243	24 4.0
		10.93- 06.96	CA854IR	28 35	10.93- 06.96	CS595	24 4.0
		10.93- 06.96	CA854IR	28 35	10.93- 06.96	CS1267	24 4.0
8.224 6.9	(L 2000)[D0826LFL03]	05.94- 09.01	CA1035IR	28 80	05.94- 09.01	CS1267	24 4.0
		05.94- 09.01	CA333IR	28 55	05.94- 01.00	CS595	24 4.0
		05.94- 03.01	CA710IR	28 35	05.94- 09.01	CS1243	24 4.0
		08.94- 09.01	CA854IR	28 35	05.94- 09.99	CS269	24 4.0
8.225 6.9	(L 2000)[D0826LFL10]	07.01- 08.02	CA1663IR	28 90	07.01- 08.02	CS1243	24 4.0
		07.01- 08.02	CA1695IR	28 55	07.01- 08.02	CS1267	24 4.0
	[D0836LFL02]	07.01- 08.02	CA1663IR	28 90	07.01- 08.02	CS1243	24 4.0
8.240 6.9	(TGL)[D0836LFL40]	04.05-	CA1870IR	28 80			
		04.05-	CA1871IR	28 110			
8.250 6.9	(TGL)[D0836LFL63]	04.05-	CA1870IR	28 80			
		04.05-	CA1871IR	28 110			
9.136 5.7	(G)[D0226MF]	10.79- 08.88	CA327IR	28 27	10.79- 08.88	CS269	24 4.0
		02.83- 08.88	CA710IR	28 35	10.79- 08.88	CS595	24 4.0
9.145 4.6	(L 2000)[D0834LFL02]	07.01-	CA1663IR	28 90	09.00-	CS1243	24 4.0
		07.01-	CA1695IR	28 55	09.00-	CS1267	24 4.0
9.150 5.7	(G 90)[D0226MF/Silent]	05.90- 10.93	CA327IR	28 27	05.90- 10.93	CS269	24 4.0
		05.90- 03.92	CA710IR	28 35	05.90- 10.93	CS595	24 4.0
		04.92- 10.93	CA222IR	28 35			
9.150 6.9	(G 90)[D0826GF]	09.87- 10.93	CA327IR	28 27	09.87- 10.93	CS1267	24 4.0
		09.87- 10.92	CA710IR	28 35	09.87- 10.93	CS1243	24 4.0
		04.92- 10.93	CA222IR	28 35	09.87- 10.93	CS595	24 4.0
	[D0826GF01]	07.88- 10.93	CA327IR	28 27	09.87- 10.93	CS269	24 4.0
		07.88- 03.92	CA710IR	28 35	07.88- 10.93	CS1243	24 4.0
		04.92- 10.93	CA222IR	28 35	07.88- 10.93	CS595	24 4.0
	[D0826GF03]	09.87- 05.95	CA327IR	28 27	07.88- 10.93	CS269	24 4.0
		09.87- 05.95	CA710IR	28 35	09.87- 05.95	CS1267	24 4.0
		10.92- 05.95	CA333IR	28 55	09.87- 05.95	CS269	24 4.0
	9.153 4.6	(L 2000)[D0824LFL01]	10.93- 12.95	CA1035IR	28 80	10.93- 12.95	CS595
10.93- 12.95			CA333IR	28 55	10.93- 12.95	CS269	24 4.0
10.93- 07.94			CA710IR	28 35	10.93- 01.95	CS1243	24 4.0
08.94- 12.95			CA854IR	28 35	10.93- 01.95	CS1267	24 4.0
08.95- 06.96			CA1035IR	28 80	08.95- 06.96	CS1267	24 4.0
[D0824LFL05]		08.95- 06.96	CA333IR	28 55	08.95- 06.96	CS1243	24 4.0
		08.95- 06.96	CA854IR	28 35	08.95- 06.96	CS595	24 4.0
					08.95- 06.96	CS269	24 4.0
					08.95- 06.96	CS269	24 4.0
					08.95- 06.96	CS269	24 4.0
9.163 4.6	(L 2000)[D0824LFL02]	05.94- 12.95	CA1035IR	28 80	05.94- 12.95	CS595	24 4.0
		05.94- 12.95	CA333IR	28 55	05.94- 12.95	CS269	24 4.0
		05.94- 07.94	CA710IR	28 35			
	[D0824LFL06]	08.94- 12.95	CA854IR	28 35			
		05.94- 03.97	CA1035IR	28 80	05.94- 03.97	CS595	24 4.0
		05.94- 03.97	CA333IR	28 55	05.94- 03.97	CS269	24 4.0
	[D0824LFL07]	05.94- 03.97	CA854IR	28 35			
		08.95- 03.97	CA1035IR	28 80	08.95- 03.97	CS1267	24 4.0
		08.95- 03.97	CA333IR	28 55	08.95- 03.97	CS1243	24 4.0
	[D0824LFL09]	08.95- 03.97	CA854IR	28 35			
03.97- 09.01		CA1035IR	28 80	03.97- 01.00	CS595	24 4.0	
03.97- 09.01		CA333IR	28 55	10.99- 09.01	CS1267	24 4.0	
9.170 5.7	(G 90)[D0226MCF0/170]	02.89- 10.93	CA240IR	28 55	02.89- 10.93	CS269	24 4.0
		02.89- 10.93	CA327IR	28 27	02.89- 10.93	CS595	24 4.0
		02.89- 10.93	CA333IR	28 55			
		02.89- 03.92	CA710IR	28 35			
	[D0824LFL03]	04.92- 10.93	CA222IR	28 35			
		09.00- 08.02	CA1663IR	28 90	09.00- 08.02	CS1267	24 4.0
		09.00- 08.02	CA1695IR	28 55	09.00- 08.02	CS1243	24 4.0
		05.84- 07.94	CA710IR	28 35	10.93- 06.96	CS269	24 4.0
		05.94- 06.96	CA1035IR	28 80	10.93- 06.96	CS1243	24 4.0
9.223 6.9	(L 2000)[D0826LFL02]	05.94- 06.96	CA333IR	28 55	10.93- 06.96	CS595	24 4.0
		05.94- 06.96	CA854IR	28 35			
		05.94- 06.96	CA1035IR	28 80	05.94- 06.96	CS269	24 4.0
		05.94- 06.96	CA333IR	28 55			
		05.94- 06.96	CA854IR	28 35			
9.224 6.9	(L 2000)[D0826LFL03]	05.94- 06.96	CA1035IR	28 80			
		05.94- 06.96	CA333IR	28 55	05.94- 06.96	CS269	24 4.0
		05.94- 07.94	CA710IR	28 35			
		08.94- 09.01	CA854IR	28 35			
		07.01- 06.05	CA1663IR	28 90	07.01- 06.05	CS1243	24 4.0
9.225 6.9	(L 2000)[D0836LFL02]	07.01- 06.05	CA1695IR	28 55	07.01- 06.05	CS1267	24 4.0
		07.01- 06.05	CA1695IR	28 55	07.01- 06.05	CS1267	24 4.0
10.136 5.7	(G)[D0226MF]	09.81- 09.87	CA327IR	28 27	09.81- 09.87	CS269	24 4.0
		02.83- 09.87	CA710IR	28 35	09.81- 09.87	CS595	24 4.0
10.145 4.6	(L 2000)[D0834LFL02]	09.00-	CA1663IR	28 90	09.00-	CS1267	24 4.0
		09.00-	CA1695IR	28 55	09.00-	CS1243	24 4.0
10.150 4.6	(L 2000)[D0824LFO]	02.95- 01.96	CA1035IR	28 80	02.95- 01.96	CS269	24 4.0
		02.95- 01.96	CA333IR	28 55	02.95- 01.96	CS1267	24 4.0
		02.95- 01.96	CA854IR	28 35	02.95- 01.96	CS1243	24 4.0
10.150 5.7	(G 90)[D0226MF/Silent]	05.90- 10.93	CA327IR	28 27	05.90- 10.93	CS595	24 4.0
		05.90- 03.92	CA710IR	28 35	05.90- 10.93	CS269	24 4.0
		04.92- 10.93	CA222IR	28 35			
10.150 6.9	(G 90)[D0826GF01]	09.87- 10.93	CA327IR	28 27	09.87- 10.93	CS1267	24 4.0
		09.87- 03.92	CA710IR	28 35	09.87- 10.93	CS595	24 4.0
		04.92- 10.93	CA222IR	28 35	09.87- 10.93	CS1243	24 4.0
	[D0826GF03]	09.87- 10.93	CA327IR	28 27	09.87- 10.93	CS269	24 4.0
		09.87- 10.93	CA710IR	28 35	09.87- 10.93	CS1243	24 4.0
		10.92- 10.93	CA333IR	28 55	09.87- 10.93	CS595	24 4.0
	[D0826OH02]	01.88- 05.92	CA1237IR	28 140	09.87- 10.93	CS269	24 4.0
					09.87- 10.93	CS1267	24 4.0



MAN Continued

10.153 4.6	(L 2000)[D0824LFL01]	10.93- 06.96 CA1035IR 28 80	10.93- 06.96 CS1267 24 4.0		
		10.93- 06.96 CA333IR 28 55	10.93- 06.96 CS1243 24 4.0		
		10.93- 07.94 CA710IR 28 35			
		08.94- 06.96 CA854IR 28 35			
[D0824LFL05]		10.93- 06.96 CA1035IR 28 80	10.93- 06.96 CS1267 24 4.0		
		10.93- 06.96 CA333IR 28 55	10.93- 06.96 CS1243 24 4.0		
		10.93- 06.96 CA710IR 28 35			
		08.94- 06.96 CA854IR 28 35			
10.163 4.6	(L 2000)[D0824LFL02]	05.94- 12.95 CA1035IR 28 80	05.94- 12.95 CS1243 24 4.0		
		05.94- 12.95 CA333IR 28 55	05.94- 12.95 CS269 24 4.0		
		05.94- 12.95 CA710IR 28 35	05.94- 12.95 CS595 24 4.0		
		05.94- 12.95 CA854IR 28 35	05.94- 12.95 CS1267 24 4.0		
		[D0824LFL06]		05.94- 03.97 CA1035IR 28 80	05.94- 03.97 CS1243 24 4.0
				05.94- 03.97 CA333IR 28 55	05.94- 03.97 CS269 24 4.0
				05.94- 03.97 CA710IR 28 35	05.94- 03.97 CS595 24 4.0
				05.94- 03.97 CA854IR 28 35	05.94- 03.97 CS1267 24 4.0
		[D0824LFL09]		03.00- 09.01 CA1035IR 28 80	01.00- 09.01 CS1243 24 4.0
				03.00- 09.01 CA333IR 28 55	03.00- 07.01 CS1267 24 4.0
				03.00- 09.01 CA854IR 28 35	03.00- CS269 24 4.0
					03.00- CS595 24 4.0
10.180 4.6	(TGL)[D0834LFL41]	04.05- CA1870IR 28 80			
		04.05- CA1871IR 28 110			
		[D0834LFL51]		04.05- CA1870IR 28 80	
				04.05- CA1871IR 28 110	
[D0826OH02]		01.88- 05.92 CA1237IR 28 140			
10.185 4.6	(L 2000)[D0834LFL03]	09.00- 08.02 CA1663IR 28 90	09.00- 08.02 CS1243 24 4.0		
		09.00- 08.02 CA1695IR 28 55	09.00- 08.02 CS1267 24 4.0		
10.210 4.6	(TGL)[D0834LFL42]	04.05- CA1870IR 28 80			
		04.05- CA1871IR 28 110			
10.220 4.6	(TGL)[D0834LFL65]	04.05- CA1870IR 28 80			
		04.05- CA1871IR 28 110			
10.220 6.9	(L 2000)[D0826LFL03]	02.95- 02.01 CA1035IR 28 80	02.95- 02.01 CS1243 24 4.0		
		02.95- 02.01 CA333IR 28 55	02.95- 02.01 CS1267 24 4.0		
		02.95- 02.01 CA854IR 28 35	02.95- 02.01 CS269 24 4.0		
			02.95- 02.01 CS595 24 4.0		
10.223 6.9	(L 2000)[D0826LFL02]	05.94- 06.96 CA1035IR 28 80	10.93- 06.96 CS269 24 4.0		
		05.94- 06.96 CA333IR 28 55	10.93- 06.96 CS191 24 5.4		
		05.94- 07.94 CA710IR 28 35			
		08.94- 06.96 CA854IR 28 35			
		[D0826LFL06]		05.94- 06.96 CA1035IR 28 80	05.94- 06.96 CS269 24 4.0
				05.94- 06.96 CA333IR 28 55	
				05.94- 07.94 CA710IR 28 35	
				08.94- 06.96 CA854IR 28 35	
10.224 6.9	(L 2000)[D0826LFL03]	05.94- 02.01 CA1035IR 28 80	10.99- 02.01 CS1267 24 4.0		
		05.94- 02.01 CA333IR 28 55	05.94- 02.01 CS269 24 4.0		
		05.94- 07.94 CA710IR 28 35	05.94- 05.00 CS595 24 4.0		
		08.94- 02.01 CA854IR 28 35	02.00- 02.01 CS1243 24 4.0		
10.225 6.9	(L 2000)[D0836LFL02]	09.00- 08.02 CA1663IR 28 90	07.01- 08.02 CS1243 24 4.0		
		09.00- 08.02 CA1695IR 28 55	07.01- 08.02 CS1267 24 4.0		
			09.00- CS595 24 4.0		
10.240 6.9	(TGL)[D0836LFL40]	04.05- CA1870IR 28 80			
		04.05- CA1871IR 28 110			
		[D0836LFL63]		04.05- CA1870IR 28 80	
				04.05- CA1871IR 28 110	
[D0826LOH06]		03.93- 09.96 CA1237IR 28 140			
[D0826LOH15]		11.95- 12.00 CA1237IR 28 140			
12.152 6.9	(M 90)[D0826F01]	12.88- 05.94 CA240IR 28 55	12.88- 05.94 CS269 24 4.0		
		12.88- 05.94 CA710IR 28 35	12.88- 05.94 CS595 24 4.0		
		10.92- 05.94 CA333IR 28 55			
		[D0826F02]		10.92- 05.94 CA186IR 14 55	12.88- 05.94 CS269 24 4.0
				10.92- 05.94 CA333IR 28 55	12.88- 05.94 CS595 24 4.0
				10.92- 05.94 CA710IR 28 35	
12.163 4.6	(M 2000 L)[D0824LFL06]	08.95- 08.01 CA1035IR 28 80	08.95- 07.01 CS1267 24 4.0		
		08.95- 08.01 CA333IR 28 55	08.95- 08.01 CS1243 24 4.0		
		08.95- 08.01 CA854IR 28 35			
		[D0824LFL09]		08.95- 08.01 CA1035IR 28 80	08.95- 07.01 CS1267 24 4.0
				08.95- 08.01 CA333IR 28 55	08.95- 08.01 CS1243 24 4.0
				08.95- 08.01 CA854IR 28 35	
		12.180 4.6	(TGL)[D0834LFL41]	04.05- CA1870IR 28 80	
				04.05- CA1871IR 28 110	
				[D0834LFL51]	
04.05- CA1871IR 28 110					
12.185 4.6	(L 2000)[D0834LFL03]	07.01- CA1663IR 28 90	07.01- CS1243 24 4.0		
		07.01- CA1695IR 28 55	07.01- CS1267 24 4.0		
12.185 9.7	(M 2000 L)[D0834LFL03]	05.01- CA1663IR 28 90	05.01- CS1243 24 4.0		
		05.01- CA1695IR 28 55	05.01- CS1267 24 4.0		
12.192 6.9	(M 90)[D0826LF01]	07.90- 06.96 CA1035IR 28 80	07.90- 06.96 CS595 24 4.0		
		07.90- 06.96 CA186IR 14 55	07.90- 06.96 CS269 24 4.0		
		07.90- 06.96 CA333IR 28 55	07.90- 06.96 CS1267 24 4.0		
		07.90- 04.94 CA710IR 28 35			
		05.94- 06.96 CA854IR 28 35			
		[D0826LF05]		07.90- 06.96 CA1035IR 28 80	07.90- 06.96 CS1267 24 4.0
				07.90- 06.96 CA186IR 14 55	07.90- 06.96 CS595 24 4.0
				07.90- 06.96 CA333IR 28 55	07.90- 06.96 CS269 24 4.0
				06.92- 04.94 CA710IR 28 35	
		[D0826LF07]		07.90- 06.96 CA1035IR 28 80	07.90- 06.96 CS595 24 4.0
				07.90- 06.96 CA186IR 14 55	07.90- 06.96 CS269 24 4.0
				07.90- 06.96 CA333IR 28 55	07.90- 06.96 CS1267 24 4.0
05.94- 06.96 CA710IR 28 35					
05.94- 06.96 CA854IR 28 35					
12.210 4.6	(TGL)[D0834LFL42]	04.05- CA1870IR 28 80			
		04.05- CA1871IR 28 110			
12.220 4.6	(TGL)[D0834LFL65]	04.05- CA1871IR 28 110			
12.222 6.9	(M 90)[D0826LF11]	05.94- 06.96 CA1035IR 28 80	05.94- 06.96 CS1267 24 4.0		
		05.94- 06.96 CA186IR 14 55	05.94- 06.96 CS595 24 4.0		
		05.94- 06.96 CA333IR 28 55	05.94- 06.96 CS269 24 4.0		
		05.94- 06.96 CA854IR 28 35			
12.224 6.9	(M 2000 L)[D0826LFL03]	08.95- 09.01 CA1035IR 28 80	08.95- 09.01 CS269 24 4.0		
		08.95- 09.01 CA333IR 28 55			
		08.95- 09.01 CA854IR 28 35			
		[D0826LFL10]		08.95- 09.01 CA1035IR 28 80	10.99- 09.01 CS1267 24 4.0
				08.95- 09.01 CA333IR 28 55	08.95- 09.01 CS269 24 4.0
		08.95- 09.01 CA854IR 28 35	02.00- 09.01 CS1243 24 4.0		
12.225 6.9	(L 2000)[D0836LFL02]	07.01- CA1663IR 28 90	07.01- CS1243 24 4.0		
		07.01- CA1695IR 28 55	07.01- CS1267 24 4.0		



12.232 6.9	(M 90)[D0826LF02]	08.88- 06.96	CA1035IR	28 80	08.88- 06.96	CS269	24 4.0
		08.88- 06.96	CA240IR	28 55	05.90- 06.96	CS1267	24 4.0
		08.88- 06.96	CA333IR	28 55	08.88- 06.96	CS595	24 4.0
		08.88- 04.94	CA710IR	28 35			
		05.90- 06.96	CA186IR	14 55			
	[D0826LF06]	08.88- 06.96	CA1035IR	28 80	05.90- 06.96	CS1267	24 4.0
		08.88- 06.96	CA240IR	28 55	08.88- 06.96	CS595	24 4.0
		08.88- 06.96	CA333IR	28 55	08.88- 06.96	CS269	24 4.0
		08.88- 05.94	CA710IR	28 35			
		05.90- 06.96	CA186IR	14 55			
	[D0826LF08]	08.88- 06.96	CA1035IR	28 80	08.88- 06.96	CS595	24 4.0
08.88- 06.96		CA240IR	28 55	08.88- 06.96	CS269	24 4.0	
08.88- 06.96		CA333IR	28 55	05.90- 06.96	CS1267	24 4.0	
08.88- 07.94		CA710IR	28 35				
05.90- 06.96		CA186IR	14 55				
05.94- 06.96		CA854IR	28 35				
12.240 6.9	(TGL)[D0836LFL40]	04.05- 04.05	CA1870IR	28 80			
	(TGM)[D0836LFL50]	12.05- 12.05	CA1870IR	28 80			
		12.05- 12.05	CA1871IR	28 110			
12.250 6.9	(TGL)[D0836LFL63]	04.05- 10.05	CA1871IR	28 110			
	(TGM)[D0836LFL63]	10.05- 10.05	CA1870IR	28 80			
12.262 6.9	(M 90)[D0826LF13]	08.95- 06.96	CA1035IR	28 80	08.95- 06.96	CS1267	24 4.0
		08.95- 06.96	CA186IR	14 55	08.95- 06.96	CS595	24 4.0
		08.95- 06.96	CA333IR	28 55	08.95- 06.96	CS269	24 4.0
		08.95- 06.96	CA854IR	28 35			
12.272 10.0	(M 90)[D2865LF02]	09.91- 10.92	CA1035IR	28 80	09.91- 10.92	CS191	24 5.4
		09.91- 10.92	CA222IR	28 35	09.91- 10.92	CS198	24 6.0
		09.91- 10.92	CA333IR	28 55			
12.272 6.9	(M 90)[D0826LF04]	10.92- 06.96	CA1035IR	28 80	10.92- 06.96	CS595	24 4.0
		10.92- 06.96	CA186IR	14 55	10.92- 06.96	CS1267	24 4.0
		10.92- 06.96	CA333IR	28 55	10.92- 06.96	CS269	24 4.0
		10.92- 04.94	CA710IR	28 35			
		10.93- 06.96	CA854IR	28 35			
12.280 6.9	(TGM)[D0836LFL51]	12.05- 12.05	CA1870IR	28 80			
		12.05- 12.05	CA1871IR	28 110			
12.290 6.9	(TGM)[D0836LFL64]	10.05- 10.05	CA1870IR	28 80			
13.220 6.9	[D0826LUH12]	07.98- 09.01	CA1237IR	28 140			
13.240 6.9	(TGM)[D0836LFL40]	05.06- 05.06	CA1870IR	28 80			
		05.06- 05.06	CA1871IR	28 110			
[D0836LFL50]	05.06- 05.06	CA1870IR	28 80				
	05.06- 05.06	CA1871IR	28 110				
13.250 6.9	(TGM)[D0836LFL63]	10.05- 10.05	CA1870IR	28 80			
13.280 6.9	(TGM)[D0836LFL41]	05.06- 05.06	CA1870IR	28 80			
		05.06- 05.06	CA1871IR	28 110			
[D0836LFL51]	05.06- 05.06	CA1870IR	28 80				
	05.06- 05.06	CA1871IR	28 110				
13.290 6.9	(TGM)[D0836LFL64]	10.05- 10.05	CA1871IR	28 110			
14.152 4.6	(M 90)[D0824LF01]	05.94- 06.96	CA1035IR	28 80	05.94- 06.97	CS1243	24 4.0
		05.94- 06.96	CA186IR	14 55	05.94- 06.96	CS595	24 4.0
		05.94- 06.96	CA333IR	28 55	05.94- 06.96	CS1267	24 4.0
		05.94- 06.96	CA710IR	28 35			
		05.94- 06.96	CA854IR	28 35			
		06.94- 06.96	CA854IR	28 35			
14.152 6.9	(M 90)[D0826F01]	12.88- 04.94	CA240IR	28 55	12.88- 05.94	CS269	24 4.0
		12.88- 03.92	CA710IR	28 35	12.88- 05.94	CS595	24 4.0
		12.88- 05.94	CA333IR	28 55	12.88- 05.94	CS269	24 4.0
		12.88- 05.94	CA710IR	28 35	12.88- 05.94	CS595	24 4.0
		12.91- 04.94	CA186IR	14 55			
14.162 4.6	(M 90)[D0824LF02]	08.95- 06.96	CA1035IR	28 80	08.95- 06.96	CS1267	24 4.0
		08.95- 06.96	CA186IR	14 55	08.95- 06.96	CS595	24 4.0
		08.95- 06.96	CA333IR	28 55			
		08.95- 06.96	CA854IR	28 35			
14.163 4.6	(M 2000 L)[D0824LFL06]	08.95- 08.01	CA1035IR	28 80	08.95- 07.01	CS1267	24 4.0
		08.95- 08.01	CA333IR	28 55	08.95- 08.01	CS1243	24 4.0
		08.95- 08.01	CA854IR	28 35			
		08.95- 08.01	CA1035IR	28 80	08.95- 07.01	CS1267	24 4.0
		08.95- 08.01	CA333IR	28 55	08.95- 08.01	CS1243	24 4.0
14.192 6.6	(M 90)[D0826TF]	08.88- 06.90	CA240IR	28 55	08.88- 06.90	CS595	24 4.0
		08.88- 06.90	CA710IR	28 35	08.88- 06.90	CS269	24 4.0
14.192 6.9	(M 90)[D0826LF01]	07.90- 06.96	CA1035IR	28 80	07.90- 06.96	CS1267	24 4.0
		07.90- 06.96	CA186IR	14 55	07.90- 06.96	CS595	24 4.0
		07.90- 06.96	CA333IR	28 55			
		07.90- 04.94	CA710IR	28 35			
	[D0826LF05]	07.90- 06.96	CA1035IR	28 80	07.90- 06.96	CS1267	24 4.0
		07.90- 06.96	CA186IR	14 55	07.90- 06.96	CS595	24 4.0
		07.90- 06.96	CA333IR	28 55			
		07.90- 06.96	CA333IR	28 55			
		06.92- 04.94	CA710IR	28 35			
	[D0826LF07]	07.90- 06.96	CA1035IR	28 80	07.90- 06.96	CS595	24 4.0
07.90- 06.96		CA186IR	14 55	07.90- 06.96	CS1267	24 4.0	
07.90- 06.96		CA333IR	28 55				
07.90- 06.96		CA333IR	28 55				
05.94- 06.96		CA854IR	28 35				
14.222 6.9	(M 90)[D0826LF11]	05.94- 06.96	CA1035IR	28 80	05.94- 06.96	CS1267	24 4.0
		05.94- 06.96	CA186IR	14 55	05.94- 06.96	CS595	24 4.0
		05.94- 06.96	CA333IR	28 55			
		05.94- 06.96	CA854IR	28 35			
14.224 6.9	(M 2000 L)[D0826LFL03]	08.95- 09.01	CA1035IR	28 80	08.95- 09.01	CS269	24 4.0
		08.95- 09.01	CA333IR	28 55			
		08.95- 09.01	CA854IR	28 35			
	[D0826LFL10]	08.95- 09.01	CA1035IR	28 80	10.99- 09.01	CS1267	24 4.0
		08.95- 09.01	CA333IR	28 55	08.95- 09.01	CS269	24 4.0
		08.95- 09.01	CA854IR	28 35	02.00- 09.01	CS1243	24 4.0
	(M 2000 M)[D0826LF15]	08.95- 03.97	CA1035IR	28 80	08.95- 03.97	CS595	24 4.0
08.95- 03.97		CA333IR	28 55	08.95- 03.97	CS269	24 4.0	
08.95- 03.97		CA854IR	28 35				
[D0826LF18]	08.95- 09.01	CA1035IR	28 80	08.95- 09.01	CS269	24 4.0	
	08.95- 09.01	CA333IR	28 55	08.95- 09.01	CS595	24 4.0	
	08.95- 09.01	CA333IR	28 55	10.99- 09.01	CS1267	24 4.0	
	08.95- 09.01	CA854IR	28 35	02.00- 09.01	CS1243	24 4.0	
14.225 6.9	(M 2000 L)[D0836LFL02]	07.01- 07.01	CA1663IR	28 90	07.01- 08.02	CS1267	24 4.0
	(M 2000 M)[D0836LF04]	07.01- 02.03	CA1695IR	28 55	09.00- 09.01	CS269	24 4.0
		02.03- 02.03	CA1663IR	28 90	09.00- 08.02	CS1243	24 4.0
		02.03- 02.03	CA1695IR	28 55	02.03- 02.03	CS1267	24 4.0



MAN Continued

14.232 6.9	(M 90)[D0826LF/217/Silent]	05.90- 04.95	CA1035IR	28 80	05.90- 04.95	CS269	24 4.0
		05.90- 04.95	CA333IR	28 55	05.90- 04.95	CS595	24 4.0
		05.90- 03.92	CA710IR	28 35			
		04.92- 04.95	CA854IR	28 35			
	[D0826LF02]	08.88- 06.96	CA1035IR	28 80	08.88- 06.96	CS269	24 4.0
		08.88- 06.96	CA240IR	28 55	08.88- 06.96	CS595	24 4.0
		08.88- 06.96	CA333IR	28 55			
		08.88- 10.92	CA710IR	28 35			
	[D0826LF06]	08.88- 06.96	CA1035IR	28 80	08.88- 06.96	CS269	24 4.0
		08.88- 06.96	CA240IR	28 55	08.88- 06.96	CS595	24 4.0
		08.88- 06.96	CA333IR	28 55			
		08.88- 05.94	CA710IR	28 35			
	[D0826LF08]	08.88- 06.96	CA1035IR	28 80	08.88- 06.96	CS269	24 4.0
		08.88- 06.96	CA240IR	28 55	08.88- 06.96	CS595	24 4.0
		08.88- 06.96	CA333IR	28 55			
		08.88- 07.94	CA710IR	28 35			
		08.94- 06.96	CA854IR	28 35			
14.255 6.9	(M 2000 L)[D0836LFL05]	07.01-	CA1663IR	28 90	07.01-	CS1267	24 4.0
		07.01-	CA1695IR	28 55	07.01-	CS1243	24 4.0
					11.02-	CS595	24 4.0
	(M 2000 M)[D0836LFL05]	10.00-	CA1237IR	28 140	10.00-	CS595	24 4.0
		10.00-	CA1663IR	28 90	10.00-	CS1243	24 4.0
		10.00-	CA1695IR	28 55			
14.262 6.9	(M 90)[D0826LF13]	08.95- 06.96	CA1035IR	28 80	08.95- 06.96	CS1267	24 4.0
		08.95- 06.96	CA186IR	14 55	08.95- 06.96	CS595	24 4.0
		08.95- 06.96	CA333IR	28 55			
		08.95- 06.96	CA854IR	28 35			
14.264 6.9	(M 2000 L)[D0826LFL09]	08.95- 09.01	CA1035IR	28 80	10.99- 09.01	CS1267	24 4.0
		08.95- 09.01	CA333IR	28 55	08.95- 09.01	CS269	24 4.0
		08.95- 09.01	CA854IR	28 35	02.00- 09.01	CS1243	24 4.0
	(M 2000 M)[D0826LF17]	08.95- 09.01	CA1035IR	28 80	08.95- 09.01	CS1267	24 4.0
		08.95- 09.01	CA333IR	28 55	08.95- 09.01	CS595	24 4.0
		08.95- 09.01	CA854IR	28 35	08.95- 09.01	CS269	24 4.0
					02.00- 09.01	CS1243	24 4.0
14.272 10.0	(M 90)[D2865LF02]	09.91- 10.92	CA1035IR	28 80	09.91- 10.92	CS191	24 5.4
		09.91- 10.92	CA222IR	28 35	09.91- 10.92	CS198	24 6.0
		09.91- 10.92	CA333IR	28 55			
14.272 6.9	(M 90)[D0826LF04]	10.92- 06.96	CA1035IR	28 80	10.92- 06.96	CS1267	24 4.0
		10.92- 06.96	CA186IR	14 55	10.92- 06.96	CS595	24 4.0
		10.92- 06.96	CA333IR	28 55			
		10.92- 04.94	CA710IR	28 35			
		05.94- 06.96	CA854IR	28 35			
14.284 6.9	(M 2000 L)[D0836LFL01]	06.98- 09.01	CA1663IR	28 90	02.00- 09.01	CS1243	24 4.0
		06.98- 09.01	CA1695IR	28 55	06.98- 09.01	CS1267	24 4.0
					06.98- 01.00	CS595	24 4.0
	(M 2000 M)[D0836LFL01]	06.98- 09.01	CA1663IR	28 90	06.98- 09.01	CS1267	24 4.0
		06.98- 09.01	CA1695IR	28 55	02.00- 09.01	CS1243	24 4.0
					06.98- 01.00	CS595	24 4.0
14.285 6.9	(M 2000 L)[D0836LFL03]	09.00-	CA1663IR	28 90	09.00-	CS1267	24 4.0
		09.00-	CA1695IR	28 55	09.00-	CS1243	24 4.0
	(M 2000 M)[D0836LFL03]	07.01- 08.02	CA1663IR	28 90	07.01- 08.02	CS1243	24 4.0
		07.01- 08.02	CA1695IR	28 55	07.01- 08.02	CS1267	24 4.0
15.163 4.6	(M 2000 L)[D0824LFL06]	08.95- 09.01	CA1035IR	28 80	08.95- 07.01	CS1267	24 4.0
		08.95- 09.01	CA333IR	28 55	08.95- 09.01	CS1243	24 4.0
		08.95- 09.01	CA854IR	28 35			
	[D0824LFL09]	08.95- 09.01	CA1035IR	28 80	08.95- 07.01	CS1267	24 4.0
		08.95- 09.01	CA333IR	28 55	08.95- 09.01	CS1243	24 4.0
		08.95- 09.01	CA854IR	28 35			
15.192 9.5	(F 9)[D2565MF]	01.83- 12.86	CA222IR	28 35	01.83- 12.86	CS191	24 5.4
15.224 6.9	(M 2000 L)[D0826LFL03]	08.95- 09.01	CA1035IR	28 80	08.95- 09.01	CS269	24 4.0
		08.95- 09.01	CA333IR	28 55			
		08.95- 09.01	CA854IR	28 35			
	[D0826LFL10]	08.95- 09.01	CA1035IR	28 80	08.95- 09.01	CS269	24 4.0
		08.95- 09.01	CA333IR	28 55	02.00- 09.01	CS1243	24 4.0
		08.95- 09.01	CA854IR	28 35	10.99- 09.01	CS1267	24 4.0
15.225 6.9	(M 2000 L)[D0836LFL02]	09.00- 09.01	CA1035IR	28 80	09.00- 09.01	CS269	24 4.0
		09.00- 09.01	CA333IR	28 55	09.02-	CS1267	24 4.0
		09.00- 09.01	CA854IR	28 35	09.00- 09.01	CS1243	24 4.0
		09.02-	CA1663IR	28 90			
		09.02-	CA1695IR	28 55			
15.240 6.9	(TGM)[D0836LFL40]	10.05-	CA1871IR	28 110			
	[D0836LFL50]	10.05-	CA1870IR	28 80			
		10.05-	CA1871IR	28 110			
	[D0836LFL53]	10.05-	CA1871IR	28 110			
15.250 6.9	(TGM)[D0836LFL63]	10.05-	CA1871IR	28 110			
15.255 6.9	(M 2000 L)[D0836LFL05]	07.01- 08.02	CA1663IR	28 90	07.01- 08.02	CS1267	24 4.0
		07.01- 08.02	CA1695IR	28 55	07.01- 08.02	CS1243	24 4.0
15.264 6.9	(M 2000 L)[D0826LFL09]	08.95- 09.01	CA1035IR	28 80	10.99- 09.01	CS1267	24 4.0
		08.95- 09.01	CA333IR	28 55	08.95- 09.01	CS269	24 4.0
		08.95- 09.01	CA854IR	28 35	02.00- 09.01	CS1243	24 4.0
15.280 6.9	(TGM)[D0836LFL41]	10.05-	CA1871IR	28 110			
	[D0836LFL51]	10.05-	CA1870IR	28 80			
		10.05-	CA1871IR	28 110			
	[D0836LFL54]	10.05-	CA1871IR	28 110			
15.284 6.9	(M 2000 L)[D0836LFL01]	06.98- 09.01	CA1663IR	28 90	02.00- 09.01	CS1243	24 4.0
		06.98- 09.01	CA1695IR	28 55	06.98- 09.01	CS1267	24 4.0
					06.98- 01.00	CS595	24 4.0
15.285 6.9	(M 2000 L)[D0836LFL03]	09.00- 09.02	CA1663IR	28 90	09.00- 09.02	CS1243	24 4.0
		09.00- 09.02	CA1695IR	28 55	09.00- 09.02	CS1267	24 4.0
15.290 6.9	(TGM)[D0836LFL64]	10.05-	CA1870IR	28 80			
		10.05-	CA1871IR	28 110			
15.330 6.9	(TGM)[D0836LFL44]	10.05-	CA1870IR	28 80			
	[D0836LFL55]	10.05-	CA1870IR	28 80			



15.340 6.9	(TGM)[D0836LFL65]	10.05-10.05-	CA1870IR 28 80 CA1871IR 28 110				
17.192 6.6	(M 90)[D0826TF]	08.88- 06.90 08.88- 06.90	CA240IR 28 55 CA710IR 28 35	08.88- 06.90 08.88- 06.90	CS595 24 4.0 CS269 24 4.0		
17.192 6.9	(M 90)[D0826LF01]	07.90- 06.96	CA1035IR 28 80	07.90- 06.96	CS1267 24 4.0		
		07.90- 06.96	CA186IR 14 55	07.90- 04.95	CS269 24 4.0		
		07.90- 06.96	CA333IR 28 55	07.90- 06.96	CS595 24 4.0		
	[D0826LF05]	07.90- 04.94	CA710IR 28 35				
		04.92- 04.95	CA854IR 28 35				
		07.90- 06.96	CA1035IR 28 80	07.90- 04.95	CS269 24 4.0		
		07.90- 06.96	CA186IR 14 55	10.92- 04.95	CS1243 24 4.0		
		07.90- 06.96	CA333IR 28 55	07.90- 06.96	CS595 24 4.0		
	[D0826LF07]	07.90- 04.94	CA710IR 28 35				
		04.92- 04.95	CA854IR 28 35				
		07.90- 06.96	CA1035IR 28 80	07.90- 06.96	CS1267 24 4.0		
		07.90- 06.96	CA186IR 14 55	07.90- 06.96	CS595 24 4.0		
		07.90- 06.96	CA333IR 28 55				
17.222 6.9	(M 90)[D0826LF11]	05.94- 06.96	CA1035IR 28 80	05.94- 06.96	CS1243 24 4.0		
		05.94- 06.96	CA186IR 14 55	05.94- 06.96	CS595 24 4.0		
		05.94- 06.96	CA333IR 28 55	05.94- 06.96	CS1267 24 4.0		
		05.94- 06.96	CA854IR 28 35				
17.232 6.9	(M 90)[D0826LF/217/Silent]	05.90- 04.95	CA1035IR 28 80	05.90- 04.95	CS269 24 4.0		
		05.90- 03.92	CA222IR 28 35	05.90- 04.95	CS595 24 4.0		
		05.90- 01.91	CA240IR 28 55				
		05.90- 04.95	CA333IR 28 55				
		05.90- 01.91	CA710IR 28 35				
		04.92- 04.95	CA854IR 28 35				
		[D0826LF02]	08.88- 06.96	CA1035IR 28 80	08.88- 06.96	CS269 24 4.0	
			08.88- 06.96	CA333IR 28 55	08.88- 06.96	CS595 24 4.0	
			08.88- 07.94	CA710IR 28 35			
			08.88- 06.96	CA854IR 28 35			
	[D0826LF06]	02.89- 04.95	CA240IR 28 55				
		08.88- 06.96	CA1035IR 28 80	08.88- 06.96	CS269 24 4.0		
		08.88- 06.96	CA333IR 28 55	08.88- 06.96	CS595 24 4.0		
		02.89- 05.95	CA240IR 28 55				
	[D0826LF08]	02.89- 07.94	CA710IR 28 35				
		10.92- 06.96	CA854IR 28 35				
		02.89- 06.96	CA1035IR 28 80	02.89- 06.96	CS595 24 4.0		
		02.89- 05.95	CA240IR 28 55	02.89- 06.96	CS269 24 4.0		
		02.89- 06.96	CA333IR 28 55				
		02.89- 07.94	CA710IR 28 35				
		02.89- 06.96	CA854IR 28 35				
		09.91- 05.95	CA1035IR 28 80	09.91- 11.91	CS191 24 5.4		
		09.91- 10.93	CA222IR 28 35	09.91- 05.95	CS198 24 6.0		
17.272 6.9	(M 90)[D0826LF04]	09.91- 05.95	CA333IR 28 55				
		11.93- 05.95	CA854IR 28 35				
		10.92- 05.95	CA1035IR 28 80	10.92- 05.95	CS595 24 4.0		
		10.92- 05.95	CA333IR 28 55	10.92- 05.95	CS269 24 4.0		
		10.92- 07.94	CA710IR 28 35				
18.192 6.9	(M 90)[D0826LF01]	08.94- 05.95	CA854IR 28 35				
		09.90- 06.96	CA1035IR 28 80	09.90- 06.96	CS1267 24 4.0		
		09.90- 06.96	CA186IR 14 55	09.90- 06.96	CS595 24 4.0		
	[D0826LF05]	09.90- 06.96	CA333IR 28 55				
		09.90- 04.94	CA710IR 28 35				
		09.90- 06.96	CA1035IR 28 80	09.90- 06.96	CS1267 24 4.0		
		09.90- 06.96	CA186IR 14 55	09.90- 06.96	CS595 24 4.0		
		09.90- 06.96	CA333IR 28 55				
	[D0826LF07]	06.92- 04.94	CA710IR 28 35				
		09.90- 06.96	CA1035IR 28 80	09.90- 06.96	CS1267 24 4.0		
		09.90- 06.96	CA186IR 14 55	09.90- 06.96	CS595 24 4.0		
		09.90- 06.96	CA333IR 28 55				
		05.94- 06.96	CA854IR 28 35				
18.222 6.9	(M 90)[D0826LF11]	05.94- 06.96	CA1035IR 28 80	05.94- 06.96	CS595 24 4.0		
		05.94- 06.96	CA186IR 14 55	05.94- 06.96	CS1267 24 4.0		
		05.94- 06.96	CA333IR 28 55				
		05.94- 06.96	CA854IR 28 35				
18.224 6.9	(M 2000 L)[D0826LFL03]	08.95- 09.01	CA1035IR 28 80	08.95- 09.01	CS269 24 4.0		
		08.95- 09.01	CA333IR 28 55				
		08.95- 09.01	CA854IR 28 35				
	[D0826LFL10]	08.95- 09.01	CA1035IR 28 80	02.00- 09.01	CS1243 24 4.0		
		08.95- 09.01	CA333IR 28 55	10.99- 09.01	CS1267 24 4.0		
		08.95- 09.01	CA854IR 28 35	08.95- 09.01	CS269 24 4.0		
		05.01-	CA333IR 28 55				
	(M 2000 M)[D0826LF15]	08.95- 03.97	CA1035IR 28 80	08.95- 03.97	CS269 24 4.0		
		08.95- 03.97	CA333IR 28 55	08.95- 03.97	CS595 24 4.0		
		08.95- 03.97	CA854IR 28 35				
		[D0826LF17]	08.95- 09.01	CA1035IR 28 80	08.95- 09.01	CS269 24 4.0	
			08.95- 09.01	CA333IR 28 55	08.95- 09.01	CS595 24 4.0	
			08.95- 09.01	CA854IR 28 35			
		[D0826LF18]	08.95- 09.01	CA1035IR 28 80	10.99- 09.01	CS1267 24 4.0	
	08.95- 09.01		CA333IR 28 55	08.95- 09.01	CS269 24 4.0		
08.95- 09.01	CA854IR 28 35		02.00- 09.01	CS1243 24 4.0			
18.225 6.9	(M 2000 L)	05.01-	CA333IR 28 55				
	(M 2000 M)[D0836LF04]	02.03-	CA1663IR 28 90	02.03-	CS1243 24 4.0		
18.232 6.9	(M 90)[D0826LF02]	02.03-	CA1695IR 28 55	02.03-	CS1267 24 4.0		
		09.90- 06.96	CA1035IR 28 80	09.90- 06.96	CS1267 24 4.0		
		09.90- 06.96	CA186IR 14 55	09.90- 06.96	CS595 24 4.0		
	[D0826LF06]	09.90- 06.96	CA333IR 28 55				
		09.90- 04.94	CA710IR 28 35				
		09.90- 06.96	CA1035IR 28 80	09.90- 06.96	CS1267 24 4.0		
		09.90- 06.96	CA186IR 14 55	09.90- 06.96	CS595 24 4.0		
		09.90- 06.96	CA333IR 28 55				
	[D0826LF08]	06.92- 04.94	CA710IR 28 35				
		09.90- 06.96	CA1035IR 28 80	09.90- 06.96	CS1267 24 4.0		
		09.90- 06.96	CA186IR 14 55	09.90- 06.96	CS595 24 4.0		
		09.90- 06.96	CA333IR 28 55				
		05.94- 06.96	CA854IR 28 35				
18.240 6.9	(TGM)[D0836LFL40]	10.05-	CA1870IR 28 80				
		10.05-	CA1871IR 28 110				
		05.06-	CA1871IR 28 110				
18.250 6.9	(TGM)[D0836LFL63]	10.05-	CA1871IR 28 110				
18.255 6.9	(M 2000 L)[D0836LFL05]	09.02-	CA1663IR 28 90	09.02-	CS1243 24 4.0		
		09.02-	CA1695IR 28 55	09.02-	CS1267 24 4.0		



MAN Continued

	(M 2000 M)[D0836LF05]	10.00-	CA1237IR	28 140	10.00-	CS595	24 4.0
		10.00-	CA1663IR	28 90	10.00-	CS1243	24 4.0
		10.00-	CA1695IR	28 55			
18.262 6.9	(M 90)[D0826LF13]	08.95- 06.96	CA1035IR	28 80	08.95- 06.96	CS1267	24 4.0
		08.95- 06.96	CA186IR	14 55	08.95- 06.96	CS595	24 4.0
		08.95- 06.96	CA333IR	28 55			
		08.95- 06.96	CA854IR	28 35			
18.264 6.9	(M 2000 L)[D0826LFL09]	08.95- 09.01	CA1035IR	28 80	10.99- 09.01	CS1267	24 4.0
		08.95- 09.01	CA333IR	28 55	08.95- 09.01	CS269	24 4.0
		08.95- 09.01	CA854IR	28 35	02.00- 09.01	CS1243	24 4.0
	(M 2000 M)[D0826LF17]	08.95- 09.01	CA1035IR	28 80	08.95- 09.01	CS595	24 4.0
		08.95- 09.01	CA333IR	28 55	08.95- 09.01	CS269	24 4.0
		08.95- 09.01	CA854IR	28 35			
18.272 10.0	(M 90)[D2865LF02]	09.91- 05.94	CA1035IR	28 80	09.91- 05.94	CS191	24 5.4
		09.91- 10.93	CA222IR	28 35	09.91- 05.94	CS198	24 6.0
		09.91- 05.94	CA333IR	28 55			
		11.93- 05.94	CA854IR	28 35			
18.272 6.9	(M 90)[D0826LF04]	10.92- 06.96	CA1035IR	28 80	10.92- 06.96	CS1267	24 4.0
		10.92- 06.96	CA186IR	14 55	10.92- 06.96	CS595	24 4.0
		10.92- 06.96	CA333IR	28 55			
		10.92- 04.94	CA710IR	28 35			
		05.94- 06.96	CA854IR	28 35			
18.280 6.9	(TGM)[D0836LFL41]	10.05-	CA1870IR	28 80			
		10.05-	CA1871IR	28 110			
	[D0836LFL51]	10.05-	CA1870IR	28 80			
		10.05-	CA1871IR	28 110			
	[D0836LFL54]	10.05-	CA1870IR	28 80			
18.284 6.9	(M 2000 L)[D0836LF01]	06.98- 09.01	CA1663IR	28 90	06.98- 09.01	CS1267	24 4.0
		06.98- 09.01	CA1695IR	28 55	02.00- 09.01	CS1243	24 4.0
					06.98- 01.00	CS595	24 4.0
	(M 2000 M)[D0836LF01]	06.98- 09.01	CA1663IR	28 90	02.00- 09.01	CS1243	24 4.0
		06.98- 09.01	CA1695IR	28 55	06.98- 09.01	CS1267	24 4.0
					06.98- 01.00	CS595	24 4.0
18.285 6.9	(M 2000 L)[D0836LFL03]	07.01-	CA1663IR	28 90	09.02-	CS1243	24 4.0
		07.01-	CA1695IR	28 55			
18.290 6.9	(TGM)[D0836LFL64]	10.05-	CA1870IR	28 80			
		10.05-	CA1871IR	28 110			
18.310 10.5	(TGA)[D2066LF04]	05.04- 09.06	CA1870IR	28 80	05.04-	CS191	24 5.4
		05.04- 09.06	CA1871IR	28 110			
		05.04-	CA1997IR	28 120			
	[D2066LF14]	05.04-	CA1997IR	28 120	05.04-	CS191	24 5.4
		04.06-	CA1870IR	28 80			
		04.06-	CA1871IR	28 110			
	[D2066LF28]	05.04-	CA1997IR	28 120	05.04-	CS191	24 5.4
	[D2066LF35]	05.04- 09.06	CA1870IR	28 80	05.04-	CS191	24 5.4
		05.04- 09.06	CA1871IR	28 110			
		05.04-	CA1997IR	28 120			
	[D2066LF39]	05.04-	CA1997IR	28 120	05.04-	CS191	24 5.4
18.310 12.0	(TGA)[D2866LF26]	09.02- 02.05	CA1847IR	28 80	02.00- 02.05	CS191	24 5.4
		03.99- 02.05	CA1663IR	28 90			
		03.99- 02.05	CA1695IR	28 55			
	[D2866LF36]	03.99- 09.01	CA1663IR	28 90	02.00- 09.01	CS191	24 5.4
		03.99- 09.01	CA1695IR	28 55			
18.320 10.5	(TGA)[D2066LF04]	05.04-	CA1870IR	28 80	05.04-	CS191	24 5.4
		05.04-	CA1871IR	28 110			
		05.04-	CA1997IR	28 120			
	[D2066LF14]	05.04-	CA1870IR	28 80	05.04-	CS191	24 5.4
		05.04-	CA1871IR	28 110			
		05.04-	CA1997IR	28 120			
	[D2066LF28]	05.04-	CA1997IR	28 120	05.04-	CS191	24 5.4
	[D2066LF35]	05.04-	CA1870IR	28 80	05.04-	CS191	24 5.4
		05.04-	CA1871IR	28 110			
		05.04-	CA1997IR	28 120			
	[D2066LF39]	05.04-	CA1997IR	28 120	05.04-	CS191	24 5.4
	(TGS)[D2066LF28]	10.07-	CA1870IR	28 80			
		10.07-	CA1871IR	28 110			
	[D2066LF39]	10.07-	CA1870IR	28 80			
		10.07-	CA1871IR	28 110			
		10.07-	CA1997IR	28 120			
	[D2066LOH01]	10.06-	CA1237IR	28 140			
18.330 6.9	(TGM)[D0836LFL44]	10.05-	CA1870IR	28 80			
		10.05-	CA1871IR	28 110			
	[D0836LFL52]	10.05-	CA1870IR	28 80			
		10.05-	CA1871IR	28 110			
	[D0836LFL55]	10.05-	CA1870IR	28 80			
18.340 6.9	(TGM)[D0836LFL65]	10.05-	CA1870IR	28 80			
		10.05-	CA1871IR	28 110			
18.350 10.5	(TGA)[D2066LF03]	05.04- 09.06	CA1870IR	28 80	05.04-	CS191	24 5.4
		05.04- 09.06	CA1871IR	28 110			
		05.04- 09.06	CA1997IR	28 120			
	[D2066LF13]	05.04- 09.06	CA1870IR	28 80	05.04-	CS191	24 5.4
		05.04- 09.06	CA1871IR	28 110			
		05.04- 09.06	CA1997IR	28 120			
	[D2066LF33]	05.04- 09.06	CA1870IR	28 80	05.04-	CS191	24 5.4
		05.04- 09.06	CA1871IR	28 110			
		05.04- 09.06	CA1997IR	28 120			
18.360 10.5	(TGA)[D2066LF07]	01.06-	CA1871IR	28 110			
	[D2066LF27]	01.06-	CA1871IR	28 110			
	[D2066LF38]	01.06-	CA1871IR	28 110			
	(TGS)[D2066LF27]	10.07-	CA1870IR	28 80			
		10.07-	CA1871IR	28 110			
	[D2066LF38]	10.07-	CA1870IR	28 80			
		10.07-	CA1871IR	28 110			
	(TGX)[D2066LF27]	10.07-	CA1870IR	28 80			
		10.07-	CA1871IR	28 110			
	[D2066LF38]	10.07-	CA1870IR	28 80			
		10.07-	CA1871IR	28 110			
18.360 12.0	(TGA)[D2866LF27]	09.02- 03.04	CA1847IR	28 80	02.00- 03.04	CS191	24 5.4
		03.99- 03.04	CA1237IR	28 140			
		03.99- 03.04	CA1663IR	28 90			
		03.99- 03.04	CA1695IR	28 55			
	[D2866LF37]	03.99- 03.04	CA1663IR	28 90	02.00- 03.04	CS191	24 5.4
		03.99- 03.04	CA1695IR	28 55			





18.390 10.5	(TGA)[D2066LF02]	05.04-	CA1870IR	28 80			
		05.04-	CA1871IR	28 110			
		05.04-	CA1997IR	28 120			
	[D2066LF12]	05.04-	CA1870IR	28 80			
		05.04-	CA1871IR	28 110			
		05.04-	CA1997IR	28 120			
	[D2066LF32]	05.04-	CA1870IR	28 80			
		05.04-	CA1871IR	28 110			
		05.04-	CA1997IR	28 120			
18.400 10.5	(TGA)[D2066LF26]	10.05-	CA1870IR	28 80			
		10.05-	CA1870IR	28 80			
		10.07-	CA1870IR	28 80			
	(TGS)[D2066LF26]	10.07-	CA1871IR	28 110			
		10.07-	CA1870IR	28 80			
		10.07-	CA1997IR	28 120			
	[D2066LF37]	10.07-	CA1870IR	28 80			
		10.07-	CA1871IR	28 110			
		10.07-	CA1997IR	28 120			
	(TGX)[D2066LF26]	10.07-	CA1870IR	28 80			
		10.07-	CA1871IR	28 110			
		10.07-	CA1870IR	28 80			
[D2066LF37]	10.07-	CA1870IR	28 80				
	10.07-	CA1871IR	28 110				
	10.07-	CA1997IR	28 120				
18.410 12.0	(TGA)[D2866LF28]	09.02- 12.05	CA1847IR	28 80	02.00- 12.05	CS191	24 5.4
		03.99- 12.05	CA1663IR	28 90			
		03.99- 12.05	CA1695IR	28 55			
	[D2866LF32]	03.99- 03.04	CA1663IR	28 90	02.00- 03.04	CS191	24 5.4
		03.99- 03.04	CA1695IR	28 55			
18.430 10.5	(TGA)[D2066LF01]	05.04-	CA1870IR	28 80			
		05.04-	CA1871IR	28 110			
		05.04-	CA1997IR	28 120			
	[D2066LF11]	05.04-	CA1870IR	28 80			
		05.04-	CA1871IR	28 110			
		05.04-	CA1997IR	28 120			
	[D2066LF31]	05.04-	CA1870IR	28 80			
		05.04-	CA1871IR	28 110			
		05.04-	CA1997IR	28 120			
18.440 10.5	(TGA)[D2066LF25]	09.05-	CA1871IR	28 110			
		09.05-	CA1871IR	28 110			
	[D2066LF36]	10.07-	CA1870IR	28 80			
		10.07-	CA1871IR	28 110			
	(TGS)[D2066LF25]	10.07-	CA1870IR	28 80			
		10.07-	CA1871IR	28 110			
	[D2066LF36]	10.07-	CA1870IR	28 80			
10.07-		CA1871IR	28 110				
18.440 12.4	(TGX)[D2676LF22]	10.07-	CA1997IR	28 120			
		10.07-	CA1871IR	28 110			
18.460 12.8	(TGA)[D2876LF04]	03.99- 05.04	CA1663IR	28 90	02.00- 05.04	CS191	24 5.4
		03.99- 05.04	CA1695IR	28 55			
		03.99- 05.04	CA1663IR	28 90	02.00- 05.04	CS191	24 5.4
	[D2876LF07]	03.99- 05.04	CA1663IR	28 90	02.00- 05.04	CS191	24 5.4
		03.99- 05.04	CA1695IR	28 55			
18.480 12.4	(TGA)[D2676LF01]	01.06-	CA1870IR	28 80			
		01.06-	CA1871IR	28 110			
		01.06-	CA1997IR	28 120			
	[D2676LF05]	01.06-	CA1870IR	28 80			
		02.06-	CA1871IR	28 110			
		02.06-	CA1871IR	28 110			
	[D2676LF12]	01.06-	CA1870IR	28 80			
		01.06-	CA1870IR	28 80			
	(TGS)[D2676LF14]	10.07-	CA1870IR	28 80			
		10.07-	CA1871IR	28 110			
		10.07-	CA1997IR	28 120			
	[D2676LF07]	10.07-	CA1997IR	28 120			
		10.07-	CA1870IR	28 80			
		10.07-	CA1871IR	28 110			
	(TGX)[D2676LF05]	10.07-	CA1870IR	28 80			
10.07-		CA1871IR	28 110				
10.07-		CA1870IR	28 80				
[D2676LF14]	10.07-	CA1870IR	28 80				
	10.07-	CA1871IR	28 110				
	10.07-	CA1871IR	28 110				
18.480 12.8	(TGA)[D2876LF12]	09.02-	CA1663IR	28 90	10.02-	CS191	24 5.4
		09.02-	CA1847IR	28 80			
18.510 12.8	(TGA)[D2876LF05]	04.00-	CA1663IR	28 90	04.00-	CS191	24 5.4
		04.00-	CA1695IR	28 55			
18.530 12.8	(TGA)[D2876LF13]	09.02-	CA1663IR	28 90	09.02-	CS191	24 5.4
		09.02-	CA1847IR	28 80			
18.540 12.4	(TGA)[D2676LF13]	08.06-	CA1871IR	28 110			
		10.07-	CA1870IR	28 80			
	(TGS)[D2676LF13]	10.07-	CA1871IR	28 110			
		10.07-	CA1870IR	28 80			
(TGX)[D2676LF13]	10.07-	CA1870IR	28 80				
	10.07-	CA1871IR	28 110				
18.680 16.2	(TGX)[D2868LF02]	10.07-	CA1870IR	28 80			
		10.07-	CA1871IR	28 110			
		10.07-	CA1997IR	28 120			
	[D2868LF03]	10.07-	CA1870IR	28 80			
		10.07-	CA1871IR	28 110			
10.07-	CA1997IR	28 120					
19.233 12.0	(F 2000)[E2866DF01]	09.96- 12.01	CA1035IR	28 80	09.96- 12.01	CS191	24 5.4
		09.96- 12.01	CA333IR	28 55			
		09.96- 12.01	CA333IR	28 55			
19.242 12.0	(F 90)[D2866F/240]	01.88- 02.89	CA222IR	28 35	01.88- 02.89	CS191	24 5.4
		01.88- 02.89	CA333IR	28 55			
		01.88- 02.89	CA333IR	28 55			
19.262 10.0	(F 90)[D2865LF/260]	01.88- 02.90	CA1035IR	28 80	01.88- 02.90	CS198	24 6.0
		01.88- 02.90	CA222IR	28 35	01.88- 02.90	CS191	24 5.4
		01.88- 02.90	CA333IR	28 55			
19.272 10.0	(F 90)[D2865LF02]	02.90- 05.95	CA1035IR	28 80	02.90- 05.95	CS191	24 5.4
		02.90- 10.93	CA222IR	28 35	02.90- 05.95	CS198	24 6.0
		02.90- 05.95	CA333IR	28 55			
	[D2865LF05]	02.90- 05.95	CA1035IR	28 80	02.90- 05.95	CS198	24 6.0
		02.90- 10.93	CA222IR	28 35	02.90- 05.95	CS191	24 5.4
		02.90- 05.95	CA333IR	28 55			
11.93- 05.95	CA854IR	28 35					
19.273 10.0	(F 2000)[D2865LF22]	01.94- 12.95	CA1035IR	28 80	01.94- 12.95	CS191	24 5.4
		01.94- 12.95	CA333IR	28 55			
		01.94- 12.95	CA854IR	28 35			
		01.94- 12.95	CA854IR	28 35			
19.292 12.0	(F 90)[D2866LF/290]	07.86- 02.90	CA1035IR	28 80	07.86- 02.90	CS191	24 5.4
		07.86- 02.90	CA222IR	28 35			
		07.86- 02.90	CA333IR	28 55			
		07.86- 02.90	CA333IR	28 55			
19.293 10.0	(F 2000)[D2865LF20]	01.94- 09.01	CA1035IR	28 80	01.94- 09.01	CS198	24 6.0
		01.94- 09.01	CA333IR	28 55	01.94- 09.01	CS191	24 5.4
		01.94- 09.01	CA854IR	28 35			
	[D2865LF24]	04.95- 09.01	CA1035IR	28 80	04.95- 09.01	CS191	24 5.4
		04.95- 09.01	CA333IR	28 55			
		04.95- 09.01	CA854IR	28 35			



MAN Continued

19.310 12.0	(E2000 Evolution)[D2866LF23]	05.00-	CA1663IR	28 90	05.00-	CS191	24 5.4
19.314 12.0	(F 2000)[D2866LF34]	06.98- 12.01 06.98- 12.01 06.98- 12.01 06.98- 12.01 06.98- 12.01	CA1035IR CA1663IR CA1695IR CA333IR CA854IR	28 80 28 90 28 55 28 55 28 35	06.98- 12.01	CS191	24 5.4
19.322 10.0	(F 90)[D2865LF03]	02.90- 06.96 02.90- 10.93 02.90- 05.95	CA1035IR CA222IR CA333IR	28 80 28 35 28 55	02.90- 06.96 02.90- 05.95	CS198 CS191	24 6.0 24 5.4
	[D2865LF06]	02.90- 06.96 02.90- 10.93 02.90- 06.96 02.90- 06.96	CA1035IR CA222IR CA333IR CA854IR	28 80 28 35 28 55 28 35	02.90- 06.96 02.90- 05.95	CS198 CS191	24 6.0 24 5.4
19.322 10.0 Unterflur	(F 90)[D2865LF03]	02.90- 05.94 02.90- 05.94 02.90- 05.94	CA1035IR CA333IR CA854IR	28 80 28 55 28 35	02.90- 05.94	CS191 CS198	24 5.4 24 6.0
	[D2865LF06]	02.90- 05.94 02.90- 05.94 02.90- 05.94	CA1035IR CA333IR CA854IR	28 80 28 55 28 35	02.90- 05.94	CS198	24 6.0
19.323 10.0	(F 2000)[D2865LF23]	01.94- 12.95 01.94- 12.95 01.94- 12.95	CA1035IR CA333IR CA854IR	28 80 28 55 28 35	01.94- 12.95	CS191	24 5.4
19.332 12.0	(F 90)[D2866LF/330]	07.86- 02.90 07.86- 02.90 07.86- 02.90	CA1035IR CA222IR CA333IR	28 80 28 35 28 55	07.86- 02.90	CS191	24 5.4
19.332 12.0 Unterflur	(F 90)[D2866LUL/330]	07.86- 02.90	CA333IR	28 55	07.86- 02.90	CS191	24 5.4
19.342 10.0	(F 90)[D2865LF09]	05.94- 06.96 05.94- 06.96 05.94- 06.96	CA1035IR CA333IR CA854IR	28 80 28 55 28 35	05.94- 06.96 05.94- 05.95	CS198 CS191	24 6.0 24 5.4
19.343 10.0	(F 2000)[D2865LF21]	01.94- 09.01 01.94- 09.01 01.94- 09.01	CA1035IR CA333IR CA854IR	28 80 28 55 28 35	01.94- 09.01	CS191	24 5.4
19.350 10.5	(TGA)[D2066LF03]	05.04-	CA1997IR	28 120			
19.360 10.5	(TGA)[D2066LF07]	05.04-	CA1997IR	28 120			
	(TGS)[D2066LF07]	02.11- 02.11- 02.11-	CA1870IR CA1871IR CA1997IR	28 80 28 110 28 120			
	[D2066LF48]	02.11- 02.11- 02.11-	CA1870IR CA1871IR CA1997IR	28 80 28 110 28 120			
	[D2066LF64]	02.11- 02.11- 02.11-	CA1870IR CA1871IR CA1997IR	28 80 28 110 28 120			
19.360 12.0	(E2000 Evolution)[D2866LF24]	05.00-	CA1663IR	28 90	05.00-	CS191	24 5.4
	(TGA)[D2866LF37]	05.04- 05.04-	CA1663IR CA1695IR	28 90 28 55	05.04-	CS191	24 5.4
19.362 12.0	(F 90)[D2866KF]	07.86- 02.90 07.86- 02.90 07.86- 02.90	CA1035IR CA222IR CA333IR	28 80 28 35 28 55	07.86- 02.90	CS191	24 5.4
	[D2866LXF]	07.86- 02.90 07.86- 02.90 07.86- 02.90	CA1035IR CA222IR CA333IR	28 80 28 35 28 55	07.86- 02.90	CS191	24 5.4
19.362 12.0 Unterflur	(F 90)[D2866KUL]	07.86- 01.91 Eng. 4912001- 07.86- 01.91 Eng. -4912000 07.86- 01.91	CA333IR CA710IR CA222IR	28 55 28 35 28 35	07.86- 01.91	CS191	24 5.4
19.364 12.0	(F 2000)[D2866LF35]	06.98- 12.01 06.98- 12.01 06.98- 12.01 06.98- 12.01 06.98- 12.01	CA1035IR CA1663IR CA1695IR CA333IR CA854IR	28 80 28 90 28 55 28 55 28 35	06.98- 12.01	CS191	24 5.4
19.372 12.0	(F 90)[D2866LF03]	02.90- 06.96 02.90- 10.93 02.90- 05.95	CA1035IR CA222IR CA333IR	28 80 28 35 28 55	02.90- 06.96	CS191	24 5.4
	[D2866LF05]	02.90- 06.96 02.90- 05.95 02.90- 05.95 02.90- 05.95	CA1035IR CA222IR CA333IR CA854IR	28 80 28 35 28 55 28 55	02.90- 06.96	CS191	24 5.4
	[D2866LF15]	02.90- 06.96 02.90- 05.95 02.90- 05.95 02.90- 05.95 09.93- 06.96	CA1035IR CA222IR CA333IR CA854IR	28 80 28 35 28 55 28 35	02.90- 06.96	CS191	24 5.4
	[D2866LXF/Silent]	05.90- 04.95 05.90- 04.95	CA222IR CA333IR	28 35 28 55	05.90- 11.90	CS191	24 5.4
19.372 12.0 Unterflur	(F 90)[D2866LF03]	02.90- 05.94 02.90- 05.94 02.90- 05.94	CA1035IR CA333IR CA854IR	28 80 28 55 28 35	02.90- 05.94	CS191 CS198	24 5.4 24 6.0
	[D2866LF05]	02.90- 05.94 02.90- 05.94 02.90- 05.94	CA1035IR CA333IR CA854IR	28 80 28 55 28 35	02.90- 11.92	CS191	24 5.4
19.373 12.0	(F 2000)[D2866LF21]	01.94- 12.95 01.94- 12.95 01.94- 12.95	CA1035IR CA333IR CA854IR	28 80 28 55 28 35	01.94- 12.95	CS191	24 5.4
19.390 10.5	(TGA)[D2066LF02]	05.04-	CA1997IR	28 120			
19.400 10.5	(TGA)[D2066LF06]	05.04-	CA1997IR	28 120			
	(TGS)[D2066LF06]	02.11- 02.11- 02.11-	CA1870IR CA1871IR CA1997IR	28 80 28 110 28 120			
	[D2066LF49]	02.11- 02.11- 02.11-	CA1870IR CA1871IR CA1997IR	28 80 28 110 28 120			
	[D2066LF63]	02.11- 02.11- 02.11-	CA1870IR CA1871IR CA1997IR	28 80 28 110 28 120			
19.402 12.0	(F 90)[D2866LF16]	05.94- 06.96 05.94- 05.95 05.94- 05.95 05.94- 06.96	CA1035IR CA222IR CA333IR CA854IR	28 80 28 35 28 55 28 35	05.94- 06.96	CS191	24 5.4
19.403 12.0	(F 2000)[D2866LF20]	01.94- 09.01 01.94- 09.01 01.94- 09.01 01.94- 09.01	CA1035IR CA1663IR CA1695IR CA333IR CA854IR	28 80 28 90 28 55 28 55 28 35	01.94- 09.01	CS191	24 5.4
19.410 12.0	(E2000 Evolution)[D2866LF25]	05.00-	CA1663IR	28 90	05.00-	CS191	24 5.4
	(TGA)[D2866LF32]	05.04- 05.04-	CA1663IR CA1695IR	28 90 28 55	05.04-	CS191	24 5.4



19.414 12.0	(F 2000)[D2866LF31]	06.98- 12.01 06.98- 12.01 06.98- 12.01 06.98- 12.01 06.98- 12.01	CA1035IR 28 80 CA1663IR 28 90 CA1695IR 28 55 CA333IR 28 55 CA854IR 28 35	06.98- 12.01	CS191	24 5.4
19.422 12.0	(F 90)[D2866LF06]	02.90- 06.96 02.90- 08.93 02.90- 10.92	CA1035IR 28 80 CA222IR 28 35 CA333IR 28 55	02.90- 06.96	CS191	24 5.4
	[D2866LF09]	02.90- 06.96 02.90- 06.96 02.90- 05.95 09.93- 06.96	CA1035IR 28 80 CA222IR 28 35 CA333IR 28 55 CA854IR 28 35	02.90- 06.96	CS191	24 5.4
	[D2866LF10]	02.90- 05.95 02.90- 05.95 02.90- 05.95	CA1035IR 28 80 CA222IR 28 35 CA333IR 28 55	02.90- 11.92	CS191	24 5.4
19.422 12.0 Unterflur	(F 90)[D2866LF06]	02.90- 05.94 02.90- 05.94 02.90- 05.94	CA1035IR 28 80 CA333IR 28 55 CA854IR 28 35	02.90- 11.90	CS191	24 5.4
	[D2866LF09]	02.90- 05.94 02.90- 05.94 02.90- 05.94	CA1035IR 28 80 CA222IR 28 35 CA333IR 28 55	02.90- 11.92	CS191	24 5.4
19.423 12.0	(F 2000)[D2866LF22]	01.94- 12.95 01.94- 12.95 01.94- 12.95 01.94- 12.95	CA1035IR 28 80 CA1663IR 28 90 CA1695IR 28 55 CA333IR 28 55 CA854IR 28 35	01.94- 12.95	CS191	24 5.4
19.430 10.5	(TGA)[D2066LF01]	05.04-	CA1997IR 28 120			
19.440 10.5	(TGS)[D2066LF50]	02.11- 02.11- 02.11-	CA1870IR 28 80 CA1871IR 28 110 CA1997IR 28 120			
	[D2066LF62]	02.11- 02.11- 02.11-	CA1870IR 28 80 CA1871IR 28 110 CA1997IR 28 120			
19.440 12.4	(TGA)[D2676LF04] (TGS)[D2676LF04]	02.06- 02.11- 02.11- 02.11-	CA1997IR 28 120 CA1870IR 28 80 CA1871IR 28 110 CA1997IR 28 120			
19.460 12.8	(E2000 Evolution)[D2876LF03]	05.00-  05.00- 05.00- 05.00- 05.00-	CA1035IR 28 80  CA1663IR 28 90 CA1695IR 28 55 CA333IR 28 55 CA854IR 28 35	05.00-	CS191	24 5.4
	(TGA)[D2876LF07]	05.04- 05.04-	CA1663IR 28 90 CA1695IR 28 55	05.04-	CS191	24 5.4
19.462 18.3	(F 90)[D2840LF/460]	05.87- 02.90 05.87- 02.90 05.87- 02.90	CA1035IR 28 80 CA222IR 28 35 CA333IR 28 55	05.87- 02.90	CS198	24 6.0
19.463 12.8	(F 2000)[D2876LF02]	01.94- 09.01 01.94- 09.01 01.94- 09.01 01.94- 09.01	CA1035IR 28 80 CA1663IR 28 90 CA1695IR 28 55 CA333IR 28 55	01.94- 09.01	CS191	24 5.4
19.464 12.8	(F 2000)[D2876LF06]	06.98- 07.01 06.98- 07.01 06.98- 07.01 06.98- 07.01 06.98- 07.01	CA1035IR 28 80 CA1663IR 28 90 CA1695IR 28 55 CA333IR 28 55 CA854IR 28 35	06.98- 07.01	CS191	24 5.4
19.480 12.4	(TGA)[D2676LF02] [D2676LF03] (TGS)[D2676LF02]	02.06- 02.06- 02.11- 02.11- 02.11-	CA1997IR 28 120 CA1997IR 28 120 CA1870IR 28 80 CA1871IR 28 110 CA1997IR 28 120			
	[D2676LF03]	02.11- 02.11- 02.11-	CA1870IR 28 80 CA1871IR 28 110 CA1997IR 28 120			
	[D2676LF20]	02.11- 02.11- 02.11-	CA1870IR 28 80 CA1871IR 28 110 CA1997IR 28 120			
	[D2676LF31]	02.11- 02.11- 02.11-	CA1870IR 28 80 CA1871IR 28 110 CA1997IR 28 120			
19.480 12.8	(TGA)[D2876LF25]	05.04-	CA1847IR 28 80	05.04-	CS191	24 5.4
19.502 18.3	(F 90)[D2840LF01]	02.90- 06.96 02.90- 06.96 02.90- 06.96 02.90- 06.96	CA1035IR 28 80 CA222IR 28 35 CA333IR 28 55 CA854IR 28 35	02.90- 06.96	CS198	24 6.0
	[D2840LF04]	02.90- 06.96 02.90- 06.96 02.90- 06.96 02.90- 06.96	CA1035IR 28 80 CA222IR 28 35 CA333IR 28 55 CA854IR 28 35	02.90- 06.96	CS198	24 6.0
	[D2840LF06]	02.90- 06.96 02.90- 06.96 02.90- 06.96 02.90- 06.96	CA1035IR 28 80 CA222IR 28 35 CA333IR 28 55 CA854IR 28 35	02.90- 06.96	CS198	24 6.0
19.603 18.3	(F 2000)[D2840LF20]			04.96- 09.01	CS198	24 6.0
20.224 6.9	(M 2000 L)	05.01-	CA333IR 28 55			
22.240 6.9	(TGM)[D0836LFL53]	10.05-	CA1870IR 28 80			
22.250 6.9	(TGM)[D0836LFL63]	10.05-	CA1870IR 28 80			
22.280 6.9	(TGM)[D0836LFL54]	10.05-	CA1870IR 28 80			
22.290 6.9	(TGM)[D0836LFL64]	10.05-	CA1870IR 28 80			
23.293 10.0	(F 2000)[D2865LF20]	01.94- 01.00 01.94- 01.00 01.94- 01.00	CA1035IR 28 80 CA333IR 28 55 CA854IR 28 35	01.94- 01.00 01.94- 01.00	CS191 CS198	24 5.4 24 6.0
	[D2865LF24]	04.95- 01.00 04.95- 01.00 04.95- 01.00	CA1035IR 28 80 CA333IR 28 55 CA854IR 28 35	04.95- 01.00	CS191	24 5.4
23.314 12.0	(F 2000)	05.01-	CA333IR 28 55			
23.343 10.0	(F 2000)[D2865LF21]	01.94- 01.00 01.94- 01.00 01.94- 01.00	CA1035IR 28 80 CA333IR 28 55 CA854IR 28 35	01.94- 01.00	CS191	24 5.4
23.364 12.0	(F 2000)	05.01-	CA333IR 28 55			
23.403 12.0	(F 2000)[D2866LF20]	01.94- 09.00 01.94- 09.00 01.94- 09.00 01.94- 09.00 01.94- 09.00	CA1035IR 28 80 CA1663IR 28 90 CA1695IR 28 55 CA333IR 28 55 CA854IR 28 35	01.94- 09.00	CS191	24 5.4
23.463 12.8	(F 2000)[D2876LF02]	01.94- 09.01 01.94- 09.01 01.94- 09.01 01.94- 09.01	CA1035IR 28 80 CA1663IR 28 90 CA1695IR 28 55 CA333IR 28 55	01.94- 09.01	CS191	24 5.4



**MAN Continued**

24.192 6.9	(M 90)[D0826LF01]	07.89- 06.96 CA1035IR 28 80	07.89- 06.96 CS269 24 4.0	
		07.89- 06.96 CA333IR 28 55	07.89- 06.96 CS595 24 4.0	
		07.89- 10.92 CA710IR 28 35		
	[D0826LF05]	07.89- 06.96 CA1035IR 28 80	07.89- 06.96 CS595 24 4.0	
	07.89- 06.96 CA333IR 28 55	07.89- 06.96 CS269 24 4.0		
	07.89- 05.94 CA710IR 28 35			
24.222 6.9	(M 90)[D0826LF11]	07.89- 06.96 CA1035IR 28 80	07.89- 06.96 CS269 24 4.0	
		07.89- 06.96 CA333IR 28 55	07.89- 06.96 CS595 24 4.0	
		07.89- 07.94 CA710IR 28 35		
		08.94- 06.96 CA854IR 28 35		
24.232 6.9	(M 90)[D0826LF/217/Silent]	05.90- 04.95 CA1035IR 28 80	05.90- 04.95 CS269 24 4.0	
		05.90- 03.92 CA222IR 28 35	05.90- 04.95 CS595 24 4.0	
		05.90- 04.95 CA333IR 28 55		
		04.92- 04.95 CA854IR 28 35		
	[D0826LF02]	07.89- 06.96 CA1035IR 28 80	07.89- 06.96 CS595 24 4.0	
		07.89- 06.96 CA333IR 28 55	07.89- 06.96 CS269 24 4.0	
		07.89- 10.92 CA710IR 28 35		
	[D0826LF06]	07.89- 06.96 CA1035IR 28 80	07.89- 06.96 CS1267 24 4.0	
		07.89- 06.96 CA186IR 14 55	07.89- 06.96 CS595 24 4.0	
		07.89- 06.96 CA333IR 28 55		
		06.92- 04.94 CA710IR 28 35		
	[D0826LF08]	07.89- 06.96 CA1035IR 28 80	07.89- 06.96 CS1267 24 4.0	
07.89- 06.96 CA186IR 14 55		07.89- 06.96 CS595 24 4.0		
07.89- 06.96 CA333IR 28 55				
05.94- 06.96 CA854IR 28 35				
24.242 12.0	(F 90)[D2866F/240]	01.88- 02.90 CA222IR 28 35	01.88- 07.88 CS191 24 5.4	
		01.88- 02.90 CA333IR 28 55		
24.262 10.0	(F 90)[D2865LF/260]	01.88- 02.90 CA1035IR 28 80	01.88- 02.90 CS191 24 5.4	
		01.88- 02.90 CA222IR 28 35	01.88- 02.90 CS198 24 6.0	
		01.88- 02.90 CA333IR 28 55		
24.262 6.9	(M 90)[D0826LF13]	08.95- 06.96 CA1035IR 28 80	08.95- 06.96 CS1267 24 4.0	
		08.95- 06.96 CA186IR 14 55	08.95- 06.96 CS595 24 4.0	
		08.95- 06.96 CA333IR 28 55		
		08.95- 06.96 CA854IR 28 35		
24.272 10.0	(F 90)[D2865LF02]	02.90- 05.95 CA1035IR 28 80	02.90- 05.95 CS191 24 5.4	
		02.90- 04.95 CA222IR 28 35	02.90- 05.95 CS198 24 6.0	
		02.90- 05.95 CA333IR 28 55		
		11.93- 05.95 CA854IR 28 35		
	[D2865LF05]	02.90- 05.95 CA1035IR 28 80	02.90- 05.95 CS191 24 5.4	
		02.90- 05.95 CA333IR 28 55	02.90- 05.95 CS198 24 6.0	
		02.90- 05.95 CA854IR 28 35		
[D2865LF02]	09.91- 05.94 CA1035IR 28 80	09.91- 05.94 CS191 24 5.4		
	09.91- 10.93 CA222IR 28 35	09.91- 05.94 CS198 24 6.0		
	09.91- 05.94 CA333IR 28 55			
	11.93- 05.94 CA854IR 28 35			
24.272 6.9	(M 90)[D0826LF04]	10.92- 06.96 CA1035IR 28 80	10.92- 06.96 CS1267 24 4.0	
		10.92- 06.96 CA186IR 14 55	10.92- 06.96 CS595 24 4.0	
		10.92- 06.96 CA333IR 28 55		
		10.92- 04.94 CA710IR 28 35		
		05.94- 06.96 CA854IR 28 35		
24.273 10.0	(F 2000)[D2865LF22]	01.94- 12.95 CA1035IR 28 80	01.94- 12.95 CS191 24 5.4	
		01.94- 12.95 CA333IR 28 55		
		01.94- 12.95 CA854IR 28 35		
24.292 12.0	(F 90)[D2866LF/290]	10.86- 02.90 CA1035IR 28 80	10.86- 02.90 CS191 24 5.4	
		10.86- 02.90 CA222IR 28 35		
		10.86- 02.90 CA333IR 28 55		
24.293 10.0	(F 2000)[D2865LF24]	01.94- 01.00 CA1035IR 28 80	01.94- 01.00 CS191 24 5.4	
		01.94- 01.00 CA333IR 28 55		
		01.94- 01.00 CA854IR 28 35		
24.302 12.0	(F 90)[D2866LF04]	05.90- 04.95 CA1035IR 28 80	05.90- 12.90 CS191 24 5.4	
		05.90- 04.95 CA222IR 28 35		
		05.90- 04.95 CA333IR 28 55		
24.314 12.0	(F 2000)	05.01- CA333IR 28 55		
24.320 10.5	(TGS)[D2066LF28]	10.07- CA1870IR 28 80		
		10.07- CA1871IR 28 110		
24.322 10.0	(F 90)[D2865LF03]	02.90- 05.95 CA1035IR 28 80	02.90- 05.95 CS198 24 6.0	
		02.90- 12.90 CA222IR 28 35	02.90- 12.90 CS191 24 5.4	
		02.90- 05.95 CA333IR 28 55		
	[D2865LF06]	02.90- 05.95 CA1035IR 28 80	02.90- 05.95 CS198 24 6.0	
		02.90- 05.95 CA333IR 28 55	02.90- 05.95 CS191 24 5.4	
		02.90- 05.95 CA854IR 28 35		
24.322 10.0 Unterflur	(F 90)[D2865LF03]	02.90- 12.90 CA1035IR 28 80	02.90- 12.90 CS191 24 5.4	
		02.90- 12.90 CA222IR 28 35	02.90- 12.90 CS198 24 6.0	
		02.90- 12.90 CA333IR 28 55		
24.323 10.0	(F 2000)[D2865LF23]	01.94- 12.95 CA1035IR 28 80	01.94- 12.95 CS191 24 5.4	
		01.94- 12.95 CA333IR 28 55		
		01.94- 12.95 CA854IR 28 35		
24.332 12.0	(F 90)[D2866LF/330]	10.86- 02.90 CA1035IR 28 80	10.86- 02.90 CS191 24 5.4	
		10.86- 02.90 CA222IR 28 35		
		10.86- 02.90 CA333IR 28 55		
24.332 12.0 Unterflur	(F 90)[D2866LUL/330]	10.86- 02.90 CA333IR 28 55	10.86- 02.90 CS191 24 5.4	
24.342 10.0	(F 90)[D2865LF09]	05.94- 05.95 CA1035IR 28 80	05.94- 05.95 CS198 24 6.0	
		05.94- 05.95 CA333IR 28 55	05.94- 05.95 CS191 24 5.4	
		05.94- 05.95 CA854IR 28 35		
24.343 10.0	(F 2000)[D2865LF21]	01.94- 01.00 CA1035IR 28 80	01.94- 01.00 CS191 24 5.4	
		01.94- 01.00 CA333IR 28 55		
		01.94- 01.00 CA854IR 28 35		
24.350 10.5	(TGA)[D2066LF03]	02.04- 09.06 CA1870IR 28 80		
		02.04- 09.06 CA1871IR 28 110		
		02.04- 09.06 CA1997IR 28 120		
	[D2066LF13]	02.04- 09.06 CA1870IR 28 80		
		02.04- 09.06 CA1871IR 28 110		
	[D2066LF33]	02.04- CA1997IR 28 120		
		02.04- CA1870IR 28 80		
24.360 10.5	(TGA)[D2066LF03]	02.04- 09.06 CA1870IR 28 80		
		02.04- 09.06 CA1871IR 28 110		
		02.04- 09.06 CA1997IR 28 120		
	[D2066LF13]	02.04- CA1870IR 28 80		
		02.04- CA1871IR 28 110		
		02.04- CA1997IR 28 120		
	[D2066LF33]	02.04- 07.06 CA1870IR 28 80		
		02.04- 07.06 CA1871IR 28 110		
			02.04- CA1997IR 28 120	
	(TGS)[D2066LF27]	10.07- CA1870IR 28 80		
		10.07- CA1871IR 28 110		
10.07- CA1870IR 28 80				
[D2066LF38]		10.07- CA1870IR 28 80		



		10.07-	CA1871IR	28 110			
	(TGX)[D2066LF27]	10.07-	CA1870IR	28 80			
		10.07-	CA1871IR	28 110			
	[D2066LF38]	10.07-	CA1870IR	28 80			
		10.07-	CA1871IR	28 110			
24.360 12.0	(TGA)[D2866LF27]	11.02- 05.04	CA1663IR	28 90	11.02- 05.04	CS191	24 5.4
		11.02- 05.04	CA1695IR	28 55			
		11.02- 05.04	CA1847IR	28 80			
24.362 12.0	(F 90)[D2866KF]	10.86- 02.90	CA1035IR	28 80	10.86- 02.90	CS191	24 5.4
		10.86- 02.90	CA222IR	28 35			
		10.86- 02.90	CA333IR	28 55			
	[D2866LXF]	10.86- 02.90	CA1035IR	28 80	10.86- 02.90	CS191	24 5.4
		10.86- 02.90	CA222IR	28 35			
		10.86- 02.90	CA333IR	28 55			
24.362 12.0 Unterflur	(F 90)[D2866KUL]	10.86- 02.90	CA333IR	28 55	10.86- 02.90	CS191	24 5.4
		Eng. 4912001- 10.86- 02.90	CA710IR	28 35			
		Eng. -4912000 10.86- 02.90	CA222IR	28 35			
24.364 12.0	(F 2000)	Eng. -4912000 05.01-	CA333IR	28 55			
24.372 12.0	(F 90)[D2866LF03]	02.90- 10.92	CA1035IR	28 80	02.90- 05.95	CS191	24 5.4
		02.90- 10.92	CA222IR	28 35			
		02.90- 10.92	CA333IR	28 55			
	[D2866LF15]	02.90- 05.95	CA1035IR	28 80	02.90- 12.94	CS191	24 5.4
		02.90- 05.95	CA222IR	28 35			
		02.90- 05.95	CA333IR	28 55			
	[D2866LXF/Silent]	05.90- 12.90	CA1035IR	28 80	05.90- 12.90	CS191	24 5.4
		05.90- 12.90	CA222IR	28 35			
		05.90- 12.90	CA333IR	28 55			
24.372 12.0 Unterflur	(F 90)[D2866LF03]	02.90- 12.90	CA1035IR	28 80	02.90- 12.90	CS191	24 5.4
		02.90- 12.90	CA222IR	28 35			
		02.90- 12.90	CA333IR	28 55			
	[D2866LF15]	02.90- 05.95	CA1035IR	28 80	02.90- 10.94	CS191	24 5.4
		02.90- 05.95	CA222IR	28 35			
		02.90- 05.95	CA333IR	28 55			
24.373 12.0	(F 2000)[D2866LF21]	01.94- 12.95	CA1035IR	28 80	01.94- 12.95	CS191	24 5.4
		01.94- 12.95	CA333IR	28 55			
		01.94- 12.95	CA854IR	28 35			
24.390 10.5	(TGA)[D2066LF02]	05.04- 09.06	CA1870IR	28 80			
		05.04- 09.06	CA1871IR	28 110			
		05.04-	CA1997IR	28 120			
	[D2066LF12]	05.04- 09.06	CA1870IR	28 80			
		05.04- 09.06	CA1871IR	28 110			
		05.04-	CA1997IR	28 120			
	[D2066LF32]	05.04-	CA1870IR	28 80			
		05.04-	CA1871IR	28 110			
		05.04-	CA1997IR	28 120			
24.400 10.5	(TGA)[D2066LF02]	05.04-	CA1870IR	28 80			
		05.04-	CA1871IR	28 110			
		05.04-	CA1997IR	28 120			
	[D2066LF12]	05.04-	CA1870IR	28 80			
		05.04-	CA1871IR	28 110			
		05.04-	CA1997IR	28 120			
	[D2066LF32]	05.04- 07.06	CA1870IR	28 80			
		05.04- 07.06	CA1871IR	28 110			
		05.04-	CA1997IR	28 120			
	(TGS)[D2066LF26]	10.07-	CA1870IR	28 80			
		10.07-	CA1871IR	28 110			
	[D2066LF37]	10.07-	CA1870IR	28 80			
		10.07-	CA1871IR	28 110			
		10.07-	CA1997IR	28 120			
	(TGX)[D2066LF26]	10.07-	CA1870IR	28 80			
		10.07-	CA1871IR	28 110			
	[D2066LF37]	10.07-	CA1870IR	28 80			
		10.07-	CA1871IR	28 110			
		10.07-	CA1997IR	28 120			
24.402 12.0	(F 90)[D2866LF16]	05.94- 05.95	CA1035IR	28 80	05.94- 12.94	CS191	24 5.4
		05.94- 05.95	CA222IR	28 35			
		05.94- 05.95	CA333IR	28 55			
24.403 12.0	(F 2000)[D2866LF20]	01.94- 09.01	CA1035IR	28 80	01.94- 09.01	CS191	24 5.4
		01.94- 09.01	CA1663IR	28 90			
		01.94- 09.01	CA1695IR	28 55			
		01.94- 09.01	CA333IR	28 55			
		01.94- 09.01	CA854IR	28 35			
24.410 12.0	(TGA)[D2866LF28]	11.02- 05.04	CA1663IR	28 90	11.02- 05.04	CS191	24 5.4
		11.02- 05.04	CA1695IR	28 55			
24.414 12.0	(F 2000)	05.01-	CA333IR	28 55			
24.422 12.0	(F 90)[D2866LF06]	02.90- 12.90	CA1035IR	28 80	02.90- 12.90	CS191	24 5.4
		02.90- 12.90	CA222IR	28 35			
		02.90- 12.90	CA333IR	28 55			
	[D2866LF09]	02.90- 05.95	CA1035IR	28 80	02.90- 12.94	CS191	24 5.4
		02.90- 05.95	CA222IR	28 35			
		02.90- 05.95	CA333IR	28 55			
24.422 12.0 Unterflur	(F 90)[D2866LF06]	02.90- 12.90	CA1035IR	28 80	02.90- 12.90	CS191	24 5.4
		02.90- 12.90	CA222IR	28 35			
		02.90- 12.90	CA333IR	28 55			
24.423 12.0	(F 2000)[D2866LF22]	01.94- 12.95	CA1035IR	28 80	01.94- 12.95	CS191	24 5.4
		01.94- 12.95	CA1663IR	28 90			
		01.94- 12.95	CA1695IR	28 55			
		01.94- 12.95	CA333IR	28 55			
		01.94- 12.95	CA854IR	28 35			
24.430 10.5	(TGA)[D2066LF01]	05.04- 09.06	CA1870IR	28 80			
		05.04- 09.06	CA1871IR	28 110			
		05.04-	CA1997IR	28 120			
	[D2066LF11]	05.04- 09.06	CA1870IR	28 80			
		05.04- 09.06	CA1871IR	28 110			
		05.04-	CA1997IR	28 120			
	[D2066LF23]	05.04-	CA1870IR	28 80			
		05.04-	CA1871IR	28 110			
		05.04-	CA1997IR	28 120			
	[D2066LF31]	05.04-	CA1870IR	28 80			
		05.04-	CA1871IR	28 110			
		05.04-	CA1997IR	28 120			
24.440 10.5	(HOCL-N)[D2066LOH10]		CA1237IR	28 140			
			CA1997IR	28 120			
	(TGA)[D2066LF01]	05.04-	CA1870IR	28 80			
		05.04-	CA1871IR	28 110			
		05.04-	CA1997IR	28 120			



MAN Continued

	[D2066LF11]	05.04-05.04-05.04	CA1870IR CA1871IR CA1997IR	28 80 28 110 28 120			
	[D2066LF23]	05.04-05.04-05.04	CA1870IR CA1871IR CA1997IR	28 80 28 110 28 120			
	[D2066LF31]	05.04-05.04-05.04	CA1870IR CA1871IR CA1997IR	28 80 28 110 28 120			
	(TGS)[D2066LF25]	10.07-10.07-10.07	CA1870IR CA1871IR CA1870IR	28 80 28 110 28 80			
	[D2066LF36]	10.07-10.07-10.07	CA1870IR CA1871IR CA1870IR	28 80 28 110 28 80			
	(TGX)[D2066LF25]	10.07-10.07-10.07	CA1870IR CA1871IR CA1870IR	28 80 28 110 28 80			
	[D2066LF36]	10.07-10.07-10.07	CA1870IR CA1871IR CA1997IR	28 80 28 110 28 120			
24.440 12.4	(TGX)[D2676LF22]	10.07-11.02-05.04	CA1997IR CA1663IR	28 120 28 90	11.02-05.04	CS191	24 5.4
24.460 12.8	(TGA)[D2876LF04]	11.02-05.04-11.02-05.04	CA1663IR CA1695IR	28 90 28 55			
24.462 18.3	(F 90)[D2840LF460]	05.87-02.90-05.87-02.90-05.87-02.90	CA1035IR CA222IR CA333IR	28 80 28 35 28 55	05.87-02.90	CS198	24 6.0
24.463 12.8	(F 2000)[D2876LF02]	01.94-09.01-01.94-09.01-01.94-09.01-01.94-09.01	CA1035IR CA1663IR CA1695IR CA333IR	28 80 28 90 28 55 28 55	01.94-09.01	CS191	24 5.4
24.464 12.8	(F 2000)	05.01-01.06-01.06-	CA333IR CA1870IR CA1871IR	28 55 28 80 28 110			
24.480 12.4	(TGA)[D2676LF01]	01.06-01.06-01.06-	CA1870IR CA1871IR CA1870IR	28 80 28 110 28 80			
	[D2676LF12]	01.06-01.06-10.07-10.07-	CA1870IR CA1871IR CA1870IR CA1871IR	28 80 28 110 28 80 28 110			
	(TGS)[D2676LF05]	10.07-10.07-10.07-	CA1870IR CA1871IR CA1870IR	28 80 28 110 28 80			
	[D2676LF14]	10.07-10.07-10.07-	CA1870IR CA1871IR CA1870IR	28 80 28 110 28 80			
	(TGX)[D2676LF05]	10.07-10.07-10.07-	CA1870IR CA1871IR CA1870IR	28 80 28 110 28 80			
	[D2676LF14]	10.07-10.07-10.07-	CA1870IR CA1871IR CA1870IR	28 80 28 110 28 110			
24.480 12.8	(TGA)[D2876LF12]	09.02-09.06-02.90-12.90	CA1847IR CA1035IR	28 80 28 80	06.03-09.06	CS191	24 5.4
24.502 18.3	(F 90)[D2840LF01]	02.90-12.90-02.90-12.90-02.90-12.90	CA1035IR CA333IR CA854IR	28 80 28 55 28 35	02.90-12.90	CS198	24 6.0
24.510 12.8	(TGA)[D2876LF05]	11.02-06.03-11.02-06.03	CA1663IR CA1695IR	28 90 28 55	11.02-06.03	CS191	24 5.4
24.530 12.8	(TGA)[D2876LF13]	12.02-09.06-01.06-01.06-	CA1847IR CA1870IR CA1871IR	28 80 28 80 28 110	12.02-09.06	CS191	24 5.4
24.540 12.4	(TGA)[D2676LF11]	01.06-01.06-10.07-10.07-	CA1870IR CA1871IR CA1870IR CA1871IR	28 80 28 110 28 80 28 110			
	(TGS)[D2676LF13]	10.07-10.07-02.09-10.07-	CA1870IR CA1871IR CA1997IR CA1870IR	28 80 28 110 28 120 28 80			
	(TGX)[D2676LF06]	02.09-10.07-10.07-	CA1997IR CA1870IR CA1871IR	28 120 28 80 28 110			
25.224 6.9	(M 2000 M)[D0826LF15]	08.95-03.97-08.95-03.97-08.95-03.97-08.95-03.97-08.95-03.97	CA1035IR CA1663IR CA1695IR CA333IR CA854IR	28 80 28 90 28 55 28 55 28 35	08.95-03.97	CS269	24 4.0
	[D0826LF18]	08.95-03.97-08.95-03.97-08.95-03.97-08.95-03.97-08.95-03.97	CA1035IR CA1663IR CA1695IR CA333IR CA854IR	28 80 28 90 28 55 28 55 28 35	08.95-03.97	CS595	24 4.0
	[D0826LF18]	08.95-03.97-08.95-03.97-08.95-03.97-08.95-03.97-08.95-03.97	CA1035IR CA1663IR CA1695IR CA333IR CA854IR	28 80 28 90 28 55 28 55 28 35	08.95-09.99	CS269	24 4.0
	[D0826LF18]	08.95-03.97-08.95-03.97-08.95-03.97-08.95-03.97-08.95-03.97	CA1035IR CA1663IR CA1695IR CA333IR CA854IR	28 80 28 90 28 55 28 55 28 35	10.99-08.95-01.00	CS1267	24 4.0
	[D0826LF18]	08.95-03.97-08.95-03.97-08.95-03.97-08.95-03.97-08.95-03.97	CA1035IR CA1663IR CA1695IR CA333IR CA854IR	28 80 28 90 28 55 28 55 28 35	02.00-	CS595	24 4.0
	[D0826LF18]	08.95-03.97-08.95-03.97-08.95-03.97-08.95-03.97-08.95-03.97	CA1035IR CA1663IR CA1695IR CA333IR CA854IR	28 80 28 90 28 55 28 55 28 35	02.00-	CS1243	24 4.0
25.264 6.9	(M 2000 M)[D0826LF17]	08.95-09.01-08.95-09.01-08.95-09.01-08.95-09.01-08.95-09.01	CA1035IR CA1663IR CA1695IR CA333IR CA854IR	28 80 28 90 28 55 28 55 28 35	08.95-09.01	CS595	24 4.0
	[D0826LF17]	08.95-09.01-08.95-09.01-08.95-09.01-08.95-09.01-08.95-09.01	CA1035IR CA1663IR CA1695IR CA333IR CA854IR	28 80 28 90 28 55 28 55 28 35	08.95-09.01	CS269	24 4.0
25.272 10.0	(F 90)[D2865LF02]	09.90-10.93-09.90-10.93-09.90-10.93-09.90-10.93	CA1035IR CA222IR CA333IR	28 80 28 35 28 55	09.90-10.93	CS191	24 5.4
	[D2865LF05]	09.90-10.93-09.90-10.93-09.90-10.93-09.90-10.93	CA1035IR CA222IR CA333IR	28 80 28 35 28 55	09.90-10.93	CS198	24 6.0
	[D2865LF05]	09.90-10.93-09.90-10.93-09.90-10.93-09.90-10.93	CA1035IR CA222IR CA333IR	28 80 28 35 28 55	09.90-10.93	CS191	24 5.4
25.285 6.9	(M 2000 M)[D0836LF03]	02.03-02.03-	CA1663IR CA1695IR	28 90 28 55	02.03-	CS1243	24 4.0
25.302 12.0	(F 90)[D2866LF04]	09.90-12.91-09.90-12.91-09.90-12.91-09.90-12.91	CA1035IR CA222IR CA333IR	28 80 28 35 28 55	09.90-11.90	CS191	24 5.4
25.322 10.0	(F 90)[D2865LF03]	09.90-12.92-09.90-12.92-09.90-12.92-09.90-12.92	CA1035IR CA222IR CA333IR	28 80 28 35 28 55	09.90-12.92	CS198	24 6.0
	[D2865LF06]	09.90-12.92-09.90-12.92-09.90-12.92-09.90-12.92	CA1035IR CA222IR CA333IR	28 80 28 35 28 55	09.90-12.92	CS191	24 5.4
25.322 10.0 Unterflur	(F 90)[D2865LF03]	09.90-12.92-09.90-12.92-09.90-12.92-09.90-12.92	CA1035IR CA222IR CA333IR	28 80 28 35 28 55	09.90-11.91	CS191	24 5.4
	[D2865LF06]	09.90-12.92-09.90-12.92-09.90-12.92-09.90-12.92	CA1035IR CA222IR CA333IR	28 80 28 35 28 55	09.90-12.92	CS198	24 6.0
	[D2865LF06]	09.90-12.92-09.90-12.92-09.90-12.92-09.90-12.92	CA1035IR CA222IR CA333IR	28 80 28 35 28 55	09.90-12.92	CS191	24 5.4
	[D2865LF06]	09.90-12.92-09.90-12.92-09.90-12.92-09.90-12.92	CA1035IR CA222IR CA333IR	28 80 28 35 28 55	09.90-12.92	CS198	24 6.0
25.372 12.0	(F 90)[D2866LF03]	09.90-10.93-09.90-10.93-09.90-10.93-09.90-10.93	CA1035IR CA222IR CA333IR	28 80 28 35 28 55	09.90-12.92	CS191	24 5.4
	[D2866LF05]	09.90-10.93-09.90-10.93-09.90-10.93-09.90-10.93	CA1035IR CA222IR CA333IR	28 80 28 35 28 55	09.90-12.92	CS191	24 5.4
	[D2866LXF/Silent]	09.90-10.93-09.90-10.93-09.90-10.93-09.90-10.93	CA1035IR CA222IR CA333IR	28 80 28 35 28 55	09.90-10.93	CS191	24 5.4
	[D2866LXF/Silent]	09.90-10.93-09.90-10.93-09.90-10.93-09.90-10.93	CA1035IR CA222IR CA333IR	28 80 28 35 28 55	09.90-10.93	CS198	24 6.0
25.372 12.0 Unterflur	(F 90)[D2866LF03]	09.90-12.92-09.90-12.92-09.90-12.92-09.90-12.92	CA1035IR CA222IR CA333IR	28 80 28 35 28 55	09.90-12.92	CS191	24 5.4
	[D2866LF05]	09.90-12.92-09.90-12.92-09.90-12.92-09.90-12.92	CA1035IR CA222IR CA333IR	28 80 28 35 28 55	09.90-12.92	CS191	24 5.4
	[D2866LF05]	09.90-12.92-09.90-12.92-09.90-12.92-09.90-12.92	CA1035IR CA222IR CA333IR	28 80 28 35 28 55	09.90-12.92	CS191	24 5.4



25.422 12.0	(F 90)[D2866LF06]	09.90- 12.92	CA1035IR	28 80	09.90- 11.90	CS191	24 5.4
		09.90- 12.92	CA222IR	28 35			
		09.90- 12.92	CA333IR	28 55			
[D2866LF09]		09.90- 12.92	CA1035IR	28 80	09.90- 12.92	CS191	24 5.4
		09.90- 12.92	CA222IR	28 35			
		09.90- 12.92	CA333IR	28 55			
25.422 12.0 Unterflur	(F 90)[D2866LF06]	09.90- 12.92	CA1035IR	28 80	09.90- 11.90	CS191	24 5.4
		09.90- 12.92	CA222IR	28 35			
		09.90- 12.92	CA333IR	28 55			
[D2866LF09]		09.90- 12.92	CA1035IR	28 80	09.90- 12.92	CS191	24 5.4
		09.90- 12.92	CA222IR	28 35			
		09.90- 12.92	CA333IR	28 55			
25.502 18.3	(F 90)[D2840LF01]	09.90- 12.92	CA1035IR	28 80	09.90- 12.92	CS198	24 6.0
		09.90- 12.92	CA333IR	28 55			
		09.90- 12.92	CA854IR	28 35			
[D2840LF04]		09.90- 12.92	CA1035IR	28 80	09.90- 12.92	CS198	24 6.0
		09.90- 12.92	CA222IR	28 35			
		09.90- 12.92	CA333IR	28 55			
26.233 12.0	(F 2000)[E2866DF01]	09.96- 08.02	CA1035IR	28 80	09.96- 08.02	CS191	24 5.4
		09.96- 08.02	CA333IR	28 55			
		03.00-	CA333IR	28 55			
26.233 12.0	(F 2000)	03.00-	CA333IR	28 55			
26.242 12.0	(F 90)[D2866F/240]	01.88- 07.89	CA222IR	28 35	01.88- 03.89	CS191	24 5.4
		01.88- 07.89	CA333IR	28 55			
26.262 10.0	(F 90)[D2865LF/260]	01.88- 02.90	CA1035IR	28 80	01.88- 02.90	CS191	24 5.4
		01.88- 02.90	CA222IR	28 35			
		01.88- 02.90	CA333IR	28 55			
26.272 10.0	(F 90)[D2865LF02]	02.90- 06.96	CA1035IR	28 80	02.90- 12.92	CS191	24 5.4
		02.90- 08.93	CA222IR	28 35			
		02.90- 06.96	CA333IR	28 55			
[D2865LF05]		02.90- 06.96	CA854IR	28 35	02.90- 06.96	CS198	24 6.0
		02.90- 06.96	CA1035IR	28 80			
		02.90- 10.93	CA222IR	28 35			
		02.90- 06.96	CA333IR	28 55			
		09.93- 06.96	CA854IR	28 35			
26.273 10.0	(F 2000)[D2865LF22]	01.94- 12.95	CA1035IR	28 80	01.94- 12.95	CS191	24 5.4
		01.94- 12.95	CA333IR	28 55			
		01.94- 12.95	CA854IR	28 35			
26.280 6.9	(TGA)[D0836LF41]	11.02-	CA1870IR	28 80			
		11.02-	CA1871IR	28 110			
		04.06-	CA1870IR	28 80			
[D0836LF54]		04.06-	CA1871IR	28 110			
		10.05-	CA1871IR	28 110			
		10.05-	CA1870IR	28 80			
26.290 6.9	(TGM)[D0836LF64]	10.05-	CA1870IR	28 80			
26.292 12.0	(F 90)[D2866LF/290]	09.87- 02.90	CA1035IR	28 80	09.87- 02.90	CS191	24 5.4
		09.87- 02.90	CA222IR	28 35			
		09.87- 02.90	CA333IR	28 55			
26.293 10.0	(F 2000)[D2865LF20]	01.94- 09.01	CA1035IR	28 80	01.94- 09.01	CS191	24 5.4
		01.94- 09.01	CA333IR	28 55			
		01.94- 09.01	CA854IR	28 35			
[D2865LF24]		04.95- 09.01	CA1035IR	28 80	04.95- 09.01	CS191	24 5.4
		04.95- 09.01	CA333IR	28 55			
		04.95- 09.01	CA854IR	28 35			
26.302 12.0	(F 90)[D2866LF04]	05.90- 12.91	CA1035IR	28 80	05.90- 12.91	CS191	24 5.4
		05.90- 12.91	CA222IR	28 35			
		05.90- 12.91	CA333IR	28 55			
26.310 10.5	(TGA)[D2066LF04]	01.04- 09.06	CA1997IR	28 120			
		02.04- 09.06	CA1870IR	28 80			
		02.04- 09.06	CA1871IR	28 110			
[D2066LF14]		02.04-	CA1870IR	28 80			
		02.04-	CA1871IR	28 110			
		02.04-	CA1997IR	28 120			
[D2066LF35]		02.04-	CA1870IR	28 80			
		02.04-	CA1871IR	28 110			
		02.04-	CA1997IR	28 120			
26.310 12.0	(E2000 Evolution)[D2866LF23]	05.00-	CA1663IR	28 90			
(TGA)[D2866LF26]		09.02- 05.04	CA1847IR	28 80	02.00- 05.04	CS191	24 5.4
		03.99- 05.04	CA1663IR	28 90			
		03.99- 05.04	CA1695IR	28 55			
[D2866LF36]		03.99- 09.01	CA1663IR	28 90	02.00- 09.01	CS191	24 5.4
		03.99- 09.01	CA1695IR	28 55			
		05.01-	CA1663IR	28 90			
26.314 12.0	(F 2000)[D2866LF23]	05.01-	CA1663IR	28 90	05.01-	CS191	24 5.4
		05.01-	CA333IR	28 55			
26.320 10.5	(TGA)[D2066LF04]	02.04-	CA1870IR	28 80			
		02.04-	CA1871IR	28 110			
		02.04-	CA1997IR	28 120			
[D2066LF14]		02.04-	CA1870IR	28 80			
		02.04-	CA1871IR	28 110			
		02.04-	CA1997IR	28 120			
[D2066LF35]		02.04-	CA1870IR	28 80			
		02.04-	CA1871IR	28 110			
		02.04-	CA1997IR	28 120			
[D2066LF39]		04.06-	CA1871IR	28 110			
		07.08-	CA1870IR	28 80			
		10.07-	CA1871IR	28 110			
(TGS)[D2066LF28]		07.08-	CA1870IR	28 80			
		10.07-	CA1871IR	28 110			
		07.08-	CA1870IR	28 80			
[D2066LF43]		07.08-	CA1871IR	28 110			
		10.07-	CA1870IR	28 80			
		10.07-	CA1871IR	28 110			
26.322 10.0	(F 90)[D2865LF03]	02.90- 06.96	CA1035IR	28 80	02.90- 06.96	CS198	24 6.0
		02.90- 08.93	CA222IR	28 35			
		09.90- 06.96	CA333IR	28 55			
[D2865LF06]		09.93- 06.96	CA854IR	28 35	09.90- 11.91	CS191	24 5.4
		02.90- 06.96	CA1035IR	28 80			
		02.90- 10.93	CA222IR	28 35			
		02.90- 06.96	CA333IR	28 55			
		09.93- 06.96	CA854IR	28 35			
26.322 10.0 Unterflur	(F 90)[D2865LF03]	09.90- 05.94	CA1035IR	28 80	09.90- 05.94	CS191	24 5.4
		09.90- 10.92	CA222IR	28 35			
		09.90- 05.94	CA333IR	28 55			
[D2865LF06]		09.90- 05.94	CA1035IR	28 80	09.90- 05.94	CS198	24 6.0
		09.90- 01.93	CA222IR	28 35			
		09.90- 05.94	CA333IR	28 55			
		01.93- 05.94	CA854IR	28 35			
26.323 10.0	(F 2000)[D2865LF23]	01.94- 12.95	CA1035IR	28 80	01.94- 12.95	CS191	24 5.4
		01.94- 12.95	CA333IR	28 55			
		01.94- 12.95	CA854IR	28 35			
26.330 6.9	(TGA)[D0836LF44]	03.03- 02.05	CA1870IR	28 80			
		03.03- 02.05	CA1871IR	28 110			



MAN Continued

	(TGM)[D0836LFL52]	04.06-	CA1870IR	28 80			
		04.06-	CA1871IR	28 110			
	[D0836LFL55]	10.05-	CA1870IR	28 80			
		10.05-	CA1871IR	28 110			
26.332 12.0	(F 90)[D2866LF/330]	09.87- 02.90	CA1035IR	28 80	09.87- 02.90	CS191	24 5.4
		09.87- 02.90	CA222IR	28 35			
		09.87- 02.90	CA333IR	28 55			
26.340 6.9	(TGM)[D0836LFL65]	10.05-	CA1870IR	28 80			
		10.05-	CA1871IR	28 110			
26.342 10.0	(F 90)[D2865LF09]	05.94- 06.96	CA1035IR	28 80	04.94- 06.96	CS198	24 6.0
		05.94- 06.96	CA333IR	28 55			
		05.94- 06.96	CA854IR	28 35			
26.343 10.0	(F 2000)[D2865LF21]	01.94- 09.01	CA1035IR	28 80	01.94- 09.01	CS191	24 5.4
		01.94- 09.01	CA333IR	28 55			
		01.94- 09.01	CA854IR	28 35			
26.350 10.5	(TGA)[D2066LF03]	01.04- 09.06	CA1997IR	28 120			
		02.04- 09.06	CA1870IR	28 80			
		02.04- 09.06	CA1871IR	28 110			
	[D2066LF13]	01.04- 09.06	CA1997IR	28 120			
		02.04- 09.06	CA1870IR	28 80			
		02.04- 09.06	CA1871IR	28 110			
	[D2066LF33]	02.04-	CA1870IR	28 80			
		02.04-	CA1871IR	28 110			
		02.04-	CA1997IR	28 120			
26.360 10.5	(TGA)[D2066LF03]	02.04- 09.06	CA1870IR	28 80			
		02.04- 09.06	CA1871IR	28 110			
		02.04- 09.06	CA1997IR	28 120			
	[D2066LF07]	05.04-	CA1870IR	28 80			
	[D2066LF13]	02.04-	CA1870IR	28 80			
		02.04-	CA1871IR	28 110			
		02.04-	CA1997IR	28 120			
	[D2066LF33]	02.04- 07.06	CA1870IR	28 80			
		02.04- 07.06	CA1871IR	28 110			
		02.04-	CA1997IR	28 120			
	[D2066LF38]	05.04-	CA1870IR	28 80			
		05.04-	CA1871IR	28 110			
	(TGS)[D2066LF27]	08.08-	CA1871IR	28 110			
	[D2066LF38]	10.07-	CA1871IR	28 110			
		05.08-	CA1870IR	28 80			
	[D2066LF42]	04.08-	CA1871IR	28 110			
		07.08-	CA1870IR	28 80			
	(TGX)[D2066LF27]	10.07-	CA1870IR	28 80			
		10.07-	CA1871IR	28 110			
	[D2066LF38]	10.07-	CA1870IR	28 80			
		10.07-	CA1871IR	28 110			
	[D2066LF42]	07.08-	CA1870IR	28 80			
		07.08-	CA1871IR	28 110			
26.360 12.0	(E2000 Evolution)[D2866LF24]	05.00-	CA1663IR	28 90			
	(TGA)[D2866LF27]	03.99- 12.05	CA1663IR	28 90	02.00- 12.05	CS191	24 5.4
		03.99- 12.05	CA1695IR	28 55			
	[D2866LF37]	03.99- 09.01	CA1663IR	28 90	02.00- 09.01	CS191	24 5.4
		03.99- 09.01	CA1695IR	28 55			
26.362 12.0	(F 90)[D2866KF]	09.87- 02.90	CA1035IR	28 80	09.87- 02.90	CS191	24 5.4
		09.87- 02.90	CA222IR	28 35			
		09.87- 02.90	CA333IR	28 55			
	[D2866LXF]	09.87- 02.90	CA1035IR	28 80	09.87- 02.90	CS191	24 5.4
		09.87- 02.90	CA222IR	28 35			
		09.87- 02.90	CA333IR	28 55			
26.364 12.0	(F 2000)[D2866LF24]	05.01-	CA1663IR	28 90	05.01-	CS191	24 5.4
26.372 12.0	(F 90)[D2866LF03]	02.90- 06.96	CA1035IR	28 80	01.90- 06.96	CS191	24 5.4
		02.90- 05.94	CA222IR	28 35			
		02.90- 12.95	CA333IR	28 55			
		09.93- 06.96	CA854IR	28 35			
	[D2866LF05]	02.90- 06.96	CA1035IR	28 80	02.90- 06.96	CS191	24 5.4
		02.90- 12.95	CA222IR	28 35			
		02.90- 12.95	CA333IR	28 55			
		09.93- 06.96	CA854IR	28 35			
	[D2866LF15]	02.90- 06.96	CA1035IR	28 80	09.90- 06.96	CS191	24 5.4
		02.90- 12.95	CA222IR	28 35			
		02.90- 12.95	CA333IR	28 55			
		09.93- 06.96	CA854IR	28 35			
26.372 12.0 Unterflur	(F 90)[D2866LF03]	09.90- 05.94	CA1035IR	28 80	09.90- 05.94	CS191	24 5.4
		09.90- 10.92	CA222IR	28 35			
		09.90- 05.94	CA333IR	28 55			
	[D2866LF05]	09.90- 05.94	CA1035IR	28 80	09.90- 11.92	CS191	24 5.4
		09.90- 05.94	CA222IR	28 35			
		09.90- 05.94	CA333IR	28 55			
26.373 12.0	(F 2000)[D2866LF21]	01.94- 12.95	CA1035IR	28 80	01.94- 12.95	CS191	24 5.4
		01.94- 12.95	CA333IR	28 55			
		01.94- 12.95	CA854IR	28 35			
26.390 10.5	(TGA)[D2066LF02]	01.04-	CA1997IR	28 120			
		02.04- 09.06	CA1870IR	28 80			
		02.04- 09.06	CA1871IR	28 110			
	[D2066LF12]	01.04-	CA1997IR	28 120			
		02.04- 09.06	CA1870IR	28 80			
		02.04- 09.06	CA1871IR	28 110			
	[D2066LF24]	05.04-	CA1870IR	28 80			
		05.04-	CA1871IR	28 110			
		05.04-	CA1997IR	28 120			
	[D2066LF32]	02.04-	CA1870IR	28 80			
		02.04-	CA1871IR	28 110			
		02.04-	CA1997IR	28 120			
26.390 12.0	(TGA)[D2866LF27]	09.03-	CA1663IR	28 90	09.03-	CS191	24 5.4
		09.03-	CA1695IR	28 55			
26.400 10.5	(TGA)[D2066LF02]	02.04-	CA1870IR	28 80			
		02.04-	CA1871IR	28 110			
		02.04-	CA1997IR	28 120			
	[D2066LF12]	02.04-	CA1870IR	28 80			
		02.04-	CA1871IR	28 110			
		02.04-	CA1997IR	28 120			
	[D2066LF24]	05.04-	CA1870IR	28 80			
		05.04-	CA1871IR	28 110			
		05.04-	CA1997IR	28 120			
	[D2066LF32]	02.04-	CA1870IR	28 80			
		02.04-	CA1871IR	28 110			
		02.04-	CA1997IR	28 120			
	[D2066LF37]	01.04-	CA1870IR	28 80			
		01.04-	CA1871IR	28 110			
	(TGS)[D2066LF26]	02.09-	CA1871IR	28 110			





	[D2066LF37]	10.07-02.09	CA1871IR	28 110			
			CA1870IR	28 80			
	[D2066LF41]	07.08-02.09	CA1871IR	28 110			
			CA1870IR	28 80			
	(TGX)[D2066LF26]	10.07-10.07	CA1870IR	28 80			
			CA1871IR	28 110			
	[D2066LF37]	10.07-10.07-10.07	CA1870IR	28 80			
			CA1871IR	28 110			
			CA1997IR	28 120			
	[D2066LF41]	07.08-	CA1870IR	28 80			
26.402 12.0	(F 90)[D2866LF16]	05.94-06.96	CA1035IR	28 80	05.94-06.96	CS191	24 5.4
		05.94-12.95	CA222IR	28 35			
		05.94-12.95	CA333IR	28 55			
		05.94-06.96	CA854IR	28 35			
26.403 12.0	(F 2000)[D2866LF20]	01.94-09.01	CA1035IR	28 80	01.94-09.01	CS191	24 5.4
		01.94-09.01	CA1663IR	28 90			
		01.94-09.01	CA1695IR	28 55			
		01.94-09.01	CA333IR	28 55			
		01.94-09.01	CA854IR	28 35			
26.410 12.0	(E2000 Evolution)[D2866LF25]	05.00-	CA1663IR	28 90			
	(TGA)[D2866LF28]	03.99-12.05	CA1663IR	28 90	02.00-12.05	CS191	24 5.4
		03.99-12.05	CA1695IR	28 55			
	[D2866LF32]	03.99-09.01	CA1663IR	28 90	02.00-09.01	CS191	24 5.4
		03.99-09.01	CA1695IR	28 55			
26.414 12.0	(F 2000)[D2866LF25]	05.01-	CA1663IR	28 90			
26.422 12.0	(F 90)[D2866LF06]	02.90-12.95	CA1035IR	28 80	02.90-12.92	CS191	24 5.4
		02.90-08.93	CA222IR	28 35			
		02.90-12.95	CA333IR	28 55			
		09.93-06.96	CA854IR	28 35			
	[D2866LF09]	02.90-06.96	CA1035IR	28 80	02.90-06.96	CS191	24 5.4
		02.90-12.95	CA222IR	28 35			
		02.90-12.95	CA333IR	28 55			
		09.93-06.96	CA854IR	28 35			
26.422 12.0 Unterflur	(F 90)[D2866LF06]	09.90-05.94	CA1035IR	28 80	09.90-11.90	CS191	24 5.4
		09.90-05.94	CA222IR	28 35			
		09.90-05.94	CA333IR	28 55			
	[D2866LF09]	09.90-05.94	CA1035IR	28 80	09.90-11.92	CS191	24 5.4
		09.90-05.94	CA222IR	28 35			
		09.90-05.94	CA333IR	28 55			
26.423 12.0	(F 2000)[D2866LF22]	01.94-12.95	CA1035IR	28 80	01.94-12.95	CS191	24 5.4
		01.94-12.95	CA1663IR	28 90			
		01.94-12.95	CA1695IR	28 55			
		01.94-12.95	CA333IR	28 55			
		01.94-12.95	CA854IR	28 35			
26.430 10.5	(TGA)[D2066LF01]	12.00-09.06	CA1997IR	28 120			
		02.04-09.06	CA1870IR	28 80			
		02.04-09.06	CA1871IR	28 110			
	[D2066LF11]	12.00-	CA1997IR	28 120			
		02.04-09.06	CA1870IR	28 80			
		02.04-09.06	CA1871IR	28 110			
	[D2066LF23]	05.04-	CA1870IR	28 80			
		05.04-	CA1871IR	28 110			
		05.04-	CA1997IR	28 120			
	[D2066LF31]	02.04-	CA1870IR	28 80			
		02.04-	CA1871IR	28 110			
		02.04-	CA1997IR	28 120			
26.440 10.5	(TGA)[D2066LF01]	02.04-	CA1870IR	28 80			
		02.04-	CA1871IR	28 110			
		02.04-	CA1997IR	28 120			
	[D2066LF11]	02.04-	CA1870IR	28 80			
		02.04-	CA1871IR	28 110			
		02.04-	CA1997IR	28 120			
	[D2066LF23]	05.04-	CA1870IR	28 80			
		05.04-	CA1871IR	28 110			
		05.04-	CA1997IR	28 120			
	[D2066LF31]	02.04-03.09	CA1870IR	28 80			
		02.04-03.09	CA1871IR	28 110			
		02.04-03.09	CA1997IR	28 120			
	[D2066LF36]	01.04-	CA1870IR	28 80			
		01.04-	CA1871IR	28 110			
	(TGS)[D2066LF25]	02.09-	CA1871IR	28 110			
	[D2066LF36]	10.07-	CA1871IR	28 110			
		05.08-	CA1870IR	28 80			
	[D2066LF40]	07.08-	CA1870IR	28 80			
		02.09-	CA1871IR	28 110			
	(TGX)[D2066LF25]	10.07-	CA1870IR	28 80			
		10.07-	CA1871IR	28 110			
	[D2066LF36]	09.07-	CA1870IR	28 80			
		10.07-	CA1871IR	28 110			
	[D2066LF40]	07.08-	CA1870IR	28 80			
26.440 12.4	(TGX)[D2676LF22]	07.08-	CA1997IR	28 120			
26.460 12.8	(E2000 Evolution)[D2876LF03]	05.00-	CA1035IR	28 80	05.00-	CS191	24 5.4
		05.00-	CA1663IR	28 90			
		05.00-	CA1695IR	28 55			
		05.00-	CA333IR	28 55			
		05.00-	CA854IR	28 35			
	(TGA)[D2876LF04]	03.99-06.05	CA1663IR	28 90	02.00-06.05	CS191	24 5.4
		03.99-06.05	CA1695IR	28 55			
	[D2876LF07]	03.99-09.01	CA1663IR	28 90	02.00-09.01	CS191	24 5.4
		03.99-09.01	CA1695IR	28 55			
26.462 18.3	(F 90)[D2840LF/460]	02.89-02.90	CA1035IR	28 80	02.89-02.90	CS198	24 6.0
		02.89-02.90	CA222IR	28 35			
		02.89-02.90	CA333IR	28 55			
26.463 12.8	(F 2000)[D2876LF02]	01.94-09.01	CA1035IR	28 80	01.94-09.01	CS191	24 5.4
		01.94-09.01	CA1663IR	28 90			
		01.94-09.01	CA1695IR	28 55			
		01.94-09.01	CA333IR	28 55			
26.464 12.8	(F 2000)[D2876LF03]	05.01-	CA1663IR	28 90	05.01-	CS191	24 5.4
26.480 12.4	(TGA)[D2676LF01]	02.06-	CA1870IR	28 80	02.06-	CS191	24 5.4
		02.06-	CA1871IR	28 110			
	[D2676LF05]	01.06-	CA1871IR	28 110			
	[D2676LF12]	02.06-	CA1870IR	28 80			
		02.06-	CA1871IR	28 110			
	(TGS)[D2676LF05]	10.07-	CA1997IR	28 120			
	[D2676LF07]	02.09-	CA1997IR	28 120			
	[D2676LF14]	02.09-	CA1997IR	28 120			
	(TGX)[D2676LF05]	09.07-	CA1997IR	28 120			
		10.07-	CA1870IR	28 80			
		10.07-	CA1871IR	28 110			



MAN Continued

	[D2676LF07]	07.08-	CA1997IR	28 120			
	[D2676LF14]	10.07-	CA1870IR	28 80			
		10.07-	CA1871IR	28 110			
26.480 12.8	(TGA)[D2876LF12]	09.02- 09.06	CA1847IR	28 80	09.02- 09.06	CS191	24 5.4
26.502 18.3	(F 90)[D2840LF01]	02.90- 06.96	CA1035IR	28 80	02.90- 06.96	CS198	24 6.0
		02.90- 06.96	CA222IR	28 35			
		02.90- 06.96	CA333IR	28 55			
		02.90- 06.96	CA854IR	28 35			
	[D2840LF04]	02.90- 06.96	CA1035IR	28 80	02.90- 06.96	CS198	24 6.0
		02.90- 06.96	CA222IR	28 35			
		02.90- 06.96	CA333IR	28 55			
		02.90- 06.96	CA854IR	28 35			
	[D2840LF06]	02.90- 06.96	CA1035IR	28 80	02.90- 06.96	CS198	24 6.0
		02.90- 06.96	CA222IR	28 35			
		02.90- 06.96	CA333IR	28 55			
		02.90- 06.96	CA854IR	28 35			
26.510 12.8	(TGA)[D2876LF05]	03.99- 06.03	CA1663IR	28 90	02.00- 06.03	CS191	24 5.4
		03.99- 06.03	CA1695IR	28 55			
26.530 12.8	(TGA)[D2876LF13]	09.02-	CA1847IR	28 80	09.02-	CS191	24 5.4
26.540 12.4	(TGA)[D2676LF13]	08.06-	CA1871IR	28 110			
	(TGS)[D2676LF06]	02.09-	CA1997IR	28 120			
	[D2676LF13]	02.09-	CA1997IR	28 120			
	(TX)[D2676LF06]	02.09-	CA1997IR	28 120			
	[D2676LF13]	10.07-	CA1870IR	28 80			
		10.07-	CA1871IR	28 110			
		10.07-	CA1997IR	28 120			
26.603 18.3	(F 2000)[D2840LF20]				06.96-	CS198	24 6.0
27.273 10.0	(F 2000)[D2865LF22]	01.94- 12.95	CA1035IR	28 80	01.94- 12.95	CS191	24 5.4
		01.94- 12.95	CA333IR	28 55			
		01.94- 12.95	CA854IR	28 35			
27.293 10.0	(F 2000)[D2865LF20]	01.94- 09.01	CA1035IR	28 80	01.94- 09.01	CS198	24 6.0
		01.94- 09.01	CA333IR	28 55	01.94- 09.01	CS191	24 5.4
		01.94- 09.01	CA854IR	28 35			
	[D2865LF24]	04.95- 09.01	CA1035IR	28 80	04.95- 09.01	CS191	24 5.4
		04.95- 09.01	CA333IR	28 55			
		04.95- 09.01	CA854IR	28 35			
27.314 12.0	(F 2000)[D2866LF23]	06.98-	CA1663IR	28 90	06.98-	CS191	24 5.4
		05.01-	CA333IR	28 55	05.01-	CS191	24 5.4
27.323 10.0	(F 2000)[D2865LF23]	01.94- 12.95	CA1035IR	28 80	01.94- 12.95	CS191	24 5.4
		01.94- 12.95	CA333IR	28 55			
		01.94- 12.95	CA854IR	28 35			
27.343 10.0	(F 2000)[D2865LF21]	01.94- 09.01	CA1035IR	28 80	01.94- 09.01	CS198	24 6.0
		01.94- 09.01	CA333IR	28 55	01.94- 09.01	CS191	24 5.4
		01.94- 09.01	CA854IR	28 35			
27.364 12.0	(F 2000)[D2866LF24]	06.98-	CA1663IR	28 90	06.98-	CS191	24 5.4
		05.01-	CA333IR	28 55	05.01-	CS191	24 5.4
27.373 12.0	(F 2000)[D2866LF21]	01.94- 12.95	CA1035IR	28 80	01.94- 12.95	CS191	24 5.4
		01.94- 12.95	CA1663IR	28 90			
		01.94- 12.95	CA1695IR	28 55			
		01.94- 12.95	CA333IR	28 55			
		01.94- 12.95	CA854IR	28 35			
27.403 12.0	(F 2000)[D2866LF20]	01.94- 09.01	CA1035IR	28 80	01.94- 09.01	CS198	24 6.0
		01.94- 09.01	CA1663IR	28 90	01.94- 09.01	CS191	24 5.4
		01.94- 09.01	CA1695IR	28 55			
		01.94- 09.01	CA333IR	28 55			
		01.94- 09.01	CA854IR	28 35			
27.414 12.0	(F 2000)[D2866LF25]	06.98-	CA1663IR	28 90	06.98-	CS191	24 5.4
		05.01-	CA333IR	28 55	05.01-	CS191	24 5.4
27.423 12.0	(F 2000)[D2866LF22]	01.94- 12.95	CA1035IR	28 80	01.94- 12.95	CS191	24 5.4
		01.94- 12.95	CA1663IR	28 90			
		01.94- 12.95	CA1695IR	28 55			
		01.94- 12.95	CA333IR	28 55			
		01.94- 12.95	CA854IR	28 35			
27.463 12.8	(F 2000)[D2876LF02]	01.94- 09.01	CA1035IR	28 80	01.94- 09.01	CS198	24 6.0
		01.94- 09.01	CA1663IR	28 90	01.94- 09.01	CS191	24 5.4
		01.94- 09.01	CA1695IR	28 55			
		01.94- 09.01	CA333IR	28 55			
		01.94- 09.01	CA854IR	28 35			
		07.00-	CA333IR	28 55			
27.464 12.8	(F 2000)[D2876LF03]	06.98-	CA1663IR	28 90	05.01-	CS191	24 5.4
	[D2876LF06]	01.94-	CA333IR	28 55	05.01-	CS191	24 5.4
		05.01-	CA333IR	28 55			
27.603 18.3	(F 2000)[D2840LF20]				01.96- 09.01	CS198	24 6.0
28.310 10.5	(TGA)[D2066LF04]	09.02-	CA1997IR	28 120			
		07.06-	CA1870IR	28 80			
		07.06-	CA1871IR	28 110			
	[D2066LF14]	06.04-	CA1997IR	28 120			
		07.06-	CA1870IR	28 80			
		07.06-	CA1871IR	28 110			
		07.06-	CA1871IR	28 110			
	[D2066LF28]	07.06-	CA1870IR	28 80			
		07.06-	CA1871IR	28 110			
		07.06-	CA1997IR	28 120			
	[D2066LF39]	07.06-	CA1870IR	28 80			
		07.06-	CA1871IR	28 110			
		07.06-	CA1871IR	28 110			
		07.06-	CA1997IR	28 120			
28.310 12.0	(E2000 Evolution)[D2866LF23]	05.00-	CA1663IR	28 90			
	(TGA)[D2866LF26]	09.02-	CA1663IR	28 90	09.02-	CS191	24 5.4
		09.02-	CA1695IR	28 55			
		09.02-	CA1847IR	28 80			
28.320 10.5	(TGA)[D2066LF04]	07.06-	CA1870IR	28 80			
		07.06-	CA1871IR	28 110			
		07.06-	CA1997IR	28 120			
	[D2066LF14]	07.06-	CA1870IR	28 80			
		07.06-	CA1871IR	28 110			
		07.06-	CA1997IR	28 120			
	[D2066LF28]	06.04-	CA1870IR	28 80			
		07.06-	CA1871IR	28 110			
		07.06-	CA1997IR	28 120			
	[D2066LF39]	06.04-	CA1870IR	28 80			
		06.04-	CA1871IR	28 110			
		07.06-	CA1997IR	28 120			
	(TGS)[D2066LF39]	07.08-	CA1871IR	28 110			
	[D2066LF43]	07.08-	CA1871IR	28 110			
28.350 10.5	(TGA)[D2066LF03]	02.04-	CA1997IR	28 120			
		06.04-	CA1870IR	28 80			
		06.04-	CA1871IR	28 110			
	[D2066LF13]	06.04-	CA1870IR	28 80			
		06.04-	CA1871IR	28 110			
		07.06-	CA1997IR	28 120			



	[D2066LF27]	06.04-	CA1870IR	28 80			
		06.04-	CA1871IR	28 110			
	[D2066LF38]	06.04-	CA1870IR	28 80			
		06.04-	CA1871IR	28 110			
28.360 10.5	(TGA)[D2066LF03]	06.04-	CA1870IR	28 80			
		06.04-	CA1871IR	28 110			
	[D2066LF13]	06.04-	CA1870IR	28 80			
		06.04-	CA1871IR	28 110			
	[D2066LF27]	06.04-	CA1870IR	28 80			
		06.04-	CA1871IR	28 110			
	[D2066LF38]	06.04-	CA1870IR	28 80			
		06.04-	CA1871IR	28 110			
	(TGS)[D2066LF38]	08.08-	CA1871IR	28 110			
	[D2066LF42]	08.08-	CA1871IR	28 110			
	(TGX)[D2066LF27]	10.07-	CA1870IR	28 80			
		10.07-	CA1871IR	28 110			
	[D2066LF38]	10.07-	CA1870IR	28 80			
		10.07-	CA1871IR	28 110			
28.360 12.0	(E2000 Evolution)[D2866LF24]	05.00-	CA1663IR	28 90	05.00-	CS191	24 5.4
	(TGA)[D2866LF27]	09.02-	CA1663IR	28 90	09.02-	CS191	24 5.4
		09.02-	CA1695IR	28 55			
		09.02-	CA1847IR	28 80			
		07.06-	CA1870IR	28 80			
		07.06-	CA1871IR	28 110			
28.390 10.5	(TGA)[D2066LF02]	05.04-	CA1997IR	28 120			
		06.04-	CA1870IR	28 80			
		06.04-	CA1871IR	28 110			
	[D2066LF12]	05.04-	CA1997IR	28 120			
		06.04-	CA1870IR	28 80			
		06.04-	CA1871IR	28 110			
	[D2066LF26]	06.04-	CA1870IR	28 80			
		06.04-	CA1871IR	28 110			
	[D2066LF37]	06.04-	CA1870IR	28 80			
		06.04-	CA1871IR	28 110			
		06.04-	CA1997IR	28 120			
28.390 12.8	(TGA)[D2876LF12]	07.06-	CA1847IR	28 80	07.06-	CS191	24 5.4
28.400 10.5	(TGA)[D2066LF02]	06.04-	CA1870IR	28 80			
		06.04-	CA1871IR	28 110			
	[D2066LF12]	06.04-	CA1870IR	28 80			
		06.04-	CA1871IR	28 110			
	[D2066LF26]	06.04-	CA1870IR	28 80			
		06.04-	CA1871IR	28 110			
	[D2066LF37]	06.04-	CA1870IR	28 80			
		06.04-	CA1871IR	28 110			
		06.04-	CA1997IR	28 120			
	(TGS)[D2066LF37]	08.08-	CA1870IR	28 80			
		08.08-	CA1871IR	28 110			
	[D2066LF41]	08.08-	CA1870IR	28 80			
		08.08-	CA1871IR	28 110			
	(TGX)[D2066LF26]	10.07-	CA1870IR	28 80			
		10.07-	CA1871IR	28 110			
	[D2066LF37]	10.07-	CA1870IR	28 80			
		10.07-	CA1871IR	28 110			
		10.07-	CA1997IR	28 120			
28.410 12.0	(E2000 Evolution)[D2866LF25]	05.00-	CA1663IR	28 90			
	(TGA)[D2866LF28]	09.02-	CA1663IR	28 90	09.02-	CS191	24 5.4
		09.02-	CA1695IR	28 55			
		09.02-	CA1847IR	28 80			
28.430 10.5	(TGA)[D2066LF01]	05.04-	CA1997IR	28 120			
		06.04-	CA1870IR	28 80			
		06.04-	CA1871IR	28 110			
	[D2066LF11]	05.04-	CA1997IR	28 120			
		06.04-	CA1870IR	28 80			
		06.04-	CA1871IR	28 110			
	[D2066LF25]	06.04-	CA1870IR	28 80			
		06.04-	CA1871IR	28 110			
	[D2066LF36]	06.04-	CA1870IR	28 80			
		06.04-	CA1871IR	28 110			
28.440 10.5	(TGA)[D2066LF01]	06.04-	CA1870IR	28 80			
		06.04-	CA1871IR	28 110			
	[D2066LF11]	06.04-	CA1870IR	28 80			
		06.04-	CA1871IR	28 110			
	[D2066LF25]	06.04-	CA1870IR	28 80			
		06.04-	CA1871IR	28 110			
	[D2066LF36]	06.04-	CA1870IR	28 80			
		06.04-	CA1871IR	28 110			
	(TGS)[D2066LF36]	08.08-	CA1870IR	28 80			
		08.08-	CA1871IR	28 110			
	[D2066LF40]	08.08-	CA1870IR	28 80			
		08.08-	CA1871IR	28 110			
	(TGX)[D2066LF25]	10.07-	CA1870IR	28 80			
		10.07-	CA1871IR	28 110			
	[D2066LF36]	10.07-	CA1870IR	28 80			
		10.07-	CA1871IR	28 110			
28.460 12.8	(E2000 Evolution)[D2876LF03]	05.00-	CA1035IR	28 80	05.00-	CS191	24 5.4
		05.00-	CA1663IR	28 90			
		05.00-	CA1695IR	28 55			
		05.00-	CA333IR	28 55			
		05.00-	CA854IR	28 35			
	(TGA)[D2876LF04]	09.02-	CA1663IR	28 90	09.02-	CS191	24 5.4
		09.02-	CA1695IR	28 55			
		09.02-	CA1847IR	28 80			
28.480 12.4	(TGA)[D2676LF02]	02.06-	CA1871IR	28 110			
	[D2676LF05]	02.06-	CA1871IR	28 110			
		07.06-	CA1870IR	28 80			
	[D2676LF14]	02.06-	CA1871IR	28 110			
	(TGS)[D2676LF05]	08.08-	CA1997IR	28 120			
	[D2676LF07]	08.08-	CA1997IR	28 120			
	(TGX)[D2676LF05]	10.07-	CA1870IR	28 80			
		10.07-	CA1871IR	28 110			
	[D2676LF14]	10.07-	CA1870IR	28 80			
		10.07-	CA1871IR	28 110			
28.480 12.8	(TGA)[D2876LF12]	09.02-	CA1847IR	28 80	09.02-	CS191	24 5.4
28.510 12.8	(TGA)[D2876LF05]	09.02-	CA1663IR	28 90	09.02-	CS191	24 5.4
		09.02-	CA1695IR	28 55			
		09.02-	CA1847IR	28 80			
28.530 12.8	(TGA)[D2876LF13]	09.02-	CA1847IR	28 80	09.02-	CS191	24 5.4



MAN Continued

28.540 12.4	(TGA)[D2676LF13]	08.06-	CA1870IR	28 80				
		08.06-	CA1871IR	28 110				
		06.08-	CA1997IR	28 120				
		02.09-	CA1997IR	28 120				
		10.07-	CA1870IR	28 80				
		10.07-	CA1871IR	28 110				
29.460 12.8	(E2000 Evolution)[D2876LF03]	05.00-	CA1035IR	28 80	05.00-	CS191	24 5.4	
		05.00-	CA1663IR	28 90				
		05.00-	CA1695IR	28 55				
		05.00-	CA333IR	28 55				
		05.00-	CA854IR	28 35				
30.310 12.0	(E2000 Evolution)[D2866LF23]	05.00-	CA1035IR	28 80	05.00-	CS191	24 5.4	
		05.00-	CA1663IR	28 90				
		05.00-	CA1695IR	28 55				
		05.00-	CA333IR	28 55				
		05.00-	CA854IR	28 35				
30.360 12.0	(E2000 Evolution)[D2866LF24]	05.00-	CA1663IR	28 90				
30.410 12.0	(E2000 Evolution)[D2866LF25]	05.00-	CA1663IR	28 90				
30.460 12.8	(E2000 Evolution)[D2876LF03]	05.00-	CA1035IR	28 80	05.00-	CS191	24 5.4	
		05.00-	CA1663IR	28 90				
		05.00-	CA1695IR	28 55				
		05.00-	CA333IR	28 55				
		05.00-	CA854IR	28 35				
32.262 10.0	(F 90)[D2865LF260]	02.89- 02.90	CA1035IR	28 80	02.89- 02.90	CS191	24 5.4	
		02.89- 02.90	CA222IR	28 35				
		02.89- 02.90	CA333IR	28 55				
32.272 10.0	(F 90)[D2865LF02]	02.90- 04.95	CA1035IR	28 80	02.90- 04.95	CS191	24 5.4	
		02.90- 10.93	CA222IR	28 35				
		02.90- 04.95	CA333IR	28 55				
			11.93- 04.95	CA854IR	28 35	02.90- 04.95	CS198	24 6.0
	[D2865LF05]	02.90- 04.95	CA1035IR	28 80				
		02.90- 10.93	CA222IR	28 35				
02.90- 04.95		CA333IR	28 55					
32.292 12.0	(F 90)[D2866LF290]	03.88- 02.90	CA1035IR	28 80	03.88- 02.90	CS191	24 5.4	
		03.88- 02.90	CA222IR	28 35				
		03.88- 02.90	CA333IR	28 55				
32.293 10.0	(F 2000)[D2865LF24]	08.95- 09.01	CA1035IR	28 80	08.95- 09.01	CS191	24 5.4	
		08.95- 09.01	CA333IR	28 55				
		08.95- 09.01	CA854IR	28 35				
32.302 12.0	(F 90)[D2866LF04]	05.90- 09.91	CA1035IR	28 80	05.90- 09.91	CS191	24 5.4	
		05.90- 09.91	CA222IR	28 35				
		05.90- 09.91	CA333IR	28 55				
32.310 12.0	(E2000 Evolution)[D2866LF23]	05.00-	CA1035IR	28 80	05.00-	CS191	24 5.4	
		05.00-	CA1663IR	28 90				
		05.00-	CA1695IR	28 55				
		05.00-	CA333IR	28 55				
		05.00-	CA854IR	28 35				
		(TGA)[D2866LF26]	01.02-	CA1663IR	28 90	01.02-	CS191	24 5.4
		01.02-	CA1695IR	28 55				
32.314 12.0	(F 2000)[D2866LF23]	05.01-	CA1663IR	28 90				
32.320 10.5	(TGS)[D2066LF43]	02.09-	CA1870IR	28 80				
32.322 10.0	(F 90)[D2865LF03]	02.90- 05.94	CA1035IR	28 80	02.90- 05.94	CS198	24 6.0	
		02.90- 08.93	CA222IR	28 35				
		07.93- 05.94	CA333IR	28 55				
		09.93- 05.94	CA854IR	28 35				
		02.90- 05.94	CA1035IR	28 80				
		02.90- 08.93	CA222IR	28 35				
		07.93- 05.94	CA333IR	28 55				
		09.93- 05.94	CA854IR	28 35				
32.332 12.0	(F 90)[D2866LF330]	03.88- 02.90	CA1035IR	28 80	03.88- 02.90	CS191	24 5.4	
		03.88- 02.90	CA222IR	28 35				
		03.88- 02.90	CA333IR	28 55				
32.342 10.0	(F 90)[D2865LF09]	05.94- 06.96	CA1035IR	28 80	05.94- 06.96	CS198	24 6.0	
		05.94- 06.96	CA333IR	28 55				
		05.94- 06.96	CA854IR	28 35				
32.343 10.0	(F 2000)[D2865LF21]	08.95- 09.01	CA1035IR	28 80	08.95- 09.01	CS191	24 5.4	
		08.95- 09.01	CA333IR	28 55				
		08.95- 09.01	CA854IR	28 35				
32.350 10.5	(TGA)[D2066LF03]	02.04-	CA1870IR	28 80				
		02.04-	CA1871IR	28 110				
		02.04-	CA1997IR	28 120				
	[D2066LF13]	02.04-	CA1870IR	28 80				
		02.04-	CA1871IR	28 110				
		02.04-	CA1997IR	28 120				
	[D2066LF33]	02.04-	CA1870IR	28 80				
		02.04-	CA1871IR	28 110				
		02.04-	CA1997IR	28 120				
32.360 10.5	(TGA)[D2066LF03]	02.04-	CA1870IR	28 80				
		02.04-	CA1871IR	28 110				
		02.04-	CA1997IR	28 120				
	[D2066LF13]	02.04-	CA1870IR	28 80				
		02.04-	CA1871IR	28 110				
		02.04-	CA1997IR	28 120				
	[D2066LF33]	02.04-	CA1870IR	28 80				
		02.04-	CA1871IR	28 110				
		02.04-	CA1997IR	28 120				
	(TGS)[D2066LF27]	10.07-	CA1870IR	28 80				
		[D2066LF38]	10.07-	CA1870IR				28 80
			08.08-	CA1871IR				28 110
			10.07-	CA1870IR				28 80
		[D2066LF42]	10.07-	CA1870IR				28 80
			(TGX)[D2066LF27]	10.07-				CA1870IR
		[D2066LF38]	10.07-	CA1871IR				28 110
	10.07-		CA1870IR	28 80				
32.360 12.0	(E2000 Evolution)[D2866LF24]	05.00-	CA1663IR	28 90	05.00-	CS191	24 5.4	
(TGA)[D2866LF27]	09.02-	CA1663IR	28 90	09.02-	CS191	24 5.4		
	09.02-	CA1695IR	28 55					
32.362 12.0	(F 90)[D2866LXF]	03.88- 02.90	CA1035IR	28 80	03.88- 02.90	CS191	24 5.4	
		03.88- 02.90	CA222IR	28 35				
		03.88- 02.90	CA333IR	28 55				



32.364 12.0	(F 2000)[D2866LF24]	05.01-	CA1663IR	28 90			
32.372 12.0	(F 90)[D2866LF03]	02.90- 06.96	CA1035IR	28 80	02.90- 05.94	CS191	24 5.4
		02.90- 08.93	CA222IR	28 35			
		02.90- 04.92	CA333IR	28 55			
		09.93- 06.96	CA854IR	28 35			
	[D2866LF05]	02.90- 06.96	CA1035IR	28 80	10.92- 05.94	CS191	24 5.4
		02.90- 08.93	CA222IR	28 35			
		02.90- 04.92	CA333IR	28 55			
		09.93- 06.96	CA854IR	28 35			
	[D2866LF15]	02.90- 06.96	CA1035IR	28 80	05.94- 06.96	CS191	24 5.4
		02.90- 08.93	CA222IR	28 35			
		02.90- 04.92	CA333IR	28 55			
		09.93- 06.96	CA854IR	28 35			
	[D2866LXF/Silent]	05.90- 04.95	CA222IR	28 35	02.90- 06.96	CS191	24 5.4
		05.90- 04.95	CA333IR	28 55			
32.390 10.5	(TGA)[D2066LF02]	05.04-	CA1870IR	28 80			
		05.04-	CA1871IR	28 110			
		05.04-	CA1997IR	28 120			
	[D2066LF12]	05.04-	CA1870IR	28 80			
		05.04-	CA1871IR	28 110			
		05.04-	CA1997IR	28 120			
	[D2066LF32]	05.04-	CA1870IR	28 80			
		05.04-	CA1871IR	28 110			
		05.04-	CA1997IR	28 120			
32.400 10.5	(TGA)[D2066LF02]	05.04-	CA1870IR	28 80			
		05.04-	CA1871IR	28 110			
		05.04-	CA1997IR	28 120			
	[D2066LF12]	05.04-	CA1870IR	28 80			
		05.04-	CA1871IR	28 110			
		05.04-	CA1997IR	28 120			
	[D2066LF32]	05.04-	CA1870IR	28 80			
		05.04-	CA1871IR	28 110			
		05.04-	CA1997IR	28 120			
	(TGS)[D2066LF26]	10.07-	CA1871IR	28 110			
	[D2066LF37]	10.07-	CA1871IR	28 110			
	[D2066LF41]	10.07-	CA1871IR	28 110			
32.402 12.0	(F 90)[D2866LF16]	05.94- 06.96	CA1035IR	28 80	05.94- 06.96	CS191	24 5.4
		05.94- 06.96	CA854IR	28 35			
32.403 12.0	(F 2000)[D2866LF20]	08.95- 09.01	CA1035IR	28 80	08.95- 09.01	CS191	24 5.4
		08.95- 09.01	CA1663IR	28 90			
		08.95- 09.01	CA1695IR	28 55			
		08.95- 09.01	CA333IR	28 55			
		08.95- 09.01	CA854IR	28 35			
32.410 12.0	(E2000 Evolution)[D2866LF25]	05.00-	CA1663IR	28 90	05.00-	CS191	24 5.4
	(TGA)[D2866LF28]	09.02- 06.05	CA1663IR	28 90	09.02- 06.05	CS191	24 5.4
		09.02- 06.05	CA1695IR	28 55			
32.414 12.0	(F 2000)[D2866LF25]	05.01-	CA1663IR	28 90			
32.422 12.0	(F 90)[D2866LF06]	02.90- 06.96	CA1035IR	28 80	02.90- 05.94	CS191	24 5.4
		02.90- 08.93	CA222IR	28 35			
		02.90- 04.92	CA333IR	28 55			
		09.93- 06.96	CA854IR	28 35			
	[D2866LF09]	02.90- 06.96	CA1035IR	28 80	10.92- 06.96	CS191	24 5.4
		02.90- 08.93	CA222IR	28 35			
		09.93- 06.96	CA854IR	28 35			
		05.94	CA1035IR	28 80			
		08.93	CA854IR	28 35			
		04.92	CA333IR	28 55			
		08.93	CA222IR	28 35			
32.430 10.5	(TGA)[D2066LF01]	05.04-	CA1870IR	28 80			
		05.04-	CA1871IR	28 110			
		05.04-	CA1997IR	28 120			
	[D2066LF11]	05.04-	CA1870IR	28 80			
		05.04-	CA1871IR	28 110			
		05.04-	CA1997IR	28 120			
	[D2066LF31]	05.04-	CA1870IR	28 80			
		05.04-	CA1871IR	28 110			
		05.04-	CA1997IR	28 120			
32.440 10.5	(TGA)[D2066LF01]	05.04-	CA1870IR	28 80			
		05.04-	CA1871IR	28 110			
		05.04-	CA1997IR	28 120			
	[D2066LF11]	05.04-	CA1870IR	28 80			
		05.04-	CA1871IR	28 110			
		05.04-	CA1997IR	28 120			
	[D2066LF31]	05.04-	CA1870IR	28 80			
		05.04-	CA1871IR	28 110			
		05.04-	CA1997IR	28 120			
	(TGS)[D2066LF25]	10.07-	CA1870IR	28 80			
	[D2066LF36]	10.07-	CA1870IR	28 80			
		08.08-	CA1871IR	28 110			
	[D2066LF40]	10.07-	CA1870IR	28 80			
32.460 12.8	(E2000 Evolution)[D2876LF03]	05.00-	CA1035IR	28 80	05.00-	CS191	24 5.4
		05.00-	CA1663IR	28 90			
		05.00-	CA1695IR	28 55			
		05.00-	CA333IR	28 55			
		05.00-	CA854IR	28 35			
	(TGA)[D2876LF04]	09.02-	CA1663IR	28 90	09.02-	CS191	24 5.4
		09.02-	CA1695IR	28 55			
32.463 12.8	(F 2000)[D2876LF02]	08.95- 09.01	CA1035IR	28 80	08.95- 09.01	CS191	24 5.4
		08.95- 09.01	CA1663IR	28 90			
		08.95- 09.01	CA1695IR	28 55			
		08.95- 09.01	CA333IR	28 55			
		08.95- 09.01	CA854IR	28 35			
32.464 12.0	(F 2000)[D2866LF24]	05.01-	CA1663IR	28 90			
32.464 12.8	(F 2000)[D2876LF03]	05.01-	CA1663IR	28 90			
32.480 12.4	(TGA)[D2676LF01]	02.06-	CA1870IR	28 80			
		02.06-	CA1871IR	28 110			
	(TGS)[D2676LF05]	08.08-	CA1997IR	28 120			
	[D2676LF07]	08.08-	CA1997IR	28 120			
32.480 12.8	(TGA)[D2876LF12]	05.04- 09.05	CA1847IR	28 80	05.04- 09.05	CS191	24 5.4
33.242 12.0	(F 90)[D2866F/240]	01.88- 08.88	CA222IR	28 35	01.88- 08.88	CS191	24 5.4
		01.88- 08.88	CA333IR	28 55			
33.262 10.0	(F 90)[D2865LF/260]	08.88- 02.90	CA1035IR	28 80	08.88- 02.90	CS191	24 5.4
		08.88- 02.90	CA222IR	28 35	08.88- 02.90	CS198	24 6.0
		08.88- 02.90	CA333IR	28 55			
33.272 10.0	(F 90)[D2865LF05]	10.92- 04.95	CA1035IR	28 80	10.92- 04.95	CS198	24 6.0
		10.92- 10.93	CA222IR	28 35	10.92- 04.95	CS191	24 5.4
		10.92- 04.95	CA333IR	28 55			
		11.93- 04.95	CA854IR	28 35			



MAN Continued

33.292 12.0	(F 90)[D2866LF290]	09.87- 02.90 09.87- 02.90 09.87- 02.90	CA1035IR CA222IR CA333IR	28 80 28 35 28 55	09.87- 02.90	CS191	24 5.4
33.322 10.0	(F 90)[D2865LF03]	09.91- 06.96 09.91- 08.93 07.93- 06.96 09.93- 06.96	CA1035IR CA222IR CA333IR CA854IR	28 80 28 35 28 55 28 35	09.91- 06.96	CS198	24 6.0
	[D2865LF06]	09.91- 06.96 09.91- 08.93 07.93- 06.96 09.93- 06.96	CA1035IR CA222IR CA333IR CA854IR	28 80 28 35 28 55 28 35	09.91- 06.96	CS198	24 6.0
33.323 10.0	(F 2000)[D2865LF23]	01.94- 12.95 01.94- 12.95 01.94- 12.95	CA1035IR CA333IR CA854IR	28 80 28 55 28 35	01.94- 12.95	CS191	24 5.4
33.332 10.0	(F 90)[D2866LF/330]	09.87- 02.90 09.87- 02.90 09.87- 02.90	CA1035IR CA222IR CA333IR	28 80 28 35 28 55	09.87- 02.90	CS191	24 5.4
33.332 12.0	(F 90)[D2866LF/330]	09.87- 02.90 09.87- 02.90 09.87- 02.90	CA1035IR CA222IR CA333IR	28 80 28 35 28 55	09.87- 02.90	CS191	24 5.4
33.342 10.0	(F 90)[D2865LF09]	05.94- 06.96 05.94- 06.96 05.94- 06.96	CA1035IR CA333IR CA854IR	28 80 28 55 28 35	05.94- 06.96	CS198	24 6.0
33.343 10.0	(F 2000)[D2865LF21]	01.94- 09.01 01.94- 09.01 01.94- 09.01	CA1035IR CA333IR CA854IR	28 80 28 55 28 35	01.94- 09.01	CS191	24 5.4
33.350 10.5	(TGA)[D2066LF03]	05.04- 05.04- 05.04-	CA1870IR CA1871IR CA1997IR	28 80 28 110 28 120			
	[D2066LF13]	05.04- 05.04- 05.04-	CA1870IR CA1871IR CA1997IR	28 80 28 110 28 120			
	[D2066LF33]	05.04- 05.04- 05.04-	CA1870IR CA1871IR CA1997IR	28 80 28 110 28 120			
33.360 10.5	(TGA)[D2066LF03]	05.04- 05.04- 05.04-	CA1870IR CA1871IR CA1997IR	28 80 28 110 28 120			
	[D2066LF07]	09.07-	CA1871IR	28 110			
	[D2066LF13]	05.04- 05.04- 05.04-	CA1870IR CA1871IR CA1997IR	28 80 28 110 28 120			
	[D2066LF33]	05.04- 05.04- 05.04-	CA1870IR CA1871IR CA1997IR	28 80 28 110 28 120			
	(TGS)[D2066LF27]	02.09-	CA1870IR	28 80			
	[D2066LF38]	06.08- 02.09-	CA1870IR CA1871IR	28 80 28 110			
	[D2066LF42]	06.08- 02.09-	CA1870IR CA1871IR	28 80 28 110			
33.360 12.0	(E2000 Evolution)[D2866LF24]	05.00-	CA1663IR	28 90	05.00-	CS191	24 5.4
	(TGA)[D2866LF27]	09.02- 12.05 09.02- 12.05 09.02- 05.04	CA1663IR CA1695IR CA1847IR	28 90 28 55 28 80	01.01- 12.05	CS191	24 5.4
	[D2866LF37]	10.00- 05.04 10.00- 05.04 09.02- 05.04	CA1663IR CA1695IR CA1847IR	28 90 28 55 28 80	10.00- 12.05	CS191	24 5.4
33.362 12.0	(F 90)[D2866KF]	09.87- 02.90 09.87- 02.90 09.87- 02.90	CA1035IR CA222IR CA333IR	28 80 28 35 28 55	09.87- 02.90	CS191	24 5.4
	[D2866LXF]	09.87- 02.90 09.87- 02.90 09.87- 02.90	CA1035IR CA222IR CA333IR	28 80 28 35 28 55	09.87- 02.90 05.01-	CS191 CS191	24 5.4 24 5.4
33.364 12.0	(F 2000)	05.01-	CA333IR	28 55			
33.372 12.0	(F 90)[D2866LF03]	09.91- 06.96 09.91- 08.93 09.91- 04.92 09.93- 06.96	CA1035IR CA222IR CA333IR CA854IR	28 80 28 35 28 55 28 35	01.91- 10.92	CS191	24 5.4
	[D2866LF05]	09.91- 06.96 09.91- 08.93 09.93- 06.96	CA1035IR CA222IR CA854IR	28 80 28 35 28 35	10.92- 05.94	CS191	24 5.4
	[D2866LF15]	09.91- 06.96 09.91- 08.93 09.93- 06.96	CA1035IR CA222IR CA854IR	28 80 28 35 28 35	05.94- 06.96	CS191	24 5.4
33.373 12.0	(F 2000)[D2866LF21]	01.94- 12.95 01.94- 12.95 01.94- 12.95 01.94- 12.95 01.94- 12.95	CA1035IR CA1663IR CA1695IR CA333IR CA854IR	28 80 28 90 28 55 28 55 28 35	01.94- 12.95	CS191	24 5.4
33.390 10.5	(TGA)[D2066LF02]	05.04- 05.04- 05.04-	CA1870IR CA1871IR CA1997IR	28 80 28 110 28 120			
	[D2066LF06]	09.07-	CA1871IR	28 110			
	[D2066LF12]	05.04- 05.04- 05.04-	CA1870IR CA1871IR CA1997IR	28 80 28 110 28 120			
	[D2066LF32]	05.04- 05.04- 05.04-	CA1870IR CA1871IR CA1997IR	28 80 28 110 28 120			
33.400 10.5	(TGA)[D2066LF02]	05.04- 05.04- 05.04-	CA1870IR CA1871IR CA1997IR	28 80 28 110 28 120			
	[D2066LF06]	09.07-	CA1871IR	28 110			
	[D2066LF12]	05.04- 05.04- 05.04-	CA1870IR CA1871IR CA1997IR	28 80 28 110 28 120			
	[D2066LF32]	05.04- 05.04- 05.04-	CA1870IR CA1871IR CA1997IR	28 80 28 110 28 120			
	(TGS)[D2066LF37]	06.08- 02.09-	CA1870IR CA1871IR	28 80 28 110			
	[D2066LF41]	06.08- 02.09-	CA1870IR CA1871IR	28 80 28 110			
	(TGX)[D2066LF26]	10.07- 10.07-	CA1870IR CA1871IR	28 80 28 110			
	[D2066LF37]	10.07- 10.07- 10.07-	CA1870IR CA1871IR CA1997IR	28 80 28 110 28 120			
33.402 12.0	(F 90)[D2866LF16]	05.94- 06.96 05.94- 06.96	CA1035IR CA854IR	28 80 28 35	05.94- 06.96	CS191	24 5.4



33.403 12.0	(F 2000)[D2866LF20]	01.94- 09.01 01.94- 09.01 01.94- 09.01 01.94- 09.01 01.94- 09.01	CA1035IR 28 80 CA1663IR 28 90 CA1695IR 28 55 CA333IR 28 55 CA854IR 28 35	01.94- 09.01	CS191	24 5.4
33.410 12.0	(E2000 Evolution)[D2866LF25]	05.00-	CA1663IR 28 90	05.00-	CS191	24 5.4
	(TGA)[D2866LF28]	09.02- 05.04 09.02- 05.04 09.02- 05.04	CA1663IR 28 90 CA1695IR 28 55 CA1847IR 28 80	10.00- 12.05	CS191	24 5.4
	[D2866LF32]	10.00- 05.04 09.02- 05.04 09.02- 05.04	CA1663IR 28 90 CA1695IR 28 55 CA1847IR 28 80	10.00- 05.01-	CS191 CS191	24 5.4 24 5.4
33.414 12.0	(F 2000)	05.01-	CA333IR 28 55			
33.422 12.0	(F 90)[D2866LF06]	09.91- 06.96 09.91- 08.93 09.91- 04.92 09.93- 06.96	CA1035IR 28 80 CA222IR 28 35 CA333IR 28 55 CA854IR 28 35	09.91- 06.96	CS191	24 5.4
	[D2866LF09]	09.91- 06.96 09.91- 08.93 09.93- 06.96	CA1035IR 28 80 CA222IR 28 35 CA854IR 28 35	09.91- 06.96	CS191	24 5.4
33.423 12.0	(F 2000)[D2866LF22]	01.94- 12.95 01.94- 12.95 01.94- 12.95 01.94- 12.95 01.94- 12.95	CA1035IR 28 80 CA1663IR 28 90 CA1695IR 28 55 CA333IR 28 55 CA854IR 28 35	01.94- 12.95	CS191	24 5.4
33.430 10.5	(TGA)[D2066LF01]	05.04- 05.04- 05.04-	CA1870IR 28 80 CA1871IR 28 110 CA1997IR 28 120			
	[D2066LF11]	05.04- 05.04- 05.04-	CA1870IR 28 80 CA1871IR 28 110 CA1997IR 28 120			
	[D2066LF31]	05.04- 05.04- 05.04-	CA1870IR 28 80 CA1871IR 28 110 CA1997IR 28 120			
33.440 10.5	(TGA)[D2066LF01]	05.04- 05.04- 05.04-	CA1870IR 28 80 CA1871IR 28 110 CA1997IR 28 120			
	[D2066LF11]	05.04- 05.04- 05.04-	CA1870IR 28 80 CA1871IR 28 110 CA1997IR 28 120			
	[D2066LF31]	05.04- 05.04- 05.04-	CA1870IR 28 80 CA1871IR 28 110 CA1997IR 28 120			
	(TGS)[D2066LF25]	07.08-	CA1997IR 28 120			
	[D2066LF36]	06.08-	CA1997IR 28 120			
	[D2066LF40]	06.08-	CA1997IR 28 120			
	(TGX)[D2066LF25]	10.07- 10.07-	CA1870IR 28 80 CA1871IR 28 110			
	[D2066LF36]	10.07- 10.07-	CA1870IR 28 80 CA1871IR 28 110			
33.440 12.4	(TGA)[D2676LF04]	06.05-	CA1997IR 28 120			
33.460 12.8	(E2000 Evolution)[D2876LF03]	05.00-	CA1035IR 28 80	05.00-	CS191	24 5.4
		05.00- 05.00- 05.00- 05.00-	CA1663IR 28 90 CA1695IR 28 55 CA333IR 28 55 CA854IR 28 35			
	(TGA)[D2876LF04]	09.02- 12.05 09.02- 12.05 09.02- 12.05	CA1663IR 28 90 CA1695IR 28 55 CA1847IR 28 80	09.02- 12.05	CS191	24 5.4
	[D2876LF07]	09.02- 09.02- 09.02-	CA1663IR 28 90 CA1695IR 28 55 CA1847IR 28 80	09.02-	CS191	24 5.4
33.462 18.3	(F 90)[D2840LF/460]	07.89- 02.90 07.89- 02.90 07.89- 02.90	CA1035IR 28 80 CA222IR 28 35 CA333IR 28 55	07.89- 02.90	CS198	24 6.0
33.463 12.0	(F 2000)[D2876LF02]	01.94- 09.01 01.94- 09.01 01.94- 09.01 01.94- 09.01 01.94- 09.01	CA1035IR 28 80 CA1663IR 28 90 CA1695IR 28 55 CA333IR 28 55 CA854IR 28 35	01.94- 09.01	CS191	24 5.4
33.463 12.8	(F 2000)[D2876LF02]	01.94- 09.01 01.94- 09.01 01.94- 09.01 01.94- 09.01 01.94- 09.01	CA1035IR 28 80 CA1663IR 28 90 CA1695IR 28 55 CA333IR 28 55 CA854IR 28 35	01.94- 09.01 05.01-	CS191 CS191	24 5.4 24 5.4
33.464 12.8	(F 2000)	05.01-	CA333IR 28 55			
33.480 12.4	(TGA)[D2676LF01]	02.06- 02.06-	CA1870IR 28 80 CA1871IR 28 110			
	[D2676LF02]	09.07-	CA1997IR 28 120			
	[D2676LF03]	09.07-	CA1997IR 28 120			
	(TGS)[D2676LF05]	08.08-	CA1997IR 28 120			
	[D2676LF07]	08.08-	CA1997IR 28 120			
	[D2676LF14]	08.08-	CA1997IR 28 120			
	(TGX)[D2676LF05]	10.07- 10.07-	CA1870IR 28 80 CA1871IR 28 110			
	[D2676LF14]	10.07- 10.07-	CA1870IR 28 80 CA1871IR 28 110			
33.480 12.8	(TGA)[D2876LF05]	09.02- 06.03 09.02- 06.03	CA1663IR 28 90 CA1695IR 28 55	09.02-	CS191	24 5.4
	[D2876LF12]	09.02- 09.06	CA1847IR 28 80	09.02- 09.06	CS191	24 5.4
	[D2876LF25]	09.02-	CA1847IR 28 80	09.02-	CS191	24 5.4
33.502 18.3	(F 90)[D2840LF01]	09.91- 06.96 09.91- 06.96 09.91- 06.96 09.91- 06.96	CA1035IR 28 80 CA222IR 28 35 CA333IR 28 55 CA854IR 28 35	09.91- 06.96	CS198	24 6.0
	[D2840LF04]	09.91- 06.96 09.91- 06.96 09.91- 06.96 09.91- 06.96	CA1035IR 28 80 CA222IR 28 35 CA333IR 28 55 CA854IR 28 35	09.91- 06.96	CS198	24 6.0
	[D2840LF06]	09.91- 06.96 09.91- 06.96 09.91- 06.96 09.91- 06.96	CA1035IR 28 80 CA222IR 28 35 CA333IR 28 55 CA854IR 28 35	09.91- 06.96	CS198	24 6.0
33.510 12.8	(TGA)[D2876LF05]	09.02- 06.03 09.02- 06.03	CA1663IR 28 90 CA1695IR 28 55	09.02- 06.03	CS191	24 5.4
33.530 12.8	(TGA)[D2876LF13]	09.02- 07.03- 07.03-	CA1847IR 28 80 CA1663IR 28 90 CA1695IR 28 55	09.02-	CS191	24 5.4



MAN Continued

33.540 12.4	(TGS)[D2676LF06]	02.09-	CA1997IR	28 120			
	[D2676LF13]	02.09-	CA1997IR	28 120			
	(TGX)[D2676LF13]	10.07-	CA1870IR	28 80			
		10.07-	CA1871IR	28 110			
33.600 18.3	(E2000 Evolution)[D2840LF21]				06.00-	CS198	24 6.0
33.603 18.3	(F 2000)[D2840LF20]				06.96-	CS198	24 6.0
33.680 16.2	(TGX)[D2868LF02]	10.07-	CA1870IR	28 80			
		10.07-	CA1871IR	28 110			
		10.07-	CA1997IR	28 120			
35.262 10.0	(F 90)[D2865LF260]	02.89- 02.90	CA1035IR	28 80	02.89- 02.90	CS191	24 5.4
		02.89- 02.90	CA222IR	28 35	02.89- 02.90	CS198	24 6.0
		02.89- 02.90	CA333IR	28 55			
35.272 10.0	(F 90)[D2865LF02]	02.90- 12.92	CA1035IR	28 80	02.90- 12.92	CS198	24 6.0
		02.90- 12.92	CA222IR	28 35	02.90- 12.92	CS191	24 5.4
		02.90- 12.92	CA333IR	28 55			
35.292 12.0	(F 90)[D2866LFZ/290]	10.88- 04.95	CA222IR	28 35	10.88- 04.95	CS191	24 5.4
		10.88- 04.95	CA333IR	28 55			
35.302 12.0	(F 90)[D2866LF04]	05.90- 09.91	CA1035IR	28 80	05.90- 11.90	CS191	24 5.4
		05.90- 09.91	CA222IR	28 35			
		05.90- 09.91	CA333IR	28 55			
35.310 10.5	(TGA)[D2066LF04]	02.04-	CA1870IR	28 80			
		02.04-	CA1871IR	28 110			
		02.04-	CA1997IR	28 120			
		02.04-	CA1870IR	28 80			
		02.04-	CA1871IR	28 110			
35.310 12.0	(TGA)[D2866LF26]	06.03- 06.05	CA1663IR	28 90	06.03- 06.05	CS191	24 5.4
		06.03- 06.05	CA1695IR	28 55	03.02-	CS191	24 5.4
		06.03- 06.05	CA1847IR	28 80			
35.314 12.0	(F 2000)	03.02-	CA333IR	28 55			
35.320 10.5	(TGA)[D2066LF04]	02.04-	CA1870IR	28 80			
		02.04-	CA1871IR	28 110			
		02.04-	CA1997IR	28 120			
		02.04-	CA1870IR	28 80			
		02.04-	CA1871IR	28 110			
		02.04-	CA1997IR	28 120			
		10.07-	CA1871IR	28 110			
		10.07-	CA1871IR	28 110			
		06.08-	CA1870IR	28 80			
		10.07-	CA1871IR	28 110			
		06.08-	CA1870IR	28 80			
		35.322 10.0	(F 90)[D2865LF03]	02.90- 06.96	CA1035IR	28 80	02.90- 06.96
02.90- 08.93	CA222IR			28 35			
07.93- 06.96	CA333IR			28 55			
09.93- 06.96	CA854IR			28 35			
02.90- 06.96	CA1035IR			28 80	02.90- 06.96	CS198	24 6.0
02.90- 08.93	CA222IR			28 35			
07.93- 06.96	CA333IR			28 55			
09.93- 06.96	CA854IR	28 35					
35.322 12.0	(F 90)[D2865LF03]	02.90- 05.94	CA1035IR	28 80	02.90- 05.94	CS198	24 6.0
		02.90- 08.93	CA222IR	28 35			
		07.93- 05.94	CA333IR	28 55			
		09.93- 05.94	CA854IR	28 35			
35.332 12.0	(F 90)[D2866LFZ/330]	10.88- 04.95	CA222IR	28 35	10.88- 04.95	CS191	24 5.4
		10.88- 04.95	CA333IR	28 55			
35.342 10.0	(F 90)[D2865LF09]	05.94- 06.96	CA1035IR	28 80	05.94- 06.96	CS198	24 6.0
		05.94- 06.96	CA333IR	28 55			
		05.94- 06.96	CA854IR	28 35			
35.343 10.0	(F 2000)[D2865LF21]	08.95- 09.01	CA1035IR	28 80	08.95- 09.01	CS191	24 5.4
		08.95- 09.01	CA333IR	28 55			
		08.95- 09.01	CA854IR	28 35			
35.350 10.5	(TGA)[D2066LF03]	02.04- 09.06	CA1870IR	28 80			
		02.04- 09.06	CA1871IR	28 110			
		02.04- 09.06	CA1997IR	28 120			
		10.04- 09.06	CA1870IR	28 80			
		10.04- 09.06	CA1871IR	28 110			
		10.04- 09.06	CA1997IR	28 120			
		02.04-	CA1870IR	28 80			
		02.04-	CA1871IR	28 110			
		02.04-	CA1997IR	28 120			
35.360 10.5	(TGA)[D2066LF03]	02.04- 09.06	CA1870IR	28 80			
		02.04- 09.06	CA1871IR	28 110			
		02.04- 09.06	CA1997IR	28 120			
		02.04-	CA1870IR	28 80			
		02.04-	CA1871IR	28 110			
		02.04-	CA1997IR	28 120			
		07.06-	CA1870IR	28 80			
		07.06-	CA1871IR	28 110			
		07.06-	CA1997IR	28 120			
		07.06-	CA1870IR	28 80			
		07.06-	CA1871IR	28 110			
		10.07-	CA1871IR	28 110			
		10.07-	CA1871IR	28 110			
		06.08-	CA1870IR	28 80			
		10.07-	CA1871IR	28 110			
06.08-	CA1870IR	28 80					
35.360 12.0	(E2000 Evolution)[D2866LF24]	05.00-	CA1663IR	28 90	05.00-	CS191	24 5.4
35.362 12.0	(F 90)[D2866LXF]	10.03- 12.05	CA1663IR	28 90	10.03- 12.05	CS191	24 5.4
		10.03- 12.05	CA1695IR	28 55			
		10.03- 12.05	CA1847IR	28 80			
35.372 12.0	(F 90)[D2866LF03]	10.88- 02.90	CA1035IR	28 80	10.88- 02.90	CS191	24 5.4
		10.88- 02.90	CA222IR	28 35			
		10.88- 02.90	CA333IR	28 55			
		02.90- 06.96	CA1035IR	28 80	02.90- 05.94	CS191	24 5.4
		02.90- 08.93	CA222IR	28 35			
35.372 12.0	(F 90)[D2866LF05]	02.90- 04.92	CA333IR	28 55			
		09.93- 06.96	CA854IR	28 35			
		02.90- 06.96	CA1035IR	28 80	10.92- 05.94	CS191	24 5.4
		02.90- 08.93	CA222IR	28 35			
		02.90- 04.92	CA333IR	28 55			
		09.93- 06.96	CA854IR	28 35			
		02.90- 06.96	CA1035IR	28 80	05.94- 06.96	CS191	24 5.4
		02.90- 08.93	CA222IR	28 35			
		02.90- 04.94	CA333IR	28 55			
		09.93- 06.96	CA854IR	28 35			





	[D2866LXF/Silent]	02.90- 04.95 02.90- 04.95	CA222IR CA333IR	28 35 28 55	02.90- 04.95	CS191	24 5.4
35.390 10.5	(TGA)[D2066LF02]	02.04- 09.06 06.04- 09.06 06.04- 09.06	CA1997IR CA1870IR CA1871IR	28 120 28 80 28 110			
	[D2066LF12]	02.04- 09.06 10.04- 09.06	CA1997IR CA1870IR CA1871IR	28 120 28 80 28 110			
	[D2066LF32]	02.04- 02.04- 02.04-	CA1870IR CA1871IR CA1997IR	28 80 28 110 28 120			
35.400 10.5	(TGA)[D2066LF02]	02.04- 02.04- 02.04-	CA1870IR CA1871IR CA1997IR	28 80 28 110 28 120			
	[D2066LF12]	02.04- 02.04- 02.04-	CA1870IR CA1871IR CA1997IR	28 80 28 110 28 120			
	[D2066LF32]	07.06- 07.06- 07.06-	CA1870IR CA1871IR CA1997IR	28 80 28 110 28 120			
	[D2066LF37]	02.04- 07.06-	CA1871IR CA1870IR	28 110 28 80			
	(TGS)[D2066LF26] [D2066LF37]	10.07- 10.07-	CA1871IR CA1871IR	28 110 28 110			
	[D2066LF41]	06.08- 10.07- 06.08-	CA1870IR CA1871IR CA1870IR	28 80 28 110 28 80			
	(TGX)[D2066LF26]	06.08- 06.08-	CA1870IR CA1871IR	28 80 28 110			
	[D2066LF37]	06.08- 06.08-	CA1870IR CA1871IR	28 80 28 110			
35.402 12.0	(F 90)[D2866LF16]	05.94- 06.96 05.94- 06.96	CA1035IR CA854IR	28 80 28 35	05.94- 06.96	CS191	24 5.4
35.403 12.0	(F 2000)[D2866LF20]	08.95- 09.01 08.95- 09.01 08.95- 09.01 08.95- 09.01	CA1035IR CA1663IR CA1695IR CA333IR CA854IR	28 80 28 90 28 55 28 55 28 35	08.95- 09.01	CS191	24 5.4
35.410 12.0	(E2000 Evolution)[D2866LF25]	05.00-	CA1663IR	28 90	05.00-	CS191	24 5.4
	(TGA)[D2866LF28]	06.03- 05.04 06.03- 05.04 06.03- 05.04	CA1663IR CA1695IR CA1847IR	28 90 28 55 28 80	06.03- 05.04	CS191	24 5.4
35.414 12.0	(F 2000)[D2866LF25]	05.01-	CA1663IR	28 90			
35.422 12.0	(F 90)[D2866LF06]	02.90- 06.96 02.90- 08.93 02.90- 04.92 09.93- 06.96	CA1035IR CA222IR CA333IR CA854IR	28 80 28 35 28 55 28 35	02.90- 05.94	CS191	24 5.4
	[D2866LF09]	02.90- 06.96 02.90- 08.93 02.90- 04.92 09.93- 06.96	CA1035IR CA222IR CA333IR CA854IR	28 80 28 35 28 55 28 35	10.90- 06.96	CS191	24 5.4
35.430 10.5	(TGA)[D2066LF01]	02.04- 09.06 03.04- 09.06 03.04- 09.06	CA1997IR CA1870IR CA1871IR	28 120 28 80 28 110			
	[D2066LF11]	10.04- 09.06 10.04- 09.06 10.04- 09.06	CA1870IR CA1871IR CA1997IR	28 80 28 110 28 120			
	[D2066LF31]	02.04- 02.04- 02.04-	CA1870IR CA1871IR CA1997IR	28 80 28 110 28 120			
35.440 10.5	(TGA)[D2066LF01]	02.04- 02.04- 02.04-	CA1870IR CA1871IR CA1997IR	28 80 28 110 28 120			
	[D2066LF11]	02.04- 02.04- 02.04-	CA1870IR CA1871IR CA1997IR	28 80 28 110 28 120			
	[D2066LF31]	07.06- 07.06- 07.06-	CA1870IR CA1871IR CA1997IR	28 80 28 110 28 120			
	[D2066LF36]	07.06- 07.06-	CA1870IR CA1871IR	28 80 28 110			
	(TGS)[D2066LF25] [D2066LF36]	10.07- 10.07-	CA1997IR CA1997IR	28 120 28 120			
	[D2066LF40]	10.07-	CA1997IR	28 120			
	(TGX)[D2066LF25]	06.08- 06.08-	CA1870IR CA1871IR	28 80 28 110			
	[D2066LF36]	06.08- 06.08-	CA1870IR CA1871IR	28 80 28 110			
35.460 12.8	(E2000 Evolution)[D2876LF03]	05.00-	CA1035IR	28 80	05.00-	CS191	24 5.4
		05.00- 05.00- 05.00- 05.00-	CA1663IR CA1695IR CA333IR CA854IR	28 90 28 55 28 55 28 35			
	(TGA)[D2876LF04]				07.06-	CS191	24 5.4
35.463 12.8	(F 2000)[D2876LF02]	08.95- 09.01 08.95- 09.01 08.95- 09.01 08.95- 09.01 08.95- 09.01	CA1035IR CA1663IR CA1695IR CA333IR CA854IR	28 80 28 90 28 55 28 55 28 35	08.95- 09.01	CS191	24 5.4
35.464 12.8	(F 2000)[D2876LF03]	05.01-	CA1663IR	28 90			
35.480 12.4	(TGA)[D2676LF01]	07.06- 07.06-	CA1870IR CA1871IR	28 80 28 110			
	[D2676LF05]	07.06- 07.06-	CA1870IR CA1871IR	28 80 28 110			
	(TGS)[D2676LF05] [D2676LF07]	10.07- 10.07-	CA1997IR CA1997IR	28 120 28 120			
	[D2676LF14]	10.07-	CA1997IR	28 120			
	(TGX)[D2676LF05]	06.08- 06.08-	CA1870IR CA1871IR	28 80 28 110			
	[D2676LF14]	06.08- 06.08-	CA1870IR CA1871IR	28 80 28 110			
35.480 12.8	(TGA)[D2876LF12]	09.03- 09.06 09.03- 09.06 09.03- 09.06	CA1663IR CA1695IR CA1847IR	28 90 28 55 28 80	09.03- 09.06	CS191	24 5.4
35.530 12.8	(TGA)[D2876LF13]	06.04- 03.06 06.04- 03.06 06.04- 03.06	CA1663IR CA1695IR CA1847IR	28 90 28 55 28 80	06.04- 03.06	CS191	24 5.4
35.540 12.4	(TGS)[D2676LF06] [D2676LF13]	10.07- 10.07-	CA1997IR CA1997IR	28 120 28 120			



MAN Continued

	(TGX)[D2676LF13]	06.08- 06.08-	CA1870IR CA1871IR	28 80 28 110			
37.310 10.5	(TGA)[D2066LF04]	12.04- 12.04- 12.04-	CA1870IR CA1871IR CA1997IR	28 80 28 110 28 120			
	[D2066LF35]	12.04- 12.04- 12.04-	CA1870IR CA1871IR CA1997IR	28 80 28 110 28 120			
37.320 10.5	(TGA)[D2066LF04]	12.04- 12.04- 12.04-	CA1870IR CA1871IR CA1997IR	28 80 28 110 28 120			
	[D2066LF35]	12.04- 12.04- 12.04-	CA1870IR CA1871IR CA1997IR	28 80 28 110 28 120			
	(TGS)[D2066LF28]	10.07-	CA1871IR	28 110			
	[D2066LF39]	10.07- 07.08-	CA1871IR CA1870IR	28 110 28 80			
	[D2066LF43]	10.07- 07.08-	CA1871IR CA1870IR	28 110 28 80			
37.350 10.5	(TGA)[D2066LF03]	12.04- 09.06 12.04- 09.06 12.04- 09.06	CA1870IR CA1871IR CA1997IR	28 80 28 110 28 120			
	[D2066LF13]	10.04- 09.06 10.04- 09.06 10.04- 09.06	CA1870IR CA1871IR CA1997IR	28 80 28 110 28 120			
	[D2066LF33]	12.04- 12.04- 12.04-	CA1870IR CA1871IR CA1997IR	28 80 28 110 28 120			
37.360 10.5	(TGA)[D2066LF03]	12.04- 09.06 12.04- 09.06 12.04- 09.06	CA1870IR CA1871IR CA1997IR	28 80 28 110 28 120			
	[D2066LF13]	12.04- 12.04- 12.04-	CA1870IR CA1871IR CA1997IR	28 80 28 110 28 120			
	[D2066LF33]	07.06- 07.06- 07.06-	CA1870IR CA1871IR CA1997IR	28 80 28 110 28 120			
	(TGS)[D2066LF27]	10.07-	CA1871IR	28 110			
	[D2066LF38]	10.07-	CA1871IR	28 110			
	[D2066LF42]	10.07-	CA1871IR	28 110			
37.390 10.5	(TGA)[D2066LF02]	03.04- 09.06 03.04- 09.06 03.04- 09.06	CA1870IR CA1871IR CA1997IR	28 80 28 110 28 120			
	[D2066LF12]	10.04- 09.06 10.04- 09.06 10.04- 09.06	CA1870IR CA1871IR CA1997IR	28 80 28 110 28 120			
	[D2066LF32]	12.04- 12.04- 12.04-	CA1870IR CA1871IR CA1997IR	28 80 28 110 28 120			
37.400 10.5	(TGA)[D2066LF02]	12.04- 12.04- 12.04-	CA1870IR CA1871IR CA1997IR	28 80 28 110 28 120			
	[D2066LF12]	12.04- 12.04- 12.04-	CA1870IR CA1871IR CA1997IR	28 80 28 110 28 120			
	[D2066LF32]	12.04- 12.04- 12.04-	CA1870IR CA1871IR CA1997IR	28 80 28 110 28 120			
	(TGS)[D2066LF26]	10.07-	CA1870IR	28 80			
	[D2066LF37]	10.07- 07.08-	CA1870IR CA1871IR	28 80 28 110			
	[D2066LF41]	10.07- 07.08-	CA1870IR CA1871IR	28 80 28 110			
37.410 12.0	(TGA)[D2866LF28]				12.04-	CS191	24 5.4
37.414 12.0	(F 2000)[D2866LF25]	06.98-	CA1663IR	28 90			
37.430 10.5	(TGA)[D2066LF01]	03.04- 09.06 03.04- 09.06 03.04- 09.06	CA1870IR CA1871IR CA1997IR	28 80 28 110 28 120			
	[D2066LF11]	10.04- 09.06 10.04- 09.06 10.04- 09.06	CA1870IR CA1871IR CA1997IR	28 80 28 110 28 120			
	[D2066LF31]	12.04- 12.04- 12.04-	CA1870IR CA1871IR CA1997IR	28 80 28 110 28 120			
37.440 10.5	(TGA)[D2066LF01]	12.04- 12.04- 12.04-	CA1870IR CA1871IR CA1997IR	28 80 28 110 28 120			
	[D2066LF11]	12.04- 12.04- 12.04-	CA1870IR CA1871IR CA1997IR	28 80 28 110 28 120			
	[D2066LF31]	07.06- 07.06- 07.06-	CA1870IR CA1871IR CA1997IR	28 80 28 110 28 120			
	(TGS)[D2066LF25]	10.07-	CA1870IR	28 80			
	[D2066LF36]	10.07- 07.08-	CA1870IR CA1871IR	28 80 28 110			
	[D2066LF40]	10.07- 07.08-	CA1870IR CA1871IR	28 80 28 110			
37.460 12.8	(TGA)[D2876LF04]				12.04-	CS191	24 5.4
37.480 12.4	(TGA)[D2676LF01]	02.06- 07.06- 07.06-	CA1997IR CA1870IR CA1871IR	28 120 28 80 28 110			
	(TGS)[D2676LF05]	10.07-	CA1997IR	28 120			
	[D2676LF07]	10.07-	CA1997IR	28 120			
	[D2676LF14]	10.07-	CA1997IR	28 120			
37.540 12.4	(TGS)[D2676LF06]	10.07-	CA1997IR	28 120			
	[D2676LF13]	10.07-	CA1997IR	28 120			
39.390 10.5	(TGA)[D2066LF12]	07.06-	CA1997IR	28 120			
39.400 10.5	(TGA)[D2066LF37]	07.06-	CA1870IR	28 80			
39.430 10.5	(TGA)[D2066LF01]	07.06-	CA1997IR	28 120			
	[D2066LF11]	07.06-	CA1997IR	28 120			
39.440 10.5	(TGA)[D2066LF36]	07.06-	CA1871IR	28 110			
39.480 12.4	(TGA)[D2676LF05]	07.06-	CA1871IR	28 110			
40.372 12.0	(F 90)[D2866LF03]	12.91- 06.96 12.91- 08.93 12.91- 04.92	CA1035IR CA222IR CA333IR	28 80 28 35 28 55	12.91- 06.96	CS191	24 5.4
	[D2866LF05]	12.91- 06.96 12.91- 08.93 09.93- 06.96	CA1035IR CA222IR CA854IR	28 80 28 35 28 35	12.91- 06.96	CS191	24 5.4
	[D2866LF15]	12.91- 06.96 09.93- 06.96	CA1035IR CA854IR	28 80 28 35	12.91- 06.96	CS191	24 5.4
40.390 10.5	(TGA)[D2066LF02]	01.05- 09.06	CA1870IR	28 80			



		01.05- 09.06	CA1871IR	28	110				
		01.05- 09.06	CA1997IR	28	120				
	[D2066LF06]	06.05- 06.05- 06.05-	CA1870IR CA1871IR CA1997IR	28	80 110 120				
	[D2066LF37]	06.05- 06.05- 06.05-	CA1870IR CA1871IR CA1997IR	28	80 110 120				
40.400	10.5 (TGA)[D2066LF02]	06.05- 06.05- 06.05-	CA1870IR CA1871IR CA1997IR	28	80 110 120				
	[D2066LF06]	06.05- 06.05- 06.05-	CA1870IR CA1871IR CA1997IR	28	80 110 120				
	[D2066LF37]	06.05- 06.05- 06.05-	CA1870IR CA1871IR CA1997IR	28	80 110 120				
	(TGS)[D2066LF06]	02.11- 02.11- 02.11-	CA1870IR CA1871IR CA1997IR	28	80 110 120				
	[D2066LF49]	02.11- 02.11- 02.11-	CA1870IR CA1871IR CA1997IR	28	80 110 120				
	[D2066LF63]	02.11- 02.11- 02.11-	CA1870IR CA1871IR CA1997IR	28	80 110 120				
40.402	12.0 (F 90)[D2866LF16]	05.95- 05.95- 06.96	CA1035IR CA854IR	28	80 35	05.95- 06.96	CS191	24	5.4
40.403	12.0 (F 2000)[D2866LF20]	01.94-	CA333IR	28	55	01.94-	CS191	24	5.4
40.410	12.0 (TGA)[D2866LF28]	04.04- 04.04- 12.05	CA1663IR CA1695IR CA1847IR	28	90 55 80	04.04- 12.05	CS191	24	5.4
	[D2866LF32]	04.04- 04.04- 12.05	CA1663IR CA1695IR CA1847IR	28	90 55 80	04.04- 12.05	CS191	24	5.4
40.414	12.0 (F 2000)	05.01-	CA333IR	28	55				
40.422	12.0 (F 90)[D2866LF06]	12.91- 12.91- 08.93	CA1035IR CA222IR	28	80 35	12.91- 08.93	CS191	24	5.4
	[D2866LF09]	12.91- 09.93- 06.96	CA1035IR CA222IR CA854IR	28	80 35 35	12.91- 06.96	CS191	24	5.4
40.430	10.5 (TGA)[D2066LF01]	01.05- 01.05- 09.06	CA1870IR CA1871IR CA1997IR	28	80 110 120				
	[D2066LF36]	06.05- 06.05- 06.05-	CA1870IR CA1871IR CA1997IR	28	80 110 120				
40.440	10.5 (TGA)[D2066LF01]	06.05- 06.05- 06.05-	CA1870IR CA1871IR CA1997IR	28	80 110 120				
	[D2066LF36]	06.05- 06.05- 06.05-	CA1870IR CA1871IR CA1997IR	28	80 110 120				
	(TGS)[D2066LF50]	02.11- 02.11- 02.11-	CA1870IR CA1871IR CA1997IR	28	80 110 120				
	[D2066LF62]	02.11- 02.11- 02.11-	CA1870IR CA1871IR CA1997IR	28	80 110 120				
40.440	12.4 (TGA)[D2676LF04]	06.05- 02.11- 02.11-	CA1997IR CA1870IR CA1871IR	28	120 80 110				
	(TGS)[D2676LF04]	02.11- 02.11- 02.11-	CA1871IR CA1997IR	28	110 120				
40.460	12.8 (TGA)[D2876LF07]	04.04- 04.04- 04.04-	CA1663IR CA1695IR CA1847IR	28	90 55 80	04.04-	CS191	24	5.4
40.462	18.3 (F 90)[D2840LF/460]	07.89- 07.89- 02.90	CA1035IR CA222IR	28	80 35	07.89- 02.90	CS198	24	6.0
	[D2840LF04]	07.89- 02.90	CA333IR	28	55				
40.463	12.8 (F 2000)[D2876LF02]	01.94-	CA333IR	28	55	01.94-	CS191	24	5.4
40.480	12.4 (TGA)[D2676LF02]	06.05- 06.05- 06.05-	CA1870IR CA1871IR CA1997IR	28	80 110 120				
	[D2676LF03]	06.05- 06.05- 06.05-	CA1870IR CA1871IR CA1997IR	28	80 110 120				
	[D2676LF12]	06.05- 06.05- 06.05-	CA1997IR	28	120				
40.480	12.8 (TGA)[D2876LF12]	04.04- 09.06	CA1847IR	28	80	04.04- 09.06	CS191	24	5.4
	[D2876LF25]	04.04- 09.06	CA1847IR	28	80	04.04- 09.06	CS191	24	5.4
40.502	18.3 (F 90)[D2840LF01]	02.90- 02.90- 06.96	CA1035IR CA222IR	28	80 35	02.90- 06.96	CS198	24	6.0
	[D2840LF04]	02.90- 02.90- 06.96	CA333IR CA854IR	28	55 35				
	[D2840LF06]	02.90- 02.90- 06.96	CA1035IR CA222IR CA333IR CA854IR	28	80 35 55 35	02.90- 06.96	CS198	24	6.0
40.600	18.3 (E2000 Evolution)[D2840LF21]	02.90- 02.90- 06.96	CA1035IR CA222IR	28	80 35	02.90- 06.96	CS198	24	6.0
41.262	10.0 (F 90)[D2865LF/260]	07.89- 07.89- 02.90	CA1035IR CA222IR CA333IR	28	80 35 55	07.89- 02.90	CS191	24	5.4
	[D2865LF02]	07.89- 02.90	CA333IR	28	55				
41.272	10.0 (F 90)[D2865LF02]	02.90- 02.90- 12.91	CA1035IR CA222IR	28	80 35	02.90- 12.91	CS191	24	5.4
	[D2865LF03]	02.90- 02.90- 12.91	CA222IR CA333IR	28	35 55	02.90- 12.91	CS198	24	6.0
41.292	12.0 (F 90)[D2866LF/290]	10.88- 10.88- 02.90	CA1035IR CA222IR	28	80 35	10.88- 02.90	CS191	24	5.4
	[D2866LF03]	10.88- 02.90	CA333IR	28	55				
41.320	10.5 (TGS)[D2066LF43]	06.08-	CA1870IR	28	80				
41.322	10.0 (F 90)[D2865LF03]	02.90- 02.90- 05.94	CA1035IR CA222IR CA333IR CA854IR	28	80 35 55 35	02.90- 05.94	CS198	24	6.0



MAN Continued

	[D2865LF06]	02.90- 06.96 CA1035IR 28 80		02.90- 06.96 CS198	24 6.0
		02.90- 08.93 CA222IR 28 35			
		02.90- 06.96 CA333IR 28 55			
41.322 12.0	(F 90)[D2866LF/330]	10.88- 02.90 CA1035IR 28 80		10.88- 02.90 CS191	24 5.4
		10.88- 02.90 CA222IR 28 35			
		10.88- 02.90 CA333IR 28 55			
41.342 10.0	(F 90)[D2865LF09]	05.94- 06.96 CA1035IR 28 80		05.94- 06.96 CS198	24 6.0
		05.94- 06.96 CA333IR 28 55			
41.343 10.0	(F 2000)[D2865LF21]	08.95- 09.01 CA1035IR 28 80		08.95- 09.01 CS191	24 5.4
		08.95- 09.01 CA333IR 28 55			
		08.95- 09.01 CA854IR 28 35			
41.350 10.5	(TGA)[D2066LF03]	12.04- 09.06 CA1870IR 28 80			
		12.04- 09.06 CA1871IR 28 110			
		12.04- 09.06 CA1997IR 28 120			
	[D2066LF13]	10.04- 09.06 CA1870IR 28 80			
		10.04- 09.06 CA1871IR 28 110			
		10.04- 09.06 CA1997IR 28 120			
	[D2066LF33]	12.04- CA1870IR 28 80			
		12.04- CA1871IR 28 110			
		12.04- CA1997IR 28 120			
41.360 10.5	(TGA)[D2066LF03]	12.04- 09.06 CA1870IR 28 80			
		12.04- 09.06 CA1871IR 28 110			
		12.04- 09.06 CA1997IR 28 120			
	[D2066LF07]	09.07- CA1870IR 28 80			
		12.08- CA1871IR 28 110			
	[D2066LF13]	12.04- CA1870IR 28 80			
		12.04- CA1871IR 28 110			
		12.04- CA1997IR 28 120			
	[D2066LF33]	07.03- CA1997IR 28 120			
		07.06- CA1870IR 28 80			
		07.06- CA1871IR 28 110			
	(TGS)[D2066LF27]	10.07- CA1870IR 28 80			
	[D2066LF38]	10.07- CA1870IR 28 80			
		07.08- CA1871IR 28 110			
	[D2066LF42]	10.07- CA1870IR 28 80			
		07.08- CA1871IR 28 110			
41.360 12.0	(TGA)[D2866LF27]	01.03- 12.05 CA1663IR 28 90		01.03- 12.05 CS191	24 5.4
		01.03- 12.05 CA1695IR 28 55			
		12.04- CA1997IR 28 120			
	[D2866LF37]	01.03- 12.05 CA1663IR 28 90		01.03- 12.05 CS191	24 5.4
		01.03- 12.05 CA1695IR 28 55			
41.362 12.0	(F 90)[D2866LXF]	10.88- 02.90 CA1035IR 28 80		10.88- 02.90 CS191	24 5.4
		10.88- 02.90 CA222IR 28 35			
		10.88- 02.90 CA333IR 28 55			
41.364 12.0	(F 2000)	05.01- CA333IR 28 55			
41.372 12.0	(F 90)[D2866LF03]	02.90- 06.96 CA1035IR 28 80		02.90- 05.94 CS191	24 5.4
		02.90- 05.94 CA222IR 28 35			
		02.90- 04.92 CA333IR 28 55			
		09.93- 06.96 CA854IR 28 35			
	[D2866LF05]	02.90- 06.96 CA1035IR 28 80		10.92- 11.92 CS191	24 5.4
		02.90- 05.94 CA222IR 28 35			
		10.92- 05.94 CA333IR 28 55			
		09.93- 06.96 CA854IR 28 35			
	[D2866LF15]	02.90- 06.96 CA1035IR 28 80		05.94- 06.96 CS191	24 5.4
		09.93- 06.96 CA854IR 28 35			
41.390 10.5	(TGA)[D2066LF02]	03.04- 09.06 CA1870IR 28 80			
		03.04- 09.06 CA1871IR 28 110			
		03.04- 09.06 CA1997IR 28 120			
	[D2066LF12]	10.04- 09.06 CA1870IR 28 80			
		10.04- 09.06 CA1871IR 28 110			
		10.04- 09.06 CA1997IR 28 120			
	[D2066LF32]	12.04- CA1870IR 28 80			
		12.04- CA1871IR 28 110			
		12.04- CA1997IR 28 120			
41.400 10.5	(TGA)[D2066LF02]	12.04- CA1870IR 28 80			
		12.04- CA1871IR 28 110			
		12.04- CA1997IR 28 120			
	[D2066LF06]	09.07- CA1871IR 28 110			
	[D2066LF12]	12.04- CA1870IR 28 80			
		12.04- CA1871IR 28 110			
		12.04- CA1997IR 28 120			
	[D2066LF32]	07.06- CA1870IR 28 80			
		07.06- CA1871IR 28 110			
		07.06- CA1997IR 28 120			
	(TGS)[D2066LF26]	10.07- CA1870IR 28 80			
	[D2066LF37]	10.07- CA1870IR 28 80			
	[D2066LF41]	10.07- CA1870IR 28 80			
41.402 12.0	(F 90)[D2866LF16]	05.94- 06.96 CA1035IR 28 80		05.94- 05.94 CS191	24 5.4
		05.94- 06.96 CA854IR 28 35			
41.403 12.0	(F 2000)[D2866LF20]	08.95- 09.01 CA1035IR 28 80		08.95- 09.01 CS191	24 5.4
		08.95- 09.01 CA1663IR 28 90			
		08.95- 09.01 CA1695IR 28 55			
		08.95- 09.01 CA333IR 28 55			
		08.95- 09.01 CA854IR 28 35			
41.410 12.0	(E2000 Evolution)[D2866LF25]	05.00- CA1663IR 28 90		05.00- CS191	24 5.4
	(TGA)[D2866LF28]	09.03- CA1663IR 28 90		09.03- CS191	24 5.4
		09.03- CA1695IR 28 55			
		07.06- CA1847IR 28 80			
	[D2866LF32]	09.03- CA1663IR 28 90		09.03- CS191	24 5.4
		09.03- CA1695IR 28 55			
41.414 12.0	(F 2000)	05.01- CA333IR 28 55			
41.422 12.0	(F 90)[D2866LF06]	02.90- 06.96 CA1035IR 28 80		02.90- 05.94 CS191	24 5.4
		02.90- 08.93 CA222IR 28 35			
		02.90- 04.92 CA333IR 28 55			
		09.93- 06.96 CA854IR 28 35			
	[D2866LF09]	02.90- 06.96 CA1035IR 28 80		02.90- 05.94 CS191	24 5.4
		02.90- 08.93 CA222IR 28 35			
		09.93- 06.96 CA854IR 28 35			
41.430 10.5	(TGA)[D2066LF01]	06.04- 09.06 CA1870IR 28 80			
		06.04- 09.06 CA1871IR 28 110			
		06.04- 09.06 CA1997IR 28 120			
	[D2066LF11]	10.04- 09.06 CA1870IR 28 80			
		10.04- 09.06 CA1871IR 28 110			
		10.04- 09.06 CA1997IR 28 120			
	[D2066LF31]	12.04- CA1870IR 28 80			
		12.04- CA1871IR 28 110			
		12.04- CA1997IR 28 120			
41.440 10.5	(TGA)[D2066LF01]	12.04- CA1870IR 28 80			
		12.04- CA1871IR 28 110			
		12.04- CA1997IR 28 120			
	[D2066LF11]	12.04- CA1870IR 28 80			



		12.04-	CA1871IR	28	110				
		12.04-	CA1997IR	28	120				
	[D2066LF31]	07.06-	CA1870IR	28	80				
		07.06-	CA1871IR	28	110				
		07.06-	CA1997IR	28	120				
	[D2066LF36]	07.06-	CA1870IR	28	80				
	(TGS)[D2066LF25]	10.07-	CA1871IR	28	110				
	[D2066LF36]	10.07-	CA1871IR	28	110				
		06.08-	CA1870IR	28	80				
	[D2066LF40]	10.07-	CA1871IR	28	110				
		06.08-	CA1870IR	28	80				
41.440 12.4	(TGA)[D2676LF04]	12.04-	CA1997IR	28	120				
41.460 12.8	(E2000 Evolution)[D2876LF03]	05.00-	CA1035IR	28	80	05.00-	CS191	24	5.4
		05.00-	CA1663IR	28	90				
		05.00-	CA1695IR	28	55				
		05.00-	CA333IR	28	55				
		05.00-	CA854IR	28	35				
	(TGA)[D2876LF04]					12.04-	CS191	24	5.4
	[D2876LF07]	09.03-	CA1663IR	28	90	09.03-	CS191	24	5.4
		09.03-	CA1695IR	28	55				
41.463 12.8	(F 2000)[D2876LF02]	08.95- 09.01	CA1035IR	28	80	08.95- 09.01	CS191	24	5.4
		08.95- 09.01	CA1663IR	28	90				
		08.95- 09.01	CA1695IR	28	55				
		08.95- 09.01	CA333IR	28	55				
		08.95- 09.01	CA854IR	28	35				
41.464 12.8	(F 2000)[D2876LF06]	06.98-	CA333IR	28	55				
		03.02-	CA333IR	28	55				
41.480 12.4	(TGA)[D2676LF01]	02.06-	CA1870IR	28	80				
		02.06-	CA1871IR	28	110				
		02.06-	CA1997IR	28	120				
	[D2676LF02]	07.06-	CA1997IR	28	120				
	[D2676LF03]	09.07-	CA1997IR	28	120				
	[D2676LF05]	07.06-	CA1870IR	28	80				
		07.06-	CA1997IR	28	120				
	(TGS)[D2676LF05]	10.07-	CA1997IR	28	120				
	[D2676LF07]	10.07-	CA1997IR	28	120				
	[D2676LF14]	10.07-	CA1997IR	28	120				
41.480 12.8	(TGA)[D2876LF12]	06.05-	CA1847IR	28	80	06.05-	CS191	24	5.4
41.530 12.8	(TGA)[D2876LF12]	07.06-	CA1847IR	28	80	07.06-	CS191	24	5.4
	[D2876LF13]	06.03-	CA1847IR	28	80	06.03-	CS191	24	5.4
41.540 12.4	(TGA)[D2676LF13]	11.06-	CA1997IR	28	120				
	(TGS)[D2676LF06]	10.07-	CA1997IR	28	120				
	[D2676LF13]	10.07-	CA1997IR	28	120				
	(TGX)[D2676LF13]	06.08-	CA1870IR	28	80				
		06.08-	CA1871IR	28	110				
41.600 18.3	(E2000 Evolution)[D2840LF21]					06.00-	CS198	24	6.0
41.660 18.3	(TGA)[D2840LF25]	04.03-	CA1871IR	28	110	09.02-	CS198	24	6.0
41.680 16.2	(TGX)[D2868LF03]	10.07-	CA1870IR	28	80				
		10.07-	CA1871IR	28	110				
		10.07-	CA1997IR	28	120				
48.292 12.0	(F 90)[D2866LF/290]	07.89- 02.90	CA1035IR	28	80	07.89- 02.90	CS191	24	5.4
		07.89- 02.90	CA222IR	28	35				
		07.89- 02.90	CA333IR	28	55				
48.332 12.0	(F 90)[D2866LF/330]	07.89- 02.90	CA1035IR	28	80	07.89- 02.90	CS191	24	5.4
		07.89- 02.90	CA222IR	28	35				
		07.89- 02.90	CA333IR	28	55				
48.362 12.0	(F 90)[D2866LXF]	07.89- 02.90	CA1035IR	28	80	07.89- 02.90	CS191	24	5.4
		07.89- 02.90	CA222IR	28	35				
		07.89- 02.90	CA333IR	28	55				
48.462 18.3	(F 90)[D2840LF/460]	07.89- 02.90	CA1035IR	28	80	07.89- 02.90	CS198	24	6.0
		07.89- 02.90	CA222IR	28	35				
		07.89- 02.90	CA333IR	28	55				
50.410 12.0	(E2000 Evolution)[D2866LF25]	05.00-	CA1663IR	28	90	10.00-	CS191	24	5.4
50.460 12.8	(E2000 Evolution)[D2876LF03]	05.00-	CA1035IR	28	80	05.00-	CS191	24	5.4
		05.00-	CA1663IR	28	90				
		05.00-	CA1695IR	28	55				
		05.00-	CA333IR	28	55				
		05.00-	CA854IR	28	35				
50.600 18.3	(E2000 Evolution)[D2840LF21]					05.00-	CS198	24	6.0
6.90 3.8	(G)[D0224MF]	10.79- 09.87	CA327IR	28	27	10.79- 09.87	CS269	24	4.0
		02.83- 09.87	CA710IR	28	35	07.83- 09.87	CS595	24	4.0
8.90 3.8	(G)[D0224MF]	10.79- 09.87	CA327IR	28	27	07.83- 09.87	CS595	24	4.0
		02.83- 09.87	CA710IR	28	35	10.79- 09.87	CS269	24	4.0
EL 202 6.9	(EL Series)[D0826LUH]	04.94- 06.97	CA1237IR	28	140	04.94- 06.97	CS595	24	4.0
	[D0826LUH03]	01.93- 06.97	CA1237IR	28	140	01.93- 06.97	CS595	24	4.0
						01.93- 06.97	CS191	24	5.4
	[D0826LUH05]	01.93- 06.97	CA1237IR	28	140				
						01.93- 06.97	CS191	24	5.4
						01.93- 06.97	CS595	24	4.0
	[D0826LUH12]	01.93- 06.97	CA1237IR	28	140	01.93- 06.97	CS191	24	5.4
						01.93- 06.97	CS595	24	4.0
EL 222 6.9	(EL Series)[D0826LUH03]	01.93- 06.97	CA1237IR	28	140	01.93- 06.97	CS595	24	4.0
	[D0826LUH05]	01.93- 06.97	CA1237IR	28	140				
						01.93- 06.97	CS191	24	5.4
						01.93- 06.97	CS595	24	4.0
	[D0826LUH12]	01.93- 06.97	CA1237IR	28	140	01.93- 06.97	CS595	24	4.0
						01.93- 06.97	CS191	24	5.4
EL 262 12.0	(EL Series)[D2866LUH22]	07.98- 09.01	CA1237IR	28	140	07.98- 09.01	CS198	24	6.0
EL 262 6.9	(EL Series)[D0826LUH]	02.96- 09.01	CA1237IR	28	140	04.94- 09.01	CS595	24	4.0
EM 11.222 6.9	[D0826LOH15]	02.96- 09.01	CA1237IR	28	140				
EM 13.222 6.9	[D0826LUH12]	06.97- 09.01	CA1237IR	28	140				
EM 192 6.9	(EM Series)[D0826LOH06]	10.93- 06.97	CA1035IR	28	80	10.93- 06.97	CS595	24	4.0
		10.93- 06.97	CA1237IR	28	140	10.93- 06.97	CS1267	24	4.0
		10.93- 06.97	CA333IR	28	55	10.93- 06.97	CS191	24	5.4
		10.93- 06.97	CA854IR	28	35				
EM 222 6.9	(EM Series)[D0826LOH15]	02.96- 09.01	CA1237IR	28	140	06.00- 09.01	CS1243	24	4.0
	[D0826LUH12]	02.96- 09.01	CA1237IR	28	140	02.96- 09.01	CS191	24	5.4
						02.96- 09.01	CS191	24	5.4
EM 223 6.9	(EM Series)[D0826LOH15]	02.96- 09.01	CA1237IR	28	140				
						06.00- 09.01	CS1243	24	4.0
						02.96- 06.01	CS1267	24	4.0



MAN Continued

	[D0826LUH12]	02.96- 09.01	CA1237IR	28 140	07.01- 09.01	CS269	24 4.0
					02.96- 09.01	CS595	24 4.0
					02.00- 09.01	CS1243	24 4.0
					02.96- 09.01	CS1267	24 4.0
					02.96- 09.01	CS191	24 5.4
FRH 422 12.0	(Lions Star)[D2866LOH20]	01.93- 09.96	CA1237IR	28 140	01.93- 09.96	CS191	24 5.4
					01.93- 09.96	CS198	24 6.0
NG 262 10.0	(NG Series)[D2865LUH09]	06.97- 07.98	CA1237IR	28 140	06.97- 07.98	CS191	24 5.4
					06.97- 07.98	CS198	24 6.0
NG 262 12.0	(NG Series)[D2866LUH22]	07.98- 11.99	CA1237IR	28 140	07.98- 11.99	CS191	24 5.4
					07.98- 11.99	CS198	24 6.0
NG 262 6.9	(NG Series)[D0826LUH01]	08.92- 09.95	CA1237IR	28 140	08.92- 09.95	CS191	24 5.4
					08.92- 09.95	CS595	24 4.0
NG 263 12.0	(NG Series)[D2866LUH22]	07.98- 12.01	CA1237IR	28 140	07.98- 12.01	CS198	24 6.0
					07.98- 12.01	CS191	24 5.4
NG 272 6.9	(NG Series)[D0826LUH01]	08.92- 09.95	CA1237IR	28 140	08.92- 09.95	CS191	24 5.4
					08.92- 09.95	CS595	24 4.0
NG 312 10.0	(NG Series)[D2865LUH07]	09.95- 07.98	CA1237IR	28 140	09.95- 07.98	CS198	24 6.0
					09.95- 07.98	CS191	24 5.4
NG 312 12.0	(NG Series)[D2866LUH26]	07.98- 11.99	CA1237IR	28 140	07.98- 11.99	CS198	24 6.0
					07.98- 11.99	CS191	24 5.4
NG 313 12.0	(NG Series)[D2866LUH26]	07.98- 12.01	CA1237IR	28 140	07.98- 12.01	CS198	24 6.0
					07.98- 12.01	CS191	24 5.4
NL 202 6.9	(NL Series)[D0826LUH]	09.89- 03.97	CA1237IR	28 140	09.89- 04.94	CS191	24 5.4
					04.94- 03.97	CS1243	24 4.0
					04.94- 03.97	CS595	24 4.0
	[D0826LUH03]	08.92- 03.97	CA1237IR	28 140	08.92- 03.97	CS191	24 5.4
	[D0826LUH12]	11.95- 03.97	CA1237IR	28 140	11.95- 03.97	CS191	24 5.4
NL 222 6.9	(NL Series)[D0826LUH03]	08.92- 04.01	CA1237IR	28 140	08.92- 04.01	CS198	24 6.0
	[D0826LUH12]	08.92- 09.01	CA1237IR	28 140	11.95- 11.99	CS191	24 5.4
		07.98- 09.01	CA1663IR	28 90	11.95- 11.99	CS595	24 4.0
NL 223 6.9	(NL Series)[D0826LUH03]	08.92- 04.01	CA1237IR	28 140	08.92- 04.01	CS198	24 6.0
	[D0826LUH12]	08.92- 09.01	CA1237IR	28 140	07.98- 09.01	CS1243	24 4.0
		07.98- 09.01	CA1663IR	28 90	07.98- 09.01	CS191	24 5.4
					07.98- 09.01	CS595	24 4.0
NL 243 12.0	(Lions City)[E2866DUH04]	01.02-	CA1237IR	28 140	01.02-	CS198	24 6.0
		01.02-	CA1663IR	28 90	01.02-	CS191	24 5.4
NL 262 10.0	(NL Series)[D2865LUH09]	06.97- 07.98	CA1237IR	28 140	06.97- 07.98	CS191	24 5.4
					06.97- 07.98	CS198	24 6.0
NL 262 12.0	(NL Series)[D2866LUH22]	07.98- 11.99	CA1237IR	28 140	07.98- 11.99	CS198	24 6.0
					07.98- 11.99	CS191	24 5.4
NL 262 6.9	(NL Series)[D0826LUH]	02.96- 03.97	CA1237IR	28 140	04.94- 02.97	CS1243	24 4.0
					04.94- 03.97	CS595	24 4.0
NL 263 12.0	(NL Series)[D2866LUH22]	07.98- 09.01	CA1237IR	28 140	07.98- 09.01	CS198	24 6.0
					11.99- 09.01	CA1663IR	28 90
					07.98- 09.01	CS191	24 5.4
NL 263 6.9	(NL Series)[D0826LUH]	04.91- 03.97	CA1237IR	28 140	04.94- 02.97	CS1267	24 4.0
					04.94- 03.97	CS595	24 4.0
NL 312 10.0	(NL Series)[D2865LUH07]	11.95- 07.98	CA1237IR	28 140	11.95- 07.98	CS191	24 5.4
					11.95- 07.98	CS198	24 6.0
NL 313 12.0	(NL Series)[D2866LUH26]	07.98- 12.01	CA1237IR	28 140	07.98- 12.01	CS198	24 6.0
					07.98- 12.01	CS191	24 5.4
NM 152 4.4	(NM Series)[D0824LOH01]	04.92- 05.96	CA1035IR	28 80	04.92- 05.96	CS1267	24 4.0
					04.92- 05.96	CA1237IR	28 140
					05.90- 10.93	CA1035IR	28 80
NM 152 6.9	(NM Series)[D0826OH02]	05.90- 10.93	CA1035IR	28 80	05.90- 10.93	CS595	24 4.0
					05.90- 10.93	CA1237IR	28 140
NM 182 6.9	(NM Series)[D0826LOH01]	05.90- 03.97	CA1237IR	28 140	05.90- 03.97	CS1267	24 4.0
					10.93- 03.97	CA1035IR	28 80
					10.93- 03.97	CA333IR	28 55
					10.93- 03.97	CA854IR	28 35
	[D0826TOH]	05.90- 03.97	CA1237IR	28 140	05.90- 03.97	CS1267	24 4.0
					05.90- 03.97	CS595	24 4.0
NM 192 6.9	(NM Series)[D0826LOH01]	05.90- 03.97	CA1237IR	28 140	05.90- 03.97	CS1267	24 4.0
					05.90- 03.97	CS595	24 4.0
	[D0826TOH]	05.90- 03.97	CA1237IR	28 140	05.90- 03.97	CS1267	24 4.0
					05.90- 03.97	CS595	24 4.0
NM 222 6.9	(NM Series)[D0826LOH15]	02.96- 07.98	CA1237IR	28 140	02.96- 07.98	CS595	24 4.0
					02.00-	CS1243	24 4.0
					02.96- 07.98	CS1267	24 4.0
					02.96- 07.98	CS191	24 5.4
					02.96- 07.98	CS269	24 4.0
NM 223 6.9	(NM Series)[D0826LOH15]	07.98- 09.01	CA1237IR	28 140	08.87-	CS191	24 5.4
					08.87-	CS1243	24 4.0
					08.87-	CS1267	24 4.0
					08.87-	CS269	24 4.0
	[D0826LUH12]	02.96- 09.01	CA1237IR	28 140	02.00- 09.01	CS1243	24 4.0
					10.99- 09.01	CS1267	24 4.0
					02.96- 09.01	CS191	24 5.4
					07.98- 09.99	CS269	24 4.0
					02.96- 01.00	CS595	24 4.0
NU 263 10.0	(NU Series)[D2865LUH09]	09.96- 07.98	CA1237IR	28 140	09.96- 07.98	CS198	24 6.0
					09.96- 07.98	CS191	24 5.4
NU 263 12.0	(NU Series)[D2866LUH22]	07.98- 09.01	CA1237IR	28 140	07.98- 09.01	CS198	24 6.0
					07.98- 09.01	CS191	24 5.4
NU 263 6.9	(NU Series)[D0826LUH13]	07.98- 09.01	CA1237IR	28 140	07.98- 09.01	CS191	24 5.4
					07.98- 09.01	CS191	24 5.4
NU 313 12.0	(NU Series)[D2866LUH26]	07.98- 12.01	CA1237IR	28 140	07.98- 12.01	CS198	24 6.0



NU 313 15 12.0	(NU Series)[D2866LUH26]	07.98- 06.01	CA1237IR	28 140	07.98- 12.01	CS191	24 5.4
		07.98- 06.01	CA1663IR	28 90	07.98- 06.01	CS191	24 5.4
NU 353 15 12.0	(NU Series)[D2866LUH21]	07.98- 12.01	CA1237IR	28 140	07.98- 12.01	CS198	24 6.0
		07.98- 12.01	CA1663IR	28 90	07.98- 12.01	CS191	24 5.4
R 292 12.0	(R Series)[D2866TOH] [D2866TUH]	05.85- 01.93	CA333IR	28 55	05.85- 01.93	CS198	24 6.0
		05.85- 01.93	CA1237IR	28 140	05.85- 01.93	CS198	24 6.0
R 362 12.0	(R Series)[D2866KUH]	05.85- 12.92	CA1237IR	28 140	05.85- 12.92	CS198	24 6.0
RH 352 12.0	(Lions Coach)[D2866LOH26]  (Lions Star)[D2866LOH26]	09.95- 11.99	CA1237IR	28 140	09.95- 11.99	CS198	24 6.0
		09.95- 11.99	CA1237IR	28 140	09.95- 11.99	CS191	24 5.4
RH 402 12.0	(Lions Coach)[D2866LOH23]  (Lions Star)[D2866LOH23]	09.95- 09.01	CA1237IR	28 140	09.95- 09.01	CS198	24 6.0
		09.95- 09.01	CA1237IR	28 140	09.95- 09.01	CS191	24 5.4
RH 403 12.0	(Lions Coach)[D2866LOH23]  (Lions Star)[D2866LOH23]	09.95- 09.01	CA1237IR	28 140	09.95- 09.01	CS191	24 5.4
		09.95- 09.01	CA1237IR	28 140	09.95- 09.01	CS198	24 6.0
RH 414 12.0	(Lions Star)[D2866LOH34]	03.00- 09.06	CA1237IR	28 140	09.95- 09.01	CS191	24 5.4
		03.00- 09.06	CA1663IR	28 90	10.01- 09.06	CS191	24 5.4
RH 463 12.8	(Lions Coach)[D2876LOH01]  [D2876LOH02]	06.99- 09.01	CA1237IR	28 140	06.99- 09.01	CS198	24 6.0
		06.99- 09.01	CA1237IR	28 140	06.99- 09.01	CS191	24 5.4
RH 464 12.8	(Lions Star)[D2876LOH03]	10.01- 09.06	CA1237IR	28 140	06.99- 01.04	CS198	24 6.0
		10.01- 09.06	CA1663IR	28 90	10.01- 09.06	CS191	24 5.4
RHC 414 12.0	(Lions Coach)[D2866LOH34]	09.02- 09.06	CA1237IR	28 140	09.02- 09.06	CS191	24 5.4
		09.02- 09.06	CA1663IR	28 90	09.02- 09.06	CS198	24 6.0
RHC 464 12.8	(Lions Coach)[D2876LOH02]  [D2876LOH03]	06.99- 09.01	CA1237IR	28 140	01.00- 09.01	CS198	24 6.0
		06.99- 09.01	CA1237IR	28 140	06.99- 09.01	CS191	24 5.4
RHS 414 12.0	(Lions Star)[D2866LOH34]	03.00- 09.06	CA1237IR	28 140	10.01- 09.06	CS198	24 6.0
		10.01- 09.06	CA1663IR	28 90	10.01- 09.06	CS191	24 5.4
RHS 464 12.8	(Lions Star)[D2876LOH03]	10.01- 09.06	CA1237IR	28 140	10.01- 09.06	CS198	24 6.0
		10.01- 09.06	CA1663IR	28 90	10.01- 09.06	CS191	24 5.4
RN 313 12.0	(Lions Comfort)[D2866LUH20]  [D2866LUH26]	09.96- 03.98	CA1237IR	28 140	09.96- 03.98	CS198	24 6.0
		09.96- 03.98	CA1237IR	28 140	09.96- 12.01	CS191	24 5.4
RN 353 12.0	(Lions Coach)[D2866LOH26]  (Lions Comfort)[D2866LUH21]	09.95- 09.01	CA1237IR	28 140	09.96- 12.01	CS198	24 6.0
		09.95- 09.01	CA1237IR	28 140	09.95- 09.01	CS191	24 5.4
SD 200 11.0	(SD Series)[D2556MXUH/175] [D2556MXUH/192]	06.97- 03.98	CA1237IR	28 140	06.97- 03.98	CS191	24 5.4
		04.74- 09.75	CA1237IR	28 140	04.74- 09.75	CS198	24 6.0
SD 200 11.4	(SD Series)[D2566MUH/175] [D2566MUH/192] [D2566MUH/200] [D2566MUH/220] [D2566UH]	10.75- 04.80	CA1237IR	28 140	10.75- 04.80	CS198	24 6.0
		10.75- 11.86	CA1237IR	28 140	10.75- 11.86	CS191	24 5.4
SG 220 11.4	(SG Series)[D2566MUH] [D2566MUM]	05.80- 01.86	CA1237IR	28 140	05.80- 01.86	CS198	24 6.0
		07.76- 01.85	CA1237IR	28 140	07.76- 01.85	CS191	24 5.4
SG 240 11.4	(SG Series)[D2566MTUH] [D2566MUH]	09.81- 01.86	CA1237IR	28 140	09.81- 01.86	CS198	24 6.0
		05.80- 01.86	CA1237IR	28 140	05.80- 01.86	CS191	24 5.4
SG 240 12.0	(SG Series)[D2866TUH]  [D2866UH]	11.84- 09.89	CA1237IR	28 140	11.84- 09.89	CS198	24 6.0
		11.84- 09.89	CA333IR	28 55	09.85- 04.94	CA1237IR	28 140
SG 242 11.4	(SG Series)[D2566MUH]  [D2866UH]	09.85- 04.94	CA1237IR	28 140	09.85- 04.94	CS198	24 6.0
		09.85- 04.94	CA1237IR	28 140	05.80- 01.86	CS191	24 5.4
SG 242 12.0	(SG Series)[D2866TOH]  [D2866TUH] [D2866UH]	09.85- 04.94	CA1237IR	28 140	09.85- 04.94	CS198	24 6.0
		04.88- 04.94	CA1237IR	28 140	04.88- 04.94	CS191	24 5.4
SG 292 12.0	(SG Series)[D2866TOH] [D2866TUH]	09.85- 04.94	CA333IR	28 55	04.92- 04.93	CS191	24 5.4
		11.84- 04.94	CA333IR	28 55	11.84- 04.94	CS198	24 6.0
SG 312 10.0	(SG Series)[D2865LUH07]  [D2865LUH08]	04.94- 06.97	CA1237IR	28 140	02.96- 06.97	CS191	24 5.4
		04.94- 06.97	CA1237IR	28 140	02.96- 06.97	CS198	24 6.0
SG 322 10.0	(SG Series)[D2865LUH07]  [D2865LUH08]	04.94- 06.97	CA1237IR	28 140	02.94- 06.97	CS191	24 5.4
		04.94- 06.97	CA1237IR	28 140	02.94- 06.97	CS198	24 6.0
SL 200 11.4	(SL Series)[D2566MUH] [D2566UH]	05.80- 04.87	CA1237IR	28 140	05.80- 04.87	CS198	24 6.0
		01.86- 04.87	CA1237IR	28 140	01.86- 04.87	CS191	24 5.4
SL 200 12.0	(SL Series)[D2866UH]  [D2866UH]	06.84- 04.93	CA1237IR	28 140	06.84- 04.93	CS198	24 6.0
		06.84- 04.94	CA1237IR	28 140	06.84- 04.94	CS191	24 5.4
SM 152 6.9	(SM Series)[D0826OH02]  [D0826TOH]	11.87- 04.94	CA1237IR	28 140	11.87- 04.94	CS595	24 4.0
		11.87- 04.94	CA1237IR	28 140	11.87- 04.94	CS269	24 4.0
SM 182 6.9	(SM Series)[D0826LOH01]  [D0826TOH]	11.87- 02.95	CA1237IR	28 140	11.87- 02.95	CS269	24 4.0
		11.87- 02.95	CA1237IR	28 140	11.87- 02.95	CS595	24 4.0



**MAN Continued**

SM 192 6.9	(SM Series)[D0826LOH01]	11.87- 02.95	CA1035IR	28 80	11.87- 02.95	CS269	24 4.0
					11.87- 02.95	CS191	24 5.4
		11.87- 02.95	CA1237IR	28 140	11.87- 02.95	CS269	24 4.0
		11.87- 02.95	CA333IR	28 55	11.87- 02.95	CS595	24 4.0
		11.87- 02.95	CA854IR	28 35			
	[D0826TOH]	11.87- 02.95	CA1035IR	28 80	11.87- 02.95	CS191	24 5.4
		11.87- 02.95	CA1237IR	28 140	11.87- 02.95	CS595	24 4.0
		11.87- 02.95	CA333IR	28 55	11.87- 02.95	CS269	24 4.0
		11.87- 02.95	CA854IR	28 35			
SR 240 11.4	(SR Series)[D2566MUH/240]				10.75- 06.83	CS198	24 6.0
SR 280 11.4	(SR Series)[D2566MTUH]				01.77- 11.86	CS198	24 6.0
SR 321 11.4	(SR Series)[D2566MKUH]				03.82- 11.86	CS198	24 6.0
SU 240 11.4	(SU Series)[D2566MTUH]				11.82- 01.86	CS198	24 6.0
	[D2566MUH]				10.75- 01.86	CS198	24 6.0
	[D2566UH]				01.86- 09.89	CS198	24 6.0
SU 240 12.0	(SU Series)[D2866TOH]	01.86- 09.89	CA333IR	28 55	01.86- 09.89	CS198	24 6.0
		04.88- 09.89	CA1237IR	28 140			
	[D2866UH]				01.86- 09.89	CS198	24 6.0
SU 242 12.0	(SU Series)[D2866UH]	04.88- 04.93	CA1237IR	28 140	01.87- 04.93	CS198	24 6.0
SU 263 12.0	(SÜ Series)[D2866LUH25]	09.03-	CA1237IR	28 140	09.03-	CS191	24 5.4
		09.03-	CA1871IR	28 110	09.03-	CS198	24 6.0
SU 272 10.0	(SÜ Series)[D2865LUH02]	04.93- 05.95	CA1237IR	28 140	04.93- 05.95	CS191	24 5.4
					04.93- 05.95	CS198	24 6.0
SÜ 283 6.9	(SÜ Series)[D0836LOH02]	06.04-	CA1237IR	28 140	06.04-	CS191	24 5.4
		06.04-	CA1663IR	28 90	09.03-	CS1243	24 4.0
		06.04-	CA1695IR	28 55	06.04-	CS1267	24 4.0
SU 292 12.0	(SÜ Series)[D2866TOH]	04.92- 07.92	CA333IR	28 55	04.92- 04.93	CS191	24 5.4
SU 313 12.0	(SÜ Series)[D2866LUH24]	06.04- 09.06	CA1871IR	28 110	06.04- 09.06	CS191	24 5.4
					06.04- 09.06	CS198	24 6.0
SU 322 10.0	(SÜ Series)[D2865LUH08]	05.95- 06.97	CA1237IR	28 140	05.95- 06.97	CS198	24 6.0
					05.95- 06.97	CS191	24 5.4
ÜL 272 10.0	(ÜL Series)[D2865LUH02]	03.93- 07.94	CA1237IR	28 140	03.93- 07.94	CS198	24 6.0
					03.93- 07.94	CS191	24 5.4
	[D2865LUH05]	03.93- 09.95	CA1237IR	28 140	07.94- 09.95	CS191	24 5.4
ÜL 292 12.0	(ÜL Series)[D2866TUH01]	09.89- 03.93	CA333IR	28 55	09.89- 03.93	CS198	24 6.0
		11.92- 03.93	CA1237IR	28 140			
ÜL 312 10.0	(ÜL Series)[D2865LUH07]	04.92- 09.96	CA1237IR	28 140	09.95- 09.96	CS198	24 6.0
					09.95- 09.96	CS191	24 5.4
	[D2865LUH08]	04.92- 09.96	CA1237IR	28 140	04.92- 09.96	CS198	24 6.0
					04.92- 09.96	CS191	24 5.4
ÜL 313 12.0	(ÜL Series)[D2866LUH20]	09.96- 09.01	CA1237IR	28 140	09.96- 09.01	CS191	24 5.4
					09.96- 09.01	CS198	24 6.0
	[D2866LUH26]	09.96- 09.01	CA1237IR	28 140	09.96- 09.01	CS191	24 5.4
					09.96- 09.01	CS198	24 6.0
ÜL 322 10.0	(ÜL Series)[D2865LUH07]	04.92- 09.96	CA1237IR	28 140	04.92- 09.96	CS198	24 6.0
					04.92- 09.96	CS191	24 5.4
	[D2865LUH08]	04.92- 09.96	CA1237IR	28 140	04.92- 09.96	CS198	24 6.0
					04.92- 09.96	CS191	24 5.4
ÜL 342 12.0	(ÜL Series)[D2866UH/240]	11.92- 03.93	CA1237IR	28 140	09.89- 03.93	CS198	24 6.0
ÜL 353 12.0	(ÜL Series)[D2866LUH21]	06.97- 12.01	CA1237IR	28 140	06.97- 12.01	CS191	24 5.4
					06.97- 12.01	CS198	24 6.0

**Marshall**

**AGRICULTURE**

D 100 5.2 Diesel	[WD611.88]	01.90- 09.94	CA603IR	14 28			
		09.94-	CA238IR	14 55			
D 135 6.6 Diesel	[WD612.87]	01.90- 09.94	CA603IR	14 28			
		09.94-	CA238IR	14 55			
D 150 6.6 Diesel	[WD612.86]	01.90- 09.94	CA603IR	14 28			
		09.94-	CA238IR	14 55			
D 642 3.5 Diesel	[WD411.44]	01.90- 09.94	CA603IR	14 28			
		09.94-	CA238IR	14 55			
D 644 3.5 Diesel	[WD411.44]	01.90- 09.94	CA603IR	14 28			
		09.94-	CA238IR	14 55			
D 742 3.5 Diesel	[WD411.90]	01.90- 09.94	CA603IR	14 28			
		09.94-	CA238IR	14 55			
D 744 3.5 Diesel	[WD411.90]	01.90- 09.94	CA603IR	14 28			
		09.94-	CA238IR	14 55			
D 842 3.5 Diesel	[WD411.88]	01.90- 09.94	CA603IR	14 28			
		09.94-	CA238IR	14 55			
D 844 3.5 Diesel	[WD411.88]	01.90- 09.94	CA603IR	14 28			
		09.94-	CA238IR	14 55			
D 944 5.2 Diesel	[WD611.43]	01.90- 09.94	CA603IR	14 28			
		09.94-	CA238IR	14 55			

**Massey Ferguson**

**AGRICULTURE**

240 2.5		01.79- 12.88	CA23v	14 55	01.79- 12.88	CS109	12 2.0
		01.79- 12.88	CA1387IR	14 70	A13 01.79- 12.88	CS1032	12 2.8
245 2.5		01.79- 12.88	CA1387IR	14 70	01.77- 12.88	CS109	12 2.0
		01.77- 01.79	CA613IR	14 34	A13 01.77- 12.88	CS1032	12 2.8
		01.77- 12.88	CA23v	14 55			
254 2.5		01.73- 01.79	CA613IR	14 34			
		01.73- 12.88	CA23v	14 55			
		01.79- 12.88	CA1387IR	14 70			
255 2.5		01.77- 12.88	CA613IR	14 34	01.77- 12.88	CS109	12 2.0
		01.77- 12.88	CA23v	14 55	A13 01.77- 12.88	CS1032	12 2.8
		01.77- 12.88	CA1387IR	14 70			
260 3.3		01.77- 12.88	CA613IR	14 34	01.77- 12.88	CS107	12 2.1
		01.77- 12.88	CA23v	14 55			
265		01.81- 12.88	CA23v	14 55	01.81- 12.88	CS107	12 2.1
		01.81- 12.88	CA1387IR	14 70			
274 3.9		01.83- 12.88	CA23v	14 55	01.83- 12.88	CS201	12 2.8
		01.83- 12.88	CA1387IR	14 70			
275		01.75- 01.79	CA613IR	14 34	01.75- 12.88	CS107	12 2.1
		01.75- 12.88	CA23v	14 55			
		01.75- 12.88	CA1387IR	14 70			
284 3.9		01.73- 01.79	CA613IR	14 34			





		01.79- 12.88	CA1387IR	14 70					
285		01.75- 01.79	CA613IR	14 34		01.79- 12.88	CS946	12 2.1	
		01.79- 12.88	CA1387IR	14 70		A13 01.79- 12.88	CS994	12 2.8	
						01.75- 01.79	CS107	12 2.1	
350		01.86- 01.92	CA600IR	14 55		01.86- 01.92	CS109	12 2.0	
		01.86- 01.92	CA564IR	14 65		A13 01.86- 01.92	CS1032	12 2.8	
354		01.92- 01.97	CA226IR	14 55		01.92- 01.97	CS1032	12 2.8	
355		01.86- 01.92	CA600IR	14 55		01.86- 01.92	CS109	12 2.0	
		01.86- 01.92	CA564IR	14 65		A14 01.86- 01.92	CS1032	12 2.8	
360		01.87- 01.90	CA564IR	14 65		01.87- 01.90	CS1032	12 2.8	
		01.87- 01.90	CA600IR	14 55					
364		01.92- 01.97	CA226IR	14 55		01.92- 01.97	CS1032	12 2.8	
365		01.86- 01.90	CA564IR	14 65		01.86- 01.90	CS946	12 2.1	
		01.86- 01.90	CA600IR	14 55		A13 01.86- 01.90	CS994	12 2.8	
375		01.86- 01.97	CA564IR	14 65		A13 01.86- 01.97	CS994	12 2.8	
		01.86- 01.97	CA600IR	14 55		01.86- 01.97	CS946	12 2.1	
390		01.86- 01.97	CA600IR	14 55		01.86- 01.97	CS946	12 2.1	
		01.86- 01.97	CA564IR	14 65		A13 01.86- 01.97	CS994	12 2.8	
398		01.83- 01.84	CA96IR	14 55		A13 01.83- 01.84	CS994	12 2.8	
						01.83- 01.84	CS946	12 2.1	
399		01.86- 01.90	CA564IR	14 65		A13 01.86- 01.90	CS994	12 2.8	
		01.86- 01.90	CA600IR	14 55		01.86- 01.90	CS946	12 2.1	
565		01.82- 12.88	CA1387IR	14 70		01.82- 12.88	CS107	12 2.1	
575		01.76- 01.81	CA23v	14 55		01.76- 12.88	CS107	12 2.1	
		01.81- 12.88	CA1387IR	14 70					
2640		01.81- 01.85	CA1387IR	14 70		01.79- 01.85	CS623#	12 2.8	
		01.79- 01.81	CA23v	14 55					
3085		01.88- 01.93	CA1494IR	14 70		01.88-	CS693	12 2.4	
3635		01.92- 01.95	CA1383IR	14 70		01.92- 01.95	CS693	12 2.4	
3645		01.89- 01.91	CA1494IR	14 70		01.89- 01.91	CS703	12 2.8	
3650		01.86- 01.90	CA1387IR	14 70		01.86- 01.90	CS623#	12 2.8	
		01.86- 01.90	CA1382IR#	14 70					
3655		01.90- 01.95	CA1494IR	14 70		01.90- 01.95	CS703	12 2.8	
3680 7.4	[612DS]	06.88-	CA1387IR	14 70	PR	06.88-	CS703	12 2.8	
		06.88-	CA564IR	14 65	LU				
4245		01.97- 01.00	CA564IR	14 65					
4255		01.97- 01.00	CA564IR	14 65		01.97- 01.00	CS994	12 2.8	
4270						01.97-	CS201	12 2.8	
6110		01.92-	CA1382IR#	14 70					
		01.92-	CA1383IR	14 70					
6120		01.92-	CA1382IR#	14 70					
		01.92-	CA1383IR	14 70					
6130		01.92-	CA1382IR#	14 70					
		01.92-	CA1383IR	14 70					
6140		01.92-	CA1382IR#	14 70					
		01.92-	CA1383IR	14 70					
6150		01.92-	CA1382IR#	14 70					
		01.92-	CA1383IR	14 70					
6160		01.96-	CA1383IR	14 70	PR				
		01.96-	CA1494IR	14 70	LU				
6170	[6.365]	01.96-	CA1383IR	14 70	PR	01.96-	CS703	12 2.8	
		01.96-	CA1494IR	14 70	LU				
6180	[6.365]	01.96-	CA1383IR	14 70	PR	01.96-	CS703	12 2.8	
		01.96-	CA1494IR	14 70	LU				
6190		01.96-	CA1383IR	14 70	PR				
		01.96-	CA1494IR	14 70	LU				
6235							CS109	12 2.0	
6245							CS109	12 2.0	
6255							CS109	12 2.0	
6280		01.99-	CA1494IR	14 70					
6290		01.99-	CA1494IR	14 70					
8110		01.96-	CA1383IR	14 70					
8120	[6.365]	01.96-	CA1383IR	14 70		01.96-	CS703	12 2.8	
8130		01.96-	CA1383IR	14 70					
8140	[6.403]	01.96-	CA1383IR	14 70		01.96-	CS703	12 2.8	
8150	[6.403]	01.96-	CA1383IR	14 70		01.96-	CS703	12 2.8	
8160	[6.451]	01.96-	CA1383IR	14 70		01.96-	CS703	12 2.8	
8240						01.99-	CS703	12 2.8	
8240							CS703	12 2.8	
8250						01.99-	CS703	12 2.8	
8250						01.99-	CS703	12 2.8	
8260						01.99-	CS703	12 2.8	
8260							CS703	12 2.8	
8270						01.99-	CS703	12 2.8	
8280						01.99-	CS703	12 2.8	
390 T		01.91- 01.97	CA600IR	14 55		01.91- 01.97	CS946	12 2.1	
		01.91- 01.97	CA564IR	14 65		A13 01.91- 01.97	CS994	12 2.8	
						01.91- 01.97	CS107	12 2.1	
Various Models		01.51-	CG52	14 11					
		01.69-	CG58	14 22					
<b>Maybach</b>									
<b>PASSENGER CARS EU</b>									
Maybach 5.5 V12	[M285.950]					09.02-	CS1072	12 1.7	
						09.02-	CS360	12 1.7	
Maybach 6.0 V12						09.05-	CS1072	12 1.7	
<b>Mazda</b>									
<b>PASSENGER CARS EU</b>									
2 1.3	(DE)	10.07-	CA2042	14 90		10.07-	CS1469	12	
	[FUJA]	04.03-	CA1737IR	14 70		04.03-	CS1050	12 1.1	
		AC 04.03-	CA1780IR	14 90					
2 1.4 16V	[FXJA]	02.03-	CA1737IR	14 70		02.03-	CS1050	12 1.1	
		AC 02.03-	CA1780IR	14 90					
2 1.4 CD	[F6JA]	04.03-	CA1777IR	14 80		04.03-	CS1275	12 1.4	
		A19 04.03-	CA1778IR	14 150					
2 1.4 diesel MZR		A19 01.08-	CA1970IR	14 150		01.08-	CS1275	12 1.4	
		A19 01.08-	CA2091IR*	14 120					
2 1.5	(DE)	A19 10.07-	CA2042	14 90		10.07-	CS1469	12	
2 1.6 16V	[FYJA]	04.03-	CA1737IR	14 70		04.03-	CS1050	12 1.1	
		AC 04.03-	CA1780IR	14 90					
2 1.6 CD MZ		AC 10.08-	CA2091IR*	14 120		10.08-	CS1275	12 1.4	
		A19 10.08-	CA1970IR	14 150					
3 1.3		A19 10.03-	JA1898	14 80		10.03-	JS1361	12 1.0	
3 1.4		A19 02.04-	JA1898	14 80		02.04-	JS1361	12 1.0	



MAZDA Continued

3 1.6	[B6ZE]	10.03-	JA1898	14 80	10.03-	JS1361	12 1.0
	[Z6]	02.04-	JA1898	14 80	02.04-	JS1361	12 1.0
3 1.6 MZR	(BL)	06.09-	CA2042	14 90			
3 1.6 Diesel MZR-CD	(BL)				11.10-	CS1341	12 1.2
3 1.6 MZR-CD	(BL)	06.09-	CA1834IR	14 150	06.09-	CS1341	12 1.2
		06.09-	CA1865IR	14 120			
3 1.6 TD	[Y601]	06.04-	CA1834IR	14 150	06.04-	CS1341	12 1.2
		06.04-	CA1865IR	14 120			
3 1.6 Turbo Di	[Y601]	06.04-	CA1834IR	14 150	06.04-	CS1341	12 1.2
		06.04-	CA1865IR	14 120			
3 2.0	[LF17]	10.03-	JA1902	14 90	07.03-	JS1317	12 1.0
3 2.0 CD MRZ	[BK12][RF7J]	12.06-	CA1972	14 90	12.06-	JS1296	12 2.3
	[BK14][RF7J]	12.06-	CA1972	14 90	12.06-	JS1296	12 2.3
3 2.3 MPS	(BK14)				12.06-	CS1436	12 1.4
5 1.6 CD	(CR19)				09.10-	CS1341	12 1.2
5 1.8	[L823]	03.05-	JA1902	14 90	03.05-	JS1317	12 1.0
5 2.0	[LFF7]	03.05-	JA1902	14 90	03.05-	JS1317	12 1.0
5 2.0 Diesel Di	[RF7J]	06.05-	CA1972	14 90	06.05-	JS1296	12 2.3
		03.05-	CA1972	14 90	03.05-	JS1296	12 2.3
5 2.3	(CR19)	02.05-	JA1902	14 90	02.05-	JS1317	12 1.0
6 1.8	(GG)[L813]	06.04-	CA2014	14 100	08.02-	JS1317	12 1.0
		AC 08.02- 06.04	JA1705	14 90			
	[GY][L813]	AC 08.02-	JA1705	14 90	08.02-	JS1317	12 1.0
	[GH][L813]	02.08-	CA2014	14 100			
		08.07-	CA2014	14 100			
6 2.0	(GG)[LF17]	06.04-	CA2014	14 100	06.02-	JS1317	12 1.0
		AC 06.02- 06.04	JA1705	14 90			
	[LF18]	06.04-	CA2014	14 100	06.02-	JS1317	12 1.0
		AC 06.02- 06.04	JA1705	14 90			
	[LFF7]	03.05-	CA2014	14 100	03.05-	JS1317	12 1.0
	[GY][LF17]	AC 08.02-	JA1705	14 90	08.02-	JS1317	12 1.0
	[LF18]	AC 08.02-	JA1705	14 90	08.02-	JS1317	12 1.0
	[LFF7]	03.05-	CA2014	14 100	03.05-	JS1317	12 1.0
6 2.0 MRZ	(GH)	08.07-	CA2014	14 100			
6 2.0 MZR	(GH)[LF-DE]	01.10-	CA2014	14 100	08.07-	JS1296	12 2.3
		01.10-	CA2014	14 100			
6 2.0 CD MRZ	(GH)	08.07-	CA2071*	14 100			
6 2.0 CTD 4x4	(GY)[RF5C]	10.02- 02.05	JA1896IR	14 90	10.02- 02.05	JS1296	12 2.3
6 2.0 Diesel Di	(GG)[RF5C]	06.02-	JA1896IR	14 90	06.02-	JS1296	12 2.3
	[RF7J]	06.05-	CA1972	14 90	06.05-	JS1296	12 2.3
	[GY][RF5C]	08.02-	JA1896IR	14 90	06.02-	JS1296	12 2.3
	[RF7J]	06.05-	CA1972	14 90	06.05-	JS1296	12 2.3
6 2.3	(GG)[L3C1]	06.02-	JA1705	14 90	06.02-	CS1436	12 1.4
		12.05-	CA2014	14 100	12.05-	CS1436	12 1.4
	[GY][L3C1]	08.02-	JA1705	14 90	08.02-	CS1436	12 1.4
6 2.3 4WD	(GY)	AT 08.02-	JA1705	14 90	11.02-	CS1436	12 1.4
6 2.5 MRZ	(GH)	AT 08.07-	CA2014	14 100			
121 1.1	(DA)[B1]	10.87- 10.90	JA1271R	14 50	10.87- 10.90	JS633	12 0.85
	[B116]	04.89- 10.90	JA1271R	14 50	04.89- 10.90	JS633	12 0.85
	(DB)	11.90- 10.93	JA694IR	14 65	11.90- 10.93	JS633	12 0.85
121 1.2	(JA,JB)[DHF]	03.96-	CA1087IR	14 70	03.96-	CS971	12 1.1
	[DHG]	03.96-	CA1087IR	14 70	03.96-	CS971	12 1.1
121 1.3	(DA)[B3]				10.87- 10.90	JS633	12 0.85
	[JHC]	03.96-	CA1087IR	14 70	03.96-	CS971	12 1.1
	[JK]	03.96-	CA1087IR	14 70	03.96-	CS971	12 1.1
121 1.3 16V	(DB)[B3]	11.90- 03.96	JA694IR	14 65	AT 11.90- 03.96	JS1000	12 0.9
					11.90- 03.96	JS633	12 0.85
121 1.8 Diesel	[RTJ]	03.96-	CA1217IR	14 70	A13 03.96-	CS613	12 2.2
					03.96-	CS341	12 1.7
	[RTK]	03.96-	CA1217IR	14 70	A13 03.96-	CS613	12 2.2
					03.96-	CS341	12 1.7
323 1.1	(BD)[E1]	11.80- 10.85	JA1271R	14 50	11.80- 10.85	JS325	12 0.9
		11.80- 10.85	JA795IR	14 50			
	[BF][E1]	08.85- 04.90	JA129IR	14 55	08.85- 04.90	JS325	12 0.9
		Chas. -400000 09.85- 12.87	JA129IR	14 55			
323 1.3	(BD)[E3]	11.80- 10.85	JA1271R	14 50	11.80- 10.86	JS325	12 0.9
		11.80- 06.82	JA795IR	14 50	11.86- 10.89	JS640	12 0.85
		09.85- 04.87	JA129IR	14 55	11.80- 08.82	JS325	12 0.9
		05.87- 10.89	JA173IR	14 60			
		11.80- 10.89	JA1271R	14 50			
	[BF][E3]	09.85- 12.87	JA129IR	14 55	08.85- 05.89	JS640	12 0.85
		Chas. 400001- 04.87- 05.89	JA173IR	14 60			
		Chas. -400000 08.85- 04.87	JA129IR	14 55			
	[BG][B383]	09.89- 06.91	JA599IR	14 65	09.89- 06.91	JS640	12 0.85
	[B3E]	09.89- 07.94	JA599IR	14 65	09.89- 07.94	JS640	12 0.85
	[BW][E3]	07.86- 04.90	JA129IR	14 55	07.86- 04.90	JS640	12 0.85
323 1.3 16V	(BA)[B3]	10.96- 10.98	JA1283	14 70	10.96- 09.98	JS1136	12 1.0
					10.96-	JS1000	12 0.9
	[BG][B3]	09.89- 07.94	JA599IR	14 65	07.94- 07.94	JS1000	12 0.9
					09.89- 07.94	JS640	12 0.85
	[B][B3ME]	05.98- 01.01	JA1283	14 70	06.98- 01.01	JS1136	12 1.0
					05.98- 10.00	JS1000	12 0.9
323 1.3 i	[BF][B3]	09.85- 08.89	JA129IR	14 55	06.87- 05.89	JS640	12 0.85
		09.85- 08.89	JA173IR	14 60			
323 1.4	[BF][B3]	04.87- 07.89	JA599IR	14 65	04.87- 10.89	JS640	12 0.85
		09.87- 10.89	JA173IR	14 60			
323 1.5	(BD)[E5]	06.80- 12.85	JA1271R	14 50	06.80- 12.85	JS325	12 0.9
		06.80- 07.85	JA795IR	14 50			
	[E5 (OHC)]	06.80- 06.82	JA795IR	14 50	06.80- 06.82	JS325	12 0.9
		05.81- 07.85	JA1271R	14 50			
	[BF][B5]	04.87- 05.89	JA173IR	14 60	04.87- 10.89	JS640	12 0.85
		Chas. 400001- 05.87- 10.89	JA173IR	14 60			
	[E5]	Chas. 400001- 05.87- 05.89	JA173IR	14 60	08.85- 05.89	JS640	12 0.85
		Chas. -400000 08.85- 04.87	JA129IR	14 55			
	[BW][B5]	01.87- 05.89	JA173IR	14 60	01.87- 05.89	JS640	12 0.85
	[B50]	01.87- 04.90	JA173IR	14 60	01.87- 04.90	JS640	12 0.85
	[B53]	01.87- 04.90	JA173IR	14 60	01.87- 04.90	JS640	12 0.85
	[E5]	01.86- 06.87	JA129IR	14 55	01.86- 06.87	JS640	12 0.85
	[FA][D5]	04.82- 05.86	JA116IR	14 35			
323 1.5 16V	(BA)[Z5-DE]	10.96- 08.98	JA1283	14 70	10.96- 08.98	JS1136	12 1.0
	[B][ZL]	05.98- 01.01	JA1283	14 70	05.98- 01.01	JS1000	12 0.9
					05.98- 01.01	JS1136	12 1.0
					05.98- 01.01	JS325	12 0.9
323 1.5 i Turbo	[BF][E5E2]	08.85- 04.87	JA129IR	14 55	10.86- 05.89	JS640	12 0.85
		Chas. 400001- 04.87- 05.89	JA173IR	14 60			
323 1.5 i	[BF][E5E3]	08.85- 04.87	JA129IR	14 55	10.86- 05.89	JS640	12 0.85
		Chas. 400001- 04.87- 05.89	JA173IR	14 60			
323 1.6	[BF][B68]	09.87- 10.89	JA173IR	14 60	09.87- 10.89	JS640	12 0.85
	[BG][B6]	03.91- 10.94	JA599IR	14 65	03.91- 10.94	JS640	12 0.85
	[B6E]	09.89- 06.91	JA599IR	14 65	09.89- 06.91	JS640	12 0.85



	(BW)[B65M]	09.86- 06.87	JA1291R	14 55	06.87- 10.95	JS1000	12 0.9
		06.87- 10.95	JA1731R	14 60	09.86- 06.87	JS640	12 0.85
	[B68]	09.87- 10.89	JA1291R	14 55	09.87- 10.89	JS640	12 0.85
	[B6E]	09.86- 06.87	JA1291R	14 55	09.86- 06.87	JS640	12 0.85
		06.87- 10.95	JA1731R	14 60	06.87- 10.95	JS1000	12 0.9
323 1.6 4WD	(BW)[B65M]	05.90- 03.93	JA5991R	14 65	05.90- 03.93	JS640	12 0.85
	[B6E]	05.90- 03.93	JA5991R	14 65	05.90- 03.93	JS640	12 0.85
323 1.6 GT	(BF)[B6]	08.85- 04.87	JA1291R	14 55	08.85- 10.89	JS640	12 0.85
		Chas. 400001- 05.87- 10.89	JA1731R	14 60			
323 1.6 16V	(BG)[B6]	06.89- 10.94	JA5991R	14 65	06.89- 10.94	JS640	12 0.85
323 1.6 GTi	(BF)[B6]	01.86- 04.87	JA1291R	14 55	01.86- 12.88	JS640	12 0.85
		Chas. 400001- 05.87- 12.88	JA1731R	14 60			
323 1.6 Turbo	(BF)[B6]	Chas. 400001- 10.85- 11.91	JA1731R	14 60	10.85- 11.91	JS640	12 0.85
323 1.6 Turbo GT	(BF)[B6]	10.85- 07.87	JA1291R	14 55	10.85- 11.91	JS640	12 0.85
		Chas. 400001- 04.87- 11.91	JA1731R	14 60			
323 1.6 Turbo GT 4WD	(BF)[B6]	Chas. 400001- 08.87- 11.91	JA1731R	14 60	08.87- 11.91	JS640	12 0.85
323 1.7 Diesel	(BG)[PN46]	08.89- 03.91	JA6681R	14 65			
	[PN54]	08.89- 07.94	JA6681R	14 65			
	[PN62]	03.91- 07.94	JA6681R	14 65			
	(BW)[PN26]	10.89- 03.93	JA6681R	14 65			
	[PN54]	10.89- 03.93	JA6681R	14 65			
323 1.8	(BA)[BP/DOHC]	08.94- 09.98	JA1283	14 70	08.94- 09.98	JS1136	12 1.0
	(BG)[BP]	04.91- 07.94	JA5991R	14 65	04.91- 07.94	JS640	12 0.85
		04.91- 07.94	JA6991R	14 65			
323 1.8 4WD	(BG)[BPC]	01.91- 12.93	JA5991R	14 65	06.91- 05.94	JS1000	12 0.9
		01.91- 12.93	JA6991R	14 65	AT 06.91- 05.94	JS637	12 1.4
		02.94- 05.94	JA11881R	14 70			
323 1.8 16V	(BG)[BP]	08.89- 07.94	JA5991R	14 65	08.89- 07.94	JS640	12 0.85
		08.89- 07.94	JA6991R	14 65			
	[BP52]	09.91- 07.94	JA5991R	14 65	09.91- 07.94	JS640	12 0.85
		09.91- 07.94	JA6991R	14 65			
	(B)[FP]	05.98- 05.04	JA1409	14 80	AT 09.98- 05.04	CS1479*	12 1.2
					05.98- 05.04	JS1096	12 1.0
323 1.8 16V 4WD	(BG)[BP]	11.91- 12.93	JA5991R	14 65	11.91- 12.93	JS640	12 0.85
		11.91- 12.93	JA6991R	14 65			
	[BP52]	09.91- 07.94	JA6991R	14 65	09.91- 07.94	JS1000	12 0.9
323 1.8 Turbo 16V 4WD	(BG)[BP]	09.90- 07.94	JA5991R	14 65	09.90- 07.94	JS640	12 0.85
		09.90- 07.94	JA6991R	14 65			
323 2.0	(BA)[KF]	08.94- 09.98	JA8061R	14 90			
323 2.0 Diesel	(BA)[RF]	10.96- 09.98	JA15151R	14 80			
	[RF1 G]	10.96- 09.98	JA15151R	14 80	10.96- 09.98	JS1238	12 2.2
	(B)[RF]	09.98- 10.00	JA15151R	14 80	05.98- 10.00	JS1238	12 2.2
	[RF1 G]	05.98- 10.00	JA15151R	14 80	05.98- 10.00	JS1238	12 2.2
323 2.0 TD	(B)[RF]	07.98- 01.01	JA15151R	14 80	Chas. -128520 07.98- 01.01	JS1238	12 2.2
					09.98- 01.01	JS365	12 2.0
626 1.6	(CD)[H6]	08.80- 10.82	JA1251R	14 60			
	[N]	05.79- 08.80	JA1251R	14 60			
	[NA]	10.78- 12.82	JA1251R	14 60			
	(GC)[F6]	11.82- 07.85	JA1281R	14 65	11.82- 09.87	JS325	12 0.9
	(GD)[F68]	06.87- 05.92	JA5751R	14 70	06.87- 05.92	JS325	12 0.9
					06.87- 05.92	JS640	12 0.85
					06.87- 05.92	JS640	12 0.85
					06.87- 05.92	JS325	12 0.9
626 1.8	(GD)[F8]	09.87- 05.92	JA5751R	14 70	09.87- 05.92	JS640	12 0.85
	(GE)[FP]	08.91- 04.97	JA7551R	14 80	08.91- 04.97	JS637	12 1.4
					05.94- 04.97	JS1096	12 1.0
	(GF)[FP]	05.97- 03.02	JA1409	14 80	05.97- 03.02	JS1096	12 1.0
	[FP9A]	08.99- 03.02	JA1409	14 80	08.99- 03.02	JS1096	12 1.0
	(GF,GW)[FP9A]	08.99- 03.02	JA1409	14 80	08.99- 03.02	JS1096	12 1.0
	(GV)[F8]	03.88- 03.92	JA5751R	14 70	01.88- 03.92	JS640	12 0.85
	(GW)[FP]	10.97- 10.99	JA1409	14 80	10.97- 10.99	JS1096	12 1.0
626 1.8 i	(GE)[FP]	01.92- 04.97	JA7551R	14 80	01.92- 04.97	JS1096	12 1.0
						JS637	12 1.4
626 2.0	(CB)[MA]	10.78- 12.82	JA1251R	14 60			
	[HE3]	08.80- 10.82	JA1251R	14 60			
	[M]	05.79- 08.80	JA1251R	14 60			
	(GC)[FE]	03.83- 07.85	JA1281R	14 65	03.83- 09.87	JS325	12 0.9
					11.86- 09.87	JS325	12 0.9
	(GD)[FE]	09.87- 10.90	JA5751R	14 70	09.87- 10.90	JS640	12 0.85
					09.87- 10.90	JS637	12 1.4
	(GF)[FS]	05.97- 04.02	JA1409	14 80	05.97- 04.02	JS1096	12 1.0
					AT 05.97- 10.02	CS1479*	12 1.2
	[FS2C]	02.98- 10.02	JA1409	14 80	02.98- 10.02	JS1096	12 1.0
					AT 02.98- 10.02	CS1479*	12 1.2
	(GV)[FE]	10.88- 10.90	JA5751R	14 70	10.88- 10.90	JS637	12 1.4
					10.88- 10.90	JS640	12 0.85
	(GW)[FS]	02.98- 04.02	JA1409	14 80	02.98- 04.02	JS1096	12 1.0
	[FS2C]	02.98- 04.02	JA1409	14 80	02.98- 04.02	JS1096	12 1.0
626 2.0 4x4	(GD)	08.89- 07.91	JA5751R	14 70	08.89- 07.91	JS640	12 0.85
					08.89- 07.91	JS637	12 1.4
626 2.0 12V	(GD)[FE]	09.87- 05.92	JA5751R	14 70	09.87- 05.92	JS637	12 1.4
					09.87- 05.92	JS640	12 0.85
	(GV)[FE]	03.88- 03.92	JA5751R	14 70	03.88- 03.92	JS637	12 1.4
					03.88- 03.92	JS640	12 0.85
626 2.0 16V	(GD)[FE]	06.87- 05.92	JA5751R	14 70	07.87- 05.92	JS637	12 1.4
					06.87- 05.92	JS640	12 0.85
	(GV)[FE]	01.88- 03.92	JA5751R	14 70	01.88- 03.92	JS637	12 1.4
					01.88- 03.92	JS640	12 0.85
626 2.0 i	(GE)[FS]	08.91- 04.97	JA7551R	14 80	05.94- 04.97	JS1096	12 1.0
					08.91- 04.94	JS637	12 1.4
					11.94- 09.97	JA5751R	14 70
					11.94- 02.98	JS1096	12 1.0
626 2.0 i 4WD	(GE)[FS]	04.92- 04.97	JA7551R	14 80	04.92- 04.94	JS637	12 1.4
					05.94- 04.97	JS1096	12 1.0
626 2.0 Diesel	(GC)[RF46]				01.83- 06.87	JS365	12 2.0
	(GD)[RF-N]	07.87- 07.91	JA5761R	14 70	07.87- 07.91	JS365	12 2.0
	(GF)[RF]	04.98- 10.02	JA15151R	14 80	04.98- 10.02	JS1238	12 2.2
	(GV)[RF-N]	09.88- 07.91	JA5761R	14 70	09.88- 07.91	JS365	12 2.0
	(GW)[RF4F]	04.98- 10.02	JA15151R	14 80	04.98- 10.02	JS1238	12 2.2
	[RF65]				11.94- 02.98	JS365	12 2.0
626 2.0 Diesel Complex	(GV)[RF-CX]				05.93- 10.97	JS365	12 2.0
626 2.0 Diesel GLX Complex	(GE)[RF]	10.92- 04.97	JA8761R	14 75	10.92- 04.97	JS365	12 2.0
626 2.0 TD		10.00- 10.02	JA15151R	14 80	10.00- 10.02	JS1238	12 2.2
626 2.0 TDDi	(GF)[RF3F]	04.98- 10.02	JA15151R	14 80	09.99- 10.02	JS365	12 2.0
					04.98- 10.02	JS1238	12 2.2
	(GW)[RF3F]	09.99- 04.02	JA15151R	14 80	09.99- 04.02	JS365	12 2.0
626 2.2 12V	(GD)[F2]	11.87- 04.92	JA5751R	14 70	11.87- 04.92	JS640	12 0.85
					11.87- 04.92	JS637	12 1.4
	(GV)[F2]	03.89- 03.92	JA5751R	14 70	03.89- 03.92	JS640	12 0.85
					03.89- 03.92	JS637	12 1.4



MAZDA Continued

Table with columns for model name, engine/transmission, power, torque, and other specifications. Rows include models like 626 2.2 12V 4WD, 929 2.0, 323 C 1.4 16V, etc.



E 2200 2.2 Diesel 4WD	(SR2)[R2]	02.97- 12.01	JA1801R	14 65	02.97- 12.01	JS1238	12 2.2
	[R203]	03.91-	JA1801R	14 60	03.91-	JS365	12 2.0
		03.91-	JA5771R	14 50			
	[R207]	03.91-	JA1801R	14 60	03.91-	JS365	12 2.0
		03.91-	JA5771R	14 50			
MPV 2.0	(LW)[FS]	08.00- 07.02	JA1598	14 100	08.00- 07.02	JS1096	12 1.0
MPV 2.0 i 16V	(LW)[FS-DS]	06.99- 04.02	JA1598	14 100	06.99- 04.02	JS1096	12 1.0
MPV 2.0 Diesel Di	(LW)[RF5C]	07.02-	JA1896R	14 90	07.02-	JS1296	12 2.3
MPV 2.3	(LW)				07.02-	CS1436	12 1.4
MPV 2.5 TD	[WLT]	05.96- 09.99	JA15131R#	14 80			
MX-3 1.6	(EC)[B69]	07.91- 10.93	JA8771R	14 70	07.91- 10.93	JS640	12 0.85
MX-3 1.6 i	(EC)[B6D]	01.94- 01.98	JA11881R	14 70	01.94- 01.98	JS640	12 0.85
MX-3 1.8 i V6	(EC)[K819]	01.92- 01.94	JA8061R	14 90	01.92- 01.94	JS747	12 1.7
	[K838]	01.94- 09.96	JA8061R	14 90	01.94- 09.96	JS747	12 1.7
MX-5 1.6	(NA)[B64F]	08.89- 01.94	JA8051R	14 60	05.90- 01.94	JS1146	12 0.95
		05.90- 01.94	JA5991R	14 65	01.95- 04.98	JS1146	12 0.95
		01.95- 04.98	JA5991R	14 65			
		01.95- 04.98	JA8051R	14 60			
MX-5 1.6 16V	(NB)[B6D]	01.98- 07.05	JA1283	14 70	01.98- 07.05	JS1136	12 1.0
		01.98- 07.05	JA1409	14 80			
MX-5 1.8	(NA)[BPF1]	02.94- 04.98	JA11881R	14 70	02.94- 04.98	JS1146	12 0.95
	(NC)	03.05-	CA2014	14 100	03.05-	CS1493*	12
MX-5 1.8 16V	(NB)[BPZE]	08.00- 10.05	JA1409	14 80	01.98- 10.05	JS1136	12 1.0
		01.98- 08.00	JA1283	14 70			
MX-5 1.9 16V	(NB)[BPZE]	11.00- 10.05	JA1409	14 80	11.00- 10.05	JS1136	12 1.0
MX-5 2.0	(NC)	03.05-	CA2014	14 100	03.05-	CS1493*	12
MX-6 2.0	(GE)[FS]	07.91- 06.97	JA7551R	14 80	07.91- 06.97	JS637	12 1.4
		07.91- 06.97	JA8061R	14 90			
MX-6 2.5 24V	(GE)[KL]	07.91- 06.97	JA7551R	14 80	07.91- 06.97	JS747	12 1.7
		07.91- 06.97	JA8061R	14 90			
MX-6 2.5 i 24V	(GE)[KL]	08.94- 06.97	JA7551R	14 80			
		08.94- 06.97	JA8061R	14 90			
Premacy 1.8	(CP)[FP]	03.99- 01.05	JA1409	14 80	03.99- 01.05	JS1096	12 1.0
Premacy 2.0	(CP)[FS7E]	11.01-	JA1409	14 80	AT 07.99-	CS1479*	12 1.2
					AT 11.01-	CS1479*	12 1.2
					11.01-	JS1096	12 1.0
					11.01-	JS1096	12 1.0
					AT 11.01-	CS1479*	12 1.2
	[FS7G]	11.01-	JA1409	14 80			
Premacy 2.0 TD	(CP)[RF3F]	10.99- 07.00	JA15151R	14 80	10.99- 07.00	JS1238	12 2.2
	[RF4F]	07.00-	JA15151R	14 80	07.00-	JS1238	12 2.2
Tribute 3.0 V6 24V 4WD					03.00-	CS961	12 1.4
Xedos 6 1.6 16V	(CA)[B6]	06.94- 10.96	JA11881R	14 70	06.94- 02.99	JS1146	12 0.95
		10.96- 02.99	JA1283	14 70			
	[B69]	08.92- 05.94	JA8771R	14 70	08.92- 05.94	JS640	12 0.85
Xedos 6 2.0 i	(CA)[KF1]	01.92- 02.99	JA8061R	14 90	01.92- 05.94	JS747	12 1.7
Xedos 9 2.0 24V	[KF]				08.93- 01.00	JS747	12 1.7
Xedos 9 2.5 24V	(TA)[KL]				07.93- 07.00	JS747	12 1.7
<b>PASSENGER CARS US</b>							
323 1.6		01.88- 01.89	JA1731R	14 60	01.86- 01.94	JS325	12 0.9
		01.92- 01.94	JA6991R	14 65			
		01.86- 01.87	JA1291R	14 55			
323 1.6 DX		01.92- 01.94	JA6991R	14 65	01.92- 01.94	JS325	12 0.9
323 1.6 SE		01.92- 01.93	JA6991R	14 65	01.90- 01.93	JS325	12 0.9
		01.90- 01.91	JA5991R	14 65			
323 1.8 DX		01.90- 01.91	JA5991R	14 65	01.90- 01.91	JS325	12 0.9
323 1.8 LX		01.90- 01.91	JA5991R	14 65	01.90- 01.91	JS325	12 0.9
626 2.0		01.83- 01.85	JA1281R	14 65	01.99- 01.01	JS637	12 1.4
		01.79- 01.82	JA1251R	14 60	01.83- 01.87	JS325	12 0.9
					01.83- 01.87	JS365	12 2.0
626 2.0 DX					01.93- 01.98	JS637	12 1.4
626 2.0 ES					01.02- 01.02	JS637	12 1.4
626 2.0 LX					01.93- 01.02	JS637	12 1.4
626 2.0 Turbo					01.86- 01.87	JS365	12 2.0
626 2.0		01.84- 01.85	JA1281R	14 65	01.86- 01.87	JS325	12 0.9
					01.84- 01.85	JS325	12 0.9
					01.84- 01.85	JS365	12 2.0
626 2.2		01.88- 01.92	JA5751R	14 70	01.88- 01.92	JS637	12 1.4
626 2.2 DX		01.90- 01.92	JA5751R	14 70	01.90- 01.92	JS637	12 1.4
626 2.2 LX		01.90- 01.92	JA5751R	14 70	01.90- 01.92	JS637	12 1.4
626 2.2 Turbo		01.88- 01.91	JA5751R	14 70	01.88- 01.91	JS637	12 1.4
626 2.2 Turbo GT		01.90- 01.91	JA5751R	14 70	01.90- 01.91	JS637	12 1.4
626 2.5		01.99- 01.00	JA8061R	14 90	01.99- 01.01	JS747	12 1.7
626 2.5 ES		01.93- 01.98	JA8061R	14 90	01.93- 01.02	JS747	12 1.7
626 2.5 LX		01.94- 01.98	JA8061R	14 90	01.94- 01.02	JS747	12 1.7
B2000 2.0		01.82- 01.84	JA1161R	14 35	01.86- 01.87	JS325	12 0.9
B2200 2.2					01.87- 01.93	JS325	12 0.9
					01.87- 01.93	JS637	12 1.4
B2600 2.6		01.87- 01.88	JA1481R	14 45	01.87- 01.88	JS628	12 1.2
GLC 1.5		01.81- 01.85	JA7951R	14 50	01.81- 01.85	JS325	12 0.9
Miata 1.6		01.90- 01.93	JA8051R	14 60	01.90- 01.93	JS1146	12 0.95
Miata 1.8		01.94- 01.00	JA11881R	14 70	01.99- 01.02	JS1136	12 1.0
					01.94- 01.97	JS1146	12 0.95
Miata 1.8 LS					01.02- 01.03	JS1136	12 1.0
MX-3 1.6		01.92- 01.93	JA8771R	14 70	01.92- 01.95	JS325	12 0.9
		01.94- 01.95	JA11881R	14 70			
MX-3 1.6 Precedia					01.95- 01.95	JS325	12 0.9
MX-3 1.8		01.92- 01.94	JA8061R	14 90	01.92- 01.94	JS747	12 1.7
MX-3 1.8 GS		01.92- 01.94	JA8061R	14 90	01.92- 01.94	JS747	12 1.7
MX-6 2.0					01.93- 01.95	JS637	12 1.4
MX-6 2.0 RS					01.96- 01.97	JS637	12 1.4
MX-6 2.2		01.88- 01.92	JA5751R	14 70	01.88- 01.92	JS637	12 1.4
MX-6 2.2 DX		01.91- 01.92	JA5751R	14 70	01.91- 01.92	JS637	12 1.4
MX-6 2.2 LX		01.91- 01.92	JA5751R	14 70	01.91- 01.92	JS637	12 1.4
MX-6 2.2 Turbo		01.92- 01.92	JA5751R	14 70	01.92- 01.92	JS637	12 1.4
MX-6 2.2 Turbo GT		01.88- 01.92	JA5751R	14 70	01.88- 01.92	JS637	12 1.4
MX-6 2.5 LS		01.93- 01.97	JA8061R	14 90	01.93- 01.97	JS747	12 1.7
Portege 1.5 DX					01.96- 01.97	JS325	12 0.9
Portege 1.5 LX					01.96- 01.97	JS325	12 0.9
Portege 1.8 DX		01.91- 01.94	JA5991R	14 65	01.91- 01.94	JS325	12 0.9
					01.91- 01.94	JS637	12 1.4
Portege 1.8 ES		01.97- 01.97	JA1283	14 70	01.95- 01.96	JS325	12 0.9
					01.95- 01.97	JS1136	12 1.0
Portege 1.8 GT		01.90- 01.91	JA5991R	14 65	01.90- 01.91	JS637	12 1.4
					01.90- 01.91	JS325	12 0.9
Portege 1.8 LX		01.90- 01.94	JA5991R	14 65	01.90- 01.94	JS637	12 1.4
					01.90- 01.94	JS325	12 0.9
Portege 1.8 S					01.95- 01.95	JS325	12 0.9
					01.95- 01.95	JS1136	12 1.0
Portege 1.8 SE		01.90- 01.90	JA5991R	14 65	01.90- 01.90	JS637	12 1.4
					01.90- 01.90	JS325	12 0.9
Portege 1.5		01.95- 01.95	JA11881R	14 70	01.95- 01.95	JS325	12 0.9
Portege 1.5 DX		01.98- 01.98	JA1283	14 70	01.98- 01.98	JS325	12 0.9



**MAZDA Continued**

Protege 1.5 LX		01.98- 01.98	JA1283	14	70	01.98- 01.98	JS325	12	0.9
Protege 1.6		01.99- 01.01	JA1283	14	70	01.99- 01.01	JS325	12	0.9
						01.01- 01.01	JS1096	12	1.0
						01.99- 01.00	JS1136	12	1.0
Protege 1.8		01.99- 01.00	JA1409	14	80	01.99- 01.00	JS1096	12	1.0
Protege 1.8 4WD		01.90- 01.91	JA5991R	14	65	01.90- 01.91	JS325	12	0.9
						01.90- 01.91	JS637	12	1.4
Protege 1.8 ES		01.98- 01.98	JA1283	14	70	01.98- 01.98	JS1136	12	1.0
Protege 2.0		01.01- 01.01	JA1409	14	80	01.01- 01.01	JS1096	12	1.0
Protege 2.0 5		01.02- 01.03	JA1409	14	80	01.02- 01.02	JS1096	12	1.0
Protege 2.0 ES		01.02- 01.03	JA1409	14	80	01.02- 01.03	JS1096	12	1.0
Protege 2.0 LX		01.02- 01.03	JA1409	14	80	01.02- 01.03	JS1096	12	1.0
Protege 2.0 MP3		01.01- 01.02	JA1409	14	80	01.01- 01.02	JS1096	12	1.0
Protege 2.0 Turbo Mazdaspeed		01.03- 01.03	JA1409	14	80				
RX-7 1.1		01.83- 01.85	JA1251R	14	60				
RX-7 1.3 Turbo						01.93- 01.95	JS747	12	1.7
Tribute 2.0						01.01- 01.01	CS1058	12	1.5
Tribute 2.0 DX						01.02- 01.03	CS1058	12	1.5
						01.02- 01.03	CS1107	12	1.4
Tribute 3.0						01.01- 01.01	CS961	12	1.4
Tribute 3.0 ES						01.02- 01.03	CS961	12	1.4
Tribute 3.0 LX						01.02- 01.03	CS961	12	1.4
<b>PASSENGER CARS AO</b>									
2 1.3 L	(B2W)	AC 04.03-	CA1780IR	14	90	04.03-	CS1050	12	1.1
		AC 04.03-	CA1737IR	14	70				
2 1.5	(B2W)	AC 04.03-	CA1780IR	14	90	04.03-	CS1050	12	1.1
		AC 04.03-	CA1737IR	14	70				
3 2.3 MZR	(BK14)	AC				10.03- 09.04	CS1436	12	1.4
3 2.3 MZR Sport	(BK14)	AC				10.03-	CS1436	12	1.4
3 2.3 DiSi Turbo MPS	(BK14)	AC				06.06-	CS1436	12	1.4
626 2.0	(GF)	AC				AT 01.98- 10.02	CS1479*	12	1.2
626 2.0 GLX	(GV)	AC 04.92- 02.95	JA5751R	14	70	04.92- 02.95	JS637	12	1.4
323 S 1.5	(BJ)	AC 05.98- 05.04	JA1283	14	70	05.98- 05.04	JS1136	12	1.0
323 S 1.8 P	(BJ)	AC 05.98- 05.04	JA1409	14	80	05.98- 05.04	JS1096	12	1.0
		AC				05.98- 05.04	CS1479*	12	1.2
323 S 2.0 Astina	(BJ)	AC				02.00- 05.04	JS1096	12	1.0
		AC				AT 02.00- 05.04	CS1479*	12	1.2
323 S 2.0 Diesel	(BJ)[RF4F]	10.00- 10.02	JA1515IR	14	80	10.00- 10.02	JS1238	12	2.2
Demio 1.3	(DW)	02.03-	JA1283	14	70	02.03-	JS1136	12	1.0
Demio 1.5	(DW)	02.03-	JA1283	14	70	02.03-	JS1136	12	1.0
MX-5 1.8	(NA)[BPF1]	09.93- 12.97	JA1188IR	14	70	09.93- 12.97	JS1146	12	0.95
	(NB)	01.98- 10.05	JA1409	14	80	01.98- 10.05	JS1136	12	1.0
		01.98- 07.02	JA1283	14	70				
Premacy 2.0	(CP)	02.05-	JA1409	14	80	02.05-	JS1096	12	1.0
		02.05-	JA1409	14	80	02.05-	JS1096	12	1.0
Premacy 2.3 SVT	(CP)	02.05-	JA1409	14	80	02.05-	JS1096	12	1.0
						AT 02.05-	CS1479*	12	1.2
<b>Mercedes-Benz</b>									
<b>PASSENGER CARS EU</b>									
100 2.4 Diesel	(631)[OM616]	12.90- 02.96	CA2631R	14	80	12.90- 12.94	CS555	12	2.2
	[OM616.963]	12.90- 02.96	CA871R	14	55				
		09.87- 01.96	CA2631R	14	80	09.87- 01.96	CS555	12	2.2
		09.87- 01.96	CA871R	14	55				
	(631.340)[OM616.963]	09.87- 01.96	CA2631R	14	80	09.87- 01.96	CS555	12	2.2
		09.87- 01.96	CA871R	14	55				
190 2.0	(201)[M102.921]	10.82- 09.88	CA3211R	14	55	06.85- 09.88	CS327	12	1.4
		10.82- 09.88	CA871R	14	55	10.82- 05.85	CS268	12	1.5
	[M102.924]	09.84- 05.90	CA3211R	14	55	06.85- 05.90	CS327	12	1.4
		09.84- 08.86	CA871R	14	55	09.84- 05.85	CS268	12	1.5
		01.85- 03.85	CA2871R	14	70				
		04.85- 08.90	CA3451R	14	70				
		PS 01.86- 05.90	CA3451R	14	70				
190 2.0 Diesel	(201)[OM601.911]	08.83- 03.85	CA2871R	14	70	08.83- 08.93	CS331	12	2.2
		08.83- 08.93	CA3211R	14	55				
		04.85- 08.93	CA3451R	14	70				
190 2.5 Diesel	(201)[OM602.911]	04.85- 08.93	CA3211R	14	55	04.85- 08.93	CS331	12	2.2
		04.85- 08.93	CA3451R	14	70				
190 2.5 TD	(201)[OM602.961]	02.88- 08.93	CA3211R	14	55	02.88- 08.93	CS331	12	2.2
		02.88- 08.93	CA3451R	14	70				
200 1.8 Kompressor	(209)[M271.940]	09.02-	CA17521R	14	120	09.02-	CS1283	12	1.1
200 1.8 CGI	(209)[M271.942]	05.02-	CA17521R	14	120	05.02-	CS1283	12	1.1
200 2.0	(115)[M115.923]	08.73- 01.77	CA691R	14	35	01.68- 01.77	CS81	12	1.5
		02.75- 01.77	CA871R	14	55				
	[M115.926]	08.73- 01.77	CA691R	14	35	01.68- 01.77	CS81	12	1.5
		02.75- 01.77	CA871R	14	55				
	(123)[M102.920]	06.80- 11.85	CA1951R	14	65	06.80- 11.85	CS268	12	1.5
		06.80- 11.85	CA871R	14	55				
	[M102.939]	06.80- 11.85	CA1951R	14	65	06.80- 11.85	CS268	12	1.5
		06.80- 11.85	CA871R	14	55				
	[M115.938]	02.76- 08.80	CA691R	14	35	02.76- 08.80	CS81	12	1.5
		02.76- 08.80	CA871R	14	55				
	[M115.939]	02.76- 08.80	CA691R	14	35	02.76- 08.80	CS81	12	1.5
		02.76- 08.80	CA871R	14	55				
	(124)[M102.922]	09.85- 05.90	CA3211R	14	55	09.85- 05.90	CS327	12	1.4
		09.85- 05.90	CA3451R	14	70				
200 2.0 Kompressor	(208)[M111.956]	06.00- 01.03	CA13011R	14	90	06.00- 01.03	CS1075	12	1.2
		06.00- 06.02	CA20761R*	14	120				
200 2.0 Diesel	(115)[OM615.913]	08.73- 01.77	CA691R	14	35	01.68- 01.77	CS188	12	2.0
		02.75- 01.77	CA871R	14	55				
	(123)[OM615.940]	07.76- 02.79	CA691R	14	35	07.76- 11.85	CS188	12	2.0
		07.76- 11.85	CA871R	14	55				
		03.79- 11.85	CA1951R	14	65				
	(124)[OM601.912]	12.84- 06.93	CA3211R	14	55	12.84- 06.93	CS331	12	2.2
		04.85- 06.93	CA3451R	14	70				
200 2.0 TD	(124)[OM601.912]	09.85- 08.91	CA3211R	14	55	09.85- 08.91	CS331	12	2.2
		09.85- 08.91	CA3451R	14	70				
206 2.2 Diesel	(601)[OM615.917]					02.73- 12.77	CS113	12	2.0
	[OM615.937]					02.73- 12.77	CS113	12	2.0
	[OM615.939]					02.73- 12.77	CS113	12	2.0
207 2.4 Diesel	(601)[OM616.917]	04.77- 12.82	CA691R	14	35	04.77- 12.82	CS188	12	2.0
		04.77- 12.82	CA871R	14	55				
	[OM616.934]	04.77- 12.82	CA691R	14	35	04.77- 12.82	CS188	12	2.0
		04.77- 12.82	CA871R	14	55				
	[OM616.937]	06.82- 01.90	CA691R	14	35	06.82- 01.90	CS188	12	2.0
		06.82- 01.90	CA871R	14	55				
	[OM616.939]	06.82- 01.90	CA691R	14	35	06.82- 01.90	CS188	12	2.0
		06.82- 01.90	CA871R	14	55				
208 2.1 CDI	(901,902)[OM611.987]	04.00-	CA14811R	14	115	04.00-	CS1044	12	2.0
		04.00-	CA14891R	14	90				
		04.00-	CA16301R	14	150				



208 2.3	(601)[M115.955]	05.77- 12.82	CA69IR	14 35	05.77- 12.82	CS81	12 1.5									
		05.77- 12.82	CA87IR	14 55												
		05.77- 12.82	CA69IR	14 35												
		05.77- 12.82	CA87IR	14 55												
208 2.3 Diesel	(601)[OM601.940]	10.88- 06.95	CA1072IR	14 55	10.88- 06.95	CS576	12 2.2									
		10.88- 06.95	CA335IR	14 80												
		11.88- 06.95	CA1062IR	14 90												
		11.88- 06.95	CA1299IR	14 115												
		11.88- 06.95	CA1477IR	14 120												
		11.88- 06.95	CA321IR	14 55												
		Eng. 281647- 11.88- 06.95	CA1062IR	14 90												
		Eng. -281646 10.88- 06.95	CA335IR	14 80												
		ACPS 10.88- 06.95	CA1062IR	14 90												
		ACPS 10.88- 06.95	CA321IR	14 55												
		ACPS 11.88- 06.95	CA335IR	14 80												
		AC, PS, Eng. 281647 10.88- 06.95	CA1062IR	14 90												
		AC, PC, Eng. 281647 10.88- 06.95	CA1062IR	14 90												
		209 3.0 Diesel	(601)[OM617.913]	12.82- 01.90				CA87IR	14 55	12.82- 01.90	CS188	12 2.0				
		210 2.3	(601)[M102.942]	04.77- 10.89				CA321IR	14 55	04.77- 01.90	CS268	12 1.5				
				04.77- 10.89				CA335IR	14 80							
				04.77- 10.89				CA345IR	14 70							
				04.77- 10.89				CA87IR	14 55							
				Eng. 102945- 04.85- 06.95				CA321IR	14 55							
				Eng. 102945- 04.85- 06.95				CA345IR	14 70							
				Eng. -102942 07.82- 03.85				CA87IR	14 55							
Eng. -016466 07.82- 01.90	CA335IR			14 80												
AT, Eng. -002087 07.82- 01.90	CA335IR			14 80												
[M102.945]	04.85- 06.95			CA321IR	14 55	10.87- 06.95	CS268	12 1.5								
04.85- 06.95	CA345IR			14 70												
10.87- 05.89	CA335IR			14 80												
05.89- 06.95	CA263IR			14 80												
Eng. -016466 10.87- 06.95	CA335IR			14 80												
[M102.946]	Eng. 102945- 04.85- 06.95			CA321IR	14 55				07.82- 01.90				CS268	12 1.5		
Eng. 102945- 04.85- 01.90	CA345IR			14 70												
Eng. -102942 07.82- 03.85	CA87IR			14 55												
Eng. -016466 07.82- 01.90	CA335IR			14 80												
[M115.955]	04.77- 10.89	CA321IR	14 55	04.77- 10.89	CS268					12 1.5						
04.77- 10.89	CA335IR	14 80														
04.77- 10.89	CA345IR	14 70														
04.77- 10.89	CA87IR	14 55														
210 2.9 Diesel	(601)[OM602.940]	10.88- 06.95	CA1072IR								14 55	10.88- 06.95			CS576	12 2.2
		10.88- 06.95	CA335IR								14 80					
		Eng. 277089- 11.88- 06.95	CA1062IR								14 90					
		Eng. -277088 11.88- 06.95	CA335IR								14 80					
		ACPS 10.88- 06.95	CA321IR								14 55					
		AC, PS, Eng. 277089 10.88- 06.95	CA1062IR			14 90										
211 2.1 CDi	(901.902)[OM611.981]	04.00-	CA1481IR			14 115	04.00-	CS1044			12 2.0					
		04.00-	CA1489IR			14 90										
		04.00-	CA1630IR			14 150										
213 2.1 CDi	(901.902)[OM611.981]	04.00-	CA1481IR			14 115	04.00-	CS1044			12 2.0					
		04.00-	CA1489IR			14 90										
		04.00-	CA1630IR			14 150										
216 2.7 CDi	(901.902)[OM612.981]	04.00-	CA1481IR			14 115	04.00-	CS1202	12 2.3							
		04.00-	CA1489IR			14 90										
		04.00-	CA1630IR	14 150												
220 2.2	(115)[M115.920]				01.68- 07.73	CS81	12 1.5									
		[M115.924]														
220 2.2 Diesel	(115)[OM615.912]	01.68- 01.77	CA69IR	14 35	01.68- 01.77	CS188	12 2.0									
		01.68- 01.77	CA87IR	14 55												
		(123)[OM615.941]	01.76- 03.79	CA69IR				14 35								
		01.76- 03.79	CA87IR	14 55												
230 2.3	(123)[M115.954]	02.76- 03.81	CA69IR	14 35	02.76- 03.81	CS81	12 1.5									
		02.76- 03.81	CA87IR	14 55												
230 2.3 Kompressor	(208)[M111.982]	06.00- 06.02	CA1732IR	14 90	06.00- 06.02	CS1075	12 1.2									
		06.00- 06.02	CA2076IR*	14 120												
240 2.4 Diesel	(115)[OM616.916]	08.73- 01.77	CA69IR	14 35	08.73- 01.77	CS188	12 2.0									
		08.73- 01.77	CA87IR	14 55												
		(123)[OM616.912]	02.76- 02.79	CA69IR				14 35								
		02.76- 11.85	CA87IR	14 55												
240 2.4 TD	(123)[OM616.912]	09.77- 12.85	CA87IR	14 55	09.77- 12.85	CS188	12 2.0									
240 2.6	(209)[M112.912]	06.02-	CA1872IR	14 120	05.02-	CS1249	12 1.4									
240 3.0 Diesel	(115)[OM617.910]	08.74- 11.76	CA69IR	14 35	08.74- 11.76	CS188	12 2.0									
		08.74- 11.76	CA87IR	14 55												
250 2.5	(114)[M114.920]	01.68- 08.72	CA87IR	14 55	01.68- 08.72	CS81	12 1.5									
		(123)[M123.921]	02.76- 07.85	CA87IR				14 55								
250 2.5 Diesel	(124)[OM602.912]	04.85- 06.93	CA321IR	14 55	04.85- 06.93	CS331	12 2.2									
		04.85- 06.93	CA345IR	14 70												
250 2.5 TD	(124)[OM602.912]	09.85- 06.93	CA321IR	14 55	09.85- 06.93	CS331	12 2.2									
		09.85- 06.93	CA345IR	14 70												
		[OM602.962]	04.85- 06.93	CA321IR				14 55								
		04.85- 06.93	CA345IR	14 70												
250 2.8	(114)[M130.923]	06.72- 07.73	CA70#	14 55	06.72- 11.76	CS81	12 1.5									
		08.73- 11.76	CA87IR	14 55												
280 2.7	(114)[M110.921]	06.72- 11.76	CA87IR	14 55	06.72- 11.76	CS81	12 1.5									
		(123)[M110.923]	02.76- 08.81	CA87IR				14 55								
		03.78- 08.81	CA195IR	14 65												
300 3.0 Diesel	(123)[OM617.912]	02.76- 11.85	CA87IR	14 55	02.76- 11.85	CS188	12 2.0									
		(124)[OM603.912]	12.84- 06.93	CA321IR				14 55								
			04.85- 06.93	CA345IR				14 70								
		[OM603.960]	01.89- 06.93	CA345IR				14 70								
		[OM603.963]	09.86- 01.89	CA345IR				14 70								
300 3.0 Diesel 4 Matic	(124)[OM603.913]	09.86- 06.93	CA321IR	14 55	09.86- 06.93	CS331	12 2.2									
		09.86- 06.93	CA345IR	14 70												
300 3.0 TD	(123)[OM617.952]	10.80- 11.85	CA87IR	14 55	10.80- 11.85	CS188	12 2.0									
		(124)[OM603.960]	09.86- 06.93	CA345IR				14 70								
			09.88- 06.93	CA321IR				14 55								
		[OM603.963]	01.88- 06.93	CA345IR				14 70								
300 3.0 TD 4 Matic	(124)[OM603.960]	01.89- 06.93	CA321IR	14 55	01.89- 06.93	CS331	12 2.2									
		01.89- 06.93	CA345IR	14 70												
		[OM603.963]	09.86- 01.89	CA321IR				14 55								
		09.86- 09.93	CA345IR	14 70												
307 2.4 Diesel	(602)[OM616.937]	04.77- 01.90	CA69IR	14 35	04.77- 01.90	CS188	12 2.0									
		04.77- 01.90	CA87IR	14 55												
		[OM616.939]	06.82- 01.90	CA69IR				14 35								
		06.82- 01.90	CA87IR	14 55												



MERCEDES-BENZ Continued

308 2.1 CDi	(903)[OM611.987]	04.00-04.00-04.00	CA1481IR CA1489IR CA1630IR	14 115 14 90 14 150	04.00-	CS1044	12 2.0		
308 2.3 Diesel	(601)[OM601.940]	10.88-06.95 Eng. 281647-06.89-06.95 Eng. -281646 10.88-06.96 ACPS 10.88-06.95 AC, PS, Eng. 281647 11.88-06.95	CA1072IR CA1062IR CA335IR CA321IR CA1062IR	14 55 14 90 14 80 14 55 14 90	10.88-06.95	CS576	12 2.2		
	(602)[OM601.940]	10.88-02.96 10.88-06.95 Eng. 281647-10.88-06.95 Eng. -281646 10.88-06.95 ACPS 05.90-06.95 AC, PS, Eng. 281647 06.89-02.96 AC, PS, Eng. -06.89-281646 02.96	CA1072IR CA321IR CA1062IR CA335IR CA321IR CA1062IR CA335IR	14 55 14 55 14 90 14 80 14 55 14 90 14 80	10.88-02.96	CS576	12 2.2		
309 3.0 Diesel	(602)[OM617.913]	10.82-01.90	CA87IR	14 55	10.82-01.90	CS188	12 2.0		
310 2.9 Diesel	(601)[OM602.940]	10.88-06.95 10.88-06.95 Eng. 277089-10.88-06.95 Eng. -277088 10.88-06.95 ACPS 10.88-06.95 AC, PS, Eng. 277089 06.89-06.95	CA1057IR CA1072IR CA1062IR CA335IR CA321IR CA1062IR	14 120 14 55 14 90 14 80 14 55 14 90	10.88-06.95	CS576	12 2.2		
	(602)[OM602.940]	10.88-06.95 10.88-06.95 10.88-06.95 Eng. 277089-10.88-06.95 Eng. -277088 10.88-06.95 AC, Eng. 277089-06.89-06.95	CA1057IR CA1072IR CA321IR CA1062IR CA335IR CA1062IR	14 120 14 55 14 55 14 90 14 80 14 90	10.88-06.95	CS576	12 2.2		
311 2.1 CDi	(903)[OM611.981]	04.00-04.00-04.00	CA1481IR CA1489IR CA1630IR	14 115 14 90 14 150	04.00-	CS1044	12 2.0		
313 2.1 CDi	(903)[OM611.981]	04.00-04.00-04.00	CA1481IR CA1489IR CA1630IR	14 115 14 90 14 150	04.00-	CS1044	12 2.0		
316 2.7 CDi	(903)[OM612.981]	04.00-04.00-04.00	CA1481IR CA1489IR CA1630IR	14 115 14 90 14 150	04.00-04.00-	CS1044 CS1202	12 2.0 12 2.3		
		05.02-	CA1872IR	14 120	05.02-	CS1249	12 1.4		
405 2.2 Diesel	(T2/L)[OM615.915] [OM621]				01.72-12.80 03.75-02.78	CS113 CS113	12 2.0 12 2.0		
406 2.2 Diesel	(T2/L)[OM615.910]				01.68-12.74	CS113	12 2.0		
407 2.4 Diesel	(T1/TN)[OM616.913] (T2/L)[OM616.910]	07.81-01.89 01.75-08.82	CA87IR CA69IR	14 55 14 35	07.81-01.89 01.75-12.88	CS188 CS113	12 2.0 12 2.0		
408 2.0	(T2/L)[M115.I]				01.68-12.72	CS81	12 1.5		
	[M115.II]				01.68-12.72	CS81	12 1.5		
408 2.2	(T2/L)[M115.921]				01.68-12.74	CS81	12 1.5		
	[M115.927]				08.72-12.74	CS81	12 1.5		
	[M115.928]				08.72-12.74	CS81	12 1.5		
	[M115.929]				08.72-12.74	CS81	12 1.5		
408 2.3	(T2/L)[M115.952]	01.75-08.82 01.75-08.82	CA69IR CA87IR	14 35 14 55	01.75-08.82	CS81	12 1.5		
		11.88-06.95 12.93-06.95 PS 11.88-06.95 ACPS 11.88-06.95 AC 11.88-06.95 AC 11.88-06.95	CA1072IR CA263IR CA335IR CA321IR CA1062IR CA335IR	14 55 14 80 14 80 14 55 14 90 14 80	11.88-06.95	CS576	12 2.2		
408 3.8	(T2/L)[OM314.948]				02.73-12.74 01.70-01.73	CS120 CS194	24 4.0 24 4.5		
409 2.2	(T2/L)[M115.921]				01.68-12.74	CS81	12 1.5		
409 2.3	(T2/L)[M115.952]	01.75-08.82 01.75-08.82	CA69IR CA87IR	14 35 14 55	01.75-08.82	CS81	12 1.5		
409 2.4 Diesel	(T1/TN)[OM617.913]	04.82-01.89	CA87IR	14 55	04.82-01.89	CS188	12 2.0		
409 3.0 Diesel	(T1/TN)[OM617.913]	04.82-01.89	CA87IR	14 55	04.82-01.89	CS188	12 2.0		
410 2.3	(T1/TN)[M102.942]	08.82-06.95 08.82-06.95 08.82-06.95 04.85-06.95	CA263IR CA335IR CA87IR CA321IR CA345IR	14 80 14 80 14 55 14 55 14 70	08.82-06.95	CS1075	12 1.2		
		[M102.945]	08.82-06.95 08.82-03.85 04.85-06.95 04.85-06.95 12.93-06.95	CA335IR CA87IR CA321IR CA345IR CA263IR	14 80 14 55 14 55 14 70 14 80	08.82-06.95	CS1075	12 1.2	
		(T2/L)[M102.943]	08.82-12.88 08.82-12.88	CA195IR CA87IR	14 65 14 55	08.82-12.88	CS268	12 1.5	
		11.88-06.95 11.88-06.95 11.88-06.95 ACPS 11.88-06.95	CA1062IR CA1072IR CA335IR CA321IR	14 90 14 55 14 80 14 55	11.88-06.95	CS576	12 2.2		
	500 5.0	(209)[M113.968]				05.02-07.06	CS1072	12 1.7	
	507 2.4 Diesel	(T2/LN1)[OM616.914]	04.86-04.89 04.86-04.89	CA195IR CA87IR	14 65 14 55	04.86-04.89	CS188	12 2.0	
	508 2.3 Diesel	(T2/LN1)[OM601.941]	03.89-02.01 12.93-02.01	CA1072IR CA263IR	14 55 14 80	03.89-02.01	CS331	12 2.2	
ACPS 03.89-03.94 ACPS 03.89-02.01			CA321IR CA335IR	14 55 14 80					
508 3.8	(T2/L)[OM314.946]	06.72-08.82 09.72-06.88 09.72-12.88 09.72-06.88 11.86-12.88	CA186IR CA187IR CA568IR CA854IR CA333IR	14 55 28 27 28 30 28 35 28 55	02.73-12.88 01.70-03.73	CS120 CS194	24 4.0 24 4.5		
		[OM314.948]	06.72-06.88 09.82-10.86 11.86-12.88 11.86-12.88	CA186IR CA187IR CA333IR CA568IR	14 55 28 27 28 55 28 30	01.70-03.73 02.73-12.88	CS194 CS120	24 4.5 24 4.0	
		[OM314.959]	09.72-06.88	CA186IR	14 55				
		[OM314.962]	09.72-06.88	CA333IR	28 55				
		[OM314.963]	09.72-06.88 09.72-06.88 09.72-06.88 09.72-06.88	CA187IR CA568IR CA854IR	28 27 28 30 28 35				
	510 2.3	(T2/LN1)[M102.946]	04.86-03.94 04.86-02.01 04.86-02.01 12.93-02.01	CA321IR CA335IR CA345IR CA263IR	14 55 14 80 14 70 14 80	04.86-02.01	CS268	12 1.5	
			[OM602.984]	09.96-01.01 09.96-01.01	CA1209IR CA1299IR	14 90 14 115	09.96-01.01	CS1044	12 2.0





608 3.8	(T2/L)[OM314.946] [OM314.948]	Chas. 059069- 02.84- 12.88		CA186IR	14 55	Chas. 017518- 01.70- 12.88	CS194	24 4.5
		04.81- 08.82	CA186IR	14 55				
		09.82- 10.86	CA187IR	28 27				
		09.82- 12.88	CA333IR	28 55				
		11.86- 12.88	CA568IR	28 30				
	[OM314.961]	02.84- 12.88	CA1035IR	28 80				
	[OM314.963]	02.84- 12.88	CA333IR	28 55				
	[OM314.967]	02.84- 12.88	CA187IR	28 27				
	[OM314.967]	02.84- 12.88	CA568IR	28 30				
	[OM314.967]	02.84- 12.88	CA854IR	28 35				
609 4.0	(T2/LN1)[OM364.906] [OM364.919]	04.86- 02.01	CA854IR	28 35	04.86- 02.01	CS1279	24 4.0	
		06.94- 02.01	CA1735IR	14 55				
	[OM364.919]	04.86- 09.01	CA854IR	28 35	04.86- 09.01	CS1279	24 4.0	
611 4.0	(T2/LN1)[OM354.901] [OM354.902]	06.94- 09.01	CA1735IR	14 55	06.94- 09.01	CS1279	24 4.0	
		06.94- 09.01	CA854IR	28 35				
	[OM354.902]	06.94- 09.01	CA1035IR	28 80	06.94- 09.01	CS1112	24 4.0 BO	
612 2.9	[OM602.985]	09.96- 04.00	CA1735IR	14 55	09.96- 04.00	CS1381	24 4.0 DR	
613 4.3	[OM904.908]	09.96- 04.00	CA1505IR	28 100	09.96- 04.00	CS1279	24 4.0	
613 5.7	(T2/L)[OM353.963] [OM353.966]	09.96- 04.00	CA1593IR	28 80				
		08.79- 08.82	CA186IR	14 55	04.77- 12.88	CS186	12 3.0	
	[OM353.966]	08.79- 08.82	CA187IR	28 27				
614 4.3	[OM904.908]	09.96- 01.01	CA333IR	28 55				
		09.96- 01.01	CA568IR	28 30				
	[OM904.908]	09.96- 01.01	CA1505IR	28 100	09.96- 01.01	CS1112	24 4.0 BO	
615 4.3	[OM904.923]	09.96- 01.01	CA1593IR	28 80	09.96- 01.01	CS1381	24 4.0 DR	
		09.96- 01.01	CA1666IR	28 80				
	[OM904.923]	09.98- 01.01	CA1505IR	28 100	09.98- 01.01	CS1112	24 4.0 BO	
616 4.3	[OM904.923]	09.98- 01.01	CA1593IR	28 80	09.98- 01.01	CS1381	24 4.0 DR	
		09.98- 01.01	CA1666IR	28 80				
	[OM904.923]	09.98- 01.01	CA1505IR	28 100	09.98- 01.01	CS1112	24 4.0	
709 4.0	(T2/LN1)[OM364.906] [OM364.912]	09.98- 09.98	CA1593IR	28 80				
		04.86- 02.01	CA1035IR	28 80	04.86- 02.01	CS1279	24 4.0	
	[OM364.912]	04.86- 02.01	CA333IR	28 55	04.86- 02.01	CS1279	24 4.0	
711 4.0	(T2/LN1)[OM354.902] [OM354.903]	04.86- 02.01	CA854IR	28 35				
		04.86- 02.01	CA1035IR	28 80	04.86- 02.01	CS120	24 4.0	
	[OM354.903]	04.86- 02.01	CA1735IR	14 55	06.94- 02.01	CS120	24 4.0	
714 4.0	[OM364.950]	06.94- 02.01	CA333IR	28 55				
		06.94- 02.01	CA854IR	28 35				
	[OM364.950]	06.94- 02.01	CA1035IR	28 80	06.94- 02.01	CS120	24 4.0	
714 4.0	[OM364.952]	06.94- 02.01	CA1735IR	14 55				
		06.94- 02.01	CA333IR	28 55				
	[OM364.952]	06.94- 02.01	CA854IR	28 35	06.94- 02.01	CS120	24 4.0	
714 4.0	[OM364.957]	02.92- 02.01	CA1035IR	28 80	02.92- 02.01	CS1279	24 4.0	
		02.92- 02.01	CA854IR	28 35				
	[OM364.957]	02.92- 02.01	CA854IR	28 35	02.92- 02.01	CS1279	24 4.0	
809 4.0	(T2/LN1)[OM364.906] [OM364.911]	06.94- 02.01	CA1035IR	28 80	06.94- 02.01	CS120	24 4.0	
		06.94- 02.01	CA1735IR	14 55				
	[OM364.911]	06.94- 02.01	CA333IR	28 55	04.86- 02.01	CS1279	24 4.0	
810 4.0	[OM364.920]	04.86- 02.01	CA854IR	28 35				
		04.86- 02.01	CA1035IR	28 80	04.86- 02.01	CS1279	24 4.0	
	[OM364.920]	04.86- 12.94	CA1735IR	14 55	04.86- 12.94	CS1279	24 4.0	
810 4.0	[OM364.921]	04.86- 12.94	CA333IR	28 55				
		04.86- 12.94	CA854IR	28 35				
	[OM364.921]	02.92- 12.94	CA1035IR	28 80	02.92- 12.94	CS1279	24 4.0	
810 4.0	[OM364.925]	02.92- 12.94	CA1735IR	14 55				
		02.92- 12.94	CA333IR	28 55				
	[OM364.925]	02.92- 12.94	CA854IR	28 35	02.92- 12.94	CS1279	24 4.0	
810 4.0	[OM364.925]	02.92- 12.94	CA1035IR	28 80				
		02.92- 12.94	CA1735IR	14 55				
	[OM364.925]	02.92- 12.94	CA333IR	28 55	04.86- 12.94	CS1279	24 4.0	
810 4.0	[OM364.925]	02.92- 12.94	CA854IR	28 35				
		02.92- 12.94	CA1035IR	28 80				
	[OM364.925]	02.92- 12.94	CA1735IR	14 55	04.86- 12.94	CS1279	24 4.0	
810 4.0	[OM364.925]	02.92- 12.94	CA333IR	28 55				
		02.92- 12.94	CA854IR	28 35				
	[OM364.925]	02.92- 12.94	CA1035IR	28 80	04.86- 12.94	CS1279	24 4.0	
812 2.9	[OM602.985]	09.96- 09.06	CA1209IR	14 90	09.96- 09.06	CS1044	12 2.0	
		09.96- 09.06	CA1299IR	14 115				
	[OM602.985]	09.96- 09.06	CA1299IR	14 115				
812 4.3	[OM904.908]	09.96- 01.01	CA1505IR	28 100	09.96- 01.01	CS1112	24 4.0 BO	
		09.96- 01.01	CA1593IR	28 80	09.96- 01.01	CS1381	24 4.0 DR	
	[OM904.923]	09.96- 01.01	CA1505IR	28 100	09.96- 01.01	CS1112	24 4.0 BO	
813 4.3	[OM904.908]	09.96- 01.01	CA1593IR	28 80	09.96- 01.01	CS1381	24 4.0 DR	
		09.96- 01.01	CA1505IR	28 100	09.96- 01.01	CS1112	24 4.0	
	[OM904.908]	09.96- 01.01	CA1593IR	28 80	09.96- 01.01	CS1112	24 4.0	
814 4.0	(T2/LN1)[OM354.924] [OM354.925]	09.96- 09.96	CA1505IR	28 100				
		04.86- 12.94	CA333IR	28 55	04.86- 12.94	CS1279	24 4.0	
	[OM354.925]	04.86- 12.94	CA854IR	28 35				
814 4.0	[OM354.925]	11.87- 12.94	CA333IR	28 55	11.87- 12.94	CS1279	24 4.0	
		11.87- 12.94	CA854IR	28 35				
	[OM354.925]	11.87- 12.94	CA854IR	28 35	11.87- 02.01	CS1279	24 4.0	

**MERCEDES-BENZ** *Continued*

	[OM364.984]	01.91- 12.94	CA854IR	28 35	01.91- 12.94	CS1279	24 4.0
	[OM364.986]	11.87- 12.94	CA854IR	28 35	11.87- 12.94	CS1279	24 4.0
	[OM364.987]	02.92- 12.94	CA854IR	28 35	02.92- 12.94	CS1279	24 4.0
814 4.3	[OM904.908]	09.96- 01.01	CA1505IR	28 100	09.96- 01.01	CS1112	24 4.0 BO
		09.96- 01.01	CA1593IR	28 80	09.96- 01.01	CS1381	24 4.0 DR
		09.96-	CA1666IR	28 80			
815 4.3	[OM904.923]	09.96- 01.01	CA1505IR	28 100	09.96- 01.01	CS1112	24 4.0 BO
		09.96- 01.01	CA1593IR	28 80	09.96- 01.01	CS1381	24 4.0 DR
		09.96-	CA1666IR	28 80			
816 4.3	[OM904.923]	09.96-	CA1505IR	28 100	09.96-	CS1112	24 4.0
		09.96-	CA1593IR	28 80			
190 E 1.8	(201)[M102.910]	04.90- 08.93	CA714IR	14 80	04.90- 08.93	CS327	12 1.4
		04.90- 08.93	CA833IR	14 70			
190 E 2.0	(201)[M102.961]	10.82- 08.86	CA321IR	14 55	09.84- 08.89	CS327	12 1.4
		10.82- 08.89	CA345IR	14 70	10.82- 05.85	CS268	12 1.5
		10.82- 08.89	CA714IR	14 80			
		10.82- 08.86	CA87IR	14 55			
		09.84- 08.86	CA195IR	14 65			
		09.84- 08.86	CA335IR	14 80			
	[M102.962]	10.82- 08.86	CA87IR	14 55	02.85- 08.93	CS327	12 1.4
		01.85- 08.93	CA321IR	14 55	10.82- 12.86	CS268	12 1.5
		02.85- 08.90	CA345IR	14 70			
		09.85- 08.86	CA195IR	14 65			
		09.85- 08.86	CA335IR	14 80			
		09.85- 08.86	CA714IR	14 80			
		09.90- 08.93	CA833IR	14 70			
190 E 2.3	(201)[M102.985]	09.86- 08.93	CA321IR	14 55	09.86- 08.93	CS327	12 1.4
		09.86- 08.90	CA345IR	14 70			
		09.90- 08.93	CA833IR	14 70			
190 E 2.3 -16	(201)[M102.983]	04.84- 01.87	CA321IR	14 55	04.84- 05.85	CS268	12 1.5
		04.84- 08.88	CA345IR	14 70	06.85- 08.88	CS327	12 1.4
190 E 2.5 Evolution II	(201)[M102.992]	05.90- 08.93	CA345IR	14 70	05.90- 08.93	CS327	12 1.4
190 E 2.5 -16	(201)[M102.990]	09.88- 08.93	CA321IR	14 55	09.88- 08.93	CS327	12 1.4
		09.88- 08.93	CA345IR	14 70			
	[M102.991]	03.89- 08.93	CA321IR	14 55	03.89- 08.93	CS327	12 1.4
		03.89- 08.93	CA345IR	14 70			
190 E 2.6	(201)[M103.942]	09.86- 12.89	CA335IR	14 80	09.86- 08.93	CS360	12 1.7
		09.86- 12.89	CA345IR	14 70			
		09.89- 08.93	CA723IR	14 80			
		01.90- 08.93	CA724IR	14 70			
200 E 2.0	(124)[M102.962]	09.88- 12.89	CA321IR	14 55	09.88- 12.89	CS327	12 1.4
		09.88- 12.89	CA345IR	14 70			
	[M102.963]	09.88- 08.92	CA321IR	14 55	09.88- 08.92	CS327	12 1.4
		09.88- 08.92	CA345IR	14 70			
	[M111.940]	10.92- 06.93	CA1044IR	14 90	10.92- 06.93	CS327	12 1.4
		10.92- 06.93	CA724IR	14 70			
200 GE 2.0	(W463)[M102.965]	01.90- 07.93	CA1735IR	14 55	01.90- 07.93	CS268	12 1.5
220 CE 2.2	(124)[M111.960]	10.92- 05.93	CA1044IR	14 90	10.92- 05.93	CS327	12 1.4
		10.92- 05.93	CA724IR	14 70			
220 E 2.2	(124)[M111.960]	10.92- 06.93	CA1044IR	14 90	10.92- 06.93	CS327	12 1.4
		10.92- 06.93	CA724IR	14 70			
230 C 2.3	(123)[M115.954]	05.77- 04.80	CA69IR	14 35	05.77- 04.80	CS81	12 1.5
		05.77- 04.80	CA87IR	14 55			
230 CE 2.3	(123)[M102.980]	04.80- 12.85	CA87IR	14 55	04.80- 12.85	CS268	12 1.5
	(124)[M102.982]	Eng. 178859- 03.87- 12.92	CA833IR	14 70	03.87- 12.92	CS327	12 1.4
		Eng. -178858 03.87- 12.92	CA321IR	14 55			
		Eng. -178858 03.87- 12.92	CA345IR	14 70			
		AT, Eng. 190931- 03.87- 12.92	CA833IR	14 70			
		AT, Eng. -190930 03.87- 12.92	CA321IR	14 55			
230 E 2.3	(123)[M102.980]	04.80- 12.85	CA87IR	14 55	04.80- 12.85	CS268	12 1.5
	(124)[M102.982]	12.84- 03.85	CA287IR	14 70	12.84- 06.93	CS327	12 1.4
		Eng. 178859- 12.84- 06.93	CA833IR	14 70			
		Eng. -178858 12.84- 06.93	CA321IR	14 55			
		Eng. -178858 01.85- 06.93	CA345IR	14 70			
		AT, Eng. 190931 12.84- 03.92	CA833IR	14 70			
		AT, Eng. 190931- 01.85- 06.93	CA833IR	14 70			
		AT, Eng. -190930 12.84- 06.93	CA321IR	14 55			
		A20 06.89- 06.93	CA714IR	14 80			
230 G 2.3	(460)[M115.973]	03.79- 05.80	CA87IR	14 55	03.79- 12.81	CS81	12 1.5
					01.82- 07.93	CS268	12 1.5
230 GE 2.3	(460)[M102.979]				05.87- 08.92	CS268	12 1.5
	[M102.981]				04.82- 08.85	CS268	12 1.5
	[M102.987]				09.85- 08.92	CS268	12 1.5
	(461)[M102.979]	04.92- 09.95	CA1735IR	14 55	02.93- 09.95	CS794	12 2.2 A29
					04.92- 09.95	CS268	12 1.5
					02.93- 09.95	CS331	12 2.2
	[M102.996]				04.92- 09.95	CS794	12 2.2
	[M102.997]				04.92- 09.95	CS794	12 2.2
	(463)[M102.989]	06.90- 06.93	CA1735IR	14 55	06.90- 06.93	CS268	12 1.5
230.4 2.3	(115)[M115.951]	08.73- 12.76	CA69IR	14 35	08.73- 12.76	CS81	12 1.5
		08.73- 12.76	CA87IR	14 55			
230.6 2.3	(114)[M180.954]	01.68- 11.76	CA87IR	14 55	01.68- 11.76	CS81	12 1.5
240 G 2.4 Diesel	(460)[OM616.936]	03.79- 05.80	CA87IR	14 55	03.79- 08.87	CS188	12 2.0
250 C 2.5	(114)[M114.920]	04.69- 06.72	CA70#	14 55	04.69- 06.72	CS81	12 1.5
250 C 2.9	(114)[M130.923]	06.72- 07.73	CA70#	14 55	06.72- 11.76	CS81	12 1.5
		08.73- 11.76	CA87IR	14 55			
250 CE 2.5	(114)[M114.980]	01.71- 04.72	CA70#	14 55	04.69- 04.72	CS81	12 1.5
250 G 2.5 Diesel	(460)[OM602.930]	09.87- 12.92	CA1735IR	14 55	09.87- 12.92	CS794	12 2.2
	(463)[OM602.931]	09.89- 07.93	CA1735IR	14 55	09.89- 07.93	CS794	12 2.2 A29
					09.89- 07.93	CS331	12 2.2
260 E 2.6	(124)[M103.940]	09.85- 12.89	CA345IR	14 70	09.85- 08.92	CS360	12 1.7
		09.86- 08.89	CA335IR	14 80			
		09.89- 08.92	CA723IR	14 80			
		01.90- 08.92	CA724IR	14 70			
260 E 2.6 4 Matic	(124)[M103.940]	12.86- 08.89	CA335IR	14 80	12.86- 12.89	CS360	12 1.7
		12.86- 12.89	CA345IR	14 70			
		09.89- 12.89	CA723IR	14 80			
	[M103.943]	09.86- 08.89	CA335IR	14 80	09.86- 08.92	CS360	12 1.7
		09.86- 12.89	CA345IR	14 70			
		09.89- 08.92	CA723IR	14 80			
		01.90- 08.92	CA724IR	14 70			
260 SE 2.5	(126)[M103.941]	09.85- 06.91	CA335IR	14 80	09.85- 06.91	CS360	12 1.7
280 C 2.7	(114)[M110.921]	06.72- 02.77	CA87IR	14 55	06.72- 02.77	CS81	12 1.5
	(123)[M110.923]	03.77- 03.80	CA87IR	14 55	03.77- 03.80	CS81	12 1.5
		03.78- 03.80	CA195IR	14 65			
280 CE 2.7	(114)[M110.981]	06.72- 01.77	CA87IR	14 55	06.72- 01.77	CS81	12 1.5
	(123)[M110.988]	03.77- 11.85	CA87IR	14 55	03.77- 11.85	CS81	12 1.5
		03.78- 11.85	CA195IR	14 65			



280 E 2.7	(114)[M110.981]	06.72- 11.76	CA871R	14 55	06.72- 11.76	CS81	12 1.5
	(123)[M110.984]	02.76- 11.85	CA871R	14 55	02.76- 11.85	CS81	12 1.5
	[M110.988]	03.78- 11.85	CA1951R	14 65			
		02.76- 11.85	CA871R	14 55	02.76- 11.85	CS81	12 1.5
280 E 2.8	(123)[M110.988]	03.78- 11.85	CA1951R	14 65			
		02.76- 11.85	CA871R	14 55	09.77- 11.85	CS81	12 1.5
	(124)[M104.942]	10.92- 06.93	CA1044IR	14 90	10.92- 06.93	CS360	12 1.7
280 GE 2.7	(460)[M110.994]	11.79- 05.80	CA871R	14 55	11.79- 08.89	CS311	12 1.5
280 S 2.7	(116)[M110.922]	08.72- 07.80	CA871R	14 55	08.72- 07.80	CS81	12 1.5
		03.78- 07.80	CA1951R	14 65			
	[M110.924]	12.79- 07.85	CA1951R	14 65	12.79- 02.80	CS81	12 1.5
		08.82- 07.85	CA2631R	14 80	03.80- 07.85	CS311	12 1.5
		12.79- 07.85	CA1951R	14 65	12.79- 02.80	CS81	12 1.5
280 S 2.8	(108)[M130.920]	06.69- 07.72	CA70#	14 55	10.67- 07.72	CS81	12 1.5
280 SE 2.7	(116)[M110.983]	08.72- 07.76	CA871R	14 55	08.72- 07.76	CS81	12 1.5
		08.72- 07.80	CA871R	14 55	08.72- 07.80	CS81	12 1.5
	[M110.985]	03.78- 07.80	CA1951R	14 65	RHD 10.76- 07.80	CS83	12 0.8
		10.79- 07.85	CA1951R	14 65	10.79- 07.85	CS311	12 1.5
	[M110.989]	10.79- 07.85	CA1951R	14 65	10.79- 07.85	CS311	12 1.5
280 SE 2.8	(108,109)[M130.980]	06.69- 08.72	CA70#	14 55	01.68- 08.72	CS81	12 1.5
	(111)[M130.980]				01.68- 09.68	CS83	12 0.8
280 SE 3.5	[M130.984]	AC 06.69- 12.71	CA70#	14 55	01.67- 12.71	CS81	12 1.5
	(108)[M116.980]	AC 01.67- 12.71	CA70#	14 55	03.71- 08.72	CS81	12 1.5
	(111)[M116.980]				01.69- 12.71	CS81	12 1.5
280 SEL 2.7	(116)[M110.983]	08.72- 07.76	CA871R	14 55	08.72- 07.76	CS81	12 1.5
		08.76- 07.80	CA871R	14 55	08.76- 07.80	CS81	12 1.5
	[M110.985]	03.78- 07.80	CA1951R	14 65	RHD 10.76- 07.80	CS83	12 0.8
		10.79- 07.85	CA1951R	14 65	10.79- 02.80	CS81	12 1.5
	[M110.989]	10.79- 07.85	CA1951R	14 65	03.80- 07.85	CS311	12 1.5
280 SEL 2.8	(108,109)[M130.980]	01.68- 08.72	CA70#	14 55	01.68- 08.72	CS81	12 1.5
280 SEL 3.5	(108)[M116.980]				03.71- 08.72	CS81	12 1.5
280 SL 2.7	(107)[M110.982]	08.74- 11.80	CA871R	14 55	08.74- 07.85	CS81	12 1.5
		06.76- 07.85	CA1951R	14 65			
	[M110.986]	08.74- 11.80	CA871R	14 55	08.74- 07.85	CS81	12 1.5
		06.76- 07.85	CA1951R	14 65			
	[M110.990]	08.74- 11.80	CA871R	14 55	08.74- 07.85	CS81	12 1.5
(113)[M130.983]	06.76- 07.85	CA1951R	14 65	10.68- 12.71	CS81	12 1.5	
280 SLC 2.8	(107)[M110.982]	08.74- 09.81	CA871R	14 55	08.74- 09.81	CS81	12 1.5
		06.76- 09.81	CA1951R	14 65			
	[M110.986]	08.74- 09.81	CA871R	14 55	08.74- 09.81	CS81	12 1.5
280 TE 2.8	(124)[M104.942]	08.76- 09.81	CA1951R	14 65			
		06.76- 09.81	CA1951R	14 65			
	(124)[M104.942]	10.92- 06.93	CA1044IR	14 90	10.92- 06.93	CS360	12 1.7
290 G 2.9 Diesel	(463)[OM602.942]	04.92- 09.97	CA1735IR	14 55	04.92- 09.97	CS794	12 2.2
290 G 2.9 TD	(461)[OM602.983]	07.97- 09.01	CA1209IR	14 90	07.97- 09.01	CS794	12 2.2
300 C 2.9 TD	(123)[OM617.952]	09.81- 07.85	CA871R	14 55	09.81- 07.85	CS188	12 2.0
300 CE-24 3.0	(124)[M104.980]	09.89- 06.93	CA7141R	14 80	09.89- 06.93	CS360	12 1.7
		04.92- 06.93	CA1044IR	14 90	04.92- 06.93	CS360	12 1.7
	[A124][M104.980]	04.92- 06.93	CA1244IR	14 90			
		AT 04.92- 06.93	CA7141R	14 80			
	(C124)[M104.980]	09.89- 12.92	CA1044IR	14 90	09.89- 12.92	CS360	12 1.7
300 E 2.9	(124)[M103.980]	01.85- 12.85	CA3451R	14 70	06.85- 12.85	CS360	12 1.7
300 E 3.0	(124)[M103.983]	09.86- 08.89	CA3351R	14 80	01.85- 05.85	CS268	12 1.5
		09.89- 08.92	CA7231R	14 80	06.85- 08.92	CS360	12 1.7
	[M103.985]	09.89- 08.92	CA7241R	14 70			
		01.90- 02.92	CA7241R	14 70			
	09.86- 08.89	CA3351R	14 80	09.86- 06.93	CS360	12 1.7	
300 E-24 3.0	(124)[M104.980]	09.88- 08.92	CA7141R	14 80	09.88- 08.92	CS360	12 1.7
		09.89- 08.92	CA10811R	14 110			
	[W124][M104.980]	09.88- 08.92	CA1044IR	14 90			
		09.88- 08.92	CA1244IR	14 90			
	AT 09.88- 08.92	CA7141R	14 80				
300 G 3.0 Diesel	(460)[OM603.912]				09.89- 07.93	CS331	12 2.2
	[OM617.931]	12.79- 05.80	CA871R	14 55	09.89- 07.93	CS794	12 2.2 A29
	(463)[OM603.931]	09.89- 07.97	CA1735IR	14 55	12.79- 12.91	CS188	12 2.0
300 GE 3.0	(463)[M103.987]	09.89- 07.97	CS331	12 2.2	09.89- 07.97	CS794	12 2.2 A29
		09.89- 07.97	CS794	12 2.2 A29			
		06.90- 08.93	CS268	12 1.5	09.89- 07.93	CS331	12 2.2
300 SE 2.9	(126)[M103.981]	09.85- 06.91	CA3351R	14 80	09.85- 06.91	CS360	12 1.7
300 SE 3.2	(140)[M104.990]	03.91- 05.93	CA6461R	14 120	03.91- 05.93	CS360	12 1.7
		03.91- 04.93	CA6461R	14 120	03.91- 04.93	CS360	12 1.7
300 SEL 2.8	(108)[M130.981]	06.69- 08.72	CA70#	14 55	01.68- 08.72	CS81	12 1.5
300 SEL 2.9	(126)[M103.981]	09.85- 06.91	CA3351R	14 80	09.85- 06.91	CS360	12 1.7
300 SEL 3.2	(140)[M104.990]	03.91- 05.93	CA6461R	14 120	03.91- 05.93	CS360	12 1.7
		[M104.994]	05.93- 10.98	CA1477IR	14 120	05.93- 10.98	CS360
300 SEL 3.5	(108)[M116.981]				01.70- 07.72	CS81	12 1.5
300 SE 6.3	(108)[M100.981]	01.71- 08.72	CA70#	14 55			
300 SL 2.9	(107)[M103.982]	09.85- 08.89	CA3451R	14 70	09.85- 08.89	CS360	12 1.7
300 SL 3.0	(129)[M103.984]	03.89- 08.93	CA10571R	14 120	03.89- 08.93	CS360	12 1.7
		03.89- 08.93	CA6451R	14 100			
300 SL-24 3.0	(129)[M104.981]	03.89- 07.93	CA6461R	14 120	03.89- 07.93	CS360	12 1.7
300 TE-24 3.0	(S124)[M104.980]	09.89- 08.92	CA1044IR	14 90	09.89- 08.92	CS360	12 1.7
		09.89- 08.92	CA1244IR	14 90			
	AT 09.89- 08.92	CA7141R	14 80				
320 CE 3.2	(124)[M104.992]	10.92- 05.93	CA1044IR	14 90	10.92- 05.93	CS360	12 1.7
320 E 3.2	(124)[M104.992]	10.92- 06.93	CA1044IR	14 90	10.92- 06.93	CS360	12 1.7
350 C 3.4 TD	(463)[OM603.972]	07.94- 06.96	CA10621R	14 90	09.91- 06.96	CS794	12 2.2
350 SE 3.5	(116)[M116.983]	08.72- 02.76	CA871R	14 55	08.72- 02.76	CS81	12 1.5
		03.76- 03.80	CA871R	14 55	03.76- 03.80	CS81	12 1.5
350 SEL 3.5	(116)[M116.983]	08.74- 02.76	CA871R	14 55	11.73- 02.76	CS81	12 1.5



MERCEDES-BENZ Continued

	[M116.985]	03.76- 03.80	CA871R	14 55		03.76- 03.80	CS81	12 1.5
350 SL 3.5	(107)[M116.982]	05.71- 02.80	CA871R	14 55		05.71- 02.80	CS81	12 1.5
	[M116.984]	05.71- 02.80	CA871R	14 55		05.71- 02.80	CS81	12 1.5
350 SLC 3.5	(107)[M116.982]	01.72- 02.80	CA871R	14 55		01.72- 02.80	CS81	12 1.5
	[M116.984]	01.72- 02.80	CA871R	14 55		01.72- 02.80	CS81	12 1.5
380 SE 3.8	(126)[M116.961]	02.80- 08.85	CA2871R	14 70		12.79- 08.85	CS81	12 1.5
		01.82- 08.85	CA2631R	14 80				
	[M116.963]	12.79- 08.85	CA2871R	14 70		12.79- 08.85	CS81	12 1.5
		01.82- 08.85	CA2631R	14 80				
380 SEC 3.8	(126)[M116.963]	10.81- 07.85	CA2871R	14 70		10.81- 07.85	CS81	12 1.5
		01.82- 07.85	CA2631R	14 80				
380 SEL 3.8	(126)[M116.961]	02.80- 08.85	CA2871R	14 70		12.79- 08.85	CS81	12 1.5
		01.82- 08.85	CA2631R	14 80				
	[M116.963]	02.80- 08.85	CA2871R	14 70		12.79- 08.85	CS81	12 1.5
		01.82- 08.85	CA2631R	14 80				
380 SL 3.8	(107)[M116.960]	09.80- 08.81	CA2871R	14 70		09.80- 08.81	CS81	12 1.5
	[M116.962]	09.80- 08.85	CA2871R	14 70		09.80- 08.85	CS81	12 1.5
		08.82- 08.85	CA2631R	14 80				
380 SLC 3.8	(107)[M116.960]	07.80- 08.81	CA2871R	14 70		07.80- 08.81	CS81	12 1.5
400 E 4.2	(124)[M119.975]	10.92- 06.93	CA10811R	14 110		10.92- 06.93	CS583	12 1.7
400 SE 4.2	(140)[M119.971]	02.91- 05.93	CA12061R	14 143		02.91- 05.93	CS583	12 1.7
		Eng. 011683- 02.91- 05.93	CA10811R	14 110				
		Eng. -011682 02.91- 05.93	CA6461R	14 120 ▲				
400 SEL 4.2	(140)[M119.971]	06.93- 09.95	CA12061R	14 143		06.93- 09.95	CS583	12 1.7
		Eng. 011683- 06.93- 09.95	CA10811R	14 110				
		Eng. -011682 06.93- 09.95	CA6461R	14 120 ▲				
406F 2.2 Diesel	(T2L)[OM615.910]					01.68- 12.74	CS113	12 2.0
420 SE 4.2	(126)[M116.965]	09.85- 06.91	CA2631R	14 80		10.85- 12.87	CS81	12 1.5
						09.87- 06.91	CS583	12 1.7
420 SEC 4.2	(126)[M116.965]	10.85- 06.91	CA2631R	14 80		10.85- 08.87	CS81	12 1.5
						09.87- 06.91	CS583	12 1.7
420 SEL 4.2	(126)[M116.965]	09.85- 06.91	CA2631R	14 80		09.85- 06.91	CS583	12 1.7
						09.85- 08.87	CS81	12 1.5
420 SL 4.1	(107)[M116.964]	01.86- 08.89	CA2871R	14 70		01.86- 08.87	CS81	12 1.5
						09.87- 08.89	CS583	12 1.7
420 SL 4.2	(107)[M116.964]	01.86- 08.89	CA2871R	14 70		01.86- 08.87	CS81	12 1.5
						09.87- 08.89	CS583	12 1.7
450 SE 4.5	(116)[M117.983]	08.74- 11.75	CA871R	14 55		01.73- 11.75	CS81	12 1.5
	[M117.986]	12.75- 04.80	CA871R	14 55		12.75- 04.80	CS81	12 1.5
450 SEL 4.5	(116)[M117.983]	08.74- 11.75	CA871R	14 55		01.73- 11.75	CS81	12 1.5
	[M117.986]	12.75- 04.80	CA871R	14 55		12.75- 04.80	CS81	12 1.5
450 SEL 6.9	(116)[M100.985]	07.75- 03.80	CA871R	14 55		07.75- 03.80	CS81	12 1.5
450 SL 4.5	(107)[M117.982]	08.74- 10.80	CA871R	14 55		10.72- 10.80	CS81	12 1.5
	[M117.985]	08.74- 10.80	CA871R	14 55		10.72- 10.80	CS81	12 1.5
450 SLC 4.5	(107)[M117.982]	01.73- 08.79	CA871R	14 55		01.73- 08.79	CS81	12 1.5
	[M117.985]	01.73- 08.79	CA871R	14 55		01.73- 08.79	CS81	12 1.5
450 SLC 5.0	(107)[M117.960]	06.78- 02.80	CA871R	14 55		06.78- 02.80	CS81	12 1.5
500 E 5.0	(124)[M119.974]	01.91- 06.93	CA10811R	14 110		01.91- 06.93	CS583	12 1.7
500 E AMG 6.0	(124)	01.92- 06.93	CA10811R	14 110		01.92- 06.93	CS583	12 1.7
500 SE 4.9	(126)[M117.961]	12.79- 08.85	CA2871R	14 70		12.79- 08.85	CS81	12 1.5
		01.82- 08.85	CA2631R	14 80				
	[M117.963]	12.79- 08.85	CA2871R	14 70		12.79- 08.85	CS81	12 1.5
		01.82- 08.85	CA2631R	14 80				
	[M117.965]	09.85- 06.91	CA2631R	14 80		09.85- 08.87	CS81	12 1.5
						09.87- 06.91	CS583	12 1.7
500 SE 5.0	(126)[M117.965]	09.85- 06.91	CA2631R	14 80		09.87- 06.91	CS583	12 1.7
						09.85- 08.87	CS81	12 1.5
	(140)[M119.970]	02.91- 05.93	CA12061R	14 143		02.91- 05.93	CS583	12 1.7
		Eng. 026391- 02.91- 05.93	CA10811R	14 110				
		Eng. -026390 02.91- 05.93	CA6461R	14 120 ▲				
500 SE 5.5	(126)[M117.968]	10.85- 06.91	CA2631R	14 80		10.85- 12.87	CS81	12 1.5
						09.87- 06.91	CS583	12 1.7
500 SEC 4.9	(126)[M117.963]	10.81- 08.85	CA2871R	14 70		10.81- 08.85	CS81	12 1.5
		08.82- 08.85	CA2631R	14 80				
	[M117.965]	09.85- 06.91	CA2631R	14 80		09.85- 08.87	CS81	12 1.5
						08.87- 06.91	CS583	12 1.7
500 SEC 5.0	(126)[M117.965]	09.85- 06.91	CA2631R	14 80		09.87- 06.91	CS583	12 1.7
						09.85- 08.87	CS81	12 1.5
500 SEL 5.0	(126)[M117.961]	12.79- 08.85	CA2871R	14 70		12.79- 08.85	CS81	12 1.5
		01.82- 08.85	CA2631R	14 80				
	[M117.963]	12.79- 08.85	CA2871R	14 70		12.79- 08.85	CS81	12 1.5
		01.82- 08.85	CA2631R	14 80				
	[M117.965]	09.85- 06.91	CA2631R	14 80		09.87- 06.91	CS583	12 1.7
						09.85- 08.87	CS81	12 1.5
	(140)[M119.970]	02.91- 05.93	CA12061R	14 143		02.91- 05.93	CS583	12 1.7
500 SL 4.9	(107)[M117.960]	05.80- 12.85	CA2871R	14 70		05.80- 12.85	CS81	12 1.5
		01.82- 12.85	CA2631R	14 80				
	[M117.964]	01.86- 08.89	CA2871R	14 70		01.86- 08.89	CS81	12 1.5
500 SL 5.0	(129)[M119.960]	03.89- 08.92	CA6451R	14 100		03.89- 08.92	CS583	12 1.7
	[M119.972]	09.89- 08.92	CA6451R	14 100		09.89- 06.93	CS583	12 1.7
		09.92- 06.93	CA10811R	14 110				
		09.92- 06.93	CA12061R	14 143				
560 SE 5.5	(126)[M117.968]	10.85- 06.91	CA2631R	14 80		09.87- 06.91	CS583	12 1.7
						10.85- 08.87	CS81	12 1.5
560 SEC 5.5	(126)[M117.968]	10.85- 06.91	CA2631R	14 80		10.85- 12.89	CS81	12 1.5
						09.87- 06.91	CS583	12 1.7
560 SEL 5.5	(126)[M117.968]	10.85- 06.91	CA2631R	14 80		08.87- 06.91	CS583	12 1.7
						10.85- 12.87	CS81	12 1.5
600 SE 6.0	(140)[M120.980]	04.91- 09.98	CA12061R	14 143		04.91- 09.98	CS360	12 1.7
		04.91- 09.98	CA6461R	14 120				
	[M120.982]	Eng. 025950- 04.91- 05.93	CA12061R	14 143				
		Eng. -025949 04.91- 05.93	CA6461R	14 120				
600 SEL 6.0	(140)[M120.980]	Eng. 025950- 04.91- 05.93	CA12061R	14 143				
		Eng. -025949 04.91- 05.93	CA6461R	14 120				
	[M120.982]	Eng. 025950- 04.91- 05.93	CA12061R	14 143				
		Eng. -025949 04.91- 05.93	CA6461R	14 120				
A 140 1.4	(168)[M166.940]	07.97- 08.04	CA13421R	14 90		Chas. -J869216 07.97- 08.04	CS1117	12 1.0
						Chas. -954103, w/Code 08.01- 06.03	CS1384	12 0.8
						049 - Engine ECU Siemens MSM2		
A 140 1.6	(168)[M166.960]	01.01- 08.04	CA13421R	14 90		Chas. -954103, w/Code 08.01- 06.03	CS1384	12 0.8
						049 - Engine ECU Siemens MSM2		
						Chas. -J869216 01.01- 11.02	CS1117	12 1.0
						Chas. -J954103- 06.03- 08.04	CS1117	12 1.0
A 150 1.5	(169)[M266.920]	09.04- 09.04	CA18741R	14 115		09.04-	CS1117	12 1.0
			CA18751R	14 90				
A 160 1.5	(W169)[M266.920]	04.09- 04.09	CA18741R	14 115		04.09-	CS1117	12 1.0
			CA18751R	14 90				
A 160 1.6	(168)[M166.960]	07.97- 08.04	CA13421R	14 90		Chas. -J869216 07.97- 08.04	CS1117	12 1.0



					Chas. -954103, w/Code 08.01- 06.03 049 - Engine ECU Siemens MSM2	<b>CS1384</b>	12	0.8
A 160 1.7 CDi	(168)[OM668.940] [OM668.941]	02.01- 08.04 03.01- 07.98- 02.01	CA1680IR CA1680IR CA1390IR	14 150 A35 14 150 A35 14 90		02.01- 08.04 07.98- 02.01	<b>CS1172</b> <b>CS1172</b>	12 1.7 12 1.7
A 160 2.0 CDi	(169)[OM640.942]	09.04-	CA1873IR	14 150		09.04-	<b>CS1172</b>	12 1.7
A 170 1.7	(169)[M266.940] (W169)[M266.940]	09.04- 04.09- 04.09-	CA1874IR CA1875IR CA1874IR CA1875IR	14 115 14 90 14 115 14 90		09.04- 04.09-	<b>CS1172</b> <b>CS1117</b>	12 1.0 12 1.0
A 170 1.7 CDi	(168)[OM668.940] [OM668.942]	07.98- 02.01 07.98- 02.01	CA1390IR CA1680IR	14 90 14 150 A35		07.98- 02.01	<b>CS1172</b>	12 1.7
A 180 2.0 CDi	(169)[OM640.940]	09.04-	CA1873IR	14 150		09.04-	<b>CS1172</b>	12 1.7
A 190 1.9	(168)[M166.990]	03.99- 08.04	CA1390IR	14 90	Chas. -J568589 02.01- 08.04	03.99- 08.04	<b>CS1172</b>	12 1.7
A 200 2.0	(169)[M266.960]	09.04-	CA1874IR	14 115		09.04-	<b>CS1117</b>	12 1.0
A 200 2.0 Turbo	(169)[M266.980]	09.05-	CA1874IR	14 115		09.05-	<b>CS1117</b>	12 1.0
A 200 2.0 CDi	(169)[OM640.941]	09.04-	CA1873IR	14 150		09.04-	<b>CS1172</b>	12 1.7
A 210 2.1	(168)[M166.995]	03.02- 08.04	CA1390IR	14 90	Chas. J869217-J954102 03.02- 08.04 Chas. -J869216 03.02- 08.04 Chas. J954103- 03.02- 08.04	03.02- 08.04 03.02- 08.04	<b>CS1338</b> <b>CS1117</b> <b>CS1117</b>	12 1.3 12 1.0 12 1.0
B 150 1.5	(245)[M266.920] (W245)[M266.920]	03.05- 03.05- 04.09- 04.09-	CA1874IR CA1875IR CA1874IR CA1875IR	14 115 14 90 14 115 14 90		03.05- 04.09-	<b>CS1117</b> <b>CS1117</b>	12 1.0 12 1.0
B 170 1.7	(245)[M266.940] (W245)[M266.940]	03.05- 03.05- 04.09- 04.09-	CA1874IR CA1875IR CA1874IR CA1875IR	14 115 14 90 14 115 14 90		03.05- 04.09-	<b>CS1117</b> <b>CS1117</b>	12 1.0 12 1.0
B 170 2.0 Bifuel NGT	(W245)[M266.960]	04.08-	CA1874IR	14 115		04.08-	<b>CS1117</b>	12 1.0
B 180 2.0 CDi	(245)[OM640.940]	03.05-	CA1873IR	14 150		03.05-	<b>CS1172</b>	12 1.7
B 200 2.0	(245)[M266.960]	03.05-	CA1874IR	14 115		03.05-	<b>CS1117</b>	12 1.0
B 200 2.0 Turbo	(245)[M266.980]	03.05-	CA1874IR	14 115		03.05-	<b>CS1117</b>	12 1.0
B 200 2.0 CDi	(245)[OM640.941]	03.05-	CA1873IR	14 150		03.05-	<b>CS1172</b>	12 1.7
C 160 1.8 Kompressor	(203)[M271.921]	05.02-	CA1752IR	14 120		06.05-	<b>CS1283</b>	12 1.1
C 180 1.6 Kompressor	(W204)[M271.952]					01.08-	<b>CS1283</b>	12 1.1
C 180 1.8	(202)[M111.920] [M111.921] (C204)[M271.820] (S204)[M271.820]	03.93- 02.01 03.93- 02.01 03.93- 02.01 11.94- 02.01 11.94- 02.01 11.94- 02.01	CA1044IR CA1057IR CA724IR CA1044IR CA1057IR CA724IR	14 90 14 120 14 70 14 90 14 120 14 70		03.93- 08.93 09.93- 02.01 06.11- 11.09-	<b>CS327</b> <b>CS1075</b> <b>CS1283</b> <b>CS1283</b> <b>CS1075</b> <b>CS1283</b>	12 1.4 12 1.2 12 1.1 12 1.1 12 1.1 12 1.1
C 180 1.8 Kompressor	(203)[M271.946] (204)[M271.952] (S204)[M271.952]	06.02-	CA1752IR	14 120		06.02- 01.07- 08.07-	<b>CS1283</b> <b>CS1283</b> <b>CS1283</b>	12 1.1 12 1.1 12 1.1
C 180 1.8 CGI	(W204)[M271.820]					01.07-	<b>CS1283</b>	12 1.1
C 180 2.0	(202)[M111.952]	09.00- 02.01	CA1732IR	14 90		09.00- 02.01 09.00- 02.01	<b>CS327</b> <b>CS1075</b>	12 1.4 12 1.2
C 200 1.8 Kompressor	(203)[M111.951] (203)[M271.940] (204)[M271.950] (S204)[M271.950]	10.00- 05.02 09.02-	CA1623IR CA1752IR	14 120 14 120		10.00- 05.02 09.02- 01.07- 08.07-	<b>CS1075</b> <b>CS1283</b> <b>CS1283</b> <b>CS1283</b>	12 1.2 12 1.1 12 1.1 12 1.1
C 200 1.8 CGI	(W204)[M271.820]					01.07-	<b>CS1283</b>	12 1.1
C 200 1.8 CGI Kompressor	(203)[M271.942]	09.02-	CA1752IR	14 120		09.02-	<b>CS1283</b>	12 1.1
C 200 2.0	(202)[M111.941] [M111.944] [M111.945]	01.94- 05.00 01.94- 02.01 01.94- 05.00 01.94- 05.00 01.94- 05.00 01.94- 05.00 01.94- 05.00 01.94- 05.00 01.94- 05.00 01.94- 05.00	CA1044IR CA1057IR CA724IR CA1044IR CA724IR CA1044IR CA724IR CA1062IR CA1044IR CA1057IR CA724IR CA1044IR CA724IR CA1044IR CA724IR CA1062IR	14 90 14 120 14 70 14 90 14 70 14 90 14 70 14 90 14 90 14 120 14 70 14 90 14 70 14 90 14 70 14 90		01.94- 02.01 11.96- 03.01 01.94- 05.00 01.94- 02.01 01.94- 05.00 01.94- 05.00 01.94- 05.00 01.94- 05.00 01.94- 05.00	<b>CS1075</b> <b>CS1075</b> <b>CS1075</b> <b>CS1075</b> <b>CS1075</b> <b>CS1075</b> <b>CS1075</b> <b>CS1075</b> <b>CS1075</b> <b>CS1075</b> <b>CS1075</b> <b>CS1075</b> <b>CS1075</b> <b>CS1075</b> <b>CS1075</b> <b>CS1075</b>	12 1.2 12 1.2 12 1.2 12 1.2 12 1.2 12 1.2 12 1.2 12 1.2 12 1.2 12 1.2 12 1.2 12 1.2 12 1.2 12 1.2 12 1.2 12 1.2
C 200 2.0 Kompressor	(202)[M111.944] [M111.956] (203)[M111.955] (202)[OM611.960]	10.95- 05.00 10.95- 05.00 09.00- 02.01 09.00- 03.01 09.00- 03.01 05.00- 05.02 03.98- 05.00 Eng. -007600 03.98- 05.00	CA1062IR CA1395IR CA1062IR CA1301IR CA2076IR* CA1689IR CA1481IR CA1489IR	14 90 14 90 14 90 14 90 14 120 14 120 14 115 14 90		10.95- 05.00 09.00- 02.01 09.00- 02.01 05.00- 08.02 03.98- 05.00	<b>CS1075</b> <b>CS1075</b> <b>CS1075</b> <b>CS327</b> <b>CS1075</b> <b>CS1075</b> <b>CS1044</b>	12 1.2 12 1.2 12 1.4 12 1.4 12 2.0
C 200 2.0 Diesel	(202)[OM601.913] [OM604.915]	03.93- 08.95 03.93- 08.95 10.96- 05.00 10.96- 06.99 10.96- 05.00 AT, Eng. -000002 10.96- 05.00	CA1062IR CA833IR CA1062IR CA1395IR CA833IR CA1062IR	14 90 14 70 14 90 14 90 14 70 14 90		03.93- 01.94 02.94- 08.95 10.96- 05.00	<b>CS1162</b> <b>CS1044</b> <b>CS1044</b>	12 2.2 12 2.0 12 2.0
C 200 2.1 CDi	(203)[OM611.962] [OM646.962] (204)[OM646.811] (S204)[OM646.811] (W204)[OM651.913]	03.03- 01.07- 08.07- 01.11-	CA1859IR CA2032IR CA2032IR CA2072IR*	14 200 14 180 14 180 14 180		09.00- 02.03 03.03- 08.07-	<b>CS1044</b> <b>CS1044</b> <b>CS1410</b> <b>CS1410</b>	12 2.0 12 2.0 12 1.7 12 1.7
C 200 2.2 CDi	(202)[OM611.960]	Eng. 007601- 03.98- 03.01 Eng. -007600 03.98- 03.01	CA1481IR CA1489IR	14 115 14 90		03.98- 03.01	<b>CS1044</b>	12 2.0
C 220 2.1 CDi	(203)[OM646.962] (203)[OM611.962] (204)[OM646.811] (S204)[OM646.811] (W204)[OM651.911]	03.03- 01.07- 08.07- 12.08-	CA1859IR CA2032IR CA2032IR CA2072IR*	14 200 14 180 14 180 14 180		03.03- 05.00- 02.03 01.07- 08.07-	<b>CS1044</b> <b>CS1044</b> <b>CS1410</b> <b>CS1410</b>	12 2.0 12 2.0 12 1.7 12 1.7
C 220 2.1 CDi T-Model	(S204)[OM651.911]	12.08-	CA2072IR*	14 180				
C 220 2.2	(202)[M111.961]	03.93- 09.96 03.93- 09.96 03.93- 09.96	CA1044IR CA1057IR CA724IR	14 90 14 120 14 70		03.93- 09.96	<b>CS1075</b>	12 1.2
C 220 2.2 CDi	(202)[OM611.960]	Eng. 007601- 12.97- 03.01 Eng. -007600 12.97- 03.01	CA1481IR CA1489IR	14 115 14 90		12.97- 03.01	<b>CS1044</b>	12 2.0
C 220 2.2 Diesel	(203)[OM646.963] (202)[OM604.910]	03.03- 08.93- 06.99 08.93- 06.99 08.93- 06.99 Eng. 003821- 05.96- 06.99 Eng. -003820 05.96- 06.99 AT, Eng. 000843- 06.96- 06.99	CA1859IR CA1062IR CA1395IR CA833IR CA1395IR CA833IR CA1395IR	14 200 14 90 14 90 14 70 14 90 14 70 14 90		03.03- 08.93- 05.94 08.93- 06.99	<b>CS1044</b> <b>CS331</b> <b>CS1044</b>	12 2.0 12 2.2 12 2.0





	[M111.945]		06.97- 06.00	CA1044IR	14 90	06.97- 06.00	CS1075	12 1.2
			06.97- 06.00	CA1057IR	14 120			
CLK 200 2.0 Kompressor	(208)[M111.944]		06.97- 06.00	CA1062IR	14 90	06.97- 06.00	CS1075	12 1.2
	(209)[M271.940]		02.03-	CA1752IR	14 120	02.03-	CS1283	12 1.1
CLK 200 2.0 16V	(208)[M111.941]		03.98-	CA1044IR	14 90	03.98-	CS1075	12 1.2
			03.98-	CA1057IR	14 120			
	[M111.945]		03.98-	CA1044IR	14 90	03.98-	CS1075	12 1.2
			03.98-	CA1057IR	14 120			
CLK 200 2.0 CGI Kompressor	(209)[M271.942]		06.03-	CA1752IR	14 120	07.03-	CS1283	12 1.1
CLK 220 2.1 CDi	(209)[OM646.966]		04.05-	CA1859IR	14 200	10.06-	CS1410	12 1.7
						04.05- 09.06	CS1044	12 2.0
CLK 230 2.3 Kompressor	(208)[M111.973]		06.96- 01.00	CA1500IR	14 90	09.96- 06.00	CS1075	12 1.2
	[M111.975]		06.97- 06.00	CA1062IR	14 90	06.97- 06.00	CS1075	12 1.2
	[M111.982]		06.00- 01.03	CA1732IR	14 90	06.00- 01.03	CS1075	12 1.2
			06.00-	CA2076IR*	14 120			
CLK 240 2.4	[M112.912]		02.03-	CA1872IR	14 120	02.03-	CS1249	12 1.4
CLK 270 2.7 CDi	(209)[OM612.962]					09.02-	CS1044	12 2.0
	[OM612.967]					09.02-	CS1044	12 2.0
CLK 280 3.0	(209)[M272.940]		01.05-	CA1908IR	14 150	RHD 01.05-	CS1414	12 1.4
						01.05-	CS1249	12 1.4
CLK 320 3.0 CDi	(209)[OM642.910]					01.05-	CS1072	12 1.7
CLK 320 3.2	(208)[M112.940]		01.97- 01.03	CA1300IR	14 115	01.97- 01.03	CS1249	12 1.4
			01.97- 01.03	CA1656IR	14 120	01.97- 01.03	CS1072	12 1.7
	[M112.955]		02.03-	CA1872IR	14 120	02.03-	CS1249	12 1.4
CLK 350 3.5	(209)[M272.960]		01.05-	CA1908IR	14 150	RHD 01.05-	CS1414	12 1.4
						01.05-	CS1249	12 1.4
CLK 430 4.3	(208)[M113.943]	Chas. -F180102, -T091959	07.98- 06.02	CA1206IR	14 143 ▲	07.98- 06.02	CS1072	12 1.7
		Chas. F180102-, 07.98- 06.02		CA1776IR	14 150			
		T091959-						
CLK 430 4.3 V8	(208)[M113.943]	Chas. -F180102, -T091959	09.98- 01.03	CA1206IR	14 143 ▲	09.98- 01.03	CS1072	12 1.7
		Chas. F180102-, 09.98- 01.03		CA1776IR	14 150			
		T091959-						
CLK 500 5.0	[M113.968]					02.03-	CS1072	12 1.7
CLK 500 5.5	(A209)[M273.967]					RHD 06.06-	CS1414	12 1.4
						06.06-	CS1249	12 1.4
CLK 55 AMG 5.4	(208)[M113.981]		01.00- 06.05	CA1845IR	14 150	01.00- 06.05	CS1072	12 1.7
						01.00- 06.05	CS1249	12 1.4
	[M113.984]	Chas. -F198563, 01.00- 04.02		CA1776IR	14 150	01.00- 04.02	CS1072	12 1.7
		Chas. -T102652						
		Chas. 198564-, 01.00- 04.02		CA1845IR	14 150			
		Chas. T102653-						
	(209)[M113.987]					09.02-	CS1072	12 1.7
	[M113.987]					02.03-	CS1072	12 1.7
CLK 55 AMG 5.5	(208)[M113.981]		08.99- 06.02	CA1845IR	14 150	08.99- 06.02	CS1072	12 1.7
	[M113.984]	Chas. F180103- 08.99- 06.02		CA1776IR	14 150	05.99- 04.02	CS1072	12 1.7
		Chas. -F180102 08.99- 06.02		CA1845IR	14 150			
CLK 55 DTM AMG 5.4	(209)[M113.994]					02.03-	CS1072	12 1.7
CLS 218 2.2 CDi	(C218)[OM651.924]		04.11-	CA2072IR*	14 180			
CLS 280 3.0	(C219)[M272.943]		04.09-	CA1908IR	14 150	04.09-	CS1249	12 1.4
CLS 320 3.0 CDi	(219)[OM642.910]					01.05-	CS1072	12 1.7
	(C219)[OM642.920]					04.09-	CS1072	12 1.7
CLS 350 3.5	(219)[M272.964]		10.04-	CA1908IR	14 150	10.04-	CS1072	12 1.7
						10.04-	CS1249	12 1.4
	[M272.985]					04.06-	CS1249	12 1.4
CLS 350 3.5 CGI	(C219)[M272.985]		04.09-	CA1908IR	14 150			
CLS 500 5.0	(219)[M113.967]		10.04-	CA1776IR	14 150	10.04-	CS1072	12 1.7
CLS 55 AMG 5.4	(219)[M113.990]					01.05-	CS1072	12 1.7
CLS 280 3.0	(C219)[M272.943]		07.08-	CA1908IR	14 150	07.08-	CS1249	12 1.4
E 200 1.8 CGI	(A207)[M271.820]					01.10-	CS1283	12 1.1
	[M271.860]					01.10-	CS1283	12 1.1
	(C207)[M271.860]					01.10-	CS1283	12 1.1
E 200 1.8 Kompressor	(211)[M271.956]		04.06-	CA1752IR	14 120	04.06-	CS1283	12 1.1
			04.06-	CA1775IR	14 150			
	[M271.941]		11.02-	CA1755IR	14 150	11.02-	CS1283	12 1.1
E 200 1.8 CGI	(211)[M271.946]		11.02-	CA1752IR	14 120	11.02-	CS1283	12 1.1
	(S212)[M271.820]					11.09-	CS1283	12 1.1
	(W212)[M271.820]					08.09-	CS1283	12 1.1
E 200 1.8 NGT	(211)[M271.941]		03.02-	CA1775IR	14 150	03.02-	CS1283	12 1.1
E 200 2.0	(124)[M111.940]		06.93- 06.97	CA1044IR	14 90	06.93- 06.98	CS1075	12 1.2
			06.93- 06.98	CA1057IR	14 120			
			06.93- 06.97	CA724IR	14 70			
			06.93- 06.98	CA1044IR	14 90			
		Eng. 035551- 06.93- 06.98		CA724IR	14 70			
		Eng. -035550 06.93- 06.98		CA1044IR	14 90			
		AT, Eng. 015029- 06.93- 06.98		CA724IR	14 70			
		AT, Eng. -015028 06.93- 06.98						
	(210)[M111.942]		06.95- 01.03	CA1044IR	14 90	06.95- 01.03	CS1075	12 1.2
			06.95- 01.03	CA1057IR	14 120			
		AT, Eng. -013255 06.95- 01.03		CA1044IR	14 90			
E 200 2.0 Kompressor	(210)[M111.947]		06.97- 03.03	CA1500IR	14 90	06.97- 03.03	CS1075	12 1.2
	[M111.957]		08.00- 03.03	CA1732IR	14 90	08.00- 03.02	CS327	12 1.4
			08.00- 03.03	CA2076IR*	14 120	08.00- 03.03	CS1075	12 1.2
E 200 2.0 Diesel	(124)[OM601.912]		06.93- 06.95	CA321IR	14 55	06.93- 06.95	CS331	12 2.2
			06.93- 06.95	CA345IR	14 70			
	(210)[OM604.917]		03.93- 06.99	CA1299IR	14 115	03.97- 06.99	CS1044	12 2.0
			03.93- 06.99	CA1395IR	14 90			
E 200 2.1 CDi	(210)[OM611.961]					07.99- 03.02	CS1044	12 2.0
			07.99- 08.99	CA1481IR	14 115			
			09.99- 08.00	CA1634IR	14 150 A35			
	(211)[OM646.820]		04.06-	CA2032IR	14 180	04.06-	CS1410	12 1.7
E 200 2.1 CDi T-Model	(S211)[OM646.821]		04.06-	CA2032IR	14 180	04.06-	CS1410	12 1.7
E 200 2.2 CDi	(210)[OM611.961]					06.98- 03.02	CS1044	12 2.0
			06.98- 08.99	CA1481IR	14 115			
			09.99- 08.00	CA1634IR	14 150 A35			
	(W212)[OM651.925]		01.09-	CA2072IR*	14 180			
E 200 E 2.1 CDi	(211)[OM646.951]		07.02-	CA1701IR	14 200	07.02-	CS1044	12 2.0
			07.02-	CA1764IR	14 200			
E 220 2.1 CDi	(211)[OM646.821]		04.06-	CA2032IR	14 180	04.06-	CS1410	12 1.7
	[OM646.961]		04.06-	CA1859IR	14 200	03.02-	CS1044	12 2.0
		Eng. 30112422- 03.02-		CA1764IR	14 200	03.02-	CS1162	12 2.2
		Eng. 30085732- 03.02-						
		30112421						
		Eng. -30085731 03.02-		CA1701IR	14 200			
	(W212)[OM651.924]		01.09-	CA2072IR*	14 180			
E 220 2.2	(124)[M111.960]		06.93- 06.97	CA1044IR	14 90	06.93- 06.98	CS1075	12 1.2
			06.93- 06.98	CA1057IR	14 120			
			06.93- 06.97	CA724IR	14 70			
		Eng. 021892- 06.93- 06.98		CA1044IR	14 90			
		Eng. -021891 06.93- 06.98		CA724IR	14 70			
		AT, Eng. 043680- 06.93- 06.98		CA1044IR	14 90			
		AT, Eng. -043679 06.93- 06.98		CA724IR	14 70			



MERCEDES-BENZ Continued

E 220 2.2 CDI	(210)[OM611.961]	06.98- 08.99 CA1481IR 14 115 09.99- 08.00 CA1634IR 14 150 A35 Eng. 007601 -044618 07.99- 08.99 CA1481IR 14 115	06.98- 03.03	CS1044	12 2.0	
	(S212)[OM651.924]	11.09- CA2072IR* 14 180				
	[OM651.925]	11.09- CA2072IR* 14 180				
E 220 2.2 Diesel	(210)[OM604.912]	06.95- 07.99 CA1062IR 14 90 06.95- 07.99 CA1299IR 14 115 06.95- 06.99 CA1395IR 14 90	06.95- 07.99 06.95- 12.95	CS1044 CS1162	12 2.0 12 2.2	
E 230 2.3	(210)[M111.970]	06.95- 08.97 CA1044IR 14 90 06.95- 08.97 CA1057IR 14 120 AT, Eng. -035180 06.95- 07.97 CA1044IR 14 90	06.95- 08.97	CS1075	12 1.2	
E 230 2.5	(W211)[M272.922]	09.07- CA1908IR 14 150	09.07-	CS1249	12 1.4	
E 230 2.5 Turbo T-Model	(S211)[M272.922]	05.07- CA1908IR 14 150	05.07-	CS1249	12 1.4	
E 240 2.4	(210)[M112.911]	06.97- 03.03 CA1656IR 14 120 09.97- 03.03 CA1300IR 14 115 Chas. B080432-, 06.97- 06.99 CA1656IR 14 120 X035650- Chas. -B080431, - 09.97- 06.99 CA1300IR 14 115 X035649	09.97- 03.03 06.97- 03.03	CS1072 CS1249	12 1.7 12 1.4	
E 240 2.6	(210)[M112.914]	Chas. B080432-, 08.00- 03.02 CA1656IR 14 120 X035650- Chas. -B080431, - 08.00- 03.03 CA1300IR 14 115 X035649	08.00- 03.03 08.00- 03.03	CS1249 CS1072	12 1.4 12 1.7	
	(211)[M112.913]	03.02- 03.05 CA1656IR 14 120 03.02- 03.05 CA1776IR 14 150	03.02- 03.05	CS1249	12 1.4	
	[M112.917]	03.02- CA1656IR 14 120 03.02- CA1776IR 14 150	03.02-	CS1249	12 1.4	
E 240 2.6 4 Matic	(211)[M112.917]	09.03- CA1656IR 14 120 09.03- CA1776IR 14 150	09.03-	CS1249	12 1.4	
E 250 1.8 CGI	(A207)[M271.860]		01.10-	CS1283	12 1.1	
E 250 1.8 CGI	(C207)[M271.860]		01.09-	CS1283	12 1.1	
	(S212)[M271.860]		11.09-	CS1283	12 1.1	
	(W212)		01.09-	CS1283	12 1.1	
E 250 2.1 CDI	(W212)[OM651.924]	01.09- CA2072IR* 14 180				
E 250 2.2 CDI	(S212)[OM651.924]	11.09- CA2072IR* 14 180				
E 250 2.5 Diesel	(124)[OM605.911]	07.93- 06.95 CA1062IR 14 90 07.93- 06.95 CA833IR 14 70	07.93- 06.95	CS331	12 2.2	
	(210)[OM605.912]	06.95- 07.99 CA1062IR 14 90 06.95- 07.99 CA1299IR 14 115	06.95- 07.99 06.95- 12.95	CS1044 CS1162	12 2.0 12 2.2	
E 250 2.5 TD	(124)[OM602.962]	06.93- 06.95 CA321IR 14 55 06.93- 06.95 CA345IR 14 70 06.93- 06.96 CA1062IR 14 90 06.93- 06.96 CA833IR 14 70	06.93- 06.95 06.93- 06.95 06.93- 06.96 06.93- 06.96	CS331 CS1044 CS1162	12 2.2 12 2.0 12 2.2 12 2.2	
	(210)[OM605.912]	05.96- 06.98 CA1299IR 14 115 05.96- 06.98 CA1395IR 14 90	05.96- 06.98	CS1044	12 2.0	
	[OM605.962]	06.97- 07.99 CA1299IR 14 115 06.97- 07.99 CA1395IR 14 90	06.97- 07.99	CS1044	12 2.0	
E 270 2.7 CDI	(210)[OM612.961]	07.99- 03.02 CA1634IR 14 150 A35	07.99- 03.02 07.99- 03.02	CS1044 CS1202	12 2.0 12 2.3	
	(211)[OM647.961]	03.02- CA1701IR 14 200 03.02- CA1764IR 14 200	03.02- 06.03	CS1202	12 2.3	
	[OM647.961]	03.03- CA1701IR 14 200 03.03- CA1764IR 14 200	06.03- 03.03- 06.03	CS1044 CS1202	12 2.0 12 2.3	
E 270 T 2.7 CDI	(210)[OM612.961]	07.99- 03.03 CA1634IR 14 150 A35	07.99- 03.03	CS1044	12 2.0	
E 280 2.8	(124)[M104.942]	06.93- 06.96 CA1044IR 14 90 06.93- 06.96 CA1057IR 14 120	06.93- 06.96	CS360	12 1.7	
	(210)[M112.921]	12.96- 03.03 CA1206IR 14 143 Chas. B080432-, 12.96- 03.03 CA1656IR 14 120 Chas. -B080431, - 12.96- 03.03 CA1300IR 14 115	07.96- 03.03 07.96- 03.03	CS1072 CS1249	12 1.7 12 1.4	
E 280 2.8 4 Matic	(210)[M112.921]	07.96- 01.03 CA1206IR 14 143 Chas. B080432-, 07.96- 01.03 CA1656IR 14 120 Chas. -B080431, - 07.96- 01.03 CA1300IR 14 115	07.96- 01.03 07.96- 01.03	CS1072 CS1249	12 1.7 12 1.4	
E 280 3.0	(211)[M272.943]		03.05-	CS1249	12 1.4	
E 280 3.0 4 Matic	(211)[M272.943]		03.05-	CS1249	12 1.4	
E 280 3.0 CDI	(211)[OM642.920]		03.05-	CS1072	12 1.7	
E 280 3.2 CDI	(211)[OM648.961]	Eng. 30042544- 02.04- 03.05 CA1859IR 14 200 Eng. -30042543 05.04- 03.05 CA1764IR 14 200	05.04- 03.05	CS1044	12 2.0	
E 280 E 2.8	(210)[M104.945]	01.96- 02.97 CA1044IR 14 90 01.96- 02.97 CA1081IR 14 110	01.96- 02.97	CS360	12 1.7	
E 290 2.9 TD	(210)[OM602.982]	06.96- 06.99 CA1299IR 14 115 06.96- 06.99 CA1395IR 14 90	06.96- 06.99	CS1044	12 2.0	
E 290 E 2.9 TD	(210)[OM602.982]	01.96- 07.99 CA1299IR 14 115 01.96- 07.99 CA1395IR 14 90	01.96- 07.99	CS1044	12 2.0	
E 300 3.0 4 Matic	(124)[M103.985]	06.93- 06.95 CA263IR 14 80 06.93- 08.94 CA345IR 14 70 06.93- 06.95 CA724IR 14 70 Eng. 002377- 06.93- 06.95 CA724IR 14 70 Eng. -002376 06.93- 06.95 CA345IR 14 70 Eng. 002357- 06.93- 06.95 CA1044IR 14 90 Eng. 002188- 06.93- 06.95 CA723IR 14 80 Eng. -002187 06.93- 06.95 CA335IR 14 80	06.93- 06.95 06.93- 08.94 06.93- 06.95 06.93- 06.95 06.93- 06.95 06.93- 06.95 06.93- 06.95	06.93- 06.95	CS360	12 1.7
E 300 3.0 CDI Bluetec	(W211)[OM642.920]		09.07-	CS1072	12 1.7	
E 300 3.0 Diesel	(124)[OM606.910]	07.93- 06.95 CA1062IR 14 90 07.93- 06.95 CA833IR 14 70 06.95- 02.97 CA1062IR 14 90 06.95- 02.97 CA1299IR 14 115	07.93- 06.95 06.95- 02.97	CS331 CS1162	12 2.2 12 2.2	
E 300 3.0 TD	(124)[OM603.960]	06.93- 06.95 CA345IR 14 70 Eng. 051061- 06.93- 06.96 CA1062IR 14 90 Eng. -051060 06.93- 06.96 CA345IR 14 70 06.93- 06.96 CA1062IR 14 90 06.93- 06.96 CA833IR 14 70 (210)[OM606.962] 03.97- 11.97 CA1395IR 14 90 12.97- 07.99 CA1299IR 14 115	06.93- 06.96 06.93- 06.95 06.93- 06.96 06.93- 06.96 03.97- 07.99	CS1162 CS331 CS1162	12 2.2 12 2.2 12 2.2 12 2.2	
E 300 3.0 TD 4 Matic	(124)[OM603.963]	06.93- 06.95 CA345IR 14 70 Eng. 004326- 06.93- 06.96 CA1062IR 14 90 Eng. -004325 06.93- 06.96 CA345IR 14 70	06.93- 06.96	CS331	12 2.2	
E 300 CE 3.0	(124)[M103.983]	03.87- 12.89 CA345IR 14 70 09.89- 05.93 CA723IR 14 80 01.90- 05.93 CA724IR 14 70	03.87- 05.93	CS360	12 1.7	
E 300 TE-24 AMG 3.0	(124)[M104.980]	06.93- 06.96 CA1044IR 14 90 AT 06.93- 06.96 CA714IR 14 80	06.93- 06.96	CS1044	12 2.0	
E 320 3.0 CDI	(211)[OM642.920]		03.05-	CS1072	12 1.7	
E 320 3.0 CDI 4 Matic	(211)[OM642.910]		03.05-	CS1072	12 1.7	
	[OM642.920]		03.05-	CS1072	12 1.7	
E 320 3.2	(124)[M104.992]	10.92- 06.98 CA1044IR 14 90 06.93- 06.98 CA1057IR 14 120 [M104.995] 06.93- 06.98 CA1044IR 14 90 06.93- 06.98 CA1057IR 14 120	10.92- 06.98 06.93- 06.98 06.93- 06.98	CS360	12 1.7 12 1.7	





	(210)[M104.992]	06.95- 02.97	CA1044IR	14 90	06.95- 02.97	CS360	12 1.7
		06.95- 02.97	CA1081IR	14 110			
	[M112.941]	Chas. B080432-, 03.97- 03.03	CA1656IR	14 120	03.97- 03.03	CS1249	12 1.4
		X035650-					
		Chas. -B080431, - 03.97- 03.03	CA1300IR	14 115	03.97- 03.03	CS1072	12 1.7
		X035649					
E 320 3.2 4 Matic	(211)[M112.949]	03.02- 03.05	CA1776IR	14 150	03.02- 03.05	CS1249	12 1.4
	(210)[M112.941]	Chas. B080432-, 03.97- 01.03	CA1656IR	14 120	03.97- 01.03	CS1249	12 1.4
		X035650-					
		Chas. -B080431, - 03.97- 01.03	CA1300IR	14 115	03.97- 01.03	CS1072	12 1.7
		X035649					
E 320 3.2 CDI	(211)[M112.954]	09.03- 03.05	CA1776IR	14 150	09.03- 03.05	CS1249	12 1.4
	(210)[OM613.961]				07.99- 03.02	CS1202	12 2.3
		07.99- 05.00	CA1634IR	14 150 A35			
	[OM648.961]	Eng. 30042544- 11.02- 03.05	CA1859IR	14 200	11.02- 03.05	CS1044	12 2.0
		Eng. -30042543 11.02- 03.05	CA1764IR	14 200			
E 320 T 3.2 CDI	(210)[OM613.961]				07.99- 03.03	CS1044	12 2.0
		07.99- 05.00	CA1634IR	14 150 A35			
E 350 3.0 CDI	(A207)[OM642.836]				01.10-	CS1072	12 1.7
	(C207)[OM642.836]				01.09-	CS1072	12 1.7
	(S212)[OM642.850]				11.09-	CS1072	12 1.7
	(W212)[OM642.850]				01.09-	CS1072	12 1.7
E 350 3.0 CDI BlueTEC	(W212)[OM642.850]				01.09-	CS1072	12 1.7
E 350 3.0 Diesel BlueTEC	(S212)[OM642.850]				11.09-	CS1072	12 1.7
E 350 3.5	(211)[M272.964]				03.05-	CS1249	12 1.4
	[M272.972]				03.05-	CS1249	12 1.4
E 350 3.5 4 Matic	(211)[M272.964]				03.05-	CS1249	12 1.4
	[M272.972]				03.05-	CS1249	12 1.4
E 350 3.5 CGI	(A207)[M272.982]	01.10-	CA1908IR	14 150			
	[M272.984]	01.10-	CA1908IR	14 150			
E 350 3.5 CGI	(C207)[M272.982]	01.09-	CA1908IR	14 150			
	(W211)[M272.985]				09.07-	CS1249	12 1.4
E 36 AMG 3.6	(124)[M104.992]	03.93- 06.98	CA1044IR	14 90	03.93- 06.98	CS360	12 1.7
		03.93- 02.94	CA1081IR	14 110	07.94- 01.95	CS360	12 1.7
		05.94- 06.96	CA1057IR	14 120	04.96- 01.98	CS360	12 1.7
	(W124)	07.94- 01.95	CA1044IR	14 90			
	(W210)	04.96- 01.98	CA1044IR	14 90			
E 420 4.2	(124)[M119.975]	06.93- 06.95	CA1081IR	14 110	06.93- 06.95	CS583	12 1.7
	(210)[M119.985]	06.96- 08.97	CA1081IR	14 110	06.96- 08.97	CS583	12 1.7
		06.96- 08.97	CA1206IR	14 143			
E 420 E 4.2	(210)[M119.985]	01.96- 06.97	CA1081IR	14 110	01.96- 06.97	CS583	12 1.7
E 430 4.3	(210)[M113.940]	08.01- 03.03	CA1776IR	14 150	06.97- 03.03	CS1072	12 1.7
		06.97- 08.01	CA1206IR	14 143 ▲			
E 430 4.3 4 Matic	(210)[M113.940]	08.01- 03.02	CA1776IR	14 150	05.99- 03.02	CS1072	12 1.7
		05.99- 08.01	CA1206IR	14 143 ▲			
E 430 T 4.3 4 Matic	(210)[M113.940]	08.01- 01.03	CA1776IR	14 150	06.97- 01.03	CS1072	12 1.7
		05.99- 08.01	CA1206IR	14 143 ▲			
E 50 AMG 5.0	(210)[M119.985]	02.96- 08.97	CA1081IR	14 110	02.96- 08.97	CS583	12 1.7
		02.96- 08.97	CA1206IR	14 143			
E 500 5.0	(124)[M119.974]	06.93- 06.95	CA1081IR	14 110	06.93- 06.95	CS583	12 1.7
	(211)[M113.967]	03.02-	CA1776IR	14 150	03.02-	CS1072	12 1.7
		09.03-	CA1300IR	14 115			
E 500 5.0 4 Matic	(211)[M113.969]	09.03-	CA1776IR	14 150	09.03-	CS1072	12 1.7
	[M113.969]	09.03-	CA1776IR	14 150	09.03-	CS1072	12 1.7
E 500 5.5	(211)[M273.960]				04.06- 08.08	CS1249	12 1.4
E 500 5.5 4 Matic	(211)[M273.962]				04.06- 08.08	CS1249	12 1.4
E 55 AMG 5.4	(210)[M113.980]	08.01- 03.03	CA1776IR	14 150	08.97- 03.03	CS1072	12 1.7
		08.97- 08.01	CA1206IR	14 143 ▲			
E 55 AMG 5.4	(210)[M113.980]	08.01- 03.02	CA1776IR	14 150	08.97- 03.02	CS1072	12 1.7
		08.97- 08.01	CA1206IR	14 143 ▲			
	(211)[M113.990]				09.03-	CS1072	12 1.7
E 55 AMG 5.4 4 Matic	(210)[M113.980]	08.01- 03.03	CA1776IR	14 150	03.98- 03.03	CS1072	12 1.7
		03.98- 08.01	CA1206IR	14 143			
		07.99- 08.01	CA1845IR	14 150			
E 55 AMG 5.4 kompressor	(211)[M113.990]				10.02-	CS1072	12 1.7
E 60 AMG 6.0	(124)[M119.974]	07.93- 06.95	CA1081IR	14 110 ▲	AT 07.93- 06.95	CS583	12 1.7
E-Class 3.5 4 Matic T-Model	(S211)[M272.972]				08.04- 08.06	CS1249	12 1.4
G 270 2.7 CDI	(463)[OM612.966]				10.01-	CS1044	12 2.0
G 300 3.0 TD	(463)[OM606.964]	08.96- 11.00	CA1209IR	14 90	08.96- 11.00	CS1162	12 2.2
G 320 3.0 CDI	(463)[OM642.970]	09.06-	CA2055IR	14 180	09.06-	CS1072	12 1.7
	(W463)[OM642.970]				09.06-	CS1072	12 1.7
G 320 3.2	(463)[M104.996]	09.94- 12.97	CA1044IR	14 90	09.94- 12.97	CS360	12 1.7
	[M112.945]	12.97-	CA1300IR	14 115	07.97-	CS1249	12 1.4
G 36 AMG 3.6	(463)	01.95-	CA1044IR	14 90	01.95-	CS1044	12 2.0
					01.95-	CS360	12 1.7
G 400 4.0 CDI	(463)[OM628.962]	12.00-	CA1634IR	14 150	Change pulley, Water cooled		
G 500 5.0	(463)[M113.962]	04.98-	CA1300IR	14 115	04.98-	CS1072	12 1.7
G 500 E 5.0	(463)[M117.965]	09.93- 09.01	CA263IR	14 80	03.93- 09.01	CS583	12 1.7
G 55 AMG 5.4	(463)[M113.982]	04.99- 03.04	CA1300IR	14 115	04.99- 03.04	CS1072	12 1.7
		04.99- 03.04	CA1491IR	14 150			
	[M113.993]	06.04-	CA1300IR	14 115	06.04-	CS1072	12 1.7
GL 320 3.0 CDI	(164)[OM642.822]	09.06-	CA2055IR	14 180	09.06-	CS1072	12 1.7
GL 350 3.0 CDI	(X164)[OM642.820]				05.09-	CS1072	12 1.7
GL 350 3.0 CDI BlueTEC	(X164)[OM642.820]				12.09-	CS1072	12 1.7
GL 450 4.7	(164)[M273.923]				09.06-	CS1249	12 1.4
GL 500 5.5	(164)[M273.963]				09.06-	CS1249	12 1.4
GLK 200 2.2 CDI	(X204)[OM651.913]	07.10-	CA2072IR*	14 180			
GLK 220 2.1 CDI	(X204)[OM651.916]	12.08-	CA2072IR*	14 180			
GLK 220 2.2 CDI	(X204)[OM651.916]	12.08-	CA2072IR*	14 180	04.09-	CS1249	12 1.4
GLK 350 3.5	(X204)						
MB 100 2.4 Diesel	(631)[OM616.963]	02.88- 02.96	CA263IR	14 80	12.90- 02.96	CS555	12 2.2
		02.88- 02.96	CA87IR	14 55	02.88- 12.90	CS188	12 2.0
MB100 2.3 i	(KPA)				11.99- 05.05	CS1075	12 1.2
MB100 2.3 Diesel	(KPA)[OM661.911]	11.99- 01.03	CA1062IR	14 90	11.99- 01.03	CS331	12 2.2
MB100 2.9 Diesel	(KPA)[OM662.911]	10.01- 05.05	CA1062IR	14 90	10.01- 05.05	CS331	12 2.2
MB140 2.3 i	(KPA)				11.99- 05.05	CS1075	12 1.2
MB140 2.9 Diesel	(KPA)	10.01- 05.05	CA1062IR	14 90	10.01- 05.05	CS331	12 2.2
ML 230 2.3	(163)[M111.977]	02.98-	CA1044IR	14 90	02.98-	CS1075	12 1.2
ML 250 2.2 CDI BlueTec 4-matic	(166)	06.11-	CA2072IR*	14 180			
ML 270 2.7 CDI	(163)[OM612.963]	Eng. 30044708-			12.99-	CS1202	12 2.3
		Eng. -30044707 12.99-	CA1634IR	14 150 A35	12.99-	CS1044	12 2.0
ML 280 3.0 CDI 4 Matic	(164)[OM642.940]	07.05-	CA2055IR	14 180	07.05-	CS1072	12 1.7
ML 300 3.0 CDI 4 Matic	(W164)[OM642.820]				02.10-	CS1072	12 1.7
ML 300 3.0 CDI 4-Matic	(W164)[OM642.940]	07.09-	CA2055IR	14 180	07.09-	CS1072	12 1.7
ML 320 3.0 CDI 4 Matic	(164)[OM642.940]	07.05-	CA2055IR	14 180	07.05-	CS1072	12 1.7
ML 320 3.2 V6	(163)[M112.942]	Chas. A319543- 02.98-	CA1872IR	14 120	02.98-	CS1072	12 1.7
		Chas. -A319542 02.98-	CA1300IR	14 115	02.98-	CS1249	12 1.4
ML 350 3.0 CDI 4 Matic	(W164)[OM642.820]				02.10-	CS1072	12 1.7
ML 350 3.0 CDI 4-Matic	(W164)[OM642.820]				07.09-	CS1072	12 1.7





	[M112.943]	05.98- 10.01	CA1300IR	14 115		05.98- 10.01	CS1249	12 1.4
SL 350 3.5	(230)[M272.966]					05.98- 10.01	CS1072	12 1.7
	(R230)[M272.968]				RHD	03.06- 03.06-	CS1414	12 1.4
						04.08-	CS1249	12 1.4
SL 350 3.7	(230)[M112.973]	03.03-	CA1776IR	14 150		03.03-	CS1249	12 1.4
SL 500 5.0	(129)[M113.961]	05.98- 10.01	CA1206IR	14 143		05.98- 10.01	CS1249	12 1.4
		05.98- 10.01	CA1845IR	14 150		05.98- 10.01	CS1072	12 1.7
	[M119.972]	09.92- 09.95	CA1081IR	14 110 ▲		09.92- 09.95	CS583	12 1.7
		09.92- 09.95	CA1206IR	14 143				
	[M119.982]	09.92- 09.95	CA1081IR	14 110 ▲		09.92- 09.95	CS583	12 1.7
		09.92- 09.95	CA1206IR	14 143				
	(230)[M113.963]	10.01-	CA1776IR	14 150		10.01-	CS1072	12 1.7
SL 500 5.5	(230)[M273.965]				RHD	03.06- 03.06-	CS1414	12 1.4
						03.06-	CS1249	12 1.4
SL 55 AMG 5.4	(230)[M113.992]					10.01-	CS1072	12 1.7
	[M113.995]					03.06-	CS1072	12 1.7
SL 55 AMG 5.5	(230)[M113.992]	10.01- 12.05	CA1776IR	14 150		10.01- 12.05	CS1072	12 1.7
SL 600 5.5	(230)[M275.951]					04.03-	CS1072	12 1.7
	[M275.954]					03.06-	CS1072	12 1.7
SL 600 6.0	(129)[M120.983]	09.95- 08.01	CA1081IR	14 110				
		09.95- 08.01	CA1206IR	14 143 ▲				
SL 600 6.9	(129)[M120.981]	07.92- 09.95	CA1081IR	14 110				
SL 65 AMG 6.0	(230)[M275.981]					09.04-	CS1072	12 1.7
SLK 200 1.8 Kompressor	(171)[M271.944]	03.04-	CA1752IR	14 120		03.04-	CS1283	12 1.1
	(R171)[M271.954]	03.04-	CA1752IR	14 120		03.04-	CS1283	12 1.1
SLK 200 2.0	(170)[M111.946]	09.96- 03.00	CA1044IR	14 90		09.96- 03.00	CS1075	12 1.2
SLK 200 2.0 Kompressor	(170)[M111.943]	10.96- 03.00	CA1500IR	14 90		10.96- 03.00	CS1075	12 1.2
	[M111.958]	03.00-	CA1500IR	14 90		03.00-	CS327	12 1.4
						03.00-	CS1075	12 1.2
SLK 230 2.3 Kompressor	(170)[M111.973]	09.96- 03.00	CA1500IR	14 90		09.96- 03.00	CS1075	12 1.2
	[M111.983]	02.00- 03.04	CA1500IR	14 90		02.00- 03.04	CS1075	12 1.2
SLK 250 1.8	(R172)[M271.861]					02.11-	CS1283	12 1.1
SLK 250 2.2 CDI	(R172)	01.12-	CA2072IR*	14 180				
SLK 280 3.0	(171)[M272.942]	01.05-	CA1908IR	14 150		RHD 01.05-	CS1414	12 1.4
						01.05-	CS1249	12 1.4
	(R171)[M272.942]	04.09-	CA1908IR	14 150				
SLK 32 AMG 3.2 Kompressor	(170)[M112.960]	03.01- 04.04	CA1872IR	14 120 ▲		03.01- 04.04	CS1249	12 1.4
SLK 320 3.2	(170)[M112.947]	06.99- 03.04	CA1872IR	14 120		06.99- 03.04	CS1072	12 1.7
						06.99- 03.04	CS1249	12 1.4
SLK 350 3.5	(R171)[M272.969]	01.08-	CA1908IR	14 150		01.08-	CS1249	12 1.4
SLK 350 AMG 3.5	(171)[M272.963]	06.04-	CA1908IR	14 150		06.04-	CS1249	12 1.4
SLK 55 AMG 5.4	(171)[M113.989]					06.04-	CS1072	12 1.7
SLR 5.4	(199)[M155.980]	04.04-	CA1776IR	14 150		04.04-	CS1072	12 1.7
	[M155.980]	04.04-	CA1776IR	14 150		04.04-	CS1072	12 1.7
SLR 5.4 722 Edition	(199)[M155.980]	10.06-	CA1776IR	14 150		10.06-	CS1072	12 1.7
SLR 5.4 Roadster	[M155.980]	10.06-	CA1776IR	14 150		10.06-	CS1072	12 1.7
Sprinter 2.2 CDI 313 4x4	(906)[OM651.956]	06.06-	CA2053IR	14 220				
		06.06-	CA2072IR*	14 180				
Sprinter 3.0 CDI 319	(906)[OM642.992]					03.09-	CS1072	12 1.7
Sprinter 3.0 CDI 319 4x4	(906)[OM642.992]				Chas. -410963	03.09-	CS1072	12 1.7
Sprinter 208 2.1 CDI	(901.902)[OM611.987]	04.00-	CA1481IR	14 115		04.00-	CS1044	12 2.0
		04.00-	CA1489IR	14 90				
		04.00-	CA1630IR	14 150				
Sprinter 208 2.3 Diesel	(901.902)[OM601.943]	02.95- 04.00	CA1209IR	14 90		01.95- 03.00	CS1162	12 2.2
		Eng. -509806 09.96- 03.97	CA1062IR	14 90		01.95- 04.00	CS1044	12 2.0
		Eng. 471030- 01.95- 04.00	CA1299IR	14 115				
		Eng. 385588-509806 02.95- 03.97	CA1062IR	14 90				
		Eng. 385588- 02.95- 04.00	CA1209IR	14 90				
		Eng. -385587 01.95- 04.00	CA833IR	14 70				
Sprinter 209 2.1 CDI	(906)[OM646.984]	06.06-	CA2038IR	14 180		06.06-	CS1410	12 1.7
		06.06-	CA2053IR	14 220		06.06-	CS1044	12 2.0
Sprinter 210 2.1 CDI	(903)[OM651.956]	03.09-	CA2053IR	14 220				
		03.09-	CA2072IR*	14 180				
	(906)[OM651]	03.09-	CA2053IR	14 220		03.09-	CS1410	12 1.7
		03.09-	CA2072IR*	14 180				
	[OM651.956]	03.09-	CA2053IR	14 220				
		03.09-	CA2072IR*	14 180				
Sprinter 210 2.9 Diesel	(901.902)[OM602.980]	01.97- 04.00	CA1299IR	14 115		01.97- 04.00	CS1044	12 2.0
		03.97- 04.00	CA1209IR	14 90				
		Eng. 025811- 01.97- 04.00	CA1209IR	14 90				
		Eng. -025810 01.97- 04.00	CA1062IR	14 90				
		AT, Eng. 001129- 01.97- 04.00	CA1209IR	14 90				
		AT, Eng. -001128 01.97- 04.00	CA1062IR	14 90				
	(902.902)[OM602.980]	Eng. 025811-, 01.97- 03.00	CA1209IR	14 90		01.97- 03.00	CS1044	12 2.0
		001129-						
		Eng. -025810, - 01.97- 03.00	CA1299IR	14 115				
		001128						
Sprinter 211 2.1 CDI	(901.902)[OM611.981]	04.00-	CA1481IR	14 115		04.00-	CS1044	12 2.0
		04.00-	CA1489IR	14 90				
		04.00-	CA1630IR	14 150				
	(906)[OM646.985]	06.06-	CA2038IR	14 180		06.06-	CS1044	12 2.0
		06.06-	CA2053IR	14 220		06.06-	CS1410	12 1.7
Sprinter 212 2.9 Diesel	(901.902)[OM602.980]	02.95- 04.00	CA1299IR	14 115		02.95- 04.00	CS1044	12 2.0
		02.95- 04.00	CA833IR	14 70		02.95- 12.95	CS1162	12 2.2
		Eng. 025811-, 02.95- 03.00	CA1209IR	14 90				
		Eng. 025811- 02.95- 04.00	CA1209IR	14 90				
		Eng. -025810, - 02.95- 03.00	CA1062IR	14 90				
		001128						
		Eng. -025810 02.95- 04.00	CA1062IR	14 90				
		AT, Eng. 001129- 02.95- 04.00	CA1209IR	14 90				
		AT, Eng. -001128 02.95- 04.00	CA1062IR	14 90				
Sprinter 213 2.1 CDI	(901.902)[OM611.981]	04.00-	CA1481IR	14 115		04.00-	CS1044	12 2.0
		04.00-	CA1489IR	14 90				
		04.00-	CA1630IR	14 150				
	(906)[OM646.986]	06.06-	CA2038IR	14 180		06.06-	CS1044	12 2.0
		06.06-	CA2053IR	14 220		06.06-	CS1410	12 1.7
	[OM651]	03.09-	CA2053IR	14 220		03.09-	CS1410	12 1.7
		03.09-	CA2072IR*	14 180				
Sprinter 214 2.3	(901.902)[M111.979]	02.95-	CA1300IR	14 115		02.95-	CS1075	12 1.2
		02.95-	CA1301IR	14 90				
		02.95-	CA1845IR	14 150				
	[M111.984]	04.00-	CA1300IR	14 115		04.00-	CS1075	12 1.2
		04.00-	CA1301IR	14 90				
		04.00-	CA1845IR	14 150				
Sprinter 214 2.3 NGT	(901.902)[M111.984]	04.00-	CA1301IR	14 90		04.00-	CS1075	12 1.2
		04.00-	CA1845IR	14 150		04.00-	CS1075	12 1.2
		04.00-	CA1845IR	14 150		06.06-	CS1044	12 2.0
		04.00-	CA1301IR	14 90		06.06-	CS1410	12 1.7
Sprinter 215 2.1 CDI	(906)	06.06-	CA2038IR	14 180				



MERCEDES-BENZ Continued

		06.06-	CA2053IR	14 220				
Sprinter 216 1.8	(906)[M271.951]	09.08-	CA1775IR	14 150	09.08-	CS1283	12 1.1	
Sprinter 216 2.1 CDI	(906)[OM651]	03.09-	CA2053IR	14 220	03.09-	CS1410	12 1.7	
		03.09-	CA2072IR*	14 180				
Sprinter 216 2.7 CDI	(901,902)[OM612.981]	04.00-	CA1481IR	14 115	04.00-	CS1044	12 2.0	
		04.00-	CA1489IR	14 90	04.00-	CS1202	12 2.3	
		04.00-	CA1630IR	14 150				
Sprinter 219 3.0 CDI	(906)[OM642]				03.09-	CS1072	12 1.7	
Sprinter 224 3.5	(906)[M272.979]	06.06-	CA1908IR	14 150	06.06-	CS1414	12 1.4	
Sprinter 308 2.1 CDI	(903)[OM611.987]	04.00-	CA1481IR	14 115	04.00-	CS1044	12 2.0	
		04.00-	CA1489IR	14 90				
		04.00-	CA1630IR	14 150				
Sprinter 308 2.3 Diesel	(903)[OM601.943]	02.95- 04.00	CA1209IR	14 90	02.95- 04.00	CS1044	12 2.0	
		11.96- 04.00	CA1299IR	14 115	02.95- 01.97	CS1162	12 2.2	
	Eng. 471030-	02.95- 03.00	CA1299IR	14 115	02.95- 03.00	CS1044	12 2.0	
	Eng. 385588 -509806	02.95- 03.97	CA1062IR	14 90	04.00-	CS1075	12 1.2	
		Eng. 385588-	04.95- 03.00	CA1209IR	14 90			
		Eng. -385587	02.95- 04.00	CA833IR	14 70			
		Eng. -385587	02.95- 03.00	CA1299IR	14 115			
		Eng. -385587	02.95- 03.00	CA1209IR	14 90			
Sprinter 308	(903)	Eng. -385587	04.00-	CA1845IR	14 150			
		Eng. -385587	04.00-	CA1301IR	14 90			
Sprinter 309 2.1 CDI	(906)[OM646.984]	06.06-	CA2038IR	14 180	06.06-	CS1044	12 2.0	
		06.06-	CA2053IR	14 220	06.06-	CS1410	12 1.7	
Sprinter 310 2.1 CDI	(906)[OM651.956]	03.09-	CA2053IR	14 220				
		03.09-	CA2072IR*	14 180				
Sprinter 310 2.9 Diesel	(903)[OM602.980]	01.97- 04.00	CA1299IR	14 115	01.97- 04.00	CS1044	12 2.0	
		Eng. 025811-	01.97- 04.00	CA1209IR	14 90			
		Eng. -025810	01.97- 04.00	CA1062IR	14 90			
		AT, Eng. 001129-	01.97- 04.00	CA1209IR	14 90			
		AT, Eng. -001128	01.97- 04.00	CA1062IR	14 90			
Sprinter 310 2.9 Diesel 4x4	(903)[OM602.980]	01.97- 03.00	CA1299IR	14 115	01.97- 03.00	CS1044	12 2.0	
		Eng. 025811-	01.97- 03.00	CA1209IR	14 90			
		Eng. -025810	01.97- 03.00	CA1062IR	14 90			
		AT, Eng. 001129-	01.97- 03.00	CA1209IR	14 90			
		AT, Eng. -001128	01.97- 03.00	CA1062IR	14 90			
Sprinter 311 2.1 CDI	(903)[OM611.981]	04.00-	CA1481IR	14 115	04.00-	CS1044	12 2.0	
		04.00-	CA1489IR	14 90				
		04.00-	CA1630IR	14 150				
	(906)[OM646.985]	06.06-	CA2038IR	14 180	06.06-	CS1044	12 2.0	
		06.06-	CA2053IR	14 220	06.06-	CS1410	12 1.7	
Sprinter 311 2.1 CDI 4x4	(903)[OM611.981]	08.02- 05.06	CA1481IR	14 115	08.02- 05.06	CS1044	12 2.0	
		08.02- 05.06	CA1489IR	14 90				
		08.02- 05.06	CA1630IR	14 150				
	(906)[OM646.985]	02.08-	CA1846IR	14 200	A25 02.08-	CS1485*	12 2.0	
		02.08-	CA2038IR	14 180	02.08-	CS1410	12 1.7	
		02.08-	CA2053IR	14 220	02.08-	CS1044	12 2.0	
Sprinter 312 2.9 Diesel	(903)[OM602.980]	02.95- 04.00	CA1299IR	14 115	02.95- 04.00	CS1044	12 2.0	
		02.95- 04.00	CA833IR	14 70	02.95- 04.00	CS1162	12 2.2	
		Eng. 025811-	02.95- 04.00	CA1209IR	14 90			
		Eng. -025810	02.95- 04.00	CA1062IR	14 90			
		AT, Eng. 001129-	02.95- 04.00	CA1209IR	14 90			
		AT, Eng. -001128	02.95- 04.00	CA1062IR	14 90			
Sprinter 312 2.9 Diesel 4x4	(903)[OM602.980]	02.95- 08.02	CA1299IR	14 115	02.95- 08.02	CS1044	12 2.0	
		05.97- 08.02	CA1209IR	14 90				
		Eng. 025811-	02.95- 03.00	CA1209IR	14 90			
		Eng. -025810	02.95- 03.00	CA1062IR	14 90			
		AT, Eng. 001129-	02.95- 03.00	CA1209IR	14 90			
		AT, Eng. -001128	02.95- 03.00	CA1062IR	14 90			
Sprinter 313 2.1 CDI	(903)[OM611.981]	04.00-	CA1481IR	14 115	04.00-	CS1044	12 2.0	
		04.00-	CA1489IR	14 90				
		04.00-	CA1630IR	14 150				
	(906)[OM646.986]	06.06-	CA1846IR	14 200	06.06-	CS1410	12 1.7	
		06.06-	CA2038IR	14 180	A25 06.06-	CS1485*	12 2.0	
		06.06-	CA2053IR	14 220	06.06-	CS1044	12 2.0	
Sprinter 313 2.1 CDI 4x4	(903)[OM611.981]	08.02- 05.06	CA1481IR	14 115	08.02- 05.06	CS1044	12 2.0	
		08.02- 05.06	CA1489IR	14 90				
		08.02- 05.06	CA1630IR	14 150				
Sprinter 314 2.3	(903)[M111.979]	02.95- 08.02	CA1300IR	14 115	02.95- 08.02	CS1075	12 1.2	
		02.95- 08.02	CA1301IR	14 90				
		02.95- 08.02	CA1845IR	14 150				
	[M111.984]	04.00- 05.06	CA1300IR	14 115	04.00- 05.06	CS1075	12 1.2	
		04.00- 05.06	CA1301IR	14 90				
		04.00- 05.06	CA1845IR	14 150				
Sprinter 314 2.3 4x4	(903)[M111.979]	02.95- 03.00	CA1300IR	14 115	02.95- 03.00	CS1075	12 1.2	
		02.95- 03.00	CA1301IR	14 90				
		02.95- 03.00	CA1845IR	14 150				
	[M111.984]	04.00- 05.06	CA1300IR	14 115	04.00- 05.06	CS1075	12 1.2	
		04.00- 05.06	CA1301IR	14 90				
		04.00- 05.06	CA1845IR	14 150				
Sprinter 314 2.3 NGT	(903)[M111.984]	04.00-	CA1301IR	14 90	04.00-	CS1075	12 1.2	
		04.00-	CA1845IR	14 150	04.00-	CS1075	12 1.2	
		04.00-	CA1301IR	14 90	06.06-	CS1044	12 2.0	
		04.00-	CA1845IR	14 150	06.06-	CS1410	12 1.7	
Sprinter 315 2.1 CDI	(906)	06.06-	CA2038IR	14 180				
		06.06-	CA2053IR	14 220				
Sprinter 315 2.1 CDI 4x4	(906)[OM646.990]	02.08-	CA1846IR	14 200	02.08-	CS1044	12 2.0	
		02.08-	CA2038IR	14 180	02.08-	CS1410	12 1.7	
		02.08-	CA2053IR	14 220	A25 02.08-	CS1485*	12 2.0	
Sprinter 316 1.8	(906)[M271.951]	09.08-	CA1775IR	14 150	09.08-	CS1283	12 1.1	
Sprinter 316 1.8 Diesel NGT	(906)[M271.951]	09.08-	CA1775IR	14 150	09.08-	CS1283	12 1.1	
Sprinter 316 2.1 CDI	(906)[OM651]	03.09-	CA2053IR	14 220	03.09-	CS1410	12 1.7	
		03.09-	CA2072IR*	14 180				
Sprinter 316 2.1 CDI 4x4	(906)[OM651]	03.09-	CA2053IR	14 220	03.09-	CS1410	12 1.7	
		03.09-	CA2072IR*	14 180				
Sprinter 316 2.7 CDI	(903)[OM612.981]	04.00-	CA1481IR	14 115	04.00-	CS1202	12 2.3	
		04.00-	CA1489IR	14 90	04.00-	CS1044	12 2.0	
		04.00-	CA1630IR	14 150				
Sprinter 316 2.7 CDI 4x4	(903)[OM612.981]	08.02- 05.06	CA1481IR	14 115	08.02- 05.06	CS1202	12 2.3	
		08.02- 05.06	CA1489IR	14 90	08.02- 05.06	CS1044	12 2.0	
		08.02- 05.06	CA1630IR	14 150				
Sprinter 319 3.0 CDI 4x4	(906)[OM642]				03.09-	CS1072	12 1.7	
	[OM642.992]				03.09-	CS1072	12 1.7	
Sprinter 324 3.5	(906)	06.06-	CA1908IR	14 150	06.06-	CS1414	12 1.4	
Sprinter 408 2.1 CDI	(904)[OM611.987]	04.00- 05.06	CA1481IR	14 115	04.00- 05.06	CS1044	12 2.0	
		04.00- 05.06	CA1489IR	14 90				
		04.00- 05.06	CA1630IR	14 150				
Sprinter 408 2.3 Diesel	(904)[OM601.943]	02.95- 03.00	CA1062IR	14 90	02.95- 03.00	CS1162	12 2.2	
		02.95- 03.00	CA1209IR	14 90	02.95- 03.00	CS1044	12 2.0	
		02.95- 03.00	CA1299IR	14 115				



		02.95- 03.95	CA833IR	14 70				
		Eng. 471030- 02.95- 03.00	CA1299IR	14 115				
Sprinter 410 2.9 Diesel	(904)[OM602.980]	01.97- 03.00	CA1299IR	14 115	01.97- 03.00	CS1044	12 2.0	
		Eng. 001129-, 01.97- 03.00	CA1209IR	14 90				
		Eng. -001128-, 01.97- 03.00	CA1062IR	14 90				
		025810						
Sprinter 410 2.9 Diesel 4x4	(904)[OM602.980]	01.97- 03.00	CA1299IR	14 115	01.97- 03.00	CS1044	12 2.0	
		Eng. 001129-, 01.97- 03.00	CA1209IR	14 90				
		Eng. -001128-, 01.97- 03.00	CA1062IR	14 90				
		025810						
Sprinter 411 2.1 CDI	(904)[OM611.981]	12.99- 05.06	CA1481IR	14 115	12.99- 05.06	CS1044	12 2.0	
		12.99- 05.06	CA1489IR	14 90				
		12.99- 05.06	CA1630IR	14 150				
Sprinter 411 2.1 CDI 4x4	(904)[OM611.981]	04.00- 05.06	CA1481IR	14 115	04.00- 05.06	CS1044	12 2.0	
		04.00- 05.06	CA1489IR	14 90				
		04.00- 05.06	CA1630IR	14 150				
Sprinter 412 2.9 Diesel	(904)[OM602.980]	02.95- 03.00	CA1299IR	14 115	02.95- 03.00	CS1162	12 2.2	
		Eng. 001129-, 02.95- 03.00	CA1209IR	14 90	02.95- 03.00	CS1044	12 2.0	
		Eng. -001128-, 02.95- 03.00	CA1062IR	14 90				
		025810						
		Chas. 001129-, 02.95- 03.00	CA1209IR	14 90				
		025811-						
		Chas. -001128-, 02.95- 03.00	CA1062IR	14 90				
		025810						
Sprinter 412 2.9 Diesel 4x4	(904)[OM602.980]	02.95- 03.00	CA1299IR	14 115	02.95- 03.00	CS1162	12 2.2	
		Eng. 001129-, 02.95- 03.00	CA1209IR	14 90	02.95- 03.00	CS1044	12 2.0	
		Eng. -001128-, 02.95- 03.00	CA1062IR	14 90				
		025810						
		Chas. 001129-, 02.95- 03.00	CA1209IR	14 90				
		025811-						
		Chas. -001128-, 02.95- 03.00	CA1062IR	14 90				
		025810						
Sprinter 413 2.1 CDI	(904)[OM611.981]	12.99- 05.06	CA1481IR	14 115	12.99- 05.06	CS1044	12 2.0	
		12.99- 05.06	CA1489IR	14 90				
		12.99- 05.06	CA1630IR	14 150				
	(906)[OM651]	06.06-	CA2053IR	14 220				
		06.06-	CA2072IR*	14 180				
Sprinter 413 2.1 CDI 4x4	(904)[OM611.981]	04.00- 05.06	CA1481IR	14 115	04.00- 05.06	CS1044	12 2.0	
		04.00- 05.06	CA1489IR	14 90				
		04.00- 05.06	CA1630IR	14 150				
Sprinter 414 2.3	(904)[M111.979]	02.95- 08.02	CA1300IR	14 115	02.95- 08.02	CS1075	12 1.2	
		02.95- 08.02	CA1301IR	14 90				
		02.95- 08.02	CA1845IR	14 150				
	[M111.984]	04.00- 05.06	CA1300IR	14 115	04.00- 05.06	CS1075	12 1.2	
		04.00- 05.06	CA1301IR	14 90				
		04.00- 05.06	CA1845IR	14 150				
Sprinter 414 2.3 4x4	(904)[M111.979]	02.95- 08.02	CA1300IR	14 115	02.95- 08.02	CS1075	12 1.2	
		02.95- 08.02	CA1301IR	14 90				
		02.95- 08.02	CA1845IR	14 150				
	[M111.984]	04.00- 05.06	CA1300IR	14 115	04.00- 05.06	CS1075	12 1.2	
		04.00- 05.06	CA1301IR	14 90				
		04.00- 05.06	CA1845IR	14 150				
Sprinter 415 2.1 CDI	(906)[OM646]	06.06-	CA1846IR	14 200	A25 06.06-	CS1485*	12 2.0	
		06.06-	CA2038IR	14 180	06.06-	CS1044	12 2.0	
		06.06-	CA2053IR	14 220	06.06-	CS1410	12 1.7	
Sprinter 416 2.1 CDI	(906)[OM651]	03.09-	CA2053IR	14 220	03.09-	CS1410	12 1.7	
		03.09-	CA2072IR*	14 180				
Sprinter 416 2.7 CDI	(904)[OM612.981]	12.99- 05.06	CA1481IR	14 115	04.00- 05.06	CS1044	12 2.0	
		12.99- 05.06	CA1489IR	14 90	12.99- 05.06	CS1202	12 2.3	
		12.99- 05.06	CA1630IR	14 150				
Sprinter 416 2.7 CDI 4x4	(904)[OM612.981]	04.00- 05.06	CA1481IR	14 115	04.00- 05.06	CS1044	12 2.0	
		04.00- 05.06	CA1489IR	14 90	04.00- 05.06	CS1202	12 2.3	
		04.00- 05.06	CA1630IR	14 150				
Sprinter 419 3.0 CDI	(906)[OM642]				03.09-	CS1072	12 1.7	
Sprinter 424 3.5	(906)[M272.979]	06.06-	CA1908IR	14 150	06.06-	CS1414	12 1.4	
Sprinter 509 2.1 CDI	(906)[OM646.984]	06.06-	CA2038IR	14 180	06.06-	CS1410	12 1.7	
		06.06-	CA2053IR	14 220	06.06-	CS1044	12 2.0	
Sprinter 510 2.1 CDI	(906)[OM651.956]	03.09-	CA2053IR	14 220				
		03.09-	CA2072IR*	14 180				
Sprinter 511 2.1 CDI	(906)[OM646.985]	06.06-	CA2038IR	14 180	06.06-	CS1044	12 2.0	
		06.06-	CA2053IR	14 220	06.06-	CS1410	12 1.7	
Sprinter 513 2.1 CDI	(906)[OM646.986]	06.06-	CA2053IR	14 220	06.06-	CS1044	12 2.0	
		06.06-	CA2072IR*	14 180	06.06-	CS1410	12 1.7	
Sprinter 515 2.1 CDI	(906)	06.06-	CA2053IR	14 220				
		06.06-	CA2038IR	14 180				
Sprinter 516 1.8	(906)[M271.951]	09.08-	CA1775IR	14 150	09.08-	CS1283	12 1.1	
Sprinter 516 1.8 Diesel NGT	(906)[M271.951]	09.08-	CA1775IR	14 150	09.08-	CS1283	12 1.1	
Sprinter 516 2.1 CDI	(906)[OM651]	03.09-	CA2053IR	14 220	03.09-	CS1410	12 1.7	
		03.09-	CA2072IR*	14 180				
Sprinter 519 3.0 CDI	(906)[OM642]				03.09-	CS1072	12 1.7	
Sprinter 524 3.5	(906)[M272.979]	06.06-	CA1908IR	14 150	06.06-	CS1414	12 1.4	
Sprinter 616 2.7 CDI	[OM612.981]	04.01-	CA1481IR	14 115	04.01-	CS1044	12 2.0	
		04.01-	CA1489IR	14 90				
		04.01-	CA1630IR	14 150				
V 200 2.0	(638)[M111.948]	04.96- 07.03	CA1300IR	14 115	04.96- 07.03	CS1075	12 1.2	
		04.96- 07.03	CA1301IR	14 90				
		02.97- 07.03	CA1845IR	14 150				
V 200 2.2 CDI	(638)[OM611.980]	03.99- 07.03	CA1481IR	14 115	03.99- 07.03	CS1044	12 2.0	
		03.99- 07.03	CA1489IR	14 90				
		03.99- 07.03	CA1630IR	14 150				
V 220 2.2 CDI	(638)[OM611.980]	03.99- 07.03	CA1481IR	14 115	03.99- 07.03	CS1044	12 2.0	
		03.99- 07.03	CA1489IR	14 90				
		03.99- 07.03	CA1630IR	14 150				
V 230 2.3	[M111.978]	10.96- 07.03	CA1300IR	14 115	10.96- 07.03	CS1075	12 1.2	
		10.96- 07.03	CA1301IR	14 90				
		10.96- 07.03	CA1845IR	14 150				
V 230 2.3 TD	[OM601.970]	04.96- 02.97	CA1090IR	14 90	04.96- 07.03	CS1044	12 2.0	
		04.96- 07.03	CA1254IR	14 115	09.96- 07.03	CS1162	12 2.2	
		04.96- 07.03	CA1563IR	14 90				
		09.96- 07.03	CA1571IR#	14 115				
V 280 2.8	(638)[M104.900]	04.96- 07.03	CA1143IR	14 150	04.96- 07.03	CS789	12 1.8	
Vaneo 1.6	[M166.961]	02.02-	CA1342IR	14 90	Chas. -N230982 02.02- 06.03-	CS1384	12 0.8	
					Chas. N230983- 06.03-	CS1117	12 1.0	
Vaneo 1.7 CDI	[OM668.914]	02.02- 08.05	CA1390IR	14 90	11.01- 08.05	CS1172	12 1.7	
		02.02- 08.05	CA1680IR	14 150 A35				
Vaneo 1.9	[M166.991]	02.02-	CA1390IR	14 90	Chas. N230983- 02.02-	CS1117	12 1.0	
					Chas. -N230982 02.02- 07.03	CS1338	12 1.3	
Viano 2.1 CDI	(W639)[OM651.940]	07.10-	CA2072IR*	14 180				
Viano 2.1 CDI 4 Matic	(639)[OM642.982]	07.05-	CA1846IR	14 200	07.05-	CS1044	12 2.0	
		07.05-	CA2038IR	14 180				
		AT 07.05-	CA1840IR	14 200				



MERCEDES-BENZ Continued

	[OM646.982]	07.05- AT 07.05-	CA1846IR CA1840IR	14 200 14 200		07.05-	CS1044	12 2.0
Viano 2.1 CDI 4-matic	(W639)[OM651.940]	07.10-	CA2072IR*	14 180				
Viano 2.2 CDI	(639)[OM646.982]	09.03- 09.03- AT 09.03-	CA1846IR CA2038IR CA1840IR	14 200 14 180 14 200		09.03- 09.03-	CS1162 CS1044	12 2.2 12 2.0
Viano 3.0 CDI	(639)[OM642.990]					03.06-	CS1072	12 1.7
	(W639)[OM642]					07.10-	CS1072	12 1.7
Viano 3.2	(639)[M112.951]	09.03-	CA1656IR	14 120		09.03-	CS1249	12 1.4
Viano 3.5 126	(W639)[M272.978]	09.07-	CA1908IR	14 150		09.07-	CS1249	12 1.4
Viano 3.7	(639)[M112.976]	06.04-	CA1656IR	14 120		06.04-	CS1249	12 1.4
Vito 2.1 CDI	(W639)[OM646.981]	08.06- 08.06- AT 08.06-	CA1846IR CA2038IR CA1840IR	14 200 14 180 14 200		08.06-	CS1044	12 2.0
Vito 2.1 CDI 110	(W639)[OM651.940]	09.10-	CA2072IR*	14 180				
Vito 2.1 CDI 113	(W639)[OM651.940]	09.10-	CA2072IR*	14 180				
Vito 2.1 CDI 113 4x4	(W639)[OM651.940]	09.10-	CA2072IR*	14 180				
Vito 2.1 CDI 116	(W639)[OM651.940]	09.10-	CA2072IR*	14 180				
Vito 2.1 CDI 116 4x4	(W639)[OM651.940]	09.10-	CA2072IR*	14 180				
Vito 2.2 CDI	(W639)[OM646.981]	09.07- 09.07- AT 09.07-	CA1846IR CA2038IR CA1840IR	14 200 14 180 14 200		09.07-	CS1044	12 2.0
Vito 2.2 CDI 4x4	(W639)[OM646.980]	09.07- 09.07- AT 09.07-	CA1846IR CA2038IR CA1840IR	14 200 14 180 14 200		09.07-	CS1044	12 2.0
	[OM646.981]	09.07- 09.07- AT 09.07-	CA1846IR CA2038IR CA1840IR	14 200 14 180 14 200		09.07-	CS1044	12 2.0
	[OM646.982]	09.07- 09.07- AT 09.07-	CA1846IR CA2038IR CA1840IR	14 200 14 180 14 200		09.07-	CS1044	12 2.0
Vito 3.0 CDI	(W639)[OM642.990]					09.07-	CS1072	12 1.7
Vito 3.0 CDI 122	(W639)[OM642.9..]					09.10-	CS1072	12 1.7
Vito 3.5	(W639)[M272.978]	09.07-	CA1908IR	14 150		09.07-	CS1249	12 1.4
Vito 3.7	(W639)[M112.976]	06.04- 07.08	CA1656IR	14 120		06.04- 07.08	CS1249	12 1.4
Vito / Mixto 2.1 CDI 110	(W639)[OM651.940]	09.10-	CA2072IR*	14 180				
Vito / Mixto 2.1 CDI 113	(W639)[OM651.940]	09.10-	CA2072IR*	14 180				
Vito / Mixto 2.1 CDI 116	(W639)[OM651.940]	09.10-	CA2072IR*	14 180				
Vito / Mixto 3.0 CDI 122	(W639)[OM642.9..]					09.10-	CS1072	12 1.7
Vito 108 2.2 CDI	(638)[OM611A]	03.99- 07.03	CA1481IR	14 115		03.99- 07.03	CS1044	12 2.0
		03.99- 07.03	CA1489IR	14 90				
		03.99- 07.03	CA1630IR	14 150				
	[OM611LA]	03.99- 07.03	CA1481IR	14 115		03.99- 07.03	CS1044	12 2.0
		03.99- 07.03	CA1489IR	14 90				
		03.99- 07.03	CA1630IR	14 150				
Vito 108 2.3 Diesel	(638)[OM601.942]	02.96- 07.03	CA1090IR	14 90		02.96- 07.03	CS1044	12 2.0
		02.96- 07.03	CA1254IR	14 115		02.96- 01.97	CS1162	12 2.2
		02.96- 07.03	CA1563IR	14 90				
		02.96- 07.03	CA1571IR#	14 115				
Vito 109 2.1 CDI	(639)[OM646.980]	09.06- 09.06- AT 09.06-	CA1846IR CA2038IR CA1840IR	14 200 14 180 14 200		09.06-	CS1044	12 2.0
	[OM646.983]	09.03- AT 09.03-	CA1846IR CA1840IR	14 200 14 200		09.03-	CS1044	12 2.0
Vito 110 2.2 CDI	(638)[OM611LA]	03.99- 07.03	CA1481IR	14 115		03.99- 07.03	CS1044	12 2.0
		03.99- 07.03	CA1489IR	14 90				
		03.99- 07.03	CA1630IR	14 150				
Vito 110 2.3 Diesel	(638)[OM601.970]	02.96- 07.03	CA1090IR	14 90		02.96- 01.97	CS1162	12 2.2
		02.96- 07.03	CA1254IR	14 115		02.96- 07.03	CS1044	12 2.0
		02.96- 07.03	CA1563IR	14 90				
		02.96- 07.03	CA1571IR#	14 115				
Vito 110 2.3 TD	(638)[OM601.970]	11.95- 07.03	CA1563IR	14 90		02.96- 07.03	CS1044	12 2.0
		11.95- 07.03	CA1571IR#	14 115		11.95- 01.97	CS1162	12 2.2
		Eng. -736262 11.95- 07.03	CA1480IR	14 143				
		Eng. -735807 11.95- 07.03	CA1090IR	14 90				
		Eng. 494180- 11.95- 07.03	CA1254IR	14 115				
Vito 111 2.2 CDI	(639)[OM646.982]	09.03- 10.06 AT 09.03- 10.06	CA1846IR CA1840IR	14 200 14 200		09.03- 10.06	CS1044	12 2.0
Vito 112 2.2 CDI	(638)[OM611.980]	03.99- 07.03	CA1481IR	14 115		03.99- 07.03	CS1044	12 2.0
		03.99- 07.03	CA1489IR	14 90				
		03.99- 07.03	CA1630IR	14 150				
Vito 113 2.0	(638)[M111.948]	11.95- 07.03	CA1300IR	14 115		11.95- 07.03	CS1075	12 1.2
		11.95- 07.03	CA1301IR	14 90				
		11.95- 07.03	CA1845IR	14 150				
Vito 114 2.3	(638)[M111.978]	11.95- 09.03	CA1300IR	14 115		11.95- 09.03	CS1075	12 1.2
		11.95- 09.03	CA1301IR	14 90				
		11.95- 09.03	CA1845IR	14 150				
Vito 115 2.2 CDI	(639)[OM646.982]	09.03- 09.03- AT 09.03-	CA1846IR CA2038IR CA1840IR	14 200 14 180 14 200		09.03-	CS1044	12 2.0
Vito 119 3.2	(639)[M112.951]	10.03-	CA1656IR	14 120		10.03-	CS1249	12 1.4
Vito 122 3.2	(639)[M112.951]	10.03-	CA1656IR	14 120		10.03-	CS1249	12 1.4
Vito 123 3.7	(639)[M112.976]	06.04-	CA1656IR	14 120		06.04-	CS1249	12 1.4
<b>PASSENGER CARS US</b>								
200 2.0						01.66- 01.67	CS81	12 1.5
220 2.2						01.60- 01.73	CS81	12 1.5
230 2.3		01.74- 01.78	CA87IR	14 55		01.66- 01.78	CS81	12 1.5
250 2.5						01.69- 01.70	CS81	12 1.5
250 2.8						01.71- 01.72	CS81	12 1.5
280 2.8		01.73- 01.76	CA87IR	14 55		01.73- 01.76	CS81	12 1.5
190 B 1.9						01.61- 01.62	CS81	12 1.5
190 C 1.9						01.63- 01.65	CS81	12 1.5
190 D 2.2		01.84- 01.85	CA321IR	14 55		01.84- 01.85	CS1162	12 2.2
190 D 2.5		01.86- 01.89	CA263IR	14 80		01.86- 01.89	CS1162	12 2.2
190 DT 2.5 Turbo		01.87- 01.87	CA263IR	14 80		01.87- 01.87	CS1162	12 2.2
190 E 2.3		01.84- 01.93	CA87IR	14 55		01.84- 01.85	CS268	12 1.5
		01.86- 01.93	CA263IR	14 80				
190 E 2.6		01.87- 01.93	CA263IR	14 80		01.87- 01.93	CS360	12 1.7
190 E-16 2.3		01.86- 01.87	CA263IR	14 80				
		01.86- 01.87	CA87IR	14 55				
220 D 2.2						01.68- 01.73	CS188	12 2.0
220 SE 2.2						01.60- 01.65	CS81	12 1.5
230 S 2.3						01.66- 01.67	CS81	12 1.5
230 SL 2.3						01.63- 01.66	CS81	12 1.5
240 D 2.4		01.74- 01.83	CA87IR	14 55		01.74- 01.83	CS188	12 2.0
250 C 2.8						01.70- 01.72	CS81	12 1.5
250 S 2.5						01.66- 01.67	CS81	12 1.5
250 SE 2.5						01.66- 01.67	CS81	12 1.5
250 SL 2.5						01.67- 01.67	CS81	12 1.5
260 E 2.6		01.87- 01.89	CA87IR	14 55		01.87- 01.89	CS360	12 1.7
		01.87- 01.89	CA263IR	14 80				
280 C 2.8		01.73- 01.76	CA87IR	14 55		01.73- 01.76	CS81	12 1.5



280 CE 2.8		01.78- 01.81	CA871R	14 55		01.78- 01.81	CS81	12 1.5
280 E 2.8		01.77- 01.81	CA871R	14 55		01.77- 01.81	CS81	12 1.5
280 S 2.8		01.75- 01.76	CA871R	14 55		01.69- 01.76	CS81	12 1.5
280 SE 2.8		01.77- 01.80	CA871R	14 55		01.69- 01.80	CS81	12 1.5
280 SE 3.5						01.70- 01.70	CS81	12 1.5
280 SE 4.5						01.73- 01.73	CS81	12 1.5
280 SEL 2.8						01.69- 01.71	CS81	12 1.5
280 SEL 4.5						01.72- 01.73	CS81	12 1.5
280 SL 2.8						01.69- 01.71	CS81	12 1.5
300 CD 3.0		01.78- 01.81	CA871R	14 55		01.78- 01.81	CS188	12 2.0
300 CDT 3.0 Turbo		01.82- 01.85	CA871R	14 55		01.82- 01.85	CS188	12 2.0
300 CE 3.0		01.88- 01.92	CA2631R	14 80		01.88- 01.92	CS360	12 1.7
300 CE 3.2		01.93- 01.93	CA1044IR	14 90		01.93- 01.93	CS360	12 1.7
		01.93- 01.93	CA1062IR	14 90				
300 D 2.5 Turbo		01.90- 01.93	CA2631R	14 80		01.90- 01.93	CS1162	12 2.2
300 D 3.0		01.75- 01.81	CA871R	14 55		01.75- 01.81	CS188	12 2.0
300 DT 3.0 Turbo		01.79- 01.85	CA871R	14 55		01.79- 01.85	CS188	12 2.0
		01.87- 01.87	CA2631R	14 80		01.87- 01.87	CS1162	12 2.2
300 E 2.6		01.90- 01.92	CA3351R	14 80		01.90- 01.92	CS360	12 1.7
300 E 2.8		01.93- 01.93	CA1044IR	14 90		01.93- 01.93	CS360	12 1.7
		01.93- 01.93	CA1062IR	14 90				
300 E 3.0		01.86- 01.92	CA2631R	14 80		01.86- 01.92	CS360	12 1.7
300 E 3.0 4 Matic		01.90- 01.93	CA3351R	14 80		01.90- 01.93	CS360	12 1.7
300 E 3.2		01.93- 01.93	CA1044IR	14 90		01.93- 01.93	CS360	12 1.7
		01.93- 01.93	CA1062IR	14 90				
300 SD 3.0 Turbo		01.78- 01.85	CA871R	14 55		01.78- 01.85	CS188	12 2.0
300 SD 3.4 Turbo		01.92- 01.93	CA6451R	14 100		01.92- 01.93	CS1162	12 2.2
300 SDL 3.0 Turbo		01.86- 01.87	CA2631R	14 80		01.86- 01.87	CS1162	12 2.2
300 SE 3.0		01.88- 01.91	CA2631R	14 80		01.88- 01.91	CS360	12 1.7
300 SE 3.2		01.92- 01.93	CA1477IR	14 120		01.92- 01.93	CS360	12 1.7
300 SEL 2.8		01.68- 01.69	CA70#	14 55		01.68- 01.69	CS81	12 1.5
300 SEL 3.0		01.88- 01.91	CA2631R	14 80		01.63- 01.65	CS81	12 1.5
						01.88- 01.91	CS360	12 1.7
300 SEL 3.5						01.70- 01.71	CS81	12 1.5
300 SEL 4.5						01.72- 01.73	CS81	12 1.5
300 SL 3.0		01.90- 01.93	CA6451R	14 100		01.90- 01.93	CS360	12 1.7
300 TE 3.0		01.88- 01.92	CA2631R	14 80		01.88- 01.92	CS360	12 1.7
300 TE 3.0 4 Matic		01.90- 01.93	CA3351R	14 80		01.90- 01.93	CS360	12 1.7
300 TE 3.2		01.93- 01.93	CA1044IR	14 90		01.93- 01.93	CS360	12 1.7
		01.93- 01.93	CA1062IR	14 90				
350 SD 3.4 Turbo		01.91- 01.91	CA3351R	14 80		01.91- 01.91	CS1162	12 2.2
350 SDL 3.4 Turbo		01.90- 01.91	CA3351R	14 80		01.90- 01.91	CS1162	12 2.2
350 SL 4.5						01.72- 01.72	CS81	12 1.5
380 SE 3.8		01.84- 01.85	CA2631R	14 80		01.84- 01.85	CS81	12 1.5
		01.84- 01.85	CA2871R	14 70				
380 SEC 3.8		01.82- 01.83	CA2631R	14 80		01.82- 01.83	CS81	12 1.5
		01.82- 01.83	CA2871R	14 70				
380 SEL 3.8		01.81- 01.83	CA2871R	14 70		01.81- 01.83	CS81	12 1.5
380 SL 3.8		01.81- 01.85	CA2871R	14 70		01.81- 01.85	CS81	12 1.5
380 SLC 3.8		01.81- 01.81	CA2871R	14 70		01.81- 01.81	CS81	12 1.5
400 E 4.2		01.92- 01.93	CA1477IR	14 120		01.92- 01.93	CS583	12 1.7
400 SE 4.2		01.92- 01.92	CA1477IR	14 120		01.92- 01.92	CS583	12 1.7
400 SEL 4.2		01.93- 01.93	CA1477IR	14 120		01.93- 01.93	CS583	12 1.7
420 SEL 4.2		01.86- 01.91	CA2631R	14 80		01.86- 01.91	CS81	12 1.5
450 SE 4.5		01.73- 01.76	CA871R	14 55		01.73- 01.76	CS81	12 1.5
450 SEL 4.5		01.73- 01.80	CA871R	14 55		01.73- 01.80	CS81	12 1.5
450 SEL 6.8		01.77- 01.79	CA5661R	14 80				
450 SL 4.5		01.74- 01.80	CA871R	14 55		01.73- 01.80	CS81	12 1.5
						01.74- 01.80	CS311	12 1.5
450 SLC 4.5		01.74- 01.80	CA871R	14 55		01.73- 01.80	CS81	12 1.5
						01.74- 01.80	CS311	12 1.5
500 E 5.0		01.92- 01.93	CA1477IR	14 120		01.92- 01.93	CS583	12 1.7
500 SEC 5.0		01.84- 01.85	CA2631R	14 80		01.93- 01.93	CS583	12 1.7
		01.84- 01.85	CA2871R	14 70		01.84- 01.85	CS81	12 1.5
		01.93- 01.93	CA1477IR	14 120				
500 SEL 5.0		01.84- 01.85	CA2631R	14 80		01.92- 01.93	CS583	12 1.7
		01.84- 01.85	CA2871R	14 70		01.84- 01.85	CS81	12 1.5
		01.92- 01.93	CA1477IR	14 120				
500 SL 5.0		01.90- 01.93	CA6451R	14 100		01.90- 01.93	CS583	12 1.7
560 SEC 5.6		01.86- 01.91	CA2631R	14 80		01.90- 01.91	CS583	12 1.7
						01.86- 01.89	CS81	12 1.5
560 SEL 5.6		01.86- 01.91	CA2631R	14 80		01.90- 01.91	CS583	12 1.7
						01.86- 01.89	CS81	12 1.5
560 SL 5.6		01.86- 01.89	CA2631R	14 80		01.86- 01.89	CS81	12 1.5
600 SEC 6.0		01.93- 01.93	CA1477IR	14 120				
600 SEL 6.0		01.92- 01.93	CA1477IR	14 120				
600 SL 6.0		01.93- 01.93	CA1477IR	14 120				
C 220 2.2		01.94- 01.96	CA1044IR	14 90				
		01.94- 01.96	CA1062IR	14 90				
C 230 2.3	[111.974]	01.98- 01.98	CA1044IR	14 90		01.98- 01.98	CS327	12 1.4
		01.98- 01.98	CA1057IR	14 120				
		01.98- 01.98	CA1062IR	14 90				
		01.97- 01.97	CA1044IR	14 90		01.97- 01.97	CS327	12 1.4
		01.97- 01.97	CA1062IR	14 90				
		01.97- 01.97	CA1057IR	14 120				
C 230 2.3 Super	[111.975]	01.99- 01.00	CA1044IR	14 90		01.99- 01.00	CS327	12 1.4
C 240 2.6	[112.912]					01.02- 01.02	CS1249	12 1.4
						01.01- 01.01	CS1072	12 1.7
C 280 2.8	[112.920]	01.99- 01.00	CA1300IR	14 115		01.99- 01.00	CS1072	12 1.7
		01.94- 01.97	CA1044IR	14 90		01.98- 01.98	CS1072	12 1.7
		01.94- 01.97	CA1062IR	14 90		01.94- 01.97	CS360	12 1.7
		01.98- 01.98	CA1300IR	14 115				
C 32 AMG 3.2 Super						01.02- 01.03	CS1249	12 1.4
C 320 3.2	[112.946]					01.02- 01.03	CS1249	12 1.4
						01.01- 01.01	CS1249	12 1.4
C 320 3.2 4 Matic	[112.946]					01.03- 01.03	CS1249	12 1.4
C 36 AMG 3.6		01.95- 01.97	CA1062IR	14 90		01.95- 01.97	CS360	12 1.7
		01.95- 01.97	CA1044IR	14 90				
		01.95- 01.97	CA1057IR	14 120				
C 43 AMG 4.3	[113.944]					01.99- 01.00	CS1072	12 1.7
						01.98- 01.98	CS1072	12 1.7
CL 500 5.0	[113.960]					01.00- 01.02	CS1072	12 1.7
		01.98- 01.98	CA1206IR	14 143		01.98- 01.98	CS583	12 1.7
						01.01- 01.02	CS1072	12 1.7
CL 55 AMG 5.5								
CL 600 6.0		01.98- 01.99	CA1206IR	14 143				
CLK 320 3.2	[112.940]	01.98- 01.02	CA1300IR	14 115		01.98- 01.01	CS1072	12 1.7
						01.02- 01.02	CS1249	12 1.4
CLK 430 4.3	[113.943]					01.99- 01.02	CS1072	12 1.7
E 300 D 3.0		01.95- 01.97	CA1044IR	14 90		01.95- 01.97	CS1162	12 2.2
		01.95- 01.97	CA724IR	14 70				
		01.95- 01.97	CA1062IR	14 90				



**MERCEDES-BENZ** *Continued*

E 300 D 3.0 Turbo	[606.962]				01.99- 01.99	CS1162	12 2.2
					01.98- 01.98	CS1162	12 2.2
E 320 3.2	[112.941]	01.99- 01.01	CA1300IR	14 115	01.99- 01.01	CS1072	12 1.7
					01.02- 01.02	CS1249	12 1.4
		01.98- 01.98	CA1300IR	14 115	01.94- 01.97	CS360	12 1.7
		01.94- 01.97	CA1062IR	14 90	01.98- 01.98	CS1072	12 1.7
		01.94- 01.97	CA1044IR	14 90			
E 320 3.2 4 Matic	[112.941]	01.99- 01.01	CA1300IR	14 115	01.02- 01.02	CS1249	12 1.4
					01.99- 01.01	CS1072	12 1.7
		01.98- 01.98	CA1300IR	14 115	01.98- 01.98	CS1072	12 1.7
E 420 4.2		01.94- 01.97	CA1477IR	14 120	01.94- 01.97	CS583	12 1.7
E 430 4.3	[113.940]				01.98- 01.02	CS1072	12 1.7
E 430 4.3 4 Matic	[113.940]				01.01- 01.02	CS1072	12 1.7
E 500 5.0		01.94- 01.94	CA1477IR	14 120	01.94- 01.94	CS583	12 1.7
E 55 AMG 5.5					01.99- 01.00	CS1072	12 1.7
G 500 5.0		01.02- 01.02	CA1300IR	14 115	01.02- 01.02	CS1072	12 1.7
ML 320 3.2	[112.942]	01.99- 01.01	CA1300IR	14 115	01.99- 01.01	CS1072	12 1.7
					01.02- 01.02	CS1249	12 1.4
		01.98- 01.98	CA1300IR	14 115	01.98- 01.98	CS1072	12 1.7
ML 430 4.3	[113.942]				01.99- 01.01	CS1072	12 1.7
ML 500 5.0					01.02- 01.02	CS1072	12 1.7
ML 55 AMG 5.5					01.00- 01.01	CS1072	12 1.7
S 320 3.2	[104.994]	01.99- 01.99	CA1057IR	14 120	01.99- 01.99	CS1072	12 1.7
		01.94- 01.97	CA1477IR	14 120	01.98- 01.98	CS1072	12 1.7
					01.98- 01.98	CA1057IR	14 120
		01.94- 01.95	CA645IR	14 100	01.94- 01.95	CS1162	12 2.2
S 350 3.4 TD		01.99- 01.99	CA1206IR	14 143	01.99- 01.99	CS583	12 1.7
S 420 4.2	[119.981]	01.94- 01.98	CA1206IR	14 143	01.94- 01.98	CS583	12 1.7
		01.94- 01.97	CA1477IR	14 120			
S 430 4.3					01.00- 01.03	CS1072	12 1.7
S 500 5.0	[119.980]	01.99- 01.99	CA1206IR	14 143	01.99- 01.99	CS583	12 1.7
		01.98- 01.98	CA1206IR	14 143	01.00- 01.03	CS1072	12 1.7
		01.94- 01.97	CA1477IR	14 120	01.94- 01.98	CS583	12 1.7
S 55 AMG 5.5					01.01- 01.02	CS1072	12 1.7
S 600 6.0		01.94- 01.99	CA1477IR	14 120			
SL 320 3.2		01.94- 01.97	CA1477IR	14 120	01.94- 01.97	CS360	12 1.7
SL 500 5.0	[113.961]				01.99- 01.02	CS1072	12 1.7
		01.98- 01.98	CA1206IR	14 143	01.03- 01.03	CS1072	12 1.7
		01.94- 01.97	CA1477IR	14 120	01.94- 01.98	CS583	12 1.7
SL 600 6.0	[120.983]	01.99- 01.02	CA1206IR	14 143			
		01.94- 01.97	CA1477IR	14 120			
		01.98- 01.98	CA1206IR	14 143			
SLK 230 2.3 Super	[111.973]				01.99- 01.00	CS327	12 1.4
					01.98- 01.98	CS327	12 1.4
SLK 320 3.2					01.01- 01.03	CS1249	12 1.4
Sprinter 2.3 Diesel 4x4	(904)[OM601.943]	06.97- 12.99	CA1062IR	14 90	06.97- 12.99	CS1162	12 2.2
		06.97- 12.99	CA1209IR	14 90	06.97- 12.99	CS1044	12 2.0
		06.97- 12.99	CA1299IR	14 115			
		06.97- 12.99	CA833IR	14 70			
<b>PASSENGER CARS AO</b>							
190 2.3	(201)[M102.985]	Chas. 040724- 09.89- 08.92	CA833IR	14 70	09.89- 08.92	CS327	12 1.4
		Chas. -040723 09.89- 08.92	CA345IR	14 70			
		AT, Chas. 089216- 09.89- 08.92	CA833IR	14 70			
		AT, Chas. -089215 09.89- 08.92	CA345IR	14 70			
190 2.3 E	(201)[M102.985]	Chas. 040724- 10.82- 09.88	CA833IR	14 70	10.82- 09.88	CS327	12 1.4
		Chas. -040723 10.82- 09.88	CA345IR	14 70			
		AT, Chas. 089216- 10.82- 09.88	CA833IR	14 70			
		AT, Chas. -089215 10.82- 09.88	CA345IR	14 70			
190 2.6	(201)[M103.942]	Chas. 015138- 10.82- 09.88	CA723IR	14 80	10.82- 09.88	CS360	12 1.7
		Chas. -015137 10.82- 09.88	CA335IR	14 80			
		AT, Chas. 034645- 10.82- 09.88	CA723IR	14 80			
		AT, Chas. -034644 10.82- 09.88	CA335IR	14 80			
200 E 2.0	(124)[M102.922]	12.84- 10.90	CA321IR	14 55	12.84- 10.90	CS327	12 1.4
		12.84- 10.90	CA345IR	14 70			
250 TD 2.5 Turbo	(124)[OM605.911]	07.93- 06.95	CA1062IR	14 90	07.93- 06.95	CS1044	12 2.0
		07.93- 06.95	CA833IR	14 70			
600 SL 6.0	(R129)[M120.980]	02.92- 05.93	CA1206IR	14 143	05.02-	CS1283	12 1.1
		02.92- 05.93	CA646IR	14 120			
C 220 1.8	(203)	05.02-	CA1752IR	14 120			
CLK 320 3.0 CDI	(209)[OM642.910]				03.05-	CS1072	12 1.7
CLK 500 5.5	(209)[M273.965]				RHD 06.06-	CS1414	12 1.4
					06.06-	CS1249	12 1.4
Viano 2.2 CDI	(W639)	08.05-	CA2038IR	14 180			
<b>TRUCKS EU</b>							
204 11.9	(Actros MP2 / MP3)	06.08-	CA1739IR	28 100			
608 3.8	(LP)[OM314.910]	10.69- 10.77	CA186IR	14 55	RHD 09.73- 10.77	CS186	12 3.0
					02.73- 10.77	CS120	24 4.0
					11.67- 01.73	CS194	24 4.5
	[OM314.944]	10.69- 10.77	CA186IR	14 55	10.69- 01.73	CS194	24 4.5
					RHD 09.73- 10.77	CS186	12 3.0
					02.73- 10.77	CS120	24 4.0
					09.73- 10.77	CS186	12 3.0
709 3.8	(LP)[OM314.910]	02.66- 12.84	CA186IR	14 55	RHD 11.77- 12.84	CS186	12 3.0
		02.66- 07.77	CA187IR	28 27	11.77- 12.84	CS120	24 4.0
		02.66- 07.77	CA333IR	28 55			
		02.66- 07.77	CA568IR	28 30			
		02.66- 07.77	CA854IR	28 35			
	[OM314.944]	02.66- 12.84	CA186IR	14 55	RHD 11.77- 12.84	CS186	12 3.0
					11.77- 12.84	CS120	24 4.0
709 4.0	(LK/LN2)[OM364.907]	03.84- 10.90	CA187IR	28 27	03.84- 02.93	CS1279	24 4.0
		11.86- 02.93	CA333IR	28 55	03.84- 02.93	CS120	24 4.0
		11.86- 02.91	CA568IR	28 30			
		10.88- 02.93	CA1035IR	28 80			
		03.91- 02.93	CA854IR	28 35			
	[OM364.918]	03.84- 10.90	CA187IR	28 27	03.84- 10.90	CS120	24 4.0
		11.86- 10.90	CA333IR	28 55	02.92-	CS1279	24 4.0
		11.86- 02.91	CA568IR	28 30			
		10.88- 10.90	CA1035IR	28 80			
		03.91- 02.93	CA854IR	28 35			
711 4.0	(LK/LN2)[OM354.900]	03.94- 12.98	CA1035IR	28 80	04.86- 12.98	CS120	24 4.0
		03.94- 12.98	CA333IR	28 55			
		03.94- 12.98	CA854IR	28 35			
711 4.3	(LK/LN2)[OM904.905]	03.96- 12.98	CA1593IR	28 80	03.96- 12.98	CS1112	24 4.0 BO
		03.96- 12.98	CA1666IR	28 80	03.96- 12.98	CS1381	24 4.0 DR
712 4.3	(Atego)[OM904.909]	01.98- 10.04	CA1505IR	28 100	01.98- 10.04	CS1112	24 4.0 BO
		01.98- 10.04	CA1593IR	28 80	01.98- 10.04	CS1381	24 4.0 DR
	(Atego 2)[OM900.911]	10.04-	CA1666IR	28 80	10.04-	CS1381	24 4.0 DR
		10.04-	CA1739IR	28 100	10.04-	CS1112	24 4.0 BO
	[OM900.917]	10.04-	CA1666IR	28 80	10.04-	CS1112	24 4.0 BO
		10.04-	CA1739IR	28 100	10.04-	CS1381	24 4.0 DR





	[OM904.909]	10.04- 10.04- 10.04- 10.04-	CA1505IR CA1593IR CA1666IR CA1739IR	28 100 28 80 28 80 28 100		10.04- 10.04-	CS1112 CS1381	24 4.0 24 4.0	BO DR
	[OM904.915]	10.04- 10.04- 10.04- 10.04-	CA1505IR CA1593IR CA1666IR CA1739IR	28 100 28 80 28 80 28 100		10.04- 10.04-	CS1381 CS1112	24 4.0 24 4.0	DR BO
713 4.3	(Atego 2)[OM900.911]	10.04- 10.04-	CA1666IR CA1739IR	28 80 28 100		10.04- 10.04-	CS1112 CS1381	24 4.0 24 4.0	BO DR
	[OM900.917]	10.04- 10.04-	CA1666IR CA1739IR	28 80 28 100		10.04- 10.04-	CS1112 CS1381	24 4.0 24 4.0	BO DR
	[OM904.909]	10.04- 10.04- 10.04- 10.04-	CA1505IR CA1593IR CA1666IR CA1739IR	28 100 28 80 28 80 28 100		10.04- 10.04-	CS1112 CS1381	24 4.0 24 4.0	BO DR
	[OM904.915]	10.04- 10.04- 10.04- 10.04-	CA1505IR CA1593IR CA1666IR CA1739IR	28 100 28 80 28 80 28 100		10.04- 10.04-	CS1112 CS1381	24 4.0 24 4.0	BO DR
714 4.2	(Atego)[OM904.910]	01.98- 10.04 01.98- 10.04	CA1505IR CA1593IR	28 100 28 80		01.98- 10.04 01.98- 10.04	CS1381 CS1112	24 4.0 24 4.0	DR
	[OM904.916]	01.98- 10.04 01.98- 10.04 01.98- 10.04 01.98- 10.04	CA1505IR CA1593IR CA1666IR CA1739IR	28 100 28 80 28 80 28 100		01.98- 10.04	CS1112	24 4.0	
715 4.3	(Atego)[OM904.922]	01.98- 10.04 01.98- 10.04	CA1505IR CA1593IR	28 100 28 80		01.98- 10.04 01.98- 10.04	CS1112 CS1381	24 4.0 24 4.0	BO DR
	(Atego 2)[OM900.912]	10.04- 10.04-	CA1666IR CA1739IR	28 80 28 100		10.04- 10.04-	CS1112 CS1381	24 4.0 24 4.0	BO DR
	[OM900.918]	10.04- 10.04-	CA1666IR CA1739IR	28 80 28 100		10.04- 10.04-	CS1112 CS1381	24 4.0 24 4.0	BO DR
	[OM904.922]	10.04- 10.04- 10.04-	CA1505IR CA1593IR CA1739IR	28 100 28 80 28 100		10.04- 10.04-	CS1112 CS1381	24 4.0 24 4.0	BO DR
716 4.3	(Atego 2)[OM900.912]	10.04- 10.04-	CA1666IR CA1739IR	28 80 28 100		10.04- 10.04-	CS1112 CS1381	24 4.0 24 4.0	BO DR
	[OM900.918]	10.04- 10.04-	CA1666IR CA1739IR	28 80 28 100		10.04- 10.04-	CS1112 CS1381	24 4.0 24 4.0	BO DR
	[OM904.922]	10.04- 10.04- 10.04-	CA1505IR CA1593IR CA1739IR	28 100 28 80 28 100		10.04- 10.04-	CS1112 CS1381	24 4.0 24 4.0	BO DR
717 4.2	(Atego)[OM904.911]	01.98- 10.04 01.98- 10.04 01.98- 10.04 01.98- 10.04	CA1505IR CA1593IR CA1666IR CA1739IR	28 100 28 80 28 80 28 100		01.98- 10.04 01.98- 10.04	CS1381 CS1112	24 4.0 24 4.0	DR BO
	[OM904.917]	01.98- 10.04 01.98- 10.04 01.98- 10.04 01.98- 10.04	CA1505IR CA1593IR CA1666IR CA1739IR	28 100 28 80 28 80 28 100		01.98- 10.04 01.98- 10.04	CS1112 CS1381	24 4.0 24 4.0	DR
808 3.8	(LP)[OM314.910]	10.69- 12.84	CA186IR	14 55		10.69- 01.73 RHD 02.77- 12.84 02.73- 12.84	CS194 CS186 CS120	24 4.5 12 3.0 24 4.0	
	[OM314.944]	10.69- 12.84	CA186IR	14 55		02.73- 12.84 10.69- 01.73	CS186 CS120 CS194	12 3.0 24 4.0 24 4.5	
	[OM314.964]	11.77- 12.84	CA186IR	14 55		RHD 11.77- 12.84 11.77- 12.84	CS186 CS120	12 3.0 24 4.0	
	[OM314.965]	11.77- 12.84	CA186IR	14 55		RHD 11.77- 12.84 11.77- 12.84	CS186 CS120	12 3.0 24 4.0	
809 3.8	(LP)[OM314.910]	10.69- 12.84	CA186IR	14 55		RHD 11.77- 12.84 11.77- 12.84	CS186 CS120	12 3.0 24 4.0	
	[OM314.944]	10.69- 12.84	CA186IR	14 55		RHD 11.77- 12.84 11.77- 12.84	CS186 CS120	12 3.0 24 4.0	
	[OM314.964]	11.77- 12.84	CA186IR	14 55		RHD 11.77- 12.84 11.77- 12.84	CS186 CS120	12 3.0 24 4.0	
	[OM314.965]	11.77- 12.84	CA186IR	14 55		RHD 11.77- 12.84 11.77- 12.84	CS186 CS120	12 3.0 24 4.0	
809 4.0	(LK/LN2)[OM364.907]	03.84- 10.86 11.86- 02.93 11.86- 02.91 10.88- 02.93 03.91- 02.93	CA187IR CA333IR CA568IR CA1035IR CA854IR	28 27 28 55 28 30 28 80 28 35		03.84- 02.93 03.84- 02.93	CS1279 CS120	24 4.0 24 4.0	
	[OM364.918]	03.84- 10.86 11.86- 02.91 12.86- 12.98 10.88- 12.98 03.91- 12.98	CA187IR CA568IR CA333IR CA1035IR CA854IR	28 27 28 30 28 55 28 80 28 35		02.92- 12.98 02.92- 12.98	CS1279 CS120	24 4.0 24 4.0	
811 4.0	(LK/LN2)[OM354.900]	03.94- 12.98 03.94- 12.98 03.94- 12.98	CA1035IR CA333IR CA854IR	28 80 28 55 28 35		03.94- 12.98	CS120	24 4.0	
	[OM904.905]	03.94- 12.98 03.94- 12.98 03.94- 12.98 03.94- 12.98	CA1035IR CA1666IR CA333IR CA854IR	28 80 28 80 28 55 28 35		03.94- 12.98	CS120	24 4.0	
811 4.2	(LK/LN2)[OM904.905]	03.96- 12.98 03.96- 12.98	CA1593IR CA1666IR	28 80 28 80		03.96- 12.98 03.96- 12.98	CS1112 CS1381	24 4.0 24 4.0	BO DR
812 4.2	(Atego 2)[OM904.909]	10.04- 10.04- 10.04-	CA1505IR CA1593IR CA1666IR	28 100 28 80 28 80		10.04-	CS1112	24 4.0	
812 4.3	(Atego)[OM904.909]	01.98- 10.04 01.98- 10.04	CA1505IR CA1593IR	28 100 28 80		01.98- 10.04 01.98- 10.04	CS1112 CS1381	24 4.0 24 4.0	BO DR
	(Atego 2)[OM900.909]	10.04- 10.04-	CA1666IR CA1739IR	28 80 28 100		10.04-	CS1112	24 4.0	
	[OM900.911]	10.04- 10.04-	CA1666IR CA1739IR	28 80 28 100		10.04- 10.04-	CS1112 CS1381	24 4.0 24 4.0	BO DR
	[OM900.917]	10.04- 10.04-	CA1666IR CA1739IR	28 80 28 100		10.04- 10.04-	CS1112 CS1381	24 4.0 24 4.0	BO DR
813 4.3	(Atego 2)[OM900.909]	10.04- 10.04-	CA1666IR CA1739IR	28 80 28 100		10.04-	CS1112	24 4.0	
	[OM900.911]	10.04- 10.04-	CA1666IR CA1739IR	28 80 28 100		10.04- 10.04-	CS1112 CS1381	24 4.0 24 4.0	BO DR
	[OM900.917]	10.04- 10.04-	CA1666IR CA1739IR	28 80 28 100		10.04- 10.04-	CS1112 CS1381	24 4.0 24 4.0	BO DR
813 5.7	(LP)[OM353.904]	08.79- 12.84	CA186IR	14 55		09.73- 12.84	CS186	12 3.0	
	[OM353.941]	10.69- 12.86	CA186IR	14 55					
	[OM353.965]	08.79- 12.84	CA186IR	14 55		09.73- 12.84	CS186	12 3.0	
	[OM353.981]	Eng. 538581- 03.73- 12.84	CA186IR	14 55		09.73- 12.84	CS186	12 3.0	



MERCEDES-BENZ Continued

814 4.0	(LK/LN2)[OM354.920]	03.94- 12.98 CA1035IR 28 80	03.94- 12.98 CS120 24 4.0		
		03.94- 12.98 CA333IR 28 55			
		03.94- 12.98 CA854IR 28 35			
[OM354.921]		03.94- 12.98 CA1035IR 28 80	03.94- 12.98 CS120 24 4.0		
		03.94- 12.98 CA333IR 28 55			
		03.94- 12.98 CA854IR 28 35			
[OM354.922]		03.94- 12.99 CA1035IR 28 80	03.94- 12.99 CS120 24 4.0		
		03.94- 12.99 CA333IR 28 55			
814 4.2	(Atego)[OM904.910]	01.98- 10.04 CA1505IR 28 100	01.98- 10.04 CS1112 24 4.0 BO		
		01.98- 10.04 CA1593IR 28 80	01.98- 10.04 CS1381 24 4.0 DR		
	[OM904.916]		01.98- 10.04 CA1505IR 28 100	01.98- 10.04 CS1112 24 4.0 BO	
			01.98- 10.04 CA1593IR 28 80	01.98- 10.04 CS1381 24 4.0 DR	
			01.98- 10.04 CA1666IR 28 80		
(LK/LN2)[OM904.906]		01.84- 12.98 CA1666IR 28 80	03.96- 12.99 CS1112 24 4.0 BO		
		03.96- 12.99 CA1593IR 28 80	03.96- 12.99 CS1381 24 4.0 DR		
814 6.0	(LK/LN2)[OM356.901]	02.92- 12.98 CA1035IR 28 80	02.92- 12.98 CS120 24 4.0		
		02.92- 12.98 CA333IR 28 55	02.92- 12.98 CS1279 24 4.0		
		02.92- 12.98 CA854IR 28 35			
		[OM356.902]			
	[OM356.905]		02.92- 12.98 CA333IR 28 55	02.92- 12.98 CS120 24 4.0	
			02.92- 12.98 CA1035IR 28 80	02.92- 12.98 CS120 24 4.0	
			02.92- 12.98 CA333IR 28 55		
	[OM356.911]		02.92- 12.98 CA854IR 28 35	02.92- 12.98 CS120 24 4.0	
			03.84- 10.86 CA187IR 28 27	03.84- 02.93 CS120 24 4.0	
			11.86- 02.91 CA568IR 28 30	03.84- 02.93 CS1279 24 4.0	
	[OM366.905]		11.86- 02.93 CA854IR 28 35		
			12.86- 02.93 CA333IR 28 55		
			10.88- 02.93 CA1035IR 28 80		
			[OM366.906]		
	[OM366.907]		03.84- 10.86 CA187IR 28 27	03.84- 02.93 CS1279 24 4.0	
			11.86- 02.91 CA568IR 28 30	03.84- 02.93 CS120 24 4.0	
			12.86- 02.93 CA333IR 28 55		
			10.88- 02.93 CA1035IR 28 80		
			03.91- 02.93 CA854IR 28 35		
	[OM366.910]		03.84- 12.98 CA1035IR 28 80	03.84- 12.98 CS1279 24 4.0	
			03.84- 10.86 CA187IR 28 27	03.84- 12.98 CS120 24 4.0	
			03.84- 12.98 CA333IR 28 55		
			03.84- 12.98 CA854IR 28 35		
			11.86- 02.91 CA568IR 28 30		
[OM366.932]		12.86- 02.93 CA1035IR 28 80	12.86- 02.93 CS120 24 4.0		
		10.88- 02.93 CA333IR 28 55			
815 4.3	(Atego)[OM904.922]	01.98- 10.04 CA1505IR 28 100	01.98- 10.04 CS1381 24 4.0 DR		
		01.98- 10.04 CA1593IR 28 80	01.98- 10.04 CS1112 24 4.0 BO		
		01.98- 10.04 CA1739IR 28 100			
	[OM906.922]		01.98- 10.04 CA1505IR 28 100	01.98- 10.04 CS1112 24 4.0 BO	
			01.98- 10.04 CA1593IR 28 80	01.98- 10.04 CS1381 24 4.0 DR	
	(Atego 2)[OM900.912]		10.04- CA1666IR 28 80	10.04- CS1112 24 4.0 BO	
			10.04- CA1739IR 28 100	10.04- CS1381 24 4.0 DR	
[OM900.918]		10.04- CA1666IR 28 80	10.04- CS1112 24 4.0 BO		
		10.04- CA1739IR 28 100	10.04- CS1381 24 4.0 DR		
[OM904.922]		10.04- CA1505IR 28 100	10.04- CS1112 24 4.0 BO		
		10.04- CA1593IR 28 80	10.04- CS1381 24 4.0 DR		
		10.04- CA1739IR 28 100			
816 4.3	(Atego 2)[OM900.912]	10.04- CA1666IR 28 80	10.04- CS1112 24 4.0 BO		
		10.04- CA1739IR 28 100	10.04- CS1381 24 4.0 DR		
	[OM900.918]		10.04- CA1666IR 28 80	10.04- CS1112 24 4.0 BO	
			10.04- CA1739IR 28 100	10.04- CS1381 24 4.0 DR	
[OM904.922]		10.04- CA1505IR 28 100	10.04- CS1112 24 4.0 BO		
		10.04- CA1593IR 28 80	10.04- CS1381 24 4.0 DR		
		10.04- CA1739IR 28 100			
817 4.2	(LK/LN2)[OM904.907]	03.96- 12.99 CA1593IR 28 80	03.96- 12.99 CS1381 24 4.0 DR		
		03.96- 12.99 CA1666IR 28 80	03.96- 12.99 CS1112 24 4.0 BO		
		03.96- 12.99 CA1924IR 28 180			
817 4.3	(Atego)[OM904.911]	01.98- 10.04 CA1505IR 28 100	01.98- 10.04 CS1381 24 4.0 DR		
		01.98- 10.04 CA1593IR 28 80	01.98- 10.04 CS1112 24 4.0 BO		
817 6.0	(LK/LN2)[OM356.948]	02.92- 12.98 CA1035IR 28 80	02.92- 12.98 CS120 24 4.0		
		02.92- 12.98 CA333IR 28 55			
	[OM356.951]		12.92- 12.98 CA1035IR 28 80	12.92- 12.98 CS1279 24 4.0	
			12.92- 12.98 CA333IR 28 55	12.92- 12.98 CS120 24 4.0	
	[OM357.900]		03.94- 12.98 CA1035IR 28 80	03.94- 12.98 CS120 24 4.0	
			03.94- 12.98 CA333IR 28 55		
			03.94- 12.98 CA854IR 28 35		
	[OM357.908]		03.94- 12.98 CA1035IR 28 80	03.94- 12.98 CS120 24 4.0	
			03.94- 12.98 CA333IR 28 55	03.94- 12.98 CS1279 24 4.0	
			03.94- 12.98 CA854IR 28 35		
	[OM357.916]		03.94- 12.98 CA1035IR 28 80	03.94- 12.98 CS120 24 4.0	
			03.94- 12.98 CA333IR 28 55		
			03.94- 12.98 CA854IR 28 35		
	[OM357.917]		03.94- 12.98 CA1035IR 28 80	03.94- 12.98 CS120 24 4.0	
			03.94- 12.98 CA333IR 28 55		
			03.94- 12.98 CA854IR 28 35		
	[OM366.942]		02.92- 12.98 CA1035IR 28 80	02.92- 12.98 CS120 24 4.0	
			02.92- 12.98 CA333IR 28 55		
			02.92- 12.98 CA854IR 28 35		
	[OM366.943]		02.92- 12.98 CA1035IR 28 80	02.92- 12.98 CS120 24 4.0	
			02.92- 12.98 CA333IR 28 55		
			02.92- 12.98 CA854IR 28 35		
	[OM366.967]		03.84- 02.93 CA854IR 28 35	03.84- 02.93 CS1279 24 4.0	
			11.86- 02.93 CA333IR 28 55	03.84- 02.93 CS120 24 4.0	
			11.86- 12.91 CA568IR 28 30		
[OM366.968]		10.88- 02.93 CA1035IR 28 80			
		01.86- 02.93 CA854IR 28 35	01.86- 02.93 CS120 24 4.0		
		10.88- 02.93 CA1035IR 28 80			
[OM366.969]		06.91- 02.93 CA333IR 28 55			
		12.86- 02.93 CA333IR 28 55	06.86- 02.93 CS120 24 4.0		
		10.88- 02.93 CA1035IR 28 80			
[OM366.973]		03.84- 10.86 CA187IR 28 27	03.84- 02.93 CS120 24 4.0		
		11.86- 02.91 CA568IR 28 30	03.84- 02.93 CS1279 24 4.0		
		12.86- 02.93 CA333IR 28 55			
		10.88- 02.93 CA1035IR 28 80			
		03.91- 02.93 CA854IR 28 35			
818 4.2	(Atego 2)[OM900.913]	02.06- CA1666IR 28 80	02.06- CS1112 24 4.0 BO		
		02.06- CA1739IR 28 100	02.06- CS1381 24 4.0 DR		
[OM900.919]		10.04- CA1666IR 28 80	10.04- CS1112 24 4.0 BO		
		10.04- CA1739IR 28 100	10.04- CS1381 24 4.0 DR		
818 4.3	(Atego 2)[OM900.913]	10.04- CA1666IR 28 80	10.04- CS1112 24 4.0 BO		





MERCEDES-BENZ Continued

918 4.2	(Atego 2)[OM900.913]					02.06-	CS1112	24 4.0
	[OM900.919]	10.04-	CA1666IR	28 80	10.04-	CS1381	24 4.0	DR
918 4.3	(Atego 2)[OM900.919]	10.04-	CA1666IR	28 80	10.04-	CS1381	24 4.0	DR
		10.04-	CA1739IR	28 100	10.04-	CS1112	24 4.0	BO
922 4.8	(Atego 2)[OM924.920]	10.04-	CA1666IR	28 80	10.04-	CS1381	24 4.0	DR
		10.04-	CA1739IR	28 100	10.04-	CS1112	24 4.0	
923 6.4	[OM924.922]					06.06-	CS1112	24 4.0
	(Atego)[OM906.910]	01.98- 10.04	CA1505IR	28 100	01.98- 10.04	CS1381	24 4.0	DR
	(Atego 2)[OM902.916]	01.98- 10.04	CA1593IR	28 80	01.98- 10.04	CS1112	24 4.0	BO
		10.04-	CA1666IR	28 80	10.04-	CS1112	24 4.0	
	[OM906.910]	10.04-	CA1739IR	28 100	10.04-	CS1112	24 4.0	BO
		10.04-	CA1505IR	28 100	10.04-	CS1381	24 4.0	DR
	[OM906.915]	10.04-	CA1593IR	28 80				
		10.04-	CA1666IR	28 80				
924 6.4	(Atego 2)[OM902.916]	10.04-	CA1739IR	28 100	10.04-	CS1112	24 4.0	BO
		10.04-	CA1666IR	28 80	10.04-	CS1381	24 4.0	DR
	[OM906.910]	10.04-	CA1739IR	28 100	10.04-	CS1112	24 4.0	BO
		10.04-	CA1505IR	28 100	10.04-	CS1381	24 4.0	DR
	[OM906.915]	10.04-	CA1593IR	28 80				
		10.04-	CA1666IR	28 80				
926 6.4	(Atego 2)[OM902.917]	10.04-	CA1739IR	28 100	10.04-	CS1112	24 4.0	DR
1013 5.7	(LP)[OM353.904]	08.79- 12.84	CA1866IR	14 55	11.76- 12.84	CS186	12 3.0	
	[OM353.914]	11.76- 12.84	CA1236IR	28 140				
	[OM353.965]	08.79- 12.84	CA1866IR	14 55	11.76- 12.84	CS186	12 3.0	
		08.79- 12.84	CA1866IR	14 55	11.76- 12.84	CS186	12 3.0	
	[OM353.982]	08.79- 12.84	CA1866IR	14 55	11.76- 12.84	CS186	12 3.0	
		08.79- 12.84	CA1866IR	14 55	11.76- 12.84	CS186	12 3.0	
	(NG)[OM353.942]	07.79- 12.86	CA1866IR	14 55	02.76- 12.86	CS186	12 3.0	
		07.79- 12.86	CA1866IR	14 55	02.76- 12.86	CS186	12 3.0	
	[OM353.945]	08.79- 12.84	CA1866IR	14 55	02.76- 12.84	CS186	12 3.0	
		08.79- 12.84	CA1866IR	14 55	02.76- 12.84	CS186	12 3.0	
1016 4.2	(Atego 2)[OM900.912]	02.06-	CA1666IR	28 80	02.06-	CS1112	24 4.0	
		02.06-	CA1739IR	28 100				
	[OM900.918]	10.04-	CA1666IR	28 80	10.04-	CS1381	24 4.0	DR
		10.04-	CA1739IR	28 100	10.04-	CS1112	24 4.0	BO
1016 4.3	(Atego 2)[OM900.912]	10.04-	CA1666IR	28 80	10.04-	CS1112	24 4.0	BO
		10.04-	CA1739IR	28 100	10.04-	CS1381	24 4.0	DR
	[OM900.918]	10.04-	CA1666IR	28 80	10.04-	CS1112	24 4.0	BO
		10.04-	CA1739IR	28 100	10.04-	CS1381	24 4.0	DR
1017 4.2	(Atego)[OM904.911]	01.98- 10.04	CA1505IR	28 100	01.98- 10.04	CS1381	24 4.0	DR
		01.98- 10.04	CA1593IR	28 80	01.98- 10.04	CS1112	24 4.0	BO
	[OM904.917]	01.98- 10.04	CA1666IR	28 80				
		01.98- 10.04	CA1739IR	28 100				
1017 4.3	(Atego)[OM900.913]	02.06-	CA1666IR	28 80	02.06-	CS1112	24 4.0	BO
		02.06-	CA1739IR	28 100	02.06-	CS1381	24 4.0	DR
	[OM904.911]	01.98- 10.04	CA1505IR	28 100	01.98- 10.04	CS1112	24 4.0	BO
		01.98- 10.04	CA1593IR	28 80	01.98- 10.04	CS1381	24 4.0	DR
	[OM904.917]	01.98- 10.04	CA1505IR	28 100	01.98- 10.04	CS1112	24 4.0	
		01.98- 10.04	CA1593IR	28 80				
	[OM904.917]	01.98- 10.04	CA1593IR	28 80				
		01.98- 10.04	CA1739IR	28 100				
1017 5.7	(NG)[OM353.950]	07.79- 02.91	CA1866IR	14 55	11.75- 02.91	CS186	12 3.0	
		07.79- 02.91	CA1866IR	14 55	11.75- 02.91	CS120	24 4.0	
	[OM353.952]	08.79- 02.91	CA1866IR	14 55	11.75- 02.91	CS186	12 3.0	
		08.79- 02.91	CA1866IR	14 55	11.75- 02.91	CS120	24 4.0	
	[OM353.953]	08.79- 02.91	CA1866IR	14 55	11.75- 02.91	CS186	12 3.0	
		08.79- 02.91	CA1866IR	14 55	11.75- 02.91	CS120	24 4.0	
	[OM353.954]	08.79- 09.85	CA1866IR	14 55	11.75- 09.85	CS120	24 4.0	
		08.79- 09.85	CA1866IR	14 55	11.75- 05.84	CS186	12 3.0	
	[OM353.970]	08.79- 12.84	CA1866IR	14 55	02.76- 12.84	CS186	12 3.0	
		08.79- 12.84	CA1866IR	14 55	02.76- 12.84	CS186	12 3.0	
	[OM353.971]	08.79- 02.91	CA1866IR	14 55	11.75- 02.91	CS186	12 3.0	
		08.79- 02.91	CA1866IR	14 55	11.75- 02.91	CS120	24 4.0	
1018 4.2	(Atego 2)[OM900.913]	02.06-	CA1666IR	28 80	02.06-	CS1112	24 4.0	
		02.06-	CA1739IR	28 100				
	[OM900.919]	10.04-	CA1666IR	28 80	10.04-	CS1381	24 4.0	DR
		10.04-	CA1739IR	28 100	10.04-	CS1112	24 4.0	BO
1018 4.3	(Atego)[OM900.913]	02.06-	CA1666IR	28 80	01.98- 10.04	CS1381	24 4.0	DR
		02.06-	CA1739IR	28 100	01.98- 10.04	CS1112	24 4.0	BO
	[OM904.911]	01.98- 10.04	CA1505IR	28 100	01.98- 10.04	CS1112	24 4.0	
		01.98- 10.04	CA1593IR	28 80				
	[OM904.917]	01.98- 10.04	CA1739IR	28 100				
		01.98- 10.04	CA1505IR	28 100	01.98- 10.04	CS1112	24 4.0	
	[OM904.917]	01.98- 10.04	CA1593IR	28 80				
		01.98- 10.04	CA1739IR	28 100				
	(Atego 2)[OM900.913]	10.04-	CA1666IR	28 80	10.04-	CS1112	24 4.0	BO
		10.04-	CA1739IR	28 100	10.04-	CS1381	24 4.0	DR
	[OM900.919]	10.04-	CA1666IR	28 80	10.04-	CS1112	24 4.0	BO
		10.04-	CA1739IR	28 100	10.04-	CS1381	24 4.0	DR
1022 4.8	(Atego 2)[OM924.920]	10.04-	CA1666IR	28 80	10.04-	CS1381	24 4.0	DR
		10.04-	CA1739IR	28 100	10.04-	CS1112	24 4.0	BO
1023 6.4	(Atego)[OM906.910]	06.06-			06.06-	CS1112	24 4.0	
		01.98- 10.04	CA1505IR	28 100	01.98- 10.04	CS1112	24 4.0	
	[OM906.915]	01.98- 10.04	CA1593IR	28 80	01.98- 10.04	CS1381	24 4.0	DR
		01.98- 10.04	CA1924IR	28 180				
	[OM906.915]	01.98- 10.04	CA1505IR	28 100	01.98- 10.04	CS1112	24 4.0	
		01.98- 10.04	CA1593IR	28 80				
	(Atego 2)[OM902.916]	01.98- 10.04	CA1924IR	28 180				
		10.04-	CA1666IR	28 80	10.04-	CS1112	24 4.0	BO
	[OM906.910]	10.04-	CA1739IR	28 100	10.04-	CS1381	24 4.0	DR
		10.04-	CA1505IR	28 100	10.04-	CS1112	24 4.0	BO
	[OM906.915]	10.04-	CA1593IR	28 80	10.04-	CS1381	24 4.0	DR
		10.04-	CA1666IR	28 80				
	[OM906.915]	10.04-	CA1739IR	28 100	10.04-	CS1112	24 4.0	BO
		10.04-	CA1666IR	28 80	10.04-	CS1381	24 4.0	DR
1024 6.4	(Atego 2)[OM902.916]	10.04-	CA1739IR	28 100	10.04-	CS1112	24 4.0	
		10.04-	CA1666IR	28 80				
	[OM906.910]	10.04-	CA1505IR	28 100	10.04-	CS1381	24 4.0	DR
		10.04-	CA1593IR	28 80	10.04-	CS1112	24 4.0	BO
	[OM906.915]	10.04-	CA1666IR	28 80				
		10.04-	CA1739IR	28 100				
	[OM906.915]	10.04-	CA1666IR	28 80	10.04-	CS1112	24 4.0	BO
		10.04-	CA1739IR	28 100	10.04-	CS1381	24 4.0	DR



1113 5.7	(LP)[OM353.904]	01.80- 12.84	<b>CA186IR</b>	14	55	01.80- 12.84	<b>CS186</b>	12	3.0	
	[OM353.982]	01.80- 12.84	<b>CA186IR</b>	14	55	01.80- 12.84	<b>CS186</b>	12	3.0	
1114 6.0	(LK/LN2)[OM356.903]	02.92- 12.99	<b>CA1035IR</b>	28	80	02.92- 12.99	<b>CS1279</b>	24	4.0	
		02.92- 12.99	<b>CA333IR</b>	28	55	02.92- 12.99	<b>CS1279</b>	24	4.0	
		02.92- 12.99	<b>CA854IR</b>	28	35					
	[OM356.904]	02.92- 12.99	<b>CA1035IR</b>	28	80	02.92- 12.99	<b>CS120</b>	24	4.0	
		02.92- 12.99	<b>CA333IR</b>	28	55	02.92- 12.99	<b>CS1279</b>	24	4.0	
		02.92- 12.99	<b>CA854IR</b>	28	35					
	[OM356.907]	02.92- 12.99	<b>CA1035IR</b>	28	80	02.92- 12.99	<b>CS120</b>	24	4.0	
		02.92- 12.99	<b>CA333IR</b>	28	55	02.92- 12.99	<b>CS1279</b>	24	4.0	
	[OM356.930]	03.84- 10.86	<b>CA187IR</b>	28	27	03.84- 02.93	<b>CS120</b>	24	4.0	
		11.86- 02.91	<b>CA568IR</b>	28	30	03.84- 02.93	<b>CS1279</b>	24	4.0	
		12.86- 02.93	<b>CA333IR</b>	28	55					
		10.88- 02.93	<b>CA1035IR</b>	28	80					
		03.91- 02.93	<b>CA854IR</b>	28	35					
	[OM366.907]	03.84- 10.86	<b>CA187IR</b>	28	27	03.84- 02.93	<b>CS120</b>	24	4.0	
		08.84- 02.93	<b>CA854IR</b>	28	35	03.84- 02.93	<b>CS1279</b>	24	4.0	
		11.86- 02.91	<b>CA568IR</b>	28	30					
		12.86- 02.93	<b>CA333IR</b>	28	55					
		10.88- 02.93	<b>CA1035IR</b>	28	80					
	[OM366.914]	03.84- 10.86	<b>CA187IR</b>	28	27	03.84- 02.93	<b>CS120</b>	24	4.0	
		10.84- 02.93	<b>CA854IR</b>	28	35	03.84- 02.93	<b>CS1279</b>	24	4.0	
		11.86- 02.91	<b>CA568IR</b>	28	30					
		12.86- 02.93	<b>CA333IR</b>	28	55					
		10.88- 02.93	<b>CA1035IR</b>	28	80					
	[OM366.918]	02.87- 02.93	<b>CA854IR</b>	28	35	02.87- 02.93	<b>CS120</b>	24	4.0	
						02.87- 02.93	<b>CS1279</b>	24	4.0	
	[OM366.931]	07.86- 02.93	<b>CA854IR</b>	28	35	02.87- 02.93	<b>CS1279</b>	24	4.0	
	[OM366.933]	12.85- 02.93	<b>CA1035IR</b>	28	80	12.85- 02.93	<b>CS1279</b>	24	4.0	
		12.85- 02.93	<b>CA333IR</b>	28	55	12.85- 02.93	<b>CS120</b>	24	4.0	
	[OM366.935]	07.86- 02.93	<b>CA333IR</b>	28	55	02.87- 02.93	<b>CS1279</b>	24	4.0	
		07.86- 02.93	<b>CA854IR</b>	28	35					
	1117 4.2	(LK/LN2)[OM356.947]	02.92- 12.99	<b>CA854IR</b>	28	35	02.92- 12.99	<b>CS120</b>	24	4.0
							02.92- 12.99	<b>CS1279</b>	24	4.0
		[OM356.959]	06.87- 12.98	<b>CA854IR</b>	28	35	06.87- 12.98	<b>CS1279</b>	24	4.0
		[OM357.906]	03.94- 12.99	<b>CA854IR</b>	28	35	03.94- 12.99	<b>CS120</b>	24	4.0
					03.94- 12.99	<b>CS1279</b>	24	4.0		
[OM366.966]		06.87- 12.92	<b>CA854IR</b>	28	35	06.87- 12.92	<b>CS1279</b>	24	4.0	
[OM366.975]		09.88- 02.93	<b>CA854IR</b>	28	35	09.88- 02.93	<b>CS1279</b>	24	4.0	
					09.88- 02.93	<b>CS120</b>	24	4.0		
[OM366.976]		09.88- 02.93	<b>CA854IR</b>	28	35	09.88- 02.93	<b>CS120</b>	24	4.0	
					09.88- 02.93	<b>CS1279</b>	24	4.0		
[OM904.907]		03.96- 12.99	<b>CA1593IR</b>	28	80	03.96- 12.99	<b>CS1381</b>	24	4.0 DR	
	03.96- 12.99	<b>CA1666IR</b>	28	80	03.96- 12.99	<b>CS1112</b>	24	4.0 BO		
	03.96- 12.99	<b>CA1924IR</b>	28	180						
1117 6.0	(LK/LN2)[OM356.949]	03.93- 12.99	<b>CA1035IR</b>	28	80	03.93- 12.99	<b>CS120</b>	24	4.0	
		03.93- 12.99	<b>CA333IR</b>	28	55	03.93- 12.99	<b>CS1279</b>	24	4.0	
		07.86- 12.99	<b>CA854IR</b>	28	35	07.86- 12.99	<b>CS1279</b>	24	4.0	
					07.86- 12.99	<b>CS120</b>	24	4.0		
	[OM357.902]	03.94- 12.98	<b>CA854IR</b>	28	35	03.94- 12.98	<b>CS1279</b>	24	4.0	
	[OM357.906]	03.94- 12.98	<b>CA854IR</b>	28	35	03.94- 12.98	<b>CS1279</b>	24	4.0	
	[OM357.907]	04.84- 12.98	<b>CA1035IR</b>	28	80	03.94- 12.98	<b>CS1279</b>	24	4.0	
		04.84- 12.98	<b>CA1236R</b>	28	140					
		04.84- 12.98	<b>CA333IR</b>	28	55					
		04.84- 12.98	<b>CA854IR</b>	28	35					
	[OM357.918]	01.84- 12.99	<b>CA333IR</b>	28	55	03.94- 12.99	<b>CS120</b>	24	4.0	
		03.94- 12.99	<b>CA854IR</b>	28	35	03.94- 12.99	<b>CS1279</b>	24	4.0	
	[OM357.919]	03.93- 12.99	<b>CA1035IR</b>	28	80	03.93- 12.99	<b>CS120</b>	24	4.0	
		03.93- 12.99	<b>CA333IR</b>	28	55	03.93- 12.99	<b>CS1279</b>	24	4.0	
	[OM366.941]	02.92- 12.99	<b>CA854IR</b>	28	35	02.92- 12.99	<b>CS120</b>	24	4.0	
					02.92- 12.99	<b>CS1279</b>	24	4.0		
	[OM366.953]	04.84- 12.92	<b>CA854IR</b>	28	35	03.84- 12.92	<b>CS1279</b>	24	4.0	
					03.84- 12.92	<b>CS120</b>	24	4.0		
	[OM366.962]	04.84- 12.92	<b>CA854IR</b>	28	35	04.84- 12.92	<b>CS1279</b>	24	4.0	
					04.84- 12.92	<b>CS120</b>	24	4.0		
	[OM366.970]	07.86- 02.93	<b>CA854IR</b>	28	35	07.86- 02.93	<b>CS1279</b>	24	4.0	
					07.86- 02.93	<b>CS120</b>	24	4.0		
	[OM366.971]	03.93- 12.99	<b>CA1035IR</b>	28	80	03.93- 12.99	<b>CS120</b>	24	4.0	
		03.93- 12.99	<b>CA333IR</b>	28	55	03.93- 12.99	<b>CS1279</b>	24	4.0	
	1120 6.0	(LK/LN2)[OM356.986]	02.92- 12.99	<b>CA854IR</b>	28	35	02.92- 12.99	<b>CS1279</b>	24	4.0
							02.92- 12.99	<b>CS120</b>	24	4.0
							02.92- 12.99	<b>CS1279</b>	24	4.0
[OM356.993]		02.92- 12.99	<b>CA333IR</b>	28	55	02.92- 12.99	<b>CS1279</b>	24	4.0	
[OM356.994]		10.92- 12.99	<b>CA1035IR</b>	28	80	10.92- 12.99	<b>CS1279</b>	24	4.0	
		10.92- 12.99	<b>CA333IR</b>	28	55					
[OM356.995]		10.92- 12.99	<b>CA333IR</b>	28	55	10.92- 12.99	<b>CS1279</b>	24	4.0	
					10.92- 12.99	<b>CS120</b>	24	4.0		
[OM356.996]		10.92- 12.99	<b>CA333IR</b>	28	55	10.92- 12.99	<b>CS1279</b>	24	4.0	
		12.92- 12.99	<b>CA1035IR</b>	28	80					
[OM357.920]		06.94- 12.99	<b>CA854IR</b>	28	35	06.94- 12.99	<b>CS120</b>	24	4.0	
					06.94- 12.99	<b>CS1279</b>	24	4.0		
[OM357.927]		06.94- 12.99	<b>CA854IR</b>	28	35	06.84- 12.99	<b>CS120</b>	24	4.0	
					06.84- 12.99	<b>CS1279</b>	24	4.0		
[OM357.929]		06.94- 12.99	<b>CA854IR</b>	28	35	02.92- 12.99	<b>CS1279</b>	24	4.0	
[OM357.932]		06.94- 12.99	<b>CA854IR</b>	28	35	06.94- 12.99	<b>CS120</b>	24	4.0	
					06.94- 12.99	<b>CS1279</b>	24	4.0		
[OM366.962]		08.84- 02.93	<b>CA854IR</b>	28	35	08.84- 02.93	<b>CS1279</b>	24	4.0	
[OM366.988]		06.84- 02.93	<b>CA854IR</b>	28	35	06.84- 02.93	<b>CS120</b>	24	4.0	
					06.84- 02.93	<b>CS1279</b>	24	4.0		
[OM366.992]		08.84- 02.93	<b>CA1035IR</b>	28	80	08.84- 02.93	<b>CS1279</b>	24	4.0	
		08.84- 02.93	<b>CA333IR</b>	28	55	08.84- 02.93	<b>CS120</b>	24	4.0	
[OM366.993]		02.92- 12.99	<b>CA333IR</b>	28	55	02.92- 12.99	<b>CS1279</b>	24	4.0	
[OM366.994]		02.87- 12.92	<b>CA333IR</b>	28	55	02.87- 12.92	<b>CS1279</b>	24	4.0	
1124 6.0		(LK/LN2)[OM356.979]	03.92- 12.99	<b>CA1035IR</b>	28	80	03.92- 12.99	<b>CS120</b>	24	4.0
			03.92- 12.99	<b>CA333IR</b>	28	55	03.92- 12.99	<b>CS1279</b>	24	4.0
			03.92- 12.99	<b>CA854IR</b>	28	35				
		[OM356.983]	03.92- 12.99	<b>CA1035IR</b>	28	80	03.92- 12.99	<b>CS1279</b>	24	4.0
			03.92- 12.99	<b>CA333IR</b>	28	55	03.92- 12.99	<b>CS120</b>	24	4.0
		03.92- 12.99	<b>CA854IR</b>	28	35					
	[OM356.989]	03.92- 12.99	<b>CA1035IR</b>	28	80	03.92- 12.99	<b>CS1279</b>	24	4.0	
		03.92- 12.99	<b>CA333IR</b>	28	55	03.92- 12.99	<b>CS120</b>	24	4.0	
		03.92- 12.99	<b>CA854IR</b>	28	35					
	[OM356.991]	03.92- 12.99	<b>CA1035IR</b>	28	80	03.92- 12.99	<b>CS1279</b>	24	4.0	
		03.92- 12.99	<b>CA333IR</b>	28	55	03.92- 12.99	<b>CS120</b>	24	4.0	
		03.92- 12.99	<b>CA854IR</b>	28	35					
	[OM357.933]	06.94- 12.99	<b>CA1035IR</b>	28	80	06.94- 12.99	<b>CS120</b>	24	4.0	
		06.94- 12.99	<b>CA333IR</b>	28	55	06.94- 12.99	<b>CS1279</b>	24	4.0	
	[OM357.942]	06.94- 12.99	<b>CA1035IR</b>	28	80	06.94- 12.99	<b>CS120</b>	24	4.0	
		06.94- 12.99	<b>CA333IR</b>	28	55	06.94- 12.99	<b>CS1279</b>	24	4.0	
	[OM357.943]	06.94- 12.99	<b>CA1035IR</b>	28	80	06.94- 12.99	<b>CS120</b>	24	4.0	
	06.94- 12.99	<b>CA333IR</b>	28	55	06.94- 12.99	<b>CS1279</b>	24	4.0		



MERCEDES-BENZ Continued

	[OM357.944]	06.94- 12.99	CA1035IR	28 80	06.94- 12.99	CS1279	24 4.0
		06.94- 12.99	CA333IR	28 55	06.94- 12.99	CS120	24 4.0
1213 5.7	(NG)[OM353.943]	08.79- 05.86	CA186IR	14 55	09.75- 05.86	CS186	12 3.0
	[OM353.944]				09.75- 05.86	CS186	12 3.0
		08.79- 05.86	CA186IR	14 55			
	[OM353.945]	08.79- 05.86	CA186IR	14 55	09.75- 05.86	CS186	12 3.0
	[OM353.946]	08.79- 05.86	CA186IR	14 55	09.75- 05.86	CS186	12 3.0
1214 4.2	(Atego)[OM904.910]	01.98- 10.04	CA1505IR	28 100	01.98- 10.04	CS1112	24 4.0
		01.98- 10.04	CA1593IR	28 80			
		01.98- 10.04	CA1924IR	28 180			
	[OM904.916]	01.98- 10.04	CA1505IR	28 100	01.98- 10.04	CS1112	24 4.0
		01.98- 10.04	CA1593IR	28 80			
		01.98- 10.04	CA1924IR	28 180			
1214 4.3	(Atego)[OM904.910]	01.98- 10.04	CA1505IR	28 100	01.98- 10.04	CS1112	24 4.0
		01.98- 10.04	CA1593IR	28 80	01.98- 10.04	CS1381	24 4.0
	[OM904.916]	01.98- 10.04	CA1505IR	28 100	01.98- 10.04	CS1112	24 4.0
		01.98- 10.04	CA1593IR	28 80	01.98- 10.04	CS1381	24 4.0
1214 6.0	(LK/LN2)[OM366.913]	01.84- 12.98	CA1593IR	28 80	01.84- 12.98	CS120	24 4.0
		01.84- 12.98	CA333IR	28 55			
1215 4.3	(Atego)[OM904.922]	01.98- 10.04	CA1505IR	28 100	01.98- 10.04	CS1381	24 4.0 DR
		01.98- 10.04	CA1593IR	28 80	01.98- 10.04	CS1112	24 4.0 BO
		01.98- 10.04	CA1739IR	28 100			
	(Atego 2)[OM900.912]	10.04- 10.04	CA1666IR	28 80	10.04- 10.04	CS1112	24 4.0 BO
		10.04- 10.04	CA1739IR	28 100	10.04- 10.04	CS1381	24 4.0 DR
	[OM904.922]	10.04- 10.04	CA1505IR	28 100	10.04- 10.04	CS1112	24 4.0 BO
		10.04- 10.04	CA1593IR	28 80	10.04- 10.04	CS1381	24 4.0 DR
		10.04- 10.04	CA1739IR	28 100			
1216 4.2	(Atego 2)[OM900.912]	02.06- 02.06	CA1666IR	28 80	02.06- 02.06	CS1112	24 4.0
		02.06- 02.06	CA1739IR	28 100			
1216 4.3	(Atego 2)[OM900.912]	10.04- 10.04	CA1666IR	28 80	10.04- 10.04	CS1112	24 4.0 BO
		10.04- 10.04	CA1739IR	28 100	10.04- 10.04	CS1381	24 4.0 DR
	[OM904.922]	10.04- 10.04	CA1505IR	28 100	10.04- 10.04	CS1112	24 4.0 BO
		10.04- 10.04	CA1593IR	28 80	10.04- 10.04	CS1381	24 4.0 DR
		10.04- 10.04	CA1739IR	28 100			
1217 4.3	(Atego)[OM904.911]	01.98- 10.04	CA1505IR	28 100	01.98- 10.04	CS1381	24 4.0 DR
		01.98- 10.04	CA1593IR	28 80	01.98- 10.04	CS1112	24 4.0 BO
1217 5.7	(NG)[OM353.950]	08.79- 09.85	CA186IR	14 55	09.75- 09.85	CS186	12 3.0
		05.83- 09.85	CA1035IR	28 80			
		05.83- 09.85	CA333IR	28 55			
		05.83- 09.85	CA568IR	28 30			
	[OM353.951]	08.79- 09.85	CA186IR	14 55	09.75- 09.85	CS186	12 3.0
		05.83- 09.85	CA1035IR	28 80			
		05.83- 09.85	CA333IR	28 55			
		05.83- 09.85	CA568IR	28 30			
	[OM353.952]	08.79- 09.85	CA186IR	14 55	09.75- 09.85	CS186	12 3.0
		05.83- 09.85	CA1035IR	28 80			
		05.83- 09.85	CA333IR	28 55			
		05.83- 09.85	CA568IR	28 30			
	[OM353.953]	08.79- 09.85	CA186IR	14 55	09.75- 09.85	CS186	12 3.0
		05.83- 09.85	CA1035IR	28 80			
		05.83- 09.85	CA333IR	28 55			
		05.83- 09.85	CA568IR	28 30			
	[OM353.970]	08.79- 09.85	CA186IR	14 55	09.75- 09.85	CS186	12 3.0
	[OM353.971]	08.79- 09.85	CA186IR	14 55	09.75- 09.85	CS186	12 3.0
1217 6.0	(LK/LN2)[OM357.901]	03.94- 12.99	CA854IR	28 35	03.94- 12.99	CS1279	24 4.0
					03.94- 12.99	CS120	24 4.0
	[OM357.918]	03.94- 12.99	CA854IR	28 35	03.94- 12.99	CS1279	24 4.0
					03.94- 12.99	CS120	24 4.0
	(NG)[OM366.960]	05.82- 10.90	CA1593IR	28 80	05.82- 10.90	CS120	24 4.0
		05.82- 10.90	CA333IR	28 55			
1218 4.2	(Atego 2)[OM900.913]	02.06- 02.06	CA1666IR	28 80	02.06- 02.06	CS1112	24 4.0
		02.06- 02.06	CA1739IR	28 100			
1218 4.3	(Atego 2)[OM900.913]	10.04- 10.04	CA1666IR	28 80	10.04- 10.04	CS1112	24 4.0 BO
		10.04- 10.04	CA1739IR	28 100	10.04- 10.04	CS1381	24 4.0 DR
1219 9.6	(NG)[OM401.905]	04.81- 12.84	CA186IR	14 55	09.75- 02.77	CS198	24 6.0
					03.77- 12.84	CS191	24 5.4
	[OM401.906]	04.81- 09.84	CA186IR	14 55	09.75- 02.77	CS198	24 6.0
					03.77- 09.84	CS191	24 5.4
	[OM401.914]	04.81- 09.84	CA186IR	14 55	09.75- 02.77	CS198	24 6.0
					03.77- 09.84	CS191	24 5.4
	[OM401.915]	04.81- 09.84	CA186IR	14 55	09.75- 02.77	CS198	24 6.0
					03.77- 09.84	CS191	24 5.4
	[OM401.918]				03.77- 09.84	CS191	24 5.4
					09.75- 02.77	CS198	24 6.0
	[OM401.919]				03.77- 09.84	CS191	24 5.4
					09.75- 02.77	CS198	24 6.0
1222 11.0	(MK)[OM441.905]	07.89- 08.94	CA1035IR	28 80	07.89- 08.94	CS191	24 5.4
		07.89- 08.94	CA333IR	28 55	07.89- 08.94	CS194	24 4.5
		07.89- 02.91	CA568IR	28 30			
		03.91- 09.91	CA854IR	28 35			
	[OM441.913]	07.89- 08.94	CA1035IR	28 80	07.89- 08.94	CS194	24 4.5
		07.89- 08.94	CA333IR	28 55	07.89- 08.94	CS191	24 5.4
		07.89- 02.91	CA568IR	28 30			
		03.91- 09.91	CA854IR	28 35			
	[OM441.914]	09.89- 07.94	CA1035IR	28 80	09.89- 07.94	CS191	24 5.4
		09.89- 07.94	CA333IR	28 55	09.89- 07.94	CS194	24 4.5
		09.89- 02.91	CA568IR	28 30			
		03.91- 09.91	CA854IR	28 35			
	[OM441.915]	09.89- 09.93	CA333IR	28 55	09.89- 09.93	CS191	24 5.4
	[OM441.917]	09.89- 09.93	CA333IR	28 55	09.89- 09.93	CS191	24 5.4
	[OM441.923]	07.89- 08.94	CA333IR	28 55	07.89- 08.94	CS194	24 4.5
		07.89- 08.94	CA854IR	28 35	07.89- 08.94	CS191	24 5.4
	[OM441.925]	07.89- 08.94	CA333IR	28 55	07.89- 08.94	CS194	24 4.5
		07.89- 08.94	CA854IR	28 35	07.89- 08.94	CS191	24 5.4
	[OM441.926]	09.89- 07.94	CA1035IR	28 80	09.89- 07.94	CS191	24 5.4
		09.89- 07.94	CA333IR	28 55	09.89- 07.94	CS194	24 4.5
		09.89- 02.91	CA568IR	28 30			
		03.91- 09.91	CA854IR	28 35			
	(NG)[OM421.905]	05.82- 10.90	CA333IR	28 55	05.82- 10.90	CS191	24 5.4
		10.88- 10.90	CA1035IR	28 80			
	[OM421.906]	05.82- 12.91	CA333IR	28 55	05.82- 12.91	CS191	24 5.4
		10.88- 12.91	CA1035IR	28 80			
1222 4.8	(Atego 2)[OM924.920]	10.04- 10.04	CA1666IR	28 80	10.04- 10.04	CS1381	24 4.0 DR
		10.04- 10.04	CA1739IR	28 100	10.04- 10.04	CS1112	24 4.0
	[OM924.922]				02.06- 02.06	CS1112	24 4.0
1222 6.0	(MK)[OM356.999]	02.93- 02.01	CA1035IR	28 80	02.93- 02.01	CS120	24 4.0
		02.93- 02.01	CA333IR	28 55			
		02.93- 02.01	CA854IR	28 35			
	[OM357.946]	02.93- 02.01	CA1035IR	28 80	02.93- 02.01	CS120	24 4.0
		02.93- 02.01	CA333IR	28 55			
		02.93- 02.01	CA854IR	28 35			
	[OM366.999]	02.93- 02.01	CA1035IR	28 80	02.93- 02.01	CS120	24 4.0



		02.93-02.01	CA333IR	28 55				
		02.93-02.01	CA854IR	28 35				
1223 6.4	(Atego)[OM906.910]	01.98-10.04	CA1505IR	28 100	01.98-10.04	CS1381	24 4.0	DR
		01.98-10.04	CA1593IR	28 80	01.98-10.04	CS1112	24 4.0	
		01.98-09.04	CA1924IR	28 180				
	[OM906.915]	01.98-09.04	CA1505IR	28 100	01.98-09.04	CS1112	24 4.0	
		01.98-09.04	CA1593IR	28 80				
		01.98-09.04	CA1924IR	28 180				
	(Atego 2)[OM902.916]	10.04-10.04	CA1666IR	28 80	10.04-	CS1112	24 4.0	
		10.04-10.04	CA1739IR	28 100				
	[OM906.910]	10.04-10.04	CA1505IR	28 100	10.04-	CS1112	24 4.0	BO
		10.04-10.04	CA1593IR	28 80	10.04-	CS1381	24 4.0	DR
		10.04-10.04	CA1666IR	28 80				
		10.04-10.04	CA1739IR	28 100				
	[OM906.915]	10.04-10.04	CA1666IR	28 80	10.04-	CS1112	24 4.0	BO
		10.04-10.04	CA1739IR	28 100	10.04-	CS1381	24 4.0	DR
1224 6.0	(MK)[OM356.999]	07.89-08.94	CA333IR	28 55	07.89-08.94	CS120	24 4.0	
					07.89-08.94	CS1279	24 4.0	
1224 6.4	(Atego 2)[OM902.916]	10.04-10.04	CA1666IR	28 80	10.04-	CS1112	24 4.0	
		10.04-10.04	CA1739IR	28 100				
	[OM906.910]	10.04-10.04	CA1505IR	28 100	10.04-	CS1112	24 4.0	BO
		10.04-10.04	CA1593IR	28 80	10.04-	CS1381	24 4.0	DR
		10.04-10.04	CA1666IR	28 80				
		10.04-10.04	CA1739IR	28 100				
	[OM906.915]	10.04-10.04	CA1666IR	28 80	10.04-	CS1112	24 4.0	BO
		10.04-10.04	CA1739IR	28 100	10.04-	CS1381	24 4.0	DR
1224 9.6	(MK)[OM401.984]	02.93-09.96	CA854IR	28 35	02.93-09.96	CS191	24 5.4	
1225 15.1	(NG)[OM442.907]	05.82-12.91	CA1035IR	28 80	05.82-12.91	CS191	24 5.4	
		05.82-12.91	CA333IR	28 55				
		05.82-12.91	CA854IR	28 35				
1225 6.4	(Atego)[OM906.919]	01.98-10.04	CA1505IR	28 100	01.98-10.04	CS1112	24 4.0	BO
		01.98-10.04	CA1593IR	28 80	01.98-10.04	CS1381	24 4.0	DR
1226 11.0	(MK)[OM441.989]	02.93-09.96	CA333IR	28 55	02.93-09.96	CS191	24 5.4	
		02.93-09.96	CA854IR	28 35				
1226 15.1	(MK)[OM442.907]	02.90-09.93	CA1035IR	28 80	02.90-09.93	CS191	24 5.4	
		02.90-09.93	CA333IR	28 55				
		02.90-09.93	CA854IR	28 35				
	[OM442.914]	02.90-09.93	CA1035IR	28 80	02.90-09.93	CS191	24 5.4	
		02.90-09.93	CA333IR	28 55				
		02.90-09.93	CA854IR	28 35				
	[OM442.920]	02.90-09.93	CA1035IR	28 80	02.90-09.93	CS191	24 5.4	
		02.90-09.93	CA333IR	28 55				
	[OM442.926]	02.90-09.93	CA333IR	28 55	02.90-09.93	CS191	24 5.4	
		02.90-09.93	CA854IR	28 35				
	[OM442.932]	02.90-09.93	CA333IR	28 55	02.90-09.93	CS191	24 5.4	
		02.90-09.93	CA854IR	28 35				
	[OM442.933]	02.90-09.93	CA1035IR	28 80	02.90-09.93	CS191	24 5.4	
		02.90-09.93	CA333IR	28 55				
1226 6.4	(Atego 2)[OM902.917]	10.04-10.04	CA1666IR	28 80	10.04-	CS1381	24 4.0	DR
		10.04-10.04	CA1739IR	28 100	10.04-	CS1112	24 4.0	BO
1226 9.6	(MK)[OM401.973]	02.93-09.96	CA333IR	28 55	02.93-09.96	CS191	24 5.4	
		02.93-09.96	CA854IR	28 35				
	[OM401.978]	02.93-09.96	CA333IR	28 55	02.93-09.96	CS191	24 5.4	
		02.93-09.96	CA854IR	28 35				
	[OM401.984]	02.93-09.96	CA333IR	28 55	02.93-09.96	CS191	24 5.4	
		02.93-09.96	CA854IR	28 35				
	[OM401.989]	02.93-09.96	CA333IR	28 55	02.93-09.96	CS191	24 5.4	
		02.93-09.96	CA854IR	28 35				
1227 11.0	(MK)[OM445.933]	01.92-07.92	CA1035IR	28 80				
		01.92-07.92	CA333IR	28 55				
1227 9.6	(MK)[OM401.973]	01.92-07.92	CA333IR	28 55	01.92-07.92	CS191	24 5.4	
		01.92-07.92	CA854IR	28 35				
	[OM401.989]	01.92-07.92	CA333IR	28 55	01.92-07.92	CS191	24 5.4	
		01.92-07.92	CA854IR	28 35				
1228 6.4	(Atego)[OM906.911]	01.98-10.04	CA1505IR	28 100	01.98-10.04	CS1112	24 4.0	BO
		01.98-10.04	CA1593IR	28 80	01.98-10.04	CS1381	24 4.0	DR
	(Atego 2)[OM902.918]	10.04-10.04	CA1666IR	28 80	10.04-	CS1112	24 4.0	
		10.04-10.04	CA1739IR	28 100				
	[OM906.911]	10.04-10.04	CA1666IR	28 80	10.04-	CS1112	24 4.0	BO
		10.04-10.04	CA1739IR	28 100	10.04-	CS1381	24 4.0	DR
	[OM906.916]	10.04-10.04	CA1505IR	28 100	10.04-	CS1112	24 4.0	BO
		10.04-10.04	CA1593IR	28 80	10.04-	CS1381	24 4.0	DR
		10.04-10.04	CA1666IR	28 80				
		10.04-10.04	CA1739IR	28 100				
1229 6.4	(Atego 2)[OM902.918]	10.04-10.04	CA1666IR	28 80	10.04-	CS1112	24 4.0	
		10.04-10.04	CA1739IR	28 100				
	[OM906.911]	10.04-10.04	CA1666IR	28 80	10.04-	CS1112	24 4.0	BO
		10.04-10.04	CA1739IR	28 100	10.04-	CS1381	24 4.0	DR
	[OM906.916]	10.04-10.04	CA1505IR	28 100	10.04-	CS1112	24 4.0	BO
		10.04-10.04	CA1593IR	28 80	10.04-	CS1381	24 4.0	DR
		10.04-10.04	CA1666IR	28 80				
		10.04-10.04	CA1739IR	28 100				
1231 9.6	(MK)[OM401.986]	01.92-09.96	CA1035IR	28 80				
		01.92-09.96	CA333IR	28 55				
		01.92-09.96	CA854IR	28 35				
1234 11.0	(MK)[OM441.989]	01.92-09.96	CA333IR	28 55	01.92-09.96	CS191	24 5.4	
		01.92-09.96	CA854IR	28 35				
	[OM441.993]	01.92-09.96	CA1035IR	28 80	01.92-09.96	CS191	24 5.4	
		01.92-09.96	CA333IR	28 55				
		01.92-09.96	CA854IR	28 35				
	[OM445.923]	01.94-09.96	CA1035IR	28 80	01.94-09.96	CS191	24 5.4	
		01.94-09.96	CA333IR	28 55				
		01.94-09.96	CA854IR	28 35				
	[OM445.933]	01.94-09.96	CA1035IR	28 80	01.94-09.96	CS191	24 5.4	
		01.94-09.96	CA333IR	28 55				
		01.94-09.96	CA854IR	28 35				
1314 6.0	(LK/LN2)[OM356.908]	12.92-09.95	CA854IR	28 35	12.92-09.95	CS1279	24 4.0	
					12.92-09.95	CS120	24 4.0	
	[OM356.909]	12.92-12.99	CA1035IR	28 80	12.92-12.99	CS1279	24 4.0	
		12.92-12.99	CA333IR	28 55	12.92-12.99	CS120	24 4.0	
		12.92-12.99	CA854IR	28 35				
	[OM356.910]	12.92-12.99	CA1035IR	28 80	12.92-12.99	CS120	24 4.0	
		12.92-12.99	CA333IR	28 55	12.92-12.99	CS1279	24 4.0	
		12.92-12.99	CA854IR	28 35				
	[OM366.907]	07.84-10.86	CA187IR	28 27	07.84-02.93	CS1279	24 4.0	
		11.86-02.91	CA568IR	28 30	07.84-02.93	CS120	24 4.0	
		12.86-02.93	CA333IR	28 55				
		10.88-02.93	CA1035IR	28 80				
		03.91-02.93	CA854IR	28 35				



MERCEDES-BENZ Continued

	[OM366.914]	07.84- 10.86	CA1871R	28 27	07.84- 02.93	CS120	24 4.0
		11.86- 02.91	CA5681R	28 30	07.84- 02.93	CS1279	24 4.0
		12.86- 02.93	CA3331R	28 55			
		10.88- 02.93	CA10351R	28 80			
		03.91- 02.93	CA8541R	28 35			
	[OM366.918]	06.87- 02.93	CA10351R	28 80	06.87- 02.93	CS1279	24 4.0
		06.87- 02.93	CA3331R	28 55	06.87- 02.93	CS120	24 4.0
		06.87- 02.91	CA5681R	28 30			
		03.91- 02.93	CA8541R	28 35			
	[OM366.936]	07.84- 02.93	CA8541R	28 35	07.84- 02.93	CS120	24 4.0
					07.84- 02.93	CS1279	24 4.0
	[OM366.937]	06.87- 02.93	CA10351R	28 80	06.87- 02.93	CS120	24 4.0
		06.87- 02.93	CA3331R	28 55	06.87- 02.93	CS1279	24 4.0
		06.87- 02.91	CA5681R	28 30			
		03.91- 02.93	CA8541R	28 35			
1317 4.2	(LK/LN2)[OM904.907]	03.96- 12.99	CA10351R	28 80	03.96- 12.99	CS1112	24 4.0 BO
		03.96- 12.98	CA16661R	28 80	03.96- 12.99	CS1381	24 4.0 DR
1317 4.3	(Atego)[OM900.913]	01.98- 10.04	CA16661R	28 80	01.98- 10.04	CS1381	24 4.0 DR
		01.98- 10.04	CA17391R	28 100	01.98- 10.04	CS1112	24 4.0 BO
	[OM904.911]	01.98- 10.04	CA15051R	28 100	01.98- 10.04	CS1381	24 4.0 DR
		01.98- 10.04	CA15931R	28 80	01.98- 10.04	CS1112	24 4.0 BO
1317 6.0	(LK/LN2)[OM356.944]	12.92- 12.99	CA10351R	28 80	12.92- 12.99	CS120	24 4.0
		12.92- 12.99	CA3331R	28 55	12.92- 12.99	CS1279	24 4.0
		12.92- 12.99	CA8541R	28 35			
	[OM356.945]	12.92- 12.99	CA10351R	28 80	12.92- 12.99	CS1279	24 4.0
		12.92- 12.99	CA3331R	28 55	12.92- 12.99	CS120	24 4.0
		12.92- 12.99	CA8541R	28 35			
	[OM356.995]	12.92- 12.98	CA8541R	28 35	12.92- 12.98	CS1279	24 4.0
					12.92- 12.98	CS120	24 4.0
	[OM357.902]	03.94- 12.99	CA10351R	28 80	07.84- 12.99	CS120	24 4.0
		03.94- 12.99	CA3331R	28 55	07.84- 12.99	CS1279	24 4.0
		03.94- 12.99	CA8541R	28 35			
	[OM357.903]	03.94- 12.98	CA10351R	28 80	03.94- 12.98	CS1279	24 4.0
		03.94- 12.98	CA3331R	28 55	03.94- 12.98	CS120	24 4.0
		03.94- 12.98	CA8541R	28 35			
	[OM357.907]	03.94- 12.99	CA10351R	28 80	03.94- 12.99	CS120	24 4.0
		03.94- 12.99	CA3331R	28 55	03.94- 12.99	CS1279	24 4.0
		03.94- 12.99	CA8541R	28 35			
	[OM357.961]	03.94- 12.98	CA10351R	28 80	08.84- 12.98	CS120	24 4.0
		03.94- 12.98	CA3331R	28 55	08.84- 12.98	CS1279	24 4.0
		03.94- 12.98	CA8541R	28 35			
	[OM357.962]	03.94- 12.98	CA10351R	28 80	03.94- 12.98	CS1279	24 4.0
		03.94- 12.98	CA3331R	28 55	03.94- 12.98	CS120	24 4.0
		03.94- 12.98	CA8541R	28 35			
	[OM366.944]	08.84- 10.86	CA1871R	28 27	08.84- 02.93	CS1279	24 4.0
		08.84- 02.93	CA8541R	28 35	08.84- 02.93	CS120	24 4.0
		11.86- 02.91	CA5681R	28 30			
		12.86- 02.93	CA3331R	28 55			
		10.88- 02.93	CA10351R	28 80			
	[OM366.946]	08.84- 10.86	CA1871R	28 27	08.84- 02.93	CS120	24 4.0
		11.86- 02.91	CA5681R	28 30	08.84- 02.93	CS1279	24 4.0
		12.86- 02.93	CA3331R	28 55			
		10.88- 02.93	CA10351R	28 80			
		03.91- 02.93	CA8541R	28 35			
	[OM366.953]	08.84- 10.86	CA1871R	28 27	08.84- 02.93	CS1279	24 4.0
		11.86- 02.91	CA5681R	28 30	08.84- 02.93	CS120	24 4.0
		12.86- 02.93	CA3331R	28 55			
		10.88- 02.93	CA10351R	28 80			
		03.91- 02.93	CA8541R	28 35			
	[OM366.962]	07.84- 10.86	CA1871R	28 27	07.84- 12.98	CS1279	24 4.0
		07.84- 12.98	CA8541R	28 35	07.84- 12.98	CS120	24 4.0
		11.86- 02.91	CA5681R	28 30			
		12.86- 12.98	CA3331R	28 55			
		10.88- 12.98	CA10351R	28 80			
	[OM366.966]	06.87- 02.93	CA8541R	28 35	06.87- 02.93	CS120	24 4.0
					06.87- 02.97	CS1279	24 4.0
1318 4.2	(Atego 2)[OM900.913]	10.04-	CA16661R	28 80	10.04-	CS1112	24 4.0 BO
		10.04-	CA17391R	28 100	10.04-	CS1381	24 4.0 DR
1318 4.3	(Atego)[OM900.913]	02.06-	CA16661R	28 80	02.06-	CS1381	24 4.0 DR
		02.06-	CA17391R	28 100	02.06-	CS1112	24 4.0 BO
	[OM904.911]	01.98- 10.04	CA15051R	28 100	01.98- 10.04	CS1112	24 4.0 BO
		01.98- 10.04	CA15931R	28 80	01.98- 10.04	CS1381	24 4.0 DR
	(Atego 2)[OM900.913]	10.04-	CA16661R	28 80	10.04-	CS1112	24 4.0 BO
		10.04-	CA17391R	28 100	10.04-	CS1381	24 4.0 DR
1320 6.0	(LK/LN2)[OM356.983]	12.92- 12.98	CA10351R	28 80	12.92- 12.98	CS120	24 4.0
		12.92- 12.98	CA3331R	28 55	12.92- 12.98	CS1279	24 4.0
		12.92- 12.98	CA8541R	28 35			
	[OM356.992]	12.92- 12.99	CA10351R	28 80	12.92- 12.99	CS120	24 4.0
		12.92- 12.99	CA3331R	28 55	12.92- 12.99	CS1279	24 4.0
		12.92- 12.99	CA8541R	28 35			
	[OM356.995]	12.92- 12.98	CA10351R	28 80	12.92- 12.98	CS120	24 4.0
		12.92- 12.98	CA3331R	28 55			
		12.92- 12.98	CA8541R	28 35			
	[OM357.921]	03.94- 12.99	CA10351R	28 80	03.94- 12.99	CS1279	24 4.0
		03.94- 12.99	CA3331R	28 55	03.94- 12.99	CS120	24 4.0
		03.94- 12.99	CA8541R	28 35			
	[OM357.932]	03.94- 12.99	CA10351R	28 80	03.94- 12.99	CS120	24 4.0
		03.94- 12.99	CA3331R	28 55	03.94- 12.99	CS1279	24 4.0
		03.94- 12.99	CA8541R	28 35			
	[OM366.962]	10.84- 02.93	CA8541R	28 35	10.84- 02.93	CS120	24 4.0
					10.84- 02.93	CS1279	24 4.0
	[OM366.966]	03.85- 02.93	CA8541R	28 35	03.85- 02.93	CS120	24 4.0
					03.85- 02.93	CS1279	24 4.0
	[OM366.980]	10.84- 02.93	CA8541R	28 35	10.84- 02.93	CS120	24 4.0
					10.84- 02.93	CS1279	24 4.0
	[OM366.988]	10.84- 10.86	CA1871R	28 27	10.84- 02.93	CS1279	24 4.0
		11.86- 02.91	CA5681R	28 30	10.84- 02.93	CS120	24 4.0
		12.86- 02.93	CA3331R	28 55			
		10.88- 02.93	CA10351R	28 80			
		03.91- 02.93	CA8541R	28 35			
	[OM366.992]	10.84- 10.86	CA1871R	28 27	10.84- 03.93	CS1279	24 4.0
		11.86- 02.91	CA5681R	28 30	10.84- 03.93	CS120	24 4.0
		12.86- 02.93	CA3331R	28 55			
		10.88- 02.93	CA10351R	28 80			
		03.91- 02.93	CA8541R	28 35			
	[OM366.997]	10.84- 10.86	CA1871R	28 27	10.84- 02.93	CS1279	24 4.0
		11.86- 02.91	CA5681R	28 30	10.84- 02.93	CS120	24 4.0
		12.86- 02.93	CA3331R	28 55			
		10.88- 02.93	CA10351R	28 80			
		03.91- 02.93	CA8541R	28 35			





1322 4.8	(Atego 2)[OM924.920]	10.04-10.04-	CA1666IR	28 80	10.04-10.04-	CS1112	24 4.0	BO	
			CA1739IR	28 100		CS1381	24 4.0	DR	
					06.06-	CS1112	24 4.0		
1323 6.4	(Atego)[OM906.910]	01.98-10.04	CA1505IR	28 100	01.98-10.04	CS1112	24 4.0	BO	
		01.98-10.04	CA1593IR	28 80	01.98-10.04	CS1381	24 4.0	DR	
		01.98-09.04	CA1924IR	28 180					
	[OM906.915]	01.98-09.04	CA1505IR	28 100	01.98-09.04	CS1112	24 4.0		
		01.98-09.04	CA1593IR	28 80					
		01.98-09.04	CA1924IR	28 180					
	(Atego 2)[OM902.916]	10.04-10.04-	CA1666IR	28 80	10.04-	CS1112	24 4.0		
			CA1739IR	28 100					
			CA1505IR	28 100	10.04-	CS1112	24 4.0	BO	
	[OM906.910]	10.04-	CA1593IR	28 80	10.04-	CS1381	24 4.0	DR	
		10.04-	CA1666IR	28 80					
		10.04-	CA1739IR	28 100					
10.04-		CA1666IR	28 80	10.04-	CS1112	24 4.0	BO		
[OM906.915]	10.04-	CA1739IR	28 100	10.04-	CS1381	24 4.0	DR		
1324 6.0	(LK/LN2)[OM356.983]	01.91-02.01	CA1035IR	28 80	01.91-02.01	CS1279	24 4.0		
		01.91-02.01	CA333IR	28 55	01.91-02.01	CS120	24 4.0		
		01.91-02.01	CA568IR	28 30					
		03.91-02.01	CA854IR	28 35					
	[OM357.940]	03.94-12.98	CA1035IR	28 80	03.94-12.98	CS1279	24 4.0		
		03.94-12.98	CA333IR	28 55	03.94-12.98	CS120	24 4.0		
		03.94-12.98	CA854IR	28 35					
	[OM357.948]	03.94-12.98	CA1035IR	28 80	03.94-12.98	CS1279	24 4.0		
		03.94-12.98	CA333IR	28 55	03.94-12.98	CS120	24 4.0		
		03.94-12.98	CA854IR	28 35					
	[OM366.997]	01.91-02.01	CA333IR	28 55	01.91-02.01	CS1279	24 4.0		
		01.91-02.01	CA854IR	28 35	01.91-02.01	CS120	24 4.0		
01.91-02.01		CA854IR	28 35	01.91-02.01	CS1279	24 4.0			
1324 6.4	(Atego 2)[OM902.916]	10.04-10.04-	CA1666IR	28 80	10.04-	CS1112	24 4.0		
			CA1739IR	28 100	10.04-	CS1381	24 4.0	DR	
			CA1505IR	28 100	10.04-	CS1112	24 4.0	BO	
	[OM906.910]	10.04-	CA1593IR	28 80	10.04-	CS1381	24 4.0	DR	
		10.04-	CA1666IR	28 80					
		10.04-	CA1739IR	28 100					
	[OM906.915]	10.04-	CA1666IR	28 80	10.04-	CS1112	24 4.0	BO	
		10.04-	CA1739IR	28 100	10.04-	CS1381	24 4.0	DR	
	1325 6.4	(Atego)[OM906.919]	01.98-10.04	CA1505IR	28 100	01.98-10.04	CS1381	24 4.0	DR
			01.98-10.04	CA1593IR	28 80	01.98-10.04	CS1112	24 4.0	BO
	1326 6.4	(Atego 2)[OM902.917]	10.04-10.04-	CA1666IR	28 80	10.04-	CS1112	24 4.0	
			CA1739IR	28 100	10.04-	CS1381	24 4.0	DR	
1328 6.4	(Atego)[OM906.911]	01.98-10.04	CA1505IR	28 100	01.98-10.04	CS1112	24 4.0	BO	
		01.98-10.04	CA1593IR	28 80	01.98-10.04	CS1381	24 4.0	DR	
	(Atego 2)[OM902.918]	10.04-10.04-	CA1666IR	28 80	10.04-	CS1112	24 4.0		
			CA1739IR	28 100					
	[OM906.911]	10.04-	CA1666IR	28 80	10.04-	CS1112	24 4.0	BO	
		10.04-	CA1739IR	28 100	10.04-	CS1381	24 4.0	DR	
[OM906.916]	10.04-	CA1505IR	28 100	10.04-	CS1112	24 4.0	BO		
	10.04-	CA1593IR	28 80	10.04-	CS1381	24 4.0	DR		
	10.04-	CA1666IR	28 80						
	10.04-	CA1739IR	28 100						
1329 6.4	(Atego 2)[OM902.918]	10.04-10.04-	CA1666IR	28 80	10.04-	CS1112	24 4.0		
			CA1739IR	28 100					
	[OM906.911]	10.04-	CA1666IR	28 80	10.04-	CS1112	24 4.0	BO	
		10.04-	CA1739IR	28 100	10.04-	CS1381	24 4.0	DR	
	[OM906.916]	10.04-	CA1505IR	28 100	10.04-	CS1112	24 4.0	BO	
		10.04-	CA1593IR	28 80	10.04-	CS1381	24 4.0	DR	
1413 5.7	(NG)[OM353.944]	08.79-12.84	CA186IR	14 55	09.75-12.84	CS186	12 3.0		
		08.79-12.84	CA186IR	14 55	09.75-12.84	CS186	12 3.0		
		08.79-12.84	CA186IR	14 55	09.75-12.84	CS186	12 3.0		
1414 6.0	(NG)[OM366.906]	04.84-03.91	CA187IR	28 27	04.84-03.91	CS120	24 4.0		
		11.86-03.91	CA568IR	28 30					
		12.86-03.91	CA333IR	28 55					
		10.88-03.91	CA1035IR	28 80					
		02.91-03.91	CA854IR	28 35					
		04.84-10.86	CA187IR	28 27	04.84-03.91	CS120	24 4.0		
	[OM366.909]	11.86-03.91	CA568IR	28 30					
		12.86-03.91	CA333IR	28 55					
		10.88-03.91	CA1035IR	28 80					
		02.91-03.91	CA854IR	28 35					
1417 5.8	(NG)[OM353.951]	08.79-12.84	CA186IR	14 55	05.75-12.84	CS186	12 3.0		
		08.79-12.84	CA186IR	14 55	05.75-12.84	CS186	12 3.0		
		07.79-12.84	CA186IR	14 55	05.75-12.84	CS186	12 3.0		
	[OM353.953]	07.79-12.84	CA186IR	14 55	05.75-12.84	CS186	12 3.0		
1417 6.0	(MK)[OM356.940]	07.89-09.96	CA1035IR	28 80	07.89-09.96	CS120	24 4.0		
		07.89-09.96	CA333IR	28 55					
		07.89-09.96	CA854IR	28 35					
	[OM356.943]	07.92-09.96	CA1035IR	28 80	07.92-09.06	CS120	24 4.0		
		07.92-09.09	CA333IR	28 55	07.92-09.06	CS1279	24 4.0		
		07.92-09.96	CA854IR	28 35					
	[OM357.915]	01.94-09.96	CA333IR	28 55	01.94-09.96	CS120	24 4.0		
		01.94-09.96	CA854IR	28 35	01.94-09.96	CS1279	24 4.0		
		03.94-09.96	CA1035IR	28 80					
	[OM366.952]	07.89-07.92	CA1035IR	28 80	07.89-07.92	CS120	24 4.0		
		07.89-07.92	CA333IR	28 55	07.89-07.92	CS1279	24 4.0		
		07.89-02.91	CA568IR	28 30					
(NG)[OM366.951]	03.91-07.92	CA854IR	28 35						
	04.84-10.86	CA187IR	28 27	04.84-03.91	CS120	24 4.0			
	11.86-03.91	CA568IR	28 30						
	12.86-03.91	CA333IR	28 55						
[OM366.952]	10.88-03.91	CA1035IR	28 80						
	04.84-10.86	CA187IR	28 27	04.84-03.91	CS120	24 4.0			
	11.86-03.91	CA568IR	28 30						
	12.86-03.91	CA333IR	28 55						
1419 5.7	(NG)[OM362.906]	05.83-06.85	CA187IR	28 27	05.83-06.85	CS120	24 4.0		
		05.83-06.85	CA187IR	28 27	05.83-06.85	CS120	24 4.0		
1419 9.6	(NG)[OM401.905]	03.78-12.84	CA186IR	14 55	05.75-02.77	CS198	24 6.0		
					03.77-12.84	CS191	24 5.4		
					05.75-02.77	CS198	24 6.0		
[OM401.914]	04.81-12.82	CA186IR	14 55	03.77-12.82	CS191	24 5.4			
1420 10.9	(NG)[OM421.905]	05.82-10.86	CA187IR	28 27	05.82-10.90	CS191	24 5.4		
		11.86-10.90	CA333IR	28 55					
		11.86-10.90	CA568IR	28 30					
1420 11.0	(MK)[OM441.905]	09.89-09.96	CA568IR	28 30	09.89-09.96	CS191	24 5.4		
		09.89-09.96	CA854IR	28 35					



MERCEDES-BENZ Continued

	[OM441.923]	09.89- 09.96 CA333IR 28 55		09.89- 09.96 CS191 24 5.4
		09.89- 09.96 CA568IR 28 30		
		09.89- 09.96 CA854IR 28 35		
1420 6.0	(MK)[OM356.984]	02.90- 09.96 CA1035IR 28 80		02.90- 09.96 CS120 24 4.0
		02.90- 09.96 CA333IR 28 55		
		02.90- 02.91 CA568IR 28 30		
		03.91- 06.93 CA854IR 28 35		
	[OM356.987]	09.89- 09.96 CA1035IR 28 80		09.89- 09.96 CS120 24 4.0
		09.89- 09.96 CA333IR 28 55		
		09.89- 09.96 CA854IR 28 35		
	(NG)[OM366.983]	07.85- 10.86 CA187IR 28 27		07.85- 03.91 CS120 24 4.0
		07.85- 03.91 CA854IR 28 35		
		11.86- 03.91 CA333IR 28 55		
		11.86- 03.91 CA568IR 28 30		
		10.88- 03.91 CA1035IR 28 80		
1422 10.9	(NG)[OM401.905]	05.82- 05.85 CA187IR 28 27		05.82- 10.90 CS191 24 5.4
		06.86- 10.90 CA854IR 28 35		
		10.88- 10.90 CA1035IR 28 80		
	[OM421.906]	05.82- 10.90 CA333IR 28 55		05.82- 10.90 CS191 24 5.4
		10.88- 10.90 CA1035IR 28 80		
1422 11.3	(MK)[OM441.905]	06.89- 08.94 CA1035IR 28 80		06.89- 08.94 CS191 24 5.4
		06.89- 08.94 CA333IR 28 55		
		06.89- 02.91 CA568IR 28 30		
		03.91- 08.94 CA854IR 28 35		
	[OM441.913]	07.89- 09.93 CA1035IR 28 80		07.89- 09.93 CS191 24 5.4
		07.89- 09.93 CA333IR 28 55		
	[OM441.923]	06.89- 08.94 CA1035IR 28 80		06.89- 08.94 CS191 24 5.4
		06.89- 08.94 CA333IR 28 55		
		06.89- 02.91 CA568IR 28 30		
		03.91- 08.94 CA854IR 28 35		
	[OM441.925]	07.89- 09.93 CA1035IR 28 80		07.89- 09.93 CS191 24 5.4
		07.89- 09.93 CA333IR 28 55		
1422 6.0	(MK)[OM356.999]	03.93- 08.94 CA333IR 28 55		03.93- 08.94 CS120 24 4.0
1422 9.6	(MK)[OM401.973]	02.93- 08.94 CA854IR 28 35		02.93- 08.94 CS191 24 5.4
	[OM401.975]	02.93- 08.94 CA854IR 28 35		02.93- 08.94 CS191 24 5.4
	[OM401.977]	02.93- 08.94 CA854IR 28 35		02.93- 08.94 CS191 24 5.4
	[OM401.978]	02.93- 08.94 CA854IR 28 35		02.93- 08.94 CS191 24 5.4
	[OM401.979]	02.93- 08.94 CA854IR 28 35		02.93- 08.94 CS191 24 5.4
1424 11.0	(MK)[OM445.924]	01.95- 09.96 CA1035IR 28 80		01.95- 09.96 CS191 24 5.4
		01.95- 09.96 CA333IR 28 55		
	[OM445.926]	01.95- 09.96 CA1035IR 28 80		01.95- 09.96 CS191 24 5.4
		01.95- 09.96 CA333IR 28 55		
	[OM445.938]	01.95- 09.96 CA1035IR 28 80		01.95- 09.96 CS191 24 5.4
		01.95- 09.96 CA333IR 28 55		
1424 12.8	(NG)[OM402.910]	11.79- 01.87 CA186IR 14 55		03.77- 01.87 CS191 24 5.4
				05.75- 02.77 CS198 24 6.0
	[OM402.911]	11.79- 01.87 CA186IR 14 55		05.75- 02.77 CS198 24 6.0
				03.77- 01.87 CS191 24 5.4
	[OM402.919]			03.77- 01.87 CS191 24 5.4
				07.75- 02.77 CS198 24 6.0
1424 6.0	(MK)[OM357.946]	07.89- 09.96 CA333IR 28 55		02.92- 09.96 CS1279 24 4.0
				07.89- 09.96 CS120 24 4.0
1424 9.6	(MK)[OM401.973]	02.93- 09.96 CA1035IR 28 80		02.93- 09.96 CS191 24 5.4
		02.93- 09.96 CA333IR 28 55		
		02.93- 09.96 CA854IR 28 35		
	[OM401.975]	02.93- 09.96 CA1035IR 28 80		02.93- 09.96 CS191 24 5.4
		02.93- 09.96 CA333IR 28 55		
		02.93- 09.96 CA854IR 28 35		
	[OM401.994]	02.93- 09.96 CA1035IR 28 80		02.93- 09.96 CS191 24 5.4
		02.93- 09.96 CA333IR 28 55		
		02.93- 09.96 CA854IR 28 35		
1425 14.6	(NG)[OM422.909]	11.82- 10.86 CA187IR 28 27		11.82- 09.96 CS191 24 5.4
		11.86- 09.96 CA333IR 28 55		11.82- 09.96 CS198 24 6.0
		11.86- 03.91 CA568IR 28 30		
		10.88- 09.96 CA1035IR 28 80		
		03.91- 09.96 CA854IR 28 35		
1426 15.1	(MK)[OM442.914]	06.89- 09.93 CA1035IR 28 80		06.89- 09.93 CS191 24 5.4
		06.89- 09.93 CA333IR 28 55		
		06.89- 02.91 CA568IR 28 30		
		03.91- 09.93 CA854IR 28 35		
	[OM442.932]	06.89- 09.93 CA1035IR 28 80		06.89- 09.93 CS191 24 5.4
		06.89- 09.93 CA333IR 28 55		
		06.89- 02.91 CA568IR 28 30		
		03.91- 09.93 CA854IR 28 35		
1427 11.0	(MK)[OM445.926]	02.93- 09.96 CA1035IR 28 80		02.93- 09.96 CS191 24 5.4
		02.93- 09.96 CA333IR 28 55		
1427 3.0	(MK)[OM401.985]	02.93- 09.96 CA1035IR 28 80		02.93- 09.96 CS191 24 5.4
		02.93- 09.96 CA333IR 28 55		
1427 9.6	(MK)[OM401.973]	12.87- 09.96 CA1035IR 28 80		12.87- 09.96 CS191 24 5.4
		12.87- 09.96 CA333IR 28 55		
		12.87- 09.96 CA854IR 28 35		
	[OM401.991]	02.93- 09.96 CA1035IR 28 80		02.93- 09.96 CS191 24 5.4
		02.93- 09.96 CA333IR 28 55		
	[OM445.936]	01.94- 09.96 CA1035IR 28 80		01.94- 09.96 CS191 24 5.4
		01.94- 09.96 CA333IR 28 55		
1428 14.6	(NG)[OM422.907]	05.82- 12.91 CA568IR 28 30		05.82- 12.91 CS191 24 5.4
		05.82- 12.91 CA854IR 28 35		
	[OM422.913]	08.73- 09.96 CA187IR 28 27		08.73- 09.96 CS191 24 5.4
		05.82- 09.96 CA333IR 28 55		
		05.82- 12.91 CA568IR 28 30		
		05.82- 09.96 CA854IR 28 35		
1429 15.1	(NG)[OM442.907]	08.73- 09.96 CA1035IR 28 80		08.73- 09.96 CS191 24 5.4
		08.73- 09.96 CA333IR 28 55		
		08.73- 09.96 CA854IR 28 35		
1431 15.1	(MK)[OM442.907]	12.87- 08.96 CA1035IR 28 80		12.87- 08.96 CS198 24 6.0
		12.87- 08.96 CA333IR 28 55		12.87- 08.96 CS191 24 5.4
		12.87- 08.96 CA854IR 28 35		
1431 9.6	(MK)[OM401.979]	12.87- 08.96 CA1035IR 28 80		12.87- 08.96 CS191 24 5.4
		12.87- 08.96 CA333IR 28 55		
		12.87- 08.96 CA854IR 28 35		
1514 6.0	(LK/LN2)[OM356.908]	01.89- 12.99 CA1035IR 28 80		01.89- CS1279 24 4.0
		01.89- 12.99 CA333IR 28 55		01.89- 12.92 CS120 24 4.0
		12.92- 12.99 CA854IR 28 35		
	[OM366.936]	01.89- 12.92 CA1035IR 28 80		01.89- 12.92 CS120 24 4.0
		01.89- 12.92 CA333IR 28 55		01.89- 12.92 CS1279 24 4.0
		01.89- 12.92 CA568IR 28 30		
		01.89- 12.92 CA854IR 28 35		
1517 4.2	(Atego)[OM904.911]	01.98- 10.04 CA1505IR 28 100		01.98- 10.04 CS1112 24 4.0
		01.98- 10.04 CA1593IR 28 80		
		01.98- 10.04 CA1924IR 28 180		



	[OM904.917]	01.98- 10.04 01.98- 10.04 01.98- 10.04	CA1505IR CA1593IR CA1924IR	28 100 28 80 28 180		01.98- 10.04	CS1112	24 4.0
	(LK/LN2)[OM904.907]	03.96- 12.99	CA1035IR	28 80		03.96- 12.99	CS1381 CS1112	24 4.0 DR 24 4.0 BO
1517 4.3	(Atego)[OM904.911]	01.98- 10.04 01.98- 10.04	CA1505IR CA1593IR	28 100 28 80		01.98- 10.04 01.98- 10.04	CS1381 CS1112	24 4.0 DR 24 4.0 BO
1517 6.0	(LK/LN2)[OM356.946]	10.88- 12.98 10.88- 12.98 10.88- 12.98	CA1035IR CA333IR CA854IR	28 80 28 55 28 35		10.88- 12.98 10.88- 12.98 10.88- 12.98	CS120 CS1279	24 4.0 24 4.0
	[OM356.953]	12.92- 12.99 12.92- 12.99 12.92- 12.99	CA1035IR CA333IR CA854IR	28 80 28 55 28 35		12.92- 12.99 12.92- 12.99 12.92- 12.99	CS120 CS1279	24 4.0 24 4.0
	[OM357.903]	03.94- 12.98 03.94- 12.98 03.94- 12.98	CA1035IR CA333IR CA854IR	28 80 28 55 28 35		03.94- 12.98 03.94- 12.98 03.94- 12.98	CS1279 CS120	24 4.0 24 4.0
	[OM357.962]	03.94- 12.99 03.94- 12.99 03.94- 12.99	CA1035IR CA333IR CA854IR	28 80 28 55 28 35		03.94- 12.99 03.94- 12.99 03.94- 12.99	CS1279 CS120	24 4.0 24 4.0
	[OM357.963]	03.94- 12.99 03.94- 12.99 03.94- 12.99	CA1035IR CA333IR CA854IR	28 80 28 55 28 35		03.94- 12.99 03.94- 12.99 03.94- 12.99	CS1279 CS120	24 4.0 24 4.0
	[OM366.945]	01.89- 12.92 01.89- 12.92 01.89- 12.92	CA1035IR CA333IR CA854IR	28 80 28 55 28 35		01.89- 12.92 01.89- 12.92 01.89- 12.92	CS1279 CS120	24 4.0 24 4.0
	[OM366.979]	01.89- 12.92 01.89- 12.92 01.89- 12.92	CA1035IR CA333IR CA854IR	28 80 28 55 28 35		01.89- 12.92 01.89- 12.92 01.89- 12.92	CS1279 CS120	24 4.0 24 4.0
1518 4.2	(Atego 2)[OM900.913]	10.04- 10.04	CA1666IR CA1739IR	28 80 28 100		10.04- 10.04	CS1112 CS1381	24 4.0 24 4.0 DR
1518 4.3	(Atego 2)[OM900.913]	10.04- 10.04	CA1666IR CA1739IR	28 80 28 100		10.04- 10.04	CS1112 CS1381	24 4.0 BO 24 4.0 DR
1520 6.0	(LK/LN2)[OM356.990]	12.92- 12.99 12.92- 12.99 12.92- 12.99	CA1035IR CA333IR CA854IR	28 80 28 55 28 35		12.92- 12.99 12.92- 12.99 12.92- 12.99	CS120 CS1279	24 4.0 24 4.0
	[OM357.922]	03.94- 12.99 03.94- 12.99 03.94- 12.99	CA1035IR CA333IR CA854IR	28 80 28 55 28 35		03.94- 12.99 03.94- 12.99 03.94- 12.99	CS1279 CS120	24 4.0 24 4.0
	[OM357.930]	03.94- 12.99 03.94- 12.99 03.94- 12.99	CA1035IR CA333IR CA854IR	28 80 28 55 28 35		03.94- 12.99 03.94- 12.99 03.94- 12.99	CS1279 CS120	24 4.0 24 4.0
	[OM366.995]	01.89- 12.92 01.89- 12.92 01.89- 12.92	CA1035IR CA333IR CA854IR	28 80 28 55 28 35		01.89- 12.92 01.89- 12.92 01.89- 12.92	CS120 CS1279	24 4.0 24 4.0
1522 4.8	(Atego 2)[OM924.920]	10.04- 10.04 10.04- 10.04 10.04- 10.04	CA1505IR CA1666IR CA1739IR	28 100 28 80 28 100		10.04- 10.04	CS1112 CS1381	24 4.0 BO 24 4.0 DR
	[OM924.922]					06.06-	CS1112	24 4.0
1523 6.4	(Atego)[OM906.910]	01.98- 10.04 01.98- 10.04 01.98- 10.04 01.98- 10.04	CA1505IR CA1593IR CA1666IR CA1739IR	28 100 28 80 28 80 28 100		01.98- 10.04 01.98- 10.04 01.98- 10.04 01.98- 10.04	CS1112 CS1381	24 4.0 BO 24 4.0 DR
	(Atego 2)[OM902.916]	10.04- 10.04	CA1666IR CA1739IR	28 80 28 100		10.04- 10.04	CS1112 CS1381	24 4.0 24 4.0 DR
	[OM906.910]	10.04- 10.04 10.04- 10.04 10.04- 10.04 10.04- 10.04	CA1505IR CA1593IR CA1666IR CA1739IR	28 100 28 80 28 80 28 100		10.04- 10.04 10.04- 10.04 10.04- 10.04 10.04- 10.04	CS1112 CS1381	24 4.0 BO 24 4.0 DR
	[OM906.915]	10.04- 10.04 10.04- 10.04	CA1666IR CA1739IR	28 80 28 100		10.04- 10.04	CS1112 CS1381	24 4.0 BO 24 4.0 DR
1524 6.0	(LK/LN2)[OM356.999]	02.91- 02.01 02.91- 02.01 02.91- 02.01	CA1035IR CA333IR CA854IR	28 80 28 55 28 35		02.91- 02.01 02.91- 02.01 02.91- 02.01	CS120 CS1279	24 4.0 24 4.0
	[OM357.941]	02.91- 12.98 02.91- 12.98 02.91- 12.98	CA1035IR CA333IR CA854IR	28 80 28 55 28 35		02.91- 12.98 02.91- 12.98 02.91- 12.98	CS1279 CS120	24 4.0 24 4.0
	[OM357.947]	02.91- 12.98 02.91- 12.98 02.91- 12.98	CA1035IR CA333IR CA854IR	28 80 28 55 28 35		02.91- 12.98 02.91- 12.98 02.91- 12.98	CS1279 CS120	24 4.0 24 4.0
	[OM366.999]	02.91- 02.01 02.91- 02.01 02.91- 02.01	CA1035IR CA333IR CA854IR	28 80 28 55 28 35		02.91- 02.01 02.91- 02.01 02.91- 02.01	CS1279 CS120	24 4.0 24 4.0
1524 6.4	(Atego 2)[OM902.916]	10.04- 10.04	CA1666IR CA1739IR	28 80 28 100		10.04- 10.04	CS1112	24 4.0
	[OM906.910]	10.04- 10.04 10.04- 10.04 10.04- 10.04 10.04- 10.04	CA1505IR CA1593IR CA1666IR CA1739IR	28 100 28 80 28 80 28 100		10.04- 10.04 10.04- 10.04 10.04- 10.04 10.04- 10.04	CS1112 CS1381	24 4.0 BO 24 4.0 DR
	[OM906.915]	10.04- 10.04 10.04- 10.04	CA1666IR CA1739IR	28 80 28 100		10.04- 10.04	CS1112 CS1381	24 4.0 BO 24 4.0 DR
1525 6.4	(Atego)[OM906.919]	01.98- 10.04 01.98- 10.04	CA1505IR CA1593IR	28 100 28 80		01.98- 10.04 01.98- 10.04	CS1112 CS1381	24 4.0 BO 24 4.0 DR
1526 6.4	(Atego 2)[OM902.917]	10.04- 10.04	CA1666IR CA1739IR	28 80 28 100		10.04- 10.04	CS1381 CS1112	24 4.0 DR 24 4.0
1528 6.4	(Atego)[OM906.911]	01.98- 10.04 01.98- 10.04 01.98- 09.04	CA1505IR CA1593IR CA1924IR	28 100 28 80 28 180		01.98- 10.04 01.98- 10.04 01.98- 09.04	CS1112 CS1381	24 4.0 BO 24 4.0 DR
	[OM906.916]	01.98- 09.04 01.98- 09.04 01.98- 09.04	CA1505IR CA1593IR CA1924IR	28 100 28 80 28 180		01.98- 09.04	CS1112	24 4.0
	(Atego 2)[OM902.918]	10.04- 10.04	CA1666IR CA1739IR	28 80 28 100		10.04- 10.04	CS1112	24 4.0
	[OM906.911]	10.04- 10.04 10.04- 10.04	CA1666IR CA1739IR	28 80 28 100		10.04- 10.04 10.04- 10.04	CS1112 CS1381	24 4.0 BO 24 4.0 DR
	[OM906.916]	10.04- 10.04 10.04- 10.04 10.04- 10.04	CA1505IR CA1593IR CA1666IR CA1739IR	28 100 28 80 28 80 28 100		10.04- 10.04 10.04- 10.04 10.04- 10.04	CS1112 CS1381	24 4.0 BO 24 4.0 DR
1529 6.4	(Atego 2)[OM902.918]	10.04- 10.04	CA1666IR CA1739IR	28 80 28 100		10.04- 10.04	CS1112	24 4.0
	[OM906.911]	10.04- 10.04	CA1666IR	28 80		10.04- 10.04	CS1112	24 4.0 BO
	[OM906.916]	10.04- 10.04 10.04- 10.04 10.04- 10.04	CA1739IR CA1505IR CA1593IR CA1666IR CA1739IR	28 100 28 100 28 80 28 80 28 100		10.04- 10.04 10.04- 10.04 10.04- 10.04 10.04- 10.04 10.04- 10.04	CS1381 CS1112 CS1381	24 4.0 DR 24 4.0 BO 24 4.0 DR
1613 5.7	(NG)[OM353.944]	07.79- 12.84	CA186IR	14 55		01.75- 12.84	CS186	12 3.0
	[OM353.946]	08.79- 12.84	CA186IR	14 55		01.75- 12.84	CS186	12 3.0



MERCEDES-BENZ Continued

1614 6.0	(NG)[OM366.906]	04.84- 10.86 CA1871R 28 27	04.84- 03.91 CS120 24 4.0		
		04.84- 03.91 CA3331R 28 55			
		11.86- 03.91 CA5681R 28 30			
		10.88- 03.91 CA10351R 28 80			
	[OM366.909]	04.84- 03.91 CA10351R 28 80	04.84- 03.91 CS120 24 4.0		
		04.84- 03.91 CA8541R 28 35			
1617 5.7	(NG)[OM353.951]	08.79- 07.85 CA1861R 14 55	01.75- 07.85 CS186 12 3.0		
		08.79- 07.85 CA1861R 14 55	01.75- 07.85 CS186 12 3.0		
		08.79- 07.85 CA1861R 14 55	01.75- 07.85 CS186 12 3.0		
1617 6.0	(NG)[OM366.951]	04.84- 10.86 CA1871R 28 27	04.84- 03.91 CS120 24 4.0		
		04.84- 03.91 CA8541R 28 35			
		11.86- 03.91 CA3331R 28 55			
		11.86- 03.91 CA5681R 28 30			
	[OM366.952]	04.84- 10.86 CA1871R 28 27	04.84- 03.91 CS120 24 4.0		
		11.86- 03.91 CA3331R 28 55			
		11.86- 03.91 CA5681R 28 30			
1619 5.7	(NG)[OM362.906]	06.83- 06.85 CA1871R 28 27	06.83- 06.85 CS120 24 4.0		
		06.83- 06.85 CA1871R 28 27	06.83- 06.85 CS120 24 4.0		
1619 9.6	(NG)[OM401.905]	03.81- 10.86 CA1871R 28 27	03.77- 05.87 CS191 24 5.4		
		04.81- 05.87 CA1861R 14 55	11.74- 02.77 CS198 24 6.0		
		11.86- 05.87 CA5681R 28 30			
	[OM401.914]	04.81- 05.87 CA1861R 14 55	03.77- 05.87 CS191 24 5.4		
		04.81- 10.86 CA1871R 28 27	11.74- 02.77 CS198 24 6.0		
		11.86- 05.87 CA5681R 28 30			
1620 6.0	(NG)[OM366.983]	07.85- 10.86 CA1871R 28 27	07.85- 03.91 CS120 24 4.0		
		11.86- 03.91 CA3331R 28 55			
		11.86- 03.91 CA5681R 28 30			
		10.88- 03.91 CA10351R 28 80			
1622 10.9	(NG)[OM421.905]	05.82- 10.86 CA1871R 28 27	05.82- 03.91 CS198 24 6.0		
		11.86- 03.91 CA3331R 28 55	05.82- 03.91 CS191 24 5.4		
		11.86- 03.91 CA5681R 28 30			
			[OM441.906]	05.82- 10.86 CA1871R 28 27	05.82- 03.91 CS191 24 5.4
				11.86- 03.91 CA3331R 28 55	05.82- 03.91 CS198 24 6.0
		11.86- 03.91 CA5681R 28 30			
	[OM441.907]	05.82- 10.86 CA1871R 28 27	05.82- 03.91 CS198 24 6.0		
		11.86- 03.91 CA3331R 28 55	05.82- 03.91 CS191 24 5.4		
		11.86- 03.91 CA5681R 28 30			
1624 11.0	(MK)[OM445.924]	12.87- 09.96 CA10351R 28 80	12.87- 09.96 CS191 24 5.4		
		12.87- 09.96 CA3331R 28 55			
		12.87- 09.96 CA8541R 28 35			
1624 12.8	(NG)[OM402.910]	11.79- 08.82 CA1861R 14 55	07.75- 02.77 CS198 24 6.0		
			03.77- 08.82 CS191 24 5.4		
			03.77- 12.82 CS191 24 5.4		
	[OM402.911]	11.79- 12.82 CA1861R 14 55	05.75- 02.77 CS198 24 6.0		
	[OM402.923]	05.75- 12.82 CA1861R 14 55	05.75- 02.77 CS198 24 6.0		
			03.77- 12.82 CS191 24 5.4		
1624 9.6	(MK)[OM401.975]	12.87- 09.96 CA10351R 28 80	12.87- 09.96 CS191 24 5.4		
		12.87- 09.96 CA3331R 28 55			
		12.87- 09.96 CA8541R 28 35			
1625 14.6	(NG)[OM422.909]	05.80- 10.86 CA1871R 28 27	05.80- 11.89 CS198 24 6.0		
		11.86- 11.89 CA3331R 28 55	05.80- 11.89 CS191 24 5.4		
		11.86- 11.89 CA5681R 28 30			
		10.88- 10.89 CA10351R 28 80			
1626 12.8	(NG)[OM402.906]	11.79- 12.80 CA1871R 28 27	08.73- 02.77 CS198 24 6.0		
			03.77- 12.80 CS191 24 5.4		
			03.77- 12.80 CS191 24 5.4		
			05.74- 02.77 CS198 24 6.0		
	[OM402.912]	11.79- 12.80 CA1871R 28 27	03.77- 12.80 CS191 24 5.4		
	[OM402.916]	11.79- 12.80 CA1871R 28 27	05.74- 02.77 CS198 24 6.0		
			03.77- 12.80 CS191 24 5.4		
1627 15.1	(MK)[OM442.914]	01.92- 09.96 CA10351R 28 80	01.92- 09.96 CS191 24 5.4		
		01.92- 09.96 CA3331R 28 55			
		01.92- 09.96 CA8541R 28 35			
			[OM442.920]	01.92- 09.96 CA10351R 28 80	01.92- 09.96 CS191 24 5.4
			[OM442.932]	01.92- 09.96 CA3331R 28 55	01.92- 08.94 CS191 24 5.4
		01.92- 09.96 CA8541R 28 35			
	[OM442.933]		02.90- 09.93 CS191 24 5.4		
1628 14.6	(NG)[OM422.905]	01.80- 10.86 CA1871R 28 27	01.80- 05.89 CS191 24 5.4		
		06.85- 05.89 CA8541R 28 35	01.80- 05.89 CS198 24 6.0		
		11.86- 05.89 CA3331R 28 55			
		11.86- 05.89 CA5681R 28 30			
		10.88- 05.89 CA10351R 28 80			
			[OM422.906]	01.80- 10.86 CA1871R 28 27	01.80- 05.89 CS191 24 5.4
				06.85- 05.89 CA8541R 28 35	01.80- 05.89 CS198 24 6.0
				11.86- 05.89 CA3331R 28 55	
				11.86- 05.89 CA5681R 28 30	
				10.88- 05.89 CA10351R 28 80	
	[OM422.911]	01.80- 10.86 CA1871R 28 27	01.80- 05.89 CS191 24 5.4		
		06.85- 05.89 CA8541R 28 35	01.80- 05.89 CS198 24 6.0		
		11.86- 05.89 CA3331R 28 55			
		11.86- 05.89 CA5681R 28 30			
		10.88- 05.89 CA10351R 28 80			
	[OM422.913]	01.80- 10.86 CA1871R 28 27	01.80- 05.89 CS191 24 5.4		
		11.86- 05.89 CA3331R 28 55	05.83- 05.89 CS198 24 6.0		
		11.86- 05.89 CA5681R 28 30			
		11.88- 05.89 CA10351R 28 80			
1632 15.9	(NG)[OM403.916]	11.79- 09.83 CA1871R 28 27	08.73- 09.83 CS198 24 6.0		
		11.79- 09.83 CA1871R 28 27	05.74- 09.83 CS198 24 6.0		
		11.79- 09.83 CA1871R 28 27	05.74- 09.83 CS198 24 6.0		
1633 14.6	(NG)[OM422.952]	10.80- 10.86 CA1871R 28 27	10.80- 05.87 CS198 24 6.0		
		11.86- 05.87 CA3331R 28 55			
		11.86- 05.87 CA5681R 28 30			
	[OM422.954]	10.80- 10.86 CA1871R 28 27	10.80- 05.87 CS198 24 6.0		
		11.86- 05.87 CA3331R 28 55			
		11.86- 05.87 CA5681R 28 30			
	[OM422.956]	10.80- 10.86 CA1871R 28 27	10.80- 05.87 CS198 24 6.0		
		11.86- 05.87 CA3331R 28 55			
		11.86- 05.87 CA5681R 28 30			
	[OM422.957]	10.80- 10.86 CA1871R 28 27	10.80- 05.87 CS198 24 6.0		
		11.86- 05.87 CA3331R 28 55			
		11.86- 05.87 CA5681R 28 30			
	[OM422.958]	10.80- 10.86 CA1871R 28 27	10.80- 05.87 CS198 24 6.0		
		11.86- 05.87 CA3331R 28 55			
		11.86- 05.87 CA5681R 28 30			
1635 14.6	(NG)[OM442.950]	02.86- 10.86 CA1871R 28 27	02.86- 07.89 CS191 24 5.4		
		11.86- 07.89 CA3331R 28 55			
		11.86- 07.89 CA5681R 28 30			
		10.88- 07.89 CA10351R 28 80			



	[OM442.952]	02.86- 10.86 11.86- 07.89 11.86- 07.89 10.86- 07.89	CA1871R CA3331R CA5681R CA10351R	28 27 28 55 28 30 28 80		02.86- 07.89	CS191	24 5.4
1636 18.3	(NG)[OM423.905]	12.83- 10.86 11.86- 03.91 11.86- 03.91	CA1871R CA3331R CA5681R	28 27 28 55 28 30		12.83- 03.91	CS198	24 6.0
	[OM423.908]	12.83- 10.86 11.86- 03.91 11.86- 03.91	CA1871R CA3331R CA5681R	28 27 28 55 28 30		12.83- 03.91	CS198	24 6.0
1638 14.6	(NG)[OM422.953]	11.80- 10.86 11.86- 12.86 11.86- 12.86	CA1871R CA3331R CA5681R	28 27 28 55 28 30		11.80- 12.86	CS198	24 6.0
	[OM422.955]	11.80- 10.86 11.86- 12.86 11.86- 12.86	CA1871R CA3331R CA5681R	28 27 28 55 28 30		11.80- 12.86	CS198	24 6.0
	[OM422.959]	11.80- 10.86 11.86- 12.86 11.86- 12.86	CA1871R CA3331R CA5681R	28 27 28 55 28 30		11.80- 12.86	CS198	24 6.0
1644 14.6	(NG)[OM442.951]	06.86- 10.88 11.86- 08.89 11.86- 08.89 10.88- 08.89	CA1871R CA3331R CA5681R CA10351R	28 27 28 55 28 30 28 80		06.86- 08.89	CS191	24 5.4
	[OM442.953]	06.86- 10.86 11.86- 08.89 11.86- 08.89 10.88- 08.89	CA1871R CA3331R CA5681R CA10351R	28 27 28 55 28 30 28 80		06.86- 08.89	CS191	24 5.4
	[OM442.980]	06.86- 10.86 11.86- 08.89 11.86- 08.89 10.88- 08.89	CA1871R CA3331R CA5681R CA10351R	28 27 28 55 28 30 28 80		06.86- 08.89	CS191	24 5.4
1717 6.0	(MK)[OM356.940]	09.89- 08.94 09.89- 08.94 09.89- 02.91 03.91- 08.94	CA10351R CA3331R CA5681R CA8541R	28 80 28 55 28 30 28 35		09.89- 08.94	CS120	24 4.0
	[OM366.952]	09.89- 08.94 09.89- 08.94 09.89- 02.91 03.91- 08.94	CA10351R CA3331R CA5681R CA8541R	28 80 28 55 28 30 28 35		09.89- 08.94	CS120	24 4.0
1719 9.6	(NG)[OM401.909]					03.77- 08.82 09.73- 02.77	CS191 CS198	24 5.4 24 6.0
	[OM401.916]					03.77- 08.82 09.73- 02.77	CS191 CS198	24 5.4 24 6.0
1720 11.3	(MK)[OM441.916]	12.88- 08.94 12.88- 08.94 12.88- 08.94	CA10351R CA3331R CA8541R	28 80 28 55 28 35		12.88- 08.94	CS191	24 5.4
	[OM441.920]	12.88- 08.94 12.88- 08.94 12.88- 08.94	CA10351R CA3331R CA8541R	28 80 28 55 28 35		12.88- 08.94	CS191	24 5.4
	[OM441.932]	12.88- 08.94 12.88- 08.94 12.88- 08.94	CA10351R CA3331R CA8541R	28 80 28 55 28 35		12.88- 08.94	CS191	24 5.4
1720 6.0	(LK/LN2)[OM366.995]	01.84- 12.98 01.84- 12.98 01.84- 12.98 01.84- 12.98	CA10351R CA12361R CA3331R CA8541R	28 80 28 140 28 55 28 35		01.84- 12.98	CS1279 CS120	24 4.0 24 4.0
	(MK)[OM356.984]	02.90- 08.94 02.90- 08.94 02.90- 02.91 03.91- 08.94	CA10351R CA3331R CA5681R CA8541R	28 80 28 55 28 30 28 35		02.90- 08.94	CS120	24 4.0
	[OM356.985]	02.90- 08.94 02.90- 08.94 02.90- 02.91 03.91- 08.94	CA10351R CA3331R CA5681R CA8541R	28 80 28 55 28 30 28 35		02.90- 08.94	CS120	24 4.0
	[OM366.983]	02.90- 08.94 02.90- 08.94 02.90- 02.91 03.91- 08.94	CA10351R CA3331R CA5681R CA8541R	28 80 28 55 28 30 28 35		02.90- 08.94	CS120	24 4.0
1722 11.0	(MK)[OM441.905]	08.88- 08.94 08.88- 08.94 08.88- 08.94	CA10351R CA3331R CA8541R	28 80 28 55 28 35		08.88- 08.94	CS191	24 5.4
	[OM441.923]	08.88- 08.94 08.88- 08.94 08.88- 08.94	CA10351R CA3331R CA8541R	28 80 28 55 28 35		08.88- 08.94	CS191	24 5.4
1722 11.3	(MK)[OM441.905]	12.88- 08.94 12.88- 08.94 12.88- 02.91 03.91- 08.94	CA10351R CA3331R CA5681R CA8541R	28 80 28 55 28 30 28 35		12.88- 08.94	CS191	24 5.4
	[OM441.913]	12.88- 08.94 12.88- 08.94 12.88- 02.91 03.91- 08.94	CA10351R CA3331R CA5681R CA8541R	28 80 28 55 28 30 28 35		12.88- 08.94	CS191	24 5.4
	[OM441.914]	12.88- 08.94 12.88- 08.94 12.88- 02.91 03.91- 08.94	CA10351R CA3331R CA5681R CA8541R	28 80 28 55 28 30 28 35		12.88- 08.94	CS191	24 5.4
	[OM441.916]	12.88- 08.94 12.88- 08.94 12.88- 03.91 03.91- 08.94	CA10351R CA3331R CA5681R CA8541R	28 80 28 55 28 30 28 35		12.88- 08.94	CS191	24 5.4
	[OM441.920]	08.88- 08.94 08.88- 08.94 08.88- 08.94 12.88- 02.91	CA10351R CA3331R CA8541R CA5681R	28 80 28 55 28 35 28 30		08.88- 08.94	CS191	24 5.4
	[OM441.923]	12.88- 08.94 12.88- 08.94 12.88- 02.91 03.91- 08.94	CA10351R CA3331R CA5681R CA8541R	28 80 28 55 28 30 28 35		12.88- 08.94	CS191	24 5.4
	[OM441.926]	12.88- 08.94 12.88- 08.94 12.88- 02.91 03.91- 08.94	CA10351R CA3331R CA5681R CA8541R	28 80 28 55 28 30 28 35		12.88- 08.94	CS191	24 5.4
	[OM441.932]	12.88- 08.94 12.88- 08.94 12.88- 02.91 03.91- 08.94	CA10351R CA3331R CA5681R CA8541R	28 80 28 55 28 30 28 35		12.88- 08.94	CS191	24 5.4
	[OM441.933]	12.88- 08.94 12.88- 08.94 12.88- 02.91 03.91- 08.94	CA10351R CA3331R CA5681R CA8541R	28 80 28 55 28 30 28 35		12.88- 08.94	CS191	24 5.4



MERCEDES-BENZ Continued

1722 15.1	(MK)[OM442.907]	12.88- 08.94	CA1035IR	28 80	12.88- 08.94	CS191	24 5.4
		12.88- 08.94	CA333IR	28 55			
		12.88- 02.91	CA568IR	28 30			
		03.91- 08.94	CA854IR	28 35			
1722 6.0	(MK)[OM356.999]	12.88- 08.94	CA1035IR	28 80	12.88- 08.94	CS120	24 4.0
		12.88- 08.94	CA333IR	28 55			
		12.88- 02.91	CA568IR	28 30			
		03.91- 08.94	CA854IR	28 35			
	[OM366.983]	12.88- 08.94	CA1035IR	28 80	12.88- 08.94	CS120	24 4.0
		12.88- 08.94	CA333IR	28 55			
		12.88- 02.91	CA568IR	28 30			
		03.91- 08.94	CA854IR	28 35			
1722 9.6	(MK)[OM401.973]	12.88- 08.94	CA1035IR	28 80	12.88- 08.94	CS191	24 5.4
		12.88- 08.94	CA333IR	28 55			
		12.88- 02.91	CA568IR	28 30			
		03.91- 08.94	CA854IR	28 35			
	[OM401.978]	12.88- 08.94	CA1035IR	28 80	12.88- 08.94	CS191	24 5.4
		12.88- 08.94	CA333IR	28 55			
		12.88- 02.91	CA568IR	28 30			
		03.91- 08.94	CA854IR	28 35			
	[OM401.979]	12.88- 08.94	CA1035IR	28 80	12.88- 08.94	CS191	24 5.4
		12.88- 08.94	CA333IR	28 55			
		12.88- 02.91	CA568IR	28 30			
		03.91- 08.94	CA854IR	28 35			
1724 6.0	(LK/LN2)[OM366.999]	01.84- 10.86	CA187IR	28 27	02.92- 12.98	CS1279	24 4.0
		11.86- 12.98	CA1035IR	28 80			
		11.86- 12.98	CA333IR	28 55			
		11.86- 02.91	CA568IR	28 30			
		03.91- 12.98	CA854IR	28 35			
1726 11.0	(MK)[OM441.960]	12.88- 08.94	CA1035IR	28 80	12.88- 08.94	CS191	24 5.4
		12.88- 08.94	CA333IR	28 55			
		12.88- 02.91	CA568IR	28 30			
		03.91- 08.94	CA854IR	28 35			
1726 15.1	(MK)[OM440.909]	12.88- 08.94	CA1035IR	28 80	12.88- 08.94	CS191	24 5.4
		12.88- 08.94	CA333IR	28 55			
		12.88- 02.91	CA568IR	28 30			
		03.91- 08.94	CA854IR	28 35			
	[OM442.906]	12.88- 08.94	CA1035IR	28 80	12.88- 08.94	CS191	24 5.4
		12.88- 08.94	CA333IR	28 55			
		12.88- 02.91	CA568IR	28 30			
		03.91- 08.94	CA854IR	28 35			
	[OM442.907]	12.88- 08.94	CA1035IR	28 80	12.88- 08.94	CS191	24 5.4
		12.88- 08.94	CA333IR	28 55			
		12.88- 02.91	CA568IR	28 30			
		03.91- 08.94	CA854IR	28 35			
	[OM442.909]	12.88- 08.94	CA1035IR	28 80	12.88- 08.94	CS191	24 5.4
		12.88- 08.94	CA333IR	28 55			
		12.88- 02.91	CA568IR	28 30			
		03.91- 08.94	CA854IR	28 35			
	[OM442.914]	12.88- 08.94	CA1035IR	28 80	12.88- 08.94	CS191	24 5.4
		12.88- 08.94	CA333IR	28 55			
		12.88- 02.91	CA568IR	28 30			
		03.91- 08.94	CA854IR	28 35			
	[OM442.922]	12.88- 08.94	CA1035IR	28 80	12.88- 08.94	CS191	24 5.4
		12.88- 08.94	CA333IR	28 55			
		12.88- 02.91	CA568IR	28 30			
		03.91- 08.94	CA854IR	28 35			
[OM442.923]	12.88- 08.94	CA1035IR	28 80	12.88- 08.94	CS191	24 5.4	
	12.88- 08.94	CA333IR	28 55				
	12.88- 02.91	CA568IR	28 30				
	03.91- 08.94	CA854IR	28 35				
[OM442.932]	12.88- 08.94	CA1035IR	28 80	12.88- 08.94	CS191	24 5.4	
	12.88- 08.94	CA333IR	28 55				
	12.88- 02.91	CA568IR	28 30				
	03.91- 08.94	CA854IR	28 35				
[OM442.935]	06.89- 08.94	CA1035IR	28 80	06.89- 08.94	CS191	24 5.4	
	06.89- 08.94	CA333IR	28 55				
	06.89- 02.91	CA568IR	28 30				
	03.91- 08.94	CA854IR	28 35				
1726 9.6	(MK)[OM401.973]	12.87- 09.96	CA568IR	28 30	12.87- 09.96	CS191	24 5.4
		12.87- 09.96	CA854IR	28 35			
	[OM401.978]	12.87- 09.96	CA568IR	28 30	12.87- 09.96	CS191	24 5.4
		12.87- 09.96	CA854IR	28 35			
1727 9.6	(MK)[OM401.973]	12.88- 08.94	CA1035IR	28 80	12.88- 08.94	CS191	24 5.4
		12.88- 08.94	CA333IR	28 55			
		12.88- 02.91	CA568IR	28 30			
		03.91- 08.94	CA854IR	28 35			
	[OM401.978]	12.88- 08.94	CA1035IR	28 80	12.88- 08.94	CS191	24 5.4
		12.88- 08.94	CA333IR	28 55			
		12.88- 02.91	CA568IR	28 30			
		03.91- 08.94	CA854IR	28 35			
1728 15.1	(SK)[OM442.906]	07.88- 08.94	CA1035IR	28 80	07.88- 08.94	CS191	24 5.4
		07.88- 08.94	CA333IR	28 55			
		07.88- 02.91	CA568IR	28 30			
		02.91- 08.94	CA854IR	28 35			
	[OM442.907]	07.88- 08.94	CA1035IR	28 80	07.88- 08.94	CS191	24 5.4
		07.88- 08.94	CA333IR	28 55			
		07.88- 02.91	CA568IR	28 30			
		02.91- 08.94	CA854IR	28 35			
	[OM442.908]	07.88- 08.94	CA1035IR	28 80	07.88- 08.94	CS191	24 5.4
		07.88- 08.94	CA333IR	28 55			
		07.88- 02.91	CA568IR	28 30			
		02.91- 08.94	CA854IR	28 35			
	[OM442.923]	07.88- 08.94	CA1035IR	28 80	07.88- 08.94	CS191	24 5.4
		07.88- 08.94	CA333IR	28 55			
		07.88- 02.91	CA568IR	28 30			
		02.91- 08.94	CA854IR	28 35			
[OM442.925]	07.88- 08.94	CA1035IR	28 80	07.88- 08.94	CS191	24 5.4	
	07.88- 08.94	CA333IR	28 55				
	07.88- 02.91	CA568IR	28 30				
	02.91- 08.94	CA854IR	28 35				
1729 15.1	(MK)[OM442.906]	12.87- 08.94	CA1035IR	28 80	12.87- 08.94	CS191	24 5.4
		12.87- 08.94	CA333IR	28 55			
		12.87- 08.94	CA854IR	28 35			
		12.87- 09.96	CA1035IR	28 80			
	[OM442.907]	12.87- 09.96	CA333IR	28 55	12.87- 09.96	CS191	24 5.4
		12.87- 09.96	CA854IR	28 35			
	[OM442.923]	12.87- 08.94	CA854IR	28 35	12.87- 08.94	CS191	24 5.4
		12.87- 08.94	CA854IR	28 35			





MERCEDES-BENZ Continued

	[OM442.964]	07.88- 08.94 CA1035IR 28 80 07.88- 08.94 CA333IR 28 55 07.88- 02.91 CA568IR 28 30 03.91- 08.94 CA854IR 28 35		07.88- 08.94 CS191	24 5.4
	[OM442.966]	08.89- 08.94 CA1035IR 28 80 08.89- 08.94 CA333IR 28 55 08.89- 02.91 CA568IR 28 30 03.91- 08.94 CA854IR 28 35		08.89- 08.94 CS191	24 5.4
	[OM442.976]	07.88- 08.94 CA1035IR 28 80 07.88- 08.94 CA333IR 28 55 07.88- 02.91 CA568IR 28 30 03.91- 08.94 CA854IR 28 35		07.88- 08.94 CS191	24 5.4
1748 14.7	(SK)[OM442.985]	07.88- 07.92 CA1035IR 28 80 07.88- 07.92 CA333IR 28 55 07.88- 02.91 CA568IR 28 30 03.91- 07.92 CA854IR 28 35		07.88- 07.92 CS191	24 5.4
	[OM442.989]	07.88- 07.92 CA1035IR 28 80 07.88- 07.92 CA333IR 28 55 07.88- 02.91 CA568IR 28 30 03.91- 07.92 CA854IR 28 35		07.88- 07.92 CS191	24 5.4
1820 6.0	(MK)[OM356.984]	01.91- 02.01 CA1035IR 28 80 01.91- 02.01 CA333IR 28 55 01.91- 02.91 CA568IR 28 30 03.91- 02.01 CA854IR 28 35		01.91- 02.01 CS120 01.91- 02.01 CS1279	24 4.0 24 4.0
	[OM356.987]	01.91- 02.91 CA568IR 28 30 05.92- 09.96 CA1035IR 28 80 05.92- 09.96 CA333IR 28 55 05.92- 09.96 CA854IR 28 35		05.92- 09.96 CS120 05.92- 09.96 CS1279	24 4.0 24 4.0
	[OM357.925]	01.91- 02.91 CA568IR 28 30 05.92- 09.96 CA1035IR 28 80 05.92- 09.96 CA333IR 28 55 01.94- 09.96 CA854IR 28 35		01.94- 09.96 CS1279 05.92- 09.96 CS120	24 4.0 24 4.0
1823 6.4	(Atego)[OM906.920]	01.98- 09.04 CA1505IR 28 100 01.98- 09.04 CA1593IR 28 80 01.98- 09.04 CA1666IR 28 80 01.98- 09.04 CA1739IR 28 100		01.98- 09.04 CS1112 01.98- 09.04 CS1381	24 4.0 BO 24 4.0 DR
	[OM906.922]	05.98- 09.04 CA1505IR 28 100 05.98- 09.04 CA1593IR 28 80		05.98- 09.04 CS1112 05.98- 09.04 CS1381	24 4.0 BO 24 4.0 DR
	(Axor)[OM906.920]	01.02- 10.04 CA1505IR 28 100 01.02- 10.04 CA1593IR 28 80 01.02- 10.04 CA1666IR 28 80 01.02- 10.04 CA1739IR 28 100		01.02- 10.04 CS1112	24 4.0
	(Axor 2)[OM906.920] (Econic)[OM906.940]	03.98- 03.01 CA1505IR 28 100 03.98- 03.01 CA1593IR 28 80 03.98- CA1666IR 28 80 03.98- CA1739IR 28 100		10.04- CS1112 03.98- 03.01 CS1112 03.98- 03.01 CS1381	24 4.0 24 4.0 BO 24 4.0 DR
1824 11.0	(MK)[OM445.924]	01.94- 09.96 CA1035IR 28 80 01.94- 09.96 CA333IR 28 55		01.94- 09.96 CS191	24 5.4
	[OM445.925]	01.94- 09.96 CA1035IR 28 80 01.94- 09.96 CA333IR 28 55		01.94- 09.96 CS191	24 5.4
	[OM445.926]	01.94- CA1035IR 28 80 01.94- CA333IR 28 55		01.94- CS191	24 5.4
	[OM445.930]	01.94- 09.96 CA1035IR 28 80 01.94- 09.96 CA333IR 28 55		01.94- 09.96 CS191	24 5.4
	[OM445.933]	01.94- CA1035IR 28 80 01.94- CA333IR 28 55		01.94- CS191	24 5.4
	[OM445.938]	01.94- 09.96 CA1035IR 28 80 01.94- 09.96 CA333IR 28 55		01.94- 09.96 CS191	24 5.4
1824 15.1	(MK)[OM442.907]	12.88- 08.94 CA1035IR 28 80 12.88- 08.94 CA333IR 28 55 12.88- 08.94 CA854IR 28 35		12.88- 08.94 CS198 12.88- 08.94 CS198	24 6.0 24 5.4
1824 6.0	(MK)[OM356.999]	08.92- 09.96 CA1035IR 28 80 08.92- 09.96 CA333IR 28 55 08.92- 09.96 CA854IR 28 35		08.92- 09.96 CS1279 08.92- 09.96 CS120	24 4.0 24 4.0
1824 6.4	(Axor)[OM902.913]	09.06- CA1666IR 28 80 09.06- CA1739IR 28 100		09.06- CS1112	24 4.0
	(Axor 2)[OM902.913]			10.04- CS1112	24 4.0
1824 9.6	(MK)[OM401.975]	08.92- 09.96 CA1035IR 28 80 08.92- 09.96 CA333IR 28 55 08.92- 09.96 CA854IR 28 35		08.92- 09.96 CS191	24 5.4
	[OM401.984]	08.92- 09.96 CA1035IR 28 80 08.92- 09.96 CA333IR 28 55 08.92- 09.96 CA854IR 28 35		08.92- 09.96 CS191	24 5.4
	[OM445.924]	01.94- 09.96 CA1035IR 28 80 01.94- 09.96 CA333IR 28 55 01.94- 09.96 CA854IR 28 35		01.94- 09.96 CS191	24 5.4
	[OM445.938]	01.94- 09.96 CA1035IR 28 80 01.94- 09.96 CA333IR 28 55 01.94- 09.96 CA568IR 28 30		08.92- 09.96 CS191	24 5.4
	[OM445.941]	01.94- 09.96 CA1035IR 28 80 01.94- 09.96 CA333IR 28 55 01.94- 09.96 CA854IR 28 35		08.92- 09.96 CS191	24 5.4
1826 6.4	(Axor)[OM902.914]	09.06- CA1666IR 28 80 09.06- CA1739IR 28 100		09.06- CS1112	24 4.0
1827 11.0	(MK)[OM445.926]	01.94- 09.96 CA1035IR 28 80 01.94- 09.96 CA333IR 28 55		01.94- 09.96 CS191	24 5.4
	[OM445.933]	08.92- 09.96 CA1035IR 28 80			
	[OM445.936]	01.94- 09.96 CA1035IR 28 80 01.94- 09.96 CA333IR 28 55		01.94- 09.96 CS191	24 5.4
1827 9.6	(MK)[OM401.973]	12.90- 02.01 CA1035IR 28 80 12.90- 02.01 CA333IR 28 55 12.90- 02.91 CA568IR 28 30 02.91- 02.01 CA854IR 28 35		12.90- 02.01 CS191	24 5.4
	[OM401.977]	12.90- 02.01 CA1035IR 28 80 12.90- 02.01 CA333IR 28 55 12.90- 02.91 CA568IR 28 30 03.91- 02.01 CA854IR 28 35		12.90- 02.01 CS191	24 5.4
	[OM401.989]	08.92- 09.96 CA1035IR 28 80 08.92- 09.96 CA333IR 28 55 08.92- 09.96 CA854IR 28 35		08.92- 09.96 CS191	24 5.4
	[OM401.991]	12.90- 02.01 CA1035IR 28 80 12.90- 02.01 CA333IR 28 55 12.90- 02.91 CA568IR 28 30 02.91- 02.01 CA854IR 28 35		12.90- 02.01 CS191	24 5.4
1828 6.4	(Atego)[OM906.921]	05.98- 09.04 CA1505IR 28 100 05.98- 09.04 CA1593IR 28 80 05.98- 09.04 CA1666IR 28 80 05.98- 09.04 CA1739IR 28 100		05.98- 09.04 CS1112 05.98- 09.04 CS1381	24 4.0 BO 24 4.0 DR
	[OM906.923]	05.98- 09.04 CA1505IR 28 100 05.98- 09.04 CA1593IR 28 80		05.98- 09.04 CS1381 05.98- 09.04 CS1112	24 4.0 DR 24 4.0 BO
	(Axor)[OM902.915]	10.04- CA1666IR 28 80		10.04- CS1112	24 4.0





		10.04-	CA1739IR	28 100				
	[OM902.932]	10.04-	CA1666IR	28 80	10.04-	CS1112	24 4.0	
		10.04-	CA1739IR	28 100				
	[OM906.921]	01.02- 08.06	CA1505IR	28 100	01.02- 08.06	CS1112	24 4.0	
		01.02- 08.06	CA1593IR	28 80				
		01.02- 08.06	CA1666IR	28 80				
		01.02- 08.06	CA1739IR	28 100				
	[OM906.923]	10.04-	CA1666IR	28 80	10.04-	CS1112	24 4.0	
		10.04-	CA1739IR	28 100				
	[OM906.926]	10.04-	CA1666IR	28 80	10.04-	CS1112	24 4.0	
		10.04-	CA1739IR	28 100				
	[OM906.928]	10.04-	CA1666IR	28 80	10.04-	CS1112	24 4.0	
		10.04-	CA1739IR	28 100				
	(Econic)[OM906.941]	03.98- 03.01	CA1505IR	28 100	03.98- 03.01	CS1381	24 4.0 DR	
		03.98- 03.01	CA1593IR	28 80		CS1112	24 4.0 BO	
		03.98-	CA1666IR	28 80				
1828 6.9	(Econic)[M906.900]	10.00-	CA1505IR	28 100	10.00-	CS1112	24 4.0	
		10.00-	CA1593IR	28 80				
1828 7.2	(Econic)[M902.900]					CS1112	24 4.0	
	[M902.903]					CS1112	24 4.0	
1829 6.4	(Axor)[OM902.915]	10.04-	CA1666IR	28 80	10.04-	CS1112	24 4.0	
		10.04-	CA1739IR	28 100				
	[OM902.932]	10.04-	CA1666IR	28 80	10.04-	CS1112	24 4.0	
		10.04-	CA1739IR	28 100				
	[OM906.921]	01.02- 08.06	CA1505IR	28 100	01.02- 08.06	CS1112	24 4.0	
		01.02- 08.06	CA1593IR	28 80				
		01.02- 08.06	CA1666IR	28 80				
		01.02- 08.06	CA1739IR	28 100				
	[OM906.923]	10.04-	CA1666IR	28 80	10.04-	CS1112	24 4.0	
		10.04-	CA1739IR	28 100				
	[OM906.926]	10.04-	CA1666IR	28 80	10.04-	CS1112	24 4.0	
		10.04-	CA1739IR	28 100				
	[OM906.928]	10.04-	CA1666IR	28 80	10.04-	CS1112	24 4.0	
		10.04-	CA1739IR	28 100				
	(Axor 2)[OM902.915]				10.04-	CS1112	24 4.0	
1831 11.0	(MK)[OM445.929]	01.94- 09.96	CA1035IR	28 80	01.94- 09.96	CS191	24 5.4	
		01.94- 09.96	CA333IR	28 55				
	[OM445.937]	01.94- 09.96	CA1035IR	28 80	01.94- 09.96	CS191	24 5.4	
		01.94- 09.96	CA333IR	28 55				
	(SK)[OM441.986]	07.92- 09.96	CA1035IR	28 80	07.92- 09.96	CS191	24 5.4	
		07.92- 09.96	CA333IR	28 55				
		07.92- 09.96	CA854IR	28 35				
	[OM441.993]	07.92- 09.96	CA1035IR	28 80	07.92- 09.96	CS191	24 5.4	
		07.92- 09.96	CA333IR	28 55				
		07.92- 09.96	CA854IR	28 35				
	[OM445.929]	01.94- 09.96	CA1035IR	28 80	01.94- 09.96	CS191	24 5.4	
		01.94- 09.96	CA333IR	28 55				
	[OM445.930]	01.94- 09.96	CA1035IR	28 80	01.94- 09.96	CS191	24 5.4	
		01.94- 09.96	CA333IR	28 55				
	[OM445.937]	01.94- 09.96	CA1035IR	28 80	01.94- 09.96	CS191	24 5.4	
		01.94- 09.96	CA333IR	28 55				
1831 11.9	(Actros)[OM541.920]	04.96- 10.02	CA1505IR	28 100	04.96- 10.02	CS1463	24 6.2 MI	
		04.96- 10.02	CA1593IR	28 80	04.96- 10.02	CS1077	24 6.2	
		04.96- 10.02	CA1666IR	28 80	AC 04.96- 10.02	CS1168#	24 7.8	
		04.96- 10.02	CA1739IR	28 100	04.96- 10.02	CS1269	24 6.2 BO	
	[OM541.926]	04.97- 10.02	CA1505IR	28 100	04.97- 10.02	CS1269	24 6.2 BO	
		04.97- 10.02	CA1593IR	28 80	04.97- 10.02	CS1077	24 6.2	
		04.97- 10.02	CA1666IR	28 80	AC 04.97- 10.02	CS1168#	24 7.8	
		04.97- 10.02	CA1739IR	28 100	04.97- 10.02	CS1463	24 6.2 MI	
1831 12.8	(MK)[OM402.987]	12.88- 08.94	CA1035IR	28 80	12.88- 08.94	CS191	24 5.4	
		12.88- 08.94	CA333IR	28 55				
		12.88- 08.94	CA854IR	28 35				
1831 9.6	(MK)[OM401.972]	12.90- 02.01	CA1035IR	28 80	12.90- 02.01	CS191	24 5.4	
		12.90- 02.01	CA333IR	28 55				
		12.90- 02.91	CA568IR	28 30				
		03.91- 02.01	CA854IR	28 35				
	[OM401.979]	12.88- 02.01	CA1035IR	28 80	12.88- 02.01	CS191	24 5.4	
		12.88- 02.01	CA333IR	28 55				
		12.88- 02.01	CA854IR	28 35				
		12.90- 02.91	CA568IR	28 30				
	[OM401.993]	12.90- 02.01	CA1035IR	28 80	12.90- 02.01	CS191	24 5.4	
		12.90- 02.01	CA333IR	28 55				
		12.90- 02.91	CA568IR	28 30				
		03.91- 02.01	CA854IR	28 35				
	(SK)[OM401.972]	02.91- 02.01	CA1035IR	28 80	02.91- 02.01	CS191	24 5.4	
		02.91- 02.01	CA333IR	28 55				
		02.91- 02.01	CA854IR	28 35				
	[OM401.979]	02.91- 02.01	CA1035IR	28 80	02.91- 02.01	CS191	24 5.4	
		02.91- 02.01	CA333IR	28 55				
		02.91- 02.01	CA854IR	28 35				
	[OM401.986]	05.91- 09.96	CA1035IR	28 80	05.91- 09.96	CS191	24 5.4	
		05.91- 09.96	CA333IR	28 55				
		05.91- 09.96	CA854IR	28 35				
	[OM401.993]	02.91- 02.01	CA1035IR	28 80	02.91- 02.01	CS191	24 5.4	
		02.91- 02.01	CA333IR	28 55				
		02.91- 02.01	CA854IR	28 35				
1832 11.9	(Actros)[OM541.940]	04.03-	CA1505IR	28 100	04.03-	CS1463	24 6.2 MI	
		04.03-	CA1593IR	28 80	04.03-	CS1077	24 6.2	
		04.03-	CA1666IR	28 80	04.03-	CS1269	24 6.2 BO	
		04.03-	CA1739IR	28 100				
	[OM541.970]	04.03-	CA1505IR	28 100	04.03-	CS1463	24 6.2 MI	
		04.03-	CA1593IR	28 80	04.03-	CS1077	24 6.2	
		04.03-	CA1666IR	28 80	04.03-	CS1269	24 6.2 BO	
		04.03-	CA1739IR	28 100				
	[OM541.971]	04.03-	CA1505IR	28 100	04.03-	CS1463	24 6.2 MI	
		04.03-	CA1593IR	28 80	04.03-	CS1077	24 6.2	
		04.03-	CA1666IR	28 80	04.03-	CS1269	24 6.2 BO	
		04.03-	CA1739IR	28 100				
1833 7.2	(Axor)[OM926.913]	10.04- 08.06	CA1666IR	28 80	10.04- 08.06	CS1112	24 4.0	
		10.04- 08.06	CA1739IR	28 100				
	(Axor 2)[OM926.913]				10.04-	CS1112	24 4.0	
	(Econic)[OM926.934]				09.06-	CS1112	24 4.0	
	(Zetros)[OM926.935]	09.08-	CA1505IR	28 100	09.08-	CS1112	24 4.0	
		09.08-	CA1666IR	28 80				
		09.08-	CA1739IR	28 100				
		09.08-	CA1924IR	28 180				
	[OM926.936]	09.08-	CA1505IR	28 100	09.08-	CS1112	24 4.0	
		09.08-	CA1666IR	28 80				
		09.08-	CA1739IR	28 100				
		09.08-	CA1924IR	28 180				
1834 11.0	(MK)[OM441.986]	01.91- 02.01	CA1035IR	28 80	01.91- 02.01	CS191	24 5.4	
		01.91- 02.01	CA333IR	28 55				



**MERCEDES-BENZ** *Continued*

		01.91- 02.91	CA568IR	28 30				
		03.91- 02.01	CA854IR	28 35				
	[OM441.987]	01.91- 09.96	CA1035IR	28 80	04.91- 09.96	CS191	24 5.4	
		01.91- 09.96	CA333IR	28 55				
		01.91- 02.91	CA568IR	28 30				
		03.91- 09.96	CA854IR	28 35				
	[OM441.989]	01.91- 02.01	CA1035IR	28 80	01.91- 02.01	CS191	24 5.4	
		01.91- 02.01	CA333IR	28 55				
		01.91- 02.91	CA568IR	28 30				
		03.91- 02.01	CA854IR	28 35				
	[OM441.991]	01.91- 02.01	CA1035IR	28 80	04.91- 02.01	CS191	24 5.4	
		01.91- 02.01	CA333IR	28 55				
		01.91- 02.91	CA568IR	28 30				
		03.91- 02.01	CA854IR	28 35				
	[OM445.920]	01.91- 02.91	CA568IR	28 30	01.91- 01.01	CS191	24 5.4	
		01.94- 01.01	CA1035IR	28 80				
		01.94- 01.01	CA333IR	28 55				
		01.94- 01.01	CA854IR	28 35				
	[OM445.921]	01.91- 02.91	CA568IR	28 30	01.94-	CS191	24 5.4	
		01.94-	CA1035IR	28 80				
		01.94-	CA333IR	28 55				
		03.94-	CA854IR	28 35				
	[OM445.939]	01.91- 02.91	CA568IR	28 30	01.94- 01.01	CS191	24 5.4	
		01.94- 01.01	CA1035IR	28 80				
		01.94- 01.01	CA333IR	28 55				
		01.94- 01.01	CA854IR	28 35				
	(SK)[OM441.986]	10.93- 09.96	CA1035IR	28 80	10.93- 09.96	CS191	24 5.4	
		10.93- 09.96	CA333IR	28 55				
		10.93- 09.96	CA854IR	28 35				
	[OM441.989]	07.88- 09.93	CA1035IR	28 80	07.88- 09.93	CS191	24 5.4	
		07.88- 09.93	CA333IR	28 55				
		07.88- 09.93	CA854IR	28 35				
	[OM441.996]	10.93- 09.96	CA1035IR	28 80	10.93- 09.06	CS191	24 5.4	
		10.93- 09.96	CA333IR	28 55				
		10.93- 09.96	CA854IR	28 35				
	[OM445.920]	01.94- 09.96	CA1035IR	28 80	01.94- 09.96	CS191	24 5.4	
		01.94- 09.96	CA333IR	28 55				
		01.94- 09.96	CA854IR	28 35				
	[OM445.939]	01.94- 09.96	CA1035IR	28 80	01.94- 09.96	CS191	24 5.4	
		01.94- 09.96	CA333IR	28 55				
		01.94- 09.96	CA854IR	28 35				
1835 11.9	(Actros)[OM541.922]	04.96- 10.02	CA1505IR	28 100	04.96- 10.02	CS1269	24 6.2 BO	
		04.96- 10.02	CA1593IR	28 80	AC 04.96- 10.02	CS1168#	24 7.8	
		04.96- 10.02	CA1666IR	28 80	04.96- 10.02	CS1463	24 6.2 MI	
		04.96- 10.02	CA1739IR	28 100	04.96- 10.02	CS1077	24 6.2	
	[OM541.927]	04.97- 10.02	CA1505IR	28 100	04.97- 10.02	CS1463	24 6.2 MI	
		04.97- 10.02	CA1593IR	28 80	AC 04.97- 10.02	CS1269	24 6.2 BO	
		04.97- 10.02	CA1666IR	28 80	04.97- 10.02	CS1168#	24 7.8	
		04.97- 10.02	CA1739IR	28 100	04.97- 10.02	CS1077	24 6.2	
1835 12.0	(Axor)[OM457.937]	01.02- 10.04	CA1666IR	28 80	01.02- 10.04	CS1463	24 6.2 MI	
		01.02- 10.04	CA1739IR	28 100	01.02- 10.04	CS1269	24 6.2 BO	
1836 11.9	(Actros)[OM541.942]	04.03-	CA1505IR	28 100	04.03-	CS1269	24 6.2 BO	
		04.03-	CA1593IR	28 80	04.03-	CS1463	24 6.2 MI	
		04.03-	CA1666IR	28 80	04.03-	CS1077	24 6.2	
		04.03-	CA1739IR	28 100				
	(Actros MP2 / MP3)[OM541.943]		CA1593IR	28 80				
1836 12.0	(Axor 2)[OM457.937]	10.04-	CA1739IR	28 100				
	[OM457.948]	10.04-	CA1739IR	28 100				
	[OM457.980]	10.04-	CA1739IR	28 100				
1838 12.8	(SK)[OM402.971]	12.90- 02.01	CA1035IR	28 80	12.90- 02.01	CS191	24 5.4	
		12.90- 02.01	CA333IR	28 55				
		12.90- 02.91	CA568IR	28 30				
		03.91- 02.01	CA854IR	28 35				
	[OM402.972]	12.90- 02.01	CA1035IR	28 80	12.90- 02.01	CS191	24 5.4	
		12.90- 02.01	CA333IR	28 55				
		12.90- 02.91	CA568IR	28 30				
		03.91- 02.01	CA854IR	28 35				
	[OM402.975]	12.90- 02.01	CA1035IR	28 80	12.90- 02.01	CS191	24 5.4	
		12.90- 02.01	CA333IR	28 55				
		12.90- 02.91	CA568IR	28 30				
		03.91- 02.01	CA854IR	28 35				
	[OM402.978]	12.92- 02.01	CA1035IR	28 80	12.92- 02.01	CS191	24 5.4	
		12.92- 02.01	CA333IR	28 55				
		12.92- 02.01	CA854IR	28 35				
	[OM402.985]	12.90- 02.01	CA1035IR	28 80	12.90- 02.01	CS191	24 5.4	
		12.90- 02.01	CA333IR	28 55				
		12.90- 02.91	CA568IR	28 30				
		03.91- 02.01	CA854IR	28 35				
	[OM402.986]	12.90- 02.01	CA1035IR	28 80	12.90- 02.01	CS191	24 5.4	
		12.90- 02.01	CA333IR	28 55				
		12.90- 02.91	CA568IR	28 30				
		03.91- 02.01	CA854IR	28 35				
	[OM402.996]	12.92- 09.96	CA1035IR	28 80	12.92- 09.96	CS191	24 5.4	
		12.92- 09.96	CA333IR	28 55				
		12.92- 09.96	CA854IR	28 35				
1838 14.6	(SK)[OM440.978]	12.90- 02.01	CA854IR	28 35	12.90- 02.01	CS191	24 5.4	
	[OM440.979]	12.92- 09.96	CA854IR	28 35	12.92- 09.96	CS191	24 5.4	
	[OM440.982]	12.92- 09.96	CA854IR	28 35	12.92- 09.96	CS191	24 5.4	
	[OM440.991]	12.90- 02.01	CA854IR	28 35	12.90- 02.01	CS191	24 5.4	
	[OM446.924]	06.95- 09.96	CA1035IR	28 80	06.95- 09.96	CS191	24 5.4	
		06.95- 09.96	CA333IR	28 55				
	[OM446.925]	06.95- 09.96	CA1035IR	28 80	06.95- 09.96	CS191	24 5.4	
		06.95- 09.96	CA333IR	28 55				
	[OM446.927]	01.94- 09.96	CA1035IR	28 80	01.94- 09.96	CS191	24 5.4	
	[OM446.943]	12.90- 02.01	CA854IR	28 35	12.90- 02.01	CS191	24 5.4	
1840 11.9	(Actros)[OM541.923]	04.96- 10.02	CA1505IR	28 100	04.96- 10.02	CS1077	24 6.2	
		04.96- 10.02	CA1593IR	28 80	AC 04.96- 10.02	CS1463	24 6.2 MI	
		04.96- 10.02	CA1666IR	28 80	04.96- 10.02	CS1168#	24 7.8	
		04.96- 10.02	CA1739IR	28 100	04.96- 10.02	CS1269	24 6.2 BO	
	[OM541.924]	04.97- 10.02	CA1505IR	28 100	04.97- 10.02	CS1269	24 6.2 BO	
		04.97- 10.02	CA1593IR	28 80	04.97- 10.02	CS1077	24 6.2	
		04.97- 10.02	CA1666IR	28 80	AC 04.97- 10.02	CS1463	24 6.2 MI	
		04.97- 10.02	CA1739IR	28 100	04.97- 10.02	CS1168#	24 7.8	
1840 12.0	(Axor)[OM457.937]	01.02- 10.04	CA1666IR	28 80	01.02- 10.04	CS1269	24 6.2 BO	
		01.02- 10.04	CA1739IR	28 100	01.02- 10.04	CS1463	24 6.2 MI	
	(Axor 2)[OM457.937]	10.04-	CA1739IR	28 100				
	[OM457.948]	10.04-	CA1739IR	28 100				
	[OM457.955]	10.04-	CA1739IR	28 100				
	[OM457.980]	10.04-	CA1739IR	28 100				
1840 12.8	(SK)[OM402.971]	07.91- 07.92	CA1035IR	28 80	07.91- 07.92	CS191	24 5.4	
		07.91- 07.92	CA333IR	28 55				
		07.91- 07.92	CA854IR	28 35				



1841 11.9	(Actros)[OM541.944]	04.03-	CA1505IR	28 100	04.03-	CS1077	24 6.2	
		04.03-	CA1593IR	28 80	04.03-	CS1269	24 6.2 BO	
		04.03-	CA1666IR	28 80	04.03-	CS1463	24 6.2 MI	
		04.03-	CA1739IR	28 100				
	[OM541.974]	04.03-	CA1505IR	28 100	04.03-	CS1463	24 6.2 MI	
	04.03-	CA1593IR	28 80	04.03-	CS1077	24 6.2		
	04.03-	CA1666IR	28 80	04.03-	CS1269	24 6.2 BO		
	04.03-	CA1739IR	28 100					
	(Actros MP2 / MP3)[OM541.991]	04.03-	CA1739IR	28 100				
	1841 12.0	(Actros)[OM541.944]	02.05-	CA1666IR	28 80	02.05-	CS1269	24 6.2 BO
02.05-			CA1739IR	28 100	02.05-	CS1463	24 6.2 MI	
[OM541.974]		02.05-	CA1666IR	28 80	02.05-	CS1269	24 6.2 BO	
02.05-		CA1739IR	28 100	02.05-	CS1463	24 6.2 MI		
1843 11.9	(Actros)[OM541.921]	04.97- 10.02	CA1505IR	28 100	04.97- 10.02	CS1463	24 6.2 MI	
		04.97- 10.02	CA1593IR	28 80	AC 04.97- 10.02	CS1168#	24 7.8	
		04.97- 10.02	CA1666IR	28 80	04.97- 10.02	CS1269	24 6.2 BO	
		04.97- 10.02	CA1739IR	28 100	04.97- 10.02	CS1077	24 6.2	
	[OM541.925]	04.96- 10.02	CA1505IR	28 100	04.96- 10.02	CS1463	24 6.2 MI	
	04.96- 10.02	CA1593IR	28 80	AC 04.96- 10.02	CS1168#	24 7.8		
	04.96- 10.02	CA1666IR	28 80	04.96- 10.02	CS1077	24 6.2		
	04.96- 10.02	CA1739IR	28 100	04.96- 10.02	CS1269	24 6.2 BO		
	1843 12.0	(Axor)[OM457.937]	01.02- 10.04	CA1666IR	28 80	01.02-	CS1269	24 6.2 BO
			01.02- 10.04	CA1739IR	28 100	01.02-	CS1463	24 6.2 MI
(Axor 2)[OM457.937]		10.04-	CA1739IR	28 100				
[OM457.948]		10.04-	CA1739IR	28 100				
[OM457.980]	10.04-	CA1739IR	28 100					
1844 11.9	(Actros)[OM541.921]	04.03-	CA1505IR	28 100	04.03-	CS1463	24 6.2 MI	
		04.03-	CA1593IR	28 80	04.03-	CS1077	24 6.2	
		04.03-	CA1666IR	28 80	04.03-	CS1269	24 6.2 BO	
		04.03-	CA1739IR	28 100				
	[OM541.946]	04.03-	CA1505IR	28 100	04.03-	CS1463	24 6.2 MI	
	04.03-	CA1593IR	28 80	04.03-	CS1077	24 6.2		
	04.03-	CA1666IR	28 80	04.03-	CS1269	24 6.2 BO		
	04.03-	CA1739IR	28 100					
	[OM541.976]	04.03-	CA1505IR	28 100	04.03-	CS1463	24 6.2 MI	
	04.03-	CA1593IR	28 80	04.03-	CS1077	24 6.2		
04.03-	CA1666IR	28 80	04.03-	CS1269	24 6.2 BO			
04.03-	CA1739IR	28 100						
1844 12.0	(Actros)[OM541.946]	04.03-	CA1666IR	28 80	04.03-	CS1463	24 6.2 MI	
		04.03-	CA1739IR	28 100	04.03-	CS1269	24 6.2 BO	
[OM541.976]	04.03-	CA1666IR	28 80	04.03-	CS1463	24 6.2 MI		
04.03-	CA1739IR	28 100	04.03-	CS1269	24 6.2 BO			
1844 14.6	(SK)[OM440.970]	11.91- 09.96	CA1035IR	28 80	11.91- 09.96	CS191	24 5.4	
		11.91- 09.96	CA333IR	28 55				
		11.91- 09.96	CA854IR	28 35				
	[OM446.922]	01.94- 09.96	CA1035IR	28 80	11.91- 09.96	CS191	24 5.4	
	01.94- 09.96	CA333IR	28 55					
01.94- 09.96	CA854IR	28 35						
1846 11.9	(Actros)[OM541.948]	04.03-	CA1593IR	28 80	04.03-	CS1269	24 6.2 BO	
		04.03-	CA1666IR	28 80	04.03-	CS1463	24 6.2 MI	
		04.03-	CA1739IR	28 100				
		04.03-	CA1593IR	28 80	04.03-	CS1269	24 6.2 BO	
	[OM541.980]	04.03-	CA1666IR	28 80	04.03-	CS1463	24 6.2 MI	
	04.03-	CA1739IR	28 100					
	[OM541.981]	04.03-	CA1593IR	28 80	04.03-	CS1463	24 6.2 MI	
	04.03-	CA1666IR	28 80	04.03-	CS1269	24 6.2 BO		
	04.03-	CA1739IR	28 100					
	1846 12.0	(Actros)[OM541.948]	04.03-	CA1666IR	28 80	04.03-	CS1463	24 6.2 MI
04.03-	CA1739IR	28 100	04.03-	CS1269	24 6.2 BO			
1848 11.9	(Actros)[OM541.948]	04.03-	CA1593IR	28 80	04.03-	CS1269	24 6.2 BO	
		04.03-	CA1666IR	28 80	04.03-	CS1463	24 6.2 MI	
		04.03-	CA1739IR	28 100				
1848 12.0	(Actros)[OM541.948]	04.03-	CA1666IR	28 80	04.03-	CS1463	24 6.2 MI	
		04.03-	CA1739IR	28 100	04.03-	CS1269	24 6.2 BO	
1848 15.9	(Actros)[OM542.921]	04.03-	CA1035IR	28 80	04.96- 10.02	CS1269	24 6.2 BO	
		04.96- 10.02	CA1505IR	28 100	04.96- 10.02	CS1463	24 6.2 MI	
		04.96- 10.02	CA1593IR	28 80	AC 04.96- 10.02	CS1168#	24 7.8	
		04.96- 10.02	CA1666IR	28 80	04.96- 10.02	CS1077	24 6.2	
		04.96- 10.02	CA1739IR	28 100				
[OM542.925]	04.97- 10.02	CA1505IR	28 100	04.97- 10.02	CS1077	24 6.2		
04.97- 10.02	CA1593IR	28 80	AC 04.97- 10.02	CS1168#	24 7.8			
04.97- 10.02	CA1666IR	28 80	04.97- 10.02	CS1269	24 6.2 BO			
04.97- 10.02	CA1739IR	28 100	04.97- 10.02	CS1463	24 6.2 MI			
1850 14.6	(SK)[OM440.973]	07.87- 09.96	CA1224IR#	28 120	07.87- 02.01	CS191	24 5.4	
		07.87- 09.96	CA1236IR	28 140				
		12.90- 02.01	CA1035IR	28 80				
		12.90- 02.01	CA333IR	28 55				
		12.90- 02.91	CA568IR	28 30				
		03.91- 02.01	CA854IR	28 35				
		[OM442.971]	12.90- 02.01	CA1035IR	28 80	12.90- 02.01	CS191	24 5.4
		12.90- 02.01	CA333IR	28 55				
		12.90- 02.91	CA568IR	28 30				
		03.91- 02.01	CA854IR	28 35				
	[OM442.985]	07.87- 09.96	CA1224IR#	28 120	07.87- 02.01	CS191	24 5.4	
	07.87- 09.96	CA1236IR	28 140					
	12.90- 02.01	CA1035IR	28 80					
	12.90- 02.01	CA333IR	28 55					
	12.90- 02.91	CA568IR	28 30					
	03.91- 02.01	CA854IR	28 35					
	[OM442.989]	12.90- 02.01	CA1035IR	28 80	12.90- 02.01	CS191	24 5.4	
	12.90- 02.01	CA333IR	28 55					
	12.90- 02.91	CA568IR	28 30					
	03.91- 02.01	CA854IR	28 35					
[OM442.992]	07.87- 09.96	CA1236IR	28 140	07.87- 02.01	CS191	24 5.4		
07.87- 09.96	CA824IR	28 120						
12.90- 02.01	CA1035IR	28 80						
12.90- 02.01	CA333IR	28 55						
12.90- 02.91	CA568IR	28 30						
03.91- 02.01	CA854IR	28 35						
[OM442.997]	12.90- 02.01	CA1035IR	28 80	12.90- 02.01	CS191	24 5.4		
12.90- 02.01	CA333IR	28 55						
12.90- 02.91	CA568IR	28 30						
03.91- 02.01	CA854IR	28 35						
1850 15.9	(Actros)[OM542.940]	04.03-	CA1505IR	28 100	04.03-	CS1463	24 6.2 MI	
		04.03-	CA1593IR	28 80	04.03-	CS1269	24 6.2 BO	
		04.03-	CA1666IR	28 80	04.03-	CS1077	24 6.2	
		04.03-	CA1739IR	28 100				
1851 15.9	(Actros)[OM542.940]	04.03-	CA1505IR	28 100	04.03-	CS1077	24 6.2	
		04.03-	CA1593IR	28 80	04.03-	CS1463	24 6.2	
		04.03-	CA1666IR	28 80	04.03-	CS1269	24 6.2 BO	
		04.03-	CA1739IR	28 100				



MERCEDES-BENZ Continued

1853 14.6	(SK)[OM446.920]	01.96- 09.96	CA1035IR	28 80	01.96- 09.96	CS191	24 5.4	
		01.96- 09.96	CA333IR	28 55				
		[OM446.946]						
		01.96- 09.96	CA1035IR	28 80	01.96- 09.96	CS191	24 5.4	
		01.96- 09.96	CA333IR	28 55				
1853 15.9	(Actros)[OM542.920]	04.96- 10.02	CA1505IR	28 100	04.96- 10.02	CS1077	24 6.2	
		04.96- 10.02	CA1593IR	28 80	04.96- 10.02	CS1269	24 6.2 BO	
		04.96- 10.02	CA1666IR	28 80	AC 04.96- 10.02	CS1168#	24 7.8	
		04.96- 10.02	CA1739IR	28 100	04.96- 10.02	CS1463	24 6.2 MI	
1854 15.9	(Actros)[OM542.942]	04.03-	CA1505IR	28 100	04.03-	CS1077	24 6.2	
		04.03-	CA1593IR	28 80	04.03-	CS1463	24 6.2 MI	
		04.03-	CA1666IR	28 80	04.03-	CS1269	24 6.2 BO	
		04.03-	CA1739IR	28 100				
1855 15.9	(Actros MP2 / MP3)	06.08-	CA1739IR	28 100				
1857 15.9	(Actros)[OM542.922]	04.97- 10.02	CA1505IR	28 100	04.97- 10.02	CS1463	24 6.2 MI	
		04.97- 10.02	CA1593IR	28 80	AC 04.97- 10.02	CS1168#	24 7.8	
		04.97- 10.02	CA1666IR	28 80	04.97- 10.02	CS1077	24 6.2	
		04.97- 10.02	CA1739IR	28 100	04.97- 10.02	CS1269	24 6.2 BO	
1858 15.9	(Actros)[OM542.944]	04.03-	CA1505IR	28 100	10.02-	CS1463	24 6.2 MI	
		04.03-	CA1593IR	28 80	04.03-	CS1077	24 6.2	
		04.03-	CA1666IR	28 80	10.02-	CS1269	24 6.2 BO	
		04.03-	CA1739IR	28 100				
1860 15.9	(Actros MP2 / MP3)[OM542.964]	06.08-	CA1739IR	28 100				
1860 16.0	(Actros)[OM542.964]	05.05-	CA1666IR	28 80	05.05-	CS1463	24 6.2 MI	
		05.05-	CA1739IR	28 100	05.05-	CS1269	24 6.2 BO	
1919 9.6	(NG)[OM401.909]				03.77- 08.82	CS191	24 5.4	
					05.74- 02.77	CS198	24 6.0	
					03.77- 08.82	CS191	24 5.4	
					05.74- 02.77	CS198	24 6.0	
		[OM401.916]						
1922 10.9	(NG)[OM421.905]	10.81- 10.86	CA187IR	28 27	05.83- 03.91	CS198	24 6.0	
		11.86- 03.91	CA333IR	28 55	10.81- 03.91	CS191	24 5.4	
		11.86- 03.91	CA568IR	28 30				
		10.88- 03.91	CA1035IR	28 80				
1922 11.3	(SK)[OM441.905]	05.89- 08.94	CA1035IR	28 80	05.89- 08.94	CS191	24 5.4	
		05.89- 08.94	CA333IR	28 55				
		05.89- 02.91	CA568IR	28 30				
		03.91- 08.94	CA854IR	28 35				
			[OM441.914]					
			05.89- 08.94	CA1035IR	28 80	05.89- 08.94	CS191	24 5.4
			05.89- 08.94	CA333IR	28 55			
			05.89- 02.91	CA568IR	28 30			
			03.91- 08.94	CA854IR	28 35			
			[OM441.923]					
			05.89- 08.94	CA1035IR	28 80	05.89- 08.94	CS191	24 5.4
			05.89- 08.94	CA333IR	28 55			
		05.89- 02.91	CA568IR	28 30				
		03.91- 08.94	CA854IR	28 35				
		[OM441.926]						
		08.89- 08.94	CA1035IR	28 80	08.89- 08.94	CS191	24 5.4	
		08.89- 08.94	CA333IR	28 55				
		08.89- 02.91	CA568IR	28 30				
		03.91- 08.94	CA854IR	28 35				
1926 12.8	(NG)[OM402.906]	11.79- 12.80	CA187IR	28 27	03.77- 12.80	CS191	24 5.4	
					08.73- 02.77	CS198	24 6.0	
					08.73- 02.77	CS198	24 6.0	
					03.77- 12.80	CS191	24 5.4	
		[OM402.912]						
		11.79- 12.80	CA187IR	28 27	08.73- 02.77	CS198	24 6.0	
		[OM402.916]						
		11.79- 12.80	CA187IR	28 27	03.77- 12.80	CS191	24 5.4	
					05.74- 02.77	CS198	24 6.0	
					03.77- 12.80	CS191	24 5.4	
1926 15.1	(MK)[OM442.914]	12.87- 09.96	CA1035IR	28 80	12.87- 09.96	CS191	24 5.4	
		12.87- 09.96	CA333IR	28 55				
		12.87- 12.91	CA568IR	28 30				
		12.87- 09.96	CA854IR	28 35				
			[OM442.922]					
			12.87- 09.96	CA1035IR	28 80	12.87- 09.96	CS191	24 5.4
			12.87- 09.96	CA333IR	28 55			
			12.87- 02.91	CA568IR	28 30			
			12.87- 09.96	CA854IR	28 35			
			[OM442.932]					
			12.87- 09.96	CA1035IR	28 80	12.87- 09.96	CS191	24 5.4
			12.87- 09.96	CA333IR	28 55			
		12.87- 02.91	CA568IR	28 30				
		12.87- 09.96	CA854IR	28 35				
1928 14.6	(NG)[OM422.905]	10.86- 03.91	CA187IR	28 27	05.83- 03.91	CS198	24 6.0	
		11.86- 03.91	CA333IR	28 55	01.80- 03.91	CS191	24 5.4	
		11.86- 03.91	CA568IR	28 30				
		10.88- 03.91	CA1035IR	28 80				
1928 14.6	(NG)[OM422.905]	01.80- 10.86	CA187IR	28 27	05.83- 03.91	CS198	24 6.0	
		11.86- 03.91	CA333IR	28 55	01.80- 03.91	CS191	24 5.4	
		11.86- 03.91	CA568IR	28 30				
		10.88- 03.91	CA1035IR	28 80				
			[OM422.906]					
			01.80- 10.86	CA187IR	28 27	05.83- 03.91	CS198	24 6.0
			11.86- 03.91	CA333IR	28 55	01.80- 03.91	CS191	24 5.4
			11.86- 03.91	CA568IR	28 30			
			10.88- 03.91	CA1035IR	28 80			
			[OM422.907]					
			01.80- 10.86	CA187IR	28 27	05.83- 03.91	CS198	24 6.0
			11.86- 03.91	CA333IR	28 55	01.80- 03.91	CS191	24 5.4
		11.86- 03.91	CA568IR	28 30				
		10.88- 03.91	CA1035IR	28 80				
		[OM422.911]						
		01.80- 10.86	CA187IR	28 27	05.83- 03.91	CS198	24 6.0	
		11.86- 03.91	CA333IR	28 55	01.80- 03.91	CS191	24 5.4	
		11.86- 03.91	CA568IR	28 30				
		10.88- 03.91	CA1035IR	28 80				
		[OM422.913]						
		01.80- 10.88	CA187IR	28 27	01.80- 03.91	CS191	24 5.4	
		11.86- 03.91	CA333IR	28 55	05.83- 03.91	CS198	24 6.0	
		11.86- 03.91	CA568IR	28 30				
		10.88- 03.91	CA1035IR	28 80				
1929 15.1	(SK)[OM442.906]	07.88- 08.94	CA1035IR	28 80	07.88- 08.94	CS191	24 5.4	
		07.88- 08.94	CA333IR	28 55				
		07.88- 02.91	CA568IR	28 30				
		07.88- 08.94	CA854IR	28 35				
			[OM442.907]					
			07.88- 08.94	CA1035IR	28 80	07.88- 08.94	CS191	24 5.4
			07.88- 08.94	CA333IR	28 55			
			07.88- 02.91	CA568IR	28 30			
			07.88- 08.94	CA854IR	28 35			
			[OM442.908]					
			07.88- 08.94	CA333IR	28 55	07.88- 08.94	CS191	24 5.4
			07.88- 02.91	CA568IR	28 30			
		10.88- 08.94	CA1035IR	28 80				
		03.91- 08.94	CA854IR	28 35				
		[OM442.909]						
		07.88- 08.94	CA1035IR	28 80	07.88- 08.94	CS191	24 5.4	
		07.88- 08.94	CA333IR	28 55				
		07.88- 08.94	CA854IR	28 35				



	[OM442.916]	07.88- 08.94 07.88- 02.91 10.88- 08.94 03.91- 08.94	CA333IR 28 55 CA568IR 28 30 CA1035IR 28 80 CA854IR 28 35		07.88- 08.94	CS191	24 5.4
	[OM442.923]	07.88- 08.94 07.88- 02.91 10.88- 08.94 03.91- 08.94	CA333IR 28 55 CA568IR 28 30 CA1035IR 28 80 CA854IR 28 35		07.88- 08.94	CS191	24 5.4
	[OM442.924]	07.88- 08.94 07.88- 08.94	CA1035IR 28 80 CA854IR 28 35		07.88- 08.94	CS191	24 5.4
	[OM442.925]	07.88- 08.94 07.88- 08.94 07.88- 02.91 03.91- 08.94	CA1035IR 28 80 CA333IR 28 55 CA568IR 28 30 CA854IR 28 35		07.88- 08.94	CS191	24 5.4
	[OM442.926]	07.88- 08.94 07.88- 02.91 10.88- 08.94 03.91- 08.94	CA333IR 28 55 CA568IR 28 30 CA1035IR 28 80 CA854IR 28 35		07.88- 08.94	CS191	24 5.4
	[OM442.929]	07.88- 08.94 07.88- 02.91 10.88- 08.94 03.91- 08.94	CA333IR 28 55 CA568IR 28 30 CA1035IR 28 80 CA854IR 28 35		07.88- 08.94	CS191	24 5.4
	[OM442.971]	07.88- 09.93	CA854IR 28 35		07.88- 09.93	CS191	24 5.4
1929 18.3	(SK)[OM443.940]	07.88- 08.94	CA333IR 28 55		07.88- 08.94	CS191	24 5.4
1932 15.9	(NG)[OM403.916]	11.79- 09.83	CA187IR 28 27		08.73- 09.83	CS198	24 6.0
	[OM403.931]	11.79- 09.83	CA187IR 28 27		08.73- 09.83	CS198	24 6.0
1933 14.6	(NG)[OM422.952]	11.80- 10.86 11.86- 03.91 11.86- 03.91 10.88- 03.91	CA187IR 28 27 CA333IR 28 55 CA568IR 28 30 CA1035IR 28 80		11.80- 03.91	CS198	24 6.0
	[OM422.954]	11.80- 10.86 11.86- 03.91 11.86- 03.91 10.88- 03.91	CA187IR 28 27 CA333IR 28 55 CA568IR 28 30 CA1035IR 28 80		11.80- 03.91	CS198	24 6.0
	[OM422.956]	11.80- 10.86 11.86- 03.91 11.86- 03.91 10.88- 03.91	CA187IR 28 27 CA333IR 28 55 CA568IR 28 30 CA1035IR 28 80		11.80- 03.91	CS198	24 6.0
	[OM422.957]	11.80- 10.86 11.86- 03.91 11.86- 03.91 10.88- 03.91	CA187IR 28 27 CA333IR 28 55 CA568IR 28 30 CA1035IR 28 80		11.80- 03.91	CS198	24 6.0
	[OM422.958]	11.80- 10.86 11.86- 03.91 11.86- 03.91 10.88- 03.91	CA187IR 28 27 CA333IR 28 55 CA568IR 28 30 CA1035IR 28 80		11.80- 03.91	CS198	24 6.0
1935 14.6	(NG)[OM442.950]	02.86- 10.86 11.86- 09.89 11.86- 09.89 10.88- 09.89	CA187IR 28 27 CA333IR 28 55 CA568IR 28 30 CA1035IR 28 80		02.86- 09.89	CS191	24 5.4
	[OM442.952]	02.86- 10.86 11.86- 09.89 11.86- 09.89 10.88- 09.89	CA187IR 28 27 CA333IR 28 55 CA568IR 28 30 CA1035IR 28 80		02.86- 09.89	CS191	24 5.4
	[OM442.962]	09.87- 03.91 09.87- 03.91 10.88- 03.91	CA333IR 28 55 CA568IR 28 30 CA1035IR 28 80		09.87- 03.91	CS191	24 5.4
	(SK)[OM440.940]	05.89- 08.94 05.89- 08.94 05.89- 02.91 03.91- 08.94	CA1035IR 28 80 CA333IR 28 55 CA568IR 28 30 CA854IR 28 35		05.89- 08.94	CS191	24 5.4
	[OM442.942]	05.89- 08.94 05.89- 08.94 05.89- 02.91 03.91- 08.94	CA1035IR 28 80 CA333IR 28 55 CA568IR 28 30 CA854IR 28 35		05.89- 08.94	CS191	24 5.4
	[OM442.943]	05.89- 08.94 05.89- 08.94 05.89- 02.91 03.91- 08.94	CA1035IR 28 80 CA333IR 28 55 CA568IR 28 30 CA854IR 28 35		05.89- 08.94	CS191	24 5.4
	[OM442.944]	05.89- 08.94 05.89- 08.94 05.89- 02.91 03.91- 08.94	CA1035IR 28 80 CA333IR 28 55 CA568IR 28 30 CA854IR 28 35		05.89- 08.94	CS191	24 5.4
	[OM442.963]	05.89- 08.94 05.89- 08.94 05.89- 02.91 03.91- 08.94	CA1035IR 28 80 CA333IR 28 55 CA568IR 28 30 CA854IR 28 35		05.89- 08.94	CS191	24 5.4
	[OM442.964]	05.89- 08.94 05.89- 08.94 05.89- 02.91 03.91- 08.94	CA1035IR 28 80 CA333IR 28 55 CA568IR 28 30 CA854IR 28 35		05.89- 08.94	CS191	24 5.4
	[OM442.966]	05.89- 08.94 05.89- 08.94 05.89- 02.91 03.91- 08.94	CA1035IR 28 80 CA333IR 28 55 CA568IR 28 30 CA854IR 28 35		05.89- 08.94	CS191	24 5.4
	[OM442.971]	05.89- 08.94 05.89- 08.94 05.89- 02.91 03.91- 08.94	CA1035IR 28 80 CA333IR 28 55 CA568IR 28 30 CA854IR 28 35		05.89- 08.94	CS191	24 5.4
	[OM442.972]	05.89- 08.94 05.89- 08.94 05.89- 02.91 03.91- 08.94	CA1035IR 28 80 CA333IR 28 55 CA568IR 28 30 CA854IR 28 35		05.89- 08.94	CS191	24 5.4
	[OM442.976]	05.89- 08.94 05.89- 08.94 05.89- 02.91 03.91- 08.94	CA1035IR 28 80 CA333IR 28 55 CA568IR 28 30 CA854IR 28 35		05.89- 08.94	CS191	24 5.4
	[OM442.977]	05.89- 08.94 05.89- 08.94 05.89- 02.91 03.91- 08.94	CA1035IR 28 80 CA333IR 28 55 CA568IR 28 30 CA854IR 28 35		05.89- 08.94	CS191	24 5.4
	[OM442.978]	03.81- 08.94 05.89- 08.94 05.89- 08.94 05.89- 02.91	CA854IR 28 35 CA1035IR 28 80 CA333IR 28 55 CA568IR 28 30		05.89- 08.94	CS191	24 5.4
1936 18.3	(NG)[OM423.905]	10.81- 10.86 11.86- 03.91 11.86- 03.91 10.88- 03.91	CA187IR 28 27 CA333IR 28 55 CA568IR 28 30 CA1035IR 28 80		10.81- 03.91	CS198	24 6.0
	[OM423.906]	10.81- 10.86 11.86- 03.91 11.86- 03.91 11.86- 03.91	CA187IR 28 27 CA333IR 28 55 CA568IR 28 30		10.81- 03.91	CS198	24 6.0



MERCEDES-BENZ Continued

		10.88- 03.91	CA1035IR	28 80			
	[OM423.907]	10.81- 10.86	CA187IR	28 27	10.81- 03.91	CS198	24 6.0
		11.86- 03.91	CA333IR	28 55			
		11.86- 03.91	CA568IR	28 30			
		10.88- 03.91	CA1035IR	28 80			
	[OM423.908]	10.81- 10.86	CA187IR	28 27	10.81- 03.91	CS198	24 6.0
		06.85-	CA854IR	28 35			
		11.86- 03.91	CA333IR	28 55			
		11.86- 03.91	CA568IR	28 30			
		10.88- 03.91	CA1035IR	28 80			
1938 14.6	(NG)[OM422.953]	11.80- 10.86	CA187IR	28 27	11.80- 06.90	CS198	24 6.0
		11.86- 06.90	CA333IR	28 55			
		11.86- 06.90	CA568IR	28 30			
		10.88- 06.90	CA1035IR	28 80			
	[OM422.955]	11.80- 10.86	CA187IR	28 27	11.80- 06.90	CS198	24 6.0
		11.86- 06.90	CA333IR	28 55			
		11.86- 06.90	CA568IR	28 30			
		10.88- 06.90	CA1035IR	28 80			
	[OM422.959]	11.80- 10.86	CA187IR	28 27	11.80- 06.90	CS198	24 6.0
		11.86- 06.90	CA333IR	28 55			
		11.86- 06.90	CA568IR	28 30			
		10.88- 06.90	CA1035IR	28 80			
1944 14.6	(NG)[OM442.951]	10.85- 10.86	CA187IR	28 27	10.85- 12.89	CS191	24 5.4
		11.86- 12.89	CA333IR	28 55			
		11.86- 12.89	CA568IR	28 30			
		10.88- 12.89	CA1035IR	28 80			
1945 18.3	(SK)[OM443.940]	07.88- 08.94	CA1035IR	28 80	07.88- 08.94	CS198	24 6.0
		07.88- 08.94	CA333IR	28 55			
1948 14.6	(SK)[OM442.982]	09.88- 07.92	CA333IR	28 55	09.88- 07.92	CS191	24 5.4
		09.88- 02.91	CA568IR	28 30			
		10.88- 07.92	CA1035IR	28 80			
		03.91- 07.92	CA854IR	28 35			
	[OM442.984]	09.88- 07.92	CA333IR	28 55	09.88- 07.92	CS191	24 5.4
		09.88- 02.91	CA568IR	28 30			
		10.88- 07.92	CA1035IR	28 80			
		03.91- 07.92	CA854IR	28 35			
	[OM442.985]	09.88- 07.92	CA333IR	28 55	09.88- 07.92	CS191	24 5.4
		09.88- 02.91	CA568IR	28 30			
		10.88- 07.92	CA1035IR	28 80			
		03.91- 07.92	CA854IR	28 35			
	[OM442.989]	09.88- 07.92	CA333IR	28 55	09.88- 07.92	CS191	24 5.4
		09.88- 02.91	CA568IR	28 30			
		10.88- 07.92	CA1035IR	28 80			
		03.91- 07.92	CA854IR	28 35			
2020 6.0	(LK/LN2)[OM366.995]	01.84- 02.91	CA568IR	28 30	05.92- 12.98	CS1279	24 4.0
		03.91- 12.98	CA1035IR	28 80	01.84- 12.98	CS120	24 4.0
		03.91- 12.98	CA333IR	28 55			
		03.91- 12.98	CA854IR	28 35			
2024 11.0	(SK)[OM445.924]	01.94- 08.96	CA1035IR	28 80	01.94- 08.96	CS191	24 5.4
	[OM445.925]	01.94- 08.96	CA1035IR	28 80	01.94- 08.96	CS191	24 5.4
2024 6.0	(LK/LN2)[OM356.999]	01.84- 12.98	CA1035IR	28 80	01.84- 12.98	CS1279	24 4.0
		01.84- 12.98	CA333IR	28 55	01.84- 12.98	CS120	24 4.0
		01.84- 12.98	CA854IR	28 35			
	[OM357.941]	01.84- 12.98	CA1035IR	28 80	01.84- 12.98	CS1279	24 4.0
		01.84- 12.98	CA333IR	28 55	01.84- 12.98	CS120	24 4.0
		01.84- 12.98	CA854IR	28 35			
	[OM357.947]	01.84- 12.98	CA1035IR	28 80	01.84- 12.98	CS1279	24 4.0
		01.84- 12.98	CA333IR	28 55	01.84- 12.98	CS120	24 4.0
		01.84- 12.98	CA854IR	28 35			
2024 9.6	(SK)[OM401.975]	02.93- 08.94	CA1035IR	28 80	02.93- 09.94	CS191	24 5.4
		02.93- 09.94	CA333IR	28 55			
		02.93- 09.94	CA854IR	28 35			
	[OM401.984]	02.93-	CA1035IR	28 80	02.93-	CS191	24 5.4
		02.93-	CA333IR	28 55			
		02.93-	CA854IR	28 35			
2025 12.8	(NG)[OM402.912]	11.79- 10.80	CA187IR	28 27	10.76- 02.77	CS198	24 6.0
					03.77- 10.80	CS191	24 5.4
	[OM402.916]	11.79- 10.80	CA187IR	28 27	10.76- 02.77	CS198	24 6.0
					08.83- 03.91	CS198	24 6.0
2025 14.6	(NG)[OM422.909]	08.83- 10.86	CA187IR	28 27			
		11.86- 03.91	CA333IR	28 55			
		11.86- 03.91	CA568IR	28 30			
		10.88- 03.91	CA1035IR	28 80			
2027 11.0	(SK)[OM445.933]	02.93- 09.96	CA1035IR	28 80	02.93- 09.96	CS191	24 5.4
2027 9.6	(SK)[OM401.989]	02.93- 09.96	CA1035IR	28 80	02.93- 09.96	CS191	24 5.4
		02.93- 09.96	CA333IR	28 55			
2028 14.6	(NG)[OM422.905]	01.80- 10.86	CA187IR	28 27	01.80- 06.89	CS198	24 6.0
		11.86- 06.89	CA333IR	28 55	01.80- 06.89	CS191	24 5.4
		11.86- 06.89	CA568IR	28 30			
		10.88- 06.89	CA1035IR	28 80			
	[OM422.906]	01.80- 10.86	CA187IR	28 27	01.80- 06.89	CS198	24 6.0
		11.86- 06.89	CA333IR	28 55	01.80- 06.89	CS191	24 5.4
		11.86- 06.89	CA568IR	28 30			
		10.88- 06.89	CA1035IR	28 80			
	[OM422.907]	01.80- 05.85	CA187IR	28 27	05.83- 06.89	CS198	24 6.0
		06.85- 06.89	CA854IR	28 35	01.80- 06.89	CS191	24 5.4
		11.86- 06.89	CA333IR	28 55			
		10.88- 06.89	CA1035IR	28 80			
	[OM422.910]	01.80- 10.86	CA187IR	28 27	01.80- 06.89	CS198	24 6.0
		11.86- 06.89	CA333IR	28 55	01.80- 06.89	CS191	24 5.4
		11.86- 06.89	CA568IR	28 30			
		10.88- 06.89	CA1035IR	28 80			
	[OM422.911]	01.80- 10.86	CA187IR	28 27	01.80- 06.89	CS198	24 6.0
		06.85- 06.89	CA854IR	28 35	01.80- 06.89	CS191	24 5.4
		11.86- 06.89	CA333IR	28 55			
		11.86- 06.89	CA568IR	28 30			
		10.88- 06.89	CA1035IR	28 80			
	[OM422.913]	01.80- 05.85	CA187IR	28 27	05.83- 06.89	CS198	24 6.0
		06.85- 06.89	CA854IR	28 35	01.80- 06.89	CS191	24 5.4
		11.86- 06.89	CA333IR	28 55			
		10.88- 06.89	CA1035IR	28 80			
2031 11.0	(SK)[OM445.929]	01.94- 09.96	CA1035IR	28 80	01.94- 09.96	CS191	24 5.4
	[OM445.930]	01.94- 08.96	CA1035IR	28 80	01.94- 08.96	CS191	24 5.4
		01.94- 08.96	CA333IR	28 55			
2031 11.9	(Actros)[OM541.920]	04.96- 10.02	CA1505IR	28 100	04.96- 10.02	CS1463	24 6.2 MI
		04.96- 10.02	CA1593IR	28 80	04.96- 10.02	CS1269	24 6.2 BO
		04.96- 10.02	CA1666IR	28 80	04.96- 10.02	CS1077	24 6.2
		04.96- 10.02	CA1739IR	28 100	AC 04.96- 10.02	CS1168#	24 7.8
	[OM541.926]	04.96- 10.02	CA1505IR	28 100	04.96- 10.02	CS1077	24 6.2
		04.96- 10.02	CA1593IR	28 80	04.96- 10.02	CS1269	24 6.2 BO
		04.96- 10.02	CA1666IR	28 80	04.96- 10.02	CS1463	24 6.2 MI
		04.96- 10.02	CA1739IR	28 100	AC 04.96- 10.02	CS1168#	24 7.8



2031 12.8	(SK)[OM402.978]	03.92- 08.96	CA1035IR	28 80	03.92- 08.96	CS191	24 5.4
		03.92- 08.96	CA333IR	28 55			
		03.92- 08.96	CA854IR	28 35			
	[OM402.996]	03.92- 08.96	CA1035IR	28 80	03.92- 08.96	CS191	24 5.4
		03.92- 08.96	CA333IR	28 55			
		03.92- 08.96	CA854IR	28 35			
	[OM440.979]	03.92- 08.96	CA854IR	28 35	03.92- 08.96	CS191	24 5.4
2031 14.6	(SK)[OM446.927]	01.94-	CA1035IR	28 80	01.94-	CS191	24 5.4
2031 9.6	(SK)[OM401.972]	03.92- 09.96	CA1035IR	28 80	03.92- 09.96	CS191	24 5.4
		03.92- 09.96	CA333IR	28 55			
		03.92- 09.96	CA854IR	28 35			
	[OM401.979]	03.92- 09.96	CA1035IR	28 80	03.92- 09.96	CS191	24 5.4
		03.92- 09.96	CA333IR	28 55			
		03.92- 09.96	CA854IR	28 35			
	[OM401.986]	03.92- 08.96	CA1035IR	28 80	03.92- 08.96	CS191	24 5.4
		03.92- 08.96	CA333IR	28 55			
		03.92- 08.96	CA854IR	28 35			
	[OM401.993]	03.92- 09.96	CA1035IR	28 80	03.92- 09.96	CS191	24 5.4
		03.92- 09.96	CA333IR	28 55			
		03.92- 09.96	CA854IR	28 35			
2032 11.9	(Actros)[OM541.920]	04.03-	CA1505IR	28 100	04.03-	CS1463	24 6.2 MI
		04.03-	CA1593IR	28 80			
		04.03-	CA1666IR	28 80			
		04.03-	CA1739IR	28 100			
	[OM541.926]	04.03-	CA1505IR	28 100	04.03-	CS1269	24 6.2 BO
		04.03-	CA1593IR	28 80	04.03-	CS1077	24 6.2
		04.03-	CA1666IR	28 80	04.03-	CS1463	24 6.2 MI
		04.03-	CA1739IR	28 100			
	[OM541.940]	04.03-	CA1505IR	28 100	04.03-	CS1269	24 6.2 BO
		04.03-	CA1593IR	28 80	04.03-	CS1077	24 6.2
		04.03-	CA1666IR	28 80	04.03-	CS1463	24 6.2 MI
		04.03-	CA1739IR	28 100			
	[OM541.941]	04.03-	CA1505IR	28 100	04.03-	CS1077	24 6.2
		04.03-	CA1593IR	28 80	04.03-	CS1269	24 6.2 BO
		04.03-	CA1666IR	28 80	04.03-	CS1463	24 6.2 MI
		04.03-	CA1739IR	28 100			
2032 14.6	(NG)[OM422.952]	12.81- 10.86	CA187IR	28 27	12.81- 05.87	CS198	24 6.0
		11.86- 05.87	CA333IR	28 55			
		11.86- 05.87	CA568IR	28 30			
		12.81- 10.86	CA187IR	28 27			
	[OM422.956]	11.86- 05.87	CA333IR	28 55	12.81- 05.87	CS198	24 6.0
		11.86- 05.87	CA568IR	28 30			
2032 15.9	(NG)[OM403.931]	11.79- 09.83	CA187IR	28 27	08.75- 09.83	CS198	24 6.0
	[OM403.932]	11.79- 09.83	CA187IR	28 27	08.75- 09.83	CS198	24 6.0
2035 11.9	(Actros)[OM541.922]	04.96- 10.02	CA1505IR	28 100	04.96- 10.02	CS1269	24 6.2 BO
		04.96- 10.02	CA1593IR	28 80			
		04.96- 10.02	CA1666IR	28 80			
		04.96- 10.02	CA1739IR	28 100			
	[OM541.927]	04.97- 10.02	CA1505IR	28 100	04.97- 10.02	CS1077	24 6.2
		04.97- 10.02	CA1593IR	28 80	AC 04.97- 10.02	CS1168#	24 7.8
		04.97- 10.02	CA1666IR	28 80	04.97- 10.02	CS1269	24 6.2 BO
		04.97- 10.02	CA1739IR	28 100	04.97- 10.02	CS1463	24 6.2 MI
2035 14.6	(NG)[OM442.950]	06.86- 10.86	CA187IR	28 27	06.86- 07.89	CS191	24 5.4
		11.86- 07.89	CA333IR	28 55			
		11.86- 07.89	CA568IR	28 30			
		06.86- 10.86	CA187IR	28 27			
	[OM442.952]	11.86- 07.89	CA333IR	28 55	06.86- 07.89	CS191	24 5.4
		11.86- 07.89	CA568IR	28 30			
		06.86- 10.86	CA187IR	28 27	06.86- 07.89	CS191	24 5.4
		11.86- 07.89	CA333IR	28 55			
		11.86- 07.89	CA568IR	28 30			
2036 11.9	(Actros)[OM541.922]	04.03-	CA1505IR	28 100	04.03-	CS1463	24 6.2 MI
		04.03-	CA1593IR	28 80			
		04.03-	CA1666IR	28 80			
		04.03-	CA1739IR	28 100			
	[OM541.927]	04.03-	CA1505IR	28 100	04.03-	CS1269	24 6.2 BO
		04.03-	CA1593IR	28 80	04.03-	CS1077	24 6.2
		04.03-	CA1666IR	28 80	04.03-	CS1269	24 6.2 BO
		04.03-	CA1739IR	28 100	04.03-	CS1077	24 6.2
	[OM541.942]	04.03-	CA1505IR	28 100	04.03-	CS1269	24 6.2 BO
		04.03-	CA1593IR	28 80	04.03-	CS1463	24 6.2 MI
		04.03-	CA1666IR	28 80	04.03-	CS1077	24 6.2
		04.03-	CA1739IR	28 100			
	[OM541.943]	04.03-	CA1505IR	28 100	04.03-	CS1463	24 6.2 MI
		04.03-	CA1593IR	28 80	04.03-	CS1077	24 6.2
		04.03-	CA1666IR	28 80	04.03-	CS1269	24 6.2 BO
		04.03-	CA1739IR	28 100			
	(Actros MP2 / MP3)[OM541.922]	04.03-	CA1593IR	28 80			
	[OM541.942]	04.03-	CA1593IR	28 80			
	[OM541.972]	04.03-	CA1593IR	28 80			
	[OM541.998]	04.03-	CA1593IR	28 80			
2036 14.6	(NG)[OM442.950]	03.84- 05.85	CA187IR	28 27	03.84- 06.89	CS198	24 6.0
		06.85- 11.86	CA854IR	28 35			
		11.86- 06.89	CA333IR	28 55			
		10.88- 06.89	CA1035IR	28 80			
	[OM442.962]	03.84- 05.85	CA187IR	28 27	03.84- 06.89	CS198	24 6.0
		03.84- 06.89	CA854IR	28 35			
		11.86- 06.89	CA333IR	28 55			
		10.88- 06.89	CA1035IR	28 80			
2036 18.3	(NG)[OM423.905]	03.84- 10.86	CA187IR	28 27	03.84- 03.91	CS198	24 6.0
		11.86- 03.91	CA333IR	28 55			
		11.86- 03.91	CA568IR	28 30			
		10.88- 03.91	CA1035IR	28 80			
	[OM423.908]	03.84- 10.86	CA187IR	28 27	03.84- 03.91	CS198	24 6.0
		11.86- 03.91	CA333IR	28 55			
		11.86- 03.91	CA568IR	28 30			
		10.88- 03.91	CA1035IR	28 80			
2038 12.8	(SK)[OM402.971]	11.91- 08.96	CA1035IR	28 80	11.91- 08.96	CS191	24 5.4
		11.91- 08.96	CA333IR	28 55			
		11.91- 08.96	CA854IR	28 35			
		11.91- 08.96	CA1035IR	28 80			
	[OM402.972]	11.91- 08.96	CA1035IR	28 80	11.91- 08.96	CS191	24 5.4
		11.91- 08.96	CA333IR	28 55			
		11.91- 08.96	CA854IR	28 35			
		11.91- 08.96	CA1035IR	28 80			
	[OM402.978]	12.92- 09.96	CA1035IR	28 80	12.92- 09.96	CS191	24 5.4
		12.92- 09.96	CA333IR	28 55			
		12.92- 09.96	CA854IR	28 35			



MERCEDES-BENZ Continued

	[OM402.985]	11.91- 09.96	CA1035IR	28 80		11.91- 09.96	CS191	24 5.4
		11.91- 09.96	CA333IR	28 55				
		11.91- 09.96	CA854IR	28 35				
	[OM402.986]	11.91-	CA1035IR	28 80		11.91-	CS191	24 5.4
		11.91-	CA333IR	28 55				
		11.91- 08.96	CA854IR	28 35				
2038 14.6	(SK)[OM440.970]	12.92- 09.96	CA854IR	28 35		12.92- 09.96	CS191	24 5.4
	[OM440.979]	12.92- 09.96	CA1035IR	28 80		12.92- 09.96	CS191	24 5.4
	[OM446.925]	01.94- 08.96	CA1035IR	28 80		01.94- 08.96	CS191	24 5.4
	[OM446.927]	01.94- 08.96	CA1035IR	28 80		01.94- 08.96	CS191	24 5.4
2040 11.9	(Actros)[OM541.923]	04.96- 10.02	CA1505IR	28 100		04.96- 10.02	CS1463	24 6.2 MI
		04.96- 10.02	CA1593IR	28 80		AC 04.96- 10.02	CS1168#	24 7.8
		04.96- 10.02	CA1666IR	28 80		04.96- 10.02	CS1269	24 6.2 BO
		04.96- 10.02	CA1739IR	28 100		04.96- 10.02	CS1077	24 6.2
	[OM541.924]	04.96- 10.02	CA1505IR	28 100		04.96- 10.02	CS1077	24 6.2
		04.96- 10.02	CA1593IR	28 80		AC 04.96- 10.02	CS1168#	24 7.8
		04.96- 10.02	CA1666IR	28 80		04.96- 10.02	CS1463	24 6.2 MI
		04.96- 10.02	CA1739IR	28 100		04.96- 10.02	CS1269	24 6.2 BO
2041 11.9	(Actros)[OM541.923]	04.03-	CA1505IR	28 100		04.03-	CS1269	24 6.2 BO
		04.03-	CA1593IR	28 80		04.03-	CS1077	24 6.2
		04.03-	CA1666IR	28 80		04.03-	CS1463	24 6.2 MI
		04.03-	CA1739IR	28 100				
	[OM541.924]	04.03-	CA1505IR	28 100		04.03-	CS1463	24 6.2 MI
		04.03-	CA1593IR	28 80		04.03-	CS1269	24 6.2 BO
		04.03-	CA1666IR	28 80		04.03-	CS1077	24 6.2
		04.03-	CA1739IR	28 100				
	[OM541.944]	04.03-	CA1505IR	28 100		04.03-	CS1077	24 6.2
		04.03-	CA1593IR	28 80		04.03-	CS1463	24 6.2 MI
		04.03-	CA1666IR	28 80		04.03-	CS1269	24 6.2 BO
		04.03-	CA1739IR	28 100				
2043 11.9	(Actros)[OM541.925]	04.96- 10.02	CA1505IR	28 100		04.96- 10.02	CS1463	24 6.2 MI
		04.96- 10.02	CA1593IR	28 80		04.96- 10.02	CS1077	24 6.2
		04.96- 10.02	CA1666IR	28 80		04.96- 10.02	CS1269	24 6.2 BO
		04.96- 10.02	CA1739IR	28 100				
2044 11.9	(Actros)[OM541.921]	04.03-	CA1505IR	28 100		04.03-	CS1269	24 6.2 BO
		04.03-	CA1593IR	28 80		04.03-	CS1077	24 6.2
		04.03-	CA1666IR	28 80		04.03-	CS1463	24 6.2 MI
		04.03-	CA1739IR	28 100				
	[OM541.925]	04.03-	CA1505IR	28 100		04.03-	CS1463	24 6.2 MI
		04.03-	CA1593IR	28 80		04.03-	CS1269	24 6.2 BO
		04.03-	CA1666IR	28 80		04.03-	CS1077	24 6.2
		04.03-	CA1739IR	28 100				
	[OM541.946]	04.03-	CA1505IR	28 100		04.03-	CS1463	24 6.2 MI
		04.03-	CA1593IR	28 80		04.03-	CS1269	24 6.2 BO
		04.03-	CA1666IR	28 80		04.03-	CS1077	24 6.2
		04.03-	CA1739IR	28 100				
	(Actros MP2 / MP3)[OM541.925]	04.03-	CA1505IR	28 100				
	[OM541.946]	04.03-	CA1505IR	28 100				
	[OM541.976]	04.03-	CA1505IR	28 100				
	[OM541.992]	04.03-	CA1505IR	28 100				
2044 12.0	(Actros)[OM541.947]	04.03-	CA1666IR	28 80		04.03-	CS1463	24 6.2 MI
		04.03-	CA1739IR	28 100		04.03-	CS1269	24 6.2 BO
2044 14.6	(SK)[OM440.970]	01.92- 09.96	CA1035IR	28 80		01.92- 09.96	CS191	24 5.4
		01.92- 09.96	CA333IR	28 55				
		01.92- 09.96	CA854IR	28 35				
	[OM440.979]	01.94- 09.96	CA1035IR	28 80		01.94- 09.96	CS191	24 5.4
		01.94- 09.96	CA333IR	28 55				
		01.94- 09.96	CA854IR	28 35				
	[OM446.922]	01.92- 09.96	CA1035IR	28 80		01.92- 09.96	CS191	24 5.4
		01.92- 09.96	CA333IR	28 55				
		01.92- 09.96	CA854IR	28 35				
2046 11.9	(Actros)[OM541.948]	04.03-	CA1593IR	28 80		04.03-	CS1463	24 6.2 MI
		04.03-	CA1666IR	28 80		04.03-	CS1269	24 6.2 BO
		04.03-	CA1739IR	28 100				
	(Actros MP2 / MP3)[OM541.948]	04.03-	CA1593IR	28 80				
	[OM541.980]	04.03-	CA1593IR	28 80				
	[OM541.994]	04.03-	CA1593IR	28 80				
2048 11.9	(Actros)[OM541.948]	04.03-	CA1666IR	28 80		04.03-	CS1269	24 6.2 BO
		04.03-	CA1739IR	28 100		04.03-	CS1463	24 6.2 MI
	(Actros MP2 / MP3)[OM541.978]	04.03-	CA1739IR	28 100				
		06.08-	CA1739IR	28 100				
2048 12.0	(Actros)[OM541.948]	04.03-	CA1666IR	28 80		04.03-	CS1269	24 6.2 BO
		04.03-	CA1739IR	28 100		04.03-	CS1463	24 6.2 MI
2048 15.9	(Actros)[OM542.925]	04.03-	CA1035IR	28 80		04.96- 10.02	CS1077	24 6.2
		04.96- 10.02	CA1505IR	28 100		04.96- 10.02	CS1269	24 6.2 BO
		04.96- 10.02	CA1593IR	28 80		04.96- 10.02	CS1463	24 6.2 MI
		04.96- 10.02	CA1666IR	28 80				
		04.96- 10.02	CA1739IR	28 100				
2050 14.6	(SK)[OM440.976]	01.91- 02.01	CA1035IR	28 80		01.91- 02.01	CS191	24 5.4
		01.91- 02.01	CA333IR	28 55				
		01.91- 02.91	CA568IR	28 30				
		01.91- 02.01	CA854IR	28 35				
	[OM442.985]	01.91- 02.01	CA1035IR	28 80		01.91- 02.01	CS191	24 5.4
		01.91- 02.01	CA333IR	28 55				
		01.91- 02.91	CA568IR	28 30				
		03.91- 02.01	CA854IR	28 35				
	[OM442.989]	01.91- 02.01	CA1035IR	28 80		01.91- 02.01	CS191	24 5.4
		01.91- 02.01	CA333IR	28 55				
		01.91- 02.91	CA568IR	28 30				
		03.91- 02.01	CA854IR	28 35				
	[OM442.992]	01.91- 02.01	CA1035IR	28 80		01.91- 02.01	CS191	24 5.4
		01.91- 02.01	CA333IR	28 55				
		01.91- 02.91	CA568IR	28 30				
		03.91- 02.01	CA854IR	28 35				
	[OM442.997]	01.91- 02.01	CA1035IR	28 80		01.91- 02.01	CS191	24 5.4
		01.91- 02.01	CA333IR	28 55				
		01.91- 02.91	CA568IR	28 30				
		03.91- 02.01	CA854IR	28 35				
	[OM446.920]	01.91- 02.01	CA1035IR	28 80		01.91- 02.01	CS191	24 5.4
		01.91- 02.01	CA333IR	28 55				
		01.91- 02.91	CA568IR	28 30				
		03.91- 02.01	CA854IR	28 35				
2050 15.9	(Actros)[OM542.940]	04.03-	CA1505IR	28 100		04.03-	CS1077	24 6.2
		04.03-	CA1593IR	28 80		04.03-	CS1269	24 6.2 BO
		04.03-	CA1666IR	28 80		04.03-	CS1463	24 6.2 MI
		04.03-	CA1739IR	28 100				





	[OM542.941]	04.03- 04.03- 04.03- 04.03-	CA1505IR 28 100 CA1593IR 28 80 CA1666IR 28 80 CA1739IR 28 100		04.03- 04.03- 04.03-	CS1463 24 6.2 MI CS1269 24 6.2 BO CS1077 24 6.2
2051 15.9	(Actros MP2 / MP3)	06.08-	CA1739IR 28 100			
2051 16.0	(Actros)[OM542.940]	04.03- 04.03-	CA1666IR 28 80 CA1739IR 28 100		04.03- 04.03- 04.03-	CS1269 24 6.2 BO CS1077 24 6.2 CS1463 24 6.2 MI
	[OM542.960]	04.03- 04.03-	CA1666IR 28 80 CA1739IR 28 100		04.03- 04.03-	CS1269 24 6.2 BO CS1463 24 6.2 MI
2053 11.9	(Actros)[OM542.920]	04.96- 10.02 04.96- 10.02 04.96- 10.02 04.96- 10.02	CA1505IR 28 100 CA1593IR 28 80 CA1666IR 28 80 CA1739IR 28 100		04.96- 10.02 04.96- 10.02 AC 04.96- 10.02 04.96- 10.02	CS1269 24 6.2 BO CS1463 24 6.2 MI CS1166# 24 7.8 CS1077 24 6.2
2054 15.9	(Actros MP2 / MP3)[OM542.942]	04.03-	CA1505IR 28 100			
2055 14.6	(SK)[OM442.997]	01.92- 09.96 01.92- 09.96	CA1035IR 28 80 CA333IR 28 55		01.92- 09.96	CS191 24 5.4
2055 15.9	(Actros MP2 / MP3)	06.08-	CA1739IR 28 100			
2219 5.7	(NG)[OM362.906]	02.83- 09.85	CA187IR 28 27		02.83- 09.85	CS120 24 4.0
	[OM362.909]	02.83- 09.85	CA187IR 28 27		02.83- 09.85	CS120 24 4.0
2219 9.6	(NG)[OM401.914]	04.81- 01.87	CA186IR 14 55		06.76- 02.77 03.77- 01.87	CS198 24 6.0 CS191 24 5.4
	[OM401.923]	04.81- 01.87	CA186IR 14 55		06.76- 01.87 06.76- 01.87	CS198 24 6.0 CS191 24 5.4
	[OM401.925]	04.81- 01.87	CA186IR 14 55		06.76- 02.77 03.77- 01.87	CS198 24 6.0 CS191 24 5.4
	[OM401.926]	04.81- 01.87	CA186IR 14 55		06.76- 01.87 06.76- 01.87	CS191 24 5.4 CS198 24 6.0
	[OM401.927]	04.81- 01.87	CA186IR 14 55		06.76- 01.87 06.76- 01.87	CS198 24 6.0 CS191 24 5.4
2220 6.0	(NG)[OM366.983]	07.85- 10.86 11.86- 03.91 11.86- 03.91 10.88- 03.91	CA187IR 28 27 CA333IR 28 55 CA568IR 28 30 CA1035IR 28 80		07.85- 03.91	CS120 24 4.0
2222 11.0	(NG)[OM421.905]	08.73- 09.96 08.73- 09.96 05.82- 10.89 11.86- 03.91 10.88- 03.91	CA568IR 28 30 CA854IR 28 35 CA187IR 28 27 CA333IR 28 55 CA1035IR 28 80		08.73- 09.96 05.82- 03.91	CS191 24 5.4 CS198 24 6.0
	[OM421.907]	05.82- 10.86 11.86- 03.91 11.86- 03.91 10.88- 03.91	CA187IR 28 27 CA333IR 28 55 CA568IR 28 30 CA1035IR 28 80		05.82- 03.91 05.82- 03.91	CS198 24 6.0 CS191 24 5.4
	[OM441.905]	08.73- 09.96 08.73- 09.96	CA568IR 28 30 CA854IR 28 35		08.73- 09.96	CS191 24 5.4
	[OM441.906]	05.82- 10.86 11.86- 03.91 11.86- 03.91 10.88- 03.91	CA187IR 28 27 CA333IR 28 55 CA568IR 28 30 CA1035IR 28 80		05.82- 03.91 05.82- 03.91	CS191 24 5.4 CS198 24 6.0
	[OM441.917]	08.73- 09.96 08.73- 09.96	CA1035IR 28 80 CA333IR 28 55		08.73- 09.96	CS191 24 5.4
2222 11.3	(NG)[OM441.914]	08.73- 09.96 08.73- 09.96	CA568IR 28 30 CA854IR 28 35		08.73- 09.96	CS191 24 5.4
	[OM441.919]	08.73- 09.96 08.73- 09.96	CA568IR 28 30 CA854IR 28 35		08.73- 09.96	CS191 24 5.4
2224 12.8	(NG)[OM402.910]	04.76- 12.82	CA186IR 14 55		04.76- 02.77 03.77- 12.82	CS198 24 6.0 CS191 24 5.4
	[OM402.911]	04.76- 12.82	CA186IR 14 55		04.76- 12.82 04.76- 12.82	CS198 24 6.0 CS191 24 5.4
	[OM402.914]	03.78- 06.82	CA187IR 28 27		03.77- 03.84 05.75- 02.77	CS191 24 5.4 CS198 24 6.0
	[OM402.927]	04.76- 12.82	CA186IR 14 55		03.77- 12.82 04.76- 02.77	CS191 24 5.4 CS198 24 6.0
	[OM402.928]	04.76- 12.82	CA186IR 14 55		04.76- 12.82 04.76- 12.82	CS198 24 6.0 CS191 24 5.4
2225 14.6	(NG)[OM422.909]	08.73- 09.96 08.73- 09.96 08.73- 09.96 04.85- 03.91 09.96	CA1035IR 28 80 CA333IR 28 55 CA854IR 28 35 CA568IR 28 30 CA187IR 28 27		08.73- 09.96 08.73- 09.96	CS191 24 5.4 CS198 24 6.0
	[OM422.912]	08.83- 10.86 11.86- 03.91 11.86- 03.91 10.88- 03.91	CA187IR 28 27 CA333IR 28 55 CA568IR 28 30 CA1035IR 28 80		08.83- 03.91 08.83- 03.91	CS191 24 5.4 CS198 24 6.0
2226 12.8	(NG)[OM402.912]	11.79- 12.80	CA187IR 28 27		03.77- 12.80 06.75- 02.77	CS191 24 5.4 CS198 24 6.0
	[OM402.916]	11.79- 12.80	CA187IR 28 27		06.75- 02.77 03.77- 12.80	CS198 24 6.0 CS191 24 5.4
	[OM402.924]	11.79- 12.80	CA187IR 28 27		03.77- 12.80 06.75- 02.77	CS191 24 5.4 CS198 24 6.0
2228 14.6	(NG)[OM422.905]	12.79- 10.86 11.86- 03.91 11.86- 03.91	CA187IR 28 27 CA333IR 28 55 CA568IR 28 30		12.79- 03.91 12.79- 03.91	CS191 24 5.4 CS198 24 6.0
	[OM422.906]	12.79- 10.86 11.86- 03.91 11.86- 03.91	CA187IR 28 27 CA333IR 28 55 CA568IR 28 30		12.79- 03.91 12.79- 03.91	CS191 24 5.4 CS198 24 6.0
	[OM422.911]	12.79- 10.86 11.86- 03.91 11.86- 03.91	CA187IR 28 27 CA333IR 28 55 CA568IR 28 30		12.79- 03.91 12.79- 03.91	CS191 24 5.4 CS198 24 6.0
2232 15.9	(NG)[OM403.931]	03.78- 09.83	CA187IR 28 27		05.74- 09.83	CS198 24 6.0
	[OM403.932]	03.78- 09.83	CA187IR 28 27		05.74- 09.83	CS198 24 6.0
2233 14.6	(NG)[OM422.952]	11.80- 10.86 11.86- 05.87 11.86- 05.87	CA187IR 28 27 CA333IR 28 55 CA568IR 28 30		11.80- 05.87	CS198 24 6.0
	[OM422.954]	11.80- 10.86 11.86- 05.87 11.86- 05.87	CA187IR 28 27 CA333IR 28 55 CA568IR 28 30		11.80- 05.87	CS198 24 6.0
	[OM422.957]	11.80- 10.86 06.85- 05.87 11.86- 05.87 11.86- 05.87	CA187IR 28 27 CA854IR 28 35 CA333IR 28 55 CA568IR 28 30		11.80- 05.87	CS198 24 6.0
	[OM422.958]	11.80- 10.86 06.85- 05.87 11.86- 05.87 11.86- 05.87	CA187IR 28 27 CA854IR 28 35 CA333IR 28 55 CA568IR 28 30		11.80- 05.87	CS198 24 6.0
2235 14.6	(NG)[OM442.950]	11.83- 07.89 03.86- 10.86 11.86- 07.89 10.88- 07.89	CA333IR 28 55 CA187IR 28 27 CA568IR 28 30 CA1035IR 28 80		03.86- 07.89	CS191 24 5.4



**MERCEDES-BENZ** *Continued*

2236 18.3	(NG)[OM423.905]	09.82- 10.86	CA1871R	28 27	09.82- 03.91	CS198	24 6.0
		11.86- 03.91	CA3331R	28 55			
		11.86- 03.91	CA5681R	28 30			
[OM423.908]	(NG)[OM422.953]	09.82- 10.86	CA1871R	28 27	09.82- 03.91	CS198	24 6.0
		11.86- 03.91	CA3331R	28 55			
		11.86- 03.91	CA5681R	28 30			
2238 14.6	(NG)[OM422.953]	01.81- 10.86	CA1871R	28 27	01.81- 12.86	CS191	24 5.4
		11.86- 12.86	CA3331R	28 55			
		11.86- 12.86	CA5681R	28 30			
[OM422.955]	(NG)[OM442.951]	01.81- 10.86	CA1871R	28 27	01.81- 12.86	CS191	24 5.4
		11.86- 12.86	CA3331R	28 55			
		11.86- 12.86	CA5681R	28 30			
[OM422.959]	(MK)[OM356.984]	01.81- 10.86	CA1871R	28 27	01.81- 12.86	CS198	24 6.0
		11.86- 12.86	CA3331R	28 55			
		11.86- 12.86	CA5681R	28 30			
2244 14.6	(NG)[OM442.951]	10.85- 10.86	CA1871R	28 27	10.85- 07.89	CS191	24 5.4
		11.86- 07.89	CA3331R	28 55			
		11.86- 07.89	CA5681R	28 30			
[OM442.959]	(MK)[OM356.984]	10.88- 07.89	CA10351R	28 80	12.87- 09.96	CS120	24 4.0
		12.87- 09.96	CA10351R	28 80			
		12.87- 09.96	CA3331R	28 55			
2320 6.0	(MK)[OM356.984]	12.87- 09.96	CA3331R	28 55	12.87- 09.96	CS120	24 4.0
		12.87- 09.96	CA8541R	28 35			
		12.87- 09.96	CA10351R	28 80			
[OM356.987]	(MK)[OM445.926]	12.87- 09.96	CA10351R	28 80	12.87- 09.96	CS191	24 5.4
		12.87- 09.96	CA3331R	28 55			
		12.87- 09.96	CA8541R	28 35			
2327 11.0	(MK)[OM445.926]	12.87- 09.96	CA10351R	28 80	12.87- 09.96	CS191	24 5.4
		12.87- 09.96	CA3331R	28 55			
		12.87- 09.96	CA8541R	28 35			
2327 9.6	(MK)[OM401.973]	12.87- 09.96	CA10351R	28 80	12.87- 09.96	CS191	24 5.4
		12.87- 09.96	CA3331R	28 55			
		12.87- 09.96	CA8541R	28 35			
2420 6.0	(MK)[OM356.984]	02.90- 08.94	CA10351R	28 80	02.90- 08.94	CS120	24 4.0
		02.90- 08.94	CA3331R	28 55			
		02.90- 02.91	CA5681R	28 30			
[OM366.983]	(MK)[OM441.905]	03.91- 08.94	CA8541R	28 35	12.87- 09.96	CS198	24 6.0
		12.87- 09.96	CA10351R	28 80			
		12.87- 09.96	CA3331R	28 55			
2422 11.0	(MK)[OM441.905]	12.87- 09.96	CA3331R	28 55	12.87- 09.96	CS198	24 6.0
		12.87- 09.96	CA8541R	28 35			
		12.87- 09.96	CA10351R	28 80			
[OM441.923]	(NG)[OM421.905]	12.87- 09.96	CA10351R	28 80	12.87- 09.96	CS191	24 5.4
		12.87- 09.96	CA3331R	28 55			
		12.87- 09.96	CA8541R	28 35			
(NG)[OM421.905]	(MK)[OM441.905]	10.81- 03.91	CA1871R	28 27	10.81- 03.91	CS191	24 5.4
		10.81- 03.91	CA5681R	28 30			
		10.81- 03.91	CA8541R	28 35			
[OM441.905]	(MK)[OM441.905]	08.73- 09.96	CA10351R	28 80	08.73- 09.96	CS198	24 6.0
		08.73- 09.96	CA3331R	28 55			
		08.73- 09.96	CA8541R	28 35			
[OM441.917]	(SK)[OM441.905]	08.73- 09.96	CA10351R	28 80	08.73- 09.96	CS198	24 6.0
		08.73- 09.96	CA3331R	28 55			
		08.73- 09.96	CA8541R	28 35			
[OM441.923]	(SK)[OM441.905]	07.87- 09.96	CA10351R	28 80	07.87- 09.96	CS191	24 5.4
		07.87- 09.96	CA3331R	28 55			
		07.87- 09.96	CA8541R	28 35			
2422 11.3	(MK)[OM441.905]	07.87- 09.96	CA10351R	28 80	07.87- 09.96	CS191	24 5.4
		07.87- 09.96	CA3331R	28 55			
		07.87- 09.96	CA8541R	28 35			
[OM441.923]	(MK)[OM441.905]	09.89- 08.94	CA10351R	28 80	09.89- 08.94	CS191	24 5.4
		09.89- 08.94	CA3331R	28 55			
		09.89- 02.91	CA5681R	28 30			
[OM441.912]	(MK)[OM441.905]	03.91- 08.94	CA8541R	28 35	09.89- 08.94	CS191	24 5.4
		09.89- 08.94	CA10351R	28 80			
		09.89- 08.94	CA3331R	28 55			
[OM441.916]	(MK)[OM441.905]	09.89- 08.94	CA3331R	28 55	09.89- 08.94	CS191	24 5.4
		09.89- 02.91	CA5681R	28 30			
		09.89- 08.94	CA8541R	28 35			
[OM441.920]	(MK)[OM441.905]	12.87- 09.96	CA10351R	28 80	12.87- 09.96	CS191	24 5.4
		12.87- 09.96	CA3331R	28 55			
		12.87- 09.96	CA8541R	28 35			
[OM441.923]	(MK)[OM441.905]	09.89- 02.91	CA5681R	28 30	09.89- 08.94	CS191	24 5.4
		09.89- 08.94	CA10351R	28 80			
		09.89- 08.94	CA3331R	28 55			
[OM441.924]	(MK)[OM441.905]	09.89- 08.94	CA3331R	28 55	09.89- 08.94	CS191	24 5.4
		09.89- 02.91	CA5681R	28 30			
		03.91- 08.94	CA8541R	28 35			
[OM441.932]	(MK)[OM441.905]	09.89- 08.94	CA10351R	28 80	09.89- 08.94	CS191	24 5.4
		09.89- 08.94	CA3331R	28 55			
		09.89- 08.94	CA8541R	28 35			
(NG)[OM441.914]	(MK)[OM441.905]	08.73- 09.96	CA5681R	28 30	08.73- 09.96	CS191	24 5.4
		08.73- 09.96	CA8541R	28 35			
		08.73- 09.96	CA10351R	28 80			
[OM441.919]	(MK)[OM441.905]	08.73- 09.96	CA3331R	28 55	08.73- 09.96	CS191	24 5.4
		08.73- 09.96	CA8541R	28 35			
		08.73- 09.96	CA10351R	28 80			
2425 14.6	(NG)[OM422.909]	09.85- 10.86	CA1871R	28 27	09.85- 06.89	CS191	24 5.4
		11.86- 06.89	CA3331R	28 55			
		11.86- 06.89	CA5681R	28 30			
[OM441.919]	(MK)[OM441.960]	10.88- 06.89	CA10351R	28 80	02.90- 08.94	CS191	24 5.4
		12.87- 09.96	CA10351R	28 80			
		12.87- 09.96	CA3331R	28 55			
2426 11.0	(MK)[OM441.960]	12.87- 09.96	CA3331R	28 55	12.87- 09.96	CS191	24 5.4
		12.87- 09.96	CA8541R	28 35			
		12.87- 09.96	CA10351R	28 80			
2426 15.1	(MK)[OM442.909]	12.87- 09.96	CA10351R	28 80	12.87- 09.96	CS191	24 5.4
		12.87- 09.96	CA3331R	28 55			
		12.87- 09.96	CA8541R	28 35			
[OM442.914]	(MK)[OM442.909]	12.87- 09.96	CA10351R	28 80	12.87- 09.96	CS191	24 5.4
		12.87- 09.96	CA3331R	28 55			
		12.87- 09.96	CA8541R	28 35			
[OM442.921]	(MK)[OM442.909]	01.90- 02.91	CA5681R	28 30	01.90- 08.94	CS191	24 5.4
		01.90- 08.94	CA10351R	28 80			
		01.90- 08.94	CA3331R	28 55			
[OM442.922]	(MK)[OM442.909]	01.90- 02.91	CA5681R	28 30	12.87- 09.96	CS191	24 5.4
		03.91- 08.94	CA8541R	28 35			
		12.87- 09.96	CA10351R	28 80			
[OM442.932]	(MK)[OM442.909]	12.87- 09.96	CA3331R	28 55	12.87- 09.96	CS191	24 5.4
		12.87- 09.96	CA8541R	28 35			
		02.90- 02.91	CA5681R	28 30			
[OM442.932]	(MK)[OM442.909]	12.87- 09.96	CA10351R	28 80	12.87- 09.96	CS191	24 5.4
		12.87- 09.96	CA3331R	28 55			
		02.90- 02.91	CA5681R	28 30			



		12.87- 09.96	CA333IR	28 55			
		12.87- 09.96	CA854IR	28 35			
		01.90- 02.91	CA568IR	28 30			
	[OM442.934]	01.90- 08.94	CA1035IR	28 80	01.90- 08.94	CS191	24 5.4
		01.90- 08.94	CA333IR	28 55			
		01.90- 02.91	CA568IR	28 30			
		03.91- 08.94	CA854IR	28 35			
2426 6.0	(MK)[OM401.973]				02.90- 08.94	CS191	24 5.4
	[OM401.979]				02.90- 08.94	CS191	24 5.4
2427 15.1	(MK)[OM442.923]	02.90- 08.94	CA1035IR	28 80	02.90- 08.94	CS191	24 5.4
		02.90- 08.94	CA333IR	28 55			
		02.90- 08.94	CA854IR	28 35			
2427 9.6	(MK)[OM401.973]	12.87- 09.96	CA1035IR	28 80	12.87- 09.96	CS191	24 5.4
		12.87- 09.96	CA333IR	28 55			
		12.87- 09.96	CA854IR	28 35			
	[OM401.977]	12.87- 09.96	CA1035IR	28 80	12.87- 09.96	CS191	24 5.4
		12.87- 09.96	CA333IR	28 55	02.90- 08.94	CS198	24 6.0
		12.87- 09.96	CA854IR	28 35			
	[OM401.978]	02.90- 08.94	CA1035IR	28 80	02.90- 08.94	CS191	24 5.4
		02.90- 08.94	CA333IR	28 55			
		02.90- 08.94	CA854IR	28 35			
2428 14.6	(NG)[OM422.905]	08.73- 09.96	CA1035IR	28 80	08.73- 09.96	CS198	24 6.0
		08.73- 09.96	CA333IR	28 55	08.73- 09.96	CS191	24 5.4
		08.73- 09.96	CA854IR	28 35			
	[OM422.911]	08.73- 09.96	CA1035IR	28 80	08.73- 09.96	CS191	24 5.4
		08.73- 09.96	CA333IR	28 55	08.73- 09.96	CS198	24 6.0
		08.73- 09.96	CA854IR	28 35			
	[OM422.913]	08.73- 09.96	CA333IR	28 55	08.73- 09.96	CS191	24 5.4
		08.73- 09.96	CA568IR	28 30	08.73- 09.96	CS198	24 6.0
		08.73- 09.96	CA854IR	28 35			
	[OM422.916]	08.73- 09.96	CA1035IR	28 80	08.73- 09.96	CS198	24 6.0
		08.73- 09.96	CA333IR	28 55	08.73- 09.96	CS191	24 5.4
		08.73- 09.96	CA854IR	28 35			
2429 14.6	(SK)[OM422.916]	07.87- 09.96	CA1035IR	28 80	07.87- 09.96	CS198	24 6.0
		07.87- 09.96	CA333IR	28 55	07.87- 09.96	CS191	24 5.4
		07.87- 09.96	CA854IR	28 35			
2429 15.1	(MK)[OM442.906]				12.87- 08.94	CS191	24 5.4
	[OM442.907]	12.87- 08.94	CA1035IR	28 80	12.87- 08.94	CS191	24 5.4
		12.87- 09.96	CA333IR	28 55			
		12.87- 09.96	CA854IR	28 35			
	[OM442.909]	12.87- 09.96	CA1035IR	28 80	12.87- 09.96	CS191	24 5.4
		12.87- 09.96	CA333IR	28 55			
		12.87- 09.96	CA854IR	28 35			
	[OM442.923]				12.87- 08.94	CS191	24 5.4
	(SK)[OM442.906]	07.87- 09.96	CA1035IR	28 80	07.87- 09.96	CS191	24 5.4
		07.87- 09.96	CA333IR	28 55			
		07.87- 09.96	CA854IR	28 35			
		07.88- 02.91	CA568IR	28 30			
	[OM442.907]	07.87- 09.96	CA1035IR	28 80	07.87- 09.96	CS191	24 5.4
		07.87- 09.96	CA333IR	28 55			
		07.87- 09.96	CA854IR	28 35			
		07.88- 02.91	CA568IR	28 30			
	[OM442.908]	07.87- 09.96	CA1035IR	28 80	07.87- 09.96	CS191	24 5.4
		07.87- 09.96	CA333IR	28 55			
		07.87- 09.96	CA854IR	28 35			
	[OM442.916]	07.87- 09.96	CA1035IR	28 80	07.87- 09.96	CS191	24 5.4
		07.87- 09.96	CA333IR	28 55			
		07.87- 09.96	CA854IR	28 35			
	[OM442.923]	07.87- 09.96	CA1035IR	28 80	07.87- 09.96	CS191	24 5.4
		07.87- 09.96	CA333IR	28 55			
		07.87- 09.96	CA854IR	28 35			
		07.88- 02.91	CA568IR	28 30			
	[OM442.925]	07.87- 09.96	CA1035IR	28 80	07.87- 09.96	CS191	24 5.4
		07.87- 09.96	CA333IR	28 55			
		07.87- 09.96	CA854IR	28 35			
		07.88- 02.91	CA568IR	28 30			
2431 11.0	(MK)[OM445.929]	12.87- 09.96	CA1035IR	28 80	12.87- 09.96	CS198	24 6.0
		12.87- 09.96	CA333IR	28 55	12.87- 09.96	CS191	24 5.4
		12.87- 09.96	CA854IR	28 35			
	[OM445.937]	12.87- 09.96	CA1035IR	28 80	12.87- 09.96	CS191	24 5.4
		12.87- 09.96	CA333IR	28 55	12.87- 09.96	CS198	24 6.0
		12.87- 09.96	CA854IR	28 35			
2431 9.6	(MK)[OM401.972]	12.87- 09.96	CA1035IR	28 80	12.87- 09.96	CS191	24 5.4
		12.87- 09.96	CA333IR	28 55			
		12.87- 09.96	CA854IR	28 35			
	[OM401.979]	12.87- 09.96	CA1035IR	28 80	12.87- 09.96	CS191	24 5.4
		12.87- 09.96	CA333IR	28 55			
		12.87- 09.96	CA854IR	28 35			
	[OM401.993]	12.87- 09.96	CA1035IR	28 80	12.87- 09.96	CS191	24 5.4
		12.87- 09.96	CA333IR	28 55			
		12.87- 09.96	CA854IR	28 35			
2432 11.9	(Actros MP2 / MP3)[OM541.970]	06.08-	CA1739IR	28 100			
	[OM541.996]	06.08-	CA1739IR	28 100			
2433 11.0	(MK)[OM441.960]	12.87- 09.96	CA1035IR	28 80	12.87- 09.96	CS191	24 5.4
		12.87- 09.96	CA333IR	28 55			
		12.87- 09.96	CA854IR	28 35			
		05.89- 02.91	CA568IR	28 30			
	[OM441.962]	05.89- 07.92	CA1035IR	28 80	05.89- 07.92	CS191	24 5.4
		05.89- 07.92	CA333IR	28 55			
		05.89- 02.91	CA568IR	28 30			
		03.91- 07.92	CA854IR	28 35			
	[OM441.981]	12.87- 09.96	CA1035IR	28 80	12.87- 09.96	CS191	24 5.4
		12.87- 09.96	CA333IR	28 55			
		12.87- 09.96	CA854IR	28 35			
		05.89- 02.91	CA568IR	28 30			
	[OM441.983]	05.89- 07.92	CA1035IR	28 80	05.89- 07.92	CS191	24 5.4
		05.89- 07.92	CA333IR	28 55			
		05.89- 02.91	CA568IR	28 30			
		03.91- 07.92	CA854IR	28 35			
	[OM441.986]	12.87- 09.96	CA1035IR	28 80	12.87- 09.96	CS191	24 5.4
		12.87- 09.96	CA333IR	28 55			
		12.87- 09.96	CA854IR	28 35			
		05.89- 02.91	CA568IR	28 30			
	[OM441.989]	12.87- 09.96	CA1035IR	28 80	12.87- 09.96	CS191	24 5.4
		12.87- 09.96	CA333IR	28 55			
		12.87- 09.96	CA854IR	28 35			
		05.89- 02.91	CA568IR	28 30			



MERCEDES-BENZ Continued

	[OM445.920]	05.89- 07.92	CA1035IR	28 80		05.89- 07.92	CS191	24 5.4
		05.89- 07.92	CA333IR	28 55				
		05.89- 02.91	CA568IR	28 30				
		03.91- 07.92	CA854IR	28 35				
	[OM445.939]	05.89- 07.92	CA1035IR	28 80		05.89- 07.92	CS191	24 5.4
		05.89- 07.92	CA333IR	28 55				
		05.89- 02.91	CA568IR	28 30				
		03.91- 07.92	CA854IR	28 35				
2433 14.6	(NG)[OM422.954]	11.80- 11.91	CA1035IR	28 80		05.83- 11.91	CS198	24 6.0
		12.82- 05.85	CA187IR	28 27		12.82- 11.91	CS191	24 5.4
		06.85- 11.91	CA854IR	28 35				
		11.86- 11.91	CA333IR	28 55				
	[OM422.957]	11.80- 11.91	CA1035IR	28 80		12.82- 11.91	CS191	24 5.4
		12.82- 05.85	CA187IR	28 27		05.83- 11.91	CS198	24 6.0
		06.85- 11.91	CA854IR	28 35				
		11.86- 11.91	CA333IR	28 55				
2433 9.6	(MK)[OM401.979]	12.87- 09.96	CA1035IR	28 80		12.87- 09.96	CS191	24 5.4
		12.87- 09.96	CA333IR	28 55				
2434 11.0	(MK)[OM441.960]	05.89- 07.92	CA1035IR	28 80		05.89- 07.92	CS191	24 5.4
		05.89- 07.92	CA333IR	28 55				
		05.89- 02.91	CA568IR	28 30				
		03.91- 07.92	CA854IR	28 35				
	[OM441.962]	05.89- 07.92	CA1035IR	28 80		05.89- 07.92	CS191	24 5.4
		05.89- 07.92	CA333IR	28 55				
		05.89- 02.91	CA568IR	28 30				
		03.91- 07.92	CA854IR	28 35				
	[OM441.981]	05.89- 07.92	CA1035IR	28 80		05.89- 07.92	CS191	24 5.4
		05.89- 07.92	CA333IR	28 55				
		05.89- 02.91	CA568IR	28 30				
		03.91- 07.92	CA854IR	28 35				
	[OM441.983]	05.89- 07.92	CA1035IR	28 80		05.89- 07.92	CS191	24 5.4
		05.89- 07.92	CA333IR	28 55				
		05.89- 02.91	CA568IR	28 30				
		03.91- 07.92	CA854IR	28 35				
	[OM441.986]	05.89- 07.92	CA1035IR	28 80		05.89- 07.92	CS191	24 5.4
		05.89- 07.92	CA333IR	28 55				
		05.89- 02.91	CA568IR	28 30				
		03.91- 07.92	CA854IR	28 35				
	[OM441.989]	01.91- 09.96	CA1035IR	28 80		01.91- 09.96	CS191	24 5.4
		01.91- 09.96	CA333IR	28 55				
	[OM445.920]	01.94- 08.96	CA1035IR	28 80		01.94- 08.96	CS198	24 6.0
	[OM445.939]	01.94- 08.96	CA1035IR	28 80		01.94- 08.96	CS198	24 6.0
	(SK)[OM441.986]	07.87- 09.96	CA1035IR	28 80		07.87- 09.96	CS191	24 5.4
		07.87- 09.96	CA333IR	28 55				
		07.87- 09.96	CA854IR	28 35				
	[OM441.989]	07.87- 09.96	CA1035IR	28 80		07.87- 09.96	CS191	24 5.4
		07.87- 09.96	CA333IR	28 55				
		07.87- 09.96	CA854IR	28 35				
2435 14.6	(SK)[OM440.940]	07.88- 08.94	CA333IR	28 55		07.88- 08.94	CS191	24 5.4
		07.88- 02.91	CA568IR	28 30				
		10.88- 08.94	CA1035IR	28 80				
		03.91- 08.94	CA854IR	28 35				
	[OM440.941]	07.87- 09.96	CA1035IR	28 80		07.87- 09.96	CS191	24 5.4
		07.87- 09.96	CA333IR	28 55				
		07.87- 09.96	CA854IR	28 35				
	[OM440.942]	07.87- 09.96	CA1035IR	28 80		07.87- 09.96	CS191	24 5.4
		07.87- 09.96	CA333IR	28 55				
		07.87- 09.96	CA854IR	28 35				
	[OM442.942]	07.87- 09.96	CA1035IR	28 80		07.87- 09.96	CS191	24 5.4
		07.87- 09.96	CA333IR	28 55				
		07.87- 09.96	CA854IR	28 35				
	[OM442.943]	07.88- 08.94	CA333IR	28 55		07.88- 08.94	CS191	24 5.4
		07.88- 02.91	CA568IR	28 30				
		10.88- 08.94	CA1035IR	28 80				
		03.91- 08.94	CA854IR	28 35				
	[OM442.944]	07.87- 09.96	CA1035IR	28 80		07.87- 09.96	CS191	24 5.4
		07.87- 09.96	CA333IR	28 55				
		07.87- 09.96	CA854IR	28 35				
		07.88- 02.91	CA568IR	28 30				
	[OM442.962]	07.87- 09.96	CA1035IR	28 80		07.87- 09.96	CS191	24 5.4
		07.87- 09.96	CA333IR	28 55				
		07.87- 09.96	CA854IR	28 35				
	[OM442.963]	07.87- 09.96	CA1035IR	28 80		07.87- 09.96	CS191	24 5.4
		07.87- 09.96	CA333IR	28 55				
		07.87- 09.96	CA854IR	28 35				
		07.88- 02.91	CA568IR	28 30				
	[OM442.964]	07.88- 08.94	CA333IR	28 55		07.88- 08.94	CS191	24 5.4
		07.88- 02.91	CA568IR	28 30				
		10.88- 08.94	CA1035IR	28 80				
		03.91- 08.94	CA854IR	28 35				
	[OM442.965]	07.88- 08.94	CA1035IR	28 80		07.88- 08.94	CS191	24 5.4
		07.88- 08.94	CA333IR	28 55				
		07.88- 02.91	CA568IR	28 30				
		03.91- 08.94	CA854IR	28 35				
	[OM442.966]	07.87- 09.96	CA1035IR	28 80		07.87- 09.96	CS191	24 5.4
		07.87- 09.96	CA333IR	28 55				
		07.87- 09.96	CA854IR	28 35				
	[OM442.968]	07.88- 08.94	CA333IR	28 55		07.88- 08.94	CS191	24 5.4
		07.88- 02.91	CA568IR	28 30				
		10.88- 08.94	CA1035IR	28 80				
		03.91- 08.94	CA854IR	28 35				
	[OM442.971]	07.87- 09.96	CA1035IR	28 80		07.87- 09.96	CS191	24 5.4
		07.87- 09.96	CA333IR	28 55				
		07.87- 09.96	CA854IR	28 35				
	[OM442.976]	07.87- 09.96	CA1035IR	28 80		07.87- 09.96	CS191	24 5.4
		07.87- 09.96	CA333IR	28 55				
		07.87- 09.96	CA854IR	28 35				
		07.88- 02.91	CA568IR	28 30				
	[OM442.978]	07.87- 09.96	CA1035IR	28 80		07.87- 09.96	CS191	24 5.4
		07.87- 09.96	CA333IR	28 55				
		07.87- 09.96	CA854IR	28 35				
2436 11.9	(Actros MP2 / MP3)[OM541.972]	06.08-	CA1739IR	28 100				
	[OM541.998]	06.08-	CA1739IR	28 100				
2438 14.6	(NG)[OM422.953]	01.81- 05.85	CA187IR	28 27		05.83- 12.86	CS198	24 6.0
		06.85- 12.86	CA854IR	28 35		01.81- 12.86	CS191	24 5.4
		11.86- 12.86	CA333IR	28 55				
	[OM422.955]	11.80- 06.90	CA187IR	28 27		11.80- 06.90	CS198	24 6.0
		11.80- 06.90	CA333IR	28 55		11.80- 06.90	CS191	24 5.4
		11.80- 06.90	CA854IR	28 35				



	[OM422.959]	11.80- 06.90	CA1871R	28 27		11.80- 06.90	CS198	24 6.0
		11.80- 06.90	CA3331R	28 55		11.80- 06.90	CS191	24 5.4
		11.80- 06.90	CA8541R	28 35				
2440 12.0	(Axor 2)[OM457.948]	10.04-	CA17391R	28 100				
	[OM457.981]	10.04-	CA17391R	28 100				
2441 11.9	(Actros MP2 / MP3)[OM541.974]	06.08-	CA17391R	28 100				
	[OM541.990]	06.08-	CA17391R	28 100				
2444 11.9	(Actros MP2 / MP3)[OM541.976]	06.08-	CA17391R	28 100				
	[OM541.992]	06.08-	CA17391R	28 100				
2444 14.6	(NG)[OM442.951]	08.73- 09.96	CA10351R	28 80		08.73- 09.96	CS191	24 5.4
		08.73- 09.96	CA3331R	28 55				
		08.73- 09.96	CA8541R	28 35				
		10.85- 10.86	CA1871R	28 27				
		11.86- 02.91	CA5681R	28 30				
	[OM442.953]	08.73- 09.96	CA10351R	28 80		08.73- 09.96	CS191	24 5.4
		08.73- 09.96	CA3331R	28 55				
		08.73- 09.96	CA8541R	28 35				
		10.85- 10.86	CA1871R	28 27				
		11.86- 02.91	CA5681R	28 30				
	[OM442.980]	08.73- 09.96	CA10351R	28 80		08.73- 09.96	CS191	24 5.4
		08.73- 09.96	CA3331R	28 55				
		08.73- 09.96	CA8541R	28 35				
		10.85- 10.86	CA1871R	28 27				
		11.86- 02.91	CA5681R	28 30				
2446 11.9	(Actros MP2 / MP3)[OM541.980]	06.08-	CA17391R	28 100				
	[OM541.994]	06.08-	CA17391R	28 100				
2448 11.9	(Actros MP2 / MP3)[OM541.978]	06.08-	CA17391R	28 100				
2448 14.6	(SK)[OM442.984]	01.88- 07.92	CA10351R	28 80		07.88- 07.92	CS191	24 5.4
		07.88- 07.92	CA3331R	28 55				
		07.88- 01.92	CA5681R	28 30				
		03.91- 07.92	CA8541R	28 35				
	[OM442.985]	07.88- 07.92	CA10351R	28 80		07.88- 07.92	CS191	24 5.4
		07.88- 07.92	CA3331R	28 55				
		07.88- 02.91	CA5681R	28 30				
		07.88- 07.92	CA8541R	28 35				
	[OM442.989]	07.88- 07.92	CA3331R	28 55		07.88- 07.92	CS191	24 5.4
		07.88- 02.91	CA5681R	28 30				
		10.88- 07.92	CA10351R	28 80				
		03.91- 07.92	CA8541R	28 35				
	[OM442.992]	07.88- 07.92	CA10351R	28 80		07.88- 07.92	CS191	24 5.4
		07.88- 07.92	CA3331R	28 55				
		07.88- 07.92	CA5681R	28 30				
		07.88- 07.92	CA8541R	28 35				
2522 11.0	(MK)[OM441.905]	12.87- 09.96	CA10351R	28 80		12.87- 09.96	CS191	24 5.4
		12.87- 09.96	CA3331R	28 55				
		12.87- 09.96	CA8541R	28 35				
2522 11.3	(MK)[OM441.920]	12.87- 09.96	CA10351R	28 80		12.87- 09.96	CS191	24 5.4
		12.87- 09.96	CA3331R	28 55				
		12.87- 09.96	CA8541R	28 35				
2523 6.4	(Atego)[OM906.920]	05.98- 09.04	CA15051R	28 100		05.98- 09.04	CS1381	24 4.0 DR
		05.98- 09.04	CA15931R	28 80		05.98- 09.04	CS1112	24 4.0 BO
	(Axor)[OM906.920]	01.02- 10.04	CA15051R	28 100		01.02- 10.04	CS1112	24 4.0
		01.02- 10.04	CA15931R	28 80				
		01.02- 10.04	CA16661R	28 80				
		01.02- 10.04	CA17391R	28 100				
2524 11.0	(MK)[OM445.924]	12.87- 09.96	CA10351R	28 80		12.87- 09.96	CS191	24 5.4
		12.87- 09.96	CA3331R	28 55				
		12.87- 09.96	CA8541R	28 35				
	[OM445.938]	12.87- 09.96	CA10351R	28 80		12.87- 09.96	CS191	24 5.4
		12.87- 09.96	CA3331R	28 55				
		12.87- 09.96	CA8541R	28 35				
	[OM445.941]	12.87- 09.96	CA10351R	28 80		12.87- 09.96	CS191	24 5.4
		12.87- 09.96	CA3331R	28 55				
		12.87- 09.96	CA8541R	28 35				
2524 9.6	(MK)[OM401.973]	02.93- 09.96	CA10351R	28 80		02.93- 09.96	CS191	24 5.4
		02.93- 09.96	CA3331R	28 55				
		02.93- 09.96	CA8541R	28 35				
	[OM401.975]	12.87- 09.96	CA10351R	28 80		12.87- 09.96	CS191	24 5.4
		12.87- 09.96	CA3331R	28 55				
		12.87- 09.96	CA8541R	28 35				
2527 11.0	(MK)[OM445.924]	01.94- 09.96	CA10351R	28 80		01.94- 09.96	CS191	24 5.4
		01.94- 09.96	CA3331R	28 55				
		01.94- 09.96	CA8541R	28 35				
	[OM445.926]	12.87- 09.96	CA10351R	28 80		12.87- 09.96	CS191	24 5.4
		12.87- 09.96	CA3331R	28 55		12.87- 09.96	CS198	24 6.0
						01.94- 09.96	CS191	24 5.4
	[OM445.927]							
	[OM445.929]	01.94-	CA10351R	28 80		01.94- 09.96	CS191	24 5.4
	[OM445.936]	12.87- 09.96	CA10351R	28 80		12.87- 09.96	CS191	24 5.4
		12.87- 09.96	CA3331R	28 55				
		12.87- 09.96	CA8541R	28 35				
	[OM445.940]	01.94-	CA10351R	28 80		01.94- 09.96	CS191	24 5.4
2527 15.1	(MK)[OM442.914]	03.91- 08.94	CA10351R	28 80		03.91- 08.94	CS191	24 5.4
		03.91- 08.94	CA3331R	28 55				
		03.91- 08.94	CA8541R	28 35				
2527 9.6	(MK)[OM401.973]	12.87- 09.96	CA10351R	28 80		12.87- 09.96	CS191	24 5.4
		12.87- 09.96	CA3331R	28 55				
		12.87- 09.96	CA8541R	28 35				
	[OM401.975]	10.93- 09.96	CA10351R	28 80		10.93- 09.96	CS191	24 5.4
		10.93- 09.96	CA3331R	28 55				
		10.93- 09.96	CA8541R	28 35				
	[OM401.977]	12.87- 09.96	CA10351R	28 80		12.87- 09.96	CS191	24 5.4
		12.87- 09.96	CA3331R	28 55				
		12.87- 09.96	CA8541R	28 35				
	[OM401.978]	03.91- 08.94	CA10351R	28 80		03.91- 08.94	CS191	24 5.4
		03.91- 08.94	CA3331R	28 55				
		03.91- 08.94	CA8541R	28 35				
	[OM401.979]	10.93- 09.96	CA10351R	28 80		10.93- 09.96	CS191	24 5.4
		10.93- 09.96	CA3331R	28 55				
		10.93- 09.96	CA8541R	28 35				
	[OM401.980]	03.91- 09.96	CA10351R	28 80		03.91- 09.96	CS191	24 5.4
		03.91- 09.96	CA3331R	28 55				
		03.91- 09.96	CA8541R	28 35				
	[OM401.991]	12.87- 09.96	CA10351R	28 80		12.87- 09.96	CS191	24 5.4
		12.87- 09.96	CA3331R	28 55				
		12.87- 09.96	CA8541R	28 35				



MERCEDES-BENZ Continued

2528 14.6	(NG)[OM422.907]	01.80- 03.91 CA1035IR 28 80	01.80- 03.91 CS191 24 5.4	
		01.80- 03.91 CA333IR 28 55		
		01.80- 03.91 CA854IR 28 35		
	[OM422.911]	01.80- 03.91 CA1035IR 28 80	01.80- 03.91 CS191 24 5.4	
		01.80- 03.91 CA333IR 28 55		
		01.80- 03.91 CA854IR 28 35		
	[OM422.913]	01.80- 03.91 CA1035IR 28 80	01.80- 03.91 CS191 24 5.4	
		01.80- 03.91 CA333IR 28 55		
		01.80- 03.91 CA854IR 28 35		
	[OM422.916]	01.80- 03.91 CA1035IR 28 80	01.80- 03.91 CS191 24 5.4	
		01.80- 03.91 CA333IR 28 55		
		01.80- 03.91 CA854IR 28 35		
2528 6.4	(Atego)[OM906.921]	05.98- 09.04 CA1505IR 28 100	05.98- 09.04 CS1381 24 4.0 DR	
		05.98- 09.04 CA1593IR 28 80	05.98- 09.04 CS1112 24 4.0 BO	
	(Axor)[OM906.921]	01.02- 10.04 CA1505IR 28 100	01.02- 10.04 CS1112 24 4.0	
		01.02- 10.04 CA1593IR 28 80		
		01.02- 10.04 CA1666IR 28 80		
		01.02- 10.04 CA1739IR 28 100		
	2531 11.0	(MK)[OM445.920]	12.87- 09.96 CA1035IR 28 80	12.87- 09.96 CS191 24 5.4
			12.87- 09.96 CA1035IR 28 80	12.87- 09.96 CS198 24 6.0
		[OM445.929]	12.87- 09.96 CA333IR 28 55	12.87- 09.96 CS191 24 5.4
			12.87- 09.96 CA854IR 28 35	
			12.87- 09.96 CA1035IR 28 80	12.87- 09.96 CS198 24 6.0
			12.87- 09.96 CA333IR 28 55	12.87- 09.96 CS191 24 5.4
[OM445.937]		12.87- 09.96 CA854IR 28 35		
		12.87- 09.96 CA1035IR 28 80	07.87- 09.96 CS198 24 6.0	
		07.87- 09.96 CA333IR 28 55	07.87- 09.96 CS191 24 5.4	
(SK)[OM445.929]		07.87- 09.96 CA854IR 28 35		
		07.87- 09.96 CA1035IR 28 80	07.87- 09.96 CS198 24 6.0	
		07.87- 09.96 CA333IR 28 55	07.87- 09.96 CS191 24 5.4	
[OM445.930]		07.87- 09.96 CA854IR 28 35		
		07.87- 09.96 CA1035IR 28 80	07.87- 09.96 CS198 24 6.0	
		07.87- 09.96 CA333IR 28 55	07.87- 09.96 CS191 24 5.4	
		07.87- 09.96 CA854IR 28 35		
		07.87- 09.96 CA1035IR 28 80	07.87- 09.96 CS198 24 6.0	
		07.87- 09.96 CA333IR 28 55	07.87- 09.96 CS191 24 5.4	
2531 11.9	(Actros)[OM541.920]	09.96- 10.02 CA1505IR 28 100	09.96- 10.02 CS1463 24 6.2 MI	
		09.96- 10.02 CA1593IR 28 80	09.96- 10.02 CS1077 24 6.2	
		09.96- 10.02 CA1666IR 28 80	AC 09.96- 10.02 CS1168# 24 7.8	
		09.96- 10.02 CA1739IR 28 100	09.96- 10.02 CS1269 24 6.2 BO	
	[OM541.922]	09.96- 10.02 CA1505IR 28 100	09.96- 10.02 CS1269 24 6.2 BO	
		09.96- 10.02 CA1593IR 28 80	09.96- 10.02 CS1463 24 6.2 MI	
		09.96- 10.02 CA1666IR 28 80	AC 09.96- 10.02 CS1168# 24 7.8	
		09.96- 10.02 CA1739IR 28 100	09.96- 10.02 CS1077 24 6.2	
	[OM541.940]	09.96- 10.02 CA1505IR 28 100	09.96- 10.02 CS1463 24 6.2 MI	
		09.96- 10.02 CA1593IR 28 80	09.96- 10.02 CS1077 24 6.2	
		09.96- 10.02 CA1666IR 28 80	AC 09.96- 10.02 CS1168# 24 7.8	
		09.96- 10.02 CA1739IR 28 100	09.96- 10.02 CS1269 24 6.2 BO	
[OM541.942]	09.96- 10.02 CA1505IR 28 100	09.96- 10.02 CS1077 24 6.2		
	09.96- 10.02 CA1593IR 28 80	AC 09.96- 10.02 CS1168# 24 7.8		
	09.96- 10.02 CA1666IR 28 80	09.96- 10.02 CS1269 24 6.2 BO		
	09.96- 10.02 CA1739IR 28 100	09.96- 10.02 CS1463 24 6.2 MI		
2531 9.6	(MK)[OM401.972]	12.87- 02.01 CA1035IR 28 80	12.87- 02.01 CS191 24 5.4	
		12.87- 02.01 CA333IR 28 55		
		12.87- 02.01 CA854IR 28 35		
		12.90- 02.01 CA568IR 28 30		
	[OM401.979]	12.87- 02.01 CA1035IR 28 80	12.87- 02.01 CS191 24 5.4	
		12.87- 02.01 CA333IR 28 55		
		12.87- 02.01 CA854IR 28 35		
		12.90- 02.01 CA568IR 28 30		
	[OM401.993]	12.87- 09.96 CA1035IR 28 80	12.87- 09.96 CS191 24 5.4	
		12.87- 09.96 CA333IR 28 55		
		12.87- 09.96 CA854IR 28 35		
		12.90- 02.01 CA568IR 28 30		
	(SK)[OM401.979]	07.87- 09.96 CA1035IR 28 80	07.87- 09.96 CS198 24 6.0	
		07.87- 09.96 CA333IR 28 55	07.87- 09.96 CS191 24 5.4	
		07.87- 09.96 CA854IR 28 35		
		07.87- 09.96 CA1035IR 28 80	07.87- 09.96 CS191 24 5.4	
	[OM401.986]	07.87- 09.96 CA333IR 28 55		
		07.87- 09.96 CA854IR 28 35		
07.87- 09.96 CA1035IR 28 80		07.87- 09.96 CS191 24 5.4		
07.87- 09.96 CA333IR 28 55				
[OM401.993]	07.87- 09.96 CA854IR 28 35			
	07.87- 09.96 CA1035IR 28 80	07.87- 09.96 CS191 24 5.4		
	07.87- 09.96 CA333IR 28 55			
	07.87- 09.96 CA854IR 28 35			
2532 11.9	(Actros)[OM541.920]	04.03- CA1505IR 28 100	04.03- CS1077 24 6.2	
		04.03- CA1593IR 28 80	04.03- CS1269 24 6.2 BO	
		04.03- CA1666IR 28 80	04.03- CS1463 24 6.2 MI	
		04.03- CA1739IR 28 100		
	[OM541.940]	04.03- CA1505IR 28 100	04.03- CS1463 24 6.2 MI	
		04.03- CA1593IR 28 80	04.03- CS1269 24 6.2 BO	
		04.03- CA1666IR 28 80	04.03- CS1077 24 6.2	
		04.03- CA1739IR 28 100		
(Actros MP2 / MP3)	06.08- CA1739IR 28 100			
	10.04- CA1593IR 28 80	10.04- CS1112 24 4.0		
2533 7.2	(Axor 2)[OM926.913]	10.04- CA1593IR 28 80	10.04- CS1112 24 4.0	
	[OM926.919]	10.04- CA1593IR 28 80	10.04- CS1112 24 4.0	
	[OM926.921]	10.04- CA1593IR 28 80	10.04- CS1112 24 4.0	
	[OM926.945]	10.04- CA1593IR 28 80	10.04- CS1112 24 4.0	
	[OM926.990]	10.04- CA1593IR 28 80	10.04- CS1112 24 4.0	
		10.04- CA1593IR 28 80	10.04- CS1112 24 4.0	
2534 11.0	(MK)[OM441.986]	01.91- 02.01 CA1035IR 28 80	01.91- 02.01 CS191 24 5.4	
		01.91- 02.01 CA333IR 28 55		
		01.91- 02.01 CA568IR 28 30		
		03.91- 02.01 CA854IR 28 35		
	[OM441.987]	03.91- 01.01 CA1035IR 28 80	03.91- 01.01 CS191 24 5.4	
		03.91- 01.01 CA333IR 28 55		
		03.91- 01.01 CA854IR 28 35		
		03.91- 01.01 CA854IR 28 35		
	[OM441.989]	01.91- 02.01 CA1035IR 28 80	01.91- 02.01 CS191 24 5.4	
		01.91- 02.01 CA333IR 28 55		
		01.91- 02.01 CA568IR 28 30		
		03.91- 02.01 CA854IR 28 35		
	[OM441.991]	03.91- 09.96 CA1035IR 28 80	01.91- 09.96 CS191 24 5.4	
		03.91- 09.96 CA333IR 28 55		
		03.91- 09.96 CA854IR 28 35		
		03.91- 09.96 CA854IR 28 35		
	[OM445.920]	12.87- 01.01 CA1035IR 28 80	12.87- 01.01 CS191 24 5.4	
		01.94- 01.01 CA333IR 28 55		
01.94- 01.01 CA568IR 28 30				
03.94- 01.01 CA854IR 28 35				
[OM445.921]	01.94- 01.01 CA1035IR 28 80	01.94- 01.01 CS191 24 5.4		
	01.94- 01.01 CA333IR 28 55			
	01.94- 01.01 CA854IR 28 35			
	01.94- 01.01 CA854IR 28 35			
[OM445.922]	01.94- 01.01 CA1035IR 28 80	01.91- 01.01 CS191 24 5.4		
	01.94- 01.01 CA333IR 28 55			
	01.94- 01.01 CA854IR 28 35			
	01.94- 01.01 CA854IR 28 35			



	[OM445.929]	12.87- 09.96	CA1035IR	28 80	12.87- 09.96	CS198	24 6.0
		12.87- 09.96	CA333IR	28 55	12.87- 09.96	CS191	24 5.4
		12.87- 09.96	CA854IR	28 35			
	(SK)[OM441.986]	07.87- 09.96	CA1035IR	28 80	07.87- 09.96	CS191	24 5.4
		07.87- 09.96	CA333IR	28 55			
		07.87- 09.96	CA854IR	28 35			
	[OM441.996]	07.87- 09.96	CA1035IR	28 80	07.87- 09.96	CS191	24 5.4
		07.87- 09.96	CA333IR	28 55			
		07.87- 09.96	CA854IR	28 35			
	[OM445.920]	07.87- 09.96	CA1035IR	28 80	07.87- 09.96	CS191	24 5.4
		07.87- 09.96	CA333IR	28 55			
		07.87- 09.96	CA854IR	28 35			
	[OM445.930]	07.87- 09.96	CA1035IR	28 80	07.87- 09.96	CS191	24 5.4
		07.87- 09.96	CA333IR	28 55			
		07.87- 09.96	CA854IR	28 35			
	[OM445.939]	07.87- 09.96	CA1035IR	28 80	07.87- 09.96	CS191	24 5.4
		07.87- 09.96	CA333IR	28 55			
		07.87- 09.96	CA854IR	28 35			
2534 9.6	(MK)[OM401.974]	12.87- 09.96	CA1236IR	28 140	12.87- 09.96	CS191	24 5.4
2535 11.9	(Actros)[OM541.922]	09.96- 10.02	CA1505IR	28 100	09.96- 10.02	CS1077	24 6.2
		09.96- 10.02	CA1593IR	28 80	AC 09.96- 10.02	CS1168#	24 7.8
		09.96- 10.02	CA1666IR	28 80	09.96- 10.02	CS1269	24 6.2 BO
		09.96- 10.02	CA1739IR	28 100	09.96- 10.02	CS1463	24 6.2 MI
2535 12.0	(Axor)[OM457.937]	01.02-	CA1666IR	28 80	01.02-	CS1269	24 6.2 BO
		01.02-	CA1739IR	28 100			
	(Axor 2)[OM457.937]	10.04-	CA1739IR	28 100			
	[OM457.948]	10.04-	CA1739IR	28 100			
	[OM457.980]	10.04-	CA1739IR	28 100			
2536 11.9	(Actros)[OM541.922]	04.03-	CA1505IR	28 100	04.03-	CS1463	24 6.2 MI
		04.03-	CA1593IR	28 80	04.03-	CS1077	24 6.2
		04.03-	CA1666IR	28 80	04.03-	CS1269	24 6.2 BO
		04.03-	CA1739IR	28 100			
	[OM541.942]	04.03-	CA1505IR	28 100	04.03-	CS1269	24 6.2 BO
		04.03-	CA1593IR	28 80	04.03-	CS1463	24 6.2 MI
		04.03-	CA1666IR	28 80	04.03-	CS1077	24 6.2
		04.03-	CA1739IR	28 100			
	[OM541.943]	04.03-	CA1505IR	28 100	04.03-	CS1077	24 6.2
		04.03-	CA1593IR	28 80	04.03-	CS1463	24 6.2 MI
		04.03-	CA1666IR	28 80	04.03-	CS1269	24 6.2 BO
		04.03-	CA1739IR	28 100			
	(Actros MP2 / MP3)	06.08-	CA1739IR	28 100			
2536 12.0	(Axor 2)[OM457.937]	10.04-	CA1739IR	28 100			
	[OM457.948]	10.04-	CA1739IR	28 100			
	[OM457.980]	10.04-	CA1739IR	28 100			
2536 14.6	(NG)[OM442.950]	10.81- 03.91	CA187IR	28 27	10.81- 03.91	CS191	24 5.4
		10.81- 03.91	CA568IR	28 30			
		10.81- 03.91	CA854IR	28 35			
	[OM442.952]	10.81- 03.91	CA187IR	28 27	10.81- 03.91	CS191	24 5.4
		10.81- 03.91	CA568IR	28 30			
		10.81- 03.91	CA854IR	28 35			
	[OM442.962]	10.81- 03.91	CA187IR	28 27	10.81- 03.91	CS191	24 5.4
		10.81- 03.91	CA568IR	28 30			
		10.81- 03.91	CA854IR	28 35			
2536 18.3	(NG)[OM423.905]	10.81- 03.91	CA1035IR	28 80	10.81- 03.91	CS198	24 6.0
		10.81- 03.91	CA333IR	28 55			
		10.81- 03.91	CA854IR	28 35			
	[OM423.907]	10.81- 03.91	CA1035IR	28 80	10.81- 03.91	CS198	24 6.0
		10.81- 03.91	CA333IR	28 55			
		10.81- 03.91	CA854IR	28 35			
2538 12.8	(SK)[OM402.971]	03.91- 08.96	CA1035IR	28 80	03.91- 08.96	CS191	24 5.4
		03.91- 08.96	CA333IR	28 55			
		03.91- 08.96	CA854IR	28 35			
	[OM402.972]	03.91- 08.96	CA1035IR	28 80	03.91- 09.96	CS191	24 5.4
		03.91- 08.96	CA333IR	28 55			
		03.91- 08.96	CA568IR	28 30			
		03.91- 09.96	CA854IR	28 35			
	[OM402.975]	03.91- 08.96	CA1035IR	28 80	03.91- 08.96	CS191	24 5.4
		03.91- 08.96	CA333IR	28 55			
		03.91- 08.96	CA854IR	28 35			
	[OM402.985]	03.91- 08.96	CA333IR	28 55	03.91- 08.96	CS191	24 5.4
		03.91- 08.96	CA854IR	28 35			
	[OM402.986]	03.91- 02.01	CA333IR	28 55	03.91- 02.01	CS191	24 5.4
		03.91- 02.01	CA854IR	28 35			
	[OM402.989]	03.91- 08.96	CA333IR	28 55	03.91- 08.96	CS191	24 5.4
		03.91- 08.96	CA568IR	28 30			
		03.91- 08.96	CA854IR	28 35			
	[OM402.990]	03.91- 08.96	CA854IR	28 35	03.91- 08.96	CS191	24 5.4
2538 14.6	(SK)[OM440.970]	03.91- 09.96	CA1035IR	28 80	03.91- 09.96	CS191	24 5.4
		03.91- 08.96	CA854IR	28 35			
	[OM440.971]	03.91- 08.96	CA854IR	28 35	03.91- 08.96	CS191	24 5.4
	[OM440.978]	03.91- 08.96	CA1035IR	28 80	03.91- 02.01	CS191	24 5.4
		03.91- 02.01	CA854IR	28 35			
	[OM440.980]	03.91- 09.96	CA1035IR	28 80	03.91- 09.96	CS191	24 5.4
		03.91- 09.96	CA854IR	28 35			
	[OM440.981]	03.91- 09.96	CA854IR	28 35	03.91- 09.96	CS191	24 5.4
	[OM442.989]	03.91- 08.96	CA854IR	28 35	03.91- 08.96	CS191	24 5.4
	[OM442.997]	03.91- 08.96	CA1236IR	28 140	03.91- 09.96	CS191	24 5.4
		03.91- 09.96	CA854IR	28 35			
	[OM446.924]	01.94- 08.96	CA1035IR	28 80	01.94- 08.96	CS191	24 5.4
	[OM446.925]	01.94- 09.96	CA1035IR	28 80	01.94- 09.96	CS191	24 5.4
	[OM446.928]	01.94- 08.96	CA1035IR	28 80	01.94- 08.96	CS191	24 5.4
	[OM446.929]	01.94- 08.96	CA1035IR	28 80	01.94- 08.96	CS191	24 5.4
	[OM446.942]	01.94- 08.96	CA1035IR	28 80	01.94- 08.96	CS191	24 5.4
	[OM446.948]	01.94- 08.96	CA1035IR	28 80	01.94- 08.96	CS191	24 5.4
2540 11.9	(Actros)[OM541.923]	09.96- 10.02	CA1505IR	28 100	09.96- 10.02	CS1269	24 6.2 BO
		09.96- 10.02	CA1593IR	28 80	09.96- 10.02	CS1463	24 6.2 MI
		09.96- 10.02	CA1666IR	28 80	09.96- 10.02	CS1077	24 6.2
		09.96- 10.02	CA1739IR	28 100	AC 09.96- 10.02	CS1168#	24 7.8
	[OM541.944]	09.96- 10.02	CA1505IR	28 100	09.96- 10.02	CS1463	24 6.2 MI
		09.96- 10.02	CA1593IR	28 80	09.96- 10.02	CS1077	24 6.2
		09.96- 10.02	CA1666IR	28 80	AC 09.96- 10.02	CS1168#	24 7.8
		09.96- 10.02	CA1739IR	28 100	09.96- 10.02	CS1269	24 6.2 BO
2540 12.0	(Axor)[OM457.937]	01.02- 10.04	CA1666IR	28 80	01.02- 10.04	CS1269	24 6.2 BO
		01.02- 10.04	CA1739IR	28 100	01.02- 10.04	CS1463	24 6.2 MI
	(Axor 2)[OM457.937]	10.04-	CA1739IR	28 100			
	[OM457.948]	10.04-	CA1739IR	28 100			
	[OM457.980]	10.04-	CA1739IR	28 100			
	[OM457.981]	10.04-	CA1739IR	28 100			



MERCEDES-BENZ Continued

2541 11.9	(Actros)[OM541.944]	04.03-	CA1505IR	28 100	04.03-	CS1269	24 6.2 BO		
		04.03-	CA1593IR	28 80	04.03-	CS1463	24 6.2 MI		
		04.03-	CA1666IR	28 80	04.03-	CS1077	24 6.2		
		04.03-	CA1739IR	28 100					
(Actros MP2 / MP3)[OM541.974]		06.08-	CA1593IR	28 80					
2543 11.9	(Actros)[OM541.925]	09.96- 10.02	CA1505IR	28 100	09.96- 10.02	CS1463	24 6.2 MI		
		09.96- 10.02	CA1593IR	28 80	09.96- 10.02	CS1269	24 6.2 BO		
		09.96- 10.02	CA1666IR	28 80	09.96- 10.02	CS1077	24 6.2		
		09.96- 10.02	CA1739IR	28 100	AC 09.96- 10.02	CS1168#	24 7.8		
	[OM541.946]	09.96- 10.02	CA1505IR	28 100	09.96- 10.02	CS1077	24 6.2		
		09.96- 10.02	CA1593IR	28 80	AC 09.96- 10.02	CS1168#	24 7.8		
		09.96- 10.02	CA1666IR	28 80	09.96- 10.02	CS1269	24 6.2 BO		
09.96- 10.02	CA1739IR	28 100	09.96- 10.02	CS1463	24 6.2 MI				
2543 12.0	(Axor)[OM457.937]	01.02- 10.04	CA1666IR	28 80	01.02- 10.04	CS1463	24 6.2 MI		
		01.02- 10.04	CA1739IR	28 100	01.02- 10.04	CS1269	24 6.2 BO		
	(Axor 2)[OM457.937]	10.04-	CA1739IR	28 100					
	[OM457.948]	10.04-	CA1739IR	28 100					
	[OM457.980]	10.04-	CA1739IR	28 100					
2544 11.9	(Actros)[OM541.946]	04.03-	CA1505IR	28 100	04.03-	CS1077	24 6.2		
		04.03-	CA1593IR	28 80	04.03-	CS1463	24 6.2 MI		
		04.03-	CA1666IR	28 80	04.03-	CS1269	24 6.2 BO		
		04.03-	CA1739IR	28 100					
(Actros MP2 / MP3)[OM541.976]		06.08-	CA1739IR	28 100					
2544 14.6	(SK)[OM440.970]	07.88- 09.96	CA1035IR	28 80	07.88- 09.96	CS191	24 5.4		
		07.88- 09.96	CA333IR	28 55					
		07.88- 09.96	CA854IR	28 35					
	[OM440.972]	01.92-	CA1035IR	28 80	01.92-	CS191	24 5.4		
	[OM440.978]	01.92- 09.96	CA333IR	28 55					
		01.92-	CA854IR	28 35					
		01.92- 09.96	CA1035IR	28 80	01.92- 09.96	CS191	24 5.4		
	[OM446.922]	01.92- 09.96	CA333IR	28 55					
		01.92- 09.96	CA854IR	28 35					
		01.92- 09.96	CA1035IR	28 80	01.92- 09.96	CS191	24 5.4		
01.92- 09.96		CA333IR	28 55						
[OM446.942]	01.92- 09.96	CA854IR	28 35						
2546 11.9	(Actros)[OM541.948]	04.03-	CA1593IR	28 80	04.03-	CS1269	24 6.2 BO		
		04.03-	CA1666IR	28 80	04.03-	CS1463	24 6.2 MI		
		04.03-	CA1739IR	28 100					
		06.08-	CA1739IR	28 100					
(Actros MP2 / MP3)		06.08-	CA1739IR	28 100					
2548 11.9	(Actros)[OM541.948]	04.03-	CA1666IR	28 80	04.03-	CS1463	24 6.2 MI		
		04.03-	CA1739IR	28 100	04.03-	CS1269	24 6.2 BO		
		(Actros MP2 / MP3)[OM541.948]		04.03-	CA1739IR	28 100	04.03-	CS1269	24 6.2
		[OM541.978]	04.03-	CA1739IR	28 100	04.03-	CS1269	24 6.2	
2548 15.9	(Actros)[OM542.921]	09.96- 10.02	CA1505IR	28 100	AC 09.96- 10.02	CS1168#	24 7.8		
		09.96- 10.02	CA1593IR	28 80	09.96- 10.02	CS1463	24 6.2 MI		
		09.96- 10.02	CA1666IR	28 80	09.96- 10.02	CS1077	24 6.2		
		09.96- 10.02	CA1739IR	28 100	09.96- 10.02	CS1269	24 6.2 BO		
	2550 14.6	(SK)[OM440.971]	01.91- 09.96	CA1035IR	28 80	01.91- 09.96	CS191	24 5.4	
			01.91- 09.96	CA333IR	28 55				
			01.91- 09.96	CA854IR	28 35				
		[OM440.973]	01.91- 09.96	CA1035IR	28 80	01.91- 09.96	CS191	24 5.4	
		[OM440.981]	01.91- 09.96	CA333IR	28 55				
			01.91- 09.96	CA854IR	28 35				
07.87- 09.96	CA1035IR		28 80	07.87- 09.96	CS191	24 5.4			
[OM440.998]	07.87- 09.96	CA1236IR	28 140						
	07.87- 09.96	CA333IR	28 55						
	07.87- 09.96	CA823IR#	28 120						
	07.87- 09.96	CA854IR	28 35						
	01.91- 09.96	CA1236IR	28 140	01.91-	CS191	24 5.4			
[OM442.989]	07.91-	CA1035IR	28 80						
	07.91-	CA333IR	28 55						
	07.91-	CA854IR	28 35						
	07.87- 09.96	CA1035IR	28 80	07.87- 09.96	CS191	24 5.4			
	07.87- 09.96	CA1236IR	28 140						
	07.87- 09.96	CA333IR	28 55						
	07.87- 09.96	CA823IR#	28 120						
	07.87- 09.96	CA854IR	28 35						
[OM442.997]	07.87- 09.96	CA1035IR	28 80	07.87- 09.96	CS191	24 5.4			
	07.87- 09.96	CA1236IR	28 140						
	07.87- 09.96	CA333IR	28 55						
	07.87- 09.96	CA823IR#	28 120						
[OM442.998]	07.87- 09.96	CA854IR	28 35						
	07.91- 08.96	CA1035IR	28 80	01.91- 08.96	CS191	24 5.4			
	07.91- 08.96	CA333IR	28 55						
07.91- 08.96	CA854IR	28 35							
[OM446.920]	01.94- 08.96	CA1035IR	28 80	01.94- 08.96	CS191	24 5.4			
2550 15.9	(Actros MP2 / MP3)[OM542.940]	04.03-	CA1505IR	28 100					
		04.03-	CA1593IR	28 80					
2551 15.9	(Actros MP2 / MP3)[OM542.960]	04.03-	CA1739IR	28 100					
2551 16.0	(Actros)[OM542.960]	04.03-	CA1666IR	28 80	04.03-	CS1269	24 6.2 BO		
		04.03-	CA1739IR	28 100	04.03-	CS1463	24 6.2 MI		
2553 14.6	(SK)[OM446.920]	01.96- 08.96	CA1035IR	28 80	01.96- 08.96	CS191	24 5.4		
2553 15.9	(Actros)[OM542.920]	09.96- 10.02	CA1505IR	28 100	09.96- 10.02	CS1077	24 6.2		
		09.96- 10.02	CA1593IR	28 80	09.96- 10.02	CS1269	24 6.2 BO		
		09.96- 10.02	CA1666IR	28 80	AC 09.96- 10.02	CS1168#	24 7.8		
09.96- 10.02	CA1739IR	28 100	09.96- 10.02	CS1463	24 6.2 MI				
2554 15.9	(Actros MP2 / MP3)[OM542.942]	04.03-	CA1505IR	28 100					
2555 15.9	(Actros MP2 / MP3)[OM542.962]	04.03-	CA1739IR	28 100					
2555 16.0	(Actros)[OM542.962]	09.05-	CA1666IR	28 80	09.05-	CS1269	24 6.2 BO		
		09.05-	CA1739IR	28 100	09.05-	CS1077	24 6.2		
					09.05-	CS1463	24 6.2 MI		
2557 15.9	(Actros)[OM542.922]	09.96- 10.02	CA1505IR	28 100	AC 09.96- 10.02	CS1168#	24 7.8		
		09.96- 10.02	CA1593IR	28 80	09.96- 10.02	CS1463	24 6.2 MI		
		09.96- 10.02	CA1666IR	28 80	09.96- 10.02	CS1269	24 6.2 BO		
		09.96- 10.02	CA1739IR	28 100	09.96- 10.02	CS1077	24 6.2		
2558 15.9	(Actros MP2 / MP3)[OM542.944]	04.03-	CA1505IR	28 100					
2560 15.9	(Actros MP2 / MP3)[OM542.964]	04.03-	CA1739IR	28 100					
2626 12.8	(NG)[OM402.906]	11.79- 12.81	CA187IR	28 27	03.77- 12.81	CS191	24 5.4		
					08.73- 02.77	CS198	24 6.0		





	[OM402.912]	11.79- 12.81	CA1871R	28 27	08.73- 02.77 03.77- 12.81	CS198 CS191	24 6.0 24 5.4
	[OM402.916]	11.79- 03.81	CA1871R	28 27	03.77- 03.81 06.75- 02.77	CS191 CS198	24 5.4 24 6.0
	[OM402.926]	11.79- 12.80	CA1871R	28 27	05.74- 02.77 03.77- 12.80	CS198 CS191	24 6.0 24 5.4
2628 14.6	(NG)[OM422.905]	02.80- 10.86 11.86- 03.91 11.86- 03.91	CA1871R CA3331R CA5681R	28 27 28 55 28 30	05.83- 03.91 02.80- 03.91	CS198 CS191	24 6.0 24 5.4
	[OM422.907]	02.80- 10.86 11.86- 03.91 11.86- 03.91	CA1871R CA3331R CA5681R	28 27 28 55 28 30	02.80- 03.91 05.83- 03.91	CS191 CS198	24 5.4 24 6.0
	[OM422.911]	02.80- 10.86 11.86- 03.91 11.86- 03.91	CA1871R CA3331R CA5681R	28 27 28 55 28 30	02.80- 03.91 05.83- 03.91	CS191 CS198	24 5.4 24 6.0
	[OM422.913]	02.80- 10.86 11.86- 03.91 11.86- 03.91	CA1871R CA3331R CA5681R	28 27 28 55 28 30	02.80- 03.91 05.83- 03.91	CS191 CS198	24 5.4 24 6.0
2628 18.3	(NG)[OM443.940]	01.90- 03.91 01.90- 03.91	CA3331R CA5681R	28 55 28 30	01.90- 03.91	CS198	24 6.0
2628 6.4	(Atego)[OM906.921]	05.98- 09.04 05.98- 09.04	CA15051R CA15931R	28 100 28 80	05.98- 09.04 05.98- 09.04	CS1112 CS1381	24 4.0 BO 24 4.0 DR
	(Axor)[OM902.915]	10.04- 10.04-	CA16661R CA17391R	28 80 28 100	10.04-	CS1112	24 4.0
	[OM906.921]	01.02- 08.06 01.02- 08.06 01.02- 08.06 01.02- 08.06	CA15051R CA15931R CA16661R CA17391R	28 100 28 80 28 80 28 100	01.02- 09.06	CS1112	24 4.0
	[OM906.926]	10.04- 10.04-	CA16661R CA17391R	28 80 28 100	10.04-	CS1112	24 4.0
	(Econic)[OM906.941]	01.98- 03.98- 03.01 03.98- 03.01 03.98- 03.01	CA16661R CA15051R CA15931R CA16591R	28 80 28 100 28 80 28 140	01.98- 03.01 01.98- 03.01	CS1381 CS1112	24 4.0 DR 24 4.0 BO
	[OM906.952]	01.98- 03.98- 03.01 03.98- 03.01 03.98- 03.01	CA16661R CA15051R CA15931R CA16591R	28 80 28 100 28 80 28 140	01.98- 03.01 01.98- 03.01	CS1381 CS1112	24 4.0 DR 24 4.0 BO
2628 6.9	(Econic)[M906.900]	10.00- 10.00-	CA15051R CA15931R	28 100 28 80	10.00-	CS1112	24 4.0
2629 12.8	(SK)[OM402.982]	07.88- 08.94 07.88- 08.94	CA10351R CA8541R	28 80 28 35	07.88- 08.94	CS191	24 5.4
2629 14.6	(SK)[OM440.970]	07.88- 08.94	CA8541R	28 35	07.88- 08.94	CS191	24 5.4
	[OM440.971]	07.88- 08.94	CA8541R	28 35	07.88- 08.94	CS191	24 5.4
	[OM442.942]	07.88- 08.94 07.88- 08.94 07.88- 08.94	CA10351R CA3331R CA8541R	28 80 28 55 28 35	07.88- 08.94	CS191	24 5.4
	[OM442.959]	07.88- 08.94 07.88- 08.94 07.88- 08.94	CA10351R CA3331R CA8541R	28 80 28 55 28 35	07.88- 08.94	CS191	24 5.4
	[OM442.966]	07.88- 08.94 07.88- 08.94 07.88- 08.94	CA10351R CA3331R CA8541R	28 80 28 55 28 35	07.88- 08.94	CS191	24 5.4
	[OM442.989]	07.88- 08.94 07.88- 08.94 07.88- 08.94	CA10351R CA3331R CA8541R	28 80 28 55 28 35	07.88- 08.94	CS191	24 5.4
	[OM442.997]	07.88- 08.94 07.88- 08.94 07.88- 08.94	CA10351R CA3331R CA8541R	28 80 28 55 28 35	07.88- 08.94	CS191	24 5.4
2629 15.1	(SK)[OM442.906]	07.88- 08.94 07.88- 08.94	CA10351R CA8541R	28 80 28 35	07.88- 08.94	CS191	24 5.4
	[OM442.907]	07.88- 08.94 07.88- 08.94 07.88- 08.94	CA10351R CA3331R CA8541R	28 80 28 55 28 35	07.88- 08.94	CS191	24 5.4
	[OM442.917]	07.88- 08.94 07.88- 08.94	CA10351R CA8541R	28 80 28 35	07.88- 08.94	CS191	24 5.4
	[OM442.925]	07.88- 08.94 07.88- 08.94 07.88- 08.94	CA10351R CA3331R CA8541R	28 80 28 55 28 35	07.88- 08.94	CS191	24 5.4
	[OM442.926]	07.88- 08.94 07.88- 08.94 07.88- 08.94	CA10351R CA3331R CA8541R	28 80 28 55 28 35	07.88- 08.94	CS191	24 5.4
	[OM442.929]	07.88- 08.94 07.88- 08.94 07.88- 08.94	CA10351R CA3331R CA8541R	28 80 28 55 28 35	07.88- 08.94	CS191	24 5.4
2629 18.3	(SK)[OM443.940]	07.88- 08.94 07.88- 08.94 07.88- 08.94	CA10351R CA3331R CA8541R	28 80 28 55 28 35	07.88- 08.94	CS191	24 5.4
2629 4.1	(SK)[OM442.906]	07.88- 08.94 10.88- 08.94	CA8541R CA10351R	28 35 28 80	07.88- 08.94	CS191	24 5.4
2629 6.4	(Axor)[OM902.915]	10.04- 10.04-	CA16661R CA17391R	28 80 28 100	10.04-	CS1112	24 4.0
	[OM906.921]	10.04- 10.04-	CA16661R CA17391R	28 80 28 100	10.04-	CS1112	24 4.0
	[OM906.926]	10.04- 10.04-	CA16661R CA17391R	28 80 28 100	10.04-	CS1112	24 4.0
2629 9.6	(SK)[OM401.979]	07.88- 08.94	CA3331R	28 55	07.88- 08.94	CS191	24 5.4
2631 11.0	(SK)[OM441.998]	07.88- 09.96 06.92- 09.96	CA8541R CA3331R	28 35 28 55	07.88- 09.96	CS191	24 5.4
	[OM445.920]	06.92- 09.96 06.92- 08.96 06.92- 09.96	CA10351R CA3331R CA8541R	28 80 28 55 28 35	01.94- 08.96	CS191	24 5.4
	[OM445.929]	07.88- 09.96 07.88- 09.96 06.92- 09.96	CA10351R CA8541R CA3331R	28 80 28 35 28 55	07.88- 09.96	CS191	24 5.4
	[OM445.930]	06.92- 09.96 06.92- 09.96 06.92- 09.96	CA10351R CA3331R CA8541R	28 80 28 55 28 35	01.94- 09.96	CS191	24 5.4
	[OM445.931]	06.92- 09.96 06.92- 09.96 06.92- 09.96	CA10351R CA3331R CA8541R	28 80 28 55 28 35	06.92- 09.96	CS191	24 5.4
2631 11.9	(Actros)[OM541.920]	04.96- 10.02 04.96- 10.02 04.96- 10.02 04.96- 10.02	CA15051R CA15931R CA16661R CA17391R	28 100 28 80 28 80 28 100	04.96- 10.02 04.96- 10.02 04.96- 10.02 AC 04.96- 10.02	CS1269 CS1463 CS1077 CS1168#	24 6.2 BO 24 6.2 MI 24 6.2 24 7.8
2631 9.6	(SK)[OM401.972]	06.92- 09.96 06.92- 09.96	CA10351R CA8541R	28 80 28 35	06.92- 09.96	CS191	24 5.4
	[OM401.979]	07.88- 09.96 07.88- 08.94 07.88- 08.94	CA10351R CA3331R CA8541R	28 80 28 55 28 35	07.88- 09.96	CS191	24 5.4



**MERCEDES-BENZ** *Continued*

	[OM401.981]	06.92- 09.96	CA1035IR	28 80		06.92- 09.96	CS191	24 5.4
		06.92- 09.96	CA854IR	28 35				
	[OM401.986]	06.92- 08.96	CA1035IR	28 80		06.92- 08.96	CS191	24 5.4
		06.92- 08.96	CA854IR	28 35				
	[OM401.987]	06.92- 09.96	CA1035IR	28 80		06.92- 08.96	CS191	24 5.4
		06.92- 09.96	CA333IR	28 55				
		06.92- 09.96	CA854IR	28 35				
	[OM401.993]	06.92- 09.96	CA1035IR	28 80		06.92- 09.96	CS191	24 5.4
		06.92- 09.96	CA333IR	28 55				
		06.92- 09.96	CA854IR	28 35				
2632 11.9	(Actros)[OM541.940]	04.03-	CA1505IR	28 100		04.03-	CS1463	24 6.2 MI
		04.03-	CA1593IR	28 80		04.03-	CS1077	24 6.2
		04.03-	CA1666IR	28 80		04.03-	CS1269	24 6.2 BO
		04.03-	CA1739IR	28 100				
	[OM541.970]	04.03-	CA1505IR	28 100		04.03-	CS1463	24 6.2 MI
		04.03-	CA1593IR	28 80		04.03-	CS1077	24 6.2
		04.03-	CA1666IR	28 80		04.03-	CS1269	24 6.2 BO
		04.03-	CA1739IR	28 100				
2632 15.9	(NG)[OM403.916]	03.78- 09.83	CA187IR	28 27		08.73- 09.83	CS198	24 6.0
	[OM403.931]	03.78- 09.83	CA187IR	28 27		08.73- 09.83	CS198	24 6.0
	[OM403.932]	03.78- 09.83	CA187IR	28 27		05.74- 09.83	CS198	24 6.0
	[OM403.935]	03.78- 09.83	CA187IR	28 27		08.73- 09.83	CS198	24 6.0
2633 14.6	(NG)[OM422.952]	05.82- 10.86	CA187IR	28 27		05.82- 05.87	CS198	24 6.0
		11.86- 05.87	CA333IR	28 55				
		11.86- 05.87	CA568IR	28 30				
	[OM422.954]	05.82- 10.86	CA187IR	28 27		05.82- 05.87	CS198	24 6.0
		11.86- 05.87	CA333IR	28 55				
		11.86- 05.87	CA568IR	28 30				
	[OM422.956]	05.82- 10.87	CA187IR	28 27		05.82- 05.87	CS198	24 6.0
		11.86- 05.87	CA333IR	28 55				
		11.86- 05.87	CA568IR	28 30				
2633 6.4	(Econic)							
2633 7.2	(Axor)[OM926.913]	10.04- 08.06	CA1666IR	28 80		10.04- 08.06	CS1112	24 4.0
		10.04- 08.06	CA1739IR	28 100				
	(Axor 2)[OM926.913]	10.04-	CA1505IR	28 100				
	[OM926.919]	10.04-	CA1505IR	28 100				
	[OM926.945]	10.04-	CA1505IR	28 100				
	(Econic)[OM926.921]						CS1112	24 4.0
	[OM926.934]					10.01-	CS1112	24 4.0
2634 11.0	(SK)[OM441.986]	06.92- 09.96	CA1035IR	28 80		06.92- 09.96	CS191	24 5.4
		06.92- 09.96	CA333IR	28 55				
		06.92- 09.96	CA854IR	28 35				
	[OM445.920]					06.92- 09.96	CS191	24 5.4
	[OM445.930]					01.94-	CS191	24 5.4
2634 9.6	(SK)[OM401.986]	06.92- 08.96	CA1035IR	28 80		06.92- 08.96	CS191	24 5.4
		06.92- 08.96	CA854IR	28 35				
2635 11.9	(Actros)[OM541.922]	04.96- 10.02	CA1505IR	28 100	AC	04.96- 10.02	CS1168#	24 7.8
		04.96- 10.02	CA1593IR	28 80		04.96- 10.02	CS1463	24 6.2 MI
		04.96- 10.02	CA1666IR	28 80		04.96- 10.02	CS1269	24 6.2 BO
		04.96- 10.02	CA1739IR	28 100		04.96- 10.02	CS1077	24 6.2
2635 12.8	(SK)[OM402.971]	01.91- 08.94	CA1035IR	28 80		01.91- 08.94	CS191	24 5.4
		01.91- 08.94	CA333IR	28 55				
		01.91- 08.94	CA854IR	28 35				
2635 14.6	(NG)[OM442.950]	04.86- 10.86	CA187IR	28 27		04.86- 03.91	CS191	24 5.4
		11.86- 03.91	CA333IR	28 55				
		11.86- 03.91	CA568IR	28 30				
	[OM442.952]	04.86- 10.86	CA187IR	28 27		04.86- 03.91	CS191	24 5.4
		11.86- 03.91	CA333IR	28 55				
		11.86- 03.91	CA568IR	28 30				
	[OM442.962]	09.87- 03.91	CA854IR	28 35		09.87- 03.91	CS191	24 5.4
		10.88- 03.91	CA1035IR	28 80				
	(SK)[OM440.940]	07.88- 08.94	CA1035IR	28 80		07.88- 08.94	CS191	24 5.4
		03.91- 08.94	CA854IR	28 35				
	[OM440.941]	03.91- 08.94	CA854IR	28 35		02.90- 08.94	CS191	24 5.4
	[OM440.942]	03.91- 08.94	CA854IR	28 35		02.90- 08.94	CS191	24 5.4
	[OM440.970]	07.91- 08.94	CA854IR	28 35		07.91- 08.94	CS191	24 5.4
	[OM440.971]	12.91- 08.94	CA854IR	28 35		02.90- 08.94	CS191	24 5.4
	[OM440.973]	12.91- 08.94	CA854IR	28 35		02.90- 08.94	CS191	24 5.4
	[OM442.942]	02.90- 08.94	CA1035IR	28 80		02.90- 08.94	CS191	24 5.4
		02.90- 08.94	CA854IR	28 35				
	[OM442.944]	07.88- 08.94	CA854IR	28 35		07.88- 08.94	CS191	24 5.4
		10.88- 08.94	CA1035IR	28 80				
	[OM442.964]	07.88- 08.94	CA854IR	28 35		07.88- 08.94	CS191	24 5.4
		10.88- 08.94	CA1035IR	28 80				
	[OM442.966]	07.88- 08.94	CA854IR	28 35		07.88- 08.94	CS191	24 5.4
		10.88- 08.94	CA1035IR	28 80				
	[OM442.972]	02.90- 08.94	CA1035IR	28 80		02.90- 08.94	CS191	24 5.4
		02.90- 08.94	CA854IR	28 35				
	[OM442.976]	07.88- 08.94	CA333IR	28 55		07.88- 08.94	CS191	24 5.4
		07.88- 08.94	CA854IR	28 35				
		10.88- 08.94	CA1035IR	28 80				
	[OM442.989]	07.88- 09.96	CA1035IR	28 80		07.88- 08.94	CS191	24 5.4
		07.88- 08.94	CA333IR	28 55				
		07.88- 09.96	CA854IR	28 35				
	[OM442.994]	07.88- 08.94	CA1035IR	28 80		07.88- 08.94	CS191	24 5.4
		07.88- 08.94	CA333IR	28 55				
		07.88- 08.94	CA854IR	28 35				
	[OM442.997]	07.88- 08.94	CA1035IR	28 80		07.88- 08.94	CS191	24 5.4
		07.88- 08.94	CA333IR	28 55				
		07.88- 08.94	CA854IR	28 35				
2635 15.1	(SK)[OM442.909]	07.88- 08.94	CA1035IR	28 80		07.88- 08.94	CS191	24 5.4
		07.88- 08.94	CA333IR	28 55				
		07.88- 08.94	CA854IR	28 35				
	[OM442.923]	07.88- 08.94	CA1035IR	28 80		07.88- 08.94	CS191	24 5.4
		07.88- 08.94	CA333IR	28 55				
		07.88- 08.94	CA854IR	28 35				
2636 11.9	(Actros)[OM541.942]	04.03-	CA1505IR	28 100		04.03-	CS1077	24 6.2 MI
		04.03-	CA1593IR	28 80		04.03-	CS1463	24 6.2 MI
		04.03-	CA1666IR	28 80		04.03-	CS1269	24 6.2 BO
		04.03-	CA1739IR	28 100				
	[OM541.972]	04.03-	CA1505IR	28 100		04.03-	CS1463	24 6.2 MI
		04.03-	CA1593IR	28 80		04.03-	CS1077	24 6.2
		04.03-	CA1666IR	28 80		04.03-	CS1269	24 6.2 BO
		04.03-	CA1739IR	28 100				
2636 12.0	(Axor)[OM457.937]	10.04-	CA1666IR	28 80		10.04-	CS1269	24 6.2 BO
		10.04-	CA1739IR	28 100		10.04-	CS1463	24 6.2 MI
	[OM457.948]	10.04-	CA1666IR	28 80		10.04-	CS1463	24 6.2 MI
		10.04-	CA1739IR	28 100		10.04-	CS1269	24 6.2 BO
	(Axor 2)[OM457.937]	10.04-	CA1739IR	28 100				



2636 18.3	(NG)[OM423.905]	11.81- 10.86	CA1871R	28 27	11.81- 03.91	CS198	24 6.0	
		11.86- 03.91	CA3331R	28 55				
		11.86- 03.91	CA5681R	28 30				
	[OM423.907]	11.81- 10.86	CA1871R	28 27	11.81- 03.91	CS198	24 6.0	
		11.86- 03.91	CA3331R	28 55				
		11.86- 03.91	CA5681R	28 30				
[OM443.940]	11.81- 10.86	CA1871R	28 27	11.81- 03.91	CS198	24 6.0		
	11.86- 03.91	CA3331R	28 55					
	11.86- 03.91	CA5681R	28 30					
2638 12.8	(SK)[OM402.971]	09.91- 08.96	CA10351R	28 80	09.91- 08.96	CS191	24 5.4	
		09.91- 08.96	CA3331R	28 55				
		09.91- 08.96	CA8541R	28 35				
	[OM402.972]	09.91- 08.96	CA10351R	28 80	09.91- 08.96	CS191	24 5.4	
		09.91- 08.96	CA3331R	28 55				
		09.91- 08.96	CA8541R	28 35				
	[OM402.975]	09.91- 09.96	CA10351R	28 80	09.91- 09.96	CS191	24 5.4	
		09.91- 09.96	CA3331R	28 55				
		09.91- 09.96	CA8541R	28 35				
	[OM402.978]	09.91- 09.96	CA10351R	28 80	09.91- 09.96	CS191	24 5.4	
		09.91- 09.96	CA3331R	28 55				
		09.91- 09.96	CA8541R	28 35				
	[OM402.985]	03.91- 09.96	CA10351R	28 80	09.91- 08.96	CS191	24 5.4	
		03.91- 08.96	CA3331R	28 55				
		03.91- 09.96	CA8541R	28 35				
	[OM402.986]	03.91- 09.96	CA10351R	28 80	09.91- 08.96	CS191	24 5.4	
		03.91- 08.96	CA3331R	28 55				
		03.91- 09.96	CA8541R	28 35				
[OM402.996]	09.91- 09.96	CA10351R	28 80	09.91- 09.96	CS191	24 5.4		
	09.91- 09.96	CA3331R	28 55					
	09.91- 09.96	CA8541R	28 35					
2638 14.6	(NG)[OM422.953]	01.81- 10.86	CA1871R	28 27	01.81- 12.86	CS198	24 6.0	
		06.85- 12.86	CA8541R	28 35				
		11.86- 12.86	CA3331R	28 55				
		11.86- 12.86	CA5681R	28 30				
		01.81- 10.86	CA1871R	28 27				
		06.85- 12.86	CA8541R	28 35				
	[OM422.955]	06.85- 12.86	CA8541R	28 35	01.81- 12.86	CS198	24 6.0	
		11.86- 12.86	CA3331R	28 55				
		11.86- 12.86	CA5681R	28 30				
		01.81- 05.85	CA1871R	28 27				
		06.85- 12.86	CA8541R	28 35				
		11.86- 12.86	CA3331R	28 55				
	(SK)[OM440.970]	09.91- 09.96	CA8541R	28 35	09.91- 09.96	CS191	24 5.4	
		09.91- 08.96	CA8541R	28 35				
		07.92- 09.96	CA8541R	28 35				
	[OM440.979]	07.92- 09.96	CA8541R	28 35	07.92- 09.96	CS191	24 5.4	
	[OM440.981]	09.91- 08.96	CA8541R	28 35	09.91- 08.96	CS191	24 5.4	
	[OM440.982]	07.92- 08.96	CA8541R	28 35	07.92- 08.96	CS191	24 5.4	
	[OM440.990]	09.91- 08.96	CA8541R	28 35	09.91- 08.96	CS191	24 5.4	
	[OM442.989]	09.91- 09.96	CA10351R	28 80	09.91-	CS191	24 5.4	
		09.91- 08.96	CA3331R	28 55				
		09.91- 09.96	CA8541R	28 35				
	[OM442.997]	09.91- 09.96	CA10351R	28 80	09.91- 09.96	CS191	24 5.4	
		09.91- 09.96	CA3331R	28 55				
		09.91- 09.96	CA8541R	28 35				
	[OM446.924]	01.94- 08.96	CA10351R	28 80	09.91- 08.96	CS191	24 5.4	
		01.94- 08.96	CA3331R	28 55				
	[OM446.925]	01.94- 08.96	CA10351R	28 80	01.94- 08.96	CS191	24 5.4	
		01.94- 08.96	CA3331R	28 55				
	[OM446.926]	01.94- 08.96	CA10351R	28 80	01.94- 08.96	CS191	24 5.4	
		01.94- 08.96	CA3331R	28 55				
	[OM446.927]	01.94- 09.96	CA10351R	28 80	01.94- 09.96	CS191	24 5.4	
		01.94- 08.96	CA3331R	28 55				
	[OM446.936]	07.92- 08.96	CA8541R	28 35	07.92- 08.96	CS191	24 5.4	
	2640 11.9	(Actros)[OM541.923]	04.96- 10.02	CA15051R	28 100	AC 04.96- 10.02	CS1077	24 6.2
			04.96- 10.02	CA15931R	28 80			
04.96- 10.02			CA16661R	28 80				
04.96- 10.02			CA17391R	28 100				
04.96- 10.02			CA17391R	28 100				
2640 12.0	(Axor)[OM457.956]	10.04-	CA16661R	28 80	10.04-	CS1463	24 6.2 MI	
		10.04-	CA17391R	28 100				
		10.04-	CA16661R	28 80				
		10.04-	CA17391R	28 100				
		10.04-	CA17391R	28 100				
2641 11.9	(Actros)[OM541.944]	04.03-	CA15051R	28 100	04.03-	CS1463	24 6.2 MI	
		04.03-	CA15931R	28 80				
		04.03-	CA16661R	28 80				
		04.03-	CA17391R	28 100				
		04.03-	CA15051R	28 100				
2643 11.9	(Actros)[OM541.925]	04.96- 10.02	CA15051R	28 100	AC 04.96- 10.02	CS1168#	24 7.8	
		04.96- 10.02	CA15931R	28 80				
		04.96- 10.02	CA16661R	28 80				
		04.96- 10.02	CA17391R	28 100				
		04.96- 10.02	CA17391R	28 100				
2643 12.0	(Axor)[OM457.956]	10.04-	CA16661R	28 80	10.04-	CS1269	24 6.2 BO	
		10.04-	CA17391R	28 100				
		10.04-	CA16661R	28 80				
		10.04-	CA17391R	28 100				
		10.04-	CA17391R	28 100				
2644 11.9	(Actros)[OM541.946]	04.03-	CA15051R	28 100	04.03-	CS1269	24 6.2 BO	
		04.03-	CA15931R	28 80				
		04.03-	CA16661R	28 80				
		04.03-	CA17391R	28 100				
		06.03-	CA15051R	28 100				
2644 14.6	(NG)[OM442.951]	10.85- 02.90	CA10351R	28 80	10.85- 02.90	CS191	24 5.4	
		10.85- 02.90	CA8541R	28 35				
		11.86- 02.90	CA3331R	28 55				
		10.85- 10.86	CA1871R	28 27				
		10.85- 02.90	CA8541R	28 35				
[OM442.953]	10.86- 02.90	CA3331R	28 55	10.85- 02.90	CS191	24 5.4		
	10.86- 02.90	CA5681R	28 30					
	10.88- 02.90	CA10351R	28 80					
	10.85- 10.86	CA1871R	28 27					
	10.85- 02.90	CA8541R	28 35					
[OM442.980]	10.85- 02.90	CA8541R	28 35	10.85- 02.90	CS191	24 5.4		
	11.86- 02.90	CA3331R	28 55					
	11.86- 02.90	CA5681R	28 30					
	10.88- 02.90	CA10351R	28 80					
	01.92- 09.96	CA10351R	28 80					
(SK)[OM440.970]	01.92- 09.96	CA3331R	28 55	01.92- 09.96	CS191	24 5.4		
	01.92- 09.96	CA8541R	28 35					
	01.92- 09.96	CA10351R	28 80					
[OM440.979]	01.92- 09.96	CA10351R	28 80	01.92- 09.96	CS191	24 5.4		



**MERCEDES-BENZ** *Continued*

		01.92- 09.96	CA333IR	28 55				
		01.92- 09.96	CA854IR	28 35				
	[OM446.922]	01.94- 09.96	CA1035IR	28 80	01.94- 09.96	CS191	24 5.4	
		01.94- 09.96	CA333IR	28 55				
	[OM446.936]	01.94- 09.96	CA1035IR	28 80				
2645	14.6	(SK)[OM442.989]	02.90- 09.96	CA1035IR	28 80	02.90- 09.96	CS191	24 5.4
			02.90- 09.96	CA333IR	28 55			
			02.90- 09.96	CA854IR	28 35			
2646	11.9	(Actros)[OM541.948]	04.03- 04.03- 06.03-	CA1593IR CA1739IR CA1666IR	28 80 28 100 28 80	06.03- 04.03- 04.03-	CS1077 CS1463 CS1269	24 6.2 MI BO
		[OM541.980]	06.03- 06.03- 06.03-	CA1593IR CA1666IR CA1739IR	28 80 28 80 28 100	04.03- 04.03-	CS1269 CS1463	24 6.2 MI
2648	11.9	(Actros)[OM541.948]	04.03- 04.03- 04.03-	CA1593IR CA1666IR CA1739IR	28 80 28 80 28 100	04.03- 04.03-	CS1269 CS1463	24 6.2 MI
		(Actros MP2 / MP3)[OM541.948]	04.03-	CA1739IR	28 100			
		[OM541.978]	04.03-	CA1739IR	28 100			
2648	14.6	(SK)[OM442.983]	12.88- 07.92	CA1035IR	28 80	12.88- 07.92	CS191	24 5.4
			12.88- 07.92	CA333IR	28 55			
			12.88- 07.92	CA854IR	28 35			
		[OM442.985]	12.88- 07.92	CA1035IR	28 80	12.88- 07.92	CS191	24 5.4
			12.88- 07.92	CA854IR	28 35			
		[OM442.989]	07.88- 08.94	CA1035IR	28 80	07.88- 08.94	CS191	24 5.4
			07.88- 08.94	CA333IR	28 55			
			07.88- 08.94	CA854IR	28 35			
		[OM442.992]	12.88- 07.92	CA1035IR	28 80	12.88- 07.92	CS191	24 5.4
			12.88- 07.92	CA854IR	28 35			
		[OM442.994]	12.88- 07.92	CA1035IR	28 80	12.88- 07.92	CS191	24 5.4
			12.88- 07.92	CA854IR	28 35			
2648	15.9	(Actros)[OM542.921]	04.96- 10.02	CA1505IR	28 100	AC 04.96- 10.02	CS1168#	24 7.8
			04.96- 10.02	CA1593IR	28 80	04.96- 10.02	CS1077	24 6.2
			04.96- 10.02	CA1666IR	28 80	04.96- 10.02	CS1463	MI
			04.96- 10.02	CA1739IR	28 100	04.96- 10.02	CS1269	BO
2650	14.6	(SK)[OM440.971]	07.88- 08.94	CA1035IR	28 80	07.88- 09.96	CS191	24 5.4
			07.88- 08.94	CA333IR	28 55			
			07.88- 09.96	CA854IR	28 35			
		[OM440.973]	07.92- 09.96	CA1035IR	28 80	07.92- 09.96	CS191	24 5.4
			07.92- 09.96	CA333IR	28 55			
			07.92- 09.96	CA854IR	28 35			
		[OM440.982]	07.87- 09.96	CA333IR	28 55	07.87- 09.96	CS191	24 5.4
			07.87- 09.96	CA854IR	28 35			
		[OM442.989]	07.88- 08.94	CA1035IR	28 80	07.88- 08.94	CS191	24 5.4
			07.88- 08.94	CA333IR	28 55			
			07.88- 08.94	CA854IR	28 35			
		[OM442.994]	07.88- 08.94	CA1035IR	28 80	07.88- 08.94	CS191	24 5.4
			07.88- 08.94	CA333IR	28 55			
			07.88- 08.94	CA854IR	28 35			
		[OM442.997]	07.88- 09.96	CA1035IR	28 80	07.88- 09.96	CS191	24 5.4
			07.88- 09.96	CA333IR	28 55			
			07.88- 09.96	CA854IR	28 35			
2650	15.9	(Actros)[OM542.940]	04.03- 04.03- 04.03-	CA1505IR CA1593IR CA1666IR	28 100 28 80 28 80	04.03- 04.03- 04.03-	CS1463 CS1077 CS1269	24 6.2 MI BO
			04.03-	CA1739IR	28 100			
2651	15.9	(Actros)[OM542.940]	04.03- 04.03- 04.03-	CA1505IR CA1593IR CA1739IR	28 100 28 80 28 100	04.03- 04.03- 04.03-	CS1269 CS1077 CS1463	24 6.2 MI BO
		(Actros MP2 / MP3)[OM542.960]	04.03-	CA1739IR	28 100			
2653	14.6	(SK)[OM446.920]	01.96-	CA1035IR	28 80	01.96-	CS191	24 5.4
		[OM446.946]	07.92- 09.96	CA1035IR	28 80	07.92- 09.96	CS191	24 5.4
2653	15.9	(Actros)[OM542.920]	04.96- 10.02	CA1505IR	28 100	04.96- 10.02	CS1269	24 6.2 BO
			04.96- 10.02	CA1593IR	28 80	04.96- 10.02	CS1463	MI
			04.96- 10.02	CA1666IR	28 80	AC 04.96- 10.02	CS1168#	7.8
			04.96- 10.02	CA1739IR	28 100	04.96- 10.02	CS1077	6.2
2654	15.9	(Actros)[OM542.942]	04.03- 04.03- 04.03-	CA1505IR CA1593IR CA1666IR	28 100 28 80 28 80	04.03- 04.03- 04.03-	CS1077 CS1269 CS1463	24 6.2 BO MI
			04.03-	CA1739IR	28 100			
2655	15.9	(Actros)[OM542.942]	04.03- 04.03- 04.03-	CA1505IR CA1593IR CA1739IR	28 100 28 80 28 100	04.03- 04.03- 04.03-	CS1269 CS1463 CS1077	24 6.2 MI BO
		(Actros MP2 / MP3)[OM542.962]	04.03-	CA1739IR	28 100			
2657	15.9	(Actros)[OM542.922]	04.97- 10.02	CA1505IR	28 100	04.97- 10.02	CS1077	24 6.2
			04.97- 10.02	CA1593IR	28 80	04.97- 10.02	CS1269	BO
			04.97- 10.02	CA1666IR	28 80	04.97- 10.02	CS1463	MI
			04.97- 10.02	CA1739IR	28 100	AC 04.97- 10.02	CS1168#	7.8
2658	15.9	(Actros)[OM542.944]	04.03- 04.03- 04.03-	CA1505IR CA1593IR CA1666IR	28 100 28 80 28 80	04.03- 04.03- 04.03-	CS1463 CS1077 CS1269	24 6.2 MI BO
			04.03-	CA1739IR	28 100			
2660	15.9	(Actros MP2 / MP3)[OM542.964]	05.05-	CA1739IR	28 100			
2732	11.9	(Actros MP2 / MP3)	06.08-	CA1739IR	28 100			
2733	7.2	(Zetros)[OM926.935]	09.08- 09.08- 09.08- 09.08-	CA1505IR CA1666IR CA1739IR CA1924IR	28 100 28 80 28 100 28 180	09.08-	CS1112	24 4.0
		[OM926.936]	09.08- 09.08- 09.08- 09.08-	CA1505IR CA1666IR CA1739IR CA1924IR	28 100 28 80 28 100 28 180	09.08-	CS1112	24 4.0
2736	11.9	(Actros MP2 / MP3)	06.08-	CA1739IR	28 100			
2741	11.9	(Actros MP2 / MP3)	06.08-	CA1739IR	28 100			
2744	11.9	(Actros MP2 / MP3)	06.08-	CA1739IR	28 100			
2746	11.9	(Actros MP2 / MP3)	06.08-	CA1739IR	28 100			
2748	11.9	(Actros MP2 / MP3)	06.08-	CA1739IR	28 100			
3025	14.6	(NG)[OM422.909]	08.83- 03.91	CA187IR	28 27	08.83- 03.91	CS191	24 5.4
			08.83- 03.91	CA568IR	28 30			
			08.83- 03.91	CA854IR	28 35			
		[OM422.912]	08.83- 03.91	CA187IR	28 27	08.83- 03.91	CS191	24 5.4
			08.83- 03.91	CA568IR	28 30			
			08.83- 03.91	CA854IR	28 35			
		[OM422.919]	12.85- 10.86	CA187IR	28 27	12.85- 07.87	CS191	24 5.4
			11.86- 07.87	CA333IR	28 55	12.85- 07.87	CS198	24 6.0
			11.86- 07.87	CA568IR	28 30			



	[OM422.920]	12.85- 10.86 11.86- 07.87 11.86- 07.87	CA1871R CA3331R CA5681R	28 27 28 55 28 30	12.85- 07.87 12.85- 07.87	CS198 CS191	24 6.0 24 5.4
	[OM442.920]	12.85- 07.87 11.86- 07.87	CA8541R CA3331R	28 35 28 55	12.85- 07.87 12.85- 07.87	CS191 CS198	24 5.4 24 6.0
3028 14.6	(NG)[OM422.905]	02.80- 05.85 06.85- 08.89 11.86- 08.89 10.88- 08.89	CA1871R CA8541R CA3331R CA10351R	28 27 28 35 28 55 28 80	05.83- 08.89 02.80- 08.89	CS198 CS191	24 6.0 24 5.4
	[OM422.911]	02.80- 05.85 06.85- 08.89 11.86- 08.89 10.88- 08.89	CA1871R CA8541R CA3331R CA10351R	28 27 28 35 28 55 28 80	05.83- 08.89 02.80- 08.89	CS198 CS191	24 6.0 24 5.4
	[OM422.919]	12.85- 07.87	CA8541R	28 35	12.85- 07.87 12.85- 07.87	CS191 CS198	24 5.4 24 6.0
3033 14.6	(NG)[OM422.954]	12.82- 05.85 06.85- 05.87 11.86- 05.87	CA1871R CA8541R CA3331R	28 27 28 35 28 55	05.83- 05.87 12.82- 05.87	CS198 CS191	24 6.0 24 5.4
	[OM422.957]	12.82- 05.85 06.85- 05.87 11.86- 05.87	CA1871R CA8541R CA3331R	28 27 28 35 28 55	05.83- 05.87 12.82- 05.87	CS198 CS191	24 6.0 24 5.4
3036 18.3	(NG)[OM423.905]	07.82- 05.85 11.86- 08.89 11.86- 08.89	CA1871R CA3331R CA8541R	28 27 28 55 28 35	12.82- 08.89	CS198	24 6.0
	[OM423.908]	07.82- 05.85 06.85- 08.89 11.86- 08.89	CA1871R CA8541R CA3331R	28 27 28 35 28 55	12.82- 08.89	CS198	24 6.0
3038 14.6	(NG)[OM422.953]	01.81- 05.85 06.85- 12.86 11.86- 12.86	CA1871R CA8541R CA3331R	28 27 28 35 28 55	01.81- 12.86	CS198	24 6.0
	[OM422.955]	01.81- 05.85 06.85- 12.86 11.86- 12.86	CA1871R CA8541R CA3331R	28 27 28 35 28 55	01.81- 12.86	CS198	24 6.0
	[OM422.959]	01.81- 05.85 06.85- 12.86 11.86- 12.86	CA1871R CA8541R CA3331R	28 27 28 35 28 55	01.81- 12.86	CS198	24 6.0
3050 14.6	(SK)[OM440.976]	12.93- 09.96 12.93- 09.96 12.93- 09.96	CA10351R CA3331R CA8541R	28 80 28 55 28 35	12.93- 09.96	CS191	24 5.4
	[OM446.933]	01.94- 09.96	CA10351R	28 80	01.94- 09.96	CS191	24 5.4
3053 14.6	(SK)[OM440.976]	12.93- 09.96 12.93- 09.96 12.93- 09.96	CA10351R CA3331R CA8541R	28 80 28 55 28 35	12.93- 09.96	CS191	24 5.4
3228 14.6	(NG)[OM422.919]	07.87- 03.91 07.87- 03.91 10.88- 03.91	CA3331R CA5681R CA10351R	28 55 28 30 28 80	07.87- 03.91	CS191	24 5.4
	[OM422.921]	07.87- 03.91 07.87- 03.91 10.88- 03.91	CA3331R CA5681R CA10351R	28 55 28 30 28 80	07.87- 03.91	CS191	24 5.4
3228 6.4	(Axor)[OM906.921]	01.02- 10.04 01.02- 10.04	CA15051R CA15931R	28 100 28 80	01.02- 10.04	CS1112	24 4.0
3229 15.1	(SK)[OM442.915]	09.89- 08.94 09.89- 08.94 09.89- 08.94 09.89- 08.94 09.89- 08.94 09.89- 08.94	CA10351R CA3331R CA8541R CA10351R CA1871R CA3331R CA5681R CA8541R	28 80 28 55 28 35 28 80 28 27 28 55 28 30 28 35	09.89- 08.94	CS191	24 5.4
	[OM442.916]	09.89- 08.94 09.89- 07.92 09.89- 08.94 09.89- 07.92 09.89- 08.94	CA10351R CA1871R CA3331R CA5681R CA8541R	28 80 28 27 28 55 28 30 28 35	09.89- 08.94	CS191	24 5.4
	[OM442.923]	09.89- 01.92 09.89- 01.92 09.89- 01.92	CA10351R CA3331R CA8541R	28 80 28 55 28 35	09.89- 01.92	CS191	24 5.4
	[OM442.927]	09.89- 08.94 09.89- 08.91	CA10351R CA8541R	28 80 28 35	09.89- 08.94	CS191	24 5.4
	[OM442.928]	09.89- 08.94 09.89- 08.91	CA10351R CA8541R	28 80 28 35	09.89- 08.94	CS191	24 5.4
3231 11.0	(MK)[OM445.929]	12.87- 09.96 12.87- 09.96 12.87- 09.96	CA10351R CA3331R CA8541R	28 80 28 55 28 35	12.87- 09.96 12.87- 09.96	CS198 CS191	24 6.0 24 5.4
3231 11.9	(Actros)[OM541.920]	04.97- 10.02 04.97- 10.02 04.97- 10.02 04.97- 10.02	CA15051R CA15931R CA16661R CA17391R	28 100 28 80 28 80 28 100	04.97- 10.02 04.97- 10.02 04.97- 10.02 AC 04.97- 10.02	CS1463 CS1269 CS1077 CS1168#	24 6.2 MI 24 6.2 BO 24 6.2 24 7.8
	[OM541.940]	04.03- 04.03- 04.03- 04.03-	CA15051R CA15931R CA16661R CA17391R	28 100 28 80 28 80 28 100	04.03- 04.03- 04.03-	CS1463 CS1077 CS1269	24 6.2 MI 24 6.2 24 6.2 BO
3231 9.6	(MK)[OM401.972]	12.87- 09.96 12.87- 09.96 12.87- 09.96	CA10351R CA3331R CA8541R	28 80 28 55 28 35	12.87- 09.96	CS191	24 5.4
	[OM401.979]	12.87- 09.96 12.87- 09.96 12.87- 09.96	CA10351R CA3331R CA8541R	28 80 28 55 28 35	12.87- 09.96	CS191	24 5.4
	[OM401.993]	12.87- 09.96 12.87- 09.96 12.87- 09.96	CA10351R CA3331R CA8541R	28 80 28 55 28 35	12.87- 09.96	CS191	24 5.4
3232 11.9	(Actros)[OM541.920]	04.03- 04.03- 04.03- 04.03-	CA15051R CA15931R CA16661R CA17391R	28 100 28 80 28 80 28 100	04.03- 04.03- 04.03-	CS1077 CS1269 CS1463	24 6.2 24 6.2 BO 24 6.2 MI
	[OM541.940]	04.03- 04.03- 04.03- 04.03-	CA15051R CA15931R CA16661R CA17391R	28 100 28 80 28 80 28 100	04.03- 04.03- 04.03-	CS1077 CS1269 CS1463	24 6.2 24 6.2 BO 24 6.2 MI
	(Actros MP2 / MP3)[OM541.970]	04.03-	CA15931R	28 80	04.03-	CS1077	24 6.2
	[OM541.996]	04.03-	CA15931R	28 80	04.03-	CS1077	24 6.2
3233 11.0	(SK)[OM441.982]	10.90- 07.92 10.90- 08.91	CA10351R CA8541R	28 80 28 35	10.90- 07.92	CS191	24 5.4
	[OM441.985]	10.90- 07.92 10.90- 08.91	CA10351R CA8541R	28 80 28 35	10.90- 07.92	CS191	24 5.4
3234 11.0	(SK)[OM441.988]	02.92- 09.96	CA10351R	28 80	02.92- 09.96	CS191	24 5.4
	[OM441.990]	02.92- 09.96	CA10351R	28 80	02.92- 09.96	CS191	24 5.4
	[OM441.992]	02.92- 09.96	CA10351R	28 80	02.92- 09.96	CS191	24 5.4
	[OM445.922]	01.92- 09.96 02.92- 09.96 02.92- 09.96	CA3331R CA10351R CA8541R	28 55 28 80 28 35	01.94- 09.96	CS191	24 5.4
3235 11.9	(Actros)[OM541.922]	04.97- 10.02 04.97- 10.02 04.97- 10.02 04.97- 10.02	CA15051R CA15931R CA16661R CA17391R	28 100 28 80 28 80 28 100	04.97- 10.02 04.97- 10.02 04.97- 10.02 AC 04.97- 10.02	CS1269 CS1463 CS1077 CS1168#	24 6.2 BO 24 6.2 MI 24 6.2 24 7.8
	[OM541.942]	04.97- 10.02	CA15051R	28 100	04.97-	CS1269	24 6.2 BO



MERCEDES-BENZ Continued

		04.97- 10.02	CA1593IR	28 80		04.97- 10.02	CS1077	24 6.2
		04.97- 10.02	CA1666IR	28 80		04.97-	CS1463	24 6.2 MI
		04.97- 10.02	CA1739IR	28 100				
3235 14.6	(NG)[OM442.944]	07.88- 08.94	CA854IR	28 35		07.88- 08.94	CS191	24 5.4
		10.88- 08.94	CA1035IR	28 80				
		10.88- 08.94	CA333IR	28 55				
	(SK)[OM442.944]	07.87- 09.96	CA1035IR	28 80		07.87- 09.96	CS191	24 5.4
		07.87- 09.96	CA333IR	28 55				
		07.87- 09.96	CA854IR	28 35				
	[OM442.952]	07.87- 02.91	CA854IR	28 35		07.87- 07.92	CS191	24 5.4
		10.88- 05.91	CA1035IR	28 80				
	[OM442.959]	10.88- 07.92	CA1035IR	28 80		07.87- 07.92	CS191	24 5.4
		10.88- 08.91	CA854IR	28 35				
	[OM442.963]	07.87- 09.96	CA1035IR	28 80		07.87- 09.96	CS191	24 5.4
		07.87- 09.96	CA333IR	28 55				
		07.87- 09.96	CA854IR	28 35				
	[OM442.976]	07.87- 09.96	CA1035IR	28 80		07.87- 09.96	CS191	24 5.4
		07.87- 09.96	CA333IR	28 55				
		07.87- 09.96	CA854IR	28 35				
3236 11.9	(Actros MP2 / MP3)[OM541.972]	04.03-	CA1505IR	28 100		04.03-	CS1077	24 6.2
		04.03-	CA1593IR	28 80				
	[OM541.998]	04.03-	CA1505IR	28 100		04.03-	CS1077	24 6.2
		04.03-	CA1593IR	28 80				
		04.03-	CA1739IR	28 100				
3236 12.0	(Axor)[OM457.956]	10.04-	CA1666IR	28 80		10.04-	CS1269	24 6.2 BO
		10.04-	CA1739IR	28 100		10.04-	CS1463	24 6.2 MI
	[OM457.957]	10.04-	CA1666IR	28 80		10.04-	CS1269	24 6.2 BO
		10.04-	CA1739IR	28 100		10.04-	CS1463	24 6.2 MI
3238 12.8	(SK)[OM402.971]	10.90- 02.01	CA1035IR	28 80		10.90- 02.01	CS191	24 5.4
		10.90- 09.96	CA854IR	28 35				
		03.91- 09.96	CA333IR	28 55				
	[OM402.972]	07.87- 09.96	CA1035IR	28 80		07.87- 09.96	CS191	24 5.4
		07.87- 09.96	CA333IR	28 55				
		07.87- 09.96	CA854IR	28 35				
	[OM402.973]	10.90- 02.01	CA1035IR	28 80		10.90- 02.01	CS191	24 5.4
		10.90- 08.91	CA854IR	28 35				
	[OM402.975]	03.91- 09.96	CA1035IR	28 80		03.91- 09.96	CS191	24 5.4
		03.91- 09.96	CA333IR	28 55				
		03.91- 09.96	CA854IR	28 35				
	[OM402.977]	10.90- 02.01	CA1035IR	28 80		10.90- 02.01	CS191	24 5.4
		10.90- 02.01	CA333IR	28 55				
		10.90- 02.01	CA854IR	28 35				
	[OM402.982]	10.90- 02.01	CA1035IR	28 80		10.90- 02.01	CS191	24 5.4
		10.90- 08.91	CA854IR	28 35				
	[OM402.985]	07.87- 09.96	CA1035IR	28 80		07.87- 09.96	CS191	24 5.4
		07.87- 09.96	CA333IR	28 55				
		07.87- 09.96	CA854IR	28 35				
	[OM402.986]	07.87- 09.96	CA1035IR	28 80		07.87- 09.96	CS191	24 5.4
		07.87- 09.96	CA333IR	28 55				
		07.87- 09.96	CA854IR	28 35				
	[OM402.987]	10.90- 02.01	CA1035IR	28 80		10.90- 02.01	CS191	24 5.4
		10.90- 02.01	CA333IR	28 55				
		10.90- 02.01	CA854IR	28 35				
3238 14.6	(SK)[OM440.970]	06.91- 02.01	CA1035IR	28 80		10.90- 02.01	CS191	24 5.4
		10.91- 02.01	CA854IR	28 35				
	[OM440.971]	10.90- 02.01	CA854IR	28 35		10.90- 02.01	CS191	24 5.4
	[OM440.980]	06.91- 02.01	CA1035IR	28 80		10.90- 02.01	CS191	24 5.4
		10.91- 02.01	CA854IR	28 35				
	[OM442.989]	10.90- 02.01	CA1035IR	28 80		10.90- 02.01	CS191	24 5.4
		10.90- 02.01	CA333IR	28 55				
		10.90- 02.01	CA854IR	28 35				
	[OM442.997]					10.90- 02.01	CS191	24 5.4
	[OM446.924]	07.87- 09.96	CA1035IR	28 80		07.87- 09.96	CS191	24 5.4
	[OM446.925]	07.87- 09.96	CA1035IR	28 80		07.87- 09.96	CS191	24 5.4
	[OM446.926]	01.94- 09.96	CA1035IR	28 80		01.94- 09.96	CS191	24 5.4
	[OM446.927]	07.87- 09.96	CA1035IR	28 80		07.87- 09.96	CS191	24 5.4
	[OM446.939]	01.94- 09.96	CA1035IR	28 80		01.94- 09.96	CS191	24 5.4
3238 18.3	(SK)[OM423.905]	03.91- 09.96	CA1035IR	28 80		03.91- 09.96	CS198	24 6.0
		03.91- 09.96	CA333IR	28 55				
		03.91- 09.96	CA854IR	28 35				
	[OM423.907]	03.91- 09.96	CA1035IR	28 80		03.91- 09.96	CS198	24 6.0
		03.91- 09.96	CA333IR	28 55				
		03.91- 09.96	CA854IR	28 35				
3240 11.9	(Actros)[OM541.923]	04.97- 10.02	CA1505IR	28 100		04.97- 10.02	CS1077	24 6.2
		04.97- 10.02	CA1593IR	28 80		04.97- 10.02	CS1269	24 6.2 BO
		04.97- 10.02	CA1666IR	28 80		04.97- 10.02	CS1463	24 6.2 MI
		04.97- 10.02	CA1739IR	28 100		AC 04.97- 10.02	CS1168#	24 7.8
3240 12.0	(Axor)[OM457.937]	03.05-	CA1666IR	28 80		03.05-	CS1463	24 6.2 MI
		03.05-	CA1739IR	28 100		03.05-	CS1269	24 6.2 BO
	[OM457.948]	03.05-	CA1666IR	28 80		03.05-	CS1269	24 6.2 BO
		03.05-	CA1739IR	28 100		03.05-	CS1463	24 6.2 MI
	[OM457.956]	10.04-	CA1666IR	28 80		10.04-	CS1463	24 6.2 MI
		10.04-	CA1739IR	28 100		10.04-	CS1269	24 6.2 BO
	[OM457.957]	10.04-	CA1666IR	28 80		10.04-	CS1269	24 6.2 BO
		10.04-	CA1739IR	28 100		10.04-	CS1463	24 6.2 MI
3241 11.9	(Actros)[OM541.944]	04.03-	CA1505IR	28 100		04.03-	CS1463	24 6.2 MI
		04.03-	CA1593IR	28 80		04.03-	CS1077	24 6.2
		04.03-	CA1666IR	28 80		04.03-	CS1269	24 6.2 BO
		04.03-	CA1739IR	28 100				
	(Actros MP2 / MP3)[OM541.944]	06.08-	CA1739IR	28 100				
	[OM541.974]	04.03-	CA1505IR	28 100		04.03-	CS1077	24 6.2
	[OM541.990]	04.03-	CA1505IR	28 100		04.03-	CS1077	24 6.2
3243 11.9	(Actros)[OM541.924]	04.97- 10.02	CA1505IR	28 100		04.97- 10.02	CS1463	24 6.2 MI
		04.97- 10.02	CA1593IR	28 80		AC 04.97- 10.02	CS1168#	24 7.8
		04.97- 10.02	CA1666IR	28 80		04.97- 10.02	CS1077	24 6.2
		04.97- 10.02	CA1739IR	28 100		04.97- 10.02	CS1269	24 6.2 BO
	[OM541.925]	04.97- 10.02	CA1505IR	28 100		04.97- 10.02	CS1077	24 6.2
		04.97- 10.02	CA1593IR	28 80		04.97- 10.02	CS1269	24 6.2 BO
		04.97- 10.02	CA1666IR	28 80		04.97- 10.02	CS1463	24 6.2 MI
		04.97- 10.02	CA1739IR	28 100		AC 04.97- 10.02	CS1168#	24 7.8
3243 12.0	(Axor)[OM457.948]	03.05-	CA1666IR	28 80		03.05-	CS1463	24 6.2 MI
		03.05-	CA1739IR	28 100		03.05-	CS1269	24 6.2 BO
	[OM457.956]	10.04-	CA1666IR	28 80		10.04-	CS1463	24 6.2 MI
		10.04-	CA1739IR	28 100		10.04-	CS1269	24 6.2 BO
	[OM457.957]	10.04-	CA1666IR	28 80		10.04-	CS1463	24 6.2 MI
		10.04-	CA1739IR	28 100		10.04-	CS1269	24 6.2 BO



3244	11.9	(Actros MP2 / MP3)[OM541.976]	04.03-	CA1739IR	28 100	04.03-	CS1168#	24 7.8
		[OM541.992]	04.03-	CA1739IR	28 100	04.03-	CS1168#	24 7.8
3244	14.6	(SK)[OM440.970]	07.87- 09.96	CA1035IR	28 80	07.87- 09.96	CS191	24 5.4
			07.87- 09.96	CA333IR	28 55			
			07.87- 09.96	CA854IR	28 35			
		[OM440.980]	01.94- 09.96	CA1035IR	28 80	01.94- 09.96	CS191	24 5.4
			01.94- 09.96	CA333IR	28 55			
			01.94- 09.96	CA854IR	28 35			
		[OM446.922]	07.87- 09.96	CA1035IR	28 80	07.87- 09.96	CS191	24 5.4
			07.87- 09.96	CA333IR	28 55			
			07.87- 09.96	CA854IR	28 35			
		[OM446.939]	01.94- 09.96	CA333IR	28 55	01.94- 09.96	CS191	24 5.4
			01.94- 09.96	CA854IR	28 35			
3246	11.9	(Actros)[OM541.948]	01.02-	CA1593IR	28 80	04.03-	CS1463	24 6.2 MI
			01.02-	CA1666IR	28 80	04.03-	CS1269	24 6.2 BO
			01.02-	CA1739IR	28 100			
		(Actros MP2 / MP3)[OM541.948]	04.03-	CA1593IR	28 80			
		[OM541.980]	04.03-	CA1593IR	28 80			
		[OM541.994]	04.03-	CA1593IR	28 80			
3248	11.9	(Actros MP2 / MP3)[OM541.978]	04.03-	CA1739IR	28 100			
3248, 11.9		(Actros MP2 / MP3)[OM541.978]	04.03-	CA1739IR	28 100			
3248	14.6	(SK)[OM442.984]	07.87- 09.96	CA854IR	28 35	07.87- 09.96	CS191	24 5.4
		[OM442.985]	07.87- 09.96	CA854IR	28 35	07.87- 09.96	CS191	24 5.4
		[OM442.989]	07.87- 09.96	CA854IR	28 35	07.87- 09.96	CS191	24 5.4
		[OM442.992]	07.87- 09.96	CA854IR	28 35	07.87- 09.96	CS191	24 5.4
3250	14.6	(SK)[OM440.971]	07.87- 09.96	CA854IR	28 35	07.87- 09.96	CS191	24 5.4
		[OM440.973]	07.87- 09.96	CA568IR	28 30	07.87- 09.96	CS191	24 5.4
			07.87- 09.96	CA854IR	28 35			
		[OM440.975]	07.87- 09.96	CA568IR	28 30	07.87- 09.96	CS191	24 5.4
			07.87- 09.96	CA854IR	28 35			
		[OM442.997]	07.87- 09.96	CA568IR	28 30	07.87- 09.96	CS191	24 5.4
			07.87- 09.96	CA854IR	28 35			
3250	18.3	(NG)[OM423.908]	09.85- 08.94	CA333IR	28 55	09.85- 08.94	CS198	24 6.0
			10.88- 08.94	CA1035IR	28 80			
		[OM423.950]	09.85- 08.94	CA333IR	28 55	09.85- 08.94	CS198	24 6.0
			10.88- 08.94	CA1035IR	28 80			
		[OM423.951]	09.85- 08.94	CA333IR	28 55	09.85- 08.94	CS198	24 6.0
			10.88- 08.94	CA1035IR	28 80			
3253	14.6	(SK)[OM446.920]	01.96- 09.96	CA1035IR	28 80	01.96- 09.96	CS191	24 5.4
		[OM446.933]	01.96- 09.96	CA1035IR	28 80	01.96- 09.96	CS191	24 5.4
		[OM446.945]	01.96- 09.96	CA1035IR	28 80	01.96- 09.96	CS191	24 5.4
3255	14.6	(SK)[OM446.920]	07.87- 09.96	CA1035IR	28 80	07.87- 09.96	CS191	24 5.4
3328	14.6	(NG)[OM422.905]	02.80- 03.91	CA1035IR	28 80	02.80- 03.91	CS191	24 5.4
			02.80- 03.91	CA187IR	28 27	02.80- 03.91	CS198	24 6.0
			02.80- 03.91	CA333IR	28 55			
			02.80- 03.91	CA854IR	28 35			
		[OM422.907]	02.80- 03.91	CA187IR	28 27	02.80- 03.91	CS191	24 5.4
			02.80- 03.91	CA333IR	28 55			
			02.80- 03.91	CA854IR	28 35			
		[OM422.911]	02.80- 03.91	CA1035IR	28 80	02.80- 03.91	CS191	24 5.4
			02.80- 03.91	CA187IR	28 27			
			02.80- 03.91	CA333IR	28 55			
			02.80- 03.91	CA854IR	28 35			
		[OM422.913]	02.80- 03.91	CA187IR	28 27	02.80- 03.91	CS191	24 5.4
			02.80- 03.91	CA333IR	28 55			
			02.80- 03.91	CA568IR	28 30			
			02.80- 03.91	CA854IR	28 35			
		[OM422.914]	07.82- 10.86	CA187IR	28 27	07.82- 07.87	CS191	24 5.4
			11.86- 07.87	CA333IR	28 55	05.83- 07.87	CS198	24 6.0
			11.86- 07.87	CA568IR	28 30			
		[OM422.916]	02.80- 03.91	CA187IR	28 27	02.80- 03.91	CS191	24 5.4
			02.80- 03.91	CA333IR	28 55			
			02.80- 03.91	CA854IR	28 35			
		[OM422.919]	07.82- 10.86	CA187IR	28 27	07.82- 07.87	CS191	24 5.4
			11.86- 07.87	CA333IR	28 55	05.83- 07.87	CS198	24 6.0
			11.86- 07.87	CA568IR	28 30			
3331	11.9	(Actros)[OM541.920]	04.97- 10.02	CA1505IR	28 100	04.97- 10.02	CS1269	24 6.2 BO
			04.97- 10.02	CA1593IR	28 80	04.97- 10.02	CS1463	24 6.2 MI
			04.97- 10.02	CA1666IR	28 80	AC 04.97- 10.02	CS1168#	24 7.8
			04.97- 10.02	CA1739IR	28 100	04.97- 10.02	CS1077	24 6.2
		[OM541.926]	04.97- 10.02	CA1505IR	28 100	AC 04.97- 10.02	CS1168#	24 7.8
			04.97- 10.02	CA1593IR	28 80	04.97- 10.02	CS1269	24 6.2 BO
			04.97- 10.02	CA1666IR	28 80	04.97- 10.02	CS1463	24 6.2 MI
			04.97- 10.02	CA1739IR	28 100	04.97- 10.02	CS1077	24 6.2
		[OM541.940]	04.03-	CA1505IR	28 100	04.03-	CS1077	24 6.2
			04.03-	CA1593IR	28 80	04.03-	CS1463	24 6.2 MI
			04.03-	CA1666IR	28 80	04.03-	CS1269	24 6.2 BO
			04.03-	CA1739IR	28 100			
		[OM541.970]	04.03-	CA1505IR	28 100	04.03-	CS1077	24 6.2
			04.03-	CA1593IR	28 80	04.03-	CS1269	24 6.2 BO
			04.03-	CA1666IR	28 80	04.03-	CS1463	24 6.2 MI
			04.03-	CA1739IR	28 100			
3332	11.9	(Actros)[OM541.920]	04.03-	CA1505IR	28 100	04.03-	CS1269	24 6.2 BO
			04.03-	CA1593IR	28 80	04.03-	CS1463	24 6.2 MI
			04.03-	CA1666IR	28 80	04.03-	CS1077	24 6.2
			04.03-	CA1739IR	28 100			
		[OM541.940]	04.03-	CA1505IR	28 100	04.03-	CS1269	24 6.2 BO
			04.03-	CA1593IR	28 80	04.03-	CS1463	24 6.2 MI
			04.03-	CA1666IR	28 80	04.03-	CS1077	24 6.2
			04.03-	CA1739IR	28 100			
		[OM541.941]	04.03-	CA1505IR	28 100	04.03-	CS1077	24 6.2
			04.03-	CA1593IR	28 80	04.03-	CS1269	24 6.2 BO
			04.03-	CA1666IR	28 80	04.03-	CS1463	24 6.2 MI
			04.03-	CA1739IR	28 100			
		[OM541.970]	04.03-	CA1505IR	28 100	04.03-	CS1077	24 6.2
			04.03-	CA1593IR	28 80	04.03-	CS1269	24 6.2 BO
			04.03-	CA1666IR	28 80	04.03-	CS1463	24 6.2 MI
			04.03-	CA1739IR	28 100			
		(Actros MP2 / MP3)		CA1505IR	28 100			
3332	12.0	(Actros)[OM541.970]	02.05-	CA1666IR	28 80	04.03-	CS1269	24 6.2 BO
			02.05-	CA1739IR	28 100	04.03-	CS1463	24 6.2 MI
3333	14.6	(NG)[OM422.954]	12.82- 05.85	CA187IR	28 27	05.83- 11.91	CS198	24 6.0
			06.85- 11.91	CA854IR	28 35	12.82- 11.91	CS191	24 5.4
			11.86- 11.91	CA333IR	28 55			
			10.88- 11.91	CA1035IR	28 80			



MERCEDES-BENZ Continued

3335 11.9	(Actros)[OM541.922]	04.97- 10.02	CA1505IR	28 100	AC 04.97- 10.02	CS1168#	24 7.8	
		04.97- 10.02	CA1593IR	28 80	04.97- 10.02	CS1077	24 6.2	
		04.97- 10.02	CA1666IR	28 80	04.97- 10.02	CS1463	24 6.2 MI	
		04.97- 10.02	CA1739IR	28 100	04.97- 10.02	CS1269	24 6.2 BO	
3335 12.0	(Axor)[OM457.937]	10.04-	CA1505IR	28 100				
3335 14.6	(NG)[OM442.950]	04.86- 03.91	CA1035IR	28 80	04.86- 03.91	CS191	24 5.4	
		04.86- 03.91	CA333IR	28 55				
		04.86- 03.91	CA854IR	28 35				
	[OM442.962]	04.86- 03.91	CA1035IR	28 80	04.86- 03.91	CS191	24 5.4	
		04.86- 03.91	CA333IR	28 55				
		04.86- 03.91	CA854IR	28 35				
3336 11.9	(Actros)[OM541.927]	04.03-	CA1666IR	28 80	04.03-	CS1077	24 6.2	
		04.03-	CA1739IR	28 100	04.03-	CS1269	24 6.2 BO	
		[OM541.942]	04.03-	CA1505IR	28 100	04.03-	CS1463	24 6.2 MI
			04.03-	CA1593IR	28 80	04.03-	CS1077	24 6.2
			04.03-	CA1666IR	28 80	04.03-	CS1269	24 6.2 BO
			04.03-	CA1739IR	28 100			
		[OM541.943]	04.03-	CA1505IR	28 100	04.03-	CS1077	24 6.2
			04.03-	CA1593IR	28 80	04.03-	CS1269	24 6.2 BO
			04.03-	CA1666IR	28 80	04.03-	CS1463	24 6.2 MI
			04.03-	CA1739IR	28 100			
	(Actros MP2 / MP3)		CA1593IR	28 80				
3336 12.0	(Actros)[OM541.972]	04.03-	CA1666IR	28 80	04.03-	CS1269	24 6.2 BO	
		04.03-	CA1739IR	28 100	04.03-	CS1077	24 6.2	
					04.03-	CS1463	24 6.2 MI	
3336 14.6	(NG)[OM442.950]	11.81- 03.91	CA1035IR	28 80	11.81- 03.91	CS198	24 6.0	
		11.81- 03.85	CA187IR	28 27	11.81- 03.91	CS191	24 5.4	
		11.81- 03.91	CA333IR	28 55				
		11.81- 03.91	CA568IR	28 30				
		11.81- 03.91	CA854IR	28 35				
		[OM442.952]	11.81- 03.91	CA1035IR	28 80	11.81- 03.91	CS198	24 6.0
			11.81- 03.91	CA187IR	28 27	11.81- 03.91	CS191	24 5.4
			11.81- 03.91	CA333IR	28 55			
			11.81- 03.91	CA568IR	28 30			
			11.81- 03.91	CA854IR	28 35			
3336 18.3	(NG)[OM423.905]	11.81- 03.91	CA187IR	28 27	11.81- 11.91	CS198	24 6.0	
		11.81- 03.91	CA568IR	28 30				
		11.81- 11.91	CA854IR	28 35				
		12.82- 11.91	CA1035IR	28 80				
		11.86- 11.91	CA333IR	28 55				
		[OM423.907]	11.81- 03.91	CA187IR	28 27	11.81- 11.91	CS198	24 6.0
			11.81- 03.91	CA568IR	28 30			
			11.81- 11.91	CA854IR	28 35			
			09.86- 11.91	CA1035IR	28 80			
			03.91- 11.91	CA333IR	28 55			
3338 14.6	(NG)[OM442.950]	01.81- 12.86	CA568IR	28 30	01.81- 12.86	CS191	24 5.4	
		01.81- 12.86	CA854IR	28 35				
3340 11.9	(Actros)[OM541.923]	04.97- 10.02	CA1505IR	28 100	04.97- 10.02	CS1269	24 6.2 BO	
		04.97- 10.02	CA1593IR	28 80	04.97- 10.02	CS1077	24 6.2	
		04.97- 10.02	CA1666IR	28 80	04.97- 10.02	CS1463	24 6.2 MI	
		[OM541.924]	04.97- 10.02	CA1739IR	28 100	AC 04.97- 10.02	CS1168#	24 7.8
			04.97- 10.02	CA1505IR	28 100	04.97- 10.02	CS1269	24 6.2 BO
			04.97- 10.02	CA1593IR	28 80	04.97- 10.02	CS1463	24 6.2 MI
3340 12.0	(Axor)[OM457.937]	10.04-	CA1666IR	28 80	10.04-	CS1333	24 6.2	
		10.04-	CA1739IR	28 100	10.04-	CS191	24 5.4	
		10.04-	CA1505IR	28 100	10.04-	CS1463	24 6.2 MI	
		[OM457.948]	10.04-	CA1666IR	28 80	10.04-	CS1269	24 6.2 BO
			10.04-	CA1739IR	28 100	10.04-	CS1463	24 6.2 MI
		[OM457.956]	10.04-	CA1666IR	28 80	10.04-	CS1463	24 6.2 MI
			10.04-	CA1739IR	28 100	10.04-	CS1269	24 6.2 BO
		[OM457.957]	10.04-	CA1666IR	28 80	10.04-	CS1463	24 6.2 MI
			10.04-	CA1739IR	28 100	10.04-	CS1269	24 6.2 BO
			10.04-	CA1505IR	28 100	10.04-	CS1077	24 6.2
3341 11.9	(Actros)[OM541.923]	04.03-	CA1505IR	28 100	04.03-	CS1077	24 6.2	
		04.03-	CA1593IR	28 80	04.03-	CS1269	24 6.2 BO	
		04.03-	CA1666IR	28 80	04.03-	CS1463	24 6.2 MI	
		[OM541.944]	04.03-	CA1739IR	28 100	04.03-	CS1463	24 6.2 MI
			04.03-	CA1505IR	28 100	04.03-	CS1077	24 6.2
			04.03-	CA1593IR	28 80	04.03-	CS1269	24 6.2 BO
			04.03-	CA1666IR	28 80	04.03-	CS1463	24 6.2 MI
		[OM541.945]	04.03-	CA1739IR	28 100	04.03-	CS1463	24 6.2 MI
			04.03-	CA1505IR	28 100	04.03-	CS1269	24 6.2 BO
			04.03-	CA1593IR	28 80	04.03-	CS1077	24 6.2
	(Actros MP2 / MP3)[OM541.974]	04.03-	CA1666IR	28 80	04.03-	CS1463	24 6.2 MI	
			CA1593IR	28 80				
	[OM541.990]	04.03-	CA1505IR	28 100	04.03-	CS1077	24 6.2	
	[OM541.991]	04.03-	CA1593IR	28 80				
			CA1666IR	28 80				
			CA1739IR	28 100				
3341 12.0	(Actros)[OM541.974]	04.03-	CA1666IR	28 80	04.03-	CS1463	24 6.2 MI	
		04.03-	CA1739IR	28 100	04.03-	CS1269	24 6.2 BO	
3343 11.9	(Actros)[OM541.921]	04.97- 10.02	CA1505IR	28 100	04.97- 10.02	CS1077	24 6.2	
		04.97- 10.02	CA1593IR	28 80	AC 04.97- 10.02	CS1168#	24 7.8	
		04.97- 10.02	CA1666IR	28 80	04.97- 10.02	CS1269	24 6.2 BO	
		[OM541.925]	04.97- 10.02	CA1739IR	28 100	04.97- 10.02	CS1463	24 6.2 MI
			04.97- 10.02	CA1505IR	28 100	04.97- 10.02	CS1077	24 6.2
			04.97- 10.02	CA1593IR	28 80	AC 04.97- 10.02	CS1168#	24 7.8
		04.97- 10.02	CA1666IR	28 80	04.97- 10.02	CS1463	24 6.2 MI	
		04.97- 10.02	CA1739IR	28 100	04.97- 10.02	CS1269	24 6.2 BO	
3343 12.0	(Axor)[OM457.937]	10.04-	CA1505IR	28 100				
3344 11.9	(Actros)[OM541.921]	04.03-	CA1666IR	28 80	04.03-	CS1463	24 6.2 MI	
		04.03-	CA1739IR	28 100	04.03-	CS1269	24 6.2 BO	
		[OM541.946]	04.03-	CA1505IR	28 100	04.03-	CS1269	24 6.2 BO
			04.03-	CA1593IR	28 80	04.03-	CS1463	24 6.2 MI
			04.03-	CA1666IR	28 80	04.03-	CS1077	24 6.2
			04.03-	CA1739IR	28 100			
		[OM541.947]	04.03-	CA1505IR	28 100	04.03-	CS1269	24 6.2 BO
			04.03-	CA1593IR	28 80	04.03-	CS1463	24 6.2 MI
			04.03-	CA1666IR	28 80	04.03-	CS1077	24 6.2
		(Actros MP2 / MP3)[OM541.976]	04.03-	CA1739IR	28 100			
		04.03-	CA1593IR	28 80	04.03-	CS1077	24 6.2	
	[OM541.992]	04.03-	CA1593IR	28 80	04.03-	CS1077	24 6.2	
			CA1593IR	28 80				
3344 12.0	(Actros)[OM541.947]	04.03-	CA1666IR	28 80	04.03-	CS1463	24 6.2 MI	
		04.03-	CA1739IR	28 100	04.03-	CS1269	24 6.2 BO	





	[OM541.976]	04.03-04.03-	CA1666IR	28 80	04.03-04.03-	CS1463	24 6.2	MI
			CA1739IR	28 100		CS1269	24 6.2	BO
3346 11.9	(Actros)[OM541.948]	04.03-04.03-04.03-04.03-	CA1505IR	28 100	04.03-04.97-10.02	CS1077	24 6.2	MI
			CA1593IR	28 80		CS1463	24 6.2	MI
			CA1666IR	28 80		CS1269	24 6.2	BO
			CA1739IR	28 100				
	[OM541.949]	04.03-04.03-	CA1666IR	28 80	04.03-04.03-	CS1269	24 6.2	BO
			CA1739IR	28 100		CS1463	24 6.2	MI
	(Actros MP2 / MP3)[OM541.948]	04.03-	CA1593IR	28 80	04.03-	CS1269	24 6.2	
	[OM541.949]	04.03-	CA1593IR	28 80				
	[OM541.980]	04.03-	CA1593IR	28 80				
	[OM541.994]	04.03-	CA1593IR	28 80				
	[OM541.995]	04.03-	CA1593IR	28 80				
			CA1593IR	28 80				
3348 11.9	(Actros)[OM541.948]	04.03-04.03-04.03-	CA1593IR	28 80	04.03-04.03-	CS1269	24 6.2	BO
			CA1666IR	28 80		CS1463	24 6.2	MI
			CA1739IR	28 100				
	[OM541.978]	04.03-	CA1739IR	28 100				
	(Actros MP2 / MP3)[OM541.978]	04.03-	CA1739IR	28 100				
			CA1739IR	28 100				
3348 15.9	(Actros)[OM542.921]	04.97-10.02	CA1505IR	28 100	AC 04.97-10.02	CS1168#	24 7.8	
		04.97-10.02	CA1593IR	28 80	04.97-10.02	CS1269	24 6.2	BO
		04.97-10.02	CA1666IR	28 80	04.97-10.02	CS1077	24 6.2	
		04.97-10.02	CA1739IR	28 100	04.97-10.02	CS1463	24 6.2	MI
	[OM542.925]	04.97-10.02	CA1505IR	28 100	AC 04.97-10.02	CS1168#	24 7.8	
		04.97-10.02	CA1593IR	28 80	04.97-10.02	CS1269	24 6.2	BO
		04.97-10.02	CA1666IR	28 80	04.97-10.02	CS1077	24 6.2	
		04.97-10.02	CA1739IR	28 100	04.97-10.02	CS1463	24 6.2	MI
	(Actros MP2 / MP3)[OM542.921]	04.03-	CA1739IR	28 100				
3350 15.9	(Actros)[OM542.940]	04.03-04.03-04.03-04.03-	CA1505IR	28 100	04.03-04.03-	CS1269	24 6.2	BO
			CA1593IR	28 80		CS1077	24 6.2	
			CA1666IR	28 80		CS1463	24 6.2	MI
			CA1739IR	28 100				
3351 15.9	(Actros)[OM542.940]	04.03-04.03-04.03-04.03-	CA1505IR	28 100	04.03-04.03-	CS1269	24 6.2	BO
			CA1593IR	28 80		CS1463	24 6.2	MI
			CA1666IR	28 80		CS1077	24 6.2	
			CA1739IR	28 100				
	(Actros MP2 / MP3)[OM542.940]	04.03-	CA1739IR	28 100				
	[OM542.960]	04.03-	CA1739IR	28 100				
	[OM542.961]	06.08-	CA1739IR	28 100				
3351 16.0	(Actros)[OM542.941]	04.03-04.03-	CA1666IR	28 80	04.03-04.03-	CS1463	24 6.2	MI
			CA1739IR	28 100		CS1269	24 6.2	BO
3353 15.9	(Actros)[OM542.920]	04.97-10.02	CA1505IR	28 100	04.97-10.02	CS1269	24 6.2	BO
		04.97-10.02	CA1593IR	28 80	04.97-10.02	CS1077	24 6.2	
		04.97-10.02	CA1666IR	28 80	04.97-10.02	CS1463	24 6.2	MI
		04.97-10.02	CA1739IR	28 100	AC 04.97-10.02	CS1168#	24 7.8	
3354 15.9	(Actros)[OM542.942]	04.03-04.03-04.03-04.03-	CA1505IR	28 100	04.03-04.03-	CS1077	24 6.2	
			CA1593IR	28 80		CS1269	24 6.2	BO
			CA1666IR	28 80		CS1463	24 6.2	MI
			CA1739IR	28 100				
	[OM542.962]	04.03-04.03-04.03-04.03-	CA1505IR	28 100	04.03-04.03-	CS1077	24 6.2	
			CA1593IR	28 80		CS1463	24 6.2	MI
			CA1666IR	28 80		CS1269	24 6.2	BO
			CA1739IR	28 100				
3355 15.9	(Actros)[OM542.942]	04.03-04.03-04.03-04.03-	CA1505IR	28 100	04.03-04.03-	CS1269	24 6.2	BO
			CA1593IR	28 80		CS1077	24 6.2	
			CA1666IR	28 80		CS1463	24 6.2	MI
			CA1739IR	28 100				
	[OM542.962]	04.03-04.03-04.03-04.03-	CA1505IR	28 100	04.03-04.03-	CS1077	24 6.2	
			CA1593IR	28 80		CS1269	24 6.2	BO
			CA1666IR	28 80		CS1463	24 6.2	MI
			CA1739IR	28 100				
	(Actros MP2 / MP3)[OM542.963]	04.03-	CA1035IR	28 80				
3355 16.0	(Actros)[OM542.962]	04.03-04.03-	CA1666IR	28 80	04.03-04.03-	CS1463	24 6.2	MI
			CA1739IR	28 100		CS1269	24 6.2	BO
						CS1077	24 6.2	
3357 15.9	(Actros)[OM542.922]	04.97-10.02	CA1505IR	28 100	04.97-10.02	CS1077	24 6.2	
		04.97-10.02	CA1593IR	28 80	04.97-10.02	CS1269	24 6.2	BO
		04.97-10.02	CA1666IR	28 80	04.97-10.02	CS1463	24 6.2	MI
		04.97-10.02	CA1739IR	28 100	AC 04.97-10.02	CS1168#	24 7.8	
3358 15.9	(Actros)[OM542.944]	04.03-04.03-04.03-	CA1505IR	28 100	04.03-04.03-	CS1077	24 6.2	
			CA1593IR	28 80		CS1463	24 6.2	
			CA1739IR	28 100	04.03-	CS1269	24 6.2	
	(Actros MP2 / MP3)	04.03-	CA1593IR	28 80				
3360 15.9	(Actros MP2 / MP3)	04.03-	CA1739IR	28 100				
3525 14.6	(SK)[OM442.950]	07.87-10.88-05.91	CA854IR	28 35	07.87-07.92	CS191	24 5.4	
			CA1035IR	28 80				
3528 14.6	(NG)[OM422.905]	07.82-07.87	CA333IR	28 55	07.82-07.87	CS191	24 5.4	
		07.82-07.87	CA854IR	28 35				
	[OM422.919]	07.82-09.89	CA333IR	28 55	07.82-09.89	CS191	24 5.4	
		07.82-07.87	CA854IR	28 35				
		07.87-09.89	CA568IR	28 30				
		10.88-09.89	CA1035IR	28 80				
3529 15.1	(SK)[OM442.906]	07.88-08.94	CA1035IR	28 80	07.88-08.94	CS191	24 5.4	
		07.88-08.94	CA333IR	28 55				
		07.88-08.94	CA854IR	28 35				
	[OM442.907]	07.88-08.94	CA1035IR	28 80	07.88-08.94	CS191	24 5.4	
		07.88-08.94	CA333IR	28 55				
		07.88-08.94	CA854IR	28 35				
	[OM442.925]	07.88-08.94	CA1035IR	28 80	07.88-08.94	CS191	24 5.4	
		07.88-08.94	CA333IR	28 55				
		07.88-08.94	CA854IR	28 35				
3534 11.0	(SK)[OM441.988]	10.93-09.96	CA1035IR	28 80	10.93-09.96	CS191	24 5.4	
		10.93-09.96	CA333IR	28 55				
		10.93-09.96	CA854IR	28 35				
	[OM445.922]	10.93-09.96	CA1035IR	28 80	01.94-	CS191	24 5.4	
		10.93-09.96	CA854IR	28 35				
		01.94-09.96	CA333IR	28 55				
3535 12.8	(SK)[OM402.982]	03.91-08.94	CA1035IR	28 80	03.91-08.94	CS191	24 5.4	
		03.91-08.94	CA333IR	28 55				
		03.91-08.94	CA854IR	28 35				
	[OM402.983]	03.91-08.94	CA1035IR	28 80	03.91-08.94	CS191	24 5.4	
		03.91-08.94	CA333IR	28 55				
		03.91-08.94	CA854IR	28 35				
3535 14.6	(NG)[OM442.950]	09.87-10.88-02.90	CA333IR	28 55	09.87-02.90	CS191	24 5.4	
			CA568IR	28 30				
			CA1035IR	28 80				



MERCEDES-BENZ Continued

	[OM442.952]	09.87- 02.90 CA333IR 28 55		09.87- 02.90 CS191 24 5.4
		09.87- 02.90 CA568IR 28 30		
		10.88- 02.90 CA1035IR 28 80		
	[OM442.959]	09.87- 01.89 CA333IR 28 55		09.87- 01.89 CS191 24 5.4
		09.87- 01.89 CA568IR 28 30		
		10.88- 01.89 CA1035IR 28 80		
	(SK)[OM440.940]	07.88- 08.94 CA1035IR 28 80	07.88- 08.94	CS191 24 5.4
		07.88- 08.94 CA333IR 28 55		
		07.88- 08.94 CA568IR 28 30		
		07.88- 08.94 CA854IR 28 35		
	[OM442.942]	07.87- 09.96 CA333IR 28 55	07.87- 09.96	CS191 24 5.4
		07.87- 09.96 CA854IR 28 35		
		07.88- 08.94 CA1035IR 28 80		
	[OM442.944]	07.88- 08.94 CA1035IR 28 80	07.88- 08.94	CS191 24 5.4
		07.88- 08.94 CA333IR 28 55		
		07.88- 08.94 CA568IR 28 30		
		07.88- 08.94 CA854IR 28 35		
	[OM442.945]	10.88- 08.94 CA1035IR 28 80	10.88- 08.94	CS191 24 5.4
		10.88- 08.94 CA854IR 28 35		
	[OM442.946]	02.90- 08.94 CA1035IR 28 80	02.90- 08.94	CS191 24 5.4
		02.90- 08.94 CA333IR 28 55		
		02.90- 02.91 CA568IR 28 30		
		03.91- 08.94 CA854IR 28 35		
	[OM442.957]	02.90- 08.94 CA1035IR 28 80	02.90- 08.94	CS191 24 5.4
		02.90- 08.94 CA854IR 28 35		
	[OM442.959]	07.88- 08.94 CA1035IR 28 80	07.88- 08.94	CS191 24 5.4
		07.88- 08.94 CA333IR 28 55		
		07.88- 08.94 CA854IR 28 35		
	[OM442.964]	07.88- 08.94 CA1035IR 28 80	07.88- 08.94	CS191 24 5.4
		07.88- 08.94 CA333IR 28 55		
		07.88- 08.94 CA568IR 28 30		
		07.88- 08.94 CA854IR 28 35		
	[OM442.966]	07.87- 09.96 CA333IR 28 55	07.87- 09.96	CS191 24 5.4
		07.87- 09.96 CA568IR 28 30		
		07.87- 09.96 CA854IR 28 35		
		07.88- 08.94 CA1035IR 28 80		
	[OM442.989]	10.88- 08.94 CA1035IR 28 80	10.88- 08.94	CS191 24 5.4
		10.88- 08.94 CA333IR 28 55		
		10.88- 08.94 CA854IR 28 35		
3536 18.3	(NG)[OM423.907]	12.82- 11.91 CA1035IR 28 80	12.82- 11.91	CS198 24 6.0
		12.82- 11.91 CA333IR 28 55		
		12.82- 11.91 CA854IR 28 35		
3538 12.8	(SK)[OM402.971]	09.91- 09.96 CA1035IR 28 80	09.91- 09.96	CS191 24 5.4
		09.91- 09.96 CA333IR 28 55		
		09.91- 09.96 CA854IR 28 35		
	[OM402.972]	09.91- 09.96 CA1035IR 28 80	09.91- 09.96	CS191 24 5.4
		09.91- 09.96 CA333IR 28 55		
		09.91- 09.96 CA854IR 28 35		
	[OM402.973]	03.91- 09.96 CA1035IR 28 80	03.91- 09.96	CS191 24 5.4
		03.91- 09.96 CA333IR 28 55		
		03.91- 09.96 CA854IR 28 35		
	[OM402.974]	09.91- 09.96 CA1035IR 28 80	09.91- 09.96	CS191 24 5.4
		09.91- 09.96 CA333IR 28 55		
		09.91- 09.96 CA854IR 28 35		
	[OM402.975]	09.91- 09.96 CA1035IR 28 80	09.91- 09.96	CS191 24 5.4
		09.91- 09.96 CA333IR 28 55		
		09.91- 09.96 CA854IR 28 35		
	[OM402.977]	09.91- 09.96 CA1035IR 28 80	09.91- 09.96	CS191 24 5.4
		09.91- 09.96 CA333IR 28 55		
		09.91- 09.96 CA854IR 28 35		
	[OM402.978]	03.91- 09.96 CA1035IR 28 80	03.91- 09.96	CS191 24 5.4
		03.91- 09.96 CA333IR 28 55		
		03.91- 09.96 CA568IR 28 30		
		03.91- 09.96 CA854IR 28 35		
	[OM402.982]	03.91- 09.96 CA1035IR 28 80	03.91- 09.96	CS191 24 5.4
		03.91- 09.96 CA333IR 28 55		
		03.91- 09.96 CA854IR 28 35		
	[OM402.983]	03.91- 09.96 CA1035IR 28 80	03.91- 09.96	CS191 24 5.4
		03.91- 09.96 CA333IR 28 55		
		03.91- 09.96 CA854IR 28 35		
	[OM402.984]	09.91- 09.96 CA1035IR 28 80	09.91- 09.96	CS191 24 5.4
		09.91- 09.96 CA333IR 28 55		
		09.91- 09.96 CA854IR 28 35		
	[OM402.985]	09.91- 09.96 CA1035IR 28 80	09.91- 09.96	CS191 24 5.4
		09.91- 09.96 CA333IR 28 55		
		09.91- 09.96 CA854IR 28 35		
	[OM402.987]	03.91- 09.96 CA1035IR 28 80	03.91- 09.96	CS191 24 5.4
		03.91- 09.96 CA333IR 28 55		
		03.91- 09.96 CA854IR 28 35		
3538 14.6	(SK)[OM440.970]	03.91- 09.96 CA854IR 28 35	03.91- 09.96	CS191 24 5.4
	[OM440.975]	03.91- 09.96 CA854IR 28 35	03.91- 09.96	CS191 24 5.4
	[OM440.979]	03.91- 09.96 CA854IR 28 35	03.91- 09.96	CS191 24 5.4
	[OM440.982]	03.91- 09.96 CA854IR 28 35	03.91- 09.96	CS191 24 5.4
	[OM440.983]	03.91- 09.96 CA854IR 28 35	03.91- 09.96	CS191 24 5.4
	[OM440.984]	03.91- 09.96 CA854IR 28 35	03.91- 09.96	CS191 24 5.4
	[OM440.985]	05.92- 09.96 CA854IR 28 35	05.92- 09.96	CS191 24 5.4
	[OM440.987]	03.91- 09.96 CA333IR 28 55	03.91- 09.96	CS191 24 5.4
		03.91- 09.96 CA854IR 28 35		
	[OM440.990]	09.91- 09.96 CA1035IR 28 80	09.91- 09.96	CS191 24 5.4
		09.91- 09.96 CA333IR 28 55		
		09.91- 09.96 CA854IR 28 35		
	[OM442.989]	03.91- 09.96 CA854IR 28 35	03.91- 09.96	CS191 24 5.4
	[OM442.997]		03.91-	CS191 24 5.4
	[OM446.924]	09.91- 09.96 CA1035IR 28 80	09.91- 09.96	CS191 24 5.4
		09.91- 09.96 CA333IR 28 55		
		09.91- 09.96 CA854IR 28 35		
	[OM446.926]	03.91- 09.96 CA333IR 28 55	03.91- 09.96	CS191 24 5.4
		03.91- 09.96 CA854IR 28 35		
		09.91- 09.96 CA1035IR 28 80		
	[OM446.930]	01.94- 09.96 CA1035IR 28 80	01.94- 09.96	CS191 24 5.4
		01.94- 09.96 CA333IR 28 55		
	[OM446.931]	01.94- 09.96 CA1035IR 28 80	01.94- 09.96	CS191 24 5.4
	[OM446.939]	05.92- 09.96 CA854IR 28 35	03.91- 09.96	CS191 24 5.4
		01.94- 09.96 CA1035IR 28 80		
	[OM446.940]	01.94- 09.96 CA1035IR 28 80	03.91- 09.96	CS191 24 5.4
		01.94- 09.96 CA854IR 28 35		
3544 14.6	(NG)[OM442.951]	08.73- 09.96 CA1035IR 28 80	08.73- 09.96	CS191 24 5.4
		09.87- 03.92 CA333IR 28 55		
		09.87- 03.92 CA854IR 28 35		



	[OM442.953]	09.87- 03.92 09.87- 03.92 10.88- 03.92	CA333IR 28 55 CA854IR 28 35 CA1035IR 28 80		09.87- 03.92	CS191	24 5.4
	[OM442.980]	08.73- 09.96 09.87- 03.92 09.87- 03.92	CA1035IR 28 80 CA333IR 28 55 CA854IR 28 35		08.73- 09.96	CS191	24 5.4
	(SK)[OM440.970]	03.91- 09.96 03.91- 09.96 03.91- 09.96 03.91- 09.96	CA1035IR 28 80 CA333IR 28 55 CA568IR 28 30 CA854IR 28 35		03.91- 09.96	CS191	24 5.4
	[OM440.978]	01.92- 09.96 01.92- 09.96 01.92- 09.96	CA1035IR 28 80 CA333IR 28 55 CA854IR 28 35		01.92- 09.96	CS191	24 5.4
	[OM440.980]	03.91- 09.96 03.91- 09.96 03.91- 09.96	CA1035IR 28 80 CA333IR 28 55 CA854IR 28 35		03.91- 09.96	CS191	24 5.4
	[OM440.985]	03.91- 09.96 03.91- 09.96 03.91- 09.96	CA1035IR 28 80 CA333IR 28 55 CA854IR 28 35		03.91- 09.96	CS191	24 5.4
	[OM446.922]	01.92- 09.96 01.92- 09.96 01.92- 09.96	CA1035IR 28 80 CA333IR 28 55 CA854IR 28 35		01.92- 09.96	CS191	24 5.4
3548 14.6	(SK)[OM440.975]	05.92- 09.96 05.92- 09.96	CA568IR 28 30 CA854IR 28 35		05.92- 09.96	CS191	24 5.4
	[OM442.993]	05.92- 09.96 05.92- 09.96	CA568IR 28 30 CA854IR 28 35		05.92- 09.96	CS191	24 5.4
3550 14.6	(SK)[OM440.975]	03.91- 09.96 03.91- 09.96 03.91- 09.96	CA1035IR 28 80 CA333IR 28 55 CA854IR 28 35		03.91- 09.96	CS191	24 5.4
	[OM440.976]	05.92- 09.96 05.92- 09.96 05.92- 09.96	CA1035IR 28 80 CA333IR 28 55 CA854IR 28 35		12.93-	CS191	24 5.4
	[OM440.982]	03.91- 09.96 03.91- 09.96 03.91- 09.96	CA1035IR 28 80 CA333IR 28 55 CA854IR 28 35		03.91- 09.96	CS191	24 5.4
	[OM442.993]	05.92- 09.96	CA1035IR 28 80		05.92- 09.96	CS191	24 5.4
	[OM442.997]	03.91- 09.96 03.91- 09.96 03.91- 09.96 05.92- 09.96	CA1035IR 28 80 CA333IR 28 55 CA854IR 28 35 CA1236IR 28 140		03.91- 09.96	CS191	24 5.4
3553 14.6	(SK)[OM440.975]	05.92- 09.96 05.92- 09.96 05.92- 09.96	CA1035IR 28 80 CA333IR 28 55 CA854IR 28 35		05.92- 09.96	CS191	24 5.4
	[OM442.993]	05.92- 09.96	CA1035IR 28 80		05.92- 09.96	CS191	24 5.4
	[OM442.997]	05.92- 09.96	CA1035IR 28 80		05.92- 09.96	CS191	24 5.4
	[OM446.920]	01.96- 09.96	CA1035IR 28 80		01.96- 09.96	CS191	24 5.4
	[OM446.933]	01.96- 09.96	CA1035IR 28 80		01.96- 09.96	CS191	24 5.4
3836 18.3	(NG)[OM423.907]	11.81- 03.91 11.81- 03.91 11.81- 03.91 11.81- 03.91 11.81- 03.91	CA1035IR 28 80 CA187IR 28 27 CA333IR 28 55 CA568IR 28 30 CA854IR 28 35		11.81- 03.91	CS198	24 6.0
3850 18.3	(NG)[OM423.950]	09.85- 08.94 10.88- 08.94	CA333IR 28 55 CA1035IR 28 80		09.85- 08.94	CS198	24 6.0
4140 11.9	(Actros)[OM541.923]	04.97- 10.02 04.97- 10.02 04.97- 10.02 04.97- 10.02	CA1505IR 28 100 CA1593IR 28 80 CA1666IR 28 80 CA1739IR 28 100		04.97- 10.02 AC 04.97- 10.02 04.97- 10.02 04.97- 10.02	CS1463 CS1168# CS1269 CS1077	24 6.2 MI 24 7.8 24 6.2 BO 24 6.2
	[OM541.924]	04.97- 10.02 04.97- 10.02 04.97- 10.02 04.97- 10.02	CA1505IR 28 100 CA1593IR 28 80 CA1666IR 28 80 CA1739IR 28 100		04.97- 10.02 04.97- 10.02 AC 04.97- 10.02 04.97- 10.02	CS1269 CS1463 CS1168# CS1077	24 6.2 BO 24 6.2 MI 24 7.8 24 6.2
	[OM541.944]	04.03- 04.03- 04.03- 04.03-	CA1505IR 28 100 CA1593IR 28 80 CA1666IR 28 80 CA1739IR 28 100		04.03- 04.03- 04.03-	CS1269 CS1463 CS1077	24 6.2 BO 24 6.2 MI 24 6.2
4141 11.9	(Actros MP2 / MP3)[OM541.974]	04.03-	CA1593IR 28 80		04.03-	CS1077	24 6.2
	[OM541.990]	04.03-	CA1593IR 28 80		04.03-	CS1077	24 6.2
	[OM541.991]	04.03-	CA1739IR 28 100		04.03-	CS1269	24 6.2
4141 12.0	(Actros)[OM541.974]	04.03- 04.03-	CA1666IR 28 80 CA1739IR 28 100		04.03- 04.03-	CS1463 CS1269	24 6.2 MI 24 6.2 BO
4143 11.9	(Actros)[OM541.921]	04.97- 10.02 04.97- 10.02 04.97- 10.02 04.97- 10.02	CA1505IR 28 100 CA1593IR 28 80 CA1666IR 28 80 CA1739IR 28 100		AC 04.97- 10.02 04.97- 10.02 04.97- 10.02 04.97- 10.02	CS1168# CS1077 CS1269 CS1463	24 7.8 24 6.2 24 6.2 BO 24 6.2 MI
	[OM541.925]	04.97- 10.02 04.97- 10.02 04.97- 10.02 04.97- 10.02	CA1505IR 28 100 CA1593IR 28 80 CA1666IR 28 80 CA1739IR 28 100		AC 04.97- 10.02 04.97- 10.02 04.97- 10.02 04.97- 10.02	CS1168# CS1077 CS1463 CS1269	24 7.8 24 6.2 24 6.2 MI 24 6.2 BO
4144 11.9	(Actros)[OM541.925]	04.03- 04.03- 04.03- 04.03-	CA1505IR 28 100 CA1593IR 28 80 CA1666IR 28 80 CA1739IR 28 100		04.03- 04.03- 04.03- 04.03-	CS1077 CS1269 CS1463	24 6.2 24 6.2 BO 24 6.2 MI
	[OM541.946]	04.03- 04.03- 04.03- 04.03-	CA1505IR 28 100 CA1593IR 28 80 CA1666IR 28 80 CA1739IR 28 100		04.03- 04.03- 04.03- 04.03-	CS1269 CS1077 CS1463	24 6.2 BO 24 6.2 24 6.2 MI
	[OM541.976]	04.03- 04.03- 04.03- 04.03-	CA1505IR 28 100 CA1593IR 28 80 CA1666IR 28 80 CA1739IR 28 100		04.03- 04.03- 04.03- 04.03-	CS1463 CS1077 CS1269	24 6.2 MI 24 6.2 24 6.2 BO
	(Actros MP2 / MP3)[OM541.946]	04.03-	CA1505IR 28 100		04.03-	CS1077	24 6.2
	[OM541.947]	04.03-	CA1505IR 28 100		04.03-	CS1077	24 6.2
	[OM541.976]	04.03- 04.03-	CA1505IR 28 100 CA1593IR 28 80		04.03- 04.03-	CS1077	24 6.2
	[OM541.992]	04.03-	CA1505IR 28 100		04.03-	CS1077	24 6.2
	[OM541.993]	04.03- 04.03-	CA1505IR 28 100 CA1593IR 28 80		04.03- 04.03-	CS1077	24 6.2
4144 12.0	(Actros)[OM541.976]	04.03- 04.03-	CA1666IR 28 80 CA1739IR 28 100		04.03- 04.03-	CS1463 CS1269	24 6.2 MI 24 6.2 BO
4146 11.9	(Actros)[OM541.948]	04.03- 04.03- 04.03-	CA1593IR 28 80 CA1666IR 28 80 CA1739IR 28 100		04.03- 04.03- 04.03-	CS1269 CS1463 CS1077	24 6.2 BO 24 6.2 MI 24 6.2
	(Actros MP2 / MP3)[OM541.948]	04.03-	CA1593IR 28 80				
	[OM541.949]	04.03-	CA1593IR 28 80				
	[OM541.980]	04.03-	CA1593IR 28 80				
	[OM541.994]	04.03-	CA1593IR 28 80				



MERCEDES-BENZ Continued

4148 11.9	(Actros)[OM541.948]	03.00-	CA1593IR	28 80	04.03-	CS1269	24 6.2	BO
		03.00-	CA1666IR	28 80	04.03-	CS1463	24 6.2	MI
		03.00-	CA1739IR	28 100				
	(Actros MP2 / MP3)[OM541.948]	04.03-	CA1739IR	28 100				
	[OM541.978]	04.03-	CA1739IR	28 100				
		04.03-	CA1739IR	28 100				
4148 15.9	(Actros)[OM542.921]	04.97- 10.02	CA1505IR	28 100	04.97- 10.02	CS1077	24 6.2	
		04.97- 10.02	CA1593IR	28 80	AC 04.97- 10.02	CS1168#	24 7.8	
		04.97- 10.02	CA1666IR	28 80	04.97- 10.02	CS1269	24 6.2	BO
		04.97- 10.02	CA1739IR	28 100	04.97- 10.02	CS1463	24 6.2	MI
	[OM542.925]	04.97- 10.02	CA1505IR	28 100	AC 04.97- 10.02	CS1168#	24 7.8	
		04.97- 10.02	CA1593IR	28 80	04.97- 10.02	CS1077	24 6.2	
		04.97- 10.02	CA1666IR	28 80	04.97- 10.02	CS1463	24 6.2	MI
		04.97- 10.02	CA1739IR	28 100	04.97- 10.02	CS1269	24 6.2	BO
4150 15.9	(Actros MP2 / MP3)[OM542.940]	04.03-	CA1505IR	28 100				
		[OM542.941]	04.03-	CA1505IR	28 100			
4151 15.9	(Actros MP2 / MP3)[OM542.961]	04.03-	CA1739IR	28 100				
4151 16.0	(Actros)[OM542.960]	05.05-	CA1666IR	28 80	05.05-	CS1269	24 6.2	BO
		05.05-	CA1739IR	28 100	05.05-	CS1463	24 6.2	MI
4160 15.9	(Actros)[OM542.956]	10.02-	CA1035IR	28 80				
		[OM542.957]	10.02-	CA1035IR	28 80			
4844 14.6	(SK)[OM440.970]	12.91- 08.94	CA333IR	28 55	12.91- 08.94	CS191	24 5.4	
		12.91- 08.94	CA854IR	28 35				
	[OM440.979]	12.91- 08.94	CA333IR	28 55	12.91- 08.94	CS191	24 5.4	
		12.91- 08.94	CA854IR	28 35				
	[OM440.984]	03.91- 09.96	CA854IR	28 35	03.91- 09.96	CS191	24 5.4	
	[OM446.940]	03.91- 09.96	CA1035IR	28 80	03.91- 09.96	CS191	24 5.4	
4850 18.3	(SK)[OM423.950]				07.87- 08.96	CS191	24 5.4	
1427 F 11.0	(MK)[OM445.936]	02.93- 09.96	CA1035IR	28 80	02.93- 09.96	CS191	24 5.4	
1850 K 14.6	(SK)[OM442.997]	07.88- 08.94	CA1035IR	28 80				
1861 LS 15.9	(Actros)[OM542.958]	05.05-	CA1739IR	28 100	05.05-	CS1463	24 6.2	
4140 B 12.0	(Axor)[OM457.956]	01.11-	CA1739IR	28 100				
		[OM457.957]	01.11-	CA1739IR	28 100			
4148 K 12.0	(Actros)[OM541.948]	04.03-	CA1739IR	28 100				
O 100 2.9 Diesel	[OM602.940]	01.94-	CA1072IR	14 55	01.94-	CS576	12 2.2	
		06.96-	CA1062IR	14 90				
		ACPS 01.94-	CA321IR	14 55				
O 301 6.0	[OM366.917]				06.86- 05.87	CS120	24 4.0	
		[OM366.965]			02.86- 05.87	CS120	24 4.0	
O 302 5.7	[OM352.980]				12.69- 12.74	CS194	24 4.5	
		[OM352.993]			12.69- 12.74	CS194	24 4.5	
O 302 8.7	[OM360.916]				05.69- 12.74	CS194	24 4.5	
		[OM360.979]			05.69- 12.74	CS194	24 4.5	
	[OM360.980]			05.69- 12.74	CS194	24 4.5		
	[OM360.981]			05.69- 12.74	CS194	24 4.5		
	[OM360.985]			05.69- 12.74	CS194	24 4.5		
	[OM421.908]	01.80- 04.89	CA824IR	28 120	01.80- 04.89	CS191	24 5.4	
O 303 11.0	[OM421.908]	01.87- 04.89	CA1236IR	28 140	05.83- 09.87	CS198	24 6.0	
		AC 01.80- 04.89	CA824IR	28 120				
[OM421.951]	01.87- 04.89	CA1236IR	28 140	11.85- 04.89	CS191	24 5.4		
	AC 01.87- 04.89	CA824IR	28 120	11.85- 09.87	CS198	24 6.0		
[OM441.908]	01.80- 09.92	CA824IR	28 120	01.80- 04.89	CS191	24 5.4		
	01.87- 09.92	CA1236IR	28 140	05.83- 09.87	CS198	24 6.0		
[OM441.909]	AC 01.80- 04.89	CA824IR	28 120					
	01.80- 09.92	CA824IR	28 120	01.80- 04.89	CS191	24 5.4		
[OM441.911]	01.87- 09.92	CA1236IR	28 140	05.83- 09.87	CS198	24 6.0		
	AC 01.80- 04.89	CA824IR	28 120	01.80- 04.89	CS191	24 5.4		
[OM441.918]	01.87- 01.89	CA1236IR	28 140	01.80- 01.89	CS191	24 5.4		
	01.87- 04.89	CA824IR	28 120	05.83- 09.87	CS198	24 6.0		
[OM441.950]	AC 01.80- 01.89	CA824IR	28 120					
	12.87- 09.92	CA1236IR	28 140	12.87- 09.92	CS191	24 5.4		
[OM441.953]	AC 12.87- 09.92	CA824IR	28 120					
	12.87- 09.92	CA1236IR	28 140	12.87- 09.92	CS191	24 5.4		
O 303 12.8	[OM402.907]	12.78- 06.83	CA824IR	28 120	03.77- 06.83	CS191	24 5.4	
O 303 14.6	[OM422.908]	01.80- 12.83	CA824IR	28 120	03.75- 02.77	CS198	24 6.0	
		01.87- 09.87	CA1236IR	28 140	01.80- 09.87	CS191	24 5.4	
[OM422.917]	AC 01.80- 09.87	CA854IR	28 35	05.83- 09.87	CS198	24 6.0		
	AC 01.87- 09.87	CA824IR	28 120	01.80- 09.87	CS191	24 5.4		
[OM422.951]	08.80- 12.83	CA824IR	28 120	05.83- 09.87	CS198	24 6.0		
	01.87- 09.87	CA1236IR	28 140	08.80- 09.87	CS191	24 5.4		
[OM422.963]	AC 01.87- 09.87	CA824IR	28 120					
	08.80- 12.83	CA824IR	28 120	05.83- 09.87	CS198	24 6.0		
[OM442.954]	01.87- 09.87	CA1236IR	28 140	08.80- 09.87	CS191	24 5.4		
	AC 01.87- 09.87	CA824IR	28 120					
[OM442.955]	09.87- 09.92	CA1236IR	28 140	09.87- 09.92	CS191	24 5.4		
	AC 09.87- 09.92	CA824IR	28 120					
[OM442.960]	09.87- 09.92	CA1236IR	28 140	09.87- 09.92	CS191	24 5.4		
	AC 09.87- 09.92	CA824IR	28 120					
[OM442.961]	09.87- 09.92	CA1236IR	28 140	09.87- 09.92	CS191	24 5.4		
	AC 09.87- 09.92	CA824IR	28 120					
O 303 15.1	[OM442.910]	09.87- 09.92	CA1236IR	28 140	09.87- 09.92	CS191	24 5.4	
		AC 09.87- 09.92	CA824IR	28 120				
[OM442.911]	09.87- 09.92	CA1236IR	28 140	09.87- 09.92	CS191	24 5.4		
	AC 09.87- 09.92	CA824IR	28 120					
[OM442.918]	09.87- 09.92	CA1236IR	28 140	09.87- 09.92	CS191	24 5.4		
	AC 09.87- 09.92	CA824IR	28 120					
[OM442.919]	09.87- 09.92	CA1236IR	28 140	09.87- 09.92	CS191	24 5.4		
	AC 09.87- 09.92	CA824IR	28 120					
[OM442.939]	09.87- 09.92	CA1236IR	28 140	09.87- 09.92	CS191	24 5.4		
	AC 09.87- 09.92	CA824IR	28 120					
O 303 15.9	[OM403.918]	12.78- 06.83	CA824IR	28 120	07.75- 06.83	CS198	24 6.0	
O 303 9.6	[OM401.907]	12.78- 06.83	CA824IR	28 120	10.74- 02.77	CS198	24 6.0	
					03.77- 06.83	CS191	24 5.4	
[OM401.908]		12.78- 06.83	CA824IR	28 120	10.74- 02.77	CS198	24 6.0	
					03.77- 06.83	CS191	24 5.4	



	[OM401.912]	12.78- 06.83	CA824IR	28 120		03.77- 06.83	CS191	24 5.4	
						10.74- 02.77	CS198	24 6.0	
O 305 11.0	[OM407.905]					04.73- 07.77	CS198	24 6.0	
	[OM407.908]					04.73- 07.77	CS198	24 6.0	
	[OM407.909]					04.73- 07.77	CS198	24 6.0	
	[OM407.911]					04.73- 07.77	CS198	24 6.0	
O 305 11.4	[OM407.913]	12.78- 05.87	CA824IR	28 120		11.76- 05.87	CS198	24 6.0	
	[OM407.914]	12.78- 05.87	CA824IR	28 120		11.76- 05.87	CS198	24 6.0	
	[OM407.917]	12.78- 05.87	CA824IR	28 120		11.76- 05.87	CS198	24 6.0	
	[OM407.919]	12.78- 05.87	CA824IR	28 120		02.78- 05.87	CS198	24 6.0	
	[OM407.951]	02.79- 05.87	CA824IR	28 120		02.79- 05.87	CS198	24 6.0	
	[OM407.955]	02.79- 05.87	CA824IR	28 120		02.79- 05.87	CS198	24 6.0	
O 305 8.7	[OM360.911]					01.69- 05.73	CS194	24 4.5	
O 307 11.0	[OM407.907]					04.73- 07.77	CS198	24 6.0	
	[OM407.911]					04.73- 07.77	CS198	24 6.0	
O 307 11.4	[OM407.915]	12.78- 07.87	CA824IR	28 120		11.76- 07.87	CS198	24 6.0	
	[OM407.916]	01.87- 07.87	CA824IR	28 120		11.76- 07.77	CS198	24 6.0	
	[OM407.918]	01.87- 07.87	CA824IR	28 120		11.76- 07.77	CS198	24 6.0	
	[OM407.955]					11.76- 07.87	CS191	24 5.4	
O 309 5.7	[OM353.969]	05.77- 02.89	CA186IR	14 55					
O 309 B 2.2	[M115.921]					01.68- 02.89	CS81	12 1.5	
O 309 B 2.3	[M102.943]	01.68- 02.89	CA87IR	14 55		01.68- 02.89	CS268	12 1.5	
	[M115.952]	01.68- 02.89	CA69IR	14 35		01.68- 02.89	CS81	12 1.5	
O 309 D 2.2	[OM615.910]					01.68- 12.74	CS113	12 2.0	
O 309 D 2.4	[OM616.910]	01.75- 12.88	CA69IR	14 35		01.75- 12.88	CS113	12 2.0	
O 309 D 3.8	[OM314.946]					01.68- 12.69	CS194	24 4.5	
	[OM314.948]								
		08.79- 08.82	CA186IR	14 55		01.70- 01.73	CS194	24 4.5	
		09.82- 10.86	CA187IR	28 27		02.73- 12.86	CS120	24 4.0	
		11.86-	CA568IR	28 30					
	[OM314.959]	08.79- 08.82	CA186IR	14 55		08.74- 02.89	CS120	24 4.0	
		09.82- 10.86	CA187IR	28 27					
		11.86- 02.89	CA333IR	28 55					
		11.86- 02.89	CA568IR	28 30					
O 345 12.0	(Conecto)[OM457.942]	11.01-	CA1236IR	28 140		11.01-	CS1333	24 6.2	
		11.01-	CA1659IR	28 140					
		11.01-	CA1924IR	28 180					
O 345 6.4	(Conecto)[OM906.960]	11.01-	CA1505IR	28 100		11.01-	CS1112	24 4.0	BO
		11.01-	CA1659IR	28 140		11.01-	CS1381	24 4.0	DR
		11.01-	CA1924IR	28 180					
O 350 11.0	(Turismo)[OM441.980]	10.95- 09.06	CA1236IR	28 140		10.95- 09.06	CS191	24 5.4	
	[OM445.934]	10.95- 09.06	CA1236IR	28 140		10.95- 09.06	CS191	24 5.4	
O 350 12.0	(Turismo)[OM457.944]	09.03-	CA1659IR	28 140		09.03-	CS1333	24 6.2	
		09.03-	CA1924IR	28 180					
O 350 12.8	(Turismo)[OM402.970]	10.95- 09.06	CA1236IR	28 140		10.95- 09.06	CS191	24 5.4	
O 350 14.6	(Turismo)[OM446.938]	08.95- 09.06	CA1236IR	28 140		10.95- 09.06	CS191	24 5.4	
O 402 6.0	[OM366.917]	02.86- 02.01	CA1236IR	28 140		02.86- 02.01	CS1279	24 4.0	
	[OM366.965]	06.86- 02.01	CA1236IR	28 140		02.86- 02.01	CS1279	24 4.0	
O 403 12.0	[OM457.944]	09.03-	CA1236IR	28 140		09.03-	CS1333	24 6.2	
		09.03-	CA1659IR	28 140					
		09.03-	CA1924IR	28 180					
O 404 11.0	[OM441.980]	09.91- 10.99	CA1236IR	28 140		09.91- 10.99	CS191	24 5.4	
	[OM445.934]	09.91- 10.99	CA1236IR	28 140		09.91- 10.99	CS191	24 5.4	
	[OM445.935]	01.95- 10.99	CA1236IR	28 140		09.94- 10.99	CS191	24 5.4	
O 404 11.3	[OM441.921]	09.91- 01.92	CA1236IR	28 140		09.91- 01.92	CS191	24 5.4	
	[OM441.922]	09.91- 01.92	CA1236IR	28 140		09.91- 01.92	CS191	24 5.4	
O 404 12.8	[OM402.970]	09.91- 10.99	CA1236IR	28 140		09.91- 10.99	CS191	24 5.4	
O 404 14.6	[OM446.934]	01.95- 10.99	CA1236IR	28 140		01.95- 10.99	CS191	24 5.4	
	[OM446.938]	01.95- 10.99	CA1236IR	28 140		01.95- 10.99	CS191	24 5.4	
O 404 15.1	[OM442.930]	09.91- 01.92	CA1236IR	28 140		09.91- 01.92	CS191	24 5.4	
	[OM442.931]	09.91- 01.92	CA1236IR	28 140		09.91- 01.92	CS191	24 5.4	
O 404 9.6	[OM401.970]	09.91- 10.99	CA1236IR	28 140		09.91- 10.99	CS191	24 5.4	
O 404 9.8	[OM401.974]	09.91- 10.99	CA1236IR	28 140		09.91- 10.99	CS191	24 5.4	
O 405 12.0	[OM427.905]	12.84- 12.86	CA1236IR	28 140		12.84- 12.86	CS198	24 6.0	
	[OM427.910]	11.85- 12.86	CA1236IR	28 140		11.85- 12.86	CS198	24 6.0	
	[OM427.911]	11.85- 02.01	CA1236IR	28 140		11.85- 02.01	CS198	24 6.0	
	[OM427.950]	11.85- 02.01	CA1236IR	28 140		11.85- 02.01	CS198	24 6.0	
	[OM447.905]	11.86- 02.01	CA1236IR	28 140		11.86- 02.01	CS198	24 6.0	
	[OM447.907]	11.85- 02.01	CA1236IR	28 140		11.85- 02.01	CS198	24 6.0	
	[OM447.908]	11.85-	CA1236IR	28 140		11.85-	CS198	24 6.0	
	[OM447.910]	11.85- 02.01	CA1236IR	28 140		11.85- 02.01	CS198	24 6.0	
	[OM447.911]	11.86- 02.01	CA1236IR	28 140		11.86- 02.01	CS198	24 6.0	
	[OM447.913]	11.86- 02.01	CA1236IR	28 140		11.86- 02.01	CS198	24 6.0	
	[OM447.914]	11.86- 12.97	CA1236IR	28 140		11.86- 12.97	CS198	24 6.0	
	[OM447.950]	11.85- 02.01	CA1236IR	28 140		11.85- 02.01	CS198	24 6.0	
	[OM447.951]	11.85- 02.01	CA1236IR	28 140		11.85- 02.01	CS198	24 6.0	
	[OM447.955]	11.85- 02.01	CA1236IR	28 140		11.85- 02.01	CS198	24 6.0	
	[OM447.956]	11.85- 02.01	CA1236IR	28 140		11.85- 02.01	CS198	24 6.0	
	[OM447.957]	11.85- 12.97	CA1236IR	28 140		11.85- 12.97	CS198	24 6.0	
	[OM447.959]	11.85- 12.97	CA1236IR	28 140		11.85- 12.97	CS198	24 6.0	
	[OM447.970]	11.86- 12.97	CA1236IR	28 140		11.86- 12.97	CS198	24 6.0	
	[OM447.971]	11.85- 12.97	CA1236IR	28 140		11.85- 12.97	CS198	24 6.0	
	[OM447.972]	11.91- 12.97	CA1236IR	28 140		11.91- 12.97	CS198	24 6.0	
	[OM447.973]	11.86- 12.97	CA1236IR	28 140		11.86- 12.97	CS198	24 6.0	
	[OM447.974]	11.85-	CA1236IR	28 140		11.85-	CS198	24 6.0	
	[OM447.975]	11.91- 12.97	CA1236IR	28 140		11.91- 12.97	CS198	24 6.0	
	[OM447.976]	11.85- 12.97	CA1236IR	28 140		11.85- 12.97	CS198	24 6.0	
	[OM447.981]	11.91- 12.97	CA1236IR	28 140		11.91- 12.97	CS198	24 6.0	
	[OM447.986]	11.91-	CA1236IR	28 140		11.91-	CS198	24 6.0	
O 405 G 12.0	[OM447.977]	09.91- 12.97	CA1236IR	28 140		09.91- 12.97	CS198	24 6.0	
	[OM447.980]	11.86- 02.01	CA1236IR	28 140		09.91- 02.01	CS198	24 6.0	
O 405 GN 12.0	[OM447.978]	11.85- 12.97	CA1236IR	28 140		11.85- 12.97	CS198	24 6.0	
	[OM447.979]	09.91- 12.97	CA1236IR	28 140		09.91- 12.97	CS198	24 6.0	
	[OM447.984]	09.91- 12.97	CA1236IR	28 140		09.91- 12.97	CS198	24 6.0	
O 405 GNTD 12.0	[OM447.998]	09.91-	CA1236IR	28 140		09.91-	CS198	24 6.0	
O 407 12.0	[OM447.906]	03.87- 02.01	CA1236IR	28 140		03.87- 02.01	CS198	24 6.0	
	[OM447.908]	03.87- 02.01	CA1236IR	28 140		03.87- 02.01	CS198	24 6.0	
	[OM447.954]	03.87- 02.01	CA1236IR	28 140		03.87- 02.01	CS198	24 6.0	
	[OM447.985]	11.91- 02.01	CA1236IR	28 140		02.91- 02.01	CS198	24 6.0	
	[OM447.990]	03.87- 02.01	CA1236IR	28 140		03.87- 02.01	CS198	24 6.0	
	[OM447.991]	11.91- 02.01	CA1236IR	28 140		02.91- 02.01	CS198	24 6.0	
O 408 12.0	[OM447.912]	01.91- 12.01	CA1236IR	28 140		01.91- 12.01	CS198	24 6.0	
	[OM447.958]	01.91- 12.01	CA1236IR	28 140		01.91- 12.01	CS198	24 6.0	
	[OM447.987]	08.92- 12.01	CA1236IR	28 140		08.92- 12.01	CS198	24 6.0	
	[OM447.992]	01.91- 12.01	CA1236IR	28 140		01.91- 12.01	CS198	24 6.0	
	[OM447.993]	08.92- 12.01	CA1236IR	28 140		08.92- 12.01	CS198	24 6.0	
O 500 12.0	(Touro)[OM457.944]	10.01-	CA1659IR	28 140		10.01-	CS1463	24 6.2	MI
		10.01-	CA1924IR	28 180		10.01-	CS1269	24 6.2	BO
						10.01-	CS1333	24 6.2	MI



MERCEDES-BENZ Continued

O 510 6.4	(Tourino)[OM906.961]	10.03-	CA1236IR	28 140	10.03-	CS1112	24 4.0	
		10.03-	CA1505IR	28 100				
		10.03-	CA1659IR	28 140				
		10.03-	CA1924IR	28 180				
[OM906.962]		10.03-	CA1236IR	28 140	10.03-	CS1112	24 4.0	
		10.03-	CA1505IR	28 100				
		10.03-	CA1659IR	28 140				
		10.03-	CA1924IR	28 180				
O 520 4.3	(Cito)[OM904.942]	06.99-	CA1505IR	28 100	01.99-	CS1112	24 4.0 BO	
		06.99-	CA1659IR	28 140				01.99-
O 530 G 6.4	(Axor)[OM909.901]	01.99- 09.04	CA1505IR	28 100	01.99- 09.04	CS1381	24 4.0 DR	
		01.99- 09.04	CA1659IR	28 140				
		01.99- 09.04	CA1739IR	28 100				
		01.99- 09.04	CA1924IR	28 180				
	(Citaro)[OM457.935]	01.98- 09.04	CA1236IR	28 140	01.99- 09.04	CS1333	24 6.2	
		01.98- 09.04	CA1659IR	28 140				
	[OM906.930]		01.99- 09.04	CA1505IR	28 100	01.99- 09.04	CS1381	24 4.0 DR
			01.99- 09.04	CA1659IR	28 140			
			01.99- 09.04	CA1924IR	28 180			
			01.99- 09.04	CA1505IR	28 100			
	[OM906.960]		01.99- 09.04	CA1505IR	28 100	01.99- 09.04	CS1112	24 4.0 BO
			01.99- 09.04	CA1659IR	28 140			
01.99- 09.04			CA1739IR	28 100				
01.99- 09.04			CA1924IR	28 180				
[OM906.961]		01.99- 09.04	CA1505IR	28 100	01.99- 09.04	CS1112	24 4.0	
		01.99- 09.04	CA1659IR	28 140				
		01.99- 09.04	CA1924IR	28 180				
		01.99- 09.04	CA1505IR	28 100				
[OM909.921]		01.99- 09.04	CA1505IR	28 100	01.99- 09.04	CS1381	24 4.0 DR	
		01.99- 09.04	CA1659IR	28 140				
		01.99- 09.04	CA1739IR	28 100				
		01.99- 09.04	CA1924IR	28 180				
O 530 GNG 12.0	(Citaro)[M476.930]	04.00-	CA1236IR	28 140	04.00-	CS198	24 6.0	
		04.00-	CA1659IR	28 140				
		04.00-	CA1924IR	28 180				
O 530 L 6.4	(Citaro)[OM906.930]	01.99- 09.04	CA1505IR	28 100	01.99- 09.04	CS1112	24 4.0 BO	
		01.99- 09.04	CA1659IR	28 140				
		01.99- 09.04	CA1924IR	28 180				
	[OM906.960]		01.01-	CA1505IR	28 100	01.99-	CS1112	24 4.0
			01.01-	CA1659IR	28 140			
			01.01-	CA1739IR	28 100			
			01.01-	CA1924IR	28 180			
	[OM909.901]		01.99- 09.04	CA1505IR	28 100	01.99- 09.04	CS1112	24 4.0
			01.99- 09.04	CA1659IR	28 140			
			01.99- 09.04	CA1739IR	28 100			
			01.99- 09.04	CA1924IR	28 180			
	[OM909.921]		01.99- 09.04	CA1505IR	28 100	01.99- 09.04	CS1112	24 4.0
01.99- 09.04			CA1659IR	28 140				
01.99- 09.04			CA1739IR	28 100				
01.99- 09.04			CA1924IR	28 180				
O 530 N 12.0	(Citaro)[OM457.934]	01.98- 09.04	CA1924IR	28 180	01.98- 09.04	CS1333	24 6.2	
		01.98- 09.04	CA1659IR	28 140				01.98- 09.04
	[OM457.942]		01.98-	CA1236IR	28 140	01.98-	CS1333	24 6.2
			04.99-	CA1659IR	28 140			
			04.99-	CA1924IR	28 180			
O 530 N 6.4	(Citaro)[OM906.962]	04.00-	CA1505IR	28 100	04.00-	CS1112	24 4.0	
		04.00-	CA1659IR	28 140				
		04.00-	CA1666IR	28 80				
		04.00-	CA1739IR	28 100				
	[OM906.963]		04.00-	CA1924IR	28 180	04.99-	CS1112	24 4.0
			04.99-	CA1505IR	28 100			
			04.99-	CA1659IR	28 140			
			04.99-	CA1739IR	28 100			
	O 530 N3 6.4	(Citaro)[OM906.930]	01.98- 09.04	CA1505IR	28 100	01.98- 09.04	CS1381	24 4.0 DR
			01.98- 09.04	CA1659IR	28 140			
			01.98- 09.04	CA1924IR	28 180			
			01.98-	CA1505IR	28 100			
[OM906.931]		01.98-	CA1659IR	28 140	01.98-	CS1381	24 4.0 DR	
		01.98-	CA1659IR	28 140				
		01.98-	CA1924IR	28 180				
		01.98-	CA1505IR	28 100				
O 530 NG 12.0	(Citaro)[M476.930]	04.00-	CA1236IR	28 140	04.00-	CS198	24 6.0	
		04.00-	CA1659IR	28 140				
		04.00-	CA1924IR	28 180				
	[M476.932]		06.00-	CA1236IR	28 140	06.00-	CS198	24 6.0
			06.00-	CA1659IR	28 140			
			06.00-	CA1924IR	28 180			
	[M476.933]		04.00-	CA1236IR	28 140	04.00-	CS198	24 6.0
			04.00-	CA1659IR	28 140			
			04.00-	CA1924IR	28 180			
	[M476.934]		04.00-	CA1236IR	28 140	04.00-	CS198	24 6.0
			04.00-	CA1659IR	28 140			
			04.00-	CA1924IR	28 180			
O 550 12.0	(Integro)[OM457.952]	01.06-	CA1236IR	28 140	01.06-	CS1463	24 6.2	
O 580 RHD 12.0	(Travego)[OM457.936]	10.99- 02.06	CA1236IR	28 140	10.99- 02.06	CS1333	24 6.2	
O 580-15 RH 12.0	(Travego)[OM457.940]	10.99- 02.06	CA1236IR	28 140	10.99- 02.06	CS1333	24 6.2	
O 580-15 RHD 12.0	(Travego)[OM457.93.]	10.99- 02.06	CA1236IR	28 140	10.99- 02.06	CS1333	24 6.2	
O 580-17 RHD 12.0	(Travego)[OM457.944]	10.99- 02.06	CA1236IR	28 140	10.99- 02.06	CS1333	24 6.2	
O 580-17 RHD 15.9	(Travego)[OM542.948]	10.99- 02.06	CA1236IR	28 140	10.99-	CS1463	24 6.2 MI	
					10.99-	CS1269	24 6.2 BO	
U 100 2.9	(Unimog)[OM602.215]	11.92-	CA1735IR	14 55	11.92-	CS794	12 2.2	
		[OM602.948]	11.92-	CA1735IR				14 55
		[OM602.981]	07.96-	CA1209IR				14 90
		[OM602.989]	07.96-	CA1209IR				14 90
U 100 5.7	(Unimog)[OM353.901]	01.77- 05.88	CA339IR	14 55	01.77- 05.88	CS186	12 3.0	
		01.88- 05.88	CA339IR	14 55				01.88- 05.88
	[OM353.940]		01.77- 05.88	CA339IR	14 55	01.77- 05.88	CS605	12 3.0
			01.77- 05.88	CA339IR	14 55			
U 1000 5.7	(Unimog)[OM353.940]	01.77- 12.82	CA186IR	14 55	01.77- 12.82	CS605	12 3.0	
		01.77- 05.88	CA186IR	14 55				01.77- 05.88
	[OM353.962]		01.77- 05.88	CA186IR	14 55	01.77- 05.88	CS605	
			01.77- 05.88	CA186IR	14 55			06.84- 05.88
U 1000 6.0	(Unimog)[OM356.914]	01.77- 12.82	CA186IR	14 55	01.77- 12.82	CS605	12 3.0	
		01.77- 05.88	CA186IR	14 55				01.77- 05.88
	[OM356.915]		01.88- 12.92	CA186IR	14 55	01.88- 12.92	CS120	
			01.88- 12.92	CA854IR	28 35			01.88- 01.91
U 110 4.0	(Unimog)[OM364.955]	Eng. -393453	07.92-	CA186IR	14 55	07.92-	CS186	12 3.0
		[OM364.958]	07.92-	CA186IR	14 55			
	[OM364.958]		07.92-	CA186IR	14 55	02.92-	CS186	12 3.0
			07.92-	CA186IR	14 55			



U 110 5.7	(Unimog)[OM353.901]	01.77- 05.88	<b>CA339IR</b>	14 55	01.77- 05.88	<b>CS605</b>	12 3.0
	[OM353.940]	01.77- 05.88	<b>CA339IR</b>	14 55	01.77- 05.88	<b>CS186</b>	12 3.0
	[OM353.980]	01.77- 05.88	<b>CA339IR</b>	14 55	01.77- 05.88	<b>CS605</b>	12 3.0
U 1100 5.7	(Unimog)[OM353.901]	01.77- 05.88	<b>CA339IR</b>	14 55	01.77- 05.88	<b>CS605</b>	12 3.0
	[OM353.907]	01.77- 01.88	<b>CA339IR</b>	14 55	01.77- 01.88	<b>CS605</b>	12 3.0
	[OM353.940]	01.77- 05.88	<b>CA339IR</b>	14 55	01.77- 05.88	<b>CS605</b>	12 3.0
	[OM353.980]	01.77- 05.88	<b>CA339IR</b>	14 55	01.77- 05.88	<b>CS605</b>	12 3.0
U 1150 5.7	(Unimog)[OM353.907]	05.88- 02.01	<b>CA341IR</b>	28 27	Eng. 708450- 05.88- 02.01	<b>CS605</b>	12 3.0
	[OM353.940]	05.88- 02.01	<b>CA339IR</b>	14 55	Eng. -708449 05.88- 02.01	<b>CS194</b>	24 4.5
		05.88- 02.01	<b>CA341IR</b>	28 27	05.88- 02.01	<b>CS194</b>	24 4.5
U 1200 5.7	(Unimog)[OM353.973]	02.82- 05.88	<b>CA186IR</b>	14 55	02.82- 05.88	<b>CS186</b>	12 3.0
	[OM353.995]	02.82- 05.88	<b>CA186IR</b>	14 55	02.82- 05.88	<b>CS186</b>	12 3.0
U 1200 6.0	(Unimog)[OM356.950]	01.88- 02.01	<b>CA186IR</b>	14 55	01.88- 01.91	<b>CS186</b>	12 3.0
		01.88- 02.01	<b>CA854IR</b>	28 35	01.91- 02.01	<b>CS120</b>	24 4.0
	[OM356.954]	01.88- 02.01	<b>CA186IR</b>	14 55	01.91- 02.01	<b>CS1279</b>	24 4.0
		01.88- 02.01	<b>CA854IR</b>	28 35	01.91- 02.01	<b>CS120</b>	24 4.0
		01.96-	<b>CA333IR</b>	28 55	01.88- 01.91	<b>CS186</b>	12 3.0
U 125 5.7	(Unimog)[OM353.907]	01.77- 01.88	<b>CA339IR</b>	14 55	01.77- 01.88	<b>CS605</b>	12 3.0
	(Unimog)[OM353.973]	12.84- 11.87	<b>CA186IR</b>	14 55	12.84- 05.88	<b>CS186</b>	12 3.0
	[OM353.995]	12.84- 11.87	<b>CA186IR</b>	14 55	12.84- 05.88	<b>CS186</b>	12 3.0
U 1250 6.0	(Unimog)[OM356.950]	01.88- 02.01	<b>CA186IR</b>	14 55	01.88- 01.91	<b>CS186</b>	12 3.0
		01.88- 02.01	<b>CA854IR</b>	28 35	01.91- 02.01	<b>CS120</b>	24 4.0
	[OM356.954]	01.88- 02.01	<b>CA186IR</b>	14 55	01.88- 02.01	<b>CS1279</b>	24 4.0
		01.88- 02.01	<b>CA854IR</b>	28 35	01.88- 02.01	<b>CS186</b>	12 3.0
	[OM366.949]	01.88- 02.01	<b>CA186IR</b>	14 55	01.91- 02.01	<b>CS120</b>	24 4.0
		01.88- 02.01	<b>CA854IR</b>	28 35	01.88- 01.91	<b>CS186</b>	12 3.0
U 130 4.0	(Unimog)[OM364.982]	07.92-	<b>CA186IR</b>	14 55	07.92-	<b>CS186</b>	12 3.0
	[OM364.985]	07.92-	<b>CA186IR</b>	14 55	07.92-	<b>CS186</b>	12 3.0
		07.92-	<b>CA186IR</b>	14 55	07.92-	<b>CS186</b>	12 3.0
U 1300 5.7	(Unimog)[OM353.961]	01.77- 05.88	<b>CA186IR</b>	14 55	01.77- 05.88	<b>CS605</b>	12 3.0
		10.78- 05.88	<b>CA595IR</b>	28 55	01.77- 05.88	<b>CS186</b>	12 3.0
	[OM353.973]	01.77- 05.88	<b>CA186IR</b>	14 55	01.81- 12.84	<b>CS186</b>	12 3.0
		10.78- 05.88	<b>CA595IR</b>	28 55	01.77- 12.80	<b>CS605</b>	12 3.0
U 1350 6.0	(Unimog)[OM366.955]	05.88- 02.01	<b>CA186IR</b>	14 55	05.88- 02.01	<b>CS186</b>	12 3.0
		05.88- 02.01	<b>CA854IR</b>	28 35	05.88- 02.01	<b>CS1279</b>	24 4.0
U 140 4.0	(Unimog)[OM364.982]	07.92-	<b>CA186IR</b>	14 55	07.92-	<b>CS186</b>	12 3.0
	[OM364.985]	05.93-	<b>CA186IR</b>	14 55	05.93-	<b>CS186</b>	12 3.0
U 1400 6.0	(Unimog)[OM357.912]	01.88- 04.00	<b>CA186IR</b>	14 55	01.88- 04.00	<b>CS186</b>	12 3.0
		01.88- 04.00	<b>CA854IR</b>	28 35	01.88- 04.00	<b>CS1279</b>	24 4.0
	[OM366.947]	01.88- 04.00	<b>CA186IR</b>	14 55	01.88- 04.00	<b>CS186</b>	12 3.0
		01.88- 04.00	<b>CA854IR</b>	28 35	01.88- 04.00	<b>CS1279</b>	24 4.0
	[OM366.948]	01.88- 04.00	<b>CA186IR</b>	14 55	01.88- 04.00	<b>CS186</b>	12 3.0
		01.88- 04.00	<b>CA854IR</b>	28 35	01.88- 04.00	<b>CS1279</b>	24 4.0
	[OM366.955]	01.88- 04.00	<b>CA186IR</b>	14 55	01.88- 04.00	<b>CS1279</b>	24 4.0
		01.88- 04.00	<b>CA854IR</b>	28 35	01.88- 04.00	<b>CS186</b>	12 3.0
U 1450 6.0	(Unimog)[OM357.912]	Eng. 371652- 07.94- 04.00	<b>CA333IR</b>	28 55	07.94- 04.00	<b>CS1279</b>	24 4.0
		Eng. -371351 07.94- 04.00	<b>CA595IR</b>	28 55			
	[OM366.947]	01.88- 01.91	<b>CA186IR</b>	14 55	01.88- 01.91	<b>CS186</b>	12 3.0
		01.91- 04.00	<b>CA854IR</b>	28 35	01.91- 04.00	<b>CS120</b>	24 4.0
	[OM366.948]	Eng. 146294- 01.88- 04.00	<b>CA854IR</b>	28 35	Eng. -146293 01.88- 04.00	<b>CS186</b>	12 3.0
		Eng. -146293 01.88- 04.00	<b>CA186IR</b>	14 55	Eng. 146294- 01.88- 04.00	<b>CS1279</b>	24 4.0
	[OM366.955]	Eng. 146294- 01.88- 04.00	<b>CA854IR</b>	28 35	Eng. -146293 01.88- 04.00	<b>CS186</b>	12 3.0
		Eng. -146293 01.88- 04.00	<b>CA186IR</b>	14 55	Eng. 146294- 01.88- 04.00	<b>CS1279</b>	24 4.0
	[OM366.956]	Eng. 146294- 01.88- 04.00	<b>CA854IR</b>	28 35	Eng. 146294- 01.88- 04.00	<b>CS1279</b>	24 4.0
		Eng. -146293 01.88- 04.00	<b>CA186IR</b>	14 55	Eng. -146293 01.88- 04.00	<b>CS186</b>	12 3.0
U 1500 5.7	(Unimog)[OM353.958]	01.77- 05.88	<b>CA186IR</b>	14 55	01.77- 05.88	<b>CS186</b>	12 3.0
U 1550 5.7	(Unimog)[OM353.958]	01.86- 05.88	<b>CA186IR</b>	14 55	04.86- 05.88	<b>CS186</b>	12 3.0
	[OM353.961]	02.86- 05.88	<b>CA186IR</b>	14 55	02.86- 05.88	<b>CS186</b>	12 3.0
	[OM353.995]	02.86- 05.88	<b>CA186IR</b>	14 55	02.86- 05.88	<b>CS186</b>	12 3.0
U 1550 6.0	(Unimog)[OM356.955]	01.92- 12.95	<b>CA854IR</b>	28 35	01.92- 04.00	<b>CS1279</b>	24 4.0
		01.96- 04.00	<b>CA333IR</b>	28 55			
	[OM356.956]	01.92- 12.95	<b>CA854IR</b>	28 35	01.92- 04.00	<b>CS1279</b>	24 4.0
		01.96- 04.00	<b>CA333IR</b>	28 55			
	[OM356.980]	03.90- 04.00	<b>CA186IR</b>	14 55	03.90- 04.00	<b>CS1279</b>	24 4.0
		03.90- 04.00	<b>CA333IR</b>	28 55	03.90- 04.00	<b>CS186</b>	12 3.0
		03.90- 04.00	<b>CA595IR</b>	28 55			
	[OM356.997]	05.88- 04.00	<b>CA186IR</b>	14 55	05.88- 04.00	<b>CS186</b>	12 3.0
		05.88- 04.00	<b>CA333IR</b>	28 55	05.88- 04.00	<b>CS120</b>	24 4.0
		01.91- 04.00	<b>CA595IR</b>	28 55	05.88- 04.00	<b>CS1279</b>	24 4.0
	[OM357.924]	05.88- 04.00	<b>CA333IR</b>	28 55	05.88- 04.00	<b>CS1279</b>	24 4.0
		05.88- 04.00	<b>CA595IR</b>	28 55	05.88- 04.00	<b>CS120</b>	24 4.0
					05.88- 04.00	<b>CS186</b>	12 3.0
	[OM357.945]	03.90- 04.00	<b>CA186IR</b>	14 55	03.90- 04.00	<b>CS186</b>	12 3.0
		03.90- 04.00	<b>CA333IR</b>	28 55	03.90- 04.00	<b>CS1279</b>	24 4.0
		03.90- 04.00	<b>CA595IR</b>	28 55			
	[OM366.955]	05.88- 04.00	<b>CA186IR</b>	14 55	05.88- 04.00	<b>CS186</b>	12 3.0
	05.88- 04.00	<b>CA854IR</b>	28 35	05.88- 04.00	<b>CS1279</b>	24 4.0	
[OM366.956]	05.88- 04.00	<b>CA186IR</b>	14 55	05.88- 04.00	<b>CS186</b>	12 3.0	
	05.88- 04.00	<b>CA854IR</b>	28 35	05.88- 04.00	<b>CS1279</b>	24 4.0	
[OM366.963]	01.92- 04.00	<b>CA186IR</b>	14 55	01.92- 04.00	<b>CS1279</b>	24 4.0	
	01.92- 04.00	<b>CA333IR</b>	28 55	01.92- 04.00	<b>CS186</b>	12 3.0	
	01.92- 04.00	<b>CA854IR</b>	28 35				
[OM366.984]	05.88- 04.00	<b>CA333IR</b>	28 55	05.88- 04.00	<b>CS1279</b>	24 4.0	
	05.88- 04.00	<b>CA595IR</b>	28 55	05.88- 04.00	<b>CS120</b>	24 4.0	
				05.88- 04.00	<b>CS186</b>	12 3.0	
U 1600 6.0	(Unimog)[OM356.956]	01.88- 02.00	<b>CA186IR</b>	14 55	01.88- 01.91	<b>CS186</b>	12 3.0
		01.88- 04.00	<b>CA854IR</b>	28 35	01.91- 04.00	<b>CS120</b>	24 4.0
	[OM356.980]	05.91-	<b>CA186IR</b>	14 55	05.91-	<b>CS1279</b>	24 4.0
		05.91-	<b>CA333IR</b>	28 55	05.91-	<b>CS186</b>	12 3.0
		05.91-	<b>CA595IR</b>	28 55			
	[OM356.997]	11.92-	<b>CA333IR</b>	28 55	11.92-	<b>CS1279</b>	24 4.0
	11.92-	<b>CA595IR</b>	28 55				
[OM357.924]	11.92-	<b>CA333IR</b>	28 55	11.92-	<b>CS1279</b>	24 4.0	
	11.92-	<b>CA595IR</b>	28 55				



**MERCEDES-BENZ** *Continued*

	[OM357.945]	11.92-	CA5951R	28 55	05.91- 05.91-	CS1279 CS186	24 4.0 12 3.0
	[OM366.949]	01.88- 04.00 01.88- 04.00	CA1861R CA8541R	14 55 28 35	01.88- 01.91 01.91- 04.00	CS186 CS120	12 3.0 24 4.0
	[OM366.984]	11.92- 11.92-	CA3331R CA5951R	28 55 28 55	09.89- 11.92-	CS186 CS1279	12 3.0 24 4.0
U 1650 6.0	(Unimog)[OM356.956]	01.88- 04.00 01.88- 04.00	CA1861R CA8541R	14 55 28 35	01.88- 01.91 01.91- 04.00	CS186 CS120	12 3.0 24 4.0
	[OM356.980]	05.91- 02.01 01.96- 02.01	CA5951R CA3331R	28 55 28 55	05.91- 02.01 05.91- 02.01	CS1279 CS120 CS186	24 4.0 24 4.0 12 3.0
	[OM356.997]	09.89- 02.01	CA5951R	28 55	09.89- 02.01	CS1279	24 4.0
	[OM357.924]	09.89- 02.01	CA5951R	28 55	01.88- 02.01	CS1279	24 4.0
	[OM357.945]	01.88- 02.01	CA5951R	28 55			
	[OM366.948]	01.88- 04.00 01.88- 04.00	CA1861R CA8541R	14 55 28 35	01.88- 01.91 01.91- 04.00	CS186 CS120	12 3.0 24 4.0
	[OM366.949]	01.88- 02.01	CA1861R	14 55	01.91- 04.00	CS120	24 4.0
		01.88- 02.01	CA8541R	28 35	01.88- 01.91	CS186	12 3.0
	[OM366.984]	09.89- 02.01	CA5951R	28 55	09.89- 02.01	CS1279	24 4.0
U 1700 5.7	(Unimog)[OM353.959]	05.78- 09.88	CA1861R	14 55	03.87- 09.88 05.78- 09.88 05.78- 12.80	CS120 CS186 CS605	24 4.0 12 3.0 12 3.0
U 1700 6.0	(Unimog)[OM356.957]	09.88- 02.01 09.88- 08.02 09.88- 02.01	CA1861R CA3331R CA8541R	14 55 28 55 28 35	09.88- 02.01 09.88- 02.01 09.88- 08.02	CS186 CS120 CS1279	12 3.0 24 4.0 24 4.0
	[OM366.963]	09.88- 02.01 09.88- 02.01 09.88- 02.01	CA1861R CA3331R CA8541R	14 55 28 55 28 35	09.88- 02.01 09.88- 02.01 09.88- 02.01	CS186 CS1279 CS120	12 3.0 24 4.0 24 4.0
U 1750 6.0	(Unimog)[OM356.957]	09.88- 02.01 09.88- 02.01 09.88- 02.01	CA1861R CA3331R CA8541R	14 55 28 55 28 35	09.88- 02.01 09.88- 02.01 09.88- 02.01	CS186 CS1279 CS120	12 3.0 24 4.0 24 4.0
	[OM356.981]	05.91- 02.01 05.91- 02.01 05.91- 02.01	CA1861R CA3331R CA5951R	14 55 28 55 28 55	09.88- 02.01 09.88- 02.01 09.88- 02.01	CS120 CS186 CS1279	24 4.0 12 3.0 24 4.0
	[OM366.963]	09.88- 02.01 09.88- 02.01 09.88- 02.01	CA1861R CA3331R CA8541R	14 55 28 55 28 35	09.88- 02.01 09.88- 02.01 09.88- 02.01	CS120 CS186 CS1279	24 4.0 12 3.0 24 4.0
U 1800 6.0	(Unimog)[OM356.998]	04.92- 08.02 04.92- 08.02	CA3331R CA5951R	28 55 28 55	04.92- 08.02	CS1279	24 4.0
U 1850 6.0	(Unimog)[OM356.998]	04.92- 08.02	CA3331R	28 55	04.92- 08.02	CS1279	24 4.0
U 2100 6.0	(Unimog)[OM356.997]	09.89- 02.01 09.89- 08.02 09.89- 08.02	CA1861R CA3331R CA5951R	14 55 28 55 28 55	09.89- 08.02 09.89- 02.01	CS1279 CS186	24 4.0 12 3.0
	[OM366.984]	09.89- 02.01 09.89- 02.01 09.89- 02.01	CA1861R CA3331R CA5951R	14 55 28 55 28 55	09.89- 02.01 09.89- 02.01	CS186 CS1279	12 3.0 24 4.0
U 2150 6.0	(Unimog)[OM356.980]	05.91- 08.02 05.91- 08.02 05.91- 08.02	CA1861R CA3331R CA5951R	14 55 28 55 28 55	05.91- 08.02 05.91- 08.02	CS1279 CS186	24 4.0 12 3.0
	[OM356.997]	09.89- 02.01 09.89- 02.01 09.89- 02.01	CA1861R CA3331R CA5951R	14 55 28 55 28 55	09.89- 02.01 09.89- 02.01	CS1279 CS186	24 4.0 12 3.0
	[OM357.945]	05.91- 08.02 05.91- 08.02	CA3331R CA8541R	28 55 28 35	05.91- 08.02 05.91- 08.02	CS186 CS1279	12 3.0 24 4.0
	[OM366.984]	09.89- 02.01 09.89- 02.01 09.89- 02.01	CA1861R CA3331R CA5951R	14 55 28 55 28 55	09.89- 02.01 09.89- 02.01	CS1279 CS186	24 4.0 12 3.0
U 2400 6.0	(Unimog)[OM356.980]	05.91- 08.02 05.91- 08.02 05.91- 08.02	CA1861R CA3331R CA5951R	14 55 28 55 28 55	05.91- 08.02 05.91- 08.02	CS1279 CS186	24 4.0 12 3.0
	[OM357.945]	05.91- 08.02 05.91- 08.02 07.93- 08.02	CA3331R CA8541R CA5951R	28 55 28 35 28 55	05.91- 08.02 05.91- 08.02	CS1279 CS186	24 4.0 12 3.0
U 2450 6.0	(Unimog)[OM356.980]	07.93- 08.02 07.93- 08.02 07.93- 08.02	CA1861R CA3331R CA5951R	14 55 28 55 28 55	05.91- 08.02 05.91- 08.02	CS1279 CS186	24 4.0 12 3.0
	[OM357.945]	07.93- 08.02 07.93- 08.02 07.93- 08.02	CA1861R CA3331R CA5951R	14 55 28 55 28 55	05.91- 08.02 05.91- 08.02	CS1279 CS186	24 4.0 12 3.0
U 300 4.2	(Unimog)[OM904.927]	04.00- 04.00- 04.00- 04.00-	CA15051R CA15931R CA16661R CA17391R	28 100 28 80 28 80 28 100	03.00- 03.00-	CS1112 CS1381	24 4.0 BO 24 4.0 DR
	[OM904.928]	04.00- 04.00- 04.00- 04.00-	CA15051R CA15931R CA16661R CA17391R	28 100 28 80 28 80 28 100	03.00- 03.00-	CS1381 CS1112	24 4.0 DR 24 4.0 BO
U 3000 4.2	(Unimog)[OM904.952]	09.02- 09.02-	CA16661R CA17391R	28 80 28 100	09.02- 09.02-	CS1112 CS1112	24 4.0 24 4.0 BO
	[OM904.953]	09.02- 09.02-	CA16661R CA17391R	28 80 28 100	09.02- 09.02-	CS1381 CS1112	24 4.0 DR 24 4.0 BO
U 400 4.2	(Unimog)[OM904.928]	04.00- 04.00- 04.00- 04.00-	CA15051R CA15931R CA16661R CA17391R	28 100 28 80 28 80 28 100	03.00- 03.00-	CS1381 CS1112	24 4.0 DR 24 4.0 BO
U 400 6.4	(Unimog)[OM906.935]	04.00- 04.00- 04.00- 04.00-	CA15051R CA15931R CA16661R CA17391R	28 100 28 80 28 80 28 100	03.00- 03.00-	CS1381 CS1112	24 4.0 DR 24 4.0 BO
U 4000 4.2	(Unimog)[OM904.952]	09.02- 09.02-	CA16661R CA17391R	28 80 28 100	09.02- 09.02-	CS1112	24 4.0
	[OM904.953]	09.02- 09.02-	CA16661R CA17391R	28 80 28 100	09.02- 09.02-	CS1112	24 4.0
U 4000 4.8	(Unimog)[OM924.923]	09.02- 09.02-	CA16661R CA17391R	28 80 28 100	09.02- 09.02-	CS1112	24 4.0
U 45 2.2	(Unimog)[OM615.911]				01.68- 12.71	CS188	12 2.0
U 500 6.4	(Unimog)[OM906.935]	02.01- 02.01- 02.01- 02.01-	CA15051R CA15931R CA16661R CA17391R	28 100 28 80 28 80 28 100	02.01- 02.01-	CS1381 CS1112	24 4.0 DR 24 4.0 BO
	[OM906.955]	10.00- 02.01- 02.01- 02.01-	CA16661R CA15051R CA15931R CA16591R	28 80 28 100 28 80 28 140	02.01- 02.01-	CS1381 CS1112	24 4.0 DR 24 4.0 BO
U 5000 4.8	(Unimog)[OM924.916]	03.03- 03.03-	CA15931R CA16661R	28 80 28 80	03.03- 09.02-	CS1112 CS1381	24 4.0 BO 24 4.0 DR
U 5000 6.4	(Unimog)[OM906.935]	11.02- 11.02- 11.02- 11.02-	CA15051R CA15931R CA16661R CA17391R	28 100 28 80 28 80 28 100	11.02-	CS1112	24 4.0





U 52 2.4	(Unimog)[OM616.911]	01.77- 05.88	CA339IR	14 55	01.77- 05.88	CS188	12 2.0
	[OM616.915]	01.77- 05.88	CA339IR	14 55	01.77- 05.88	CS188	12 2.0
	[OM616.931]	01.77- 05.88	CA339IR	14 55	01.77- 05.88	CS188	12 2.0
	[OM616.932]	01.77- 05.88	CA339IR	14 55	01.77- 05.88	CS188	12 2.0
U 54 3.8	(Unimog)[OM314.916]	04.66- 03.72	CA186IR	14 55	09.73- 12.76	CS186	12 3.0
U 60 2.4	(Unimog)[OM616.911]	01.77- 05.88	CA339IR	14 55	01.77- 05.88	CS188	12 2.0
	[OM616.915]	01.77- 05.88	CA339IR	14 55	01.77- 05.88	CS188	12 2.0
	[OM616.931]	01.77- 05.88	CA339IR	14 55	01.77- 05.88	CS188	12 2.0
	[OM616.932]	01.77- 05.88	CA339IR	14 55	01.77- 05.88	CS188	12 2.0
U 600 2.4	(Unimog)[OM616.911]	01.77- 05.88	CA339IR	14 55	01.77- 05.88	CS188	12 2.0
	[OM616.915]	01.77- 05.88	CA339IR	14 55	01.77- 05.88	CS188	12 2.0
	[OM616.931]	01.77- 05.88	CA339IR	14 55	01.77- 05.88	CS188	12 2.0
	[OM616.932]	01.77- 05.88	CA339IR	14 55	01.77- 05.88	CS188	12 2.0
	[OM616.942]	05.88- 02.01	CA339IR	14 55	05.88- 02.01	CS188	12 2.0
	[OM616.943]	05.88- 02.01	CA339IR	14 55	05.88- 02.01	CS188	12 2.0
U 650 2.4	(Unimog)[OM616.942]	05.88- 02.01	CA339IR	14 55	05.88- 02.01	CS188	12 2.0
	[OM616.943]	05.88- 02.01	CA339IR	14 55	05.88- 02.01	CS188	12 2.0
U 66 3.8	(Unimog)[OM314.917]				09.73- 12.75	CS186	12 3.0
U 72 3.8	(Unimog)[OM314.917]				01.76- 12.76	CS186	12 3.0
					01.76- 12.76	CS605	12 3.0
U 80 3.8	(Unimog)[OM314.917]				09.73- 01.77	CS186	12 3.0
U 80 5.7	(Unimog)[OM352.984]				09.73-	CS186	12 3.0
	[OM353.902]				09.73- 12.76	CS186	12 3.0
U 800 3.8	(Unimog)[OM314.917]	04.82- 03.90	CA339IR	14 55	01.77- 03.90	CS605	12 3.0
U 84 5.7	(Unimog)[OM353.902]				09.73- 12.76	CS186	12 3.0
U 90 2.9	(Unimog)[OM602.941]	11.92- 04.94	CA1735IR	14 55	11.92- 04.94	CS794	12 2.2
	[OM602.981]	07.96-	CA1209IR	14 90	07.96-	CS1044	12 2.0
	[OM602.989]	07.96-	CA1209IR	14 90	07.96-	CS1044	12 2.0
U 90 5.7	(Unimog)[OM352.984]				09.73- 12.75	CS186	12 3.0
U 900 5.7	(Unimog)[OM353.902]	04.82- 02.01	CA339IR	14 55	01.88- 02.01	CS605	12 3.0
	[OM353.940]	01.77- 05.88	CA339IR	14 55	Enq. 708450- 01.77- 05.88	CS605	12 3.0
U 900 6.0	(Unimog)[OM356.912]	11.88- 02.01	CA339IR	14 55	11.88- 02.01	CS605	12 3.0
		11.88- 02.01	CA341IR	28 27			
	[OM366.939]	11.88- 02.01	CA339IR	14 55			
		11.88- 02.01	CA341IR	28 27	11.88- 02.01	CS605	12 3.0
<b>AGRICULTURE</b>							
700 3.8	[OM314.956]	07.73- 12.75	CA186IR	14 55	04.74- 12.75	CS186	12 3.0
	[OM314.957]	07.73- 12.75	CA186IR	14 55	03.74- 12.75	CS186	12 3.0
700 4.0	[OM364.908]	03.87- 12.91	CA186IR	14 55	03.87- 12.91	CS186	12 3.0
800 3.8	[OM314.957]	07.73- 12.75	CA186IR	14 55	03.74- 12.75	CS186	12 3.0
800 4.0	[OM364.909]	03.87- 12.91	CA186IR	14 55	03.87- 12.91	CS186	12 3.0
900 3.8	[OM314.970]	09.81- 12.82	CA186IR	14 55	09.81- 12.82	CS186	12 3.0
900 4.0 Turbo	[OM364.951]	03.87- 12.91	CA186IR	14 55	03.87- 12.91	CS186	12 3.0
1000 5.7	[OM353.985]	12.82- 03.87	CA186IR	14 55	12.82- 03.87	CS186	12 3.0
1000 6.0	[OM366.908]	03.87- 12.91	CA186IR	14 55	03.87- 12.91	CS186	12 3.0
	[OM366.912]	03.87- 12.91	CA186IR	14 55	03.87- 12.91	CS186	12 3.0
1100 5.7	[OM353.949]	03.79- 03.87	CA186IR	14 55	03.79- 12.80	CS605	12 3.0
					01.81- 03.87	CS186	12 3.0
1100 6.0	[OM366.908]	03.87- 12.91	CA186IR	14 55	03.87- 12.91	CS186	12 3.0
	[OM366.912]	03.87- 12.91	CA186IR	14 55	03.87- 12.91	CS186	12 3.0
1300 5.7	[OM353.957]	10.76- 03.87	CA186IR	14 55	10.76- 03.87	CS605	12 3.0
1300 6.0	[OM366.958]	03.87- 12.91	CA186IR	14 55	03.87- 12.91	CS186	12 3.0
	[OM366.977]	03.87- 12.91	CA186IR	14 55	03.87- 12.91	CS186	12 3.0
1400 6.0	[OM366.958]	03.87- 12.91	CA186IR	14 55	03.87- 12.91	CS186	12 3.0
	[OM366.977]	03.87- 12.91	CA186IR	14 55	03.87- 12.91	CS186	12 3.0
1500 5.7	[OM353.976]	07.80- 03.87	CA186IR	14 55	07.80- 03.87	CS186	12 3.0
1600 6.0	[OM366.954]	06.90- 12.91	CA186IR	14 55	06.90- 12.91	CS186	12 3.0
65/70 3.8	[OM314.956]				03.74- 12.75	CS186	12 3.0
<b>MOTORS</b>							
Engine 11.0	[421]				02.86-	CS1031	12 3.6
Engine 3.8	[314]				04.71- 12.88	CS194	24 4.5
Engine 9.6	[401..]				05.94-	CS1031	12 3.6
<b>Mercury</b>							
<b>PASSENGER CARS US</b>							
Bobcat 2.3							
Bobcat 2.8							
Capri 1.6					01.71- 01.72	CS78	12 0.75
					01.91- 01.94	JS325	12 0.9
Capri 1.6 Turbo XR2					01.91- 01.94	JS325	12 0.9
Capri 2.0		01.71- 01.74	CA17v	14 34	01.71- 01.74	CS86	12 1.0
		01.71- 01.74	CA94IR	14 55	01.71- 01.74	CS78	12 0.75
Capri 2.3							
Capri 2.3 Ghia							
Capri 2.3 Turbo							
Capri 2.3 Turbo Ghia							
Capri 2.6					01.72- 01.73	CS72	12 1.1
Capri 2.8					01.74- 01.77	CS72	12 1.1
Capri 2.8 Ghia		01.76- 01.77	CA190IR	14 35			
Capri 3.3							
Capri 3.3 Ghia							
Capri 4.2							
Capri 4.2 Ghia							
Capri 5.0							
Capri 5.0 Ghia							
Colony Park 5.0							
Colony Park 5.8							
Colony Park 7.5							
Comet 3.3							
Comet 4.1							
Comet 5.0							
Cougar 2.0					01.99- 01.02	CS1058	12 1.5
					01.99- 01.02	CS1107	12 1.4
Cougar 2.3							
Cougar 2.3 Turbo							
Cougar 2.5					01.99- 01.02	CS961	12 1.4
Cougar 2.5 S					01.01- 01.01	CS961	12 1.4
Cougar 3.3							
Cougar 3.3 XR-7							
Cougar 3.8 LS		01.87- 01.92	UA1210IR#	14 75			
Cougar 3.8 XR-7		01.93- 01.96	UA1210IR#	14 75			
Cougar 4.2							
Cougar 4.2 XR-7							
Cougar 5.0							
Cougar 5.0 Brougham							
Cougar 5.0 XR-7							
Cougar 5.8							
Cougar 5.8 Brougham							



**MERCURY Continued**

Cougar 5.8 Brougham Villager								
Cougar 5.8 XR-7								
Cougar 6.6								
Cougar 6.6 Brougham								
Cougar 6.6 Brougham Villager								
Cougar 6.6 XR-7								
Cougar 7.5								
Cougar 7.5 XR-7								
Grand Marquis 4.2								
Grand Marquis 5.0								
Grand Marquis 5.0 Colony Park								
Grand Marquis 5.8								
Grand Marquis 6.6								
Grand Marquis 7.5								
LN7 1.6								
Lynx 1.6								
Marquis 2.3								
Marquis 2.3 Brougham								
Marquis 2.3								
Marquis 2.3 Brougham								
Marquis 3.3								
Marquis 3.3 Brougham								
Marquis 4.2								
Marquis 4.2 Brougham								
Marquis 5.0								
Marquis 5.0 Brougham								
Marquis 5.8								
Marquis 5.8 Brougham								
Marquis 6.6								
Marquis 6.6 Brougham								
Marquis 7.5								
Marquis 7.5 Brougham								
Monarch 3.3								
Monarch 4.1								
Monarch 4.1 Ghia								
Monarch 4.2								
Monarch 5.0								
Monarch 5.0 Ghia								
Monarch 5.8								
Monarch 5.8 Ghia								
Montego 5.8								
Montego 5.8 MX								
Montego 5.8 MX Brougham								
Montego 5.8 Villager								
Montego 7.0 GT								
Montego 7.0 Villager								
Montego 7.5								
Montego 7.5 MX								
Montego 7.5 MX Brougham								
Montego 7.5 Villager								
Monterey 7.5								
Monterey 7.5 Custom								
Mystique 2.0					01.99- 01.00	CS1058	12 1.5	
					01.99- 01.00	CS1107	12 1.4	
Mystique 2.0 GS					01.95- 01.98	CS1058	12 1.5	
					01.95- 01.98	CS1107	12 1.4	
Mystique 2.0 LS					01.95- 01.98	CS1058	12 1.5	
					01.95- 01.98	CS1107	12 1.4	
Mystique 2.5					01.99- 01.00	CS961	12 1.4	
Mystique 2.5 GS					01.95- 01.98	CS961	12 1.4	
Mystique 2.5 LS					01.96- 01.98	CS961	12 1.4	
Mystique 2.5 Young America					01.95- 01.95	CS961	12 1.4	
Tracer 1.6		01.87- 01.87	JA129IR	14 55	01.87- 01.89	JS325	12 0.9	
		01.88- 01.89	JA173IR	14 60				
Tracer 1.8 LTS		01.91- 01.96	JA699IR	14 65				
		01.91- 01.96	JA599IR	14 65				
Zephyr 2.3								
Zephyr 2.3 GS								
Zephyr 2.3 Z7								
Zephyr 3.3								
Zephyr 3.3 GS								
Zephyr 3.3 Z7								
Zephyr 4.2								
Zephyr 4.2 Z7								
Zephyr 5.0								
Zephyr 5.0 Z7								
<b>MARINE</b>								
Various Models			JA1169IR#	14 55		US1240	12 1.4	
<b>Merkur</b>								
<b>PASSENGER CARS US</b>								
Scorpio 2.9		01.88- 01.89	CA324IR	14 90	01.88- 01.89	CS328	12 1.4	
<b>MG</b>								
<b>PASSENGER CARS EU</b>								
1300 MK 1.3					09.67- 09.70	CS18	12 0.8	
Maestro 1.6 1600		03.83- 09.84	CA293IR	14 55	03.83- 09.84	CS116	12 0.8	
Maestro 2.0		10.84- 09.90	CA600IR	14 55	05.86- 09.90	CS579	12 0.9	
Maestro 2.0 Turbo		10.88- 09.90	CA600IR	14 55	10.88- 09.90	CS579	12 0.9	
Magnette 1.6					01.64- 09.68	CS19	12 0.8	
Metro 1.3 1300		01.85- 09.90	CA126IR	14 45	05.82- 01.87	CS18	12 0.8	
		05.82- 12.84	CA18h	14 43				
MG ZR 2.0 TD		Chas. YD 471565 - 12.02- 12.05	JA1424IR	14 90	12.02- 12.05	JS1149	12 1.8	
		Chas. - YD 471564	12.02- 12.05	JA1425IR	14 80			
MG ZS 1.6		07.03- 12.05	CA1318IR	14 65	07.03- 12.05	CS610	12 0.8	
		07.03- 12.05	CA1576IR	14 85				
MGB 1.8		01.69- 12.80	CA17h	14 34				
MGB 1.8 GT		01.69- 11.80	CA17h	14 34				
MGF 1.6	[16K4F]	02.00- 03.02	CA1576IR	14 85	02.00- 03.02	CS1253	12 1.1	
					AT 02.00- 03.02	CS1503*	12 1.2	
MGF 1.8 i 16V	[18K4F]	10.95- 03.02	CA1487IR	14 85	AT 03.95- 03.02	CS1503*	12 1.2	
		10.95- 03.02	CA1576IR	14 85	10.95- 03.02	CS1253	12 1.1	
MGF 1.8 i VVC	[18K4K]	10.95- 03.02	CA1487IR	14 85	Chas. -YD 522572	10.95- 03.02	CS1270	12 1.4
					Chas. YD 522573-	10.95- 03.02	CS1253	12 1.1



MGF 1.8 i WC	[N47D20D]				Chas. -YD522572 03.01- 03.02	CS1270	12	1.4			
					Chas. YD522573- 03.01- 03.02	CS1253	12	1.1			
			AT 03.01- 03.02	CA1576IR	14	85	CS1270	12	1.4		
						Chas. -YD522573- 03.01- 03.02	CS1253	12	1.1		
Midget 1.1					01.64- 12.66	CS19	12	0.8			
Midget 1.3		01.67- 09.74	CG50	14	22	CS19	12	0.8			
Midget 1.5		09.74- 12.79	CA17h	14	34	CS19	12	0.8			
Montego 2.0		AC 04.84- 09.90	CA564IR	14	65	05.86- 09.90	CS579	12	0.9		
		04.84- 09.90	CA305IR	14	55						
Montego 2.0 Turbo	[20HT]	10.84- 09.90	CA305IR	14	55	05.86- 09.90	CS579	12	0.9		
		AC 10.84- 09.90	CA564IR	14	65						
RV8 3.9		09.92- 12.95	CA325IR	14	70						
TF 1.6 115	[16K4F]	03.02- 05.05	CA1576IR	14	85						
TF 1.8	[18K4K]	AT 03.02- 05.05	CA1576IR	14	85	Chas. YD522573- 03.02- 05.05	CS1253	12	1.1		
TF 1.8 120	[18K4F]	03.02- 05.05	CA1576IR	14	85	AT 03.02-	CS1503*	12	1.2		
						Chas. -YD 522572 03.02- 05.05	CS1270	12	1.4		
						Chas. YD 522573- 03.02- 05.05	CS1253	12	1.1		
						AT 03.02-	CS1503*	12	1.2		
TF 1.8 135	[18K4F]	03.02- 05.05	CA1576IR	14	85	Chas. -YD 522572 03.02- 05.05	CS1270	12	1.4		
						Chas. YD 522573- 03.02- 05.05	CS1253	12	1.1		
						AT 03.02-	CS1503*	12	1.2		
						Chas. -YD 522572 03.02- 05.05	CS1270	12	1.4		
ZR 2.0 TD		Chas. - YD 471564 10.01- 05.05	JA1425IR	14	80	10.01- 05.05	JS1149	12	1.8		
		Chas. YD 471565 - 10.01- 05.05	JA1424IR	14	90						
ZR 105 1.4		06.01- 05.05	CA1575IR	14	75						
ZR 120 1.8	[18K4F]	10.01- 05.05	CA1575IR	14	75	Chas. - YD 471564 10.01- 05.05	CS1270	12	1.4		
						AT 10.01-	CS1503*	12	1.2		
ZR 160 1.8	[18K4K]	06.01- 03.02	CA1576IR	14	85	Chas. YD 471565 - 10.01- 05.05	CS1253	12	1.1		
						AT 06.01-	CS1503*	12	1.2		
						Chas. -YD522572 06.01- 03.02	CS1270	12	1.4		
						Chas. YD522573- 06.01- 03.02	CS1253	12	1.1		
ZS 1.6		11.01- 10.05	CA1576IR	14	85	11.01- 10.05	CS610	12	0.8		
		11.01- 10.05	CA1318IR	14	65						
ZS 2.0 TD		01.04- 05.05	JA1425IR	14	80	01.04- 05.05	JS1149	12	1.8		
		01.04- 05.05	JA1424IR	14	90						
ZS 120 1.8	[18K4F]	10.01- 05.05	CA1575IR	14	75	AT 07.01-	CS1503*	12	1.2		
						10.01- 05.05	CS1253	12	1.1		
						10.01- 05.05	CS1253	12	1.1		
						AT 07.01-	CS1503*	12	1.2		
ZS 180 2.5	[25 K4F]	10.01- 05.05	JA1596IR	14	90	10.01- 05.05	CS1253	12	1.1		
						07.01- 05.05	CS1253	12	1.1		
						07.01- 05.05	CS1253	12	1.1		
						AT 07.01-	CS1503*	12	1.2		
ZT 1.8 16V		AC 03.02- 05.05	JA1723IR	14	90	03.02- 05.05	JS1223	12	1.0		
		01.03-	JA1723IR	14	90						
ZT 1.8 T 16V		10.01- 05.05	CA1631IR	14	110	10.01- 05.05	JS1321	12	2.0		
						11.02- 05.05	CA1631IR	14	110	11.02- 05.05	JS1321
ZT 160 2.5	[25K4F]	10.01- 05.05	JA1596IR	14	90	AT 10.01- 05.05	JS1320	12	2.0		
ZT 190 2.5	[25K4F]	06.01- 05.05	JA1596IR	14	90	AT 06.01- 05.05	JS1320	12	2.0		
ZT- T 2.0 CDTi	[M47R (204D2)]	11.02- 05.05	CA1631IR	14	110	11.02- 05.05	JS1321	12	2.0		
ZT-T 1.8 16V		AC 03.02- 05.05	JA1723IR	14	90	03.02- 05.05	JS1223	12	1.0		
ZT-T 1.8 T 16V		AC 01.03-	JA1723IR	14	90						
ZT-T 2.0 CDTi	[204D2]	10.01- 05.05	CA1631IR	14	110	10.01- 05.05	JS1321	12	2.0		
<b>PASSENGER CARS US</b>											
MGA 1.5		01.56- 01.59	CG50	14	22	01.56- 01.59	CS18	12	0.8		
MGA 1.6		01.60- 01.62	CG50	14	22	01.60- 01.62	CS18	12	0.8		
MGB 1.8		01.68- 01.79	CA17h	14	34						
		01.63- 01.67	CG50	14	22						
		01.74- 01.80	CA18h	14	43						
		01.63- 01.67	CG50	14	22						
MGB 1.8 GT		01.68- 01.74	CA17h	14	34						
		01.74- 01.74	CA18h	14	43						
		01.69- 01.69	CA17h	14	34						
MGC 2.9		01.63- 01.66	CG50	14	22	01.63- 01.66	CS18	12	0.8		
Midget 1.1		01.67- 01.73	CG50	14	22	01.67- 01.74	CS18	12	0.8		
Midget 1.3		01.74- 01.74	CA17h	14	34						
Midget 1.5		01.75- 01.79	CA17h	14	34	01.75- 01.79	CS18	12	0.8		
TF 1.5						01.55- 01.55	CS18	12	0.8		
<b>Mini</b>											
<b>PASSENGER CARS EU</b>											
Cooper 1.6	[N12B16]	03.09-	CA1954IR	14	120	03.09-	CS1417	12	0.9		
		03.09-	CA1990IR*	14	120						
		03.09-	CA2006IR	14	150						
		[N12B16.]	10.06-	CA1954IR	14	120	10.06-	CS1417	12	0.9	
			10.06-	CA1990IR*	14	120					
		10.06-	CA2006IR	14	150						
		[N16B16A]	03.10-	CA1990IR*	14	120	03.10-	CS1417	12	0.9	
			03.10-	CA2006IR	14	150					
		[W10B16A]		06.01- 01.04	CA1676IR	14	105	AT 06.01- 11.06	CS1445	12	0.9
				06.01-	CA2052IR	14	120	06.01- 11.06	CS1254	12	0.9
01.04- 11.06	CA1867IR			14	100						
01.04- 11.06	CA1868IR			14	110						
Cooper 1.6 Clubman	[N12B16A]	10.07-	CA1954IR	14	120	10.07-	CS1417	12	0.9		
		10.07-	CA1990IR*	14	120						
		10.07-	CA2006IR	14	150						
		[N14B16A]	10.07-	CA1954IR	14	120	10.07-	CS1417	12	0.9	
			10.07-	CA1990IR*	14	120					
		[N16B16A]	03.10-	CA1990IR*	14	120	03.10-	CS1417	12	0.9	
	03.10-	CA2006IR	14	150							
	10.07-	CA1954IR	14	120	10.07-	CS1417	12	0.9			
	10.07-	CA1990IR*	14	120							
Cooper 1.6 Countryman	[N16B16A]	06.10-	CA1954IR	14	120	06.10-	CS1417	12	0.9		
		06.10-	CA1954IR	14	120	06.10-	CS1417	12	0.9		
Cooper 1.6 Countryman 4x4	[N18B16A]	06.10-	CA1954IR	14	120	06.10-	CS1417	12	0.9		
Cooper 1.6 Diesel	[9HZ]					03.07-	CS1329	12	1.5		
Cooper 1.6 Diesel Clubman	[9HZ]					10.07-	CS1329	12	1.5		
Cooper S 1.6	[N14B16A]	10.06-	CA1954IR	14	120	10.06-	CS1417	12	0.9		
		10.06-	CA1990IR*	14	120						
		10.06-	CA2006IR	14	150						
		[N18B16A]	03.10-	CA1990IR*	14	120	03.10-	CS1417	12	0.9	
			03.10-	CA2006IR	14	150					
		[W11B16A]		03.02- 11.06	CA1869IR	14	105	AT 03.02- 11.06	CS1445	12	0.9
								03.02-	CS1254	12	0.9
Cooper S 1.6 Clubman	[N18B16A]	03.10-	CA1990IR*	14	120	03.10-	CS1417	12	0.9		
		03.10-	CA2006IR	14	150						
Cooper S 1.6 COUNTRYMAN	[N18B16A]					06.10-	CS1417	12	0.9		
Cooper S 1.6 Roadster	[N18B16A]					02.12-	CS1417	12	0.9		



MINI Continued

Mini 1.6	[W11B16A]	11.03- 11.06	CA1869IR	14 105	AT 11.03- 11.06	CS1445	12 0.9
					11.03- 11.06	CS1254	12 0.9
Mini 1.6 John Cooper Works	[N14B16C]	03.08- 03.08- 03.08-	CA1954IR CA1990IR* CA2006IR	14 120 14 120 14 150	03.08-	CS1417	12 0.9
Mini Works 1.6	[W11B16A]	11.03-	CA1869IR	14 105	AT 11.03- 11.03-	CS1445 CS1254	12 0.9 12 0.9
One 1.4	[N12B14A]	03.07- 03.07- 03.07-	CA1954IR CA1990IR* CA2006IR	14 120 14 120 14 150	03.07-	CS1417	12 0.9
One 1.4 Clubman	[N12B14A]	03.10-	CA1954IR	14 120			
One 1.4 i	[B14A]	04.03- 07.04	CA1676IR	14 105	AT 04.03- 10.06	CS1445	12 0.9
		07.04- 10.06	CA1867IR	14 100	04.03- 10.06	CS1254	12 0.9
One 1.4 Diesel	[1ND]				06.03- 11.06	JS1358	12 2.0
One 1.6	[N16B16A]	03.10- 03.10-	CA1990IR* CA2006IR	14 120 14 150	03.10-	CS1417	12 0.9
	[W10B16A]	06.01- 06.01- 01.04	CA1676IR CA2052IR	14 105 14 120	AT 06.01- 11.06	CS1445	12 0.9
		01.04- 11.06	CA1867IR	14 100	06.01- 11.06	CS1254	12 0.9
		01.04- 11.06	CA1868IR	14 110			
One 1.6 Clubman	[N16B16A]	03.10- 03.10-	CA1990IR* CA2006IR	14 120 14 150	03.10-	CS1417	12 0.9
One 1.6 Countryman	[N16B16A]				06.10-	CS1417	12 0.9
<b>Mitsubishi</b>							
<b>PASSENGER CARS EU</b>							
3000 GT 3.0i 24V	(Z16A)[6G72]	06.92- 08.99	JA995IR	14 110			
					06.93- 08.99	JS658	12 1.2
Canter 2.8 TDi	(FB6_, FE5_, FE6_)[4M40-2AT]	10.98- 07.01	JA1375IR	14 75	10.98- 07.01	JS1221	12 2.2
Canter 3.6 TDi	(FB6_, FE5_, FE6_)				04.98- 07.01	JS1354	24 3.2
Carisma 1.3	(DA_)[4G13]	09.00- 10.04	CA1585IR	14 90	09.00- 10.04	CS886	12 1.3
Carisma 1.6	(DA1A)[4G92]	12.98- 06.06	CA1075IR	14 90	AT 12.98- 06.06	JS925	12 0.9
					12.98- 06.06	CS886	12 1.3
	[4G92]	07.95- 07.95- 02.99	CA1075IR	14 90	07.95- 02.99	CS886	12 1.3
		07.95- 02.99	CA1136IR	14 75	AT 07.95- 02.99	JS925	12 0.9
		03.99- 06.06	CA1075IR	14 90	03.99- 06.06	CS886	12 1.3
Carisma 1.8	[4G93]	07.95- 07.95- 02.99	CA1075IR	14 90	07.95- 02.99	JS1139	12 1.2
		07.95- 02.99	CA1136IR	14 75	AT 05.95- 02.99	JS925	12 0.9
Carisma 1.8 16V	[4G93]	07.95- 07.95- 02.99	CA1075IR	14 90	05.97- 12.03	JS1139	12 1.2
		07.95- 02.99	CA1136IR	14 75	AT 05.95- 02.99	JS925	12 0.9
		09.97- 12.03	JA1522IR	14 100			
		09.97- 12.03	JA1523IR	14 85			
Carisma 1.8 GDi 16V	[4G93]	09.97- 12.03	JA1522IR	14 100	09.97- 12.03	JS1139	12 1.2
		09.97- 12.03	JA1523IR	14 85	10.00- 06.06	JS1139	12 1.2
Carisma 1.8 GDi	(DA_)	10.00- 06.06	JA1522IR	14 100			
Carisma 1.9 Diesel Di	(DA_)[F9Q1]				07.00- 06.06	CS1193	12 1.8
					07.00- 06.06	CS1281	12 2.1
	[F9Q2]				07.00- 06.06	CS1193	12 1.8
Carisma 1.9 TD	[F8QT]				10.96- 09.00	CS684	12 1.7
Celeste 1.6	(A72)[4G32]	01.77- 06.81	JA150IR	14 45	01.77- 06.81	JS350	12 0.7
Celeste 2.0	(A78)[4G52]	10.75- 06.81	JA151IR	14 50			
Colt 1.1	(CZ)[3A91]	09.08- 02.09	JA1895IR	14 85	A25 09.08- 09.08-	CS1510*	12
					08.04-	JS1359	12 0.9
	[3A91]	08.04-	JA1895IR	14 85	08.04-	JS1359	12 0.9
					A25 10.04-	CS1510*	12
Colt 1.2	(A151A)[4G11]	12.78- 01.84	JA150IR	14 45	12.78- 01.84	JS350	12 0.7
	(A15A)[4G16]	02.84- 05.86	JA159IR#	14 65	02.84- 09.86	JS350	12 0.7
	(C15A)[4G16]				09.86- 04.88	JS350	12 0.7
Colt 1.3	(C1_A)[G13B]				06.86- 04.88	JS350	12 0.7
	(C5_A)[4G13]	04.88- 04.88- 12.90	JA598IR	14 60	04.88- 12.90	JS349	12 0.9
		04.88- 12.90	JA689IR	14 75			
	(C51A)[4G13]	04.88- 04.88- 05.92	JA598IR	14 60	04.88- 05.92	JS349	12 0.9
		04.88- 05.92	JA689IR	14 75			
	(CZ)[4A90]	09.08- 09.08- 02.09	JA1895IR	14 85	09.08-	JS1359	12 0.9
					A25 09.08-	CS1510*	12
	[4A90]	06.04-	JA1895IR	14 85	A25 03.09- 06.04-	CS1510*	12
Colt 1.3 1300	(CJ1A)[4G13]	09.00- 09.00- 07.05	JA1531IR	14 80	09.00- 07.05	JS1139	12 1.2
		09.00- 07.05	JA1805IR	14 90	09.00- 07.05	JS925	12 0.9
Colt 1.3 GLX	[4G13]	11.95- 11.95- 09.00	JA1531IR	14 80	05.96- 09.00	JS925	12 0.9
		11.95- 09.00	JA1805IR	14 90			
Colt 1.3 12V	(C51A)[4G13]	07.90- 07.90- 05.92	JA598IR	14 60	07.90- 05.92	JS349	12 0.9
		07.90- 05.92	JA689IR	14 75			
	(CA1A)[4G13]	04.92- 04.92- 11.95	JA1181IR	14 75	04.92- 11.95	JS349	12 0.9
Colt 1.4	(A152A)[4G12]	05.79- 05.79- 01.84	JA150IR	14 45	07.80- 01.84	JS350	12 0.7
Colt 1.4 Turbo	(A152A)[4G12T]	09.81- 09.81- 01.84	JA150IR	14 45	09.81- 01.84	JS396#	12 0.7
Colt 1.5	(C12A)[4G15]	09.84- 09.84- 05.86	JA159IR#	14 65	09.84- 04.88	JS349	12 0.9
	[G15B]	09.85- 09.85- 05.86	JA159IR#	14 65	09.85- 04.88	JS349	12 0.9
	(C52A)[4G15]	04.88- 04.88- 05.92	JA598IR	14 60	04.88- 05.92	JS349	12 0.9
		04.88- 05.92	JA689IR	14 75			
	(CZ)[4A91]	09.08- 09.08- 06.04	JA1895IR	14 85	09.08-	JS1359	12 0.9
	[4A91]	06.04-	JA1895IR	14 85	06.04-	JS1359	12 0.9
Colt 1.5 CZC		05.06- 05.06-	JA1895IR	14 85	05.06-	JS1359	12 0.9
Colt 1.5 CZT	[4G15T]	03.05- 03.05-	JA1895IR	14 85	03.05-	JS1359	12 0.9
Colt 1.5 Ralliart	(CZ)[4G15T]				09.08-	JS1359	12 0.9
Colt 1.5 16V 1500	(CJ2A)[4G15]				11.95- 07.05	JS925	12 0.9
Colt 1.5 Turbo CZC					05.06-	JS1359	12 0.9
Colt 1.6	(CA_A)[4G92]	02.94- 02.94- 04.96	JA1126IR	14 75	02.94- 04.96	JS1003	12 0.9
		02.94- 04.96	JA1531IR	14 80	AT 02.94- 04.96	JS643	12 0.9
Colt 1.6 1600	(CJ1A)	09.00- 09.00- 07.05	JA1523IR	14 85	09.00- 07.05	JS1139	12 1.2
					09.00- 07.05	JS925	12 0.9
Colt 1.6 1600 GLX	[4G92]	05.96- 05.96- 09.00	JA1523IR	14 85	A13 05.96- 09.00	JS1139	12 1.2
					05.96- 09.00	JS925	12 0.9
Colt 1.6 16V	(CA4A)[4G92]	12.91- 12.91- 11.95	JA1126IR	14 75	12.91- 11.95	JS1003	12 0.9
		12.91- 11.95	JA1279IR	14 90			
Colt 1.6 GTi 16V	(C53A)[4G61]	04.88- 04.88- 05.90	JA664IR	14 65	04.88- 05.90	JS349	12 0.9
		04.88- 05.90	JA671IR	14 75			
Colt 1.6 Turbo	(C13A)[4G32T/C]	02.84- 02.84- 04.88	JA159IR#	14 65	02.84- 04.88	JS396#	12 0.7
Colt 1.6 Turbo ECi	(C13A)[G32B/T]	07.86- 07.86- 04.88	JA159IR#	14 65	07.86- 04.88	JS396#	12 0.7
Colt 1.8 16V	(CA5A)[4G93]	12.91- 12.91- 11.95	JA1126IR	14 75	12.91- 11.95	JS1003	12 0.9
		12.91- 11.95	JA1279IR	14 90			
Colt 1.8 GTi 16V	(C58A)[4G67]	06.90- 06.90- 05.92	JA664IR	14 65	06.90- 05.92	JS628	12 1.2
		06.90- 05.92	JA671IR	14 75			
Colt 1.8 Diesel	(C54A)[4D65]	04.88- 04.88- 05.92	JA793IR#	14 65	04.88- 05.92	JS344	12 2.0
Colt 2.0 Diesel	(CA8)[4D68]	07.92- 07.92- 02.00	JA1133IR	14 75	07.92- 02.00	JS344	12 2.0
		07.92- 02.00	JA1360IR	14 90			
Cordia 1.6	(A212A)[4G32]				10.82- 07.84	JS350	12 0.7
Cordia 1.6 Turbo	(A212A)[4G32T]	08.84- 08.84- 05.85	JA159IR#	14 65	09.82- 05.85	JS350	12 0.7
Cordia 1.8	(A215A)[4G37]	10.86- 10.86- 12.86	JA159IR#	14 65	10.86- 12.86	JS350	12 0.7
Cordia 1.8 Turbo	(A213A)[4G62T]				10.84- 12.86	JS350	12 0.7



Eclipse 2.0 16V GS	[4G63]	12.95- 12.00	JA11671R	14 75	12.95- 12.00	JS628	12 1.2
Eclipse 2.0 i 16V	(D22A)[4G63]	04.91- 03.94	JA6841R	14 90	04.91- 03.94	JS628	12 1.2
Eclipse 2.0 i 16V 4WD	[4G63]	04.91- 11.95	JA6841R	14 90	04.91- 11.95	JS628	12 1.2
Eclipse 2000 2.0 16V GT	[4G63]	08.95- 04.99	JA6841R	14 90	08.95- 04.99	JS628	12 1.2
Galant 1.6	(A11A)[4G32]	06.84- 05.86	JA1591R#	14 65	06.84- 12.87	JS349	12 0.9
		06.86- 12.87	JA6661R	14 60			
	(A12_)[4G32]	01.77- 08.80	JA1501R	14 45	01.77- 08.80	JS349	12 0.9
					01.77- 08.80	JS350	12 0.7
Galant 1.6 GL	(A161A)[4G32]	09.80- 05.84	JA1501R	14 45	09.80- 05.84	JS350	12 0.7
					09.80- 05.84	JS349	12 0.9
	(A161V)[4G32]	09.80- 05.84	JA1501R	14 45	09.80- 05.84	JS350	12 0.7
					09.80- 05.84	JS349	12 0.9
Galant 1.6 GL	(A121V)[4G32]	01.79- 08.80	JA1501R	14 45	01.79- 08.80	JS350	12 0.7
					01.79- 08.80	JS349	12 0.9
Galant 1.8	(E32A)[4G37]	11.87- 10.92	JA6661R	14 60	11.87- 10.92	JS349	12 0.9
					11.87- 10.92	JS628	12 1.2
Galant 1.8	(E52A)[4G93]	11.92- 08.96	JA11261R	14 75	11.92- 08.96	JS1003	12 0.9
			JA12791R	14 90	AT 11.92- 08.96	JS643	12 0.9
Galant 1.8 TD	(E14A)[4D65T]	06.86- 12.87	JA6541R#	14 65	06.84- 12.87	JS769	12 2.2
	(E34A)[4D65T]	12.87- 10.92	JA6541R#	14 65	12.87- 10.92	JS344	12 2.0
Galant 2.0	(A12_)[4G52]	01.77- 08.80	JA1511R	14 50	01.77- 08.80	JS350	12 0.7
	(A163)[4G63]	09.80- 05.84	JA1511R	14 50	09.80- 05.84	JS350	12 0.7
	(A163V)[4G63]	09.80- 06.83	JA1511R	14 50	09.80- 06.83	JS350	12 0.7
	(E15A)[4G63]	06.86- 12.87	JA5981R	14 60	06.84- 12.87	JS349	12 0.9
					06.84- 12.87	JS628	12 1.2
	[G63B]	06.86- 12.87	JA5981R	14 60	06.86- 12.87	JS628	12 1.2
					06.86- 12.87	JS349	12 0.9
	(E33A)[4G63]	11.87- 10.92	JA6641R	14 65	11.87- 10.92	JS628	12 1.2
			JA6711R	14 75	11.87- 10.92	JS349	12 0.9
			JA6841R	14 90	AT 11.87- 10.92	JS1004	12 1.2
	(E55A)[4G63]	11.92- 08.96	JA11671R	14 75	AT 11.92- 08.96	JS1004	12 1.2
			JA12841R	14 90	11.92- 08.96	JS628	12 1.2
				11.92- 08.96	JS349	12 0.9	
(EA2A)[4G63]	09.96- 12.03	JA15231R	14 85	09.96- 12.03	JS1313	12 1.2	
				09.96- 12.03	JS1300	12 0.9	
(EA2W)[4G63]	09.96- 09.02	JA15231R	14 85	09.96- 09.02	JS1313	12 1.2	
				09.96- 09.02	JS1300	12 0.9	
Galant 2.0 4WD	(E38A)[4G63]	09.00- 10.04	JA15231R	14 85	09.00- 10.04	JS1313	12 1.2
			JA6641R	14 65	12.88- 10.92	JS349	12 0.9
			JA6711R	14 75	12.88- 10.92	JS628	12 1.2
			JA6841R	14 90	AT 12.88- 10.92	JS1004	12 1.2
	(E39A)[4G63]	04.89- 10.92	JA6641R	14 65	04.89- 10.92	JS628	12 1.2
			JA6711R	14 75	04.89- 10.92	JS349	12 0.9
			JA6841R	14 90	AT 04.89- 10.92	JS1004	12 1.2
	(E75A)[4G63]	11.92- 08.96	JA11671R	14 75	11.92- 08.96	JS349	12 0.9
		JA12841R	14 90	AT 11.92- 08.96	JS1004	12 1.2	
				11.92- 08.96	JS628	12 1.2	
Galant 2.0 GLX	(A123V)[4G52]	01.79- 08.80	JA1511R	14 50	01.79- 08.80	JS350	12 0.7
Galant 2.0 16V	(E33A)[4G63]	11.87- 10.92	JA6641R	14 65	11.87- 10.92	JS628	12 1.2
			JA6711R	14 75	11.87- 10.92	JS349	12 0.9
		JA6841R	14 90	AT 11.87- 10.92	JS1004	12 1.2	
Galant 2.0 16V 4WD	(E3_A)[4G63]	06.88- 10.92	JA6641R	14 65	06.88- 10.92	JS628	12 1.2
			JA6711R	14 75	AT 06.88- 10.92	JS1004	12 1.2
		JA6841R	14 90	06.88- 10.92	JS349	12 0.9	
Galant 2.0 GTi 16V	(E3_A)[4G63]	11.87- 10.92	JA6711R	14 75	A13 11.87- 10.92	JS628	12 1.2
					11.87- 10.92	JS349	12 0.9
Galant 2.0 GTi 16V 4WD	[4G63]	07.89- 12.92	JA6641R	14 65	AT 07.89- 12.92	JS1004	12 1.2
			JA6711R	14 75	07.89- 12.92	JS628	12 1.2
		JA6841R	14 90	07.89- 12.92	JS349	12 0.9	
Galant 2.0 Turbo	(A164)[4G63T]				05.82- 05.84	JS350	12 0.7
	(E15A)[4G63T]				06.84- 05.85	JS349	12 0.9
					06.84- 05.85	JS350	12 0.7
Galant 2.0 V6 24V	(E54A)[6A12]	11.92- 05.96	JA11731R	14 90	11.92- 05.96	JS1020#	12 1.0
Galant 2.0 TD	(E57A)[4D68]	11.92- 10.96	JA11331R	14 75	11.92- 10.96	JS344	12 2.0
			JA13601R	14 90			
Galant 2.0 TDi	(EA6A)[4D68]				09.96- 02.00	JS344	12 2.0
	(EA6W)[4D68]				09.96- 02.00	JS344	12 2.0
Galant 2.3 TD	(A167)[4D55T]	11.81- 05.84	JA1481R	14 45	09.80- 05.84	JS344	12 2.0
		07.83- 05.84	JA6631R#	14 55	A13 09.80- 05.84	JS769	12 2.2
	(A167V)[4D55T]	07.83- 05.84	JA1481R	14 45	07.83- 05.84	JS344	12 2.0
			JA6631R#	14 55	A13 07.83- 05.84	JS769	12 2.2
Galant 2.4	(E16A)[G64B]	06.86- 12.87	JA5981R	14 60	06.86- 12.87	JS628	12 1.2
Galant 2.4 GDi	(EA3A)[4G64]	09.00- 10.04	JA15221R	14 100 ▲	02.99- 10.04	CS1459	12 1.4
		AC 02.99- 09.00	JA15221R	14 100			
	(EA3W)[4G64]	09.00- 10.03	JA15221R	14 100 ▲	02.99- 10.03	CS1459	12 1.4
		AC 02.99- 09.00	JA15221R	14 100			
Galant 2.5	(E5_A, E7_A, E8_A)[6G73]				11.92- 09.96	JS658	12 1.2
Galant 2.5 V6 24V	(E88A)[6G73]				11.92- 08.96	JS658	12 1.2
Galant 2.8 TD	(EA_)[4M40-T]	10.96- 07.01	JA13751R	14 75	10.96- 07.01	JS1221	12 2.2
			JA13761R	14 90			
Galloper 2.5 Diesel Intercooler	[D4BH]	02.99-	JA17161R	14 75	02.99-	JS892	12 2.2
			JA17171R	14 90	02.99-	JS892	12 2.2
Gallopier 2.5 TD	(JK-01)	02.99-	JA17171R	14 90			
Gallopier 3.0 V6	[G6AT]	08.98-	JA8701R	14 90			
Grandis 2.0 Di-D	(NA8W)[BSY]	09.05-	CA17631R	14 150	09.05-	CS1460*	12 2.0
		02.07-	CA17631R	14 150	02.07-	CS1460*	12 2.0
L 200 2.0	[4G63]				AT 01.96- 06.01	JS628	12 1.2
					01.96- 06.01	JS349	12 0.9
L 200 2.4 4WD	[4G64]				01.96-	JS628	12 1.2
L 200 2.5 Di-D	(KB4T)[4D56]				05.06-	JS1140	12 2.2
					10.07-	JS1140	12 2.2
L 200 2.5 Di-D 4x4	(KB4T)[4D56]				04.10-	JS1140	12 2.2
L 200 2.5 Di-D RWD	(KA4T)[4D56]				04.10-	JS1140	12 2.2
L 200 2.5 Diesel	(K14T)[4D56]	11.86- 08.96	JA1481R	14 45	11.86- 08.96	JS344	12 2.0
			JA5851R	14 60	A13 11.86- 08.96	JS769	12 2.2
	[4D56]	01.96- 06.01	JA11831R	14 65	AT 01.96- 06.01	JS1140	12 2.2
			JA12711R	14 75	A13 01.96- 06.01	JS1227	12 2.2
			JA14191R	14 90	01.96- 06.01	JS1351	12 2.0
			JA15331R	14 80			
L 200 2.5 Diesel 4WD	(K24, 34T)[4D56]	12.87- 05.93	JA1481R	14 45	A13 12.87- 05.93	JS769	12 2.2
			JA5851R	14 60	12.87- 05.93	JS344	12 2.0
L 200 2.5 TD 4WD	(K6 T)	08.03- 03.06	JA12711R	14 75	AT 08.03- 03.06	JS1140	12 2.2
			JA11831R	14 65	A13 08.03- 03.06	JS1227	12 2.2
					08.03- 03.06	JS1351	12 2.0
	(K74T)	01.96-	JA11831R	14 65	AT 01.96-	JS1140	12 2.2
			JA15331R	14 80	A13 01.96-	JS1227	12 2.2
			JA12711R	14 75	01.96-	JS1351	12 2.0
[4D56]	11.01-	JA11831R	14 65	AT 11.01-	JS1140	12 2.2	
		JA15331R	14 80	11.01-	JS1351	12 2.0	
				A13 11.01-	JS1227	12 2.2	



MITSUBISHI Continued

	[4D56T]	11.92- 08.96	JA148IR	14 45		A13 11.92- 08.96	JS769	12 2.2
		11.92- 08.96	JA585IR	14 60		11.92- 08.96	JS344	12 2.0
	[4D56TD]	01.96-	JA1183IR	14 65		A13 01.96-	JS1227	12 2.2
		01.96-	JA1271IR	14 75		01.96-	JS1351	12 2.0
		01.96-	JA1419IR	14 90		AT 01.96-	JS1140	12 2.2
		01.96-	JA1533IR	14 80				
L 200 2.6 4WD	[G54B]	06.90- 05.95	JA670IR	14 60		11.89- 05.95	JS628	12 1.2
L 300 1.6	(L)[4G32]	04.83- 10.86	JA150IR	14 45		04.83- 04.94	JS350	12 0.7
	(L030PW)[4G32]	11.84- 10.86	JA150IR	14 45		11.84- 02.87	JS350	12 0.7
	(L032P)[4G32]	05.80- 10.86	JA150IR	14 45		05.80- 10.86	JS350	12 0.7
	(PO2V,P12V)[4G32]	11.86- 05.94	JA150IR	14 45		11.86- 05.94	JS349	12 0.9
						11.86- 05.94	JS350	12 0.7
	(R12V,PO2V)[4G32]	11.86- 05.94	JA150IR	14 45		11.86- 05.94	JS350	12 0.7
						11.90- 05.94	JS349	12 0.9
L 300 1.8	(L03 W)[4G62]	03.83- 10.86	JA151IR	14 50		03.83- 10.86	JS349	12 0.9
L 300 1.8 4WD	(L03 P)[4G62]	08.84- 09.90	JA151IR	14 50		08.84- 09.90	JS349	12 0.9
L 300 2.0	(P0_W,P1_W,P2_W)[4G63]	07.96-	JA670IR	14 60		07.96- 08.97	JS628	12 1.2
						07.96- 08.97	JS349	12 0.9
	(P03V,2W,13V)[4G63]	11.86- 10.92	JA670IR	14 60		11.86- 10.92	JS349	12 0.9
		11.86- 10.92	JA973IR	14 75		11.86- 10.92	JS628	12 1.2
	(P03V,P13V)[G63B]	11.86- 10.88	JA670IR	14 60		11.86- 10.88	JS349	12 0.9
		11.86- 10.88	JA973IR	14 75		11.86- 10.88	JS628	12 1.2
	(P03W)[G63B]	11.86- 10.88	JA670IR	14 60		11.86- 10.88	JS628	12 1.2
		11.86- 10.88	JA973IR	14 75		11.86- 10.88	JS349	12 0.9
	[4G63]					06.94- 04.00	JS349	12 0.9
L 300 2.0 4WD	(L030PW)[4G63]	11.86- 02.87	JA670IR	14 60		11.86- 02.87	JS628	12 1.2
		11.86- 02.87	JA973IR	14 75				
	(P23V,W)[4G63]	12.86- 12.96	JA670IR	14 60		12.86- 12.96	JS628	12 1.2
		12.86- 12.96	JA973IR	14 75				
	(P23W)[4G63]	11.86- 06.93	JA670IR	14 60		11.86- 06.93	JS349	12 0.9
		11.86- 06.93	JA973IR	14 75		11.86- 06.93	JS628	12 1.2
L 300 2.0 4x4	(P0_W, P1_W)[4G63]	08.88- 05.94	JA670IR	14 60		08.88- 05.94	JS628	12 1.2
		08.88- 05.94	JA973IR	14 75		08.88- 05.94	JS349	12 0.9
L 300 2.3 Diesel	(I030P)[4D55]	09.83- 10.86	JA148IR	14 45		09.83- 10.86	JS344	12 2.0
		09.83- 10.86	JA663IR#	14 55				
	(L038P)[4D55]	04.83- 10.86	JA148IR	14 45		04.83- 10.86	JS344	12 2.0
		04.83- 10.86	JA663IR#	14 55				
L 300 2.4	(P04V,W,14V)[4G64]	11.90- 05.96	JA670IR	14 60		11.90- 05.96	JS628	12 1.2
		11.90- 05.96	JA973IR	14 75		11.90- 05.96	JS349	12 0.9
L 300 2.4 4WD	(P24V,W)[4G64]	11.90- 06.95	JA670IR	14 60		11.90- 06.95	JS628	12 1.2
		11.90- 06.95	JA973IR	14 75		11.90- 06.95	JS349	12 0.9
	[G64B]	11.86- 05.94	JA670IR	14 60		11.86- 12.90	JS349	12 0.9
		11.86- 05.94	JA670IR	14 90		01.91- 05.94	JS628	12 1.2
		11.86- 05.94	JA973IR	14 75				
L 300 2.5 Diesel	(P05V, W, 15V)[4D56]	11.86- 10.88	JA585IR	14 60		11.86- 05.96	JS344	12 2.0
		11.86- 05.96	JA983IR	14 75				
		11.88- 05.94	JA674IR	14 65				
		11.91- 05.96	JA1130IR	14 75				
	(P05W, 05U, 15V)[4D56]	06.94- 08.96	JA1179IR	14 65				
	(P15T)[4D56T]	11.94- 12.01	JA1411IR	14 65		11.94- 12.01	JS1140	12 2.2
	(P05V, P05W, P15V)[4D56]	11.86- 10.88	JA585IR	14 60		11.86- 05.96	JS344	12 2.0
		11.86- 05.96	JA983IR	14 75				
		11.88- 05.94	JA674IR	14 65				
		11.91- 10.96	JA1130IR	14 75				
		10.96- 12.00	JA1183IR	14 65				
	[4D56]	11.86- 05.94	JA585IR	14 60		11.86- 12.00	JS344	12 2.0
		11.86- 05.94	JA775IR	14 50				
		11.86- 12.00	JA983IR	14 75				
L 300 2.5 TD 4WD	(P25V, P25W, P45V)[4D56T]	11.88- 10.91	JA674IR	14 65		05.96-	JS1140	12 2.2
		11.91- 10.96	JA1130IR	14 75		11.88- 05.96	JS344	12 2.0
		10.96- 12.00	JA1183IR	14 65				
L 300 2.5 TD 4x4	(P0_W, P1_W)[4D56T]	11.91- 05.03	JA1411IR	14 65		11.91- 05.03	JS1140	12 2.2
L 400 2.0	(PA0V)[4G63]					A13 06.96- 03.01	JS628	12 1.2
						06.96- 03.01	JS349	12 0.9
L 400 2.5 TD 2500	(PA5V)[4D56T]	12.94- 12.95	JA1411IR	14 65		12.94- 03.01	JS1140	12 2.2
		01.96- 03.01	JA1183IR	14 65				
		01.96- 03.01	JA1271IR	14 75				
		A13 01.96- 03.01	JA1533IR	14 80				
		A13 01.96- 03.01	JA1802IR	14 90				
	(PA5W)[4D56T]	12.94- 12.95	JA1411IR	14 65		12.94- 03.01	JS1140	12 2.2
		01.96- 03.01	JA1183IR	14 65				
		01.96- 03.01	JA1271IR	14 75				
		A13 01.96- 03.01	JA1533IR	14 80				
		A13 01.96- 03.01	JA1802IR	14 90				
L 400 2.5 TD 2500 4WD	(PA0V)[4D56T]	12.94- 03.01	JA1411IR	14 65		12.94- 03.01	JS1140	12 2.2
		05.96- 03.01	JA1802IR	14 90				
Lancer 1.2	(A171)[4G11]	01.80- 12.81	JA150IR	14 45		01.80- 12.81	JS350	12 0.7
	(A7_)[4G36]					01.78- 09.79	JS350	12 0.7
	(C15AS)[4G16]					01.84- 10.86	JS350	12 0.7
	(C65A)[4G16]					08.86- 04.88	JS350	12 0.7
Lancer 1.3	(C6_A)[4G13]	04.88- 05.92	JA598IR	14 60		04.88- 05.92	JS349	12 0.9
		04.88- 05.92	JA689IR	14 75				
	(C61A)[G13B]	08.88- 05.92	JA598IR	14 60		08.88- 05.92	JS349	12 0.9
		08.88- 05.92	JA689IR	14 75				
	(CB1A)[4G13]	06.92- 12.94	JA1181IR	14 75		06.92- 12.94	JS349	12 0.9
Lancer 1.3 12V	(C61A)[4G13]	01.91- 05.94	JA598IR	14 60		01.91- 05.94	JS349	12 0.9
		01.91- 05.94	JA689IR	14 75				
Lancer 1.3 12V GLX	[4G13]	12.95- 05.01	JA1531IR	14 80		12.95- 06.99	JS925	12 0.9
		12.95- 05.01	JA1805IR	14 90				
Lancer 1.3 16V	(CS_A)[4G13]					09.03-	JS1139	12 1.2
Lancer 1.4	(A172)[4G12]	09.79- 02.83	JA150IR	14 45		09.79- 02.83	JS350	12 0.7
	(A7_)[4G33]					01.78- 09.79	JS350	12 0.7
	(A7_K)[4G33]					01.78- 09.79	JS350	12 0.7
Lancer 1.5	(C12AS)[4G15]	11.83- 05.86	JA159IR#	14 65		11.83- 04.88	JS350	12 0.7
	[G15B]	06.85- 05.86	JA159IR#	14 65		06.85- 04.88	JS350	12 0.7
	(C12V)[4G15]	09.85- 05.86	JA159IR#	14 65		09.85- 12.87	JS350	12 0.7
		09.88- 12.90	JA598IR	14 60		09.88- 12.90	JS349	12 0.9
		09.88- 12.90	JA689IR	14 75				
	[G15B]	09.85- 05.86	JA159IR#	14 65		09.85- 08.89	JS350	12 0.7
	(C6_A,CT_A)[4G15]	06.88- 05.92	JA598IR	14 60		06.88- 05.92	JS350	12 0.7
		06.88- 05.92	JA689IR	14 75		A13 06.88- 05.92	JS349	12 0.9
	(C62A)[4G15]	04.88- 05.92	JA598IR	14 60		AT 06.90- 05.92	JS643	12 0.9
		04.88- 05.92	JA689IR	14 75		AT 04.88- 05.92	JS349	12 0.9
	[4A91]	06.08-	JA1895IR	14 85		06.08-	JS1359	12 0.9
Lancer 1.5 12V	(C12V)[4G15]	09.90- 12.91	JA598IR	14 60		09.90- 12.91	JS349	12 0.9
		09.90- 12.91	JA689IR	14 75				
	(C62A)[4G15]	05.89- 05.92	JA598IR	14 60		AT 05.89- 05.92	JS349	12 0.9
		05.89- 05.92	JA689IR	14 75		AT 06.90- 05.92	JS643	12 0.9



Lancer 1.5 16V	(CJ2A)[4G15]						AT 12.95- 08.03	JS925	12	0.9
							12.95- 08.03	JS925	12	0.9
Lancer 1.6	(A174)[4G32GS]	03.79- 02.83	JA1501R	14	45		03.79- 02.83	JS350	12	0.7
	(A7_)[4G32GS]	01.79- 07.79	JA1501R	14	45		01.78- 09.79	JS349	12	0.9
							01.78- 09.79	JS350	12	0.7
	(C66A)[4G92]	06.92- 05.94	JA1126IR	14	75		06.92- 05.94	JS349	12	0.9
	(CB/D_A)[4G92]	02.94- 02.94	JA1126IR	14	75		AT 02.94-	JS643	12	0.9
	(CB4A)[4G92]	06.92- 12.96	JA1126IR	14	75		06.92- 12.96	JS1003	12	0.9
	(CS_A)						09.03-	JS1139	12	1.2
	(CS_W)[4G18]						09.03-	JS1139	12	1.2
Lancer 1.6 16V	(CJA4)	12.95- 08.03	JA1523IR	14	85		12.95- 08.03	JS925	12	0.9
							12.95- 08.03	JS1139	12	1.2
Lancer 1.6 16V 4WD	[4G92]	06.92- 10.03	JA1126IR	14	75		06.92- 10.03	JS1003	12	0.9
Lancer 1.6 16V 4WD GLXi	[4G92]	12.92- 10.03	JA1126IR	14	75		12.92- 10.03	JS1003	12	0.9
Lancer 1.6 16V GLXi	[4G92]	12.92- 10.03	JA1126IR	14	75		12.92- 10.03	JS1003	12	0.9
Lancer 1.8	(CY/Z_A)[4B10]	05.10-	CA2013IR*	14	120					
	[4B10]	02.08-	CA2013IR*	14	120					
Lancer 1.8 4WD	(C37V)[4G37]	01.87- 12.90	JA1591R#	14	65		A13 01.87- 05.92	JS349	12	0.9
							06.90- 05.92	JS350	12	0.7
	(C77A)[4G37]	09.89- 06.92	JA6661R	14	60		09.89- 06.92	JS349	12	0.9
	[G37B]	01.87- 08.89	JA1591R#	14	65		01.87- 08.89	JS349	12	0.9
Lancer 1.8 Sportsback	(CX_A)[4B10]	05.10-	CA2013IR*	14	120					
Lancer 1.8 16V	(CB/D_A)[4G93]						05.92- 11.95	JS1003	12	0.9
Lancer 1.8 GTi 16V	(C68A)[4G67]	11.89- 05.92	JA6641R	14	65		11.89- 05.92	JS628	12	1.2
	(C69A)[4G93]						06.92- 07.95	JS1003	12	0.9
Lancer 1.8 Diesel	(C14V)[4D65]	04.88- 06.92	JA7931R#	14	65					
	(C64A)[4D65]	04.88- 05.92	JA7931R#	14	65		04.88- 05.92	JS769	12	2.2
Lancer 2.0 EVO X	(CY4A)[4B11]	06.08-	CA2013IR*	14	120					
Lancer 2.0 Ralliart	(CY/Z_A)[4B11T/C]	10.08-	CA2013IR*	14	120					
Lancer 2.0 Sportsback Ralliart	(CX_A)[4B11]	10.08-	CA2013IR*	14	120					
Lancer 2.0 Turbo	(A176)[4G32T]	03.81- 02.83	JA1501R	14	45					
Lancer 2.0 Di-D	(CY8A)[BKD]	01.08-	CA1763IR	14	150		01.08-	CS1460*	12	2.0
Lancer 2.0 Diesel	(C6_A, C7_A)[4D68]	06.92- 07.93	JA7931R#	14	65		06.92- 07.93	JS344	12	2.0
	(CB8A)[4D68]	06.92- 12.96	JA1133IR	14	75		06.92- 12.96	JS344	12	2.0
Lancer 2.0 Diesel GLX	(CB_W, CD_W)[4D68]	12.92- 10.03	JA1133IR	14	75		12.92- 10.03	JS344	12	2.0
Lancer F 1.2	(A171)[4G11]	03.83- 01.84	JA1501R	14	45		03.83- 01.84	JS350	12	0.7
Lancer F 1.4	(A172)[4G12]	03.83- 01.84	JA1501R	14	45		03.83- 01.84	JS350	12	0.7
Lancer F 1.4 Turbo	(A17_)[4G12T]	03.83- 01.84	JA1501R	14	45		03.83- 01.84	JS350	12	0.7
Mirage 1.5	(CJ2A)[4G15]	09.95- 08.99	JA1805IR	14	90		09.95- 08.99	JS925	12	0.9
Outlander 2.0	(CW4W)[4B11]	11.06-	CA2013IR*	14	120					
Outlander 2.0 Di-D	(CW8W)[BSY]	02.07-	CA1763IR	14	150		02.07-	CS1460*	12	2.0
Outlander 2.2 Di-D	(CW7W)	08.07-	CA2008IR	14	150		08.07-	CS594	12	1.4
							08.07-	CS1416	12	2.5
Outlander 2.4 Mivec	(CW5W)[4B12]	09.07-	CA2013IR*	14	120					
Pajero 1.8 Pinin	[4G93]	09.01-	JA1523IR	14	85		11.01-	JS1139	12	1.2
Pajero 1.8 GDi	(V2_W, V4_W)[4G93]	06.98- 04.00	JA1522IR	14	100		06.98- 04.00	JS1139	12	1.2
							11.97- 08.99	JS1139	12	1.2
Pajero 1.8 GDi 4x4	(V2_W, V4_W)	11.97- 08.99	JA1522IR	14	100					
Pajero 1.8 GDi Pinin	(H6_W, H7_W)[4G93]	06.00- 06.01	JA1523IR	14	85		06.98- 08.01	JS1139	12	1.2
Pajero 2.0 GDi Pinin	(H67W/H77W)[4G94]	10.00-	JA1522IR	14	100		10.00-	JS1139	12	1.2
Pajero 2.3 Diesel	(L04_G, L14_G)	10.84- 09.86	JA1481R	14	45		10.84- 09.86	JS344	12	2.0
							A13 10.84- 09.86	JS769	12	2.2
Pajero 2.3 TD	(L043G)[4D55T]	12.82- 04.86	JA1481R	14	45		12.82- 04.86	JS344	12	2.0
							A13 12.82- 04.86	JS769	12	2.2
	(L048G)[4D55]	12.82- 04.86	JA1481R	14	45		12.82- 04.86	JS344	12	2.0
Pajero 2.4	(V2_W, V4_W)[4G64]	04.91- 02.00	JA6701R	14	60		04.91- 02.00	JS349	12	0.9
							11.97- 10.98	JS1227	12	2.2
Pajero 2.5 Diesel Sport 4x4	(K90)	11.97- 10.98	JA1533IR	14	80					
Pajero 2.5 TD	(L044G)[4D56T]	05.86- 12.90	JA5851R	14	60		w/Intercooler 11.89- 12.91	JS770	12	2.0
							05.86- 12.90	JS344	12	2.0
							A13 11.89- 12.91	JS892	12	2.2
							AT 01.90- 12.91	JS769	12	2.2
	(L049G)[4D56T]	05.86- 06.91	JA5851R	14	60		05.86- 06.91	JS344	12	2.0
	(V24C,W)[4D56TD]	12.90- 10.93	JA1184IR	14	90		A13 12.90- 04.00	JS892	12	2.2
							AT 12.90- 04.00	JS769	12	2.2
							12.90- 10.93	JS770	12	2.0
Pajero 2.5 TD Classic	(V2_W)[4D56]	AC 07.02-	JA1533IR	14	80		07.02-	JS1227	12	2.2
Pajero 2.5 TD Sport	(K9_)[4D56T]	08.98- 08.99	JA1271IR	14	75		08.98-	JS1351	12	2.0
							08.98-	JS1227	12	2.2
							AC 07.02-	JA1533IR	14	80
							09.01-	JS1227	12	2.2
Pajero 2.5 TDi	(V60)	AC 09.01-	JA1533IR	14	80					
Pajero 2.6	(L042G)[4G54]	01.83- 06.86	JA1511R	14	50		05.86- 11.90	JS628	12	1.2
							01.83- 11.90	JS349	12	0.9
	(L047G)[4G54]	12.82- 06.91	JA1511R	14	50		12.82- 06.91	JS349	12	0.9
							A13 12.82- 06.91	JS628	12	1.2
Pajero 2.8 TD	(V46W)[4M40]	11.93- 04.00	JA1375IR	14	75		09.95- 04.00	JS1221	12	2.2
Pajero 3.0	(V2_W, V4_W)[6G72]	11.93- 04.00	JA1376IR	14	90					
							06.94- 04.00	JS658	12	1.2
Pajero 3.0 24V	(V2_W, V4_W)[6G72]	06.94- 04.00	JA1180IR	14	90					
Pajero 3.0 V6 24V	(V2_W, V4_W)[6G72]	06.94- 04.00	JA1180IR	14	90		06.94- 05.97	JS658	12	1.2
							06.97- 04.00	JS658	12	1.2
							06.97- 04.00	JS658	12	1.2
Pajero 3.0 V6	(C23C,W,43W)[6G72]	12.90- 05.94	JA6851R	14	75		12.90- 05.94	JS658	12	1.2
	(L141G)[6G72]	11.88- 11.90	JA6851R	14	75		11.88- 11.90	JS658	12	1.2
	(L146G)[6G72]	11.88- 06.91	JA6851R	14	75		11.88- 06.91	JS658	12	1.2
Pajero 3.0 V6 Sport	(K9_)[6G72]	08.98-	JA1180IR	14	90		08.98-	JS658	12	1.2
	(K90)[6G72]	03.03-	JA1180IR	14	90		03.03-	JS658	12	1.2
Pajero 3.2 Di-D	(V60)[4M41]	04.00- 10.01	JA1617IR	14	125		02.00- 10.01	JS1221	12	2.2
	(V80)[4M41]	AC 02.00-	JA1617IR	14	125					
Pajero 3.2 Di-D 4WD	(V2_W)[4M41]	05.05-	JA1617IR	14	125		02.07-	JS1221	12	2.2
Pajero 3.2 Di-D 4x4	(V88, V98)[4M41]						05.05-	JS1221	12	2.2
Pajero 3.2 Di-D Pinin 4x4	(H6_W, H7_W)[4M41]	09.99- 09.06	JA1617IR	14	125		01.09-	JS1221	12	2.2
Pajero 3.5 GDi	(V60)[6G74]	04.00-	JA1601IR	14	100		09.99- 09.06	JS1221	12	2.2
							04.00- 05.03	JS658	12	1.2

**MITSUBISHI Continued**

Pajero 3.5 V6 24V	(V2_W,V4_W)[6G74]	11.93- 02.00	JA1180IR	14 90	11.93- 02.00	JS658	12 1.2
		11.93- 02.00	JA1601IR	14 100			
	(V25W,V45W)[6G74]	11.93- 04.00	JA1180IR	14 90	11.93- 04.00	JS658	12 1.2
Santamo 2.0 16V		11.93- 04.00	JA1601IR	14 100	05.99-	JS349	12 0.9
		05.99-	JA671IR	14 75	05.99-	JS1004	12 1.2
					AC 05.99-	JS628	12 1.2
Santamo 2.0 16V 4WD					05.99-	JS1004	12 1.2
		05.99-	JA671IR	14 75	AC 05.99-	JS628	12 1.2
					05.99-	JS349	12 0.9
Sapporo 1.6	(A121)[4G32]				04.78- 07.80	JS350	12 0.7
	(A161A)[4G32]	08.80- 09.84	JA150IR	14 45	08.80- 09.84	JS350	12 0.7
Sapporo 2.0	(A123)[4G52]	04.78- 07.80	JA151IR	14 50	04.78- 07.80	JS350	12 0.7
	(A161A)[4G63]	08.80- 09.84	JA151IR	14 50	08.80- 09.84	JS350	12 0.7
Sapporo 2.0 Turbo	(A164)[4G63T]				08.82- 08.83	JS350	12 0.7
Sapporo 2.4	(E16A)[4G64]	06.87- 08.90	JA598IR	14 60			
		06.87- 08.90	JA689IR	14 75			
Shogun 2.5 TD	(P25W)[4D56]	06.86- 11.88	JA585IR	14 60			
		11.88- 12.96	JA674IR	14 65			
Sigma 3.0 i 24V	(F16A)[6G72]	12.90- 07.96	JA995IR	14 110			
Sigma 3.0 i V6	(F16A)[6G72]				12.90- 07.96	JS658	12 1.2
Sigma 3.0 V6	(F07W)[6G72]						
Space Gear 2.0 16V	(PA3V/W, PB3V)[4G63]				06.94- 05.00	JS349	12 0.9
Space Gear 2.0 16V L400	(PA3V/W)[4G63]	12.94- 05.00	JA1167IR	14 75	12.94- 05.00	JS349	12 0.9
					AT 12.94- 05.00	JS628	12 1.2
Space Gear 2.4 i	(PA4W)[4G64]				12.94- 05.00	JS628	12 1.2
Space Gear 2.4 i 4WD	(PA4W)[4G64]				12.94- 05.00	JS628	12 1.2
Space Gear 2.5 TD	(PA0)[4D56T]	06.94- 03.01	JA1802IR	14 90	06.94- 03.01	JS1140	12 2.2
	(PA5W)[4D56TD]	06.94- 03.01	JA1802IR	14 90	06.94- 03.01	JS1140	12 2.2
Space Gear 2.5 TD 4WD	(PA5W)[4D56TD]	12.94- 03.01	JA1802IR	14 90	12.94- 03.01	JS1140	12 2.2
Space Runner 1.8	(N11W)[4G93]	06.93- 12.01	JA1126IR	14 75	06.92- 12.01	JS1003	12 0.9
					06.91- 05.92	JS349	12 0.9
	[4G93]	07.93- 05.99	JA1126IR	14 75	06.91- 05.99	JS350	12 0.7
Space Runner 1.8 4WD	(N21W)[4G93]	06.93- 12.01	JA1126IR	14 75	06.92- 12.01	JS1003	12 0.9
					06.91- 05.92	JS349	12 0.9
	[4G93]	07.93- 05.99	JA1126IR	14 75	06.92- 05.99	JS1003	12 0.9
Space Runner 2.0	(N50)[4G63]	05.99- 08.02	JA1522IR	14 100	05.99- 08.02	JS1313	12 1.2
					05.99- 08.02	JS1300	12 0.9
					05.99- 08.02	JS1300	12 0.9
Space Runner 2.0 16V	[4G63]	05.99- 08.02	JA1522IR	14 100	05.99- 08.02	JS1313	12 1.2
Space Runner 2.0 TD GLX	[4D68T]	06.92- 08.93	JA1187IR#	14 65	05.96- 12.02	JS344	12 2.0
		09.93- 12.02	JA1133IR	14 75			
Space Runner 2.4 GDI	(N64W)[4G64]	05.99- 08.02	JA1522IR	14 100	08.99- 08.02	CS1459	12 1.4
Space Star 1.3 16V	(DGO)[4G13]	06.98-	CA1585IR	14 90	06.98-	CS886	12 1.3
	(DGO)[4G13]	06.98-	CA1585IR	14 90	06.98-	CS886	12 1.3
Space Star 1.6 16V	[4G13]	06.98-	CA1585IR	14 90	06.98-	CS886	12 1.3
	(DGO)[4G18]	01.01-	CA1585IR	14 90	01.01-	CS886	12 1.3
Space Star 1.8 GDI	(DGO)[4G93]				10.02-	CS886	12 1.3
	[4G93]	06.98-	JA1522IR	14 100	06.98-	JS1139	12 1.2
Space Star 1.8 GDI		06.98-	JA1523IR	14 85	06.98- 08.02	JS1139	12 1.2
	(DGO)	06.98- 08.02	JA1522IR	14 100			
Space Star 1.9 Diesel Di	(DGO)[F9Q1]				06.00-	CS1193	12 1.8
	[F9Q2]				10.02-	CS1193	12 1.8
Space Wagon 1.8	(N31W)[4G93]				05.91- 05.92	JS349	12 0.9
Space Wagon 1.8 4WD	(N41W)[4G93]				05.91- 05.92	JS349	12 0.9
	[4G37]	07.87- 05.91	JA598IR	14 60	10.87- 05.91	JS349	12 0.9
Space Wagon 1.8 GLX	(D05V)[4G37]	07.87- 12.88	JA666IR	14 60	10.87- 05.91	JS628	12 1.2
					06.87- 12.88	JS628	12 1.2
Space Wagon 1.8 TD	(D09W)[4D65T]	07.87- 04.91	JA654IR#	14 65	01.84- 12.88	JS349	12 0.9
	(N35W)[4D65T]	05.91- 05.92	JA793IR#	14 65	06.87- 04.91	JS344	12 2.0
Space Wagon 2.0	(D04W)[4G63]	06.88- 04.91	JA598IR	14 60	05.91- 05.92	JS344	12 2.0
					06.88- 04.91	JS349	12 0.9
					06.88- 04.91	JS628	12 1.2
					06.86- 05.88	JS349	12 0.9
					06.87- 05.88	JS628	12 1.2
					06.87- 05.88	JS628	12 1.2
Space Wagon 2.0 4WD	(N3_W, N4_W)[4G63]	05.91- 10.97	JA1167IR	14 75	05.91- 10.97	JS1003	12 0.9
		05.91- 10.97	JA1284IR	14 90	AT 05.91- 10.97	JS1004	12 1.2
	(N33W)[4G63]	06.92- 12.00	JA1167IR	14 75	AT 10.92- 12.00	JS1004	12 1.2
		06.92- 12.00	JA1284IR	14 90	10.92- 12.00	JS1003	12 0.9
Space Wagon 2.0 4WD	(D08W)[4G63]	06.88- 04.91	JA598IR	14 60	03.85- 04.91	JS349	12 0.9
					06.87- 04.91	JS628	12 1.2
	[G63B]				06.86- 05.88	JS349	12 0.9
					06.87- 05.88	JS628	12 1.2
Space Wagon 2.0 GDI	(N43W)[4G63]	06.92- 11.00	JA1167IR	14 75	10.92- 11.00	JS1003	12 0.9
		06.92- 11.00	JA1284IR	14 90	AT 10.92- 11.00	JS1004	12 1.2
Space Wagon 2.0 TD	[4G93]	04.02- 12.04	JA1522IR	14 100	04.02- 12.04	JS1300	12 0.9
	(N38W)[4D68T]	06.92- 11.00	JA1133IR	14 75	06.92- 11.00	JS344	12 2.0
Space Wagon 2.4 GDI		06.92- 05.93	JA1187IR#	14 65			
		06.97- 11.00	JA1360IR	14 90			
Space Wagon 2.4 GDI	(N84W)[4G64]	10.98- 01.04	JA1522IR	14 100 ▲	10.98- 01.04	CS1459	12 1.4
Space Wagon 2.4 GDI 4WD					10.98- 01.04	JS1313	12 1.2
	(N94W)[4G64]	07.98- 01.04	JA1522IR	14 100 ▲	07.98- 01.04	JS1313	12 1.2
Space Wagon 2.4 GDI					07.98- 01.04	CS1459	12 1.4
	(N84W)[4G64]	09.00- 01.04	JA1522IR	14 100	09.00- 01.04	CS1459	12 1.4
Space Wagon 2.4 GDI 4WD					09.00- 01.04	JS1313	12 1.2
	(N94W)[4G64]	07.98- 01.04	JA1522IR	14 100	07.98- 01.04	CS1459	12 1.4
Starion 2.0 Turbo	(A183A)[4G63T/C]	06.86- 05.88	JA670IR	14 60	05.85- 05.88	JS350	12 0.7
	(A183E)[4G63T]				06.82- 12.85	JS350	12 0.7
Starion 2.6 Turbo	(A187)[G54BT/C]				12.89- 06.90	JS628	12 1.2
Tredia 1.4	(A211)[4G12]	10.82- 08.85	JA150IR	14 45	10.82- 08.85	JS349	12 0.9
Tredia 1.6	(A212)[4G32]				09.82- 11.87	JS396#	12 0.7
Tredia 1.6 Turbo	(A212)[4G32T]	09.84- 05.85	JA159IR#	14 65	09.82- 05.85	JS396#	12 0.7
Tredia 1.8	(A215)[4G37]	08.84- 11.87	JA159IR#	14 65	08.84- 11.87	JS349	12 0.9
Tredia 1.8 Turbo	(A21_)[G62B]				A13 09.84- 09.85	JS349	12 0.9
					09.84- 09.85	JS350	12 0.7
<b>PASSENGER CARS US</b>							
3000 GT 3.0	[6G72]	01.93- 01.99	JA995IR	14 110	01.93- 01.95	JS658	12 1.2
		01.91- 01.92	JA995IR	14 110			
3000 GT 3.0 SL	[6G72]	01.93- 01.99	JA995IR	14 110	01.91- 01.92	JS658	12 1.2
		01.91- 01.92	JA995IR	14 110	01.93- 01.95	JS658	12 1.2
					01.91- 01.92	JS658	12 1.2





3000 GT 3.0 Spyder SL	[6G72]	01.95- 01.95	JA995IR	14 110	01.95- 01.95	JS658	12 1.2
3000 GT 3.0 Turbo Spyder VR-4	[6G72]	01.95- 01.95	JA995IR	14 110	01.95- 01.96	JS658	12 1.2
3000 GT 3.0 Turbo VR4	[6G72T]	01.99- 01.99	JA995IR	14 110	01.99- 01.99	JS658	12 1.2
3000 GT 3.0 Turbo VR-4	[6G72]	01.93- 01.98	JA995IR	14 110	01.93- 01.98	JS658	12 1.2
		01.91- 01.92	JA995IR	14 110	01.91- 01.92	JS658	12 1.2
Cordia 1.8					01.83- 01.83	JS350	12 0.7
Cordia 1.8 Turbo					01.86- 01.88	JS350	12 0.7
Cordia 1.8 Turbo L					01.85- 01.85	JS350	12 0.7
Cordia 1.8 Turbo LS					01.84- 01.84	JS350	12 0.7
Cordia 2.0					01.84- 01.88	JS350	12 0.7
					01.86- 01.88	JS628	12 1.2
Cordia 2.0 L					01.84- 01.85	JS350	12 0.7
Cordia 2.0 LS					01.84- 01.84	JS350	12 0.7
Diamante 3.0							
Diamante 3.0 ES	[6G72]						
Diamante 3.0 LS	[6G72]						
Eclipse 1.8		01.90- 01.94	JA666IR	14 60	01.90- 01.94	JS350	12 0.7
					01.93- 01.94	JS643	12 0.9
Eclipse 1.8 GS		01.90- 01.94	JA666IR	14 60	01.90- 01.94	JS350	12 0.7
					01.93- 01.94	JS643	12 0.9
Eclipse 2.0 GS		01.90- 01.94	JA671IR	14 75	01.90- 01.94	JS628	12 1.2
Eclipse 2.0 Turbo GS		01.90- 01.94	JA671IR	14 75	01.90- 01.94	JS628	12 1.2
Eclipse 2.0 Turbo GST	[4G63]				01.96- 01.97	JS628	12 1.2
					01.95- 01.95	JS628	12 1.2
Eclipse 2.0 Turbo GSX	[4G63]				08.95- 04.99	JS628	12 1.2
		01.90- 01.94	JA671IR	14 75	01.90- 01.95	JS628	12 1.2
Eclipse 2.0 Turbo Spyder GST	[4G63]				01.96- 01.97	JS628	12 1.2
Eclipse 2.4 SPYDER	[4G64]				01.99- 01.99	JS628	12 1.2
Eclipse 2.4 Spyder GS	[4G64]				01.96- 01.98	JS628	12 1.2
Expo 1.8 LRV		01.94- 01.94	JA1126IR	14 75	01.92- 01.94	JS1003	12 0.9
Expo 1.8 LRV Sport					01.92- 01.92	JS1003	12 0.9
Expo 2.4	[4G64]	01.93- 01.95	JA1167IR	14 75	01.93- 01.95	JS628	12 1.2
		01.92- 01.92	JA671IR	14 75	01.92- 01.92	JS350	12 0.7
		01.92- 01.92	JA1167IR	14 75	01.92- 01.92	JS628	12 1.2
Expo 2.4 LRV		01.93- 01.94	JA1167IR	14 75			
Expo 2.4 LRV Sport		01.93- 01.94	JA1167IR	14 75			
Expo 2.4 SP	[4G64]	01.93- 01.93	JA1167IR	14 75	01.92- 01.92	JS350	12 0.7
		01.92- 01.92	JA671IR	14 75	01.92- 01.92	JS628	12 1.2
		01.92- 01.92	JA1167IR	14 75	01.89- 01.92	JS350	12 0.7
Galant 2.0		01.89- 01.92	JA671IR	14 75	01.89- 01.92	JS628	12 1.2
		01.91- 01.92	JA684IR	14 90	01.93- 01.93	JS628	12 1.2
Galant 2.0 ES		01.93- 01.93	JA684IR	14 90	01.89- 01.92	JS628	12 1.2
		01.93- 01.93	JA671IR	14 75	01.89- 01.92	JS350	12 0.7
Galant 2.0 GS		01.89- 01.92	JA671IR	14 75	01.91- 01.92	JS350	12 0.7
		01.91- 01.92	JA684IR	14 90	01.91- 01.92	JS628	12 1.2
Galant 2.0 GSR		01.91- 01.92	JA684IR	14 90	01.90- 01.92	JS350	12 0.7
		01.91- 01.92	JA671IR	14 75	01.90- 01.92	JS628	12 1.2
Galant 2.0 GSX		01.91- 01.92	JA684IR	14 90	01.89- 01.92	JS350	12 0.7
		01.90- 01.92	JA671IR	14 75	01.89- 01.93	JS628	12 1.2
Galant 2.0 LS		01.89- 01.93	JA671IR	14 75	01.93- 01.93	JS628	12 1.2
		01.91- 01.93	JA684IR	14 90	01.91- 01.92	JS628	12 1.2
Galant 2.0 S		01.93- 01.93	JA671IR	14 75	01.87- 01.87	JS628	12 1.2
		01.93- 01.93	JA684IR	14 90			
Galant 2.0 Turbo VR-4		01.91- 01.92	JA684IR	14 90			
Galant 2.4		01.87- 01.87	JA598IR	14 60			
Galant 2.4 DE	[4G64]				01.97- 01.98	JS628	12 1.2
Galant 2.4 ES	[4G64]	01.94- 01.97	JA1167IR	14 75	01.94- 01.98	JS628	12 1.2
Galant 2.4 GS		01.94- 01.94	JA1167IR	14 75	01.94- 01.94	JS628	12 1.2
Galant 2.4 LS	[4G64]	01.94- 01.97	JA1167IR	14 75	01.94- 01.98	JS628	12 1.2
Galant 2.4 S	[4G64]	01.94- 01.96	JA1167IR	14 75	01.94- 01.96	JS628	12 1.2
Lancer 2.0		01.02- 01.03	JA1523IR	14 85	01.02- 01.03	JS1139	12 1.2
Lancer 2.0 Turbo Evolution		01.03- 01.03	JA1523IR	14 85	01.83- 01.86	JS350	12 0.7
Mighty Max 2.0					01.84- 01.86	JS349	12 0.9
					01.83- 01.84	JS350	12 0.7
Mighty Max 2.0 S					01.84- 01.84	JS349	12 0.9
					01.89- 01.89	JS350	12 0.7
Mighty Max 2.0 SWB					01.89- 01.89	JS628	12 1.2
					01.83- 01.85	JS628	12 1.2
Mighty Max 2.3 Turbo SP					01.83- 01.85	JS769	12 2.2
					01.83- 01.83	JS344	12 2.0
					01.84- 01.84	JS628	12 1.2
Mighty Max 2.3 Turbo SPX					01.84- 01.84	JS769	12 2.2
					01.90- 01.94	JS628	12 1.2
Mighty Max 2.4					01.90- 01.94	JS350	12 0.7
					01.92- 01.93	JS628	12 1.2
Mighty Max 2.4 LWB					01.92- 01.93	JS350	12 0.7
Mighty Max 2.4 SWB	[4G64]				01.95- 01.96	JS350	12 0.7
					01.95- 01.96	JS628	12 1.2
					01.92- 01.92	JS628	12 1.2
					01.92- 01.92	JS350	12 0.7
Mighty Max 2.6					01.88- 01.89	JS628	12 1.2
Mighty Max 2.6 LWB					01.89- 01.89	JS628	12 1.2
Mighty Max 2.6 SP		01.83- 01.83	JA148IR	14 45	01.83- 01.86	JS350	12 0.7
Mighty Max 2.6 SPX		01.83- 01.83	JA148IR	14 45	01.87- 01.89	JS628	12 1.2
					01.83- 01.86	JS350	12 0.7
Mighty Max 2.6 SWB					01.89- 01.89	JS628	12 1.2
Mighty Max 3.0 SWB		01.92- 01.92	JA685IR	14 75	01.92- 01.92	JS658	12 1.2
Mirage 1.5	[4G15]	01.91- 01.92	JA689IR	14 75	01.99- 01.99	JS925	12 0.9
		01.99- 01.01	JA1531IR	14 80	01.00- 01.02	JS1139	12 1.2
					01.91- 01.92	JS350	12 0.7
					01.91- 01.92	JS643	12 0.9
		01.89- 01.90	JA689IR	14 75	01.85- 01.90	JS350	12 0.7
					01.85- 01.85	JS349	12 0.9
Mirage 1.5 DE	[4G15]	01.97- 01.98	JA1531IR	14 80	01.97- 01.98	JS925	12 0.9
Mirage 1.5 ES	[4G15]	01.93- 01.95	JA689IR	14 75	01.93- 01.95	JS350	12 0.7
Mirage 1.5 L					01.85- 01.88	JS350	12 0.7
					01.85- 01.85	JS349	12 0.9
Mirage 1.5 LS	[4G15]	01.91- 01.93	JA689IR	14 75	01.91- 01.93	JS350	12 0.7
					01.91- 01.93	JS643	12 0.9
		01.89- 01.90	JA689IR	14 75	01.89- 01.90	JS350	12 0.7
Mirage 1.5 RS		01.90- 01.90	JA689IR	14 75	01.90- 01.90	JS350	12 0.7
Mirage 1.5 S	[4G15]	01.93- 01.96	JA689IR	14 75	01.93- 01.96	JS350	12 0.7

**MITSUBISHI Continued**

Mirage 1.5 VL	[4G15]	01.91- 01.92	JA689IR	14 75	01.91- 01.92	JS350	12 0.7
					01.91- 01.92	JS643	12 0.9
		01.90-	JA689IR	14 75	01.90-	JS350	12 0.7
Mirage 1.6 GS		01.91- 01.92	JA671IR	14 75	01.91- 01.92	JS628	12 1.2
Mirage 1.6 Turbo		01.89- 01.89	JA671IR	14 75	01.89- 01.89	JS628	12 1.2
					01.88- 01.88	JS350	12 0.7
Mirage 1.6 Turbo L		01.85- 01.85	JA159IR#	14 65	01.85- 01.85	JS350	12 0.7
					01.85- 01.85	JS349	12 0.9
Mirage 1.6 Turbo LS		01.86- 01.87	JA159IR#	14 65	01.86- 01.87	JS350	12 0.7
Mirage 1.8	[4G93]	01.99- 01.02	JA1523IR	14 85	01.99- 01.02	JS1139	12 1.2
					01.99- 01.99	JS925	12 0.9
Mirage 1.8 ES	[4G93]	01.93- 01.95	JA1126IR	14 75	01.93- 01.95	JS1003	12 0.9
Mirage 1.8 LS	[4G93]	01.93- 01.96	JA1126IR	14 75	01.97- 01.98	JS925	12 0.9
		01.98- 01.98	JA1523IR	14 85	01.93- 01.96	JS1003	12 0.9
					01.98- 01.98	JS1139	12 1.2
Montero 2.4 Sport ES	[4G64]				01.97- 01.97	JS628	12 1.2
Montero 2.6		01.83- 01.86	JA148IR	14 45	01.83- 01.86	JS350	12 0.7
					01.87- 01.89	JS628	12 1.2
Montero 2.6 Sport					01.87- 01.88	JS628	12 1.2
Montero 3.0		01.89- 01.94	JA685IR	14 75	01.89- 01.94	JS658	12 1.2
Montero 3.0 LS		01.89- 01.96	JA685IR	14 75	01.89- 01.96	JS658	12 1.2
Montero 3.0 LS Sport	[6G72]	01.98- 01.98	JA1180IR	14 90	01.98- 01.98	JS658	12 1.2
Montero 3.0 RS		01.91- 01.93	JA685IR	14 75	01.91- 01.93	JS658	12 1.2
Montero 3.0 Sport	[6G72]	01.99- 01.03	JA1180IR	14 90	01.99- 01.99	JS658	12 1.2
		01.89- 01.90	JA685IR	14 75	01.89- 01.90	JS658	12 1.2
Montero 3.0 Sport LS	[6G72]	01.97- 01.97	JA1180IR	14 90	01.97- 01.97	JS658	12 1.2
Montero 3.0 Sport XLS	[6G72]	01.97- 01.97	JA1180IR	14 90	01.97- 01.97	JS658	12 1.2
Montero 3.0 SR		01.92- 01.94	JA685IR	14 75	01.92- 01.94	JS658	12 1.2
Montero 3.0 XLS Sport	[6G72]	01.98- 01.98	JA1180IR	14 90	01.98- 01.98	JS658	12 1.2
Montero 3.5	[6G74]	01.99- 01.02	JA1601IR	14 100	01.00- 01.02	JS658	12 1.2
Montero 3.5 LS	[6G74]	01.97- 01.97	JA1180IR	14 90	01.97- 01.97	JS658	12 1.2
Montero 3.5 Sport	[6G74]	01.00- 01.03	JA1180IR	14 90			
		01.99- 01.99	JA1601IR	14 100			
Montero 3.5 SR	[6G74]	01.97- 01.97	JA1180IR	14 90	01.97- 01.97	JS658	12 1.2
		01.94- 01.96	JA1180IR	14 90	01.94- 01.96	JS658	12 1.2
		01.90- 01.93	JA689IR	14 75	01.87- 01.93	JS350	12 0.7
Precis 1.5					01.87- 01.89	JS350	12 0.7
Precis 1.5 LS					01.88- 01.91	JS350	12 0.7
Precis 1.5 RS		01.90- 01.91	JA689IR	14 75	01.88- 01.90	JS658	12 1.2
Sigma 3.0					01.83- 01.83	JS350	12 0.7
Starion 2.6 Turbo		01.83- 01.88	JA151IR	14 50	01.84- 01.84	JS350	12 0.7
Starion 2.6 Turbo ES		01.84- 01.85	JA151IR	14 50	01.84- 01.84	JS350	12 0.7
Starion 2.6 Turbo LE		01.84- 01.85	JA151IR	14 50	01.84- 01.84	JS350	12 0.7
Starion 2.6 Turbo LS		01.84- 01.84	JA151IR	14 50	01.84- 01.84	JS350	12 0.7
Treda 1.8					01.83- 01.83	JS350	12 0.7
Treda 1.8 Turbo					01.86- 01.88	JS350	12 0.7
Treda 1.8 Turbo LS					01.84- 01.84	JS350	12 0.7
Treda 2.0					01.84- 01.88	JS350	12 0.7
					01.86- 01.88	JS628	12 1.2
Treda 2.0 L					01.84- 01.85	JS350	12 0.7
Treda 2.0 LS					01.84- 01.84	JS350	12 0.7
Van 2.4		01.87- 01.90	JA973IR	14 75	01.87- 01.90	JS628	12 1.2
<b>PASSENGER CARS AO</b>							
Canter 3.0 DiTD	(FB6 , FE5 , FE6 )				04.06-	CS1203	12 2.3
Colt 1.6 4WD	(CA_A)[4G92]	08.93- 08.95	JA1126IR	14 75	08.93- 08.95	JS1003	12 0.9
Eclipse 2.0 Turbo 4WD	(D3 )	12.95- 04.99	JA684IR	14 90	12.95- 04.99	JS628	12 1.2
Grandis 2.4 GDi GLX	(N94W)[4G64]	11.97- 07.00	JA1522IR	14 100	11.97- 07.00	JS1313	12 1.2
					11.97- 07.00	CS1459	12 1.4
Grandis 2.4 GDi GLX	[4G64]	08.00- 05.03	JA1522IR	14 100	08.00- 05.03	JS1313	12 1.2
					08.00- 05.03	CS1459	12 1.4
Grandis 2.4 GDi GLX 4WD	[4G64]	11.97- 05.03	JA1522IR	14 100	11.97- 05.03	CS1459	12 1.4
L 300 1.4	(P0_W, P1_W)[4G33]				04.90- 05.94	JS350	12 0.7
L 300 1.6	(L03_P)[4G32]				02.80- 10.02	JS350	12 0.7
L 300 2.0	(P0_W, P1_W)				08.94- 08.95	JS349	12 0.9
	(P1_T)				08.94- 04.00	JS349	12 0.9
L 400 2.0	(PA0V)				09.95- 10.02	JS349	12 0.9
L 400 2.4	(PA0V)				06.96- 10.02	JS628	12 1.2
	(PA0V)				06.96- 10.02	JS628	12 1.2
Lancer 1.3	(CB/D_A)[4G13]	07.90- 02.95	JA598IR	14 60	07.90- 02.95	JS350	12 0.7
Lancer 1.6 4WD	(C6_A, C7_A)[4G92]	06.92- 11.93	JA1126IR	14 75	06.92- 11.93	JS1003	12 0.9
Lancer 1.6 GLX	(C6_A)	08.89- 08.92	JA664IR	14 65			
Lancer 1.6 GTI	(C6_A)[4G61]	05.88- 05.90	JA671IR	14 75			
Pajero 3.2 DiD Pinin Exceed 4WD	[4M41]	09.99-	JA1617IR	14 125	09.99-	JS1221	12 2.2
Space Wagon 1.8 GLX	(D0_VW)[G37B]	09.88- 04.91	JA666IR	14 60	09.88- 04.91	JS349	12 0.9
<b>TRUCKS EU</b>							
Canter 211	(FE)[4D30A]				11.83-	JS553	24 3.2
Canter 35 2.5 Diesel	[4D56]	01.90- 09.96	JA148IR	14 45	01.86- 09.96	JS892	12 2.2
Canter 35 2.8 Diesel	[4M40-2AT]	07.99- 10.00	JA1375IR	14 75	07.99- 10.00	JS1221	12 2.2
	[4M40-A]	07.99- 10.00	JA1375IR	14 75	01.96-	JS1221	12 2.2
Canter 35 3.0 TD	[4M42-0AT]	11.02-	JA1375IR	14 75	09.01-	JS1221	12 2.2
Canter 444	(FE)[4D31]	11.83-	JA1427IR	28 30	01.87-	JS553	24 3.2
Canter 55 3.0 Diesel	[4M42-0AT]	11.00-	JA1375IR	14 75	09.01-	JS1221	12 2.2
Canter 60 3.3 TD	[4D31T]	08.86- 12.96	JA1427IR	28 30			
Canter 60 3.9	[4D34-2AT6]				09.01-	JS1354	24 3.2
Canter 60 3.9 TD	[4D34-2AT4]				05.96-	JS1354	24 3.2
Canter 75 3.9 TD	[4D34-2AT4]				06.97-	JS1354	24 3.2
Fuso 3.9	(FE7 , FE8 ) [4D34]				05.99-	CS1494*	24 3.7
Fuso 4.2	(FE7 , FE8 ) [4D33]				05.99-	CS1494*	24 3.7
<b>FORK LIFTS</b>							
FD20					01.83-	JS777	24 3.2
FG10					01.77- 01.79	JS362	12 1.1
					01.90-	JS915	12 1.2
FG18 1.4					01.90-	JS915	12 1.2
FG20					01.86- 12.87	JS915	12 1.2
					01.80- 12.87	JS362	12 1.1
FG25					01.80- 12.87	JS674	12 0.9
					01.80- 12.87	JS362	12 1.1
					01.86- 12.87	JS915	12 1.2
FG30 2.4					01.80- 12.87	JS362	12 1.1
					01.86- 12.87	JS915	12 1.2
Various Models						JS1009	12 2.2
						JS779	12 1.2
<b>MARINE</b>							
Various Models						JS1014	12 2.0
<b>MISC.</b>							
Mini Loader						JS1014	12 2.0



Mitsubishi Fuso						
TRUCKS EU						
Canter FE 3.9 Diesel					01.99-	CS1494* 24 3.7
Canter FG 3.9 Diesel	[4D34-2AT]				01.99- 01.04	CS1494* 24 3.7
FE Series 3.9 Diesel 238	[4D34-2.3AT]				01.99-	CS1494* 24 3.7
FG Series 3.9 Diesel 238	[4D34-3AT]				01.99-	CS1494* 24 3.7
					01.99-	CS1494* 24 3.7
Morris						
PASSENGER CARS EU						
Ital 1.3		07.80- 03.84	CA17h	14 34	07.80- 03.84	CS19 12 0.8
Ital 1.7		07.80- 03.84	CA17h	14 34		
Ital 2.0		07.80- 03.84	CA226IR	14 55		
Marina 1.3		04.70- 06.75	CG50	14 22	04.70- 10.80	CS19 12 0.8
		04.70- 10.80	CA17h	14 34		
Marina 1.3 1300		10.75- 10.80	CA17h	14 34	10.75- 10.80	CS19 12 0.8
Marina 1.7		10.78- 10.80	CA17h	14 34		
Marina 1.8		04.71- 12.79	CA17h	14 34		
Marina 1.8 1800		03.75- 10.78	CA18h	14 43		
		04.71- 10.75	CA17h	14 34		
Marina 1.8 1800 GT		03.75- 10.78	CA18h	14 43		
Marina 1.8 TC		04.71- 12.75	CA17h	14 34		
Multicar						
PASSENGER CARS EU						
Various Models						CS624 12 1.8
						CS689 12 2.5
TRUCKS EU						
M26 2.8 EcoLine ProfiLine	[8140.43R]	01.03- 01.03-	CA1557IR CA1679IR	14 90 14 120	01.03-	CS1203 12 2.3
M26 2.8 TransLine	[8140.43R]	01.03- 01.03-	CA1557IR CA1679IR	14 90 14 120	01.03-	CS1203 12 2.3
Neoplan						
TRUCKS EU						
N 1216 10.5	[D2066LOH03]	09.06-	CA1237IR	28 140		
	[D2066LOH04]	09.06-	CA1237IR	28 140		
N 2216 10.5	[D2066LOH03]	06.06-	CA1237IR	28 140		
	[D2066LOH04]	06.06-	CA1237IR	28 140		
		06.06-	CA1997IR	28 120		
N 2216 SHD 12.0	[D2866LOH34]	11.03- 11.03-	CA1237IR CA1663IR	28 140 28 90	11.03- 11.03-	CS191 24 5.4 CS198 24 6.0
N 2216 SHD 12.8	[D2876LOH03]	01.03- 11.03-	CA1237IR CA1663IR	28 140 28 90	11.03- 11.03-	CS198 24 6.0 CS191 24 5.4
N 2216 SHDL 12.0	[D2866LOH34]	11.03- 11.03-	CA1237IR CA1663IR	28 140 28 90	11.03- 11.03-	CS191 24 5.4 CS198 24 6.0
N 2216 SHDL 12.8	[D2876LOH03]	11.03- 11.03-	CA1237IR CA1663IR	28 140 28 90	11.03- 11.03-	CS191 24 5.4 CS198 24 6.0
New Holland						
AGRICULTURE						
4635	[Ford]	09.95- 09.95-	CA1330IR CA725IR	14 70 14 45		
5640 4.4		11.91- 01.98	CA1379IR	14 100	11.91- 01.98	CS200 12 2.8
6635	[Ford]	09.95- 12.98	CA564IR	14 65		
6640 5.0		11.91- 01.98	CA1379IR	14 100	11.91- 01.98	CS200 12 2.8
7635	[Ford]	09.95- 12.98	CA564IR	14 65		
7740 5.0		11.91- 01.98	CA1379IR	14 100	11.91- 01.98	CS200 12 2.8
7840 6.6		11.91- 12.98	CA1379IR	14 100	11.91- 12.98	CS200 12 2.8
8080	[M10Y]				01.79- 01.85	CS1031 12 3.6
8240 7.5		11.91- 12.96	CA1379IR	14 100	11.91- 12.96	CS200 12 2.8
8340 7.5		11.91- 07.98	CA1379IR	14 100	11.91- 07.98	CS200 12 2.8
8000 Series	[Ford]	09.95- 12.01	CA1379IR	14 100		
M SERIES		09.95-	CA1379IR	14 100	09.95-	CS1126 12 3.1
NH 95	[M8Y]				01.96-	CS1126 12 3.1
TL Series		10.98-	CA1849IR	14 65		
TS 115		07.03-	CA1379IR	14 100		
TV 140		01.98-	CA1379IR	14 100		
INDUSTRY						
EC130	[4BT3.9]	01.00- 01.01	UA1620IR	28 70		
EC160	[4BT3.9]	01.00- 01.01	UA1620IR	28 70		
EC215	[6BT A5.9]	01.00-	UA1620IR	28 70		
L60 2.9	[Fiat]	09.95- 12.98	CA1849IR	14 65		
L65 3.6	[Fiat]	09.95- 12.98	CA1849IR	14 65		
L75 3.9	[Fiat]	09.95- 12.98	CA1849IR	14 65		
L85 3.9	[Fiat]	09.95- 12.98	CA1849IR	14 65		
L95 3.9	[Fiat]	09.95- 12.98	CA1849IR	14 65		
Nissan						
PASSENGER CARS EU						
100 NX 1.6	(B13)[GA16DE]	10.92- 10.94	JA974IR	14 65	10.92- 10.94	JS759 12 0.8
	[GA16DS]	10.90- 10.92	JA974IR	14 65	AT 10.92- 10.94	JS766 12 1.2
					AT 10.90- 10.92	JS766 12 1.2
					A13 10.90- 10.92	JS520 12 1.2
					10.90- 10.92	JS759 12 0.8
100 NX 2.0 GTI	(B13)[SR20DE]	10.90- 10.95	JA762IR	14 80	10.90- 10.95	JS627 12 1.4
200SX 1.8	(S13)[CA18DE]	09.88- 03.94	JA782IR	14 80	09.88- 03.94	JS667 12 1.4
200SX 1.8 Turbo	(S13)[CA18DET]	07.88- 11.93	JA782IR	14 80	07.88- 11.93	JS667 12 1.4
		01.92- 09.94	JA782IR	14 80	01.92- 09.94	JS667 12 1.4
200SX 2.0 i 16V	(S13)[SR20DE]	07.88- 11.93	JA782IR	14 80	07.88- 11.93	JS667 12 1.4
200SX 2.0 i Turbo 16V	(S14)[SR20DET]				04.94- 12.99	JS890 12 1.4
280 ZX 2.8	(HGS130)[L28E]	10.78- 06.83	JA198IR	14 60	10.78- 06.83	JS307 12 1.0
	(HGS133)[L28E]	02.80- 09.82	JA198IR	14 60	02.80- 09.82	JS307 12 1.0
Almera 1.4	(N15)[GA14DE]	07.95- 07.00	JA1182IR	14 70	07.95- 07.00	JS759 12 0.8
					01.99- 07.00	JS1301 12 1.2
Almera 1.5	(N16)[QG15DE]	07.00-	JA1607IR	14 80	A13 07.00-	JS1100 12 1.2
	[QG15DE]	03.00-	JA1607IR	14 80	07.00- 03.03	JS1226 12 0.7
					03.00- 03.03	JS1226 12 0.7
					A13 03.00-	JS1100 12 1.2
Almera 1.5 DCi	(N16)[K9K]	01.03- 01.03-	CA1652IR CA1762IR	14 110 14 110	01.03- 11.06	CS1273 12 1.1
	[K9K722]	10.02- 11.06	CA1762IR	14 110	10.02- 11.06	CS1273 12 1.1
		01.03- 11.06	CA1652IR	14 110		
Almera 1.6	(N15)[GA16DE]	07.95- 07.00	JA1182IR	14 70	AT 07.95- 04.00	JS1100 12 1.2
					04.97- 04.00	JS1301 12 1.2
					07.95- 04.00	JS759 12 0.8
Almera 1.6 SLX	(N15)[GA16DE]	07.95- 07.00	JA1182IR	14 70	07.95- 04.00	JS759 12 0.8
					AT 07.95- 04.00	JS1100 12 1.2
					04.97- 04.00	JS1301 12 1.2
Almera 1.8	(N16)[QG18DE]	01.00- 07.02	JA1607IR	14 80	01.00- 03.04	JS1226 12 0.7
					A32 01.00- 07.02	JS1100 12 1.2



NISSAN Continued

	[QG18DE]	01.00-	JA1607IR	14 80		01.00-03.04	JS1226	12 0.7
						A32 01.00-	JS1100	12 1.2
Almera 2.0 GTI	(N15)[SR20DE]	07.96-01.99 01.99-03.00	JA1287IR JA1606IR	14 80 14 90		07.96-04.00	JS1137	12 1.4
Almera 2.0 Diesel	(N15)[CD20]	07.95-04.96 04.96-07.00	JA769IR JA1702IR	14 70 14 80		07.95-07.00	JS539 JS1001	12 2.0 12 2.2
Almera 2.2 DCi	(N16)[YD22DDT] (N16E)[YD22DDT]	02.03- 02.03-	JA1611IR JA1611IR	14 100 14 100		02.03- 5SP 02.03- 6SP 02.03-	JS1235 JS1235 JS1295	12 2.2 12 2.2 12 1.7
Almera 2.2 Diesel Di	(N16)[YD22DDT] (N16E)[YD22DDT]	07.00- 07.00- 01.00-	JA1611IR JA1615IR JA1611IR	14 100 14 90 14 100		07.00- 5SP 01.00- 6SP 02.03-	JS1235 JS1235 JS1295	12 2.2 12 2.2 12 1.7
Almera Tino 1.8	(V10)[QG18DE]	05.00-	JA1607IR	14 80		05.00-03.04	JS1226 JS1100	12 0.7 12 1.2
Almera Tino 1.8 i	(V10M)[QG18DE]	05.00-	JA1607IR	14 80		05.00-03.04	JS1226 JS1100	12 0.7 12 1.2
Almera Tino 2.0 i	(V10M)[SR20DE]	05.00-	JA1606IR	14 90		AT 05.00- AT 08.00-	JS1225 JS1226	12 1.7 HI 12 0.7 VA
Almera Tino 2.2 DCi	(V10)[YD22DDT]	02.03-	JA1611IR	14 100		6SP 02.03- 5SP 02.03- 6SP 02.03- 5SP 08.00-	JS1295 JS1235 JS1295 JS1235	12 1.7 12 2.2 12 1.7 12 2.2
Almera Tino 2.2 Diesel Di	(V10)[YD22DDT]	08.00-	JA1611IR	14 100		6SP 02.03- 5SP 08.00-	JS1295 JS1235	12 1.7 12 2.2
Bluebird 1.6	(T12)[CA16S] [CA16]	03.86-06.90 03.86-06.91	JA166IR CA564IR	14 70 14 65 ▲		03.86-06.91	JS378	12 1.0
Bluebird 1.8	(910)[L18S] [L18T] (T72, T12) (W910)[L18S] [L18]	01.80-05.84 01.80-05.84 05.86-11.92 01.80-05.84 01.80-05.84	JA104IR JA158IR# JA104IR JA158IR# JA166IR JA104IR JA158IR#	14 50 14 60 14 70 14 60 14 70 14 50 14 60		AT 01.80-05.84 01.80-05.84 AT 01.80-05.84 05.86-11.92 01.80-05.84 01.80-05.84 AT 01.79-11.79 01.79-11.79	JS307 JS302# JS302# JS307 JS378 JS307 JS302# JS307 JS302#	12 1.0 12 0.8 12 0.8 12 1.0 12 1.0 12 1.0 12 0.8 12 1.0
Bluebird 1.8 i 16V	(T72)[CA18D]	02.89-12.90	JA166IR	14 70		02.89-12.90	JS378	12 1.0
Bluebird 1.8 Turbo	(T72, T12)[CA18T]					09.88-04.90	JS378	12 1.0
Bluebird 2.0	(T12)[CA20S] (WU11)[CA20E] [CA20S]	12.85-12.87 04.84-12.90 04.86-12.87	JA166IR JA166IR JA166IR	14 70 14 70 14 70		A16 12.85-12.87 02.86-12.90 04.86-12.87	JS378 JS378 JS378	12 1.0 12 1.0 12 1.0
Bluebird 2.0 i	(910)[Z20E] (T12, T72)[CA20E] (T12, T72)[CA20E] (WU11)[CA20E]	01.82-05.84 09.88-09.90 12.85-12.90 09.88-09.90	JA104IR JA166IR JA166IR JA166IR	14 50 14 70 14 70 14 70		01.82-05.84 12.85-12.90	JS308# JS378	12 1.2 12 1.0
Cabstar 2.3 Diesel	(F22)[TD23]	01.87-12.89 01.87-12.89	JA185IR JA780IR	14 50 14 60		01.87-12.89 01.87-12.89	JS517 JS660	12 2.5 12 2.0
Cabstar 2.5 Diesel	(F22)[TD25]	01.89-12.92	JA185IR	14 50		01.89-12.92 01.89-12.92	JS660 JS517	12 2.0 12 2.5
Cherry 1.0	(N10)[A10S] (N12)[E10] (VN10)[A10] [E10]	03.79-07.81 08.81-06.82 05.82-05.86 08.78-07.81 08.78-07.81 08.81-05.82 08.81-05.82	JA100 JA104IR JA104IR JA100 JA104IR JA100 JA104IR	14 35 14 50 14 50 14 35 14 50 14 35 14 50		05.82-05.86 08.78-07.81	JS305 JS305	12 0.8 12 0.8
Cherry 1.2	(N10)[A12] (VN10)[A12]	10.78-02.82 10.78-02.82	JA100 JA100	14 35 14 35		07.81-02.82	JS305	12 0.8
Cherry 1.3	(N10)[E13] (N12)[E13] (VN10)[E13]	09.81-05.86 05.82-10.86 09.81-12.83	JA104IR JA104IR JA104IR	14 50 14 50 14 50		09.81-05.86 05.82-10.86 09.81-12.83	JS305 JS305 JS305	12 0.8 12 0.8 12 0.8
Cherry 1.4	(N10)[A14S] (VN10)[A14S]	08.81-04.82 08.80-02.81	JA104IR JA104IR	14 50 14 50				
Cherry 1.4 i.e.	(N10)[A14S]	07.81-04.82	JA104IR	14 50				
Cherry 1.5	(N10)[E15] (N12)[E15S] (VN10)[E15]	08.81-12.82 11.83-10.86 08.81-03.82	JA104IR JA104IR JA104IR	14 50 14 50 14 50		08.81-12.82 11.83-10.86 08.81-03.82	JS305 JS305 JS305	12 0.8 12 0.8 12 0.8
Cherry 1.5 Turbo	(N12)[E15ET]	07.83-12.85	JA158IR#	14 60				
Cube 1.5 DCi	(Z12)[K9K]	03.10-	CA1876IR	14 150		03.10-	CS1332	12 1.4
Cube 1.6 16V	(Z12)[HR16DE]					03.10-	JS1367	12 1.0
Datsun 140 J 1.4	[A14]					01.73-05.77	JS302#	12 0.8
Datsun 160 J 1.6	[L16S] [L16T]					01.73-12.79 AT 01.78-02.82 01.78-02.82	JS302# JS307 JS302#	12 0.8 12 1.0 12 0.8
Datsun 160 J 1.6 i.e.	[L16]					01.78-02.82	JS302#	12 0.8
Interstar 1.9 DCi	[F9Q772]	07.02- AC 07.02-	CA1645IR CA1627IR	14 125 14 125		07.02-	CS1193	12 1.8
Interstar 2.2 DCi	[G9T722]	07.02- 07.02- 07.02-	CA1627IR CA1661IR CA1827IR	14 125 14 125 14 150		07.02-	CS1207	12 2.0
Interstar 2.5 DCi	(X70)[G9U632] [G9U650]	09.06- 09.06- 09.06- 11.03- 11.03- 09.06- 09.06-	CA1627IR CA1827IR CA1877IR CA1627IR CA1645IR CA1827IR CA1877IR	14 125 14 150 14 150 14 125 14 125 14 150 14 150		09.06- 11.03- 09.06-	CS1193 CS1193 CS1207	12 1.8 12 1.8 12 2.0
	[G9U720]	07.02- 07.02-	CA1661IR CA1827IR	14 125 14 150		07.02-	CS1207	12 2.0
	[G9U720]	07.02- 07.02- 07.02-	CA1627IR CA1661IR CA1827IR	14 125 14 125 14 150		07.02-11.03	CS1193	12 1.8
Interstar 2.5 DCi 100	(X70)[G9U650]	04.06- 04.06- 04.06- 04.06-	CA1627IR CA1645IR CA1645IR CA1627IR	14 125 14 125 14 125 14 125		04.06- 04.06- 04.06-	CS1193 CS1207 CS1193	12 1.8 12 2.0 12 1.8
	[G9U730]	11.03- 11.03- 11.03- 02.04- 02.04-	CA1627IR CA1661IR CA1827IR CA1627IR CA1645IR	14 125 14 125 14 150 14 125 14 125		11.03- 02.04-	CS1193 CS1207	12 1.8 12 2.0
Interstar 2.5 DCi 120	[G9U720]	08.03- 08.03- 08.06- 08.06- 08.06- 08.06-	CA1627IR CA1645IR CA1877IR CA1627IR CA1827IR	14 125 14 125 14 150 14 125 14 150		08.03- 08.06- 08.06-	CS1193 CS1193 CS1193	12 1.8 12 1.8 12 1.8
Interstar 2.5 DCi 150		08.06- 08.06- 08.06-	CA1627IR CA1877IR CA1827IR	14 125 14 150 14 150				



Interstar 3.0 DCi 140	[ZD30]	11.03-	CA1645IR	14	125	11.03-	CS1491*	12	2.5	
		11.03-	CA2081R*	14	120					
		11.03-	CA2082R*	14	135					
Juke 1.5 DCi	[K9K ..]	06.10-	CA1876IR	14	150	06.10-	CS1332	12	1.4	
King Cab 1.6	[FG21][Z16]	01.89-	JA1041R	14	50					
		09.85- 02.98	JA1041R	14	50					
King Cab 2.0	(D21)[Z20]	09.85- 02.98	JA1581R#	14	60					
		01.89-	JA1041R	14	50					
King Cab 2.3 Diesel	(D21)[SD23]	06.85-	JA6621R	14	60					
King Cab 2.4 Diesel	(D21)[Z24]	09.85- 04.92	JA1041R	14	50					
		09.85- 04.92	JA1581R#	14	60					
King Cab 2.4 i 12V	(D21)[KA24E]	04.92- 02.98	JA1363IR#	14	60	04.92- 02.98	JS939	12	1.2	
		04.92- 02.98	JA1406IR	14	70					
King Cab 2.4 i 12V 4WD	(D21)[KA24E]	04.92- 02.98	JA1363IR#	14	60	04.92- 02.98	JS939	12	1.2	
		04.92- 02.98	JA1406IR	14	70					
King Cab 2.4 i 4WD	(D21)[Z24i]	08.88-	JA7541R	14	60					
King Cab 2.7 TD 4WD	(D21)[TD27]	08.87- 03.95	JA6601R	14	50	08.87- 02.98	JS660	12	2.0	
		04.95- 02.98	JA1516IR	14	60					
King Cab 3.0 i V6 4WD	(D21)[VG30E]	09.90- 02.98	JA1122IR	14	70	09.90- 02.98	JS1104	12	1.4	
King Van 2.0	(E24)[Z20]	12.88- 10.93	JA1041R	14	50	A13 11.86- 10.88	JS308#	12	1.2	
King Van 2.3 Diesel	(E24)[TD23]	11.86- 03.89	JA1851R	14	50	11.86- 03.89	JS517	12	2.5	
		02.87- 12.88	JA6781R	14	70					
King Van 2.5 TD	(E24)[TD25]	12.88- 07.94	JA1851R	14	50	12.88- 07.94	JS517	12	2.5	
		12.88- 07.94	JA6781R	14	70					
King Vanette 1.5	(GC22)[A15S]	09.86- 07.95	JA1041R	14	50	09.86- 07.95	JS300	12	0.8	
King Vanette 2.0	(GC22)[Z20S]	09.86- 07.95	JA1581R#	14	60					
		09.86- 04.93	JA1041R	14	50	09.86- 04.93	JS308#	12	1.2	
Kubistar 1.1 X76	(FC0F, FC1A)[D7F764]	08.03-	CA1637IR	14	70	08.03-	CS1385	12	0.85	
		08.03-	CA1637IR	14	70	08.03-	CS1057	12	0.7	
Kubistar 1.1 16V X76	[D4F712]	04.06-	CA1637IR	14	70	04.06-	CS1385	12	0.85	
		04.06-	CA1976IR	14	95					
Kubistar 1.5 DCi X76	(FC07)[K9K700]	08.03-	CA1652IR	14	110	08.05-	CS1332	12	1.4	
		08.03- 01.07	CA1881IR	14	120	08.03-	CS1273	12	1.1	
		04.06-	CA1933IR	14	125					
	[K9K704]	08.03-	CA1652IR	14	110	08.03-	CS1273	12	1.1	
		08.03- 01.07	CA1881IR	14	120	08.03-	CS1332	12	1.4	
		08.03-	CA1933IR	14	125					
	[K9K714]	08.03-	CA1652IR	14	110	08.03-	CS1273	12	1.1	
		08.03- 01.07	CA1881IR	14	120	08.03-	CS1332	12	1.4	
		08.03-	CA1933IR	14	125					
	[K9K716]	08.03-	CA1652IR	14	110	08.03-	CS1273	12	1.1	
		08.03- 01.07	CA1881IR	14	120	08.03-	CS1332	12	1.4	
		08.03-	CA1933IR	14	125					
	(FC08)[K9K702]	08.03-	CA1652IR	14	110	08.03-	CS1273	12	1.1	
		08.03-	CA1881IR	14	120	08.03-	CS1332	12	1.4	
		08.03-	CA1933IR	14	125					
	[K9K710]	08.03-	CA1652IR	14	110	08.03-	CS1273	12	1.1	
		08.03-	CA1881IR	14	120	08.03-	CS1332	12	1.4	
		08.03-	CA1933IR	14	125					
	[K9K718]	08.03-	CA1652IR	14	110	08.03-	CS1273	12	1.1	
		08.03-	CA1881IR	14	120	08.03-	CS1332	12	1.4	
		08.03-	CA1933IR	14	125					
	[K9K722]	08.03-	CA1652IR	14	110	08.03-	CS1273	12	1.1	
		08.03-	CA1881IR	14	120	08.03-	CS1332	12	1.4	
		08.03-	CA1933IR	14	125					
	(FC09)[K9K]	[K9K710]	08.03- 08.05	CA1881IR	14	120	08.03- 08.05	CS1273	12	1.1
			08.05-	CA1652IR	14	110	08.05-	CS1273	12	1.1
	Kubistar 1.6 16V X76	[K4M752]	08.03-	CA1470IR	14	98	08.03-	CS1174	12	0.8
08.03-			CA1484IR	14	75	08.03-	CS1276	12	0.85	
01.81- 01.84			JA1981R	14	60	01.81- 01.84	JS302#	12	0.8	
Laurel 2.0	(C31)[L20A]	01.81- 12.85	JA1971R	14	50					
Laurel 2.4	(C31)[L24]	01.81- 12.85	JA1981R	14	60					
		01.85- 12.87	JA1981R	14	60					
Laurel 2.8 Diesel	(C32)[RD28]	01.85- 12.87	JA1981R	14	60					
		02.87- 12.89	JA1981R	14	60					
Lucino 1.8 Turbo	[SR18DE]	11.95- 01.00	JA1287IR	14	80	11.95- 01.00	JS1156	12	1.4	
Lucino 2.0 GTi	[SR20DE]	11.95- 01.00	JA1287IR	14	80	11.95- 01.00	JS1156	12	1.4	
Maxima 2.0	(A32)[VQ20DE]	10.94- 08.00	JA1357IR	14	100	10.94- 08.00	JS924	12	1.4	
		AC 10.94- 08.98	JA9901R	14	110					
Maxima 3.0	(A32)[VQ30DE]	03.94- 03.99	JA1357IR	14	100	03.94- 03.99	JS924	12	1.4	
		AC 03.94- 03.99	JA9901R	14	110					
Maxima 3.0 i	(A33)[VQ30DE]	04.99- 08.03	JA1357IR	14	100	04.99- 08.03	JS924	12	1.4	
Maxima QX 2.0	(A32)[VQ20DE]	12.88- 06.94	JA7671R	14	90	12.88- 06.94	JS754#	12	1.4	
		02.95- 01.00	JA1357IR	14	100	02.95- 01.00	JS924	12	1.4	
Maxima QX 2.0	(A32)[VQ20DE]	AC 02.95- 01.00	JA9901R	14	110					
		01.00-	JA1357IR	14	100	01.00-	JS924	12	1.4	
Maxima QX 2.5 V6 24V	(A33)[VQ25DE]	01.00-	JA1357IR	14	100	01.00-	JS924	12	1.4	
Maxima QX 3.0	(A32)[VQ30DE]	10.94- 08.02	JA1357IR	14	100	10.94- 01.00	JS924	12	1.4	
Maxima QX 3.0 V6 24V	(A33)[VQ30DE]	AC 10.94- 12.96	JA9901R	14	110					
		01.00- 08.02	JA1357IR	14	100	01.00-	JS924	12	1.4	
Micra 1.0	(K10)[MA10S]	12.82- 12.89	JA1041R	14	50	12.82- 12.89	JS305	12	0.8	
Micra 1.0 16V	(K12)[CG10DE]	12.82- 07.92	JA1041R	14	50	12.82- 07.92	JS305	12	0.8	
		01.03- 05.05	JA1725IR	14	80	01.03- 05.05	JS1307	12	0.7	
Micra 1.0 i 16V	(K11)[CG10DE]	05.05-	CA1963IR	14	80					
		07.00- 02.03	JA1790IR	14	65	07.00- 02.03	JS1305	12	0.7	
Micra 1.0 i 16V	(K11)[CG10DE]	08.92- 05.96	JA8681R	14	65	AT 09.00- 02.03	JS1307	12	0.7	
		11.95- 07.00	JA1176IR	14	70	A13 07.00- 02.03	JS1315	12	1.1	
						AT 08.92- 07.00	JS1016	12	0.9	
						08.92- 07.00	JS305	12	0.8	
Micra 1.2	(K10)[MA12S]	07.86- 07.92	JA6591R	14	50	07.86- 07.92	JS305	12	0.8	
Micra 1.2 16V	(K12)[CR12DE]	01.03- 05.05	JA1725IR	14	80	A32 01.03-	JS1016	12	0.9	
		06.04- 05.06	CA1963IR	14	80	A34 01.03-	JS1307	12	0.7	
Micra 1.3 i 16V	(K11E)[CG13DE]	05.06-	CA1977IR	14	80					
		08.92- 09.00	JA1176IR	14	70	AT 08.92- 09.00	JS1016	12	0.9	
Micra 1.4 16V	(K12)[CR14DE]	08.92- 05.96	JA8681R	14	65	08.92- 09.00	JS305	12	0.8	
		01.03- 05.06	CA1963IR	14	80	01.03-	JS1016	12	0.9	
Micra 1.4 i 16V	(K12E)[CR14DE]	05.06-	CA1977IR	14	80					
		08.05- 05.06	CA1963IR	14	80	08.05-	JS1307	12	0.7	
Micra 1.4 i 16V	(K11)[CGA3DE]	05.06-	CA1977IR	14	80	A13 08.05-	JS1016	12	0.9	
		07.00- 02.03	JA1790IR	14	65	A13 07.00- 02.03	JS1315	12	1.1	
Micra 1.5 DCi	(K12)[K9K]	07.00- 02.03	JA1790IR	14	65	AT 07.00- 02.03	JS1307	12	0.7	
		07.00- 02.03	JA1790IR	14	65	07.00- 02.03	JS1305	12	0.7	
Micra 1.5 DCi	(K12)[K9K]	01.03- 05.05	CA1652IR	14	110	05.05-	CS1332	12	1.4	
		01.03-	CA1876IR	14	150					
		05.05-	CA1762IR	14	110					
		05.05-	CA1881IR	14	120					
		01.03- 05.05	CA1762IR	14	110	01.03- 09.07	CS1273	12	1.1	
		05.05-	CA1881IR	14	120					
[K9K722]	09.03- 05.05	CA1762IR	14	110	09.03- 05.05	CS1273	12	1.1		



**NISSAN** *Continued*

		05.05-	CA1881R	14 120						
Micra 1.5 Diesel	(K11)(TD15)	02.98- 02.03	CA1038IR	14 70			02.98- 10.02	CS542	12 1.4	
Micra 1.6 160 SR	(K12)(HR16DE)	05.05- 09.07	CA1957IR	14 120			05.05-	JS1367	12 1.0	
	(HR16DE)	08.05-	CA1957IR	14 120			08.05-	JS1367	12 1.0	
Murano 3.5 4WD	[VQ35DE]	03.05-	JA990IR	14 110						
Navara 2.5 DCi	(D40)(YD25DDTi)	07.05-	CA1946IR	14 150			07.05-	CS1424	12 2.0	
		07.05-	CA2085IR*	14 130						
Navara 2.5 DCi 4WD	(D40)(YD25DDTi)	10.06-	CA1946IR	14 150			10.06-	CS1424	12 2.0	
		10.06-	CA2085IR*	14 130						
	[YD25DDTi]	07.05-	CA1946IR	14 150			07.05-	CS1424	12 2.0	
		07.05-	CA2085IR*	14 130						
Note 1.4	(E11)(CR14DE)	01.06- 05.06	CA1963IR	14 80			03.06-	JS1307	12 0.7	
		05.06-	CA1977IR	14 80			A13 03.06-	JS1016	12 0.9	
Note 1.5 DCi	(E11)	07.08-	CA1876IR	14 150			07.08-	CS1332	12 1.4	
	[K9K276]	12.07-	CA1876IR	14 150			03.06-	CS1332	12 1.4	
	[K9K700]	12.07-	CA1876IR	14 150			03.06-	CS1332	12 1.4	
Note 1.6	[HR16DE]	03.06-	CA1957IR	14 120			03.06-	JS1367	12 1.0	
NP300 2.5 DCi 4x4	[YD25DDTi]	04.08-	CA1983IR	14 90			04.08-	CS1439	12 2.2	
NV 200 1.5 DCi		04.11-	CA1762IR	14 110			04.11-	CS1332	12 1.4	
NV 200 Evalia 1.5 DCi		04.11-	CA1762IR	14 110			04.11-	CS1332	12 1.4	
	(M20)(K9K)	02.10-	CA1876IR	14 150			02.10-	CS1332	12 1.4	
		02.10-	CA1876IR	14 150			02.10-	CS1332	12 1.4	
		02.10-	CA1762IR	14 110 ▲						
NV200 1.6 16V	(M20)(HR16DE)	02.10-	CA1957IR	14 120			02.10-	JS1367	12 1.0	
		07.10-	CA1957IR	14 120			07.10-	JS1367	12 1.0	
Pathfinder 2.5 DCi 4WD	(R51)(YD25DDTi)	03.05-	CA1946IR	14 150			03.05-	CS1424	12 2.0	
		03.05-	CA2085IR*	14 130						
Pathfinder 2.7 TD 4WD	[TD27ETi]						09.97- 12.04	JS1214	12 1.9	
Patrol 2.8	(160)(L28)	07.80- 08.88	JA198IR	14 60						
	(260)(L28)	07.85- 03.89	JA754IR	14 60						
Patrol 2.8 TD	(260)(RD28T)	04.89- 11.92	JA867IR	14 70	BO		06.89- 11.95	JS650	12 2.0	HI
		06.89- 11.95	JA677IR	14 70			02.90- 11.95	JS936	12 2.2	BO
		12.92- 11.95	JA1421R	14 70	BO					
	(Y60)(RD28T)	09.88- 08.95	JA677IR	14 70			09.88- 09.97	JS650	12 2.0	
	[RD28T]	05.86- 06.90	JA677IR	14 70			05.86- 06.90	JS650	12 2.0	
		04.89- 06.90	JA867IR	14 70	BO					
	[RD28Ti]	10.97- 02.00	JA1594IR	14 100			10.97- 02.00	JS650	12 2.0	
Patrol 3.0	(260)(RB30S)	04.89- 05.98	JA754IR	14 60						
Patrol 3.2 Diesel	(W260)(SD33T)	08.88- 06.90	JA672IR	28 35			08.88- 06.90	JS540	24 3.5	
	[SD33T]	08.88- 06.90	JA672IR	28 35			08.88- 06.90	JS540	24 3.5	
Patrol 3.2 TD	(160)(SD33T)	07.83- 08.88	JA1871R#	28 25			04.83- 06.85	JS399#	24 3.2	
		07.83- 08.88	JA672IR	28 35			06.85- 08.88	JS540	24 3.5	
Patrol 3.3 Diesel	(160)(SD33)	11.79- 08.88	JA1871R#	28 25			11.79- 05.86	JS399#	24 3.2	
							06.85- 08.88	JS540	24 3.5	
Patrol GR 2.8 TD	(Y60)(RD28T)	10.95- 02.98	JA677IR	14 70			10.95- 02.98	JS650	12 2.0	
Patrol GR 2.8 TDIC	(Y61)(RD28Ti)	10.97- 02.00	JA1594IR	14 100			10.97- 02.00	JS650	12 2.0	
Patrol GR 3.0 DTi	(Y61)(ZD30DDTi)	05.00- 02.05	JA1602IR	14 90						
Pick Up 1.8	(720)(L18)	01.83- 03.86	JA1041R	14 50			01.83- 03.86	JS307	12 1.0	
		09.85- 04.92	JA1041R	14 50			09.85- 04.92	JS307	12 1.0	
Pick Up 2.0	(D21)(Z20)	09.85- 04.92	JA1041R	14 50			04.83- 03.86	JS307	12 1.0	
Pick Up 2.2 4WD	(720)(Z22)	04.83- 03.86	JA1041R	14 50			04.83- 03.86	JS379	12 1.8	
	(720)(SD23)									
Pick Up 2.4 Diesel	(D21)(SD23)	09.85- 08.88	JA662IR	14 60						
	(D21)(Z24)	09.85- 04.92	JA1041R	14 50			09.85- 04.92	JS308#	12 1.2	
		08.88- 04.92	JA754IR	14 60						
Pick Up 2.4 i	(D21)(KA24E)	04.92- 05.94	JA1363IR#	14 60			04.92- 02.98	JS939	12 1.2	
	(D22)(KA24E)						02.98-	JS1219	12 1.4	
Pick Up 2.4 i 4WD	(D22)(KA24DE)						03.02-	JS1219	12 1.4	
	[KA24E]						02.98- 11.01	JS1219	12 1.4	
Pick Up 2.5 Diesel	(D21)(TD25)	08.87- 02.98	JA780IR	14 60			08.87- 02.98	JS660	12 2.0	
	(D22)(TD25)	02.98- 11.01	JA1516IR	14 60			02.98- 11.01	JS660	12 2.0	
Pick Up 2.5 Diesel 4WD	(720)(SD25)						04.83- 03.86	JS359	12 1.8	
	(D21)(SD25)	09.85- 08.91	JA662IR	14 60			10.87- 08.91	JS660	12 2.0	
							09.85- 10.87	JS522	12 2.0	
	[TD25]	08.87- 03.96	JA660IR	14 50			10.87- 10.88	JS517	12 2.5	
		08.87- 02.98	JA780IR	14 60			10.87- 02.98	JS660	12 2.0	
	(D22)(TD25)	02.98- 11.01	JA1516IR	14 60			02.98- 11.01	JS660	12 2.0	
Pick Up 2.5 TD	(D22)(YD25DDTi)	03.02-	CA1983IR	14 90			03.02- 02.07	CS1439	12 2.2	
Pick Up 2.5 TD 4WD	(D22)(TD25Ti)	05.98- 11.01	JA1516IR	14 60			05.98- 11.01	JS660	12 2.0	
	[YD25DDTi]	03.02-	CA1983IR	14 90			03.02- 02.07	CS1439	12 2.2	
Pick Up 2.7 Diesel 4WD	(D41)(TD27)	09.87- 08.91	JA780IR	14 60			09.87- 08.91	JS660	12 2.0	
Pick-Up 2.2 Diesel 4WD	(720)(SD22)						01.82- 09.84	JS359	12 1.8	
Prairie 1.5 S	(M10)(E15S)	01.84- 12.87	JA1041R	14 50			01.83- 09.88	JS305	12 0.8	
Prairie 1.8	(M10)(CA18S)	07.83- 10.87	JA1071R	14 60						
Prairie 2.0 4WD	(M10)(CA20S)	06.86- 09.88	JA1071R	14 60 ▲						
Prairie 2.0 i 4WD	(M11)(CA20E)	10.88- 12.92	JA1661R	14 70						
Prairie 2.0 i PRO	(M11)(CA20E)	10.88- 04.92	JA1661R	14 70			10.88- 04.92	JS911#	12 1.4	
Prairie 2.4 i 4WD	[KA24E]						04.92- 07.94	JS937	12 1.4	
Prairie 2.4 i PRO	(M11)(KA24E)						04.92- 07.94	JS937	12 1.4	
Primastar 1.9 DCi	[F9Q760]	03.01- AC 03.01-	CA1645IR	14 125			03.01-	CS1193	12 1.8	
		03.01-	CA1627IR	14 125						
	[F9Q762]	03.01- AC 03.01-	CA1645IR	14 125			07.02-	CS1193	12 1.8	
			03.01-	CA1627IR	14 125					
Primastar 2.0	[F4R720]	03.01- 12.02	CA1661IR	14 125			07.02-	CS1255	12 0.9	
		03.01-	CA1829IR	14 100						
		01.03-	CA1824IR	14 150						
	[F4R722]	03.01- 12.02	CA1661IR	14 125			03.01-	CS1255	12 0.9	
		03.01-	CA1829IR	14 100						
	01.03-	CA1824IR	14 150							
Primastar 2.0 DCi	(X83)(M9RE7)	09.06-	CA1959IR	14 150			09.06-	CS1415	12 2.2	
Primastar 2.5 DCi	(X83)(G9U630)	09.06-	CA1827IR	14 150			09.06-	CS1207	12 2.0	
	[G9U730]	09.03-	CA1627IR	14 125			09.03-	CS1207	12 2.0	
		09.03-	CA1661IR	14 125						
Primera 1.6	(P10)(GA16DE)	06.93- 01.96	JA756IR	14 67			06.93- 01.96	JS672	12 1.0	
							A13 06.93- 01.96	JS766	12 1.2	
	[GA16DS]	06.90- 06.96	JA756IR	14 67			06.90- 06.96	JS672	12 1.0	
							A13 06.90- 06.96	JS766	12 1.2	
	(P12)(QG16DE)	01.02-	JA1607IR	14 80			A13 01.02-	JS1100	12 1.2	
		AC 03.02-	JA1607IR	14 80			01.02-	JS1226	12 0.7	
	[GA16DE]	06.93- 01.96	JA756IR	14 67			06.93- 01.96	JS672	12 1.0	
						A13 06.93- 01.96	JS766	12 1.2		
	[GA16DS]	06.90- 06.93	JA756IR	14 67			06.90- 06.93	JS672	12 1.0	
Primera 1.6 Visia	(WP12)(QG16DE)	01.02-	JA1607IR	14 80			01.02-	JS1100	12 1.2	
Primera 1.6 16V	(P11)(GA16DE)	06.96- 12.01	JA1174IR	14 80			06.96- 12.01	JS1142	12 0.9	
							06.96- 12.01	JS1142	12 0.9	
	[QG16DE]	09.00- 12.01	JA1607IR	14 80			09.00- 12.01	JS1226	12 0.7	
						A13 09.00- 12.01	JS1100	12 1.2		
Primera 1.6 i	(W10)(GA16DS)	07.90- 07.94	JA974IR	14 65			01.95- 12.97	JS1100	12 1.2	
		07.94- 12.97	JA1182IR	14 70			07.90- 01.95	JS766	12 1.2	
							07.90- 04.93	JS672	12 1.0	



Primera 1.8	(P12)[QG18DE]	07.02- AC 03.02-	JA1607IR	14 80	A13 03.02-	JS1100	12 1.2
	(WP12)[QG18DE]		JA1607IR	14 80	03.02-	JS1226	12 0.7
Primera 1.8 16V	(P11)[QG18DE]	08.99- 12.01	JA1607IR	14 80	A13 03.02-	JS1226	12 0.7
	(WP11)[QG18DD]	06.96- 05.99	JA1607IR	14 80	06.99- 12.01	JS1100	12 1.2
Primera 1.9 DCi	(P12)[F9Q]	04.03-	CA1814IR	14 125	04.03-	CS1193	12 1.8
	(WP12)[F9Q]	04.03-	CA1814IR	14 125	04.03-	CS1193	12 1.8
Primera 2.0	(P10)[SR20DE]	06.90- 06.96	JA6651R	14 80	06.90- 06.96	JS627	12 1.4
	[SR20DI]	06.90- 01.96	JA6651R	14 80	06.90- 01.96	JS627	12 1.4
	(P12)[QR20DE]	12.01-	JA1712IR	14 110	GSP 12.01-	JS1318	12 1.4
	(W10)[SR20DI]	07.90- 07.94	JA7621R	14 80	04.96- 03.98	JS1137	12 1.4
		07.94- 01.98	JA1287IR	14 80	07.90- 04.96	JS627	12 1.4
	(WP12)[QR20DE]	12.01-	JA1712IR	14 110	GSP 12.01-	JS1318	12 1.4
Primera 2.0 GT	[SR20DE]	01.95- 06.96	JA6651R	14 80	01.95- 06.96	JS627	12 1.4
	(P10)[SR20DE]	06.90- 01.96	JA6651R	14 80	06.90- 01.96	JS627	12 1.4
Primera 2.0 16V	(P11)[SR20DE]	06.96- 06.99	JA1175IR	14 80	AT 04.98- 07.02	JS1225	12 1.7
		06.99- 07.02	JA1287IR	14 80	A34 06.96- 07.02	JS1156	12 1.4
		06.99- 07.02	JA1606IR	14 90			
	(WP11)[SR20VE]	AC 06.96- 12.01	JA1287IR	14 80	06.96- 05.99	JS1156	12 1.4
Primera 2.0 16V 4WD	(P10)[SR20DI]	04.91- 05.93	JA6651R	14 80	04.91- 06.96	JS627	12 1.4
	(P10)[SR20DE]	09.94- 06.96	JA6651R	14 80	09.94- 06.96	JS627	12 1.4
Primera 2.0 Diesel	(P10)[CD20]	01.91- 01.96	JA7691R	14 70	A13 01.91- 01.96	JS1001	12 2.2
	(W10)[CD20]	07.90- 12.95	JA7691R	14 70	01.91- 01.96	JS539	12 2.0
	[CD20]	01.91- 01.96	JA7691R	14 70	A13 07.90- 12.95	JS1001	12 2.2
					01.91- 01.96	JS539	12 2.0
Primera 2.0 TD	(P11)[CD20T]	09.96- 07.02	JA1528IR	14 90	A13 01.91- 01.96	JS1001	12 2.2
					09.96- 12.01	JS539	12 2.0
Primera 2.2 DCi	(P12)[YD2DDT]	01.03-	JA1806IR	14 110	A15 09.96- 12.01	JS1001	12 2.2
	(WP12)[YD2DDT]	01.03-	JA1806IR	14 110	01.03-	JS1295	12 1.7
Primera 2.2 Diesel Di	(P12)[YD2DDT]	03.02-	JA1806IR	14 110	03.02-	JS1295	12 1.7
	(WP12)[YD2DDT]	03.02-	JA1806IR	14 110	03.02-	JS1295	12 1.7
Qashqai 1.5 DCi	(J10)	07.08-	CA1876IR	14 150	07.08-	CS1332	12 1.4
	(J10, J110)				11.10-	CS1332	12 1.4
	[K9K]	02.07-	CA1876IR	14 150	02.07-	CS1332	12 1.4
Qashqai 1.6	(J10, J110)[HR16DE]				11.10-	JS1367	12 1.0
	[HR16DE]	02.07-	CA1957IR	14 120	02.07-	JS1367	12 1.0
Qashqai 2.0	[MR20DE]				12.06-	CS1418*	12 1.0
Qashqai 2.0 4WD	[MR20DE]				12.06-	CS1418*	12 1.0
Qashqai 2.0 DCi	[M9R]	02.07-	CA1979IR	14 150	02.07-	CS1415	12 2.2
Qashqai 2.0 DCi 4WD	[M9R]	02.07-	CA1979IR	14 150	02.07-	CS1415	12 2.2
Serena 1.6 16V	(C23M)[GA16DE]	07.92- 11.01	JA1374IR	14 80	07.92- 11.01	JS1094	12 1.4
Serena 2.0 16V	(C23M)[SR20DE]	07.92- 11.01	JA9751R	14 90	07.92- 11.01	JS890	12 1.4
Serena 2.0 Diesel	(C23M)[LD20]	11.92- 09.94	JA1162IR	14 90	11.92- 09.94	JS568	12 2.2
Serena 2.3 Diesel	(C23M)[LD23]	09.94- 06.96	JA1162IR	14 90	09.94- 11.01	JS568	12 2.2
Silvia 1.8 i	(S12)[CA18ET]				04.84- 05.88	JS378	12 1.0
	(S12)[FJ20E]	10.83- 09.88	JA1581R#	14 60			
Stanza 1.6	(T11)[CA16S]	08.81- 12.85	JA1071R	14 60			
Stanza 1.8	(T11)[CA18]	08.81- 12.85	JA1071R	14 60			
	[CA18S]	08.81- 12.85	JA1071R	14 60			
Stanza 1.8 SGL	(T11)[CA18S]	03.83- 12.85	JA1071R	14 60			
Sunny 1.0	(N13)[E10S]	06.86- 09.90	JA1631R	14 60	06.86- 09.90	JS305	12 0.8
Sunny 1.3	(B11)[E13]	03.82- 08.90	JA1041R	14 50	03.82- 09.87	JS305	12 0.8
	(N13)[E13S]	06.86- 10.91	JA1631R	14 60	06.86- 10.91	JS305	12 0.8
Sunny 1.4	(B310)[A14]	01.70- 05.78	JA100	14 35	AT 10.77- 02.82	JS755#	12 1.0
					01.70- 02.82	JS300	12 0.8
	(N13)[GA14S]	10.88- 08.91	JA6531R	14 65	01.89- 08.91	JS300	12 0.8
Sunny 1.4 LX	(N13)[GA14S]	10.88- 08.91	JA6531R	14 65	AT 01.89- 08.91	JS755#	12 1.0
Sunny 1.4 16V	[GA14DE]	10.90- 05.95	JA9741R	14 65	10.90- 05.95	JS759	12 0.8
Sunny 1.4 i 16V					AT 10.90- 05.95	JS766	12 1.2
	(N14)[GA14DE]	10.92- 06.95	JA9741R	14 65	10.92- 06.95	JS766	12 1.2
Sunny 1.4 i					AT 10.92- 05.95	JS766	12 1.2
	(N14)[GA14DE]	10.90- 05.95	JA9741R	14 65	10.92- 05.95	JS759	12 0.8
	[GA14DS]	10.90- 05.95	JA9741R	14 65	10.90- 02.91	JS520	12 1.2
Sunny 1.5					AT 10.90- 05.95	JS766	12 1.2
	(B11)[E15S]	03.82- 10.86	JA1041R	14 50	10.90- 05.95	JS759	12 0.8
	(B12)[E15S]	03.82- 10.86	JA1581R#	14 60	03.82- 10.86	JS305	12 0.8
	(B310)[A15]	06.86- 10.88	JA1631R	14 60	06.86- 10.88	JS305	12 0.8
Sunny 1.6					06.79- 02.82	JS300	12 0.8
	(N13)[E15S]	06.86- 10.88	JA1631R	14 60	06.79- 02.82	JS755#	12 1.0
	(B12)[E16S]	06.86- 10.88	JA1631R	14 60	06.86- 10.88	JS305	12 0.8
Sunny 1.6 16V					06.86- 10.88	JS305	12 0.8
	(N13)[E16S]	06.86- 10.88	JA1631R	14 60	06.86- 10.88	JS305	12 0.8
	(Y10)[GA16DS]	10.90- 03.94	JA9741R	14 65	06.86- 10.88	JS520	12 1.2
Sunny 1.6 GTi 16V					AT 10.90- 05.95	JS766	12 1.2
	(Y10)[GA16DS]	03.94- 05.95	JA1182IR	14 70	10.90- 02.91	JS520	12 1.2
Sunny 1.6 i 12V	(B12)[CA16D]	05.87- 05.89	JA1661R	14 70			
	(N13)[CA16D]	02.87- 05.89	JA1661R	14 70			
Sunny 1.6 i 12V 4WD	(N13)[GA16i]	10.88- 10.90	JA6531R	14 65	06.86- 10.90	JS520	12 1.2
Sunny 1.6 i 16V	(B12)[GA16i]	10.88- 08.91	JA1631R	14 60	10.88- 08.90	JS766	12 1.2
	(10)[GA16DE]	10.92- 03.94	JA9741R	14 65	AT 10.92- 03.00	JS766	12 1.2
		03.94- 03.00	JA1182IR	14 70	10.92- 03.00	JS759	12 0.8
	(N14)[GA16DE]	10.92- 05.95	JA9741R	14 65	AT 10.92- 05.95	JS766	12 1.2
Sunny 1.6 i 16V 4WD					10.92- 05.95	JS759	12 0.8
	(Y10L)[GA16DE]	10.92- 03.94	JA9741R	14 65	AT 10.92- 03.00	JS766	12 1.2
		03.94- 03.00	JA1182IR	14 70	10.92- 03.00	JS759	12 0.8
Sunny 1.6 i 16V 4WD	(N14)[GA16DE]	10.92- 05.95	JA9741R	14 65	10.92- 05.95	JS766	12 1.2
	[GA16DS]	10.90- 10.92	JA9741R	14 65	10.90- 10.92	JS766	12 1.2
Sunny 1.6 i	(B12)[E16i]	06.86- 05.89	JA1631R	14 60	06.86- 10.88	JS305	12 0.8
					06.86- 05.89	JS520	12 1.2
	[GA16i]	10.88- 06.91	JA6531R	14 65	10.88- 06.91	JS520	12 1.2
	(N13)[E16i]	06.86- 10.90	JA1631R	14 60	06.86- 10.90	JS520	12 1.2
Sunny 1.6 i					06.86- 10.90	JS305	12 0.8
	[GA16i]	10.88- 06.91	JA6531R	14 65	06.86- 10.90	JS305	12 0.8
	(N14)[GA16DE]	10.92- 05.95	JA9741R	14 65	AT 10.92- 05.95	JS766	12 1.2
					10.92- 05.95	JS759	12 0.8
	[GA16DE]	10.90- 05.95	JA9741R	14 65	AT 10.90- 05.95	JS766	12 1.2
					10.92- 05.95	JS759	12 0.8
	[GA16DE]	10.90- 05.95	JA9741R	14 65	AT 10.90- 05.95	JS766	12 1.2



NISSAN Continued

	[GA16DS]	10.90- 05.95	JA974IR	14 65		AT 10.90- 05.95 JS766	12 1.2	
						10.90- 02.91 JS520	12 1.2	
						10.90- 05.95 JS759	12 0.8	
	(Y10)[GA16DE]	10.92- 03.94	JA974IR	14 65		AT 10.92- 03.00 JS766	12 1.2	
		03.94- 03.00	JA1182IR	14 70		10.92- 03.00 JS759	12 0.8	
						10.92- 03.00 JS1301	12 1.2	
	[GA16DS]	10.90- 10.92	JA974IR	14 65		10.90- 10.92 JS520	12 1.2	
						AT 10.90- 10.92 JS766	12 1.2	
						10.90- 10.92 JS759	12 0.8	
Sunny 1.6 i 4WD	(B12A)[E16i]	06.86- 05.89	JA104IR	14 50				
	(N13A)[E16i]	06.86- 10.90	JA163IR	14 60				
Sunny 1.7 Diesel	(B12)[CD17]					01.86- 06.91 JS539	12 2.0	
	(N13)[CD17]					06.86- 01.91 JS539	12 2.0	
	(Y10)[CD17]					11.90- 03.00 JS539	12 2.0	
Sunny 1.8 GTi 16V	(B12)[CA18D]	01.89- 06.91	JA166IR	14 70				
	(N13)[CA18D]	01.89- 06.91	JA166IR	14 70				
Sunny 2.0 GTi 16V	(N14)[SR20DE]	10.90- 05.95	JA762IR	14 80		10.90- 05.95 JS627	12 1.4	
Sunny 2.0 i 16V	(N14)[SR20DE]	10.90- 05.95	JA762IR	14 80		10.90- 05.95 JS627	12 1.4	
Sunny 2.0 i Turbo	(N14)[SR20DET]	10.90- 05.95	JA762IR	14 80				
Sunny 2.0 Diesel	(N14)[CD20]	10.90- 05.95	JA769IR	14 70		A15 10.90- 05.95 JS1001	12 2.2	
						10.90- 05.95 JS539	12 2.0	
	(Y10)[CD20]	06.91- 03.00	JA769IR	14 70		06.91- 03.00 JS539	12 2.0	
						A15 06.91- 03.00 JS1001	12 2.2	
Terrano 2.4	(WD21)[Z24i]	07.86- 10.95	JA754IR	14 60				
Terrano 2.4 4WD	(R20)[KA24E]	05.96- 09.99	JA991IR	14 65		05.96- 09.99 JS1219	12 1.4	
		A15 05.96- 09.99	JA1406IR	14 70				
Terrano 2.4 i 12V	(R20)[KA24E]	02.93- 10.99	JA991IR	14 65		02.93- 05.96 JS939	12 1.2	
		A15 02.93- 10.99	JA1406IR	14 70		05.96- 10.99 JS1219	12 1.4	
Terrano 2.4 i	(WD21)[Z24i]	08.87- 07.92	JA754IR	14 60				
Terrano 2.7 TD	(R20)[TD27T]	02.93- 01.02	JA1117IR	14 60	BO	05.96- 01.02 JS517	12 2.5 HI	
		02.93- 05.96	JA678IR	14 70		05.96- 01.02 JS660	12 2.0 HI	
		02.93- 01.02	JA780IR	14 60	HI	02.93- 05.96 JS1214	12 1.9 BO	
		05.96- 01.02	JA1364IR	14 70				
	(WD21)[TD27T]	02.89- 10.93	JA660IR	14 50		02.89- 10.93 JS660	12 2.0	
		02.89- 10.93	JA780IR	14 60		02.89- 10.93 JS517	12 2.5	
Terrano 2.7 TDi 4WD	(R20)[TD27T]	05.96-	JA1364IR	14 70		05.96- 03.99 JS1214	12 1.9 BO	
						06.98- 12.06 JS660	12 2.0 HI	
						06.98-	JS1159	
		AT 05.96-	CA2079IR*	14 70		07.86- 08.89 JS1104	12 1.4	
Terrano 3.0 4x4	(WD21)[VG30i]	07.86- 08.89	JA1122IR	14 70		08.90- 12.95 JS1104	12 1.4	
Terrano 3.0 i	(WD21)[VG30E]	01.90- 12.95	JA1122IR	14 70		08.90- 12.95 JS1104	12 1.4	
Terrano 3.0 Diesel Di 4WD	[ZD30]	02.02-	JA1602IR	14 90		05.02-	CS1491*	
						09.07-	CS1332	
Tiida 1.5 DCi	(C11X)					09.07-	CS1332	
	(SC11X)					09.07-	CS1367	
Tiida 1.6	(C11X)[HR16DE]					09.07-	JS1367	
	(SC11X)[HR16DE]					09.07-	JS1367	
Tiida 1.8	(C11X)[MR18DE]					09.07-	CS1418*	
	(SC11X)[MR18DE]					09.07-	CS1418*	
Trade 3.0	[BD-30Ti]	01.96- 12.98	JA1603IR	14 70				
Trade 3.0 Diesel	[BD-30i]	04.93- 12.98	JA1527IR	14 55		04.93- 12.98 JS1159	12 2.2	
Trade 3.0 TDiC	[BD-30Ti]	06.96- 10.01	JA1527IR	14 55		06.96- 10.01 JS1159	12 2.2	
		06.96- 10.01	JA1603IR	14 70				
Urvan 2.0	(E23)[H20]	07.81- 11.82	JA104IR	14 50		07.81- 11.82 JS329	12 0.8	
	[Z20]	12.82- 11.88	JA104IR	14 50		12.82- 11.88 JS308#	12 1.2	
	(E24)[Z20]	05.87- 05.97	JA104IR	14 50				
	[Z20S]	01.92- 09.93	JA104IR	14 50				
		01.92- 09.93	JA158IR#	14 60				
Urvan 2.2 Diesel	(E23)[SD22]					07.80- 04.82 JS359	12 1.8	
Urvan 2.3 Diesel	(E23)[SD23]					11.82- 11.88 JS359	12 1.8	
						11.82- 02.85 JS379	12 1.8	
	(E24)[TD23]	02.87- 05.97	JA185IR	14 50		11.86- 05.97 JS517	12 2.5	
		02.87- 05.97	JA678IR	14 70				
Urvan 2.4	(E24)[Z24S]	11.86- 06.97	JA158IR#	14 60		11.86- 06.97 JS307	12 1.0	
	(V2_) [KA24DE]					05.01-	JS1219	
Urvan 2.5 Diesel	(E24)[TD25]	12.88- 05.97	JA185IR	14 50		12.88- 05.97 JS517	12 2.5	
		12.88- 05.97	JA678IR	14 70				
	(E24L)[TD25]	12.88- 09.93	JA185IR	14 50		12.88- 09.93 JS517	12 2.5	
		12.88- 09.93	JA678IR	14 70				
Urvan 3.0 Di	(V2_) [ZD30DD]					10.00-	JS660	
						05.02-	JS660	
Vanette 1.5	(C22)[A15S]	10.86- 12.95	JA104IR	14 50		10.86- 12.95 JS300	12 0.8	
		10.86- 12.95	JA158IR#	14 60				
	(KC120)[A15]	01.83- 12.87	JA104IR	14 50		05.84- 12.87 JS300	12 0.8	
Vanette 1.6 Cargo	(HC 23)[GA16DE]	09.94- 05.01	JA1374IR	14 80		09.94- 05.01 JS1094	12 1.4	
		09.94- 05.01	JA1525IR	14 90				
Vanette 2.0 Diesel	(C22)[LD20-II]	12.87- 11.94	JA757IR	14 55		12.87- 11.94 JS568	12 2.2	
Vanette Cargo 1.6 i	(C23M)[GA16DE]	07.92- 11.01	JA1374IR	14 80		07.92- 11.01 JS1094	12 1.4	
Vanette Cargo 2.0 Diesel	(C23M)[LD20]	07.92- 09.94	JA1162IR	14 90		07.92- 09.94 JS568	12 2.2	
Vanette Cargo 2.3 Diesel	(C23M)[LD23]	09.94- 11.01	JA1162IR	14 90		09.94- 11.01 JS568	12 2.2	
X-Trail 2.0	(T30)[QR20DE]	11.01-	JA1712IR	14 110		11.01-	JS1318	
	(T31)[MR20DE]					06.07-	CS1418*	
X-Trail 2.0 4WD	(T30)[QR20DE]	07.01-	JA1712IR	14 110		07.01-	JS1318	
						AT 07.01-	JS1306	
X-Trail 2.0 DCi	(T31)[M9R]	06.07-	CA1979IR	14 150		06.07-	CS1415	
	[M9R760]	06.07-	CA1979IR	14 150		06.07-	CS1415	
X-Trail 2.2 DCi	(T30)[YD22DDT]	12.03-	JA1615IR	14 90		12.03-	JS1295	
X-Trail 2.2 DCi 4WD	(T30)[YD22DDT]	12.03-	JA1615IR	14 90		12.03-	JS1295	
X-Trail 2.2 Di 4WD	(T30)[YD22DDT]	07.01-	JA1615IR	14 90		07.01-	JS1295	
	[YD22ET]	07.01-	JA1615IR	14 90		07.01-	JS1295	
X-Trail 2.5	(T31)[QR25DE]	06.07-	JA1712IR	14 110		AT 06.07-	JS1306	
						06.07-	JS1318	
X-Trail 2.5 4WD	[QR25DE]	09.02-	JA1712IR	14 110		09.02-	JS1318	
						09.02-	JS1306	
<b>PASSENGER CARS US</b>								
210 1.2	[A12]	01.79- 01.82	JA125IR	14 60		01.79- 01.82 JS755#	12 1.0	
210 1.4	[A14]	01.79- 01.79	JA125IR	14 60		01.79- 01.79 JS755#	12 1.0	
210 1.4 Deluxe	[A14]	01.80- 01.80	JA125IR	14 60		01.80- 01.80 JS755#	12 1.0	
210 1.5 Deluxe	[A15]	01.80- 01.82	JA125IR	14 60		01.80- 01.82 JS755#	12 1.0	
310 1.4	[A14]	01.79- 01.80	JA125IR	14 60		01.79- 01.80 JS755#	12 1.0	
310 1.4 GX	[A14]	01.80- 01.80	JA125IR	14 60		01.80- 01.80 JS755#	12 1.0	
310 1.5	[A15]	01.81- 01.81	JA125IR	14 60		01.81- 01.81 JS755#	12 1.0	
310 1.5 Deluxe	[E15]	01.82- 01.82	JA125IR	14 60		01.82- 01.82 JS305	12 0.8	
310 1.5 GX	[A15]	01.81- 01.81	JA125IR	14 60		01.81- 01.81 JS755#	12 1.0	
	[E15]	01.82- 01.82	JA125IR	14 60		01.82- 01.82 JS305	12 0.8	
410 1.2	[E11]					01.63- 01.65 JS755#	12 1.0	
510 1.6	[L16]					01.68- 01.73 JS302#	12 0.8	
510 2.0	[L20B]	01.78- 01.79	JA104IR	14 50		01.78- 01.79 JS307	12 1.0	
		01.78- 01.79	JA125IR	14 60				
	[Z20S]	01.80- 01.81	JA104IR	14 50		01.80- 01.81 JS307	12 1.0	
		01.80- 01.81	JA125IR	14 60				
520 1.3	[J13]					01.65- 01.68 JS755#	12 1.0	
521 1.3	[J13]					01.69- 01.69 JS755#	12 1.0	
521 1.6	[L16]					01.70- 01.72 JS302#	12 0.8	





610 1.8	[L18]				01.73- 01.73	JS302#	12 0.8
					01.73- 01.73	JS307	12 1.0
610 2.0	[L20B]				01.74- 01.76	JS302#	12 0.8
					01.74- 01.76	JS307	12 1.0
620 1.6	[L16]				01.72- 01.73	JS302#	12 0.8
620 1.8	[L18]				01.74- 01.74	JS302#	12 0.8
					01.74- 01.74	JS307	12 1.0
620 2.0	[L20B]				01.75- 01.79	JS302#	12 0.8
					01.75- 01.79	JS307	12 1.0
710 1.8	[L18]				01.74- 01.74	JS302#	12 0.8
					01.74- 01.74	JS307	12 1.0
710 2.0	[L20B]				01.75- 01.77	JS302#	12 0.8
					01.75- 01.77	JS307	12 1.0
720 2.0	[L20B]				01.80- 01.80	JS302#	12 0.8
					01.80- 01.80	JS307	12 1.0
	[Z20]	01.83- 01.85	JA1041R	14 50			
		01.83- 01.85	JA1251R	14 60			
720 2.2	[Z22]	01.81- 01.82	JA1041R	14 50	01.81- 01.82	JS307	12 1.0
		01.81- 01.82	JA1251R	14 60			
720 2.2	[SD22]				01.81- 01.82	JS359	12 1.8
720 2.4	[Z24]	01.83- 01.85	JA1041R	14 50	01.83- 01.85	JS307	12 1.0
		01.83- 01.85	JA1251R	14 60			
	[Z24i]				01.86- 01.86	JS307	12 1.0
	[SD25]				01.83- 01.86	JS359	12 1.8
810 2.4	[L24E]				01.77- 01.77	JS307	12 1.0
200SX 1.6	[GA16DE]				01.95- 01.98	JS759	12 0.8
					01.95- 01.98	JS766	12 1.2
200SX 1.6 SE	[GA16DE]				01.95- 01.98	JS759	12 0.8
					01.95- 01.98	JS766	12 1.2
200SX 2.0	[CA20E]	01.84- 01.86	JA1071R	14 60			
	[L20B]				01.77- 01.79	JS302#	12 0.8
					01.77- 01.79	JS307	12 1.0
	[SR20DE]	01.95- 01.98	JA12871R	14 80	01.95- 01.95	JS627	12 1.4
					01.95- 01.95	JS627	12 1.4
					01.98- 01.98	JS1137	12 1.4
	[Z20E]	01.80- 01.81	JA1041R	14 50	01.80- 01.81	JS307	12 1.0
200SX 2.0 SE-R	[SR20DE]	01.96- 01.98	JA12871R	14 80	01.98- 01.98	JS1137	12 1.4
					01.96- 01.97	JS627	12 1.4
200SX 2.2	[Z22E]	01.82- 01.83	JA1041R	14 50	01.82- 01.83	JS307	12 1.0
240SX 2.4	[KA24DE]				01.91- 01.98	JS937	12 1.4
	[KA24E]				01.89- 01.90	JS937	12 1.4
240SX 2.4 LE	[KA24DE]				01.91- 01.97	JS937	12 1.4
240SX 2.4 SE	[KA24DE]				01.91- 01.97	JS937	12 1.4
	[KA24E]				01.89- 01.90	JS937	12 1.4
240Z 2.4	[L24]				01.70- 01.73	JS307	12 1.0
260Z 2.6	[L26]				01.74- 01.74	JS307	12 1.0
280Z 2.8	[L28E]				01.75- 01.77	JS307	12 1.0
280ZX 2.8	[L28E]	01.82- 01.83	JA1981R	14 60			
280ZX 2.8 GL	[L28E]	01.81- 01.81	JA1981R	14 60			
280ZX 2.8 Turbo	[L28ET]	01.82- 01.83	JA1981R	14 60			
Axxess 2.4	[KA24E]				01.90- 01.90	JS937	12 1.4
B210 1.3	[A13]				01.74- 01.74	JS755#	12 1.0
B210 1.4	[A14]				01.75- 01.78	JS755#	12 1.0
D21 2.4	[KA24E]				01.90- 01.93	JS939	12 1.2
	[Z24]				01.86- 01.89	JS307	12 1.0
D21 3.0	[VG30E]	01.90- 01.93	JA11221R	14 70	01.90- 01.93	JS1104	12 1.4
D21 3.0 SE	[VG30E]	01.91- 01.93	JA11221R	14 70	01.91- 01.93	JS1104	12 1.4
F 10 1.4	[A14]				01.76- 01.78	JS755#	12 1.0
Frontier 2.4	[KA24DE]				01.98- 01.01	JS1219	12 1.4
Maxima 2.4	[L24E]	01.82- 01.84	JA1981R	14 60			
Maxima 3.0	[VG30E]	01.85- 01.91	JA7671R	14 90	01.89- 01.91	JS754#	12 1.4
	[VQ30DE]	01.99- 01.99	JA13571R	14 100	01.99- 01.01	JS924	12 1.4
Maxima 3.0 GLE	[VQ30DE]	01.95- 01.97	JA9901R	14 110	01.95- 01.98	JS924	12 1.4
		01.98- 01.98	JA13571R	14 100			
Maxima 3.0 GXE	[VG30E]	01.92- 01.94	JA7671R	14 90	01.92- 01.94	JS754#	12 1.4
	[VQ30DE]	01.95- 01.97	JA9901R	14 110	01.95- 01.98	JS924	12 1.4
		01.98- 01.98	JA13571R	14 100			
Maxima 3.0 SE	[VE30DE]				01.92- 01.94	JS754#	12 1.4
	[VQ30DE]	01.95- 01.98	JA9901R	14 110	01.95- 01.98	JS924	12 1.4
NX 1.6	[GA16DE]	01.91- 01.93	JA9741R	14 65	01.91- 01.93	JS766	12 1.2
					01.91- 01.93	JS759	12 0.8
NX 2.0	[SR20DE]				01.91- 01.93	JS627	12 1.4
Pathfinder 3.0	[VG30E]	01.91- 01.92	JA11221R	14 70	01.91- 01.92	JS1104	12 1.4
Pathfinder 3.0 LE	[VG30E]	01.94- 01.95	JA11221R	14 70	01.94- 01.95	JS1104	12 1.4
Pathfinder 3.0 SE	[VG30E]	01.90- 01.95	JA11221R	14 70	01.90- 01.95	JS1104	12 1.4
Pathfinder 3.0 XE	[VG30E]	01.90- 01.95	JA11221R	14 70	01.90- 01.95	JS1104	12 1.4
Pick Up 2.4	[KA24E]	01.94- 01.94	JA13631R#	14 60	01.96- 01.97	JS1219	12 1.4
					01.94- 01.94	JS939	12 1.2
Pick Up 2.4 SE	[KA24E]				01.96- 01.97	JS1219	12 1.4
Pick Up 2.4 Short Bed E	[KA24E]				01.95- 01.95	JS939	12 1.2
Pick Up 2.4 Short Bed XE	[KA24E]				01.95- 01.97	JS939	12 1.2
Pick Up 2.4 XE	[KA24E]	01.94- 01.95	JA13631R#	14 60	01.94- 01.95	JS939	12 1.2
					01.96- 01.97	JS1219	12 1.4
Pick Up 3.0	[VG30E]	01.94- 01.94	JA13631R#	14 60	01.94- 01.94	JS1104	12 1.4
Pick Up 3.0 SE	[VG30E]	01.94- 01.95	JA13631R#	14 60	01.94- 01.95	JS1104	12 1.4
Pick Up 3.0 XE	[VG30E]	01.94- 01.95	JA13631R#	14 60	01.94- 01.95	JS1104	12 1.4
Pulsar 1.6	[E16]	01.83- 01.83	JA1251R	14 60	01.83- 01.83	JS305	12 0.8
Pulsar NX 1.5 Turbo	[E15T]	01.83- 01.84	JA1581R#	14 60			
Pulsar NX 1.6	[E16]	01.83- 01.86	JA1251R	14 60	01.83- 01.86	JS305	12 0.8
	[GA16i]	01.90- 01.90	JA6531R	14 65	01.90- 01.90	JS759	12 0.8
		01.90- 01.90	JA9741R	14 65	01.90- 01.90	JS766	12 1.2
Pulsar NX 1.6 SE	[CA16DE]	01.87- 01.87	JA1661R	14 70			
Pulsar NX 1.6 XE	[E16i]	01.87- 01.88	JA1631R	14 60	01.87- 01.88	JS305	12 0.8
					01.87- 01.88	JS520	12 1.2
	[GA16i]	01.89- 01.90	JA6531R	14 65	01.89- 01.90	JS766	12 1.2
		01.89- 01.90	JA9741R	14 65	01.89- 01.90	JS759	12 0.8
Pulsar NX 1.8 SE	[CA18DE]	01.86- 01.89	JA1661R	14 70			
Sentra 1.5	[E15S]	01.82- 01.83	JA1251R	14 60	01.82- 01.83	JS305	12 0.8
Sentra 1.6	[E16]	01.83- 01.84	JA1251R	14 60	01.85- 01.85	JS520	12 1.2
		01.85- 01.85	JA1581R#	14 60	01.83- 01.84	JS305	12 0.8
	[E16i]	01.87- 01.88	JA1631R	14 60	01.87- 01.88	JS305	12 0.8
					01.87- 01.88	JS520	12 1.2
	[E16S]	01.86- 01.87	JA1581R#	14 60	01.86- 01.88	JS520	12 1.2
		01.86- 01.88	JA1631R	14 60	01.88- 01.88	JS305	12 0.8
	[GA16DE]	01.91- 01.94	JA9741R	14 65	01.91- 01.99	JS766	12 1.2
					01.91- 01.99	JS759	12 0.8
	[GA16i]	01.89- 01.90	JA6531R	14 65	01.89- 01.90	JS766	12 1.2
		01.89- 01.90	JA9741R	14 65	01.89- 01.90	JS759	12 0.8
Sentra 1.6 4WD	[GA16i]	01.90- 01.90	JA6531R	14 65	01.90- 01.90	JS766	12 1.2
		01.90- 01.90	JA9741R	14 65			



NISSAN Continued

Sentra 1.6 E	[GA16DE]	01.93- 01.94	JA974IR	14 65	01.93- 01.96 JS766	12 1.2
					01.93- 01.96 JS759	12 0.8
Sentra 1.6 GLE	[GA16DE]				01.95- 01.97 JS759	12 0.8
					01.95- 01.97 JS766	12 1.2
Sentra 1.6 GXE	[GA16DE]	01.93- 01.94	JA974IR	14 65	01.93- 01.97 JS766	12 1.2
					01.93- 01.97 JS759	12 0.8
Sentra 1.6 LE	[GA16DE]	01.94- 01.94	JA974IR	14 65	01.94- 01.94 JS766	12 1.2
					01.94- 01.94 JS759	12 0.8
Sentra 1.6 SE	[GA16DE]	01.93- 01.94	JA974IR	14 65	01.93- 01.94 JS759	12 0.8
					01.93- 01.94 JS766	12 1.2
Sentra 1.6 XE	[GA16DE]	01.93- 01.94	JA974IR	14 65	01.93- 01.97 JS759	12 0.8
					01.93- 01.97 JS766	12 1.2
Sentra 2.0	[SR20DE]	01.98- 01.99	JA1287IR	14 80	01.98- 01.01 JS1137	12 1.4
Sentra 2.0 SE-R	[SR20DE]				01.91- 01.94 JS627	12 1.4
Stanza 2.0	[CA20E]	01.86- 01.89	JA166IR	14 70		
	[CA20S]	01.82- 01.83	JA107IR	14 60		
Stanza 2.4	[KA24E]				01.90- 01.92 JS937	12 1.4
Van 2.4	[Z24i]				01.87- 01.88 JS311#	12 0.8
Xterra 2.4	[KA24DE]				01.00- 01.01 JS1219	12 1.4
<b>PASSENGER CARS AO</b>						
100 NX 2.0	(B13)[SR20DE]	10.90- 10.94	JA762IR	14 80	10.90- 10.94 JS627	12 1.4
Almera 1.5 XL	(N16)[QG15DE]	03.01-	JA1607IR	14 80	03.01-	JS1100 12 1.2
Bluebird 1.6	(T72_T12)[CA16S]	12.85- 02.90	JA166IR	14 70		
Bluebird 1.8	(T72_T12)[CA18N]	03.88- 04.90	JA166IR	14 70		
Bluebird 1.8 Turbo	(WU11)[CA18ET]	09.84- 04.90	JA166IR	14 70	09.84- 04.90 JS378	12 1.0
Bluebird 2.0 LX	(T72_T12)[CA20S]	12.85- 02.90	JA166IR	14 70	12.85- 02.90 JS378	12 1.0
	(U11)[CA20S]	12.85- 02.90	JA166IR	14 70		
	(WU11)[CA20S]	12.85- 02.90	JA166IR	14 70	12.85- 02.90 JS378	12 1.0
Cabstar 2.0	[Z20S]	01.82- 05.94	JA104IR	14 50		
		01.82- 05.94	JA158IR#	14 60		
		07.92- 05.94	JA104IR	14 50		
		07.92- 05.94	JA158IR#	14 60		
Cherry 1.6	(N12)[E16]				05.84- 07.86 JS520	12 1.2
Navara 2.5 DCi	(D40)	12.05-	CA2085IR*	14 130	01.05-	CS1424 12 2.0
Navara 2.5 DCi 4x4	(D40)	08.08-	CA2085IR*	14 130		
Pathfinder 2.5 DCi	(R51)	09.06-	CA1946IR	14 150		
		01.05- 09.06	CA2085IR*	14 130		
Pick Up 2.7 TD	(D22)[TD27]	02.98-	JA1516IR	14 60	02.98-	JS660 12 2.0
Prairie Pro 2.0 SLX	(M11)[CA20E]	03.89- 08.90	JA166IR	14 70	03.89- 08.90 JS911#	12 1.4
Prairie Pro 2.0 SLX 4WD	(M11)[CA20E]	03.89- 08.90	JA166IR	14 70		
Primer 1.6 16V Visia	(WP11)[QG16DE]	01.02- 12.01	JA1607IR	14 80	01.02- 12.01 JS1100	12 1.2
Primer 2.0	(P10)[SR20DE]	06.90- 04.93	JA665IR	14 80	06.90- 04.93 JS627	12 1.4
	(W10)[SR20DE]	07.94- 01.98	JA665IR	14 80	07.94- 01.98 JS627	12 1.4
Primer 2.0 GT 4WD	(P10)[SR20DE]	03.91- 04.93	JA665IR	14 80	03.91- 04.93 JS627	12 1.4
Serena 1.6	(C23M)[GA16DE]	10.94- 08.00	JA1374IR	14 80	10.94- 08.00 JS1094	12 1.4
Serena 2.0 SGX	(C2)[SR20DE]	09.00-	JA975IR	14 90	09.00-	JS890 12 1.4
Serena 2.0 SGX 4WD	(C2)[SR20DE]	09.00-	JA975IR	14 90	09.00-	JS890 12 1.4
Sunny 1.3	[QG13DE]				07.95- 03.00 JS1100	12 1.2
Sunny 1.4	(N13)	10.88- 09.90	JA163IR	14 60		
	(N14)[GA14DS]	10.90- 06.95	JA974IR	14 65	A13 10.90- 06.95 JS520	12 1.2
					10.90- 06.95 JS759	12 0.8
Sunny 1.6 L	(Y10)[GA16DE]	11.92- 07.94	JA974IR	14 65	10.92- 07.95 JS766	12 1.2
		07.94-	JA1182IR	14 70	07.95- 04.98 JS1100	12 1.2
Sunny 1.6 SGX	(B12)	10.88- 09.90	JA653IR	14 65	10.88- 09.90 JS520	12 1.2
Sunny 1.6 SLX 4WD	(B11)[E16S]	07.86- 10.88	JA163IR	14 60	07.86- 10.88 JS305	12 0.8
					07.86- 10.88 JS520	12 1.2
Sunny 1.6 SR 4WD	(N14)[GA16DEL]	01.92- 06.95	JA974IR	14 65	AT 01.92- 06.95 JS766	12 1.2
					01.92- 06.95 JS520	12 1.2
					01.92- 06.95 JS759	12 0.8
					05.01-	JS1219 12 1.4
Urvan 2.4	[KA24DE]					
Vanette 2.0	(C22)[Z20S]	07.87- 08.94	JA104IR	14 50		
		07.87- 08.94	JA158IR#	14 60		
X-Trail 2.0 4WD	(T30)[QR20DE]	09.01-	JA1712IR	14 110	AT 09.01-	JS1306 12 1.4
					09.01-	JS1318 12 1.4
X-Trail 2.0 LX	(T30)[QR20DE]	09.01-	JA1712IR	14 110	09.01-	JS1318 12 1.4
X-Trail 2.0 Turbo Sport 4WD	(T30)	06.01-	JA1712IR	14 110	AT 06.01-	JS1306 12 1.4
					06.01-	JS1318 12 1.4
X-Trail 2.2 DCi	(T30)	10.04-	JA1615IR	14 90	10.04-	JS1295 12 1.7
X-Trail 2.5 4WD	(T30)[QR25DE]	11.02-	JA1712IR	14 110	11.02-	JS1318 12 1.4
					AT 11.02-	JS1306 12 1.4
<b>TRUCKS EU</b>						
45.15 3.0 Diesel	(F24)[ZD30]	10.06-	CA2081IR*	14 120		
		10.06-	CA2082IR*	14 135		
Cabstar 1.6	(F22)[Z16]				A13 10.86- 09.92 JS308#	12 1.2
Cabstar 2.0	(F22)[Z20]				A13 01.86- 12.88 JS308#	12 1.2
Cabstar 2.3 Diesel	(F22)[SD23]				A13 10.86- 06.92 JS517	12 2.5
					10.86- 06.92 JS660	12 2.0
	[TD23]	10.86- 06.92	JA185IR	14 50	12.81- 06.92 JS660	12 2.0
		10.86- 06.92	JA780IR	14 60	A13 12.81- 06.92 JS517	12 2.5
Cabstar 2.5 Diesel	(F22)[SD25]				02.83- 02.86 JS359	12 1.8
					02.86- 12.90 JS522	12 2.0
	[TD25]	10.86- 06.92	JA185IR	14 50	10.86- 06.92 JS660	12 2.0
					A13 10.86- 06.92 JS517	12 2.5
Cabstar 2.5 TD	(F23)[TD25]	07.92-	JA185IR	14 50	07.92- 08.92 JS660	12 2.0
					A13 07.92- 08.92 JS517	12 2.5
Cabstar 2.7 Diesel	(F22)[TD27]	10.86- 06.92	JA185IR	14 50	A13 02.83- 12.90 JS517	12 2.5
		10.86- 10.88	JA780IR	14 60	02.83- 12.90 JS660	12 2.0
Cabstar 5.7	(1120)[FD6]				04.85-	JS1087 24 3.5
	(1220)[FD6]				04.85-	JS1087 24 3.5
	(815)[FE6]				04.85-	JS1087 24 3.5
	(818)[FE6]				04.85-	JS1087 24 3.5
Cabstar E 110.45 3.0 TD	[BD-30Ti]	10.98- 10.06	JA1527IR	14 55	10.98- 10.06 JS660	12 2.0
		10.98- 10.06	JA1603IR	14 70		
		10.98- 10.06	JA1614IR	14 55		
Cabstar E 120.35 3.0 TD	[BD-30Ti]	10.98- 10.06	JA1527IR	14 55	10.98- 10.06 JS660	12 2.0
		10.98- 10.06	JA1603IR	14 70		
		10.98- 10.06	JA1614IR	14 55		
Cabstar E 90.32 2.7 Diesel	[TD27T]	10.98- 10.06	JA1527IR	14 55		
		10.98- 10.06	JA1603IR	14 70		
		10.98- 10.06	JA1614IR	14 55		
Cabstar E 90.32 3.0 TD	[BD-30Ti]	10.98- 10.06	JA1527IR	14 55	10.98- 10.06 JS660	12 2.0
		10.98- 10.06	JA1603IR	14 70		
		10.98- 10.06	JA1614IR	14 55		
E 120.45 3.0 TD	[BD-30Ti]	10.98- 10.06	JA1527IR	14 55	10.98- 10.06 JS660	12 2.0
		10.98- 10.06	JA1603IR	14 70		
		10.98- 10.06	JA1614IR	14 55		
ECO-T 100 3.0 TD	[BD-30Ti]	07.96- 08.99	JA1527IR	14 55	04.93- 08.99 JS1159	12 2.2
		07.96- 08.99	JA1603IR	14 70		



FORK LIFTS						
FD104		JA100	14 35		JS329	12 0.8
					JS343	12 0.8
FD105		JA100	14 35			
FG101		JA100	14 35	01.74-	JS340	12 0.8
FG103		JA100	14 35			
H30				01.90-	JS779	12 1.2
Various Models					JS329	12 0.8
					JS915	12 1.2
					JS379	12 1.8
Oldsmobile						
PASSENGER CARS EU						
Cutlass 2.8 V6 Supreme	09.87-	UA1113IR	14 100			
Cutlass 3.1 V6 Supreme	09.88-	UA1113IR	14 100			
Cutlass 3.4 V6 Supreme	09.90-	UA938IR	14 100			
PASSENGER CARS US						
98 3.0 Regency				01.85- 01.85	US810#	12
98 3.8 Regency	01.88- 01.94	UA964IR	14 100	01.85- 01.94	US810#	12
98 3.8 Regency Brougham	01.88- 01.90	UA964IR	14 100	01.85- 01.90	US810#	12
98 3.8 Regency Elite	01.91- 01.94	UA964IR	14 100	01.91- 01.95	US810#	12
98 3.8 Regency Touring	01.88- 01.93	UA964IR	14 100	01.88- 01.93	US810#	12
98 3.8 Super Regency Elite	01.94- 01.94	UA964IR	14 100	01.94- 01.94	US810#	12
98 3.8 Super Regency Touring	01.92- 01.93	UA964IR	14 100			
98 4.1	01.81- 01.81	UA943IR	14 60	01.81- 01.81	US818	12 1.5
98 4.1 Regency	01.81- 01.83	UA943IR	14 60	01.81- 01.83	US818	12 1.5
98 4.1 Regency Brougham	01.82- 01.83	UA943IR	14 60	01.82- 01.83	US818	12 1.5
98 4.3 Regency	01.85- 01.85	UA943IR	14 60			
98 4.3 Regency Brougham	01.85- 01.85	UA943IR	14 60			
98 5.0	01.80- 01.81	UA943IR	14 60			
98 5.0 Regency	01.80- 01.83	UA943IR	14 60			
	01.84- 01.84	UA945IR	14 65			
98 5.0 Regency Brougham	01.84- 01.84	UA945IR	14 65			
	01.82- 01.83	UA943IR	14 60			
98 5.7	01.72- 01.80	UA943IR	14 60	01.72- 01.73	US818	12 1.5
98 5.7 Regency	01.73- 01.80	UA943IR	14 60	01.73- 01.73	US818	12 1.5
98 5.7	01.78- 01.81	UA943IR	14 60			
98 5.7 Regency	01.78- 01.83	UA943IR	14 60			
	01.84- 01.84	UA945IR	14 65			
98 5.7 Regency Brougham	01.82- 01.83	UA943IR	14 60			
	01.84- 01.84	UA945IR	14 65			
98 6.5	01.60- 01.64	UA916#	14 60			
98 6.6	01.75- 01.79	UA943IR	14 60			
98 6.6 Regency	01.75- 01.79	UA943IR	14 60			
98 7.0	01.65- 01.67	UA916#	14 60			
98 7.0 Holiday	01.65- 01.67	UA916#	14 60			
98 7.5	01.72- 01.76	UA943IR	14 60			
	01.68- 01.71	UA916#	14 60			
98 7.5 Regency	01.73- 01.76	UA943IR	14 60			
442 5.7	01.68- 01.70	UA943IR	14 60	01.68- 01.70	US818	12 1.5
	01.68- 01.70	UA916#	14 60			
442 6.6	01.65- 01.69	UA916#	14 60			
442 7.5	01.68- 01.71	UA916#	14 60			
	01.68- 01.71	UA943IR	14 60			
Achieva 3.3 S				01.92- 01.93	US810#	12
Achieva 3.3 SL				01.92- 01.93	US810#	12
Achieva 3.3 W44				01.92- 01.93	US810#	12
Bravada 4.3	01.91- 01.94	UA939IR	14 100	01.91- 01.94	US858	12
Calais 2.3	01.87- 01.87	UA938IR	14 100			
Calais 3.0				01.85- 01.87	US810#	12
Calais 3.0 Supreme				01.85- 01.87	US810#	12
Ciera 2.2 SL	01.95- 01.96	UA939IR	14 100			
Custom Cruiser 5.0	01.84- 01.90	UA945IR	14 65			
	01.80- 01.83	UA943IR	14 60			
Custom Cruiser 5.7	01.73- 01.80	UA943IR	14 60	01.73- 01.73	US818	12 1.5
Custom Cruiser 5.7	01.84- 01.85	UA945IR	14 65			
	01.78- 01.83	UA943IR	14 60			
Custom Cruiser 6.6	01.75- 01.79	UA943IR	14 60			
Custom Cruiser 7.5	01.71- 01.71	UA916#	14 60			
	01.71- 01.76	UA943IR	14 60			
Cutlass 2.2 Ciera Cruiser S	01.93- 01.93	UA939IR	14 100			
Cutlass 2.2 Ciera S	01.93- 01.94	UA939IR	14 100			
Cutlass 2.3 Calais	01.88- 01.91	UA938IR	14 100			
Cutlass 2.3 Calais International	01.88- 01.91	UA938IR	14 100			
Cutlass 2.3 Calais S	01.89- 01.91	UA938IR	14 100			
Cutlass 2.3 Calais SL	01.88- 01.91	UA938IR	14 100			
Cutlass 2.5 Ciera	01.82- 01.92	UA943IR	14 60	01.86- 01.92	US810#	12
Cutlass 2.5 Ciera Brougham	01.82- 01.86	UA943IR	14 60	01.87- 01.88	US810#	12
	01.87- 01.88	UA938IR	14 100			
Cutlass 2.5 Ciera Cruiser	01.87- 01.90	UA938IR	14 100	01.84- 01.90	US810#	12
	01.84- 01.86	UA943IR	14 60			
Cutlass 2.5 Ciera Cruiser Brougham	01.87- 01.88	UA938IR	14 100	01.87- 01.88	US810#	12
Cutlass 2.5 Ciera Cruiser S	01.91- 01.92	UA938IR	14 100	01.91- 01.92	US810#	12
Cutlass 2.5 Ciera Cruiser SL	01.89- 01.89	UA938IR	14 100	01.89- 01.89	US810#	12
Cutlass 2.5 Ciera LS	01.82- 01.85	UA943IR	14 60			
Cutlass 2.5 Ciera S	01.87- 01.91	UA938IR	14 100	01.87- 01.91	US810#	12
Cutlass 2.5 Ciera SL	01.87- 01.89	UA938IR	14 100	01.87- 01.89	US810#	12
Cutlass 2.8 Ciera	01.82- 01.89	UA945IR	14 65			
	01.82- 01.82	UA943IR	14 60			
Cutlass 2.8 Ciera Brougham	01.82- 01.84	UA943IR	14 60			
	01.82- 01.88	UA945IR	14 65			
Cutlass 2.8 Ciera Cruiser	01.84- 01.89	UA945IR	14 65			
	01.84- 01.85	UA943IR	14 60			
Cutlass 2.8 Ciera Cruiser Brougham	01.87- 01.88	UA1109IR	14 105			
Cutlass 2.8 Ciera Cruiser SL	01.89- 01.89	UA1109IR	14 105			
Cutlass 2.8 Ciera LS	01.82- 01.84	UA945IR	14 65			
	01.82- 01.84	UA943IR	14 60			
Cutlass 2.8 Ciera S	01.87- 01.87	UA1109IR	14 105			
Cutlass 2.8 Ciera SL	01.87- 01.89	UA1109IR	14 105			
Cutlass 2.8 Supreme	01.88- 01.89	UA1113IR	14 100			
Cutlass 2.8 Supreme International	01.88- 01.89	UA1113IR	14 100			
Cutlass 2.8 Supreme SL	01.88- 01.89	UA1113IR	14 100			
Cutlass 3.0 Calais International				01.88- 01.88	US810#	12
Cutlass 3.0 Calais SL				01.88- 01.88	US810#	12



**OLDSMOBILE** *Continued*

Cutlass 3.0 Ciera	01.82- 01.82	UA943IR	14 60		01.82- 01.82	US810#	12
Cutlass 3.0 Ciera Brougham	01.82- 01.85	UA943IR	14 60		01.82- 01.85	US810#	12
Cutlass 3.0 Ciera Cruiser	01.84- 01.85	UA943IR	14 60		01.84- 01.85	US810#	12
Cutlass 3.0 Ciera LS	01.82- 01.85	UA943IR	14 60		01.82- 01.85	US810#	12
Cutlass 3.1 Supreme	01.89- 01.93	UA1113IR	14 100				
Cutlass 3.1 Supreme International	01.89- 01.93	UA1113IR	14 100				
Cutlass 3.1 Supreme S	01.92- 01.93	UA1113IR	14 100				
Cutlass 3.1 Supreme SL	01.89- 01.91	UA1113IR	14 100				
Cutlass 3.3 Calais S					01.89- 01.89	US810#	12
Cutlass 3.3 Calais SL					01.89- 01.91	US810#	12
Cutlass 3.3 Ciera					01.89- 01.92	US810#	12
Cutlass 3.3 Ciera Cruiser					01.89- 01.90	US810#	12
Cutlass 3.3 Ciera Cruiser S					01.91- 01.93	US810#	12
Cutlass 3.3 Ciera Cruiser SL					01.89- 01.93	US810#	12
Cutlass 3.3 Ciera International					01.89- 01.90	US810#	12
Cutlass 3.3 Ciera S					01.90- 01.93	US810#	12
Cutlass 3.3 Ciera SL					01.89- 01.93	US810#	12
Cutlass 3.4 Supreme S	01.92- 01.94	UA938IR	14 100				
Cutlass 3.5	01.62- 01.63	UA916#	14 60				
Cutlass 3.8	01.80- 01.81	UA943IR	14 60		01.80- 01.81	US818	12 1.5
Cutlass 3.8 Brougham	01.80- 01.81	UA943IR	14 60		01.80- 01.81	US818	12 1.5
Cutlass 3.8 Calais	01.78- 01.84	UA943IR	14 60		01.78- 01.84	US818	12 1.5
Cutlass 3.8 Ciera					01.86- 01.88	US810#	12
Cutlass 3.8 Ciera Brougham	01.84- 01.85	UA943IR	14 60		01.84- 01.88	US810#	12
	01.87- 01.88	UA958IR	14 105				
Cutlass 3.8 Ciera Cruiser	01.87- 01.88	UA958IR	14 105		01.84- 01.88	US810#	12
	01.84- 01.85	UA943IR	14 60				
Cutlass 3.8 Ciera Cruiser Brougham	01.87- 01.88	UA958IR	14 105		01.87- 01.88	US810#	12
Cutlass 3.8 Ciera International	01.88- 01.88	UA958IR	14 105		01.88- 01.88	US810#	12
Cutlass 3.8 Ciera LS	01.84- 01.85	UA943IR	14 60		01.84- 01.85	US810#	12
Cutlass 3.8 Ciera S	01.87- 01.87	UA958IR	14 105		01.87- 01.87	US810#	12
Cutlass 3.8 Ciera SL	01.87- 01.88	UA958IR	14 105		01.87- 01.88	US810#	12
Cutlass 3.8 Cruiser	01.78- 01.83	UA943IR	14 60		01.78- 01.83	US818	12 1.5
	01.83- 01.83	UA945IR	14 65				
Cutlass 3.8 Cruiser Brougham	01.80- 01.81	UA943IR	14 60		01.80- 01.81	US818	12 1.5
Cutlass 3.8 LS	01.80- 01.81	UA943IR	14 60		01.80- 01.81	US818	12 1.5
Cutlass 3.8 S	01.77- 01.77	UA943IR	14 60		01.77- 01.77	US818	12 1.5
Cutlass 3.8 Salon	01.78- 01.87	UA943IR	14 60		01.78- 01.87	US818	12 1.5
Cutlass 3.8 Salon Brougham	01.78- 01.80	UA943IR	14 60		01.78- 01.80	US818	12 1.5
Cutlass 3.8 Supreme	01.77- 01.87	UA943IR	14 60		01.77- 01.87	US818	12 1.5
Cutlass 3.8 Supreme Brougham	01.77- 01.87	UA943IR	14 60		01.77- 01.87	US818	12 1.5
Cutlass 4.1	01.68- 01.71	UA916#	14 60				
	01.75- 01.75	UA943IR	14 60		01.68- 01.75	US818	12 1.5
Cutlass 4.1 S	01.75- 01.76	UA943IR	14 60		01.71- 01.76	US818	12 1.5
	01.71- 01.71	UA916#	14 60				
Cutlass 4.1 Supreme	01.75- 01.76	UA943IR	14 60		01.75- 01.76	US818	12 1.5
Cutlass 4.1 Supreme Brougham	01.76- 01.76	UA943IR	14 60				
					01.76- 01.76	US818	12 1.5
Cutlass 4.3	01.75- 01.81	UA943IR	14 60		01.75- 01.75	US818	12 1.5
Cutlass 4.3 Brougham	01.80- 01.81	UA943IR	14 60				
Cutlass 4.3 Calais	01.78- 01.82	UA943IR	14 60				
Cutlass 4.3 Cruiser	01.78- 01.82	UA943IR	14 60				
Cutlass 4.3 Cruiser Brougham	01.80- 01.81	UA943IR	14 60				
Cutlass 4.3 LS	01.80- 01.81	UA943IR	14 60				
Cutlass 4.3 S	01.75- 01.77	UA943IR	14 60		01.75- 01.77	US818	12 1.5
Cutlass 4.3 Salon	01.75- 01.80	UA943IR	14 60		01.75- 01.79	US818	12 1.5
Cutlass 4.3 Salon Brougham	01.78- 01.80	UA943IR	14 60				
Cutlass 4.3 Supreme	01.75- 01.82	UA943IR	14 60		01.75- 01.79	US818	12 1.5
Cutlass 4.3 Supreme Brougham	01.76- 01.82	UA943IR	14 60		01.76- 01.79	US818	12 1.5
Cutlass 4.3 Calais	01.79- 01.83	UA943IR	14 60				
Cutlass 4.3 Ciera	01.82- 01.82	UA943IR	14 60				
Cutlass 4.3 Ciera Brougham	01.82- 01.85	UA943IR	14 60				
Cutlass 4.3 Ciera Cruiser	01.84- 01.85	UA943IR	14 60				
Cutlass 4.3 Ciera LS	01.82- 01.85	UA943IR	14 60				
Cutlass 4.3 Cruiser	01.79- 01.79	UA943IR	14 60				
Cutlass 4.3 Salon	01.79- 01.79	UA943IR	14 60				
Cutlass 4.3 Supreme	01.79- 01.83	UA943IR	14 60				
Cutlass 4.3 Supreme Brougham	01.79- 01.83	UA943IR	14 60				
Cutlass 4.4 Calais	01.82- 01.82	UA943IR	14 60				
Cutlass 4.4 Cruiser	01.82- 01.82	UA943IR	14 60				
Cutlass 4.4 Supreme	01.82- 01.82	UA943IR	14 60				
Cutlass 4.4 Supreme Brougham	01.82- 01.82	UA943IR	14 60				
Cutlass 5.0	01.80- 01.80	UA943IR	14 60				
Cutlass 5.0 Brougham	01.80- 01.80	UA943IR	14 60				
Cutlass 5.0 Calais	01.83- 01.84	UA945IR	14 65		01.84- 01.84	US818	12 1.5
	01.78- 01.83	UA943IR	14 60				
Cutlass 5.0 Cruiser	01.78- 01.83	UA943IR	14 60				
Cutlass 5.0 Cruiser Brougham	01.80- 01.81	UA943IR	14 60				
Cutlass 5.0 LS	01.80- 01.80	UA943IR	14 60				
Cutlass 5.0 Salon	01.85- 01.87	UA945IR	14 65		01.85- 01.87	US818	12 1.5
	01.78- 01.80	UA943IR	14 60				
Cutlass 5.0 Salon Brougham	01.78- 01.80	UA943IR	14 60				
Cutlass 5.0 Supreme	01.78- 01.83	UA943IR	14 60		01.83- 01.87	US818	12 1.5
	01.84- 01.87	UA945IR	14 65				
Cutlass 5.0 Supreme Brougham	01.78- 01.83	UA943IR	14 60				
	01.84- 01.87	UA945IR	14 65				
Cutlass 5.4	01.64- 01.67	UA916#	14 60		01.64- 01.67	US818	12 1.5
Cutlass 5.4 Holiday	01.64- 01.67	UA916#	14 60		01.64- 01.67	US818	12 1.5
Cutlass 5.7	01.68- 01.80	UA943IR	14 60		01.68- 01.75	US818	12 1.5
	01.68- 01.71	UA916#	14 60				
Cutlass 5.7 Brougham	01.80- 01.80	UA943IR	14 60				
Cutlass 5.7 Calais	01.79- 01.80	UA943IR	14 60				
Cutlass 5.7 Cruiser	01.78- 01.79	UA943IR	14 60				
Cutlass 5.7 Cruiser Brougham	01.80- 01.80	UA943IR	14 60				
Cutlass 5.7 LS	01.80- 01.80	UA943IR	14 60				
Cutlass 5.7 S	01.71- 01.77	UA943IR	14 60		01.71- 01.75	US818	12 1.5
	01.71- 01.71	UA916#	14 60				
Cutlass 5.7 Salon	01.75- 01.79	UA943IR	14 60		01.75- 01.75	US818	12 1.5
Cutlass 5.7 Supreme	01.72- 01.80	UA943IR	14 60		01.72- 01.75	US818	12 1.5
Cutlass 5.7 Supreme Brougham	01.76- 01.80	UA943IR	14 60				
Cutlass 5.7 Supreme Cruiser	01.74- 01.75	UA943IR	14 60		01.74- 01.75	US818	12 1.5
Cutlass 5.7	01.80- 01.81	UA943IR	14 60				
Cutlass 5.7 Brougham	01.80- 01.81	UA943IR	14 60				



Cutlass 5.7 Calais	01.83- 01.84	UA9451R	14 65				
	01.80- 01.82	UA9431R	14 60				
Cutlass 5.7 Cruiser	01.79- 01.82	UA9431R	14 60				
	01.83- 01.83	UA9451R	14 65				
Cutlass 5.7 Cruiser Brougham	01.80- 01.81	UA9431R	14 60				
Cutlass 5.7 LS	01.80- 01.81	UA9431R	14 60				
Cutlass 5.7 Salon	01.80- 01.80	UA9431R	14 60				
	01.85- 01.85	UA9451R	14 65				
Cutlass 5.7 Supreme	01.83- 01.85	UA9451R	14 65				
	01.79- 01.82	UA9431R	14 60				
Cutlass 5.7 Supreme Brougham	01.79- 01.82	UA9431R	14 60				
	01.83- 01.85	UA9451R	14 65				
Cutlass 6.6	01.65- 01.68	UA916#	14 60				
	01.68- 01.68	UA9431R	14 60				
Cutlass 6.6 S	01.77- 01.77	UA9431R	14 60				
Cutlass 6.6 Salon	01.77- 01.77	UA9431R	14 60				
Cutlass 6.6 Supreme	01.77- 01.77	UA9431R	14 60				
Cutlass 6.6 Supreme Brougham	01.77- 01.77	UA9431R	14 60				
Cutlass 6.6 Turnpike Cruiser	01.67- 01.67	UA916#	14 60				
Cutlass 7.5	01.70- 01.75	UA9431R	14 60				
Cutlass 7.5 S	01.71- 01.76	UA9431R	14 60				
Cutlass 7.5 Salon	01.75- 01.76	UA9431R	14 60				
Cutlass 7.5 Supreme	01.71- 01.76	UA9431R	14 60				
Cutlass 7.5 Supreme Brougham	01.76- 01.76	UA9431R	14 60				
Cutlass 7.5 Supreme Cruiser	01.74- 01.76	UA9431R	14 60				
Delmont 5.7 88	01.68- 01.68	UA916#	14 60				
Delmont 88 5.4	01.67- 01.67	UA916#	14 60	01.67- 01.67	US818	12 1.5	
Delmont 88 5.4 Holiday	01.67- 01.67	UA916#	14 60	01.67- 01.67	US818	12 1.5	
Delmont 88 7.0	01.67- 01.67	UA916#	14 60				
Delmont 88 7.0 Holiday	01.67- 01.67	UA916#	14 60				
Delta 4.4 88	01.82- 01.82	UA9431R	14 60				
Delta 88 3.0 Royale				01.86- 01.86	US810#	12	
Delta 88 3.0 Royale Brougham				01.86- 01.86	US810#	12	
Delta 88 3.8	01.77- 01.83	UA9431R	14 60	01.77- 01.83	US818	12 1.5	
	01.83- 01.83	UA9451R	14 65				
Delta 88 3.8 Royale	01.88- 01.94	UA9641R	14 100	01.86- 01.95	US810#	12	
	01.77- 01.85	UA9431R	14 60	01.77- 01.85	US818	12 1.5	
	01.83- 01.85	UA9451R	14 65				
Delta 88 3.8 Royale Brougham	01.80- 01.85	UA9431R	14 60	01.86- 01.91	US810#	12	
	01.83- 01.85	UA9451R	14 65	01.80- 01.85	US818	12 1.5	
	01.88- 01.91	UA9641R	14 100				
Delta 88 3.8 Royale Brougham LS	01.84- 01.84	UA9431R	14 60	01.84- 01.84	US818	12 1.5	
	01.84- 01.84	UA9451R	14 65				
Delta 88 3.8 Royale LS	01.92- 01.94	UA9641R	14 100	01.92- 01.95	US810#	12	
Delta 88 3.8 Royale LSS				01.95- 01.95	US810#	12	
Delta 88 4.3	01.77- 01.82	UA9431R	14 60	01.77- 01.79	US818	12 1.5	
Delta 88 4.3 Royale	01.77- 01.82	UA9431R	14 60	01.77- 01.79	US818	12 1.5	
Delta 88 4.3 Royale Brougham	01.80- 01.82	UA9431R	14 60				
Delta 88 4.4 Royale	01.82- 01.82	UA9431R	14 60				
Delta 88 4.4 Royale Brougham	01.82- 01.82	UA9431R	14 60				
Delta 88 4.9	01.79- 01.79	UA9431R	14 60				
Delta 88 4.9 Royale	01.79- 01.79	UA9431R	14 60				
Delta 88 5.0	01.80- 01.83	UA9431R	14 60				
Delta 88 5.0 Royale	01.84- 01.85	UA9451R	14 65				
	01.80- 01.83	UA9431R	14 60				
Delta 88 5.0 Royale Brougham	01.80- 01.83	UA9431R	14 60				
	01.84- 01.85	UA9451R	14 65				
Delta 88 5.0 Royale Brougham LS	01.84- 01.85	UA9451R	14 65				
Delta 88 5.4	01.67- 01.67	UA916#	14 60	01.67- 01.67	US818	12 1.5	
Delta 88 5.4 Holiday	01.67- 01.67	UA916#	14 60	01.67- 01.67	US818	12 1.5	
Delta 88 5.7	01.68- 01.80	UA9431R	14 60	01.68- 01.79	US818	12 1.5	
	01.68- 01.71	UA916#	14 60				
Delta 88 5.7 Custom	01.68- 01.70	UA916#	14 60	01.68- 01.70	US818	12 1.5	
	01.68- 01.70	UA9431R	14 60				
Delta 88 5.7 Royale	01.70- 01.80	UA9431R	14 60	01.70- 01.79	US818	12 1.5	
	01.70- 01.70	UA916#	14 60				
Delta 88 5.7 Royale Brougham	01.80- 01.80	UA9431R	14 60				
Delta 88 5.7	01.78- 01.83	UA9431R	14 60				
Delta 88 5.7 Royale	01.84- 01.85	UA9451R	14 65				
	01.78- 01.83	UA9431R	14 60				
Delta 88 5.7 Royale Brougham	01.80- 01.83	UA9431R	14 60				
	01.84- 01.85	UA9451R	14 65				
Delta 88 5.7 Royale Brougham LS	01.84- 01.85	UA9451R	14 65				
Delta 88 6.6	01.77- 01.79	UA9431R	14 60				
Delta 88 6.6 Royale	01.77- 01.79	UA9431R	14 60				
Delta 88 7.0	01.65- 01.67	UA916#	14 60				
Delta 88 7.0 Holiday	01.65- 01.67	UA916#	14 60				
Delta 88 7.5	01.72- 01.76	UA9431R	14 60				
	01.68- 01.71	UA916#	14 60				
Delta 88 7.5 Custom	01.68- 01.71	UA916#	14 60				
Delta 88 7.5 Royale	01.70- 01.76	UA9431R	14 60				
	01.70- 01.71	UA916#	14 60				
Dynamic 6.5	01.60- 01.64	UA916#	14 60				
Dynamic 7.0	01.65- 01.66	UA916#	14 60				
Dynamic 7.0 Holiday	01.65- 01.66	UA916#	14 60				
F 85 3.5	01.61- 01.63	UA916#	14 60				
F 85 3.7	01.64- 01.65	UA916#	14 60	01.64- 01.65	US818	12 1.5	
F 85 4.1	01.66- 01.71	UA916#	14 60	01.66- 01.71	US818	12 1.5	
F 85 4.1 Holiday	01.66- 01.66	UA916#	14 60	01.66- 01.66	US818	12 1.5	
F 85 5.4	01.64- 01.67	UA916#	14 60	01.64- 01.67	US818	12 1.5	
F 85 5.4 Holiday	01.66- 01.66	UA916#	14 60	01.66- 01.66	US818	12 1.5	
F 85 5.7	01.68- 01.72	UA9431R	14 60	01.68- 01.72	US818	12 1.5	
	01.68- 01.71	UA916#	14 60				
F 85 6.6	01.65- 01.66	UA916#	14 60				
F 85 7.5	01.72- 01.72	UA9431R	14 60				
	01.70- 01.70	UA916#	14 60				
Fiesta 6.5	01.63- 01.63	UA916#	14 60				
Firenza 1.8	01.82- 01.86	UA9431R	14 60				
Firenza 1.8 LC	01.86- 01.86	UA9451R	14 65				
Firenza 1.8 LX	01.82- 01.86	UA9431R	14 60				
Firenza 1.8 S	01.82- 01.86	UA9431R	14 60				
Firenza 1.8 SX	01.82- 01.85	UA9431R	14 60				
Firenza 2.8	01.85- 01.85	UA9431R	14 60				
Firenza 2.8 GT	01.86- 01.87	UA9431R	14 60				



**OLDSMOBILE** *Continued*

Firenza 2.8 LX		01.85- 01.85	UA943IR	14	60				
Firenza 2.8 S		01.85- 01.85	UA943IR	14	60				
Firenza 2.8 SX		01.85- 01.85	UA943IR	14	60				
Jetstar 5.4 88		01.64- 01.66	UA916#	14	60	01.64- 01.66	US818	12	1.5
Jetstar 5.4 88 Holiday		01.64- 01.66	UA916#	14	60	01.64- 01.66	US818	12	1.5
Jetstar 6.5 88		01.64- 01.64	UA916#	14	60				
Jetstar 6.5 88 Holiday		01.64- 01.64	UA916#	14	60				
Jetstar 7.0 88		01.65- 01.65	UA916#	14	60				
Jetstar 7.0 88 Holiday		01.65- 01.65	UA916#	14	60				
Omega 2.5		01.80- 01.84	UA943IR	14	60	01.80- 01.82	US810#	12	
Omega 2.5 Brougham		01.80- 01.84	UA943IR	14	60	01.80- 01.82	US810#	12	
Omega 2.8		01.80- 01.84	UA943IR	14	60	01.80- 01.84	US810#	12	
Omega 2.8 Brougham		01.80- 01.84	UA943IR	14	60	01.80- 01.84	US810#	12	
Omega 3.8		01.77- 01.79	UA943IR	14	60	01.77- 01.79	US818	12	1.5
Omega 3.8 Brougham		01.77- 01.79	UA943IR	14	60	01.77- 01.79	US818	12	1.5
Omega 3.8 F85		01.77- 01.77	UA943IR	14	60	01.77- 01.77	US818	12	1.5
Omega 4.1		01.73- 01.76	UA943IR	14	60	01.73- 01.76	US818	12	1.5
Omega 4.1 Brougham		01.76- 01.76	UA943IR	14	60	01.76- 01.76	US818	12	1.5
Omega 4.1 F85		01.76-	UA943IR	14	60				
Omega 4.1 Salon		01.75- 01.75	UA943IR	14	60				
Omega 4.3		01.75- 01.77	UA943IR	14	60	01.75- 01.77	US818	12	1.5
Omega 4.3 Brougham		01.76- 01.77	UA943IR	14	60	01.76- 01.77	US818	12	1.5
Omega 4.3 F85		01.76-	UA943IR	14	60	01.76-	US818	12	1.5
Omega 4.3 Salon		01.75- 01.75	UA943IR	14	60	01.75- 01.75	US818	12	1.5
Omega 5.0		01.77- 01.79	UA943IR	14	60				
Omega 5.0 Brougham		01.77- 01.79	UA943IR	14	60				
Omega 5.0 F85		01.77- 01.77	UA943IR	14	60				
Omega 5.7		01.73- 01.79	UA943IR	14	60	01.73- 01.76	US818	12	1.5
Omega 5.7 Brougham		01.76- 01.79	UA943IR	14	60				
Omega 5.7 F85		01.76- 01.77	UA943IR	14	60	01.76- 01.76	US818	12	1.5
Omega 5.7 Salon		01.75- 01.75	UA943IR	14	60	01.75- 01.75	US818	12	1.5
Silhouette 3.1		01.90- 01.94	UA1109IR	14	105				
Silhouette 3.8		01.92- 01.95	UA964IR	14	100	01.92- 01.95	US810#	12	
Starfire 2.3		01.76- 01.77	UA943IR	14	60				
Starfire 2.3 SX		01.76- 01.77	UA943IR	14	60				
Starfire 2.5		01.78- 01.80	UA943IR	14	60				
Starfire 2.5 SX		01.78- 01.80	UA943IR	14	60				
Starfire 3.8		01.75- 01.80	UA943IR	14	60	01.75- 01.77	US818	12	1.5
Starfire 3.8 SX		01.76- 01.80	UA943IR	14	60	01.76- 01.77	US818	12	1.5
Starfire 5.0		01.77- 01.79	UA943IR	14	60				
Starfire 5.0 SX		01.77- 01.79	UA943IR	14	60				
Starfire 6.5		01.61- 01.64	UA916#	14	60				
Starfire 7.0		01.65- 01.66	UA916#	14	60				
Super 88 6.5		01.60- 01.64	UA916#	14	60				
Toronado 3.8						01.88- 01.92	US810#	12	
Toronado 3.8 Trofeo						01.88- 01.92	US810#	12	
Toronado 5.0 Brougham		01.80- 01.85	UA943IR	14	60				
Toronado 5.7 Brougham		01.79- 01.80	UA943IR	14	60				
Toronado 5.7 Brougham		01.79- 01.85	UA943IR	14	60				
Toronado 6.6		01.78- 01.78	UA943IR	14	60				
Toronado 6.6 Brougham		01.77- 01.78	UA943IR	14	60				
Toronado 6.6 XSR		01.77- 01.77	UA943IR	14	60				
Toronado 7.0		01.66- 01.67	UA916#	14	60				
Toronado 7.5		01.68- 01.76	UA943IR	14	60				
Toronado 7.5		01.68- 01.71	UA916#	14	60				
Toronado 7.5 Brougham		01.75- 01.76	UA943IR	14	60				
Vista 5.7 Cruiser		01.68- 01.77	UA943IR	14	60	01.68- 01.77	US818	12	1.5
Vista 5.7 Cruiser		01.68- 01.71	UA916#	14	60				
Vista 6.6 Cruiser		01.77- 01.77	UA943IR	14	60				
Vista 7.5 Cruiser		01.70- 01.76	UA943IR	14	60				
Vista 7.5 Cruiser		01.70- 01.71	UA916#	14	60				
Vista Cruiser 3.7		01.64- 01.65	UA916#	14	60				
Vista Cruiser 5.4		01.64- 01.67	UA916#	14	60				

**Opel**

**PASSENGER CARS EU**

Admiral B 2.8	[28E]					07.71- 07.76	CS80	12	1.0
Admiral B 2.8 S	[28H]					03.69- 07.76	CS80	12	1.0
Admiral B 2.8 S	[28S]	10.76- 01.78	CA42IR	14	55	03.69- 01.78	CS80	12	1.0
Agila 1.0	[Z10XEP]	08.03-	CA1747IR	14	70	08.03-	CS1257	12	1.1
Agila 1.0 i 12V	[Z10XE]	09.00- 08.03	CA1257IR*	14	70	Chas. -19P00893 09.00- 08.03	CS519	12	1.0
Agila 1.0 LPG	[K10B]	Chas. 1G021260- 09.00- 08.03	CA1747IR	14	70	Chas. 19P00894- 09.00- 08.03	CS1257	12	1.1
Agila 1.2	[K12B]	11.10-	CA2026IR*	14	75				
Agila 1.2 16V Twinport	[Z12XEP]	Chas. -8M110445 09.07-	CA2026IR*	14	75				
Agila 1.2 i 16V	[Z12XE]	07.04-	CA1747IR	14	70	07.04-	CS1257	12	1.1
Agila 1.2 i 16V	[Z12XE]	09.00- 06.04	CA1257IR	14	70	09.00- 06.04	CS519	12	1.0
Agila 1.2 LPG	[K12B]	Chas. 1G021260- 09.00- 06.04	CA1747IR	14	70	09.00- 06.04	CS1257	12	1.1
Agila 1.3 CDTi	[Z13DT]	09.07-	CA2026IR*	14	75				
Antara 2.0 CDTi	[Z20DM]	08.03-	CA1855IR	14	75	08.03-	CS1334	12	1.1
Antara 2.0 CDTi	[Z20DMH]	08.03-	CA1862IR	14	90				
Antara 2.4	[Z24XED]					03.07-	CS1431	12	1.8
Arena 1.9 Diesel	[F8Q600]					05.06-	CS1431	12	1.8
Arena 1.9 Diesel	[F8Q606]					05.06-	CS1431	12	1.8
Arena 2.5 Diesel	[S8U758]					05.06-	CS879	12	1.1
Arena 2.5 Diesel	[S8U780]	03.98- 08.01	CA1304IR	14	75	03.98- 08.01	CS784	12	1.4
Arena 2.5 Diesel	[S8U782]	03.98- 08.01	CA1304IR	14	75	03.98- 08.01	CS784	12	1.4
Ascona A 1.2 S	[12S]					03.98- 08.01	CS370	12	2.2
Ascona A 1.6	[16N]	03.98- 08.01	CA1343IR	14	75	03.98- 08.01	CS370	12	2.2
Ascona A 1.6 Voyage	[16S]					03.98- 08.01	CS370	12	2.2
Ascona A 1.6 S	[16S]	10.72- 08.75	CA48IR	14	45	04.72- 08.75	CS66	12	0.65
Ascona A 1.9 Voyage	[19S]	06.71- 08.75	CA42IR	14	55	10.70- 08.81	CS70	12	0.8
Ascona A 1.6 Voyage	[16N]	06.80- 08.81	CA221IR	14	65				
Ascona A 1.6 S	[16S]	06.71- 08.75	CA42IR	14	55	01.71- 08.75	CS70	12	0.8
Ascona A 1.6 S	[16S]	06.71- 08.75	CA42IR	14	55	01.71- 08.75	CS70	12	0.8
Ascona A 1.9 Voyage	[19S]	06.71- 08.75	CA42IR	14	55	10.70- 08.75	CS70	12	0.8



Ascona A 1.9 S	[19S]	06.71- 08.75	CA42IR	14 55	03.71- 08.75	CS70	12 0.8
Ascona B 1.2	[12N]	08.76- 02.79	CA48IR	14 45	08.76- 02.79	CS66	12 0.65
Ascona B 1.2 S	[12S]	09.75- 02.79	CA48IR	14 45	09.75- 02.79	CS66	12 0.65
Ascona B 1.3	[13N]	03.79- 08.81	CA128IR	14 45	03.79- 08.81	CS162	12 0.7
		03.79- 08.81	CA99IR	14 55			
Ascona B 1.3 S	[13S]	08.79- 08.81	CA128IR	14 45	08.79- 08.81	CS162	12 0.7
		08.79- 08.81	CA99IR	14 55			
Ascona B 1.6 N	[16N]	10.76- 08.81	CA42IR	14 55	09.75- 08.81	CS70	12 0.8 BO
		06.80- 08.81	CA221IR	14 65			
Ascona B 1.6 S	[16S]	10.76- 08.81	CA42IR	14 55	09.75- 08.81	CS70	12 0.8 BO
		06.80- 08.81	CA221IR	14 65			
Ascona B 1.9	[19N]	10.76- 08.81	CA42IR	14 55	08.76- 08.81	CS70	12 0.8 BO
		06.80- 08.81	CA221IR	14 65			
Ascona B 1.9 S	[19S]	10.76- 08.81	CA42IR	14 55	09.75- 08.81	CS70	12 0.8 BO
		06.80- 08.81	CA221IR	14 65			
Ascona B 2.0	[20E]	08.79- 08.81	CA42IR	14 55	08.79- 08.81	CS70	12 0.8 BO
		06.80- 08.81	CA221IR	14 65			
	[20N]	08.77- 08.81	CA42IR	14 55	08.77- 08.81	CS70	12 0.8 BO
		06.80- 08.81	CA221IR	14 65			
Ascona B 2.0 S	[20S]	08.77- 08.81	CA42IR	14 55	08.77- 08.81	CS70	12 0.8 BO
		06.80- 08.81	CA221IR	14 65			
Ascona B 2.0 Diesel	[20D]	08.78- 08.81	CA128IR	14 45			
		08.78- 08.81	CA99IR	14 55			
Ascona B 2.4 400	[24E]	08.79- 08.81	CA221IR	14 65	08.79- 08.81	CS70	12 0.8 BO
		08.79- 08.81	CA42IR	14 55			
Ascona C 1.3	[13N]	09.81- 08.86	CA128IR	14 45	09.81- 08.86	CS162	12 0.7
		09.81- 08.86	CA99IR	14 55			
		09.84- 08.86	CA353IR	14 65			
Ascona C 1.3 S	[13S]	09.81- 08.88	CA128IR	14 45	09.81- 08.88	CS162	12 0.7
		09.81- 08.88	CA99IR	14 55			
		09.84- 08.88	CA353IR	14 65			
Ascona C 1.6	[16N]	09.81- 08.88	CA158IR	14 45	09.81- 08.88	CS263	12 0.8
		09.81- 08.88	CA264IR	14 55			
		09.81- 08.88	CA352IR	14 65			
	[16SV]	09.86- 08.88	CA353IR	14 65	09.86- 08.88	CS535	12 0.9
		09.86- 08.88	CA99IR	14 55	09.86- 08.88	CS519	12 1.0
Ascona C 1.6 i	[C16LZ]	09.86- 08.87	CA353IR	14 65	09.86- 08.87	CS535	12 0.9
		09.86- 08.87	CA99IR	14 55	09.86- 08.87	CS519	12 1.0
	[C16NZ]	09.87- 08.88	CA353IR	14 65	08.87- 08.88	CS519	12 1.0
		09.87- 08.88	CA99IR	14 55	08.87- 08.88	CS535	12 0.9
	[E16NZ]	09.87- 08.88	CA353IR	14 65	09.87- 08.88	CS519	12 1.0
		09.87- 08.88	CA99IR	14 55	09.87- 08.88	CS535	12 0.9
Ascona C 1.6 S	[16SH]	09.81- 08.86	CA158IR	14 45	09.81- 08.86	CS263	12 0.8
		09.81- 08.86	CA264IR	14 55			
		09.81- 08.86	CA352IR	14 65			
Ascona C 1.6 Diesel	[16D]				03.82- 08.88	CS290	12 1.7
					03.82- 08.88	CS322	12 1.7
	[16DA]				03.82- 08.88	CS290	12 1.7
					03.82- 08.88	CS322	12 1.7
Ascona C 1.8	[E18NV]	09.87- 08.88	CA158IR	14 45	09.87- 08.88	CS372	12 1.4 BO
		09.87- 08.88	CA264IR	14 55	09.87- 08.88	CS518	12 1.0 DR
		09.87- 08.88	CA352IR	14 65			
	[S18NV]	09.86- 08.88	CA264IR	14 55	01.85- 08.86	CS372	12 1.4
		09.86- 08.91	CA352IR	14 65	01.85- 08.86	CS263	12 0.8
		09.86- 08.91	CA517IR	14 70			
		09.88- 08.91	CA548IR#	14 55			
Ascona C 1.8 E	[C18NE]	01.85- 08.86	CA158IR	14 45	01.85- 08.86	CS263	12 0.8
		01.85- 08.86	CA264IR	14 55			
		01.85- 08.86	CA352IR	14 65			
Ascona C 1.8 i	[18E]	09.82- 08.86	CA158IR	14 45	09.82- 08.86	CS263	12 0.8
		09.82- 08.86	CA264IR	14 55			
		09.82- 08.86	CA352IR	14 65			
	[C18NE]	01.85- 08.86	CA158IR	14 45	01.85- 08.86	CS263	12 0.8
		01.85- 08.86	CA264IR	14 55			
		01.85- 08.86	CA352IR	14 65			
Ascona C 2.0 GTi	[20SEH]	03.87- 08.88	CA264IR	14 55	03.87- 08.88	CS372	12 1.4 BO
		03.87- 08.88	CA352IR	14 65	03.87- 08.88	CS518	12 1.0 DR
Ascona C 2.0 i	[20NE]	09.86- 08.88	CA264IR	14 55	09.86- 08.88	CS518	12 1.0 DR
		09.86- 08.88	CA352IR	14 65	09.86- 08.88	CS372	12 1.4 BO
	[20SEH]	03.87- 08.88	CA264IR	14 55	03.87- 08.88	CS372	12 1.4 BO
		03.87- 08.88	CA352IR	14 65	03.87- 08.88	CS518	12 1.0 DR
	[C20NE]	09.86- 08.88	CA264IR	14 55	09.86- 08.88	CS372	12 1.4 BO
		09.86- 08.88	CA352IR	14 65	09.86- 08.88	CS518	12 1.0 DR
	[C20NEF]	08.87- 08.88	CA352IR	14 65	08.87- 08.88	CS518	12 1.0 DR
					08.87- 08.88	CS372	12 1.4 BO
Astra F 1.2	[X12XE]	03.98- 08.00	CA1257IR	14 70	03.98- 08.00	CS1257	12 1.1
		03.98- 08.00	CA1561IR	14 100	03.98- 08.00	CS519	12 1.0
	as. 12000001-, 15000001-, 16000001-, 18000001	03.98- 08.00	CA1747IR	14 70			
	as. 12000001-, 15000001-, 16000001-, 18000001	03.98- 08.00	CA1748IR	14 100			
Astra F 1.4	[14NV]	09.91- 09.93	CA1146IR	14 70	09.91- 09.93	CS1183	12 0.9
		09.91- 09.93	CA513IR	14 55			
		09.91- 09.93	CA514IR	14 70			
	[14SE]	09.92- 09.98	CA1146IR	14 70	09.92- 09.98	CS1183	12 0.9
		09.92- 09.98	CA513IR	14 55			
		09.92- 09.98	CA514IR	14 70			
Astra F 1.4 i 16V	[X14NZ]	09.97- 08.00	CA1146IR	14 70	09.97- 08.00	CS519	12 1.0
		PS 09.97- 08.00	CA861IR	14 70			
	[X14XE]	04.96- 02.98	CA1045IR	14 120	04.96- 02.98	CS519	12 1.0
		04.96- 02.98	CA1053IR	14 100	04.96- 02.98	CS535	12 0.9
		04.96- 02.98	CA861IR	14 70			
		09.97- 02.98	CA1391IR	14 70			
		09.97- 02.98	CA1581IR	14 100			
		09.97- 02.98	CA1765IR	14 120			
Astra F 1.4 i	[C14NZ]	09.91- 08.94	CA513IR	14 55	09.91- 03.96	CS162	12 0.7
		09.91- 08.94	CA514IR	14 70	09.91- 02.98	CS519	12 1.0
		09.94- 02.98	CA1066IR	14 55	09.91- 02.98	CS535	12 0.9
		09.94- 02.98	CA1146IR	14 70			
	PS, Chas. P25...P30...P40...P50...P80...	09.92- 01.98	CA861IR	14 70			
	PS, Chas. -NA29...-NE29...-N299...-N499...-N599	09.91- 08.92	CA519IR	14 65			
	PS 09.91- 08.92	09.91- 08.92	CA519IR	14 65			
	PS 09.91- 01.98	09.91- 01.98	CA861IR	14 70			
	PS 09.92- 02.98	09.92- 02.98	CA1053IR	14 100			
	Chas. S2500016...S5000001...S8000001-09.94	01.98	CA1066IR	14 55			
	Chas. S2500016...S5000001...S8000001-09.94	01.98	CA1146IR	14 70			



Opel Continued

		Chas. -S2500015,-R5999999,-R8999999	09.91- 08.94	CA5131R	14 55			
		Chas. -S2500015,-R5999999,-R8999999	09.91- 08.94	CA5141R	14 70			
	[C14SE]		03.92- 08.94	CA6471R	14 70	03.92- 03.96	CS162	12 0.7
			03.92- 02.98	CA8921R	14 55	03.92- 09.98	CS535	12 0.9
			09.94- 02.98	CA11461R	14 70	03.92- 09.98	CS519	12 1.0
		PS 03.92- 08.92		CA5191R	14 65			
		PS 08.92- 02.98		CA8611R	14 70			
	[X14NZ]		09.97- 08.00	CA11461R	14 70	09.97- 08.00	CS519	12 1.0
		PS 09.97- 08.00		CA8611R	14 70			
	[X14XE]		03.98- 08.00	CA10451R	14 120	03.98- 08.00	CS519	12 1.0
			03.98- 08.00	CA10531R	14 100	03.98- 08.00	CS535	12 0.9
			03.98- 08.00	CA13911R	14 70			
			03.98- 08.00	CA15811R	14 100			
Astra F 1.4 Si	[C14SE]		03.92- 08.94	CA6471R	14 70	03.92- 01.98	CS162	12 0.7
			03.92- 02.98	CA8921R	14 55	03.92- 02.98	CS535	12 0.9
			09.94- 02.98	CA11461R	14 70	03.92- 02.98	CS519	12 1.0
		PS 03.92- 08.92		CA5191R	14 65			
		PS 08.92- 02.98		CA8611R	14 70			
Astra F 1.6	[16LZ2]		09.95- 09.98	CA10451R	14 120	09.95- 09.98	CS727	12 1.1
			09.95- 09.98	CA10531R	14 100			
			09.95- 09.98	CA8611R	14 70			
Astra F 1.6 i 16V	[X16XEL]		09.94- 08.00	CA8611R	14 70	09.94- 08.00	CS519	12 1.0
						09.94- 02.98	CS535	12 0.9
Astra F 1.6 i	[16LZ2]		09.94- 01.98	CA10451R	14 120	09.95- 01.98	CS727	12 1.1
			09.94- 01.98	CA10531R	14 100			
			09.94- 01.98	CA8611R	14 70			
	[16NZR]		09.95- 09.98	CA11461R	14 70	09.95- 09.98	CS519	12 1.0
		PS 09.95- 09.98		CA10531R	14 100	09.95- 09.98	CS535	12 0.9
		PS 09.95- 09.98		CA5191R	14 65			
		PS 09.95- 09.98		CA8611R	14 70			
	[C16NZ]		09.91- 08.94	CA10451R	14 120	09.91- 08.94	CS519	12 1.0
			09.91- 08.94	CA10531R	14 100	09.91- 08.94	CS535	12 0.9
			10.91- 04.93	CA5141R	14 70	09.91- 08.94	CS162	12 0.7
		PS, Chas. P2500001- , P3000001- , PS, Chas. - 09.91- 08.94		CA5191R	14 65			
		NA299999, -						
		PS 10.91- 08.92		CA5191R	14 65			
		PS 09.92- 04.93		CA8611R	14 70			
		Chas. S2500016-,-S5000001-,-S8000001-09.91- 08.94		CA11461R	14 70			
		Chas. -S2500015,-R5999999,-R8999999	09.91- 08.94	CA3531R	14 65			
		Chas. -S2500015,-R5999999,-R8999999	09.91- 08.94	CA5141R	14 70			
	[C16SE]	PS, Chas. P25...- , P30...-P40...-P50...- , P80...-	09.92- 02.98	CA8611R	14 70	03.92- 02.98	CS535	12 0.9
		PS, Chas. -NA29,-NE29,-N299,-N499,-N599	03.92- 08.94	CA5191R	14 65	03.92- 02.98	CS519	12 1.0
		Chas. S2500016-,-S5000001-,-S8000001-09.94- 02.98		CA11461R	14 70			
		Chas. -S2500015,-R5999999,-R8999999	03.92- 09.94	CA6471R	14 70			
	[X16SZ]		09.92- 08.94	CA6471R	14 70	09.92- 03.96	CS535	12 0.9
			08.94- 07.96	CA11461R	14 70	09.92- 07.96	CS519	12 1.0
		PS, Chas. P25...-P30...-P40...-P50...-P80...-09.92- 03.96		CA8611R	14 70			
		PS, Chas. -NA29,-NE29,-N299,-N499,-N599	09.92- 03.96	CA5191R	14 65			
		PS 09.92- 07.96		CA8611R	14 70			
		Chas. S2500016-,-S5000001-,-S8000001-08.94- 03.96		CA11461R	14 70			
		Chas. -S2500015,-R5999999,-R8999999	09.92- 08.94	CA6471R	14 70			
	[X16SZR]		09.91- 08.94	CA5141R	14 70	09.91- 06.93	CS535	12 0.9
			09.94- 08.00	CA11461R	14 70	09.95- 08.97	CS162	12 0.7
			09.95- 08.97	CA10531R	14 100	09.91- 08.00	CS519	12 1.0
		PS 09.92- 08.97		CA10531R	14 100			
		PS 09.92- 08.00		CA8611R	14 70			
		PS 09.95- 08.97		CA5191R	14 65			
Astra F 1.7 Diesel	[17D]		12.91- 08.94	CA5161R	14 70	08.92- 08.94	CS322	12 1.7
						12.91- 07.92	CS290	12 1.7
	[17DR]		12.91- 08.94	CA5161R	14 70	Eng. 14292840-07.92- 08.94	CS322	12 1.7
						Eng. -14292839	12.91- 07.92	CS290
						12.91- 07.92	CS290	12 1.7
Astra F 1.7 TD	[X17DTL]		08.94- 02.98	CA5161R	14 70	08.94- 08.00	CS322	12 1.7
			03.98- 08.00	CA14401R	14 70			
			03.98- 08.00	CA14731R	14 100			
Astra F 1.7 TDS	[17DT (TC4EE1)]		12.91- 01.98	JA8631R	14 70	Eng. 997453- 12.91- 02.98	JS1091	12 1.2
			04.96- 02.98	JA11721R	14 70	12.91- 03.96	JS753	12 1.4
		Chas. T2000001-04.96- 01.98		JA11721R	14 70			
	[X17DT (TC4EE1)]		04.96- 02.98	JA11721R	14 70	04.96- 02.98	JS1091	12 1.2
		AC 04.96- 02.98		JA13701R	14 100			
Astra F 1.8 16V	[18SE]		09.95- 09.96	CA10451R	14 120	09.95- 09.96	CS879	12 1.1
			09.95- 09.96	CA10531R	14 100			
			09.95- 09.96	CA8611R	14 70			
	[C18SEL]		09.95- 08.97	CA10451R	14 120	09.95- 08.97	CS879	12 1.1
			09.95- 08.97	CA10531R	14 100			
			09.95- 08.97	CA8611R	14 70			
Astra F 1.8 i 16V	[C18XE]		06.93- 02.98	CA10451R	14 120	09.93- 02.98	CS879	12 1.1
			09.93- 02.98	CA10531R	14 100			
			09.93- 02.98	CA8611R	14 70			
	[C18XEL]		07.94- 02.98	CA10451R	14 120	07.94- 02.98	CS879	12 1.1
			07.94- 02.98	CA10531R	14 100			
			07.94- 02.98	CA8611R	14 70			
	[X18XE]		09.95- 09.98	CA10451R	14 120	09.95- 09.98	CS879	12 1.1
			09.95- 09.98	CA10531R	14 100			
			09.95- 09.98	CA8611R	14 70			
Astra F 1.8 i	[C18NZ]		09.91- 02.98	CA10451R	14 120	09.91- 12.94	CS518	12 1.0 DR
			09.91- 02.98	CA10531R	14 100	09.91- 12.94	CS372	12 1.4 BO
		Chas. P250...-P300...- , P400...-P500...-P600... , P810...-	09.92- 02.98	CA8611R	14 70	01.95- 02.98	CS727	12 1.1
		Chas. -N299,-NA29,-09.91- 08.92		CA5171R	14 70			
		N429,-N529,-N629,- NE12.						
	[X18XE1]		03.98- 08.00	CA13911R	14 70	03.98- 08.00	CS1188	12 1.1
			03.98- 08.00	CA15811R	14 100	03.98- 08.00	CS1257	12 1.1
			03.98- 08.00	CA17651R	14 120			
Astra F 2.0 GSi 16V	[C20XE]		09.91- 02.98	CA10451R	14 120	09.91- 12.94	CS372	12 1.4 BO
			09.91- 02.98	CA10531R	14 100	09.91- 12.94	CS518	12 1.0 DR
			09.91- 02.98	CA6151R	14 70	01.95- 02.98	CS727	12 1.1
			09.91- 02.98	CA8611R	14 70			





Astra F 2.0 i 16V	[C20XE]	09.91- 02.98	CA1045IR	14 120	01.95- 02.98	CS727	12 1.1	
		09.91- 02.98	CA1053IR	14 100	09.91- 12.94	CS372	12 1.4 BO	
		09.91- 02.98	CA615IR	14 70	09.91- 12.94	CS518	12 1.0 DR	
		09.91- 02.98	CA861IR	14 70				
	[X20XEV]	01.95- 09.98	CA1053IR	14 100	01.95- 09.98	CS879	12 1.1	
		01.95- 09.98	CA861IR	14 70				
		PS 01.95- 09.98	CA861IR	14 70				
Astra F 2.0 i	[C20NE]	09.91- 02.98	CA1045IR	14 120	01.95- 02.98	CS727	12 1.1	
		09.91- 02.98	CA1053IR	14 100	09.91- 12.94	CS372	12 1.4 BO	
		Chas. P250.-,P300.-,P400.-,P500.-,P600.-,P810.-	09.92- 02.98	CA861IR	14 70	09.91- 12.94	CS518	12 1.0 DR
		Chas. P250.-, P300.-, P400.-, P500.-, P600.-, P810.-	09.92- 01.98	CA861IR	14 70			
		Chas. -N299.-, -NA29.-, N429.-, -N529.-, -N629.-, NE12.	09.91- 08.92	CA517IR	14 70			
		Chas. -N299.-, -NA29.-, NA29.-, -N429.-, -N529.-, -N629.-, NE12.	09.91- 08.92	CA517IR	14 70			
	[X20XER]	10.99- 08.00	CA1581IR	14 100	10.99- 08.00	CS879	12 1.1	
		10.99- 08.00	CA1765IR	14 120				
		10.99- 08.00	CA1821IR	14 120				
	[X20XEV]	03.98- 08.00	CA1391IR	14 70	03.98- 08.00	CS879	12 1.1	
	03.98- 08.00	CA1581IR	14 100					
	03.98- 08.00	CA1765IR	14 120					
Astra F 2.0 DTi	[X20DTH]	08.99- 08.00	CA1490IR	14 70	08.99- 08.00	CS976	12 2.0	
		08.99- 08.00	CA1501IR	14 100				
		08.99- 08.00	CA1577IR	14 120				
		A19 08.99- 08.00	CA1582IR	14 120				
Astra G 1.2 16V	[X12XE]	09.97- 09.03	CA1257IR	14 70	Chas. -22, -25, -26, -28, -09.97- 09.03 2B, -2H999999	CS519	12 1.0	
		09.97- 09.03	CA1561IR	14 100	09.97- 09.03	CS1257	12 1.1	
		Chas. 12000001-, 15000001-, 16000001-, 18000001-	09.97- 09.03	CA1747IR	14 70			
		Chas. 12000001-, 15000001-, 16000001-, 18000001-	09.97- 09.03	CA1748IR	14 100			
	[X12XE]	09.97- 09.03	CA1257IR	14 70	09.97- 09.03	CS519	12 1.0	
		09.97- 09.03	CA1561IR	14 100	09.97- 09.03	CS1257	12 1.1	
		Chas. 12000001-, 15000001-, 16000001-, 18000001-	09.97- 09.03	CA1747IR	14 70			
	Chas. 12000001-, 15000001-, 16000001-, 18000001-	09.97- 09.03	CA1748IR	14 100				
[Z12XE]	09.00- 09.03	CA1257IR	14 70	09.00- 09.03	CS1257	12 1.1		
	09.00- 09.03	CA1561IR	14 100					
	Chas. 12000001-, 15000001-, 16000001-, 18000001-	09.00- 09.03	CA1658IR	14 120				
	Chas. 12000001-, 15000001-, 16000001-, 18000001-	09.00- 09.03	CA1747IR	14 70				
	Chas. 12000001-, 15000001-, 16000001-, 18000001-	09.00- 09.03	CA1748IR	14 100				
Astra G 1.4 i 16V	[X14XE]	09.97- 09.00	CA1391IR	14 70	09.97- 09.00	CS1257	12 1.1	
		09.97- 09.00	CA1581IR	14 100	09.97- 09.00	CS519	12 1.0	
		Chas. 12257453-, 15257664-, 18131575-09.97- 09.00	09.97- 09.00	CA1821IR	14 120			
		Chas. -12257452-, -15257663-, -18131574	09.97- 09.00	CA1765IR	14 120			
	[Z14XE]	09.00- 06.04	CA1391IR	14 70	09.00- 06.04	CS1257	12 1.1	
		09.00- 06.04	CA1581IR	14 100	09.00- 06.04	CS519	12 1.0	
	Chas. 12257453-, 15257664-, 18131575-09.00- 06.04	09.00- 06.04	CA1821IR	14 120	09.00- 06.04	CS1183	12 0.9	
	Chas. -12257452-, -15257663-, -18131574	09.00- 06.04	CA1765IR	14 120				
Astra G 1.6	[Z16XEP]	03.03- 08.05	CA1833IR	14 120	03.03- 08.05	CS519	12 1.0	
					03.03- 08.05	CS1257	12 1.1	
Astra G 1.6 16V	[X16XEL]	09.97- 08.00	CA1391IR	14 70	09.97- 08.00	CS1257	12 1.1	
		09.97- 08.00	CA1581IR	14 100	09.97- 08.00	CS519	12 1.0	
		Chas. 12257453-, 15257664-, 18131575-09.97- 08.00	09.97- 08.00	CA1821IR	14 120			
		Chas. -12257452-, -15257663-, -18131574	09.97- 08.00	CA1765IR	14 120			
	[Z16XEP]	03.00- 02.05	CA1833IR	14 120	03.00- 02.05	CS519	12 1.0 VA	
				03.00- 02.05	CS1257	12 1.1 BO		
Astra G 1.6 i 16V	[X16XEL]	09.97- 08.00	CA1391IR	14 70	09.97- 08.00	CS519	12 1.0	
		09.97- 08.00	CA1581IR	14 100	09.97- 08.00	CS1257	12 1.1	
		Chas. 12257453-, 15257664-, 18131575-09.97- 08.00	09.97- 08.00	CA1821IR	14 120			
		Chas. -12257452-, -15257663-, -18131574	09.97- 08.00	CA1765IR	14 120			
	[Z16XE]	09.00- 08.05	CA1391IR	14 70	09.98- 01.04	CS519	12 1.0	
		09.00- 08.05	CA1581IR	14 100	09.00- 08.05	CS1257	12 1.1	
	Chas. 12257453-, 15257664-, 18131575-09.00- 08.05	09.00- 01.04	CA1765IR	14 120				
	Chas. -12257452-, -15257663-, -18131574	09.00- 08.05	CA1821IR	14 120				
	Chas. -12257452-, -15257663-, -18131574	09.00- 08.05	CA1765IR	14 120				
Astra G 1.6 i	[X16SZR]	09.97- 09.00	CA1391IR	14 70	Chas. -22, -25, -26, -28, -09.97- 09.00 2B, -2H999999	CS519	12 1.0	
		09.97- 09.00	CA1581IR	14 100	09.97- 09.00	CS1257	12 1.1	
		Chas. 12257453-, 15257664-, 18131575-09.97- 09.00	09.97- 09.00	CA1821IR	14 120			
		Chas. -12257452-, -15257663-, -18131574	09.97- 09.00	CA1765IR	14 120			
	[Z16SE]	09.00- 06.04	CA1391IR	14 70	Chas. -229...-259...-09.00- 01.04 269...-289...-2B9...- 2H999999	CS519	12 1.0	
	09.00- 06.04	CA1581IR	14 100	09.00- 06.04	CS1257	12 1.1		
	Chas. 12257453-, 15257664-, 18131575-09.00- 06.04	09.00- 06.04	CA1821IR	14 120				
	Chas. -12257452-, -15257663-, -18131574	09.00- 06.04	CA1765IR	14 120				
Astra G 1.6 Twinport	[Z16XEP]	03.03- 06.04	CA1833IR	14 120	03.03- 06.04	CS519	12 1.0	
		03.03- 06.04	CA1882IR	14 100	03.03- 06.04	CS1257	12 1.1	
Astra G 1.6	[Z16YNG]	09.02- 06.04	CA1391IR	14 70	09.02- 06.04	CS1257	12 1.1	
		09.02- 06.04	CA1581IR	14 100				



**OPEL** *Continued*

		09.02- 06.04	<b>CA1765IR</b>	14 120			
		09.02- 06.04	<b>CA1821IR</b>	14 120			
Astra G 1.7 CDTi	[Z17DTL]	03.03- 06.04	<b>JA1521IR</b>	14 100	03.03- 06.04	<b>JS1158</b>	12 1.4
Astra G 1.7 DTi 16V	[Y17DT]	09.00- 06.04	<b>JA1521IR</b>	14 100	09.00- 06.04	<b>JS1158</b>	12 1.4
		09.00- 06.04	<b>JA1526IR</b>	14 70			
		AC 09.00- 01.04	<b>JA1521IR</b>	14 100			
Astra G 1.7 TD	[X17DTL]	02.98- 08.00	<b>CA1440IR</b>	14 70	02.98- 08.00	<b>CS322</b>	12 1.7
		02.98- 08.00	<b>CA1473IR</b>	14 100			
Astra G 1.8 16V	[X18XE1]	09.97- 09.00	<b>CA1391IR</b>	14 70	09.97- 09.00	<b>CS1188</b>	12 1.1
		09.97- 09.00	<b>CA1581IR</b>	14 100	Chas. 6G000001- 02.98- 09.00	<b>CS1257</b>	12 1.1
	Chas. 12257453-, 15257664-, 18131575-	09.97- 09.00	<b>CA1821IR</b>	14 120			
	Chas. -12257452, -15257663, -18131574	09.97- 09.00	<b>CA1765IR</b>	14 120			
Astra G 1.8 i 16V	[X18XE1]	09.97- 09.00	<b>CA1391IR</b>	14 70	Chas. 6G000001- 09.97- 09.00	<b>CS1257</b>	12 1.1
		09.97- 09.00	<b>CA1581IR</b>	14 100	Chas. -Y2999999, Y599... 09.97- 09.00	<b>CS1188</b>	12 1.1
	Chas. 12257453-, 15257664-, 18131575-	09.97- 09.00	<b>CA1821IR</b>	14 120			
	Chas. -12257452, -15257663, -18131574	09.97- 09.00	<b>CA1765IR</b>	14 120			
	[Z18XE]	09.00- 08.05	<b>CA1391IR</b>	14 70	Chas. 12000001- 09.00- 02.05	<b>CS1257</b>	12 1.1
					22999999, 15000001- 25999999, 16000001- 26999999, 18000001- 28999999, 32000001- 35000001-, 36000001- ,38000001-, 3B000001- 34000001- Chas. -2B999999, - 09.00- 08.05	<b>CS1188</b>	12 1.1
	Chas. 12257453-, 15257664-, 18131575-	09.00- 08.05	<b>CA1821IR</b>	14 120			
	Chas. -12257452, -15257663, -18131574	09.00- 08.05	<b>CA1765IR</b>	14 120			
Astra G 2.0	[Z20LER]	11.02- 03.05	<b>CA1581IR</b>	14 100	11.02- 03.05	<b>CS879</b>	12 1.1
		11.02- 03.05	<b>CA1765IR</b>	14 120			
		11.02- 03.05	<b>CA1821IR</b>	14 120			
	[Z20LET]	09.02- 01.04	<b>CA1581IR</b>	14 100	09.02- 01.04	<b>CS879</b>	12 1.1
		09.02- 01.04	<b>CA1765IR</b>	14 120			
Astra G 2.0 OPC	[Z20LET]	09.01- 06.04	<b>CA1581IR</b>	14 100	09.01- 06.04	<b>CS879</b>	12 1.1
		09.01- 06.04	<b>CA1765IR</b>	14 120			
		09.01- 06.04	<b>CA1821IR</b>	14 120			
Astra G 2.0 16V	[X20XEV]	09.97- 06.04	<b>CA1391IR</b>	14 70	09.97- 06.04	<b>CS879</b>	12 1.1
		09.97- 06.04	<b>CA1581IR</b>	14 100			
		09.97- 06.04	<b>CA1765IR</b>	14 120			
		09.97- 06.04	<b>CA1821IR</b>	14 120			
	[Z20LET]	03.02- 08.05	<b>CA1581IR</b>	14 100	03.02- 08.05	<b>CS879</b>	12 1.1
Astra G 2.0 i 16V	[X20XER]	11.99- 09.02	<b>CA1581IR</b>	14 100	11.99- 09.02	<b>CS879</b>	12 1.1
		11.99- 09.02	<b>CA1765IR</b>	14 120			
		11.99- 09.02	<b>CA1821IR</b>	14 120			
	[X20XEV]	09.97- 01.04	<b>CA1391IR</b>	14 70	09.97- 01.04	<b>CS879</b>	12 1.1
		09.97- 01.04	<b>CA1581IR</b>	14 100			
		09.97- 01.04	<b>CA1765IR</b>	14 120			
		09.97- 01.04	<b>CA1821IR</b>	14 120			
Astra G 2.0 Turbo 16V	[Z20LER]	03.02-	<b>CA1581IR</b>	14 100	03.02-	<b>CS879</b>	12 1.1
	[Z20LET]	09.00- 02.05	<b>CA1581IR</b>	14 100	09.00- 02.05	<b>CS879</b>	12 1.1
		09.00- 02.05	<b>CA1821IR</b>	14 120			
Astra G 2.0 Diesel Di	[X20DTL]	03.98- 08.00	<b>CA1490IR</b>	14 70	03.98- 08.00	<b>CS976</b>	12 2.0
		03.98- 08.00	<b>CA1501IR</b>	14 100			
		03.98- 08.00	<b>CA1577IR</b>	14 120			
Astra G 2.0 Diesel	[X20DTL]	02.98- 08.00	<b>CA1490IR</b>	14 70	02.98- 08.00	<b>CS976</b>	12 2.0
		02.98- 08.00	<b>CA1501IR</b>	14 100			
		02.98- 08.00	<b>CA1577IR</b>	14 120			
	A19 03.98- 08.00		<b>CA1582IR</b>	14 120			
	[Y20DTL]	09.00- 06.04	<b>CA1490IR</b>	14 70	09.00- 06.04	<b>CS976</b>	12 2.0
		09.00- 06.04	<b>CA1501IR</b>	14 100			
		09.00- 06.04	<b>CA1577IR</b>	14 120			
	A19 09.00- 06.04		<b>CA1553IR</b>	14 150			
	A19 09.00- 01.04		<b>CA1582IR</b>	14 120			
Astra G 2.0 DTi 16V	[X20DTH]	03.98- 06.04	<b>CA1490IR</b>	14 70	03.98- 06.04	<b>CS976</b>	12 2.0
		03.98- 06.04	<b>CA1501IR</b>	14 100			
		03.98- 06.04	<b>CA1577IR</b>	14 120			
		A19 03.98- 06.04	<b>CA1582IR</b>	14 120			
	[Y20DTH]	09.00- 06.04	<b>CA1490IR</b>	14 70	09.00- 06.04	<b>CS976</b>	12 2.0
		09.00- 06.04	<b>CA1501IR</b>	14 100			
		09.00- 06.04	<b>CA1577IR</b>	14 120			
		A19 09.00- 06.04	<b>CA1582IR</b>	14 120			
Astra G 2.2 i 16V	[Z22SE]	09.00- 08.05	<b>CA1592IR</b>	14 100	Chas. -1B007894 09.00- 08.05	<b>CS1291</b>	12 1.8
		09.00- 08.05	<b>CA1740IR</b>	14 120	Chas. 1B007895- 09.00- 08.05	<b>CS1395</b>	12 1.4
Astra G 2.2 DTi	[Y22DTR]	09.01- 08.05	<b>CA1577IR</b>	14 120	09.01- 08.05	<b>CS976</b>	12 2.0
		09.01- 08.05	<b>CA1828IR</b>	14 140			
		A19 09.02- 01.05	<b>CA2067IR*</b>	14 140			
Astra H 1.2	[Z12XEP]	08.05-	<b>CA1747IR</b>	14 70	08.05-	<b>CS1257</b>	12 1.1
		08.05-	<b>CA1748IR</b>	14 100			
		08.05-	<b>CA1940IR</b>	14 100			
Astra H 1.2 GTC	[Z12XEP]	08.05-	<b>CA1747IR</b>	14 70	08.05-	<b>CS1257</b>	12 1.1
		08.05-	<b>CA1748IR</b>	14 100			
		08.05-	<b>CA1940IR</b>	14 100			
Astra H 1.3 CDTi	[Z13DTH]	08.05-	<b>CA1855IR</b>	14 75 VA	08.05-	<b>CS1334</b>	12 1.1
		08.05-	<b>CA1862IR</b>	14 90 VA			
		08.05-	<b>CA1934IR</b>	14 105			
		08.05-	<b>CA1935IR</b>	14 120			
Astra H 1.3 CDTi GTC	[Z13DTH]	01.06-	<b>CA1855IR</b>	14 75 VA	01.06-	<b>CS1334</b>	12 1.1
		01.06-	<b>CA1862IR</b>	14 90 VA			
		01.06-	<b>CA1934IR</b>	14 105			
		01.06-	<b>CA1935IR</b>	14 120			
Astra H 1.4	[Z14XEL]	04.04- 10.04	<b>CA1747IR</b>	14 70	04.04- 10.04	<b>CS1257</b>	12 1.1
		04.04- 10.04	<b>CA1748IR</b>	14 100			
		04.04- 10.04	<b>CA1940IR</b>	14 100			
		03.05-	<b>CA1658IR</b>	14 120			
		03.05-	<b>CA1862IR</b>	14 90			
	[Z14XEP]	03.04-	<b>CA1658IR</b>	14 120	03.04-	<b>CS519</b>	12 1.0
		03.04-	<b>CA1747IR</b>	14 70			
		03.04-	<b>CA1748IR</b>	14 100			



Astra H 1.4 Twinport GTC	[Z14XEP]	03.04-	CA1940IR	14 100				
		03.05-	CA1658IR	14 120		03.05-	CS519	12 1.0
		03.05-	CA1747IR	14 70				
		03.05-	CA1748IR	14 100				
Astra H 1.4 LPG	[Z14XEP]	03.05-	CA1940IR	14 100				
		08.09-	CA1747IR	14 70		08.09-	CS1257	12 1.1
		08.09-	CA1748IR	14 100				
Astra H 1.6	[Z16XEP]	03.04- 03.07	CA1833IR	14 120	Chas. -62097898, -03.04-65096746, -68071397		CS519	12 1.0
		03.04- 03.07	CA1882IR	14 100	Chas. 62097899-, 03.04-65096747-, 68071398-		CS1438	12 1.1
	[Z16XER]	12.06-	CA1833IR	14 120	Chas. -62097898, -03.04-65096746, -68071397		CS1257	12 1.1
		12.06-	CA1960IR	14 120		12.06-	CS1438	12 1.1
Astra H 1.6 Ecotec	[Z16XER]	02.07-	CA1833IR	14 120		02.07-	CS1438	12 1.1
Astra H 1.6 GTC	[Z16XER]	02.07-	CA1960IR	14 120				
Astra H 1.6 Turbo	[Z16XER]	12.06-	CA1833IR	14 120		12.06-	CS1438	12 1.1
Astra H 1.6 Turbo GTC	[Z16XER]	12.06-	CA1960IR	14 120				
Astra H 1.6 Turbo	[Z16LET]	02.07-	CA1973IR	14 120		02.07-	CS1438	12 1.1
Astra H 1.6 Turbo GTC	[Z16LET]	02.07-	CA1973IR	14 120		02.07-	CS1438	12 1.1
Astra H 1.6 Twinport	[Z16XEP]	08.04-	CA1833IR	14 120	Chas. -62097898, -08.04-65096746, -68071397		CS519	12 1.0
		08.04-	CA1882IR	14 100	Chas. 62097899-, 08.04-65096747-, 68071398-		CS1438	12 1.1
		08.04-	CA1882IR	14 100	Chas. -62097898, -08.04-65096746, -68071397		CS1257	12 1.1
Astra H 1.6 Twinport GTC	[Z16XEP]	03.05-	CA1833IR	14 120	Chas. -62097898, -03.05-65096746, -68071397		CS519	12 1.0
		03.05-	CA1882IR	14 100	Chas. 62097899-, 03.05-65096747-, 68071398-		CS1438	12 1.1
		03.05-	CA1882IR	14 100	Chas. -62097898, -03.05-65096746, -68071397		CS1257	12 1.1
		03.05-	CA1882IR	14 100				
Astra H 1.6 CNG	[Z16YNG]	11.05-	CA1765IR	14 120		11.05-	CS1257	12 1.1
Astra H 1.6 LPG	[Z16XER]	08.09-	CA1833IR	14 120		08.09-	CS1438	12 1.1
		08.09-	CA1960IR	14 120				
Astra H 1.7 CDTi	[A17DTJ]	02.07-	CA2010IR	14 100		02.07-	JS1158	12 1.4
		02.07-	CA2017IR	14 140				
	[A17DTR]	02.07-	CA2010IR	14 100		02.07-	JS1158	12 1.4
		02.07-	CA2017IR	14 140				
	[D17DTL]	AC 02.07-	CA2017IR	14 140				
		08.04-	JA1899IR	14 100		08.04-	JS1158	12 1.4
	[Z17DTH]	08.04-	JA1900IR	14 110				
		03.04-	JA1899IR	14 100		03.04-	JS1158	12 1.4
	[Z17DTJ]	AC 03.04-	JA1900IR	14 110				
		A39 03.04-	JA1900IR	14 110				
		02.07-	CA2010IR	14 100		02.07-	JS1158	12 1.4
	[Z17DTL]	02.07-	CA2017IR	14 140				
		AC 02.07-	CA2017IR	14 140				
03.04-		JA1899IR	14 100		03.04-	JS1158	12 1.4	
[Z17DTR]	AC 03.04-	JA1900IR	14 110					
	02.07-	CA2010IR	14 100		02.07-	JS1158	12 1.4	
	02.07-	CA2017IR	14 140					
Astra H 1.7 CDTi Ecotec	[Z17DTL]	AC 02.07-	CA2017IR	14 140				
		03.05- 03.07	JA1899IR	14 100		03.05- 03.07	JS1158	12 1.4
Astra H 1.7 CDTi GTC	[A17DTR]	AC 03.05- 03.07	JA1900IR	14 110				
		02.07-	CA2010IR	14 100		02.07-	JS1158	12 1.4
		AC 02.07-	CA2017IR	14 140				
[Z17DTH]	03.05-	JA1899IR	14 100		03.05-	JS1158	12 1.4	
	AC 03.05-	JA1900IR	14 110					
Astra H 1.7 CRDi	[Z17DTJ]	02.07-	CA2010IR	14 100		02.07-	JS1158	12 1.4
Astra H 1.8	[Z18XE]	02.07-	CA2017IR	14 140				
		03.04-	CA1765IR	14 120		03.04-	CS1257	12 1.1
	[Z18XER]	08.04-	CA1581IR	14 100				
		08.05-	CA1833IR	14 120		08.05-	CS1438	12 1.1
Astra H 1.8 Ecotec	[Z18XER]	08.05-	CA1882IR	14 100				
		Chas. 72094719-, 09.05-75086480-, 78048188-	CA1960IR	14 120				
		Chas. -72094718, -09.05-75086479, -78048187	CA1833IR	14 120				
Astra H 1.8 GTC	[Z18XER]	Chas. 72094719-, 02.07-75086480-, 78048188-	CA1960IR	14 120		02.07-	CS1438	12 1.1
		Chas. -72094718, -02.07-75086479, -78048187	CA1833IR	14 120				
		Chas. 72094719-, 01.06-75086480-, 78048188-	CA1960IR	14 120		01.06-	CS1438	12 1.1
Astra H 1.8 i GTC	[Z18XER]	Chas. -72094718, -01.06-75086479, -78048187	CA1833IR	14 120				
		03.05-	CA1391IR	14 70		03.05-	CS1257	12 1.1
Astra H 1.9 CDTi 16V	[Z19DTH]	03.05-	CA1581IR	14 100				
		03.05-	CA1765IR	14 120				
		Chas. 72172469-, 04.04-75189053-, 78104401-, 8B000001-	CA1994IR	14 140		04.04-	CS1428	12 1.7
		Chas. 72172469-, 04.04-75189053-, 78104401-, 8B000001-	CA2045IR	14 120				
		Chas. -72172468, -04.04-75189052, -78104400	CA1884IR	14 105				
		Chas. -72172468, -04.04-75189052, -78104400	CA1885IR	14 120				
Chas. -72172468, -04.04-75189052, -78104400	CA1890IR	14 130						



**OPEL Continued**

	[Z19DTJ]	Chas. 72172469-, 04.04-75189053-, 78104401-, 8B000001- Chas. 72172469-, 04.04-75189053-, 78104401-, 8B000001- Chas. -72172468, - 04.04-75189052, - 78104400 Chas. -72172468, - 04.04-75189052, - 78104400 Chas. -72172468, - 04.04-75189052, - 78104400	CA1994IR CA2045IR CA1884IR CA1885IR CA1890IR	14 140 14 120 14 105 14 120 14 130	04.04-	CS1428	12 1.7
Astra H 1.9 CDTi 16V GTC	[Z19DTH]	Chas. 72172469-, 03.05-75189053-, 78104401-, 8B000001- Chas. 72172469-, 03.05-75189053-, 78104401-, 8B000001- Chas. -72172468, - 03.05-75189052, - 78104400 Chas. -72172468, - 03.05-75189052, - 78104400 Chas. -72172468, - 03.05-75189052, - 78104400	CA1994IR CA2045IR CA1884IR CA1885IR CA1890IR	14 140 14 120 14 105 14 120 14 130	AT 03.05- 03.05-	CS1264 CS1428	12 1.7 12 1.7
	[Z19DTJ]	Chas. 72172469-, 03.05-75189053-, 78104401-, 8B000001- Chas. 72172469-, 03.05-75189053-, 78104401-, 8B000001- Chas. -72172468, - 03.05-75189052, - 78104400 Chas. -72172468, - 03.05-75189052, - 78104400 Chas. -72172468, - 03.05-75189052, - 78104400	CA1994IR CA2045IR CA1884IR CA1885IR CA1890IR	14 140 14 120 14 105 14 120 14 130	03.05-	CS1428	12 1.7
Astra H 1.9 CDTi	[Z19DT]	09.05-09.05- Chas. 72172469-, 09.05- Chas. 72172469-, 09.05- Chas. -72172468, - 09.05- Chas. -72172468, - 09.05-	CA1884IR CA1890IR CA1994IR CA2045IR CA1884IR CA1885IR CA1890IR	14 105 14 130 14 140 14 120 14 105 14 120 14 130	09.05-	CS1264	12 1.7
	[Z19DTH]	09.04-09.04- 09.04-09.04- 09.04-09.04- Chas. 72172469-, 09.04- Chas. 72172469-, 09.04- Chas. -72172468, - 09.04- Chas. -72172468, - 09.04- Chas. -72172468, - 09.04-	CA1884IR CA1890IR CA1994IR CA2045IR CA1994IR CA2045IR CA1884IR CA1885IR CA1890IR	14 105 14 130 14 140 14 120 14 140 14 120 14 105 14 120 14 130	09.04-AT 09.04-	CS1428 CS1264	12 1.7 12 1.7
	[Z19DTJ]	08.04-08.04- 08.04-08.04-	CA1884IR CA1890IR CA2045IR	14 105 14 130 14 120	08.04-	CS1428	12 1.7
Astra H 1.9 CDTi GTC	[Z19DT]	Chas. 72172469-, 09.05- Chas. 72172469-, 09.05- Chas. -72172468, - 09.05- Chas. -72172468, - 09.05- Chas. -72172468, - 09.05-	CA1994IR CA2045IR CA1884IR CA1885IR CA1890IR	14 140 14 120 14 105 14 120 14 130	09.05-	CS1264	12 1.7
	[Z19DTL]	Chas. 72172469-, 01.06- Chas. 72172469-, 01.06- Chas. -72172468, - 01.06- Chas. -72172468, - 01.06- Chas. -72172468, - 01.06-	CA1994IR CA2045IR CA1884IR CA1885IR CA1890IR	14 140 14 120 14 105 14 120 14 130	01.06-	CS1264	12 1.7
Astra H 2.0 Turbo	[Z20LEH]	03.05-	CA1909IR	14 120	03.05-	CS879	12 1.1
	[Z20LEL]	03.04-	CA1909IR	14 120	03.04-	CS879	12 1.1
	[Z20LER]	09.04-	CA1909IR	14 120	09.04-	CS879	12 1.1
Astra H 2.0 Turbo GTC	[Z20LEH]	08.05-	CA1909IR	14 120	08.05-	CS879	12 1.1
	[Z20LEL]	03.05-	CA1909IR	14 120	03.05-	CS879	12 1.1
	[Z20LER]	03.05-	CA1909IR	14 120	03.05-	CS879	12 1.1
Astra J 1.6	[A16XER]				10.10-	CS1438	12 1.1
Astra J 1.6 Ecotec	[A16XER]				12.09-	CS1438	12 1.1
Astra J 1.6 Turbo ecotec	[A16LET]				10.10-	CS1438	12 1.1
Astra J 1.7 CDTi 16V Ecotec	[A17DTJ]				10.10-	JS1158	12 1.4
	[A17DTR]				10.10-	JS1158	12 1.4
Astra J 1.8 GTC	[A18XER]				10.11-	CS1438	12 1.1
Astra J 2.0 GTC	[A20DTH]	10.11-	CA2005IR	14 100			
Astra J 2.0 CDTi	[A20DTH]	06.11-	CA2005IR	14 100			
Astra J 2.0 CDTi Ecotec	[A20DTH]	10.10-	CA2005IR	14 100	AT 10.10- 10.10-	CS1264 CS1428	12 1.7 12 1.7
Astra J 2.0 CDTi Sports Tourer	[A20DTH]	08.11-	CA2005IR	14 100			
Calibra A 2.0 i 16V	[C20XE]	06.90- 07.97 06.90- 08.91 09.91- 07.97 09.92- 07.97 09.92- 07.97 09.92- 07.97	CA515IR CA615IR CA517IR CA1045IR CA1053IR CA861IR	14 90 14 70 14 70 14 120 14 100 14 70	06.90- 12.94 06.90- 12.94 01.95- 03.97	CS372 CS518 CS727	12 1.4 BO 12 1.0 DR 12 1.1
	[X20XEVI]	11.93- 03.97 11.93- 03.97 11.93- 03.97	CA1045IR CA1053IR CA861IR	14 120 14 100 14 70	02.94- 07.97	CS879	12 1.1



Calibra A 2.0 i 16V 4x4	[C20XE]	06.90-07.97	<b>CA515IR</b>	14 90	06.90-12.94	<b>CS518</b>	12 1.0	DR	
		06.90-08.92	<b>CA615IR</b>	14 70	01.95-03.97	<b>CS727</b>	12 1.1		
		09.91-07.97	<b>CA517IR</b>	14 70	06.90-12.94	<b>CS372</b>	12 1.4	BO	
		09.92-07.97	<b>CA1045IR</b>	14 120					
		09.92-07.97	<b>CA1053IR</b>	14 100					
		09.92-07.97	<b>CA861IR</b>	14 70					
		[X20XE]	11.93-03.97	<b>CA1045IR</b>	14 120	02.94-07.97	<b>CS879</b>	12 1.1	
Calibra A 2.0 i Turbo 4x4	[C20LET]	11.93-03.97	<b>CA1053IR</b>	14 100					
		11.93-03.97	<b>CA861IR</b>	14 70					
		03.92-08.92	<b>CA515IR</b>	14 90	01.95-07.97	<b>CS727</b>	12 1.1		
		03.92-08.92	<b>CA615IR</b>	14 70	03.92-12.94	<b>CS372</b>	12 1.4	BO	
		09.92-03.97	<b>CA1045IR</b>	14 120	03.92-12.94	<b>CS518</b>	12 1.0	DR	
		09.92-03.97	<b>CA861IR</b>	14 70					
Calibra A 2.0 i	[C20NE]	06.90-07.97	<b>CA515IR</b>	14 90	AT 06.90-07.97	<b>CS727</b>	12 1.1		
		06.90-08.92	<b>CA517IR</b>	14 70	AT 06.90-07.97	<b>CS372</b>	12 1.4	BO	
		09.92-07.97	<b>CA1045IR</b>	14 120	06.90-07.97	<b>CS518</b>	12 1.0	DR	
		09.92-07.97	<b>CA1053IR</b>	14 100					
		09.92-07.97	<b>CA861IR</b>	14 70					
Calibra A 2.0 i 4x4	[C20NE]	06.90-07.97	<b>CA515IR</b>	14 90	AT 06.90-07.97	<b>CS372</b>	12 1.4	BO	
		06.90-08.92	<b>CA517IR</b>	14 70	06.90-07.97	<b>CS518</b>	12 1.0	DR	
		09.92-07.97	<b>CA1045IR</b>	14 120	AT 06.90-07.97	<b>CS727</b>	12 1.1		
		09.92-07.97	<b>CA1053IR</b>	14 100					
		09.92-07.97	<b>CA861IR</b>	14 70					
Calibra A 2.5 i V6	[C25XE]	04.93-07.97	<b>CA1051IR</b>	14 70	04.93-07.97	<b>CS802</b>	12 1.4		
		04.93-07.97	<b>CA1070IR</b>	14 120					
		04.93-07.97	<b>CA1103IR</b>	14 100					
	[X25XE]	04.93-07.97	<b>CA1051IR</b>	14 70	04.93-07.97	<b>CS802</b>	12 1.4		
		04.93-07.97	<b>CA1070IR</b>	14 120					
		04.93-07.97	<b>CA1103IR</b>	14 100					
Campo 2.2 Diesel	[C223]				08.87-09.96	<b>JS552</b>	12 2.0		
Campo 2.2 Diesel 4x4	[C223]				09.90-08.92	<b>JS552</b>	12 2.0		
					08.87-09.96	<b>JS552</b>	12 2.0		
Campo 2.3	[23P] [4ZD1]	08.94-09.96	<b>JA697IR#</b>	14 55					
		08.91-09.96	<b>JA1120IR#</b>	14 45					
		08.91-09.96	<b>JA697IR#</b>	14 55					
Campo 2.3 4x4	[4ZD1]	08.91-09.96	<b>JA1120IR#</b>	14 45					
		08.91-09.96	<b>JA697IR#</b>	14 55					
		08.94-09.96	<b>JA697IR#</b>	14 55					
Campo 2.5 Diesel	[4JA1]	09.91-11.95	<b>JA1290IR</b>	14 80	09.91-11.94	<b>JS639</b>	12 2.0		
		09.91-11.95	<b>JA761IR</b>	14 50	12.94-11.95	<b>JS999</b>	12 2.8		
Campo 2.5 DTi	[4JA1]	RHD 08.01-	<b>JA1290IR</b>	14 80	12.01-	<b>JS999</b>	12 2.8		
Campo 2.5 DTi 4x4	[4JA1]	RHD 08.01-	<b>JA1290IR</b>	14 80	12.01-	<b>JS999</b>	12 2.8		
Campo 2.5 TD	[4JA1]	02.89-08.97	<b>JA1290IR</b>	14 80	02.89-08.97	<b>JS999</b>	12 2.8		
		02.89-08.97	<b>JA761IR</b>	14 50					
	[4JA1T]	10.89-08.01	<b>JA1290IR</b>	14 80	10.89-08.01	<b>JS999</b>	12 2.8		
		10.89-08.01	<b>JA761IR</b>	14 50					
	Campo 2.5 TD 4x4	[4JA1] [4JA1T]	08.91-06.94	<b>JA1290IR</b>	14 80	02.89-08.97	<b>JS999</b>	12 2.8	
			07.94-08.01	<b>JA1290IR</b>	14 80	07.94-08.01	<b>JS999</b>	12 2.8	
07.94-08.01			<b>JA761IR</b>	14 50					
Campo 3.1 TD	[4JG2T]	12.92-08.97	<b>JA761IR</b>	14 50	12.92-08.97	<b>JS639</b>	12 2.0		
		03.97-08.02	<b>JA873IR</b>	14 60	03.97-08.02	<b>JS999</b>	12 2.8		
		12.92-07.95	<b>JA761IR</b>	14 50	10.94-	<b>JS999</b>	12 2.8		
Combo 1.2 i	[C12NZ]	PS, Chas. S6000013-07.94-10.01	<b>CA1231IR</b>	14 55	07.94-09.97	<b>CS519</b>	12 1.0		
		PS, Chas. S6000013-07.94-10.01	<b>CA861IR</b>	14 70	09.97-10.01	<b>CS1257</b>	12 1.1		
		Chas. S6000013-07.94-10.01	<b>CA1066IR</b>	14 55					
		Chas. S6000013-07.94-10.01	<b>CA1146IR</b>	14 70					
		Chas. -S6000012 07.94-10.01	<b>CA513IR</b>	14 55					
		Chas. -S6000012 07.94-10.01	<b>CA514IR</b>	14 70					
	[X12SZ]	PS, Chas. S6000013-07.94-10.01	<b>CA1053IR</b>	14 100	08.97-10.01	<b>CS1257</b>	12 1.1		
		PS, Chas. S6000013-07.94-10.01	<b>CA1231IR</b>	14 55	07.94-08.97	<b>CS519</b>	12 1.0		
		PS, Chas. S6000013-07.94-10.01	<b>CA861IR</b>	14 70					
		Chas. S6000013-07.94-10.01	<b>CA1066IR</b>	14 55					
		Chas. -S6000012 07.94-10.01	<b>CA892IR</b>	14 55					
Combo 1.3 CDTi 16V	[Z13DT] [Z13DTJ]	09.04-	<b>CA1855IR</b>	14 75	09.04-	<b>CS1334</b>	12 1.1		
		09.04-	<b>CA1862IR</b>	14 90					
Combo 1.3 CDTi 16V Tour	[Z13DT]	09.04-	<b>CA1855IR</b>	14 75	09.04-	<b>CS1334</b>	12 1.1		
		10.04-	<b>CA1862IR</b>	14 90					
Combo 1.4	[C14NZ]	07.94-03.96	<b>CA1045IR</b>	14 120	07.94-03.96	<b>CS535</b>	12 0.9		
		07.94-03.96	<b>CA99IR</b>	14 55	07.94-03.96	<b>CS519</b>	12 1.0		
		PS 07.94-03.96	<b>CA861IR</b>	14 70					
		Chas. S6000013-07.94-03.96	<b>CA1066IR</b>	14 55					
		AT 07.94-03.96	<b>CA1146IR</b>	14 70					
		AT 07.94-03.96	<b>CA353IR</b>	14 65					
	[X14SZ]	AC, Chas. R4000001-07.94-03.96	<b>CA861IR</b>	14 70					
		AC 07.94-03.96	<b>CA99IR</b>	14 55					
		07.94-03.96	<b>CA1045IR</b>	14 120	04.96-10.01	<b>CS1257</b>	12 1.1		
		07.94-03.96	<b>CA99IR</b>	14 55					
		PS 07.94-03.96	<b>CA861IR</b>	14 70					
		Chas. S6000013-07.94-03.96	<b>CA1066IR</b>	14 55					
Combo 1.4 i	[C14SE]	AT 07.94-03.96	<b>CA1146IR</b>	14 70					
		AT 07.94-03.96	<b>CA353IR</b>	14 65					
		AC, Chas. R4000001-07.94-03.96	<b>CA861IR</b>	14 70					
		AC 07.94-03.96	<b>CA99IR</b>	14 55					
		07.94-03.96	<b>CA1045IR</b>	14 120					
		07.94-03.96	<b>CA99IR</b>	14 55					
	[Z14XEP]	PS 07.94-03.96	<b>CA861IR</b>	14 70					
		Chas. S6000013-07.94-03.96	<b>CA1066IR</b>	14 55					
		AT 07.94-03.96	<b>CA1146IR</b>	14 70					
		AT 07.94-03.96	<b>CA353IR</b>	14 65					
		AC, Chas. R4000001-07.94-03.96	<b>CA861IR</b>	14 70					
		AC 07.94-03.96	<b>CA99IR</b>	14 55					
Combo 1.4 Tour	[Z14XEP]	10.04-	<b>CA1658IR</b>	14 120	10.04-	<b>CS519</b>	12 1.0		
		10.04-	<b>CA1747IR</b>	14 70					
		10.04-	<b>CA1748IR</b>	14 100					
Combo 1.4 16V	[X14XE]	08.99-10.01	<b>CA1053IR</b>	14 100	08.99-10.01	<b>CS519</b>	12 1.0		
		08.99-10.01	<b>CA1231IR</b>	14 55					
		08.99-10.01	<b>CA861IR</b>	14 70					
	[Z14XEP]	08.05-	<b>CA1658IR</b>	14 120	08.05-	<b>CS519</b>	12 1.0		
		08.05-	<b>CA1747IR</b>	14 70					
		08.05-	<b>CA1748IR</b>	14 100					
Combo 1.4 i	[C14SE]	07.94-10.01	<b>CA1066IR</b>	14 55	07.94-08.97	<b>CS535</b>	12 0.9		
		PS 07.94-10.01	<b>CA1231IR</b>	14 55	08.97-10.01	<b>CS1257</b>	12 1.1		
		PS 07.94-10.01	<b>CA861IR</b>	14 70	07.94-08.97	<b>CS519</b>	12 1.0		
		AC 07.94-10.01	<b>CA1045IR</b>	14 120					
		AC 07.94-10.01	<b>CA861IR</b>	14 70					
Combo 1.6	[Z16SE]	10.01-08.04	<b>CA1391IR</b>	14 70	10.01-08.04	<b>CS1257</b>	12 1.1		
		10.01-08.04	<b>CA1571IR#</b>	14 115					
		10.01-08.04	<b>CA1581IR</b>	14 100					



**OPEL** *Continued*

Combo 1.6 16V	[Z16YNG]	06.06-	CA1765IR	14 120		06.06-	CS1257	12 1.1	
Combo 1.6 16V Tour	[Z16YNG]	06.06-	CA1581IR	14 100		06.06-	CS1257	12 1.1	
		06.06-	CA1765IR	14 120					
		06.06-	CA1821IR	14 120					
Combo 1.6 CNG	[Z16YNG]	04.05-	CA1765IR	14 120		04.05-	CS1257	12 1.1	
Combo 1.7 CDTi 16V	[Z17DTH]	12.04-	JA1901IR	14 100		12.04-	JS1158	12 1.4	
		12.04-	JA1901IR	14 100		12.04-	JS1158	12 1.4	
Combo 1.7 CDTi 16V Tour	[Z17DTH]	12.04-	JA1901IR	14 100		12.04-	JS1158	12 1.4	
		AC 12.04-	JA1900IR	14 110					
Combo 1.7 Diesel 16V	[Y17DTL]	10.01- 08.04	JA1521IR	14 100		10.01- 08.04	JS1158	12 1.4	
		10.01- 08.04	JA1526IR	14 70					
Combo 1.7 Diesel	[17D (4EE1)]	Eng. 00975025- 07.94- 10.01	JA1172IR	14 70		07.94- 10.01	JS941	12 1.4	
		Eng. -00975024 07.94- 10.01	JA863IR	14 70					
	AC 04.96- 10.01	JA1370IR	14 100						
	[X17D (4EE1)]	Eng. 00975025- 04.96- 10.01	JA1172IR	14 70		04.96- 10.01	JS941	12 1.4	
		Eng. -00975024 04.96- 10.01	JA863IR	14 70					
		AC 04.96- 10.01	JA1370IR	14 100					
Combo 1.7 DTi 16V	[Y17DT]	10.01-	JA1521IR	14 100		10.01- 08.04	JS1158	12 1.4	
		10.01- 08.04	JA1526IR	14 70					
		AC 10.01- 08.04	JA1521IR	14 100					
Commodore A 2.5	[25S]					08.67- 08.69	CS80	12 1.0	
Commodore A 2.5 GS	[25H]					08.67- 01.72	CS80	12 1.0	
Commodore B 2.5	[25S]	02.75- 07.78	CA42IR	14 55		01.72- 07.78	CS80	12 1.0	
Commodore B 2.5 GS	[25H]	01.72- 08.75	CA42IR	14 55		01.72- 08.75	CS80	12 1.0	
Commodore B 2.6	[25S]	10.76- 07.78	CA42IR	14 55		01.72- 07.78	CS80	12 1.0	
Commodore B 2.8 GS	[28HC]	10.76- 07.78	CA42IR	14 55		01.72- 07.78	CS80	12 1.0	
Commodore B 2.8 GS/E	[28E]					07.72- 02.75	CS80	12 1.0	
	[28EC]					07.72- 02.75	CS80	12 1.0	
	[28HC]	03.75- 07.78	CA42IR	14 55		03.75- 07.78	CS80	12 1.0	
	[25S]	08.78- 12.82	CA42IR	14 55		08.78- 12.82	CS80	12 1.0	
Commodore C 2.5	[25S]	06.80- 12.82	CA221IR	14 65					
		12.80- 12.82	CA221IR	14 65		12.80- 12.82	CS80	12 1.0	
Commodore C 2.5 E	[25E]	12.80- 12.82	CA42IR	14 55					
		12.80- 12.82	CA42IR	14 55					
Corsa A 1.0	[10S]	09.82- 08.94	CA128IR	14 45		09.82- 08.88	CS80	12 1.0	
		09.82- 08.94	CA42IR	14 55		09.82- 08.94	CS66	12 0.65	
		09.82- 08.94	CA99IR	14 55					
		RHD 09.82- 08.94	CA99IR	14 55					
Corsa A 1.0 S	[10S]	09.82- 08.94	CA128IR	14 45		09.82- 08.94	CS80	12 1.0	
		09.82- 08.94	CA42IR	14 55		09.82- 08.94	CS66	12 0.65	
		RHD 09.82- 08.94	CA99IR	14 55					
Corsa A 1.2	[12 S]	09.82- 08.90	CA128IR	14 45		09.82- 08.90	CS162	12 0.7	
		09.82- 08.90	CA514IR	14 70		09.82- 08.90	CS1183	12 0.9	
	[12NC]	01.85- 12.86	CA128IR	14 45		01.85- 12.86	CS66	12 0.65	
		01.85- 12.86	CA353IR	14 65		01.85- 12.86	CS80	12 1.0	
		01.85- 12.86	CA99IR	14 55					
	[12NV]	09.86- 08.88	CA353IR	14 65		09.86- 03.93	CS162	12 0.7	
		09.86- 08.94	CA42IR	14 55		09.86- 03.93	CS519	12 1.0	
		09.86- 08.88	CA99IR	14 55		09.86- 03.93	CS535	12 0.9	
		09.88- 03.93	CA513IR	14 55					
	[12ST]	09.88- 03.93	CA514IR	14 70					
		02.86- 08.86	CA128IR	14 45		02.86- 08.88	CS162	12 0.7	
02.86- 08.88		CA353IR	14 65		02.86- 04.89	CS535	12 0.9		
[E12GV]	02.86- 08.88	CA99IR	14 55		02.86- 04.89	CS519	12 1.0		
	09.88- 04.89	CA514IR	14 70						
Corsa A 1.2 i	[12NC]	01.87- 08.94	CA128IR	14 45		01.87- 08.94	CS66	12 0.65	
		01.87- 08.94	CA353IR	14 65		01.87- 08.94	CS80	12 1.0	
		01.87- 08.94	CA42IR	14 55					
		01.87- 08.94	CA513IR	14 55					
		01.87- 08.94	CA514IR	14 70					
		01.87- 08.94	CA99IR	14 55					
	[C12NZ]	09.82- 08.86	CA128IR	14 45		01.85- 08.88	CS80	12 1.0	
		09.82- 08.88	CA99IR	14 55		01.85- 03.93	CS66	12 0.65	
		09.84- 08.88	CA353IR	14 65					
		09.88- 03.93	CA513IR	14 55					
		09.88- 03.93	CA514IR	14 70					
[E12GV]	09.89- 03.93	CA513IR	14 55		09.89- 03.93	CS162	12 0.7		
	09.89- 03.93	CA514IR	14 70		09.89- 03.93	CS535	12 0.9		
					09.89- 03.93	CS519	12 1.0		
	01.87- 03.93	CA513IR	14 55		01.87- 03.93	CS66	12 0.65		
	01.85- 12.86	CA128IR	14 45		01.85- 12.86	CS66	12 0.65		
Corsa A 1.2 N	[12NC]	01.85- 12.86	CA42IR	14 55		01.85- 12.86	CS80	12 1.0	
		01.85- 12.86	CA42IR	14 55					
Corsa A 1.2 S	[12S]	09.82- 08.94	CA128IR	14 45		09.82- 08.94	CS535	12 0.9	
		09.82- 08.88	CA353IR	14 65		09.82- 08.94	CS162	12 0.7	
		09.82- 08.94	CA513IR	14 55		09.82- 08.94	CS519	12 1.0	
		09.82- 08.94	CA514IR	14 70					
[12ST]	09.82- 08.94	CA99IR	14 55						
	09.82- 08.86	CA128IR	14 45		09.82- 03.93	CS535	12 0.9		
	09.82- 08.88	CA353IR	14 65		09.82- 03.93	CS162	12 0.7		
	09.82- 08.88	CA99IR	14 55		09.82- 03.93	CS519	12 1.0		
	09.88- 03.93	CA513IR	14 55						
Corsa A 1.3	[13NB]	09.88- 03.93	CA514IR	14 70					
		02.86- 10.99	CA128IR	14 45		02.86- 10.99	CS535	12 0.9	
		02.86- 08.88	CA353IR	14 65		02.86- 10.99	CS519	12 1.0	
		02.86- 10.99	CA99IR	14 55		02.86- 10.99	CS162	12 0.7	
		03.86- 10.99	CA513IR	14 55					
		03.86- 10.99	CA514IR	14 70					
[13SB]	09.82- 08.86	CA128IR	14 45		09.82- 03.93	CS519	12 1.0		
	09.82- 08.88	CA535IR	14 105		09.82- 03.93	CS535	12 0.9		
	09.82- 08.88	CA99IR	14 55		09.82- 03.93	CS162	12 0.7		
	09.88- 03.93	CA513IR	14 55						
	09.88- 03.93	CA514IR	14 70						
Corsa A 1.3 i	[13NB]	09.85- 08.86	CA128IR	14 45		09.85- 03.93	CS535	12 0.9	
		09.85- 08.88	CA353IR	14 65		09.85- 03.93	CS519	12 1.0	
		09.85- 08.88	CA99IR	14 55		09.85- 03.93	CS162	12 0.7	
		09.88- 03.93	CA513IR	14 55					
		09.88- 03.93	CA514IR	14 70					
		[C13N]	09.85- 12.92	CA128IR	14 45		09.85- 12.92	CS519	12 1.0
		09.85- 08.88	CA353IR	14 65		09.85- 12.92	CS535	12 0.9	
[C13N]	09.85- 12.92	CA99IR	14 55		09.85- 12.92	CS162	12 0.7		
	09.88- 12.92	CA513IR	14 55						
	09.88- 12.92	CA514IR	14 70						
	09.82- 09.94	CA128IR	14 45		09.82- 09.94	CS162	12 0.7		
Corsa A 1.3 S	[13SB]	09.82- 08.88	CA353IR	14 65		09.82- 09.94	CS519	12 1.0	
		09.82- 09.94	CA513IR	14 55		09.82- 09.94	CS535	12 0.9	
		09.82- 09.94	CA514IR	14 70					



			09.82- 09.94	CA991R	14 55				
Corsa A 1.4 i	[C14NZ]		10.89- 03.93	CA5131R	14 55	10.89- 03.93	CS162	12 0.7	
			10.89- 03.93	CA5141R	14 70	01.90- 03.93	CS535	12 0.9	
						01.90- 03.93	CS519	12 1.0	
	[C14SE]		09.91- 03.93	CA6471R	14 70	09.91- 03.93	CS535	12 0.9	
			09.91- 03.93	CA8921R	14 55	09.91- 03.93	CS519	12 1.0	
Corsa A 1.4 S	[14NV]		09.89- 03.93	CA5131R	14 55	09.89- 03.93	CS519	12 1.0	
			09.89- 03.93	CA5141R	14 70	01.90- 03.93	CS535	12 0.9	
						01.90- 03.93	CS162	12 0.7	
Corsa A 1.5 Diesel	[15D (4EC1)]	Chas. M4000001-	06.87- 03.93	JA8711R	14 70	06.87- 03.93	JS651	12 1.4	
		Chas. -L4999999	06.87- 03.93	JA6731R	14 70				
Corsa A 1.5 TD	[15DT (T4EC1)]	Chas. M4000001-	10.87- 03.93	JA8711R	14 70	10.87- 03.93	JS753	12 1.4	
		Chas. -L4999999	10.87- 03.93	JA6731R	14 70				
Corsa A 1.6 GSi	[C16NZ]		08.88- 09.92	CA5131R	14 55	08.88- 09.92	CS519	12 1.0	
			08.88- 09.92	CA5141R	14 70				
		05.88- 03.93	CA5131R	14 55	05.88- 03.93	CS535	12 0.9		
		05.88- 03.93	CA5141R	14 70	05.88- 03.93	CS519	12 1.0		
		09.89- 03.93	CA5131R	14 55	09.89- 03.93	CS519	12 1.0		
		09.89- 03.93	CA5141R	14 70	09.89- 03.93	CS535	12 0.9		
		05.88- 08.88	CA3531R	14 65	05.88- 03.93	CS535	12 0.9		
		05.88- 08.88	CA991R	14 55	05.88- 03.93	CS519	12 1.0		
		09.88- 03.93	CA5131R	14 55					
		09.88- 03.93	CA5141R	14 70					
Corsa B 1.0 i 12V	[X10XE]		09.96- 08.99	CA12571R	14 70	09.96- 08.99	CS519	12 1.0	
			09.96- 08.99	CA13291R	14 55				
Corsa B 1.2 i 16V	[X12XE]		09.97- 09.00	CA12571R	14 70	09.97- 09.00	CS519	12 1.0	
			09.97- 09.00	CA13291R	14 55				
Corsa B 1.2 i	[12NZ]		03.93- 09.00	CA10661R	14 55	09.94- 09.00	CS1257	12 1.1	
			03.93- 09.00	CA11461R	14 70	03.93- 09.00	CS519	12 1.0	
			03.93- 09.00	CA5131R	14 55				
			03.93- 09.00	CA5141R	14 70				
			03.93- 09.00	CA8611R	14 70				
			PS 03.93- 09.00	CA12311R	14 55				
	[C12NZ]		03.93- 09.94	CA991R	14 55	03.93- 09.00	CS519	12 1.0	
			09.94- 09.00	CA10661R	14 55				
			09.94- 09.00	CA11461R	14 70				
			PS 09.94- 09.00	CA12311R	14 55				
			AT 03.93- 09.00	CA8611R	14 70				
			AT 09.94- 09.00	CA3531R	14 65				
		ACPS 09.94- 09.00	CA8611R	14 70					
[X12SZ]		03.93- 09.94	CA991R	14 55	03.93- 09.00	CS519	12 1.0		
		09.94- 09.00	CA10661R	14 55					
		PS 09.94- 09.00	CA12311R	14 55					
		AT 03.93- 09.00	CA8611R	14 70					
		ACPS 09.94- 09.00	CA8611R	14 70					
Corsa B 1.4 i 16V	[C14SEL]		08.97- 09.00	CA10531R	14 100	08.97- 09.00	CS519	12 1.0	
			08.97- 09.00	CA12311R	14 55				
			08.97- 09.00	CA8611R	14 70				
	[X14XE]		09.94- 08.99	CA10451R	14 120	09.94- 08.99	CS535	12 0.9	
			09.94- 08.99	CA10531R	14 100	09.94- 08.99	CS519	12 1.0	
		09.94- 08.99	CA12311R	14 55					
		09.94- 08.99	CA8611R	14 70					
Corsa B 1.4 i	[C14NZ]		03.93- 09.00	CA10531R	14 100	03.93- 09.00	CS519	12 1.0	
			03.93- 09.00	CA10661R	14 55	03.93- 09.00	CS535	12 0.9	
			PS 09.93- 09.00	CA12311R	14 55				
			AT 03.93- 09.00	CA5141R	14 70				
			AT 09.94- 03.96	CA11461R	14 70				
			ACPS 09.94- 09.00	CA8611R	14 70				
			AC 03.93- 03.96	CA10451R	14 120				
			AC 09.93- 09.00	CA10531R	14 100				
	[X14SZ]		09.96- 09.00	CA10531R	14 100	08.99- 09.00	CS519	12 1.0	
			09.96- 09.00	CA10661R	14 55	09.96- 09.00	CS1257	12 1.1	
		09.96- 09.00	CA11461R	14 70					
		PS 09.96- 09.00	CA12311R	14 55					
		ACPS 09.96- 09.00	CA8611R	14 70					
Corsa B 1.4 Si	[C14SE]		03.93- 09.00	CA10451R	14 120	03.93- 09.00	CS535	12 0.9	
			03.93- 09.00	CA10661R	14 55	03.93- 09.00	CS519	12 1.0	
			03.93- 09.00	CA8611R	14 70				
			PS 09.93- 09.00	CA12311R	14 55				
			ACPS 03.93- 09.00	CA8611R	14 70				
		AC 09.93- 09.00	CA10531R	14 100					
Corsa B 1.5 Diesel	[15D (4EC1)]		03.93- 09.00	JA8631R	14 70	Eng. 877696- 03.93- 09.00	JS941	12 1.4	
			09.94- 09.00	JA11721R	14 70	Eng. -00877695 03.93- 09.00	JS651	12 1.4	
Corsa B 1.5 TD	[15DT (T4EC1)]	Eng. 00975025-	03.93- 09.00	JA11721R	14 70	Chas. 877696- 03.93- 09.00	JS941	12 1.4	
		Eng. -00975024	03.93- 09.00	JA8631R	14 70	Chas. -00877695 03.93- 09.00	JS651	12 1.4	
	[X15DT (T4EC1)]	Eng. 00975025-	04.96- 09.00	JA11721R	14 70	Chas. -00877695 04.96- 09.00	JS651	12 1.4	
		Eng. -00975024	04.96- 09.00	JA8631R	14 70	Chas. 877696- 04.96- 09.00	JS941	12 1.4	
Corsa B 1.6 GSi 16V	[C16XE]		03.93- 09.00	CA10531R	14 100	03.93- 09.00	CS519	12 1.0	
			03.93- 09.00	CA8611R	14 70	03.93- 09.00	CS535	12 0.9	
Corsa B 1.6 i 16V	[C16SEL]		08.97- 09.00	CA10531R	14 100	08.97- 09.00	CS519	12 1.0	
			08.97- 09.00	CA8611R	14 70				
	[X16XE]		03.93- 09.00	CA10531R	14 100	03.93- 09.00	CS535	12 0.9	
		03.93- 09.00	CA8611R	14 70	03.93- 09.00	CS519	12 1.0		
Corsa B 1.7 Diesel	[17D (4EE1)]		08.99- 09.00	JA11721R	14 70	Eng. -00877695 03.93- 09.00	JS651	12 1.4	
			Eng. -975024	03.93- 09.00	JA8631R	14 70	Eng. 877696- 02.96- 09.00	JS941	12 1.4
	[X17D (4EE1)]		02.96- 09.00	JA11721R	14 70	Eng. 877696- 02.96- 09.00	JS941	12 1.4	
					Eng. -00877695 02.96- 09.00	JS651	12 1.4		
Corsa C 1.0 Twinport	[Z10XEP]		06.03-	CA16581R	14 120	06.03-	CS519	12 1.0	
			06.03-	CA17471R	14 70	06.03-	CS1257	12 1.1	
Corsa C 1.0 i 12V	[Z10XE]		09.00-	CA12571R	14 70	Chas. -19P00893 09.00-	CS519	12 1.0	
			09.00-	CA15611R	14 100	Chas. 19P00894- 09.00-	CS1257	12 1.1	
		Chas. 23000001-, 24000001-, 26000001-	09.00-	CA17471R	14 70				
		Chas. 23000001-, 24000001-, 26000001-	09.00-	CA17481R	14 100				
Corsa C 1.2	[Z12XEP]		07.05-	CA17481R	14 100	07.05-	CS1257	12 1.1	
Corsa C 1.2 Twinport	[Z12XEP]		07.04-	CA17481R	14 100	07.04-	CS519	12 1.0	
Corsa C 1.2 i 16V	[Z12XE]		09.00-	CA12571R	14 70	09.00-	CS519	12 1.0	
			09.00-	CA15611R	14 100	09.00-	CS1257	12 1.1	
			09.00-	CA16581R	14 120				
			Chas. 23000001-, 24000001-, 26000001-	09.00-	CA17471R	14 70			
			Chas. 23000001-, 24000001-, 26000001-	09.00-	CA17481R	14 100			
			08.05-	CA18551R	14 75	08.05-	CS1334	12 1.1	
	08.05-	CA18621R	14 90						
		08.05-	CA19341R	14 105					
		08.05-	CA19351R	14 120					

**OPEL Continued**

Corsa C 1.3 CDTi	[Z13DT]	06.03-	CA1855IR	14 75	06.03-	CS1334	12 1.1
		06.03-	CA1862IR	14 90			
		06.03-	CA1934IR	14 105			
		06.03-	CA1935IR	14 120			
Corsa C 1.4	[Z14XEP]	08.03-	CA1658IR	14 120	08.03-	CS1257	12 1.1
		08.03-	CA1747IR	14 70			
Corsa C 1.4 i 16V	[Z14XE]	09.00-	CA1391IR	14 70	09.00-	CS519	12 1.0
		09.00-	CA1581IR	14 100			
	[Z14XEP]	09.00-	CA1821IR	14 120	09.00-	CS1257	12 1.1
		09.03-	CA1658IR	14 120			
		09.03-	CA1747IR	14 70	09.03-	CS1257	12 1.1
		09.03-	CA1747IR	14 70			
Corsa C 1.4 Twinport	[Z14XEP]	06.03- 08.05	CA1658IR	14 120	06.03-	CS519	12 1.0
		06.03- 08.05	CA1747IR	14 70			
Corsa C 1.7 CDTi	[Z17DTH]	06.03-	JA1901IR	14 100	09.03-	JS1158	12 1.4
Corsa C 1.7 CDTi SE	[Z17DTH]	08.03- 09.06	JA1900IR	14 110	08.03- 09.06	JS1158	12 1.4
		08.03- 09.06	JA1901IR	14 100			
Corsa C 1.7 Diesel 16V	[Y17DTL]	09.00-	JA1526IR	14 70	09.00-	JS1158	12 1.4
		AC 09.00-	JA1521IR	14 100			
Corsa C 1.7 DT	[Y17DTL]	09.00-	JA1526IR	14 70	09.00-	JS1158	12 1.4
		AC 09.00-	JA1521IR	14 100			
Corsa C 1.7 DTi 16V	[Y17DT]	09.00-	JA1526IR	14 70	09.00-	JS1158	12 1.4
		AC 09.00-	JA1521IR	14 100			
Corsa C 1.7 DTi	[Y17DT]	09.00-	JA1526IR	14 70	09.00-	JS1158	12 1.4
		AC 09.00-	JA1521IR	14 100			
Corsa C 1.8 i 16V	[Z18XE]	09.00-	CA1391IR	14 70	09.00-	CS1257	12 1.1
		09.00-	CA1581IR	14 100			
		09.00-	CA1821IR	14 120			
Corsa D 1.0	[A10XEP]	01.10-	CA1940IR	14 100	01.10-	CS1257	12 1.1
		01.10-	CA2046IR*	14 70			
	[Z10XEP]	07.06-	CA1940IR	14 100	07.06-	CS1257	12 1.1
		07.06-	CA2046IR*	14 70			
Corsa D 1.2	[A12XEL]	06.10-	CA1940IR	14 100	06.10-	CS1257	12 1.1
		06.10-	CA2046IR*	14 70			
	[A12XER]	06.10-	CA1940IR	14 100	06.10-	CS1257	12 1.1
		06.10-	CA2046IR*	14 70			
[Z12XEP]	07.06-	CA1940IR	14 100	07.06-	CS1257	12 1.1	
	07.06-	CA2046IR*	14 70				
Corsa D 1.2 ecoFlex	[Z12XEP]	09.09-	CA1940IR	14 100	09.09-	CS1257	12 1.1
		09.09-	CA2046IR*	14 70			
Corsa D 1.3 CDTi	[A13DTC,Z13DTH]	07.06-	CA1955IR	14 70			
		07.06-	CA1956IR	14 100			
		07.06-	CA1987IR	14 120			
	[A13DTR]	06.10-	CA1955IR	14 70			
		06.10-	CA1956IR	14 100			
		06.10-	CA1987IR	14 120			
	[Z13DTE]	06.10-	CA1955IR	14 70			
		06.10-	CA1956IR	14 100			
		06.10-	CA1987IR	14 120			
	[Z13DTH]	07.06-	CA1955IR	14 70	07.06-	CS1334	12 1.1
		07.06-	CA1956IR	14 100			
		07.06-	CA1987IR	14 120			
[Z13DTJ]	07.06-	CA1955IR	14 70	07.06-	CS1334	12 1.1	
	07.06-	CA1956IR	14 100				
	07.06-	CA1987IR	14 120				
Corsa D 1.4	[A14XER]	06.10-	CA1940IR	14 100	06.10-	CS1257	12 1.1
		06.10-	CA2046IR*	14 70			
	[Z14XEP]	07.06-	CA1940IR	14 100	07.06-	CS1257	12 1.1
		07.06-	CA2046IR*	14 70			
Corsa D 1.4 LPG	[A14XEL]	09.09-	CA2046IR*	14 70	09.09-	CS1257	12 1.1
		07.06-	CA1940IR	14 100			
	[Z14XEP]	07.06-	CA2046IR*	14 70	07.06-	CS1257	12 1.1
Corsa D 1.4 ecoFlex	[Z14XEP]	09.09-	CA1940IR	14 100	09.09-	CS1257	12 1.1
		09.09-	CA2046IR*	14 70			
Corsa D 1.6 Turbo	[Z16LEL]	02.07-	CA1973IR	14 120	02.07-	CS1438	12 1.1
		02.07-	CA1973IR	14 120			
Corsa D 1.7 CDTi 16V	[A17DTS]	06.10-	CA2010IR	14 100	06.10-	JS1158	12 1.4
Corsa D 1.7 CDTi	[Z17DTR]	07.06-	CA2010IR	14 100	07.06-	JS1158	12 1.4
		AC 07.06-	CA2017IR	14 140			
Diplomat 2.8	[28HC]	09.72- 08.78	CA320IR	14 90	09.72- 08.78	CS80	12 1.0
Diplomat B 2.8	[28E]	07.71- 02.75	CA42IR	14 55	03.69- 02.75	CS80	12 1.0
Frontera A 2.0 i Sport	[C20NE]	03.92- 08.95	CA515IR	14 90	03.92- 08.95	CS372	12 1.4 BO
		03.92- 08.95	CA517IR	14 70			
	[X20SE]	02.95- 10.98	CA1053IR	14 100	02.95- 10.98	CS727	12 1.0 DR
		AC 02.95- 10.98	CA1045IR	14 120			
Frontera A 2.2 i	[X22XE]	03.95- 10.98	CA1053IR	14 100	03.95- 10.98	CS879	12 1.1
		AC 03.95- 10.98	CA1045IR	14 120			
Frontera A 2.3 TD	[Z23DTR]	03.92- 08.95	CA384IR	14 70	03.92- 08.95	CS356	12 2.2
Frontera A 2.4 i	[C24NE]	03.92- 08.95	CA515IR	14 90			
		03.92- 08.95	CA570IR	14 70			
Frontera A 2.5 TDS	[Z25TDS]				06.96- 10.98	CS1071	12 2.0
Frontera A 2.5 TDS Sport	[Z25TDS]				06.96- 10.98	CS1071	12 2.0
Frontera A 2.8 TD	[4JB1T]	03.95- 10.98	JA1290IR	14 80	03.95- 10.98	JS639	12 2.0
Frontera B 2.2 i	[X22SE]	09.98- 12.00	CA1053IR	14 100	09.98- 12.00	CS879	12 1.1
		AC 09.98- 12.00	CA1045IR	14 120			
	[Y22SE]	09.00- 09.04	CA1053IR	14 100	09.00- 09.04	CS879	12 1.1
		AC 09.00- 09.04	CA1045IR	14 120			
Frontera B 2.2 DTi	[X22DTH]	09.98- 10.02	CA1327IR	14 100	09.98- 10.02	CS976	12 2.0
		09.02- 09.04	CA1327IR	14 100			
	[Y22DTH]				Eng. -17883780, 17883781- 09.02- 09.04	CS976	12 2.0
Frontera B 3.2 i	[Y32NE]	10.98- 09.04	CA158IR	14 45			
GT 1.1	[11SR]				09.68- 12.70	CS66	12 0.65
GT 1.9	[19S]				09.68- 08.73	CS70	12 0.8
Insignia 1.6	[A16LET]				07.08-	CS1438	12 1.1
					07.08-	CS1438	12 1.1
Insignia 1.6 Caravan	[A16XER]				07.08-	CS1438	12 1.1
					07.08-	CS1438	12 1.1
Insignia 1.6 Turbo	[A16LET]				07.08-	CS1438	12 1.1
					07.08-	CS1438	12 1.1
Insignia 1.8	[A18XER]				07.08-	CS1438	12 1.1
					07.08-	CS1438	12 1.1
Insignia 1.8 Caravan	[A18XER]				07.08-	CS1438	12 1.1
					07.08-	CS1428	12 1.7
Insignia 2.0 CDTi	[A20DTC]	07.08-	CA2005IR	14 100	07.08-	CS1428	12 1.7
					AT 07.08-	CS1264	12 1.7
	[A20DTH]	07.08-	CA2005IR	14 100	07.08-	CS1428	12 1.7
					AT 07.08-	CS1264	12 1.7
[A20DTJ]	07.08-	CA2005IR	14 100	07.08-	CS1428	12 1.7	
				AT 07.08-	CS1264	12 1.7	





	[A20DTR]	07.08-	CA2005IR	14 100		07.08- AT 07.08-	CS1428 CS1264	12 1.7 12 1.7
Insignia 2.0 CDTi 4x4	[A20DTH]	06.10-	CA2005IR	14 100		06.10-	CS1264	12 1.7
	[A20DTR]	07.08-	CA2005IR	14 100		AT 07.08- 07.08-	CS1264 CS1428	12 1.7 12 1.7
Insignia 2.0 CDTi Caravan	[A20DTC]	07.08-	CA2005IR	14 100		07.08- AT 07.08-	CS1428 CS1264	12 1.7 12 1.7
	[A20DTH]	07.08-	CA2005IR	14 100		07.08- AT 07.08-	CS1264 CS1428	12 1.7 12 1.7
	[A20DTJ]	07.08-	CA2005IR	14 100		AT 07.08- 07.08-	CS1264 CS1428	12 1.7 12 1.7
	[A20DTR]	07.08-	CA2005IR	14 100		07.08- AT 07.08-	CS1428 CS1264	12 1.7 12 1.7
Insignia 2.8 Turbo V6 4x4	[A28NET]					07.08-	CS1488*	12
Insignia 2.8 Turbo V6 Caravan 4x4	[A28NET]					07.08-	CS1488*	12
Kadett B 1.1	[11N]	10.72- 08.73	CA48IR	14 45		09.65- 08.73	CS66	12 0.65
	[11S]					09.65- 07.71	CS66	12 0.65
	[11SR]					11.66- 07.71	CS66	12 0.65
Kadett B 1.1 S	[11S]					09.65- 07.71	CS66	12 0.65
Kadett B 1.1 SR	[11SR]					11.66- 07.71	CS66	12 0.65
Kadett B 1.2	[12S]	10.72- 08.73	CA48IR	14 45		08.71- 08.73	CS66	12 0.65
Kadett B 1.2 S	[12S]	10.72- 08.73	CA48IR	14 45		08.71- 08.73	CS66	12 0.65
Kadett B 1.9	[19S]					07.68- 08.73	CS70	12 0.8
Kadett C 1.0	[10N]	01.74- 07.79	CA48IR	14 45		01.74- 07.79	CS66	12 0.65
Kadett C 1.0 City	[10N]	01.76- 07.79	CA48IR	14 45		01.76- 07.79	CS66	12 0.65
Kadett C 1.2	[12N]	08.73- 07.79	CA48IR	14 45		08.73- 07.79	CS66	12 0.65
Kadett C 1.2 City	[12N]	01.76- 07.79	CA48IR	14 45		01.76- 07.79	CS66	12 0.65
Kadett C 1.2 S	[12S]	08.73- 07.79	CA48IR	14 45		08.73- 07.79	CS66	12 0.65
Kadett C 1.2 S City	[12S]	08.73- 07.79	CA48IR	14 45		08.73- 07.79	CS66	12 0.65
Kadett C 1.6 S	[16S]	05.77- 07.79	CA42IR	14 55		05.77- 07.79	CS70	12 0.8 BO
Kadett C 1.6 S City	[16S]	05.77- 07.79	CA42IR	14 55		05.77- 07.79	CS70	12 0.8 BO
Kadett C 1.9 GT/E	[19E]	10.76- 07.77	CA42IR	14 55		09.75- 07.77	CS70	12 0.8
Kadett C 2.0 Rally	[20E]	08.77- 07.79	CA42IR	14 55		08.77- 07.79	CS70	12 0.8
Kadett C 2.0 GT/E	[20EH]	08.77- 07.79	CA42IR	14 55		08.77- 07.79	CS70	12 0.8
Kadett D 1.0	[10N]	09.79- 08.82	CA48IR	14 45		09.79- 08.82	CS66	12 0.65
	[10S]	09.79- 08.84	CA48IR	14 45		09.79- 08.84	CS66	12 0.65
Kadett D 1.2	[12N]	08.79- 07.82	CA48IR	14 45		08.79- 07.82	CS66	12 0.65
Kadett D 1.2 S	[12S]	08.79- 08.84	CA48IR	14 45		08.79- 08.84	CS66	12 0.65
		08.82- 08.84	CA128IR	14 45		08.82- 08.84	CS162	12 0.7
		08.82- 08.84	CA48IR	14 45				
Kadett D 1.3	[13N]	08.79- 08.84	CA128IR	14 45		08.79- 08.84	CS162	12 0.7
		08.79- 08.84	CA99IR	14 55				
Kadett D 1.3 N	[C13N]	08.79- 08.84	CA128IR	14 45		08.79- 08.84	CS162	12 0.7
		08.79- 08.84	CA353IR	14 65				
		08.79- 08.84	CA99IR	14 55				
		08.79- 08.84	CA128IR	14 45		08.79- 08.84	CS162	12 0.7
Kadett D 1.3 S	[13S]	08.79- 08.84	CA353IR	14 65				
		08.79- 08.84	CA99IR	14 55				
		08.79- 08.84	CA158IR	14 45		09.81- 08.84	CS263	12 0.8
Kadett D 1.6 S	[16SH]	09.81- 08.84	CA264IR	14 55				
		09.81- 08.84	CA264IR	14 55		09.81- 08.84	CS263	12 0.8
Kadett D 1.6 Diesel	[16D]	03.82- 08.84	CA548IR#	14 55		03.82- 08.84	CS322	12 1.7
						03.82- 08.84	CS290	12 1.7
Kadett D 1.8 GT/E	[18E]	02.83- 08.84	CA158IR	14 45		02.83- 08.84	CS263	12 0.8
		02.83- 08.84	CA264IR	14 55				
Kadett E 1.2	[12SC]	09.84- 07.86	CA48IR	14 45		09.84- 07.86	CS66	12 0.65
Kadett E 1.2 S	[12SC]	09.84- 07.86	CA48IR	14 45		09.84- 07.86	CS66	12 0.65
Kadett E 1.3	[13N]	09.84- 07.89	CA128IR	14 45		09.84- 08.91	CS162	12 0.7
		09.84- 07.89	CA353IR	14 65				
		09.84- 07.89	CA99IR	14 55				
		09.88- 08.91	CA513IR	14 55				
		09.88- 08.91	CA514IR	14 70				
		09.84- 07.89	CA128IR	14 45		09.84- 08.91	CS162	12 0.7
		09.84- 07.89	CA353IR	14 65				
		09.84- 07.89	CA99IR	14 55				
		09.88- 08.91	CA513IR	14 55				
		09.88- 08.91	CA514IR	14 70				
Kadett E 1.3 Combo	[13N]	01.86- 12.89	CA128IR	14 45		01.86- 12.89	CS162	12 0.7
		01.86- 12.89	CA353IR	14 65				
		01.86- 12.89	CA513IR	14 55				
		01.86- 12.89	CA514IR	14 70				
Kadett E 1.3 i	[C13N]	09.85- 08.86	CA128IR	14 45		09.85- 08.91	CS162	12 0.7
		09.85- 08.88	CA353IR	14 65				
		09.85- 08.88	CA99IR	14 55				
		09.88- 08.91	CA513IR	14 55				
		09.88- 08.91	CA514IR	14 70				
Kadett E 1.3 S	[13S]	09.84- 08.86	CA128IR	14 45		09.84- 08.87	CS162	12 0.7
		09.84- 08.87	CA353IR	14 65				
		09.84- 08.87	CA99IR	14 55				
Kadett E 1.3 S Combo	[13S]	01.86- 12.89	CA128IR	14 45		01.86- 12.89	CS162	12 0.7
		01.86- 12.89	CA353IR	14 65				
		01.86- 12.89	CA513IR	14 55				
		01.86- 12.89	CA514IR	14 70				
Kadett E 1.4 Combo	[14NV]	07.89- 08.91	CA513IR	14 55		07.89- 08.91	CS162	12 0.7
		07.89- 08.91	CA514IR	14 70				
Kadett E 1.4 i	[C14NZ]	01.90- 08.91	CA513IR	14 55		01.90- 08.91	CS535	12 0.9
		01.90- 08.91	CA514IR	14 70		01.90- 08.91	CS519	12 1.0
						01.90- 08.91	CS162	12 0.7
Kadett E 1.4 i Combo	[C14NZ]	08.91- 07.94	CA513IR	14 55		08.91- 07.94	CS162	12 0.7
		08.91- 07.94	CA514IR	14 70				
Kadett E 1.4 S	[14NV]	01.90- 08.91	CA513IR	14 55		01.90- 08.91	CS162	12 0.7
		01.90- 08.91	CA514IR	14 70				
	[C14SE]	09.89- 08.91	CA513IR	14 55		09.89- 08.91	CS1183	12 0.9
Kadett E 1.5 TD	[15DT (T4EC1)]	09.88- 08.91	JA874IR	14 70		07.88- 08.91	JS753	12 1.4
Kadett E 1.6	[16SV]	09.86- 08.91	CA353IR	14 65		09.86- 08.91	CS519	12 1.0
		09.86- 08.91	CA48IR	14 45		09.86- 08.88	CS162	12 0.7
		09.88- 08.91	CA517IR	14 70		09.86- 08.91	CS535	12 0.9
Kadett E 1.6 Combo	[16SV]	09.86- 08.88	CA353IR	14 65		09.86- 12.91	CS162	12 0.7
		09.86- 12.91	CA48IR	14 45		09.86- 12.91	CS519	12 1.0
		09.88- 12.91	CA517IR	14 70		09.86- 12.91	CS535	12 0.9



**OPEL** *Continued*

Kadett E 1.6 i	[16SV]	07.89- 02.93 CA513IR	14 55	07.89- 02.93 CS1183	12 0.9	
		07.89- 02.93 CA514IR	14 70	07.89- 02.93 CS535	12 0.9	
Kadett E 1.6 i	[C16LZ]	PS 07.89- 02.93 CA519IR	14 65			
		09.86- 08.88 CA128IR	14 45	09.88- 08.91 CS535	12 0.9	
		09.86- 08.88 CA99IR	14 55	09.88- 08.91 CS519	12 1.0	
		09.88- 08.91 CA513IR	14 55	09.86- 08.88 CS162	12 0.7	
		09.88- 08.91 CA514IR	14 70			
		PS 09.86- 08.88 CA530IR	14 65			
		PS 09.88- 08.91 CA519IR	14 65			
		09.86- 08.88 CA128IR	14 45	09.88- 08.91 CS535	12 0.9	
Kadett E 1.6 i	[C16NZ]	09.86- 08.88 CA99IR	14 55	09.86- 08.88 CS162	12 0.7	
		09.88- 09.93 CA513IR	14 55	08.89- 09.93 CS1183	12 0.9	
		09.88- 09.93 CA514IR	14 70	09.88- 08.91 CS519	12 1.0	
		PS 09.86- 08.88 CA530IR	14 65			
		PS 09.88- 09.93 CA519IR	14 65			
Kadett E 1.6 i	[E16NZ]	09.86- 08.88 CA128IR	14 45	09.88- 08.91 CS535	12 0.9	
		09.86- 08.88 CA99IR	14 55	09.88- 08.91 CS519	12 1.0	
		09.88- 08.91 CA513IR	14 55	09.86- 08.88 CS162	12 0.7	
		09.88- 08.91 CA514IR	14 70			
		PS 09.86- 08.88 CA530IR	14 65			
Kadett E 1.6 i	[C16NZ]	PS 09.88- 08.91 CA519IR	14 65			
		08.91- 07.94 CA514IR	14 70	08.91- 07.94 CS1183	12 0.9	
Kadett E 1.6 S	[16SH]	09.84- 08.86 CA158IR	14 45	09.84- 08.86 CS263	12 0.8	
		09.84- 08.86 CA264IR	14 55			
		09.84- 08.86 CA352IR	14 65			
Kadett E 1.6 S	[16SV]	09.86- 08.91 CA353IR	14 65	09.86- 08.88 CS162	12 0.7	
		09.86- 08.91 CA48IR	14 45	09.86- 08.91 CS519	12 1.0	
		09.88- 08.91 CA517IR	14 70	09.86- 08.91 CS535	12 0.9	
Kadett E 1.6 Diesel	[16D]			09.85- 01.89 CS290	12 1.7	
	[16DA]			08.84- 09.85 CS322	12 1.7	
Kadett E 1.6 Diesel	[16DA]			09.85- 01.89 CS290	12 1.7	
	[16DA]			08.84- 09.85 CS322	12 1.7	
Kadett E 1.6 Diesel	[16DA]			01.86- 12.89 CS290	12 1.7	
Kadett E 1.7 Diesel	[17D]	08.88- 09.92 CA516IR	14 70	08.88- 09.92 CS290	12 1.7	
	[17DR]	02.89- 08.91 CA516IR	14 70	02.89- 08.91 CS322	12 1.7	
Kadett E 1.7 Diesel	[17D]	01.89- 07.94 CA516IR	14 70	01.89- 07.94 CS290	12 1.7	
Kadett E 1.8	[C18NE]	10.85- 08.86 CA158IR	14 45	AT 10.85- 08.86 CS263	12 0.8	
		10.85- 08.86 CA264IR	14 55	10.85- 08.86 CS727	12 1.1	
		10.85- 08.86 CA352IR	14 65			
Kadett E 1.8 E	[C18NE]	10.85- 08.86 CA158IR	14 45	10.85- 08.86 CS727	12 1.1	
		10.85- 08.86 CA264IR	14 55	AT 10.85- 08.86 CS263	12 0.8	
		10.85- 08.86 CA352IR	14 65			
Kadett E 1.8 GSi	[18E]	09.84- 08.86 CA158IR	14 45	09.84- 08.86 CS372	12 1.4 BO	
		09.84- 08.86 CA264IR	14 55	09.84- 08.86 CS518	12 1.0 DR	
		09.84- 08.86 CA352IR	14 65	AT 09.84- 08.86 CS263	12 0.8	
Kadett E 1.8 i	[18E]	09.84- 08.86 CA158IR	14 45	09.84- 08.86 CS372	12 1.4	
		09.84- 08.86 CA264IR	14 55	09.84- 08.86 CS263	12 0.8	
		09.84- 08.86 CA352IR	14 65			
	Kadett E 1.8 i	[C18NE]	10.85- 08.86 CA158IR	14 45	AT 10.85- 08.86 CS263	12 0.8
			10.85- 08.86 CA264IR	14 55	10.85- 08.86 CS727	12 1.1
			10.85- 08.86 CA352IR	14 65		
	Kadett E 1.8 i	[C18NT]	08.84- 09.92 CA158IR	14 45	A34 08.84- 09.92 CS263	12 0.8
			08.84- 09.92 CA264IR	14 55		
			08.84- 09.92 CA352IR	14 65		
	Kadett E 1.8 i	[C18NZ]	09.90- 08.91 CA517IR	14 70	09.90- 08.91 CS518	12 1.0 DR
09.90- 08.91 CA548IR#			14 55	09.90- 08.91 CS372	12 1.4 BO	
Kadett E 1.8 i		[S18NV]	09.86- 08.91 CA264IR	14 55	09.86- 08.91 CS727	12 1.1
			09.86- 08.91 CA352IR	14 65	09.86- 08.91 CS518	12 1.0 DR
			09.88- 08.91 CA548IR#	14 55		
Kadett E 1.8 S	[E18NV]	09.87- 08.91 CA264IR	14 55	09.87- 08.91 CS518	12 1.0 DR	
		09.87- 08.91 CA352IR	14 65	09.87- 08.91 CS372	12 1.4 BO	
		09.88- 08.91 CA517IR	14 70			
		09.88- 08.91 CA548IR#	14 55			
	[S18NV]	09.86- 08.88 CA264IR	14 55	09.87- 08.91 CS372	12 1.4 BO	
Kadett E 2.0	[20NE]	09.86- 08.88 CA264IR	14 55	09.86- 08.91 CS372	12 1.4 BO	
		09.86- 08.91 CA352IR	14 65	09.86- 08.91 CS518	12 1.0 DR	
		09.88- 08.91 CA517IR	14 70			
		09.88- 08.91 CA548IR#	14 55			
	Kadett E 2.0	[20SEH]	09.86- 08.91 CA264IR	14 55	09.86- 08.91 CS372	12 1.4 BO
			09.86- 08.91 CA352IR	14 65	09.86- 08.91 CS518	12 1.0 DR
			09.88- 08.91 CA517IR	14 70		
			09.88- 08.91 CA548IR#	14 55		
	Kadett E 2.0	[C20XE]	09.90- 05.92 CA352IR	14 65	09.90- 05.92 CS518	12 1.0 DR
			09.90- 05.92 CA517IR	14 70	09.90- 05.92 CS727	12 1.1 BO
09.90- 05.92 CA548IR#			14 55			
Kadett E 2.0	[C20XEJ]	09.90- 05.92 CA352IR	14 65	09.90- 05.92 CS518	12 1.0 DR	
		09.90- 05.92 CA517IR	14 70	09.90- 05.92 CS727	12 1.1 BO	
		09.90- 05.92 CA548IR#	14 55			
Kadett E 2.0 GSi	[20SER]	09.90- 05.92 CA352IR	14 65	09.90- 05.92 CS727	12 1.1 BO	
		09.90- 05.92 CA517IR	14 70	09.90- 05.92 CS518	12 1.0 DR	
		09.90- 05.92 CA548IR#	14 55			
Kadett E 2.0 GSi 16V	[20XE]	12.87- 08.91 CA517IR	14 70	12.87- 08.91 CS372	12 1.4	
		12.87- 08.91 CA548IR#	14 55			
	[20XEJ]	09.88- 08.91 CA615IR	14 70	03.88- 08.91 CS518	12 1.0 DR	
Kadett E 2.0 GSi	[C20XE]	09.88- 08.91 CA615IR	14 70	03.88- 08.91 CS372	12 1.4 BO	
				03.88- 08.91 CS518	12 1.0 DR	
				03.88- 08.91 CS372	12 1.4 BO	
				03.88- 08.91 CS518	12 1.0 DR	
Kadett E 2.0 GSi	[C20NE]	09.86- 08.91 CA264IR	14 55	09.86- 08.91 CS372	12 1.4 BO	
		09.86- 08.91 CA352IR	14 65	09.86- 08.91 CS518	12 1.0 DR	
		09.88- 08.91 CA517IR	14 70			
		09.88- 08.91 CA548IR#	14 55			
Kadett E 2.0 i	[20NE]	09.86- 08.91 CA264IR	14 55	09.86- 08.91 CS372	12 1.4 BO	
		09.86- 08.91 CA352IR	14 65	09.86- 08.91 CS518	12 1.0 DR	
		09.88- 08.91 CA517IR	14 70			
	Kadett E 2.0 i	[C20NE]	09.88- 08.91 CA548IR#	14 55		
			09.86- 08.91 CA264IR	14 55	09.86- 08.91 CS518	12 1.0 DR
			09.86- 08.91 CA352IR	14 65	09.86- 08.91 CS372	12 1.4 BO
Manta A 1.2	[12S]	09.88- 08.91 CA517IR	14 70			
		09.88- 08.91 CA548IR#	14 55			
		04.72- 08.75 CA48IR	14 45	04.72- 08.75 CS66	12 0.65	



Manta A 1.6	[16N]				09.70- 08.75	CS70	12 0.8	BO
	[16S]				02.75- 08.75	CS70	12 0.8	BO
Manta A 1.6 S	[16S]				09.70- 08.75	CS70	12 0.8	BO
Manta A 1.9 GT/E	[19E]				02.74- 08.75	CS70	12 0.8	BO
Manta A 1.9 S	[19S]				09.70- 08.75	CS70	12 0.8	BO
Manta B 1.2	[12N]	08.76- 07.83	CA48IR	14 45	08.76- 07.83	CS66	12 0.65	
	[12S]	09.75- 02.79	CA48IR	14 45	09.75- 02.79	CS66	12 0.65	
Manta B 1.3	[13N]	03.79- 12.80	CA128IR	14 45	03.79- 12.80	CS162	12 0.7	
		03.79- 12.80	CA99IR	14 55				
Manta B 1.3 S	[13S]	08.79- 08.86	CA128IR	14 45	08.79- 08.86	CS162	12 0.7	
		08.79- 08.86	CA99IR	14 55				
		09.84- 08.86	CA353IR	14 65				
Manta B 1.6	[16N]	10.76- 12.80	CA42IR	14 55	09.75- 12.80	CS70	12 0.8	BO
		06.80- 12.80	CA221IR	14 65				
Manta B 1.6 S	[16S]	10.76- 12.80	CA42IR	14 55	09.75- 12.80	CS70	12 0.8	BO
		06.80- 12.80	CA221IR	14 65				
Manta B 1.8 S	[18S]	07.82- 08.87	CA158IR	14 45	07.82- 08.87	CS263	12 0.8	
		07.82- 08.87	CA264IR	14 55				
		09.84- 08.87	CA352IR	14 65				
Manta B 1.9	[19E]	10.76- 08.77	CA42IR	14 55	09.75- 08.77	CS70	12 0.8	BO
	[19N]	10.76- 12.80	CA42IR	14 55	08.76- 12.80	CS70	12 0.8	BO
		06.80- 12.80	CA221IR	14 65				
Manta B 1.9 S	[19S]	10.76- 07.77	CA42IR	14 55	09.75- 07.77	CS70	12 0.8	BO
Manta B 2.0	[20E]	08.77- 08.88	CA42IR	14 55	09.81- 08.88	CS80	12 1.0	
		06.80- 08.88	CA221IR	14 65	08.77- 08.88	CS70	12 0.8	BO
		08.77- 12.80	CA42IR	14 55	08.77- 12.80	CS70	12 0.8	BO
		06.80- 12.80	CA221IR	14 65				
Manta B 2.0 S	[20S]	08.77- 08.85	CA42IR	14 55	08.77- 08.85	CS70	12 0.8	BO
		06.80- 08.85	CA221IR	14 65				
Manta B 2.4 400	[24E]	07.80- 08.81	CA42IR	14 55	07.80- 08.84	CS70	12 0.8	
		09.81- 08.84	CA221IR	14 65				
Meriva 1.4 16V Twinport LPG	[Z14XEP]	07.04- 05.10	CA1658IR	14 120	07.04- 05.10	CS1257	12 1.1	
		07.04- 05.10	CA1747IR	14 70				
		07.04- 05.10	CA1862IR	14 90				
		07.04- 05.10	CA1940IR	14 100				
		07.04- 05.10	CA2046IR*	14 70				
Meriva A 1.3 CDTi	[Y13DT]	04.05-	CA1934IR	14 105	04.05-	CS1334	12 1.1	
		04.05-	CA1935IR	14 120				
	[Z13DT]	04.05-	CA1934IR	14 105	04.05-	CS1334	12 1.1	
		04.05-	CA1935IR	14 120				
	[Z13DTJ]	09.03-	CA1855IR	14 75	09.03- 09.05	CS1334	12 1.1	
		09.03-	CA1862IR	14 90				
		09.03-	CA1934IR	14 105				
		09.03-	CA1935IR	14 120				
Meriva A 1.4 16V Twinport	[Z14XEP]	07.04- 05.10	CA1658IR	14 120	07.04-	CS519	12 1.0	
		07.04-	CA1747IR	14 70				
		07.04-	CA1748IR	14 100				
		07.04-	CA2046IR*	14 70				
Meriva A 1.6	[Z16SE]	05.03-	CA1391IR	14 70	05.03-	CS1257	12 1.1	
		05.03-	CA1581IR	14 100				
		05.03-	CA1765IR	14 120				
		01.06-	CA1833IR	14 120	01.06-	CS1438	12 1.1	
Meriva A 1.6 16V	[Z16XE]	05.03-	CA1391IR	14 70	05.03-	CS1257	12 1.1	
		05.03-	CA1581IR	14 100				
		05.03-	CA1765IR	14 120				
Meriva A 1.6 Turbo	[Z16LET]	09.05-	CA1833IR	14 120	09.05-	CS1438	12 1.1	
		AC 09.05-	CA1973IR	14 120				
Meriva A 1.7 CDTi	[A17DTR]	09.06-	CA2010IR	14 100	09.06-	JS1158	12 1.4	
		AC 09.06-	CA2017IR	14 140				
	[Z17DTH]	09.03-	JA1901IR	14 100	09.03-	JS1158	12 1.4	
	[Z17DTR]	09.06-	CA2010IR	14 100	09.06-	JS1158	12 1.4	
		AC 09.06-	CA2017IR	14 140				
Meriva A 1.7 DTi	[Y17DT]	03.03- 09.05	JA1526IR	14 70	03.03- 09.05	JS1158	12 1.4	
		AC 03.03- 09.05	JA1521IR	14 100				
Meriva A 1.8	[Z18XE]	09.02-	CA1581IR	14 100	09.02-	CS1257	12 1.1	
		05.03-	CA1391IR	14 70				
		05.03-	CA1765IR	14 120				
Meriva B 1.3 CDTi	[A13DTC]	06.10-	CA1955IR	14 70				
		06.10-	CA1956IR	14 100				
		CA1987IR	14 120					
	[A13DTE]	06.10-	CA1955IR	14 70				
		06.10-	CA1956IR	14 100				
		06.10-	CA1987IR	14 120				
Meriva B 1.7 CDTi	[A17DTC]	06.10-	CA2010IR	14 100	06.10-	JS1158	12 1.4	
		06.10-	CA2017IR	14 140				
	[A17DTS]	06.10-	CA2010IR	14 100	06.10-	JS1158	12 1.4	
		06.10-	CA2017IR	14 140				
Meriva B 1.7 CDTi Ecotec	[A17DT]	06.10-	CA2010IR	14 100	06.10-	JS1158	12 1.4	
		06.10-	CA2017IR	14 140				
Monterey A 3.1 TD	[4JG2TC]	09.91- 12.97	JA761IR	14 50	09.91- 12.97	JS999	12 2.8	
		09.91- 12.97	JA873IR	14 60	09.91- 12.97	JS639	12 2.0	
		03.92- 12.97	JA1290IR	14 80				
Monterey B 3.0 DTi	[4JX1]				04.98- 12.99	JS999	12 2.8	
Monza A 2.0 i	[H20E]	03.83- 08.86	CA221IR	14 65	03.83- 10.84	CS80	12 1.0	
		03.83- 08.86	CA42IR	14 55				
		12.83- 08.86	CA515IR	14 90				
Monza A 2.2 i	[22E]	11.84- 08.86	CA221IR	14 65	11.84- 08.86	CS80	12 1.0	
		11.84- 08.86	CA42IR	14 55	11.84- 08.86	CS70	12 0.8	
		11.84- 08.86	CA515IR	14 90				
Monza A 2.5 i	[25E]	06.84- 08.86	CA221IR	14 65	06.84- 08.86	CS80	12 1.0	
	[H25E]	06.84- 08.86	CA515IR	14 90				
		05.81- 12.82	CA42IR	14 55	05.81- 08.86	CS80	12 1.0	
		01.83- 08.86	CA221IR	14 65				
		12.83- 08.86	CA515IR	14 90				
Monza A 2.8	[28H]	02.78- 04.81	CA42IR	14 55	02.78- 04.81	CS80	12 1.0	
Monza A 3.0	[30H]	04.78- 07.82	CA42IR	14 55	04.78- 07.82	CS80	12 1.0	
Monza A 3.0 i	[30E]	02.78- 08.86	CA42IR	14 55	02.78- 08.86	CS80	12 1.0	
		01.83- 08.86	CA221IR	14 65				
		12.83- 08.86	CA515IR	14 90				
				09.85- 08.86	CA221IR	14 65	09.85- 08.86	CS80
	[C30LE]	09.85- 08.86	CA42IR	14 55				
		09.85- 08.86	CA515IR	14 90				



Opel Continued

Movano 1.9 DTi	[F9Q770]	09.00-	CA1622IR	14 120	09.00-	CS1263	12 2.0
	[F9Q774]	10.01-	CA1645IR	14 125	10.01-	CS1193	12 1.8
Movano 2.2 DTi	[G9T720]	AC 10.01-	CA1627IR	14 125			
		09.00-	CA1627IR	14 125	09.00-	CS1207	12 2.0
Movano 2.3 CDTi	[M9T670]	AC 09.00-	CA1661IR	14 125			
	[M9T676]				12.10-	CS1415	12 2.2
	[M9T680]				12.10-	CS1415	12 2.2
	[M9T694]				12.10-	CS1415	12 2.2
	[M9T698]				12.10-	CS1415	12 2.2
Movano 2.5 CDTi	[G9U632]	08.06-	CA1827IR	14 150	08.06-	CS1207	12 2.0
	[G9U754]	08.06-	CA1827IR	14 150	08.06-	CS1207	12 2.0
		08.06-	CA1827IR	14 150	08.06-	CS1207	12 2.0
Movano 2.5 CDTi Combi	[G9U632]	08.06-	CA1827IR	14 150	08.06-	CS1207	12 2.0
		08.06-	CA1827IR	14 150	08.06-	CS1207	12 2.0
Movano 2.5 Diesel	[S8U770]	07.98-	CA1343IR	14 75	07.98- 09.00	CS1160	12 2.2
		01.99-	CA1645IR	14 125			
		AC 07.98-	CA1434IR	14 110			
		AC 01.99-	CA1627IR	14 125			
Movano 2.5 DTi	[G9U720]	10.01-	CA1627IR	14 125	10.01-	CS1207	12 2.0
	[G9U724]	AC 10.01-	CA1661IR	14 125			
Movano 2.5 DTi	[G9U754]	10.01-	CA1827IR	14 150	10.01-	CS1207	12 2.0
		10.01-	CA1877IR	14 150			
		AC 10.01-	CA1661IR	14 125			
		AC 10.01-	CA1827IR	14 150			
		AC 10.01-	CA1877IR	14 150			
Movano 2.8 DTi	[S9W702]	06.98- 10.01	CA1343IR	14 75	06.98- 10.01	CS1160	12 2.2
Movano 3.0 DTi	[ZD3200]	10.03-	CA2081IR*	14 120	10.03-	CS1491*	12 2.5
		10.03-	CA2082IR*	14 135			
	[ZD3-200]	10.03-	CA2081IR*	14 120	10.03-	CS1491*	12 2.5
		10.03-	CA2082IR*	14 135			
	[ZD3202]	10.03-	CA2081IR*	14 120	10.03-	CS1491*	12 2.5
		10.03-	CA2082IR*	14 135			
Movano B 2.3 CDTi FWD	[M9T6..]				05.10-	CS1415	12 2.2
	[M9T67..]				05.10-	CS1415	12 2.2
	[M9T69..]				05.10-	CS1415	12 2.2
					05.10-	CS1415	12 2.2
Movano B 2.3 CDTi RWD	[M9T6..]				05.10-	CS1415	12 2.2
	[M9T69..]				05.10-	CS1415	12 2.2
Omega 3.0 24V	[C30SE]	09.88- 04.94	CA846IR	14 90			
Omega A 1.8	[18NV]	09.86- 08.87	CA264IR	14 55	AT 09.86- 08.87	CS372	12 1.4 BO
		09.86- 08.87	CA352IR	14 65	Chas. -K1000098 09.86- 08.87	CS518	12 1.0 DR
		PS 09.86- 08.87	CA530IR	14 65	Chas. K1000099- 09.86- 08.87	CS727	12 1.1
		09.87- 08.88	CA264IR	14 55	Chas. -K1000098 09.87- 03.94	CS518	12 1.0 DR
		09.87- 08.88	CA352IR	14 65	Chas. K1000099- 09.87- 03.94	CS727	12 1.1
		09.88- 03.94	CA517IR	14 70	AT 09.87- 03.94	CS372	12 1.4 BO
		09.88- 03.94	CA548IR#	14 55			
		PS 09.87- 08.88	CA530IR	14 65			
		09.86- 08.88	CA264IR	14 55	Chas. K1000099- 09.86- 03.94	CS727	12 1.1
		09.86- 08.88	CA352IR	14 65	Chas. -K1000098 09.86- 03.94	CS518	12 1.0 DR
Omega A 1.8 i	[18SEH]	09.88- 03.94	CA517IR	14 70	AT 09.86- 03.94	CS372	12 1.4 BO
		09.88- 03.94	CA548IR#	14 55			
		PS 09.86- 08.88	CA530IR	14 65			
		09.86- 08.88	CA264IR	14 55	Chas. -K1000098 09.86- 03.94	CS518	12 1.0 DR
		09.86- 08.88	CA352IR	14 65	Chas. K1000099- 09.86- 03.94	CS727	12 1.1
Omega A 1.8 S	[18SV]	09.88- 03.94	CA517IR	14 70	AT 09.86- 03.94	CS372	12 1.4 BO
		09.88- 03.94	CA548IR#	14 55			
		PS 09.86- 08.88	CA530IR	14 65			
		09.86- 08.88	CA264IR	14 55	Chas. -K1000098 09.86- 03.94	CS518	12 1.0 DR
		09.86- 08.88	CA352IR	14 65	Chas. K1000099- 09.86- 03.94	CS727	12 1.1
Omega A 2.0 i	[20SE]	09.86- 08.88	CA264IR	14 55	Chas. -K1000098 09.86- 03.94	CS518	12 1.0 DR
		09.86- 08.88	CA352IR	14 65	Chas. K1000099- 09.86- 03.94	CS727	12 1.1
		09.86- 03.94	CA515IR	14 90	AT 09.86- 03.94	CS372	12 1.4 BO
		09.88- 03.94	CA517IR	14 70			
	[C20NE]	09.86- 08.88	CA264IR	14 55	Chas. K1000099- 09.86- 03.94	CS727	12 1.1
		09.86- 08.88	CA352IR	14 65	AT 09.86- 03.94	CS372	12 1.4 BO
		09.86- 03.94	CA515IR	14 90	Chas. -K1000098 09.86- 03.94	CS518	12 1.0 DR
		09.88- 03.94	CA517IR	14 70			
	[C20NEF]	09.88- 03.94	CA548IR#	14 55			
		09.90- 03.94	CA515IR	14 90	Chas. K1000099- 09.90- 03.94	CS727	12 1.1
[C20NEJ]	09.90- 03.94	CA517IR	14 70	Chas. -K1000098 09.90- 03.94	CS518	12 1.0 DR	
	09.90- 03.94	CA548IR#	14 55	AT 09.90- 03.94	CS372	12 1.4 BO	
	09.90- 03.94	CA515IR	14 90	Chas. -K1000098 09.90- 03.94	CS518	12 1.0 DR	
	09.90- 03.94	CA517IR	14 70	AT 09.90- 03.94	CS372	12 1.4 BO	
Omega A 2.3 Diesel	[23YD]	09.86- 03.94	CA384IR	14 70	09.86- 03.94	CS356	12 2.2
	[23YDT]	09.86- 08.88	CA384IR	14 70	09.86- 08.88	CS356	12 2.2
Omega A 2.3 TD	[23DTR]	09.88- 03.94	CA384IR	14 70	09.88- 03.94	CS356	12 2.2
	[23YDT]	09.86- 08.88	CA384IR	14 70	09.86- 08.88	CS356	12 2.2
Omega A 2.4 i	[C24NE]	09.88- 03.94	CA515IR	14 90			
		09.88- 03.94	CA570IR	14 70			
Omega A 2.6 i	[C26NE]	09.90- 03.94	CA846IR	14 90			
Omega A 3.0 i 24V	[C30SE]	09.89- 03.94	CA846IR	14 90			
	[C30SEJ]	09.89- 03.94	CA846IR	14 90			
Omega A 3.0 i	[30NE]	03.87- 08.88	CA221IR	14 65			
		03.87- 08.88	CA294IR	14 50			
		09.88- 09.90	CA515IR	14 90			
		09.88- 09.90	CA570IR	14 70			
	[C30LE]	03.87- 08.88	CA221IR	14 65			
		09.88- 03.94	CA515IR	14 90			
		09.88- 03.94	CA570IR	14 70			
	[C30NE]	01.88- 08.88	CA221IR	14 65			
		09.88- 03.94	CA515IR	14 90			
		09.88- 03.94	CA570IR	14 70			
Omega A 3.0 i 3000	[30NE]	01.88- 08.88	CA221IR	14 65			
		09.88- 12.89	CA515IR	14 90			
		09.88- 12.89	CA570IR	14 70			
	[C30LE]	03.87- 12.87	CA221IR	14 65			
	[C30NE]	01.88- 08.88	CA221IR	14 65			
Omega A 3.0 i 24V Lotus	[C36GET]	09.88- 03.94	CA515IR	14 90			
		09.88- 03.94	CA570IR	14 70			
		01.90- 03.94	CA846IR	14 90			



Omega B 2.0 i 16V	[X20XE]	09.93- 09.99	CA1045IR	14 120	09.93- 09.99	CS879	12 1.1
		09.93- 09.99	CA1053IR	14 100			
		09.93- 09.99	CA861IR	14 70			
Omega B 2.0 i	[20SE]	03.94- 12.00	CA1045IR	14 120	03.94- 12.00	CS727	12 1.1
		03.94- 12.00	CA1053IR	14 100			
		03.94- 12.00	CA861IR	14 70			
	[X20SE]	03.94- 12.00	CA1045IR	14 120	03.94- 12.00	CS727	12 1.1
		03.94- 12.00	CA1053IR	14 100			
		03.94- 12.00	CA861IR	14 70			
Omega B 2.0 DTi 16V	[X20DTH]	09.97- 09.00	CA1326IR#	14 70	09.97- 09.00	CS976	12 2.0
		09.97- 09.00	CA1327IR	14 100			
Omega B 2.2 i 16V	[Y22XE]	09.99- 09.99	CA1045IR	14 120	09.99-	CS879	12 1.1
		09.99- 09.99	CA1053IR	14 100			
		09.99- 09.99	CA1581IR	14 100			
		09.99- 09.99	CA861IR	14 70			
		Chas. -Y1999999 09.99-	CA1053IR	14 100			
		Chas. 11000001- 09.99-	CA1581IR	14 100			
	[Z22XE]	AC 09.99-	CA1045IR	14 120	09.00- 09.03	CS879	12 1.1
		09.00- 09.03	CA1045IR	14 120			
		09.00- 09.03	CA1053IR	14 100			
		09.00- 09.03	CA1581IR	14 100			
		09.00- 09.03	CA861IR	14 70			
Chas. -Y1999999 09.00-	CA1053IR	14 100	09.00- 09.03	CS879	12 1.1		
Chas. 11000001- 09.00-	CA1581IR	14 100					
AC 09.00-	CA1045IR	14 120					
Omega B 2.2 DTi 16V	[Y22DTH]	09.00- 09.03	CA1577IR	14 120	09.00- 09.03	CS976	12 2.0
		09.00- 09.03	CA1828IR	14 140			
Omega B 2.5 i V6	[X25XE]	03.94- 09.00	CA1051IR	14 70	03.94- 09.00	CS982	12 1.4
		03.94- 09.00	CA1070IR	14 120			
		03.94- 09.00	CA1103IR	14 100			
		AC 03.94- 09.00	CA1507IR	14 120			
Omega B 2.5 DTi	[Y25DT]	06.01- 09.03	CA1584IR	14 150	06.01- 09.03	CS984	12 2.0
Omega B 2.5 TD	[25DT]	04.94- 02.01	CA1150IR	14 105	04.94- 02.01	CS378	12 2.2
		04.94- 02.01	CA1150IR	14 105			
	[X25DT]	04.96- 11.00	CA1150IR	14 105	04.96- 11.00	CS378	12 2.2
		04.96- 11.00	CA1150IR	14 105			
		04.96- 11.00	CA1150IR	14 105			
Omega B 2.6 i V6	[Y26SE]	09.00- 09.03	CA1731IR	14 120			
Omega B 3.0 i V6	[X30XE]	04.94- 02.01	CA1051IR	14 70	04.94- 02.01	CS982	12 1.4
		04.94- 02.01	CA1070IR	14 120			
		04.94- 02.01	CA1103IR	14 100			
		AC 04.94- 02.01	CA1507IR	14 120			
Omega B 3.2 i V6	[Y32SE]	02.01-	CA1731IR	14 120			
Rekord C 1.5	[15...]				08.66- 12.71	CS70	12 0.8
Rekord C 1.7	[17N]	09.68- 12.71	CA42IR	14 55	01.67- 12.71	CS70	12 0.8
Rekord C 1.7 S	[17S]	09.68- 12.71	CA42IR	14 55	01.67- 12.71	CS70	12 0.8
Rekord C 1.9	[19S]	09.68- 12.71	CA42IR	14 55	01.67- 12.71	CS70	12 0.8
Rekord C 1.9 Sprint	[19SH]	09.68- 12.71	CA42IR	14 55	09.68- 12.71	CS70	12 0.8
Rekord D 1.7	[17N]	01.72- 08.77	CA42IR	14 55	01.72- 08.77	CS70	12 0.8 BO
Rekord D 1.7 S	[17S]	01.72- 02.75	CA42IR	14 55	01.72- 02.75	CS70	12 0.8 BO
Rekord D 1.9	[19N]	03.75- 08.77	CA42IR	14 55	03.75- 08.77	CS70	12 0.8 BO
	[19SH]	03.75- 08.77	CA42IR	14 55	03.75- 08.77	CS70	12 0.8 BO
Rekord D 1.9 S	[19SH]	01.72- 02.75	CA42IR	14 55	01.72- 02.75	CS70	12 0.8 BO
Rekord D 2.0	[20S]	09.75- 08.77	CA42IR	14 55	09.75- 08.77	CS70	12 0.8 BO
Rekord D 2.0 S	[20S]	09.75- 08.77	CA42IR	14 55	09.75- 08.77	CS70	12 0.8
Rekord D 2.0 Diesel	[20D]	08.74- 08.77	CA128IR	14 45			
		08.74- 08.77	CA99IR	14 55			
Rekord D 2.1 Diesel	[21D]	09.72- 08.77	CA99IR	14 55			
Rekord E 1.7	[17N]	09.77- 10.82	CA42IR	14 55	09.77- 10.82	CS70	12 0.8 BO
		06.80- 10.82	CA221IR	14 65			
		11.82- 08.86	CA158IR	14 45			
Rekord E 1.8	[18N]	11.82- 08.86	CA264IR	14 55	11.82- 08.86	CS263	12 0.8
		09.84- 08.86	CA352IR	14 65			
		05.85- 08.86	CA158IR	14 45			
	[C18NV]	05.85- 08.86	CA264IR	14 55	05.85- 08.86	CS263	12 0.8
		05.85- 08.86	CA352IR	14 65			
Rekord E 1.8 E	[C18NV]	05.85- 08.86	CA158IR	14 45	05.85- 08.86	CS263	12 0.8
		05.85- 08.86	CA264IR	14 55			
		05.85- 08.86	CA352IR	14 65			
Rekord E 1.8 S	[18S]	11.82- 08.86	CA158IR	14 45	11.82- 08.86	CS263	12 0.8
		11.82- 08.86	CA264IR	14 55			
		09.84- 08.86	CA352IR	14 65			
Rekord E 1.9	[19N]	09.77- 10.82	CA42IR	14 55	09.77- 10.82	CS70	12 0.8 BO
		06.80- 10.82	CA221IR	14 65			
Rekord E 1.9 E	[19N]	09.77- 10.82	CA42IR	14 55	09.77- 10.82	CS70	12 0.8 BO
		06.80- 10.82	CA221IR	14 65			
Rekord E 2.0	[20E]	09.77- 10.84	CA42IR	14 55	09.77- 10.84	CS70	12 0.8 BO
		06.80- 10.84	CA221IR	14 65			
	[20N]	09.77- 10.82	CA42IR	14 55	09.77- 10.82	CS70	12 0.8 BO
		06.80- 10.82	CA221IR	14 65			
Rekord E 2.0 S	[20S]	08.77- 08.86	CA42IR	14 55	08.77- 08.86	CS70	12 0.8 BO
		06.80- 08.86	CA221IR	14 65			
Rekord E 2.0 Diesel	[20D]	09.77- 10.82	CA128IR	14 45	11.82- 08.86	CS80	12 1.0
		09.77- 10.82	CA99IR	14 55			
Rekord E 2.1 Diesel	[21D]	09.77- 07.78	CA128IR	14 45			
		09.77- 07.78	CA99IR	14 55			
Rekord E 2.2	[22E]	11.84- 08.86	CA221IR	14 65	11.84- 08.86	CS80	12 1.0
		11.84- 08.86	CA42IR	14 55			
Rekord E 2.3 Diesel	[23D]	08.78- 02.84	CA128IR	14 45	09.84- 08.86	CS356	12 2.2
		08.78- 02.84	CA99IR	14 55			
		03.84- 08.86	CA384IR	14 70			
		06.84- 08.86	CA384IR	14 70			
Rekord E 2.3 TD	[23TD]	06.84- 08.86	CA384IR	14 70	09.84- 08.86	CS356	12 2.2
Senator A 2.0 i	[H20E]	03.83- 10.84	CA221IR	14 65	03.83- 10.84	CS80	12 1.0
		03.83- 10.84	CA42IR	14 55			
		12.83- 10.84	CA515IR	14 90			
Senator A 2.2 i	[22E]	11.84- 08.87	CA221IR	14 65	11.84- 08.87	CS80	12 1.0
		11.84- 08.87	CA42IR	14 55			
		11.84- 08.87	CA515IR	14 90			
Senator A 2.3 TD	[23TD]	11.84- 08.87	CA384IR	14 70	11.84- 08.87	CS356	12 2.2
Senator A 2.5 i	[25E]	09.84- 08.87	CA221IR	14 65	09.84- 08.87	CS80	12 1.0
		09.84- 08.87	CA515IR	14 90			



Opel Continued

	[H25E]		01.83- 08.84 CA221IR 14 65		01.83- 08.84 CS80 12 1.0
			01.83- 08.84 CA42IR 14 55		
			01.83- 08.84 CA515IR 14 90		
Senator A 2.8	[28H]		02.78- 04.81 CA42IR 14 55	02.78- 04.81	CS80 12 1.0
Senator A 3.0	[30H]		04.78- 07.82 CA42IR 14 55	04.78- 07.82	CS80 12 1.0
Senator A 3.0 i	[30E]		02.78- 08.87 CA221IR 14 65	02.78- 08.87	CS80 12 1.0
			02.78- 08.87 CA42IR 14 55		
			12.83- 08.87 CA515IR 14 90		
	[C30LE]		09.85- 08.87 CA221IR 14 65	09.85- 08.87	CS80 12 1.0
			09.85- 08.87 CA42IR 14 55		
			09.85- 08.87 CA515IR 14 90		
Senator B 2.5 i	[25NE]		09.87- 08.88 CA221IR 14 65	09.87- 12.89	CS80 12 1.0
			09.87- 12.89 CA515IR 14 90		
			09.88- 12.89 CA570IR 14 70		
Senator B 2.6 i	[C26NE]		09.90- 09.93 CA846IR 14 90		
Senator B 3.0 i 24V	[C30SE]		09.89- 09.93 CA846IR 14 90		
Senator B 3.0 i	[30NE]		01.88- 08.88 CA221IR 14 65		
			01.88- 08.88 CA42IR 14 55		
			01.88- 09.90 CA515IR 14 90		
			09.88- 09.90 CA570IR 14 70		
	[C30LE]		09.87- 08.88 CA221IR 14 65		
			09.87- 08.88 CA42IR 14 55		
			09.87- 09.93 CA515IR 14 90		
			09.88- 09.93 CA570IR 14 70		
	[C30NE]		01.88- 08.88 CA221IR 14 65		
			01.88- 08.88 CA42IR 14 55		
			01.88- 09.93 CA515IR 14 90		
			09.88- 09.93 CA570IR 14 70		
Signum 1.8	[Z18XE]		05.03- CA1765IR 14 120	05.03-	CS1257 12 1.1
			05.03- CA1821IR 14 120		
	[Z18XER]	Chas. 71052537- 09.05-	CA1960IR 14 120	09.05-	CS1438 12 1.1
		Chas. -71052536 09.05-	CA1833IR 14 120		
Signum 1.9 CDTi	[Z19DT]		Chas. 71111928- 04.04- CA1994IR 14 140	04.04-	CS1264 12 1.7
			Chas. 71111928- 04.04- CA2045IR 14 120		
			Chas. -71111927 04.04- CA1884IR 14 105		
			Chas. -71111927 04.04- CA1885IR 14 120		
			Chas. -71111927 04.04- CA1890IR 14 130		
	[Z19DTH]		Chas. 71111928- 04.04- CA1994IR 14 140	AT 04.04-	CS1264 12 1.7
			Chas. 71111928- 04.04- CA2045IR 14 120	04.04-	CS1428 12 1.7
			Chas. -71111927 04.04- CA1884IR 14 105		
			Chas. -71111927 04.04- CA1885IR 14 120		
			Chas. -71111927 04.04- CA1890IR 14 130		
Signum 2.0 Turbo	[Z20NET]		05.03- CA1740IR 14 120	05.03-	CS1291 12 1.8
			05.03- CA1858IR 14 100		
Signum 2.0 DTi	[Y20DTH]		05.03- CA1577IR 14 120	05.03-	CS976 12 2.0
			05.03- CA1828IR 14 140		
Signum 2.2	[Z22YH]		05.03- CA1740IR 14 120	05.03-	CS1291 12 1.8
			05.03- CA1858IR 14 100		
Signum 2.2 DTi	[Y22DTR]		05.03- CA1577IR 14 120	05.03-	CS976 12 2.0
			05.03- CA1828IR 14 140		
Signum 2.8	[Z28NET]			10.06-	CS1488* 12
Signum 2.8 Turbo V6	[Z28NEL]			09.05-	CS1488* 12
	[Z28NET]			01.06-	CS1488* 12
Signum 3.2 V6	[Z32SE]		05.03- CA1730IR 14 140	05.03-	CS1247 12 1.7
Sintra 2.2 i 16V	[X22XE]		09.96- 09.99 CA1389IR 14 105	09.96- 09.99	CS879 12 1.1
Sintra 2.2 TD	[X22DTH]			09.97- 09.99	CS976 12 2.0
Sintra 3.0 i 24V	[X30XE]			09.96- 09.99	CS802 12 1.4
Speedster 2.0	[Z20LET]		10.03- 08.06 CA1581IR 14 100	10.03- 08.06	CS879 12 1.1
			10.03- 08.06 CA1740IR 14 120		
Speedster 2.0 Turbo	[Z20LET]		04.03- CA1581IR 14 100	04.03-	CS879 12 1.1
			04.03- CA1740IR 14 120		
Speedster 2.2 i	[Z22SE]		09.00- CA1592IR 14 100	Chas. -11009958 09.00-	CS1291 12 1.8
			09.00- CA1740IR 14 120	Chas. 11009959- 09.00-	CS1395 12 1.4
Tigra 1.3 CDTi	[Z13DT]		06.04- CA1862IR 14 90	12.04-	CS1334 12 1.1
			06.04- CA1934IR 14 105		
			06.04- CA1935IR 14 120		
Tigra 1.4 i 16V	[X14XE]		07.94- 08.99 CA1053IR 14 100	07.94- 08.99	CS519 12 1.0
			07.94- 08.99 CA1231IR 14 55	07.94- 08.99	CS535 12 0.9
			07.94- 08.99 CA861IR 14 70		
Tigra 1.4 i	[Z14XEP]		06.04- CA1658IR 14 120	06.04-	CS519 12 1.0
			06.04- CA1747IR 14 70		
			06.04- CA1748IR 14 100		
Tigra 1.6 i 16V	[C16SEL]		08.97- CA1053IR 14 100	08.97-	CS1257 12 1.1
			08.97- CA861IR 14 70	08.97-	CS519 12 1.0
	[X16XE]		07.94- 08.99 CA1045IR 14 120	07.94- 09.97	CS535 12 0.9
			07.94- 08.99 CA1053IR 14 100	08.97- 08.99	CS1257 12 1.1
			07.94- 08.99 CA861IR 14 70	07.94- 09.97	CS519 12 1.0
Tigra 1.8 i	[Z18XE]		06.04- CA1581IR 14 100	06.04-	CS1257 12 1.1
			06.04- CA1765IR 14 120		
Vectra A 1.4 S	[14NV]		04.88- 09.92 CA513IR 14 55	04.88- 09.92	CS162 12 0.7
			04.88- 09.92 CA514IR 14 70	04.88- 06.92	CS519 12 1.0
				09.88- 09.92	CS1257 12 1.1
		Chas. -MV206209, -M1173885, -M5247753 09.88- 09.92	CA519IR 14 65	04.88- 06.92	CS535 12 0.9
Vectra A 1.6	[16SV]		09.88- 08.91 CA513IR 14 55	09.88- 08.95	CS162 12 0.7
			09.88- 08.91 CA514IR 14 70	09.88- 08.95	CS535 12 0.9
			09.91- 08.95 CA1053IR 14 100	09.88- 08.95	CS519 12 1.0
			09.91- 08.95 CA861IR 14 70		
		PS 09.88- 08.91	CA519IR 14 65		
	[C16LZ]		08.92- 07.93 CA1045IR 14 120	08.92- 07.93	CS727 12 1.1
			08.92- 07.93 CA1053IR 14 100	08.92- 07.93	CS372 12 1.4
			08.92- 07.93 CA513IR 14 55		
		PS 08.92- 07.93	CA861IR 14 70		
Vectra A 1.6 i	[16LZ2]		09.93- 11.95 CA1053IR 14 100	09.93- 11.95	CS535 12 0.9
			09.93- 11.95 CA513IR 14 55	09.93- 11.95	CS162 12 0.7
			09.93- 11.95 CA861IR 14 70	09.93- 11.95	CS519 12 1.0
	[C16NZ]		09.88- 08.91 CA513IR 14 55	09.88- 08.95	CS519 12 1.0
			09.88- 08.91 CA514IR 14 70	09.88- 08.95	CS535 12 0.9
			09.91- 08.95 CA1053IR 14 100	09.88- 08.95	CS162 12 0.7
			09.91- 08.95 CA861IR 14 70		
		PS 09.88- 08.91	CA519IR 14 65		
	[C16NZ2]		09.93- 08.95 CA1053IR 14 100	09.93- 08.95	CS519 12 1.0
			09.93- 08.95 CA861IR 14 70	09.93- 08.95	CS727 12 1.1
		PS 09.93- 08.95	CA1045IR 14 120	09.93- 08.95	CS535 12 0.9
		PS 09.93- 08.95	CA861IR 14 70	09.93- 08.95	CS162 12 0.7



	[E16NZ]	09.88- 08.91 09.88- 08.91 09.91- 08.95 PS, Chas. S1000001- 09.91- 08.95 PS 09.88- 08.91 Chas. S1000001- 09.88- 10.90	CA513IR CA514IR CA1053IR CA861IR CA519IR CA1146IR	14 55 14 70 14 100 14 70 14 65 14 70		09.88- 08.95 09.88- 08.95 09.88- 08.95	CS162 CS519 CS535	12 0.7 12 1.0 12 0.9
	[X16SZ]	09.93- 11.95 09.93- 11.95	CA1053IR CA861IR	14 100 14 70		09.93- 11.95 09.93- 11.95 09.93- 11.95	CS519 CS535 CS162	12 1.0 12 0.9 12 0.7
Vectra A 1.6 S	[16SV]	09.88- 08.91 09.88- 08.91 09.91- 08.95 09.91- 08.95 PS 09.88- 08.91	CA513IR CA514IR CA1053IR CA861IR CA519IR	14 55 14 70 14 100 14 70 14 65		09.88- 08.95 09.88- 08.95 09.88- 08.95	CS162 CS535 CS519	12 0.7 12 0.9 12 1.0
Vectra A 1.7 Diesel	[17D]	10.88- 08.95	CA516IR	14 70		10.88- 08.95 10.88- 08.95	CS322 CS290	12 1.7 12 1.7
	[17DR]	10.88- 08.95	CA516IR	14 70		10.88- 08.95 10.88- 08.95	CS290 CS322	12 1.7 12 1.7
Vectra A 1.7 TD	[17DT]	03.90- 08.95	JA863IR	14 70		03.90- 08.95	JS753	12 1.4
	[X17DT]	03.90- 08.95	JA863IR	14 70		03.90- 08.95	JS753	12 1.4
Vectra A 1.8 i	[18SV]	09.88- 08.95 09.88- 09.91 09.91- 08.95 09.91- 08.95	CA515IR CA517IR CA1053IR CA861IR	14 90 14 70 14 100 14 70		09.88- 08.95 09.88- 08.95 09.88- 08.95	CS727 CS518 CS372	12 1.1 12 1.0 DR 12 1.4 BO
	[C18NZ]	03.90- 08.95 03.90- 08.91 09.91- 08.95 09.91- 08.95	CA515IR CA517IR CA1053IR CA861IR	14 90 14 70 14 100 14 70		A34 03.90- 08.95 A34 03.90- 08.95	CS372 CS518	12 1.4 BO 12 1.0 DR
Vectra A 1.8 S	[18SV]	09.89- 08.95 09.89- 08.95	CA515IR CA517IR	14 90 14 70		09.89- 08.95 09.89- 08.95	CS372 CS518	12 1.4 BO 12 1.0 DR
	[E18NVR]	09.88- 08.95 09.88- 08.95	CA515IR CA517IR	14 90 14 70		AT 09.88- 08.95 AT 09.88- 08.95 09.88- 07.95	CS518 CS372 CS727	12 1.0 12 1.4 BO 12 1.1 BO
Vectra A 1.8 S 4x4	[E18NVR]	01.89- 08.95 01.89- 08.95	CA515IR CA517IR	14 90 14 70		01.89- 08.95 01.89- 08.95	CS372 CS518	12 1.4 12 1.0 DR
Vectra A 2.0 16V 2000 GT	[C20XE]	09.89- 08.95 09.89- 08.92 09.91- 08.95 09.92- 08.95 09.92- 08.95	CA515IR CA517IR CA1053IR CA1045IR CA861IR	14 90 14 70 14 100 14 120 14 70		09.89- 08.95 09.89- 08.95	CS518 CS372	12 1.0 DR 12 1.4 BO
Vectra A 2.0 16V 2000 GT 4x4	[C20XE]	02.90- 08.95 02.90- 08.92 09.91- 08.95 09.92- 08.95 09.92- 08.95	CA515IR CA517IR CA1053IR CA1045IR CA861IR	14 90 14 70 14 100 14 120 14 70		02.90- 08.95 02.90- 08.95	CS372 CS518	12 1.4 BO 12 1.0 DR
Vectra A 2.0 GTi	[20SEH]	09.88- 08.95 09.88- 08.92 09.91- 08.95 09.92- 08.95 09.92- 08.95	CA515IR CA517IR CA1053IR CA1045IR CA861IR	14 90 14 70 14 100 14 120 14 70		A34 09.88- 08.95 A34 09.88- 08.95	CS518 CS372	12 1.0 DR 12 1.4 BO
Vectra A 2.0 i 16V	[20XEJ]	02.89- 10.90 02.89- 10.90	CA515IR CA517IR	14 90 14 70		02.89- 10.90 02.89- 10.90	CS372 CS518	12 1.4 BO 12 1.0 DR
	[C20XE]	02.90- 08.95 02.90- 09.92 09.91- 08.95 09.92- 08.95 09.92- 08.95	CA515IR CA517IR CA1053IR CA1045IR CA861IR	14 90 14 70 14 100 14 120 14 70		02.90- 08.95 02.90- 08.95	CS518 CS372	12 1.0 DR 12 1.4 BO
	[X20XEJ]	06.94- 11.95 06.94- 11.95 06.94- 11.95	CA1045IR CA1053IR CA861IR	14 120 14 100 14 70		06.94- 11.95	CS879	12 1.1
Vectra A 2.0 i 16V 2000 4x4	[20XEJ]	01.89- 10.90 01.89- 10.90	CA515IR CA517IR	14 90 14 70		01.89- 10.90 01.89- 10.90	CS372 CS518	12 1.4 BO 12 1.0 DR
Vectra A 2.0 i 16V 2000 GT	[20XEJ]	01.89- 06.94 01.89- 08.92 09.91- 06.94 09.92- 06.94 09.92- 06.94	CA515IR CA517IR CA1053IR CA1045IR CA861IR	14 90 14 70 14 100 14 120 14 70		01.89- 06.94 01.89- 06.94	CS518 CS372	12 1.0 DR 12 1.4 BO
Vectra A 2.0 i 16V 4x4	[X20XEJ]	06.94- 11.95 06.94- 11.95 06.94- 11.95	CA1045IR CA1053IR CA861IR	14 120 14 100 14 70		06.94- 11.95	CS879	12 1.1
Vectra A 2.0 i Turbo 4x4	[C20LET]	09.92- 08.95 09.92- 08.95 09.92- 08.95 09.92- 08.95	CA1045IR CA1053IR CA515IR CA861IR	14 120 14 100 14 90 14 70		09.92- 08.95 09.92- 08.95	CS372 CS518	12 1.4 BO 12 1.0 DR
Vectra A 2.0 i	[20NE]	09.88- 08.95 09.88- 08.92 09.91- 08.95 09.92- 08.95 09.92- 08.95	CA515IR CA517IR CA1053IR CA1045IR CA861IR	14 90 14 70 14 100 14 120 14 70		AT 09.88- 08.95 AT 09.88- 08.95 09.88- 08.95	CS518 CS372 CS727	12 1.0 DR 12 1.4 BO 12 1.1
	[20SEH]	09.88- 08.95 09.88- 09.92 09.91- 08.95 09.92- 08.95 09.92- 08.95	CA515IR CA517IR CA1053IR CA1045IR CA861IR	14 90 14 70 14 100 14 120 14 70		AT 09.88- 08.95 AT 09.88- 08.95	CS372 CS518	12 1.4 BO 12 1.0 DR
	[C20NE]	09.88- 08.95 09.88- 08.92 09.91- 08.95 09.92- 08.95 09.92- 08.95	CA515IR CA517IR CA1053IR CA1045IR CA861IR	14 90 14 70 14 100 14 120 14 70		09.88- 08.95 09.88- 08.95 09.88- 08.95	CS727 CS372 CS518	12 1.1 12 1.4 BO 12 1.0 DR
	[C20NEF]	04.88- 09.89 04.88- 09.89	CA515IR CA517IR	14 90 14 70		AT 04.88- 09.89 AT 04.88- 09.89	CS372 CS518	12 1.4 BO 12 1.0 DR
Vectra A 2.0 i 4x4	[20NE]	01.89- 08.95 01.89- 08.92 09.91- 08.95 09.92- 08.95 09.92- 08.95	CA515IR CA517IR CA1053IR CA1045IR CA861IR	14 90 14 70 14 100 14 120 14 70		01.89- 08.95 01.89- 08.95	CS372 CS518	12 1.4 BO 12 1.0 DR
	[20SEH]	01.89- 08.95 01.89- 09.92 09.91- 08.95 09.92- 08.95 09.92- 08.95	CA515IR CA517IR CA1053IR CA1045IR CA861IR	14 90 14 70 14 100 14 120 14 70		01.89- 08.95 01.89- 08.95	CS518 CS372	12 1.0 DR 12 1.4 BO



Opel Continued

	[C20NE]		01.89- 08.95 CA5151R 14 90		01.89- 08.95 CS518 12 1.0 DR
			01.89- 08.92 CA5171R 14 70		01.89- 08.95 CS372 12 1.4 BO
			09.91- 08.95 CA10531R 14 100		
			09.92- 08.95 CA10451R 14 120		
			09.92- 08.95 CA8611R 14 70		
Vectra A 2.5 i V6	[C25XE]		02.93- 08.95 CA10511R 14 70	02.93- 08.95	CS802 12 1.4
			02.93- 08.95 CA10701R 14 120		
			02.93- 08.95 CA11031R 14 100		
		AC	02.93- 08.95 CA15071R 14 120		
Vectra B 1.6 i 16V	[X16XEL]		09.95- 07.02 CA10451R 14 120	09.95- 07.02	CS1257 12 1.1
			09.95- 07.02 CA10531R 14 100	09.95- 07.02	CS1183 12 0.9
			09.95- 07.02 CA8611R 14 70	09.95- 07.02	CS519 12 1.0
				09.95- 07.02	CS535 12 0.9
	[Y16XE]		09.95- 09.02 CA10451R 14 120	09.95- 09.02	CS1257 12 1.1
			09.95- 09.02 CA10531R 14 100	09.95- 09.02	CS519 12 1.0
			09.95- 09.02 CA8611R 14 70	09.95- 09.02	CS535 12 0.9
				09.95- 09.02	CS1183 12 0.9
	[Z18XE]		09.00- 09.02 CA10451R 14 120	09.00- 09.02	CS1257 12 1.1
			09.00- 09.02 CA10531R 14 100	09.00- 09.02	CS535 12 0.9
			09.00- 09.02 CA8611R 14 70	09.00- 09.02	CS519 12 1.0
				09.00- 09.02	CS1183 12 0.9
Vectra B 1.6 i	[16LZ2]		09.95- 07.03 CA10451R 14 120	09.95- 07.03	CS1183 12 0.9
			09.95- 07.03 CA10531R 14 100	10.95- 04.02	CS727 12 1.1
			09.95- 07.03 CA8611R 14 70		
	[X16SZR]		10.95- 07.03 CA10451R 14 120	10.95- 07.03	CS519 12 1.0
			10.95- 07.03 CA10531R 14 100	10.95- 07.03	CS1183 12 0.9
			10.95- 07.03 CA8611R 14 70	10.95- 07.03	CS535 12 0.9
Vectra B 1.7 TD	[X17TD]		11.96- 12.97 JA11721R 14 70	11.96- 12.97	JS1091 12 1.2
		AC	11.96- 12.97 JA13701R 14 100		
Vectra B 1.7 TD	[X17DT (TC4EE1)]		09.95- 09.98 JA11721R 14 70	09.95- 09.98	JS1091 12 1.2
		AC	09.95- 09.98 JA13701R 14 100		
Vectra B 1.8 16V	[X18XE]		10.95- 09.00 CA10451R 14 120	10.95- 09.00	CS879 12 1.1
			10.95- 09.00 CA10531R 14 100		
			11.96- 09.00 CA8611R 14 70		
Vectra B 1.8 i 16V	[X18XE]		09.95- 09.00 CA10451R 14 120	09.95- 09.00	CS879 12 1.1
			09.95- 09.00 CA10531R 14 100		
			09.95- 09.00 CA8611R 14 70		
	[X18XE1]		06.98- 09.00 CA10451R 14 120	06.98- 09.00	CS1188 12 1.1
			06.98- 09.00 CA10531R 14 100		
			06.98- 09.00 CA8611R 14 70		
	[Z18XE]		09.00- 09.02 CA10451R 14 120	09.00- 09.02	CS1188 12 1.1
			09.00- 09.02 CA8611R 14 70		
Vectra B 2.0 i 16V	[C20SEL]		05.97- 09.02 CA10451R 14 120	05.97- 09.02	CS879 12 1.1
			05.97- 09.02 CA10531R 14 100		
			05.97- 09.02 CA8611R 14 70		
	[X20XE]		09.95- 09.02 CA10451R 14 120	09.95- 09.02	CS879 12 1.1
			09.95- 09.02 CA10531R 14 100		
			09.95- 09.02 CA8611R 14 70		
Vectra B 2.0 i	[20NEJ]		09.95- 02.02 CA10451R 14 120	09.95- 02.02	CS727 12 1.1
			09.95- 02.02 CA10531R 14 100		
			09.95- 02.02 CA8611R 14 70		
Vectra B 2.0 Diesel 16V	[X20DTL]		09.96- 08.02 CA13261R# 14 70	09.96- 08.02	CS976 12 2.0
			09.96- 08.02 CA13271R 14 100		
Vectra B 2.0 TD 16V	[X20DTH]		09.97- 08.03 CA13261R# 14 70	09.97- 08.03	CS976 12 2.0
			09.97- 08.03 CA13271R 14 100		
	[Y20DTH]		09.00- 09.03 CA14901R 14 70	09.00- 09.03	CS976 12 2.0
			09.00- 09.03 CA15011R 14 100		
			09.00- 09.03 CA15771R 14 120		
			09.97- 09.03 CA13261R# 14 70		
			09.97- 09.03 CA13271R 14 100		
Vectra B 2.2 i 16V	[Z22SE]		09.00- 09.03 CA15921R 14 100	Chas. 11170205-, 17085554- 09.00- 09.03	CS1395 12 1.4
			09.00- 09.03 CA17401R 14 120	Chas. -11170204-, -17085553 09.00- 09.03	CS1291 12 1.8
Vectra B 2.2 DTi 16V	[Y22DTR]		09.00- 09.03 CA15771R 14 120	09.00- 09.03	CS976 12 2.0
Vectra B 2.5 i V6	[X25XE]		09.95- 09.00 CA10701R 14 120	09.95- 09.00	CS802 12 1.4
			09.95- 09.00 CA11031R 14 100		
			11.97- 09.00 CA15071R 14 120		
		AC	10.95- 09.00 CA15071R 14 120		
Vectra B 2.5 i	[X25XE]		09.96- 09.00 CA10701R 14 120	09.96- 09.00	CS802 12 1.4
			09.96- 09.00 CA11031R 14 100		
			09.96- 09.00 CA15071R 14 120		
Vectra B 2.5 V6	[X25XE]		10.99- 06.00 CA15071R 14 120	10.99- 06.00	CS802 12 1.4
			10.99- 06.00 CA8551R 14 120		
Vectra B 2.6 i V6	[Y26SE]		09.00- 09.02 CA17301R 14 140	09.00- 09.02	CS1247 12 1.7
Vectra B CC 1.8 16V	[X18XE]		10.95- 09.00 CA10451R 14 120	10.95- 09.00	CS879 12 1.1
			10.95- 09.00 CA10531R 14 100		
			10.95- 09.00 CA8611R 14 70		
Vectra C 1.6	[Z16XEP]	Chas. 71052537- 01.06- CA19601R 14 120	01.06- CS1257 12 1.1		
		Chas. -71052536, Chas. -48999999 01.06- CA18331R 14 120	01.06- CS519 12 1.0		
		Chas. -71052536 01.06- CA18331R 14 120			
Vectra C 1.6 GTS	[Z16XE]	08.05- CA15811R 14 100	08.05- CS1257 12 1.1		
	[Z16XEP]	Chas. 71052537- 01.06- CA19601R 14 120	01.06- CS519 12 1.0		
		Chas. -71052536 01.06- CA18331R 14 120			
Vectra C 1.6 16V	[Z16XE]	06.04- 07.05 CA15811R 14 100	06.04- 07.05 CS1257 12 1.1		
		06.04- 07.05 CA17651R 14 120			
Vectra C 1.8	[Z18XEL]	04.02- 08.05 CA15811R 14 100	04.02- CS1257 12 1.1		
		04.02- 08.05 CA18211R 14 120			
		04.02- 08.05 CA8611R 14 70			
	[Z18XER]	01.06- CA18331R 14 120	01.06- CS1438 12 1.1		
Vectra C 1.8 GTS	[Z18XER]	Chas. 71052537- 01.06- CA19601R 14 120	01.06- CS1438 12 1.1		
		Chas. -71052536 01.06- CA18331R 14 120			
Vectra C 1.8 i 16V	[Z18XE]	04.02- CA15811R 14 100	04.02- CS1257 12 1.1		
		04.02- CA17651R 14 120			
		04.02- CA18211R 14 120			
	[Z18XEL]	04.02- CA15811R 14 100	04.02- CS1257 12 1.1		
		04.02- CA17651R 14 120			
		04.02- CA18211R 14 120			
Vectra C 1.8 i 16V GTS	[Z18XE]	08.02- CA15811R 14 100	08.02- CS1257 12 1.1		
		08.02- CA17651R 14 120			
		08.02- CA18211R 14 120			
	[Z18XEL]	08.02- CA15811R 14 100	08.02- CS1257 12 1.1		
		08.02- CA17651R 14 120			
		08.02- CA18211R 14 120			





Vectra C 1.8 i	[Z18XE]	10.03-	CA1581IR	14 100	09.03-	CS1257	12 1.1
		10.03-	CA1765IR	14 120			
		10.03-	CA1821IR	14 120			
Vectra C 1.9 CDTi	[Z19DT]	Chas. 71111928- 04.04-	CA1994IR	14 140	04.04-	CS1264	12 1.7
		Chas. 71111928- 04.04-	CA2045IR	14 120			
		Chas. -71111927 04.04-	CA1884IR	14 105			
		Chas. -71111927 04.04-	CA1885IR	14 120			
		Chas. -71111927 04.04-	CA1890IR	14 130			
	[Z19DTH]	Chas. 71111928- 04.04-	CA1994IR	14 140	04.04- AT 04.04-	CS1428 CS1264	12 1.7 12 1.7
		Chas. 71111928- 04.04-	CA2045IR	14 120			
		Chas. -71111927 04.04-	CA1884IR	14 105			
		Chas. -71111927 04.04-	CA1885IR	14 120			
		Chas. -71111927 04.04-	CA1890IR	14 130			
Vectra C 1.9 CDTi GTS	[Z19DT]	Chas. 71111928- 04.04-	CA1994IR	14 140	04.04-	CS1264	12 1.7
		Chas. 71111928- 04.04-	CA2045IR	14 120			
		Chas. -71111927 04.04-	CA1884IR	14 105			
		Chas. -71111927 04.04-	CA1885IR	14 120			
		Chas. -71111927 04.04-	CA1890IR	14 130			
	[Z19DTH]	Chas. 71111928- 04.04-	CA1994IR	14 140	04.04- AT 04.04-	CS1428 CS1264	12 1.7 12 1.7
		Chas. 71111928- 04.04-	CA2045IR	14 120			
		Chas. -71111927 04.04-	CA1884IR	14 105			
		Chas. -71111927 04.04-	CA1885IR	14 120			
		Chas. -71111927 04.04-	CA1890IR	14 130			
Vectra C 2.0 Turbo 16V	[Z20NET]	03.03-	CA1740IR	14 120	03.03-	CS1291	12 1.8
		Chas. 31085253-, 38060500- 03.03-	CA1592IR	14 100			
		Chas. -31085252-, -38060499 03.03-	CA1858IR	14 100			
Vectra C 2.0 Turbo 16V GTS	[Z20NET]	03.03-	CA1740IR	14 120	03.03-	CS1291	12 1.8
		Chas. 31085253-, 38060500- 03.03-	CA1592IR	14 100			
		Chas. -31085252-, -38060499 03.03-	CA1858IR	14 100			
Vectra C 2.0 Turbo	[Z20NET]	10.03-	CA1740IR	14 120	10.03-	CS1291	12 1.8
		Chas. 31085253-, 38060500- 10.03-	CA1592IR	14 100			
		Chas. -31085252-, -38060499 10.03-	CA1858IR	14 100			
Vectra C 2.0 DTi 16V	[Y20DTH]	04.02-	CA1577IR	14 120	04.02-	CS976	12 2.0
		04.02-	CA1828IR	14 140			
Vectra C 2.0 DTi 16V GTS	[Y20DTH]	08.02-	CA1577IR	14 120	08.02-	CS976	12 2.0
		08.02-	CA1828IR	14 140			
Vectra C 2.0 DTi	[Y20DTH]	09.03- 09.05	CA1577IR	14 120	09.03- 09.05	CS976	12 2.0
		09.03- 09.05	CA1828IR	14 140			
Vectra C 2.2 Direct	[Z22YH]	10.03-	CA1740IR	14 120	10.03-	CS1395	12 1.4
		Chas. 31085253-, 38060500- 10.03-	CA1592IR	14 100			
		Chas. -31085252-, -38060499 10.03-	CA1858IR	14 100			
Vectra C 2.2 GTS Direct	[Z22YH]	10.03-	CA1740IR	14 120	10.03-	CS1395	12 1.4
		Chas. 31085253-, 38060500- 10.03-	CA1592IR	14 100			
		Chas. -31085252-, -38060499 10.03-	CA1858IR	14 100			
Vectra C 2.2 i 16V	[Z22SE]	04.02-	CA1740IR	14 120	Chas. 31090426- 04.02- Chas. 31090425 04.02-	CS1395 CS1291	12 1.4 12 1.8
		Chas. 31085253-, 38060500- 04.02-	CA1592IR	14 100			
		Chas. -31085252-, -38060499 04.02-	CA1858IR	14 100			
Vectra C 2.2 i 16V GTS	[Z22SE]	08.02-	CA1740IR	14 120	Chas. 31090425 08.02- Chas. 31090426- 08.02-	CS1291 CS1395	12 1.8 12 1.4
		Chas. 31085253-, 38060500- 08.02-	CA1592IR	14 100			
		Chas. -31085252-, -38060499 08.02-	CA1858IR	14 100			
Vectra C 2.2 DTi 16V	[Y22DTR]	04.02-	CA1577IR	14 120	04.02-	CS976	12 2.0
		04.02-	CA1828IR	14 140			
Vectra C 2.2 DTi 16V GTS	[Y22DTR]	08.02-	CA1577IR	14 120	08.02-	CS976	12 2.0
		08.02-	CA1828IR	14 140			
Vectra C 2.2 DTi	[Y22DTR]	09.03- 09.05	CA1577IR	14 120	09.03- 09.05	CS976	12 2.0
		09.03- 09.05	CA1828IR	14 140			
Vectra C 2.8 Turbo V6	[Z28NEL]				08.05-	CS1488*	12
Vectra C 2.8 Turbo V6 GTS	[Z28NEL]				08.05-	CS1488*	12
Vectra C 2.8 V6 Turbo	[Z28NET]				08.05-	CS1488*	12
Vectra C 3.2 i V6	[Z32SE]	08.02-	CA1730IR	14 140	08.02-	CS1247	12 1.7
		RHD 09.03-	CA1730IR	14 140			
Vectra C 3.2 i V6 GTS	[Z32SE]	08.02-	CA1730IR	14 140	08.02-	CS1247	12 1.7
Vivaro 1.9 Di	[F9Q762]	08.06-	CA1627IR	14 125	08.06-	CS1255	12 0.9
		AC 08.06-	CA1661IR	14 125			
Vivaro 1.9 Diesel Di	[F9Q762]	08.01-	CA1645IR	14 125	08.01-	CS1193	12 1.8
		AC 08.01-	CA1627IR	14 125			
Vivaro 1.9 Diesel	[F9Q760]	08.06-	CA1627IR	14 125	08.06-	CS1193	12 1.8
		AC 08.06-	CA1661IR	14 125			
	[F9Q774]	08.01-	CA1645IR	14 125	08.01-	CS1193	12 1.8
		AC 08.01-	CA1627IR	14 125			
Vivaro 1.9 DTi	[F9Q760]	08.01-	CA1645IR	14 125	08.01-	CS1193	12 1.8
		AC 08.01-	CA1627IR	14 125			
Vivaro 2.0 Ecotec	[F4R720]	08.06-	CA1829IR	14 100			
		AC 08.06-	CA1627IR	14 125			
		A23 08.06-	CA1661IR	14 125			
			CA1829IR	14 100			
			CA1824IR	14 150			
Vivaro 2.0 16V	[F4R820]	08.06-	CA1829IR	14 100	08.06-	CS1255	12 0.9
			CA1824IR	14 150			
	[F4R]	08.06-	CA1829IR	14 100	08.06-	CS1255	12 0.9
		Heated windscreen 08.06-	CA1661IR	14 125			
	[F4R720]	AC 08.06-	CA1627IR	14 125	08.01-	CS1255	12 0.9
		08.01-	CA1829IR	14 100			
		AC 08.01-	CA1627IR	14 125			
		AC 08.01-	CA1661IR	14 125			
		AC 08.01-	CA1824IR	14 150			
		A22 08.01-	CA1627IR	14 125			
A22 08.01-	CA1661IR	14 125					
Vivaro 2.0 CDTi	[M9R780]	01.06-	CA1959IR	14 150	01.06-	CS1415	12 2.2
			CA1827IR	14 150			
Vivaro 2.5 CDTi	[G9MB6]	08.06-	CA1827IR	14 150	08.06-	CS1207	12 2.0
			CA1827IR	14 150			
Vivaro 2.5 CDTi Combi	[G9U630]	08.06-	CA1827IR	14 150	08.06-	CS1207	12 2.0
			CA1827IR	14 150			
Vivaro 2.5 DTi	[G9U730]	05.03-	CA1627IR	14 125	05.03-	CS1207	12 2.0
		AC 05.03-	CA1661IR	14 125			
Zafira 1.6 CNG		07.05-	CA1391IR	14 65	07.05-	CS1257	12 1.1
		07.05-	CA1765IR	14 120			
		07.05-	CA1581IR	14 45			
Zafira 1.6 EcoFlex CNG	[Z16XNT]	02.09-	CA1973IR	14 120	02.09-	CS1438	12 1.1
Zafira 1.6	[Z16YNG]	01.06-	CA1391IR	14 70	01.06-	CS1257	12 1.1
		01.06-	CA1581IR	14 100			
		01.06-	CA1765IR	14 120			
		01.06-	CA1821IR	14 120			



**OPEL Continued**

Zafira 2.0 CDTi	[A20DTH]	10.11-	CA2005IR	14 100	10.11- AT 10.11-	CS1428 CS1264	12 1.7 12 1.7	
	[A20DTL]	10.11-	CA2005IR	14 100	10.11- 10.11-	CS1264 CS1448*	12 1.7 12 2.7	
Zafira A 1.6 16V	[X16XEL]	04.99- 07.05	CA1391IR	14 70	04.99- 07.05	CS519	12 1.0	
		04.99- 07.05	CA1581IR	14 100	04.99- 07.05	CS1257	12 1.1	
		04.99- 07.05	CA1821IR	14 120				
	Chas. -12257452, -15257663, -18131574	04.99- 07.05	CA1765IR	14 120				
	[Z16XE]	09.00- 07.05	CA1821IR	14 120	09.00- 07.05	CS1257	12 1.1	
		04.99- 07.05	CA1391IR	14 70	04.99- 07.05	CS519	12 1.0	
		04.99- 07.05	CA1581IR	14 100				
		09.00- 07.05	CA1765IR	14 120				
Zafira A 1.6 i	[Z16YNG]	09.01- 09.01-	CA1391IR	14 70	09.01- 09.01-	CS1257	12 1.1	
			CA1581IR	14 100	Chas. -22999999, -259, -269, -289, -2B9, -2H9	CS519	12 1.0	
		09.01- 09.01-	CA1765IR	14 120				
			CA1821IR	14 120				
Zafira A 1.8 16V	[X18XE1]	04.99- 09.00	CA1391IR	14 70	04.99- 09.00	CS1188	12 1.1	
		04.99- 09.00	CA1581IR	14 100	Chas. 6G000001- 04.99- 09.00	CS1257	12 1.1	
		04.99- 09.00	CA1821IR	14 120				
	Chas. -12257452, -15257663, -18131574	04.99- 09.00	CA1765IR	14 120				
	[Z18XE]	09.00- 07.05	CA1391IR	14 70	09.00- 07.05	CS1188	12 1.1	
		09.00- 07.05	CA1581IR	14 100				
		09.00- 07.05	CA1821IR	14 120				
		09.00- 07.05	CA1765IR	14 120				
Zafira A 2.0	[Z20LET]	09.01- 06.05	CA1581IR	14 100	09.01- 06.05	CS879	12 1.1	
		09.01- 06.05	CA1765IR	14 120				
		09.01- 06.05	CA1821IR	14 120				
Zafira A 2.0 OPC	[Z20LET]	11.02- 07.05	CA1581IR	14 100	09.01- 07.05	CS879	12 1.1	
		11.02- 07.05	CA1765IR	14 120				
		11.02- 07.05	CA1821IR	14 120				
Zafira A 2.0 Diesel Di 16V	[X20DTL]	10.99- 06.05	CA1490IR	14 70	10.99- 06.05	CS976	12 2.0	
		10.99- 06.05	CA1501IR	14 100				
		10.99- 06.05	CA1577IR	14 120				
		A19 10.99- 06.05	CA1582IR	14 120				
Zafira A 2.0 DTi 16V	[Y20DTH]	04.99- 07.05	CA1490IR	14 70	04.99- 07.05	CS976	12 2.0	
		04.99- 07.05	CA1501IR	14 100				
		A19 04.99- 07.05	CA1582IR	14 120				
Zafira A 2.2 16V	[Z22SE]	09.00- 07.05	CA1592IR	14 100	Chas. -22012028, - 25005804, -28038498, -1H031120	09.00- 07.05	CS1291	12 1.8
		09.00- 07.05	CA1740IR	14 120	Chas. 22012029, -25005805-, -28038499-, -1H031121-	09.00- 07.05	CS1395	12 1.4
Zafira A 2.2 DTi 16V	[Y22DTR]	01.02- 07.05	CA1577IR	14 120	01.02- 07.05	CS976	12 2.0	
		01.02- 07.05	CA1828IR	14 140				
		A19 01.02- 07.05	CA1582IR	14 120				
		A19 01.02- 06.05	CA2067IR*	14 140				
Zafira B 1.6	[Z16XEP]	07.05-	CA1833IR	14 120	Chas. -6G038808, Chas. 62097898	07.05-	CS519	12 1.0
		07.05-	CA1882IR	14 100	Chas. 6G038809-, Chas. 62097899-	07.05-	CS1438	12 1.1
				Chas. -6G038808, Chas. 62097898	07.05-	CS1257	12 1.1	
	[Z16XER]	01.08-	CA1882IR	14 100	01.08-	CS1438	12 1.1	
		Chas. 7G066982 01.08-	CA1960IR	14 120				
	Chas. -7G066981 01.08-	CA1833IR	14 120					
	Chas. 72095157- 01.08-	CA1960IR	14 120					
	Chas. -72095156 01.08-	CA1833IR	14 120					
Zafira B 1.7 CDTi	[A17DTJ]	01.08-	CA2010IR	14 100	01.08-	JS1158	12 1.4	
		AC 01.08-	CA2017IR	14 140				
	[A17DTR]	01.08-	CA2010IR	14 100	01.08-	JS1158	12 1.4	
		AC 01.08-	CA2017IR	14 140				
Zafira B 1.8	[Z18XEP]	07.05-	CA1833IR	14 120	07.05-	CS1438	12 1.1	
		07.05-	CA1882IR	14 100				
	[Z18XER]	07.05-	CA1833IR	14 120	07.05-	CS1438	12 1.1	
		07.05-	CA1882IR	14 100				
Zafira B 1.9 CDTi	[Z19DT]	07.05-	CA1884IR	14 105	07.05-	CS1264	12 1.7	
		07.05-	CA1885IR	14 120				
		07.05-	CA1890IR	14 130				
		07.05-	CA1994IR	14 140				
		07.05-	CA2045IR	14 120				
	[Z19DTH]	07.05-	CA1884IR	14 105	AT 07.05-	CS1264	12 1.7	
		07.05-	CA1885IR	14 120	07.05-	CS1428	12 1.7	
		07.05-	CA1890IR	14 130				
		07.05-	CA1994IR	14 140				
		07.05-	CA2045IR	14 120				
Zafira B 2.0	[Z20LEH]	01.06-	CA1909IR	14 120	01.06-	CS879	12 1.1	
	[Z20LER]	07.05-	CA1909IR	14 120	07.05-	CS879	12 1.1	
Zafira B 2.2	[Z22YH]				07.05-	CS1395	12 1.4	
Zafira Van 1.6 Turbo CNG	[A16XNT]	02.09-	CA1973IR	14 120				
	[Z16XNT]	02.09-	CA1973IR	14 120				
Zafira Van 1.7 CDTi	[A17DTJ]	01.08-	CA2010IR	14 100	01.08-	JS1158	12 1.4	
		01.08-	CA2017IR	14 140				
	[A17DTR]	01.08-	CA2010IR	14 100	01.08-	JS1158	12 1.4	
		01.08-	CA2017IR	14 140				
	[Z17DTJ]	01.08-	CA2010IR	14 100	01.08-	JS1158	12 1.4	
		01.08-	CA2017IR	14 140				
Zafira Van 1.8	[A18XER]	07.05-	CA1833IR	14 120				
	[Z18XEP]	07.05-	CA1833IR	14 120				
	[Z18XER]	07.05-	CA1833IR	14 120				
<b>PASSENGER CARS US</b>								
1900 1.9					01.73- 01.74	CS70	12 0.8	
1900 1.9 Rallye					01.71- 01.72	CS70	12 0.8	
Deluxe 1.1		01.71- 01.71	CA48IR	14 45				
GT 1.1		01.69- 01.70	CA48IR	14 45	01.69- 01.70	CS66	12 0.65	
GT 1.9					01.71- 01.73	CS70	12 0.8	
Isuzu 1.8		01.76- 01.76	JA144	14 45				
Kadett 1.1		01.67- 01.72	CA48IR	14 45	01.67- 01.72	CS66	12 0.65	
Kadett 1.1 DLX		01.68- 01.70	CA48IR	14 45	01.68- 01.70	CS66	12 0.65	
Kadett 1.1 LS		01.68- 01.68	CA48IR	14 45	01.68- 01.68	CS66	12 0.65	
Kadett 1.1 Rallye					01.67- 01.67	CS66	12 0.65	
Kadett 1.1 Rallye DLX		01.68- 01.70	CA48IR	14 45	01.68- 01.70	CS66	12 0.65	
Manta 1.9					01.73- 01.74	CS70	12 0.8	



PASSENGER CARS AO										
Astra H 1.4	[Z14XEL]	04.04- 10.04	CA1747IR	14	70	04.04- 10.04	CS519	12	1.0	
		04.04- 10.04	CA1748IR	14	100					
		10.04- 09.05	CA1940IR	14	100					
Corsa A 1.3 GL	[13S]	09.82- 03.93	CA513IR	14	55	09.82- 03.93	CS162	12	0.7	
		09.82- 03.93	CA514IR	14	70	09.82- 03.93	CS1183	12	0.9	
Corsa A 1.3 TR GL	[13S]	09.82- 03.93	CA513IR	14	55	09.82- 03.93	CS162	12	0.7	
		09.82- 03.93	CA514IR	14	70	09.82- 03.93	CS1183	12	0.9	
Corsa B 1.7 DTi	[Y17DT]	08.01-	JA1526IR	14	70	08.01-	JS1158	12	1.4	
		AC 08.01-	JA1521IR	14	100					
Kadett E 1.6	[E16SE]	09.87- 08.91	CA513IR	14	55	09.87- 08.91	CS1183	12	0.9	
		09.87- 08.91	CA514IR	14	70	09.87- 08.91	CS162	12	0.7	
Vectra A 2.5 CD 4x4	[C25XE]	08.92- 08.95	CA1051IR	14	70	DR	09.94- 08.95	CS1247	12	1.7
		08.92- 08.95	CA1070IR	14	120	BO	08.92- 08.94	CS802	12	1.4
		08.92- 08.95	CA1103IR	14	100	DR				
Zafira 1.6	[Z16YNG]	09.02- 06.05	CA1391IR	14	70	09.02- 06.05	CS1257	12	1.1	
		09.02- 06.05	CA1581IR	14	100					
		09.02- 06.05	CA1765IR	14	120					
Zafira 1.8	[Z18XEL]	02.03-	CA1581IR	14	100	02.03-	CS1257	12	1.1	
		02.03-	CA1765IR	14	120					
Padane										
TRUCKS EU										
ZX 14.6	[OM422.907]	01.81-	CA1035IR	28	80	01.81-	CS191	24	5.4	
		01.81-	CA333IR	28	55					
		01.81-	CA854IR	28	35					
Perkins										
MOTORS										
403C-07 0.7 3R							CS1471	12	2.0	
403C-10 1.0 3R							CS1471	12	2.0	
403C-11 1.1 3R							CS1471	12	2.0	
403C-15 1.5 3R							CS1471	12	2.0	
404C-20 2.0 4R							CS1471	12	2.0	
404C-22 2.2 4R							CS1471	12	2.0	
404C-22T 2.2 4R44							CS1471	12	2.0	
6-354						01.80-	CS700	24	5.2	
6-372						01.80-	CS700	24	5.2	
Various Models							CS1471	12	2.0	
						01.70-	CS695	12	2.6	
Peugeot										
PASSENGER CARS EU										
104 1.0	[108 (XV3)] [108 (XV5)]	10.72- 10.79	CA2911R	14	50	10.72- 10.79	CS355	12	0.85	
		10.72- 10.83	CA2911R	14	50	09.82- 10.83	CS142	12	0.85	
						08.79- 10.84	CS142	12	0.85	
104 1.1	[108C (XV8)]	08.79- 06.88	CA2911R	14	50	08.79- 10.84	CS355	12	0.85	
						09.83- 06.88	CS142	12	0.85	
104 1.1	[109 (XW3)] [109F (XW7)]	07.76- 06.88	CA2911R	14	50	07.76- 06.88	CS142	12	0.85	
		07.76- 06.88	CA2911R	14	50	11.84- 06.88	CS355	12	0.85	
						07.76- 10.84	CS142	12	0.85	
104 1.2	[121 (XW3S)] [129 (XZ5)]	08.75- 06.88	CA2911R	14	50	08.79- 06.83	CS142	12	0.85	
						08.79- 06.84	CS142	12	0.85	
104 1.4	[150 (XY6B)]	08.79- 06.84	CA2911R	14	50	08.79- 06.84	CS142	12	0.85	
106 1.0	[CDY (TU9M)] [CDZ (TU9M)]	09.91- 04.96	CA617IR	14	50	09.91- 04.96	CS581	12	1.0	
		07.92- 04.96	CA618IR	14	70					
		09.91- 04.96	CA617IR	14	50	09.91- 04.96	CS581	12	1.0	
106 1.0 i	[CDY (TU9M)] [CDZ (TU9M)]	09.91- 04.96	CA618IR	14	70	09.91- 04.96	CS390	12	0.9	
		AC 09.91- 04.96	CA715IR	14	80					
		05.96- 05.05	CA618IR	14	70	05.96- 05.05	CS581	12	1.0	
106 1.1	[HDZ (TU1M)]	09.91- 04.96	CA617IR	14	50	09.91- 04.96	CS1111	12	0.7	
		09.91- 04.96	CA618IR	14	70	09.91- 04.96	CS581	12	1.0	
						01.97- 05.05	CS581	12	1.0	
106 1.1 i	[HDY (TU1M)] [HDZ (TU1M)] [HFX (TU1JP)]	03.00- 05.05	CA1641IR	14	80	01.97- 05.05	CS1111	12	0.7	
		03.00- 05.05	CA1642IR	14	97	01.97- 05.05	CS581	12	1.0	
		01.97- 05.98	CA618IR	14	70					
		AC 01.97- 05.05	CA1305IR	14	65					
		AC 05.98- 05.05	CA1243IR	14	90					
		05.96- 05.05	CA1642IR	14	97	05.96- 05.05	CS581	12	1.0	
		05.96- 05.05	CA618IR	14	70	05.96- 05.05	CS1111	12	0.7	
		09.98- 05.05	CA1641IR	14	80					
		AC 05.96- 05.05	CA1305IR	14	65					
		AC 05.98- 05.05	CA1243IR	14	90					
106 1.3	[TU2J2]	03.00- 05.05	CA1641IR	14	80	03.00- 05.05	CS581	12	1.0	
		03.00- 05.05	CA1642IR	14	97	03.00- 05.05	CS390	12	0.9	
		03.00- 05.05	CA1642IR	14	97	03.00- 05.05	CS1111	12	0.7	
106 1.4	[KDX (TU3MC)] [KDY (TU3M)] [KFZ (TU3J2/Z)] [TU3]	10.93- 04.96	CA617IR	14	50	10.93- 04.96	CS581	12	1.0	
		10.93- 04.96	CA618IR	14	70					
		12.92- 04.96	CA617IR	14	50	12.92- 04.96	CS390	12	0.9	
		12.92- 04.96	CA618IR	14	70	12.92- 04.96	CS581	12	1.0	
		AC 12.92- 04.96	CA715IR	14	80					
		09.91- 04.96	CA617IR	14	50	09.91- 04.96	CS581	12	1.0	
		09.91- 04.96	CA618IR	14	70					
		09.91- 04.96	CA715IR	14	80					
		09.91- 04.96	CA617IR	14	50	09.91- 04.96	CS581	12	1.0	
		09.91- 04.96	CA618IR	14	70					
106 1.4 i	[KFW (TU3JP)] [KFX (TU3JP)]	08.91- 03.96	CA617IR	14	50	08.91- 03.96	CS581	12	1.0	
		08.91- 03.96	CA618IR	14	70	08.91- 03.96	CS390	12	0.9	
		AC 08.91- 03.96	CA715IR	14	80					
106 1.4 Diesel	[K9Y (TUD3Y)]	03.00- 05.05	CA1305IR	14	65	03.00- 05.05	CS1111	12	0.7	
		03.00- 05.05	CA618IR	14	70	03.00- 05.05	CS581	12	1.0	
		03.00- 05.05	CA715IR	14	80	03.00- 05.05	CS390	12	0.9	
		05.96- 05.05	CA1305IR	14	65	05.96- 05.05	CS1111	12	0.7	
		05.96- 05.05	CA618IR	14	70	05.96- 05.05	CS581	12	1.0	
106 1.5 Diesel	[TUD5] [VJX (TUD5)]	09.98- 05.05	CA715IR	14	80					
		09.98- 05.05	CA1641IR	14	80					
		09.92- 04.96	CA1095IR	14	70	09.92- 04.96	CS542	12	1.4	
		09.92- 04.96	CA617IR	14	50					
		06.94- 04.96	CA1038IR	14	70	06.94- 04.96	CS542	12	1.4	
106 1.5 Diesel	[TUD5] [VJX (TUD5)]	06.94- 04.96	CA1583IR	14	90					
		08.94- 04.96	CA1203IR	14	80					
		07.00- 05.05	CA1038IR	14	70	07.00- 05.05	CS542	12	1.4	
		07.00- 05.05	CA1155IR	14	70					
		10.00-	CA1203IR	14	80					



**PEUGEOT** *Continued*

	[VJY (TUD5)]	06.94- 05.05 06.94- 05.05 08.94- 05.05	CA1038IR CA1583IR CA1203IR	14 70 14 90 14 80		06.94- 05.05	CS542	12 1.4
106 1.6	[NFY (TU5J2)]	01.94- 04.96 01.94- 04.96 AC 01.94- 04.96	CA617IR CA618IR CA715IR	14 50 14 70 14 80		01.94- 04.96	CS581	12 1.0
	[NFZ (TU5JP)]	06.93- 04.96 06.93- 04.96 AC 06.93- 04.96	CA617IR CA618IR CA715IR	14 50 14 70 14 80		06.93- 04.96	CS581	12 1.0
106 1.6 i	[NFW (TU5J2)]	05.96- 05.05 05.96- 05.05	CA1155IR CA1243IR	14 70 14 90		05.96- 05.05 05.96- 05.05	CS1111 CS581	12 0.7 12 1.0
	[NFY (TU5J2)]	05.96- 05.05 05.96- 05.05 05.96- 05.05 09.98- 05.05	CA1155IR CA1243IR CA715IR CA1642IR	14 70 14 90 14 80 14 97		05.96- 05.05 05.96- 05.05	CS390 CS581 CS1111	12 0.9 12 1.0 12 0.7
	[NFZ (TU5JP)]	05.96- 05.05 05.96- 05.05 05.96- 05.05 09.98- 05.05 09.98- 05.05 09.98- 05.05	CA1243IR CA1305IR CA715IR CA1640IR CA1641IR CA1642IR	14 90 14 65 14 80 14 70 14 80 14 97		05.96- 05.05 05.96- 05.05	CS581 CS1111	12 1.0 12 0.7
106 1.6 S 16	[NFX (TU5J4)]	05.96- 05.05 05.96- 05.05 09.98- 05.05 09.98- 05.05	CA1243IR CA715IR CA1641IR CA1642IR	14 90 14 80 14 80 14 97		05.96- 05.05 05.96- 05.05	CS581 CS1111	12 1.0 12 0.7
107 1.0	[CFA(384F)]	06.05- 06.05-	CA1949IR CA1978IR	14 80 14 70		06.05-	CS1407	12 1.1
107 1.4 HDi	[DV4TED]	06.05- 06.05-	CA1589IR CA1674IR	14 90 14 150		06.05- 06.05-	CS1260 CS1329	12 1.1 12 1.5
205 1.0	[108C (XV8)]					02.83- 10.87	CS355	12 0.85
	[TU9]	10.87- 09.98 10.87- 09.98 AC 10.87- 09.98	CA359IR CA533IR CA639IR	14 50 14 70 14 80		10.87- 09.98	CS390	12 0.9
205 1.1	[109F (XW7)]	02.83- 10.87	CA291IR	14 50		02.83- 10.87	CS355	12 0.85
	[109N (XW7)]	10.87- 10.90	CA369IR	14 50		08.86- 10.90	CS355	12 0.85
	[H1B (TU1)]	10.87- 10.90 10.87- 10.90	CA359IR CA533IR	14 50 14 70		10.87- 10.90	CS390	12 0.9
	[HDZ (TU1M)]	07.89- 09.98 07.89- 09.98 AC 07.89- 09.98	CA359IR CA533IR CA639IR	14 50 14 70 14 80		07.89- 09.98	CS390	12 0.9
		02.83- 07.90	CA533IR	14 70		02.83- 07.90	CS581	12 1.0
205 1.1 CJ	[HDZ (TU1M)]	02.83- 07.90 10.89- 09.98 10.89- 09.98	CA359IR CA359IR CA533IR	14 50 14 50 14 70		02.83- 07.90 10.89- 09.98	CS390 CS390	12 0.9 12 0.9
205 1.2	[F1]	01.87- 12.90	CA369IR	14 50		01.87- 12.90	CS306	12 1.05
205 1.3		02.84- 10.87	CA369IR	14 50		02.84- 10.87	CS306	12 1.05
205 1.3 Rally	[TU24]	10.87- 10.90 AC 10.87- 10.90 A13 10.87- 10.90	CA359IR CA639IR CA533IR	14 50 14 80 14 70		10.87- 10.90	CS390	12 0.9
205 1.4	[150 (XY6B)]	02.83- 10.87 02.83- 10.87	CA291IR CA369IR	14 50 14 50		02.83- 10.87	CS355	12 0.85
	[150B (XY8)]	02.83- 12.88 02.83- 12.88	CA291IR CA369IR	14 50 14 50		02.83- 12.88	CS355	12 0.85
	[150D (XY7)]	02.83- 05.89 02.83- 05.89	CA291IR CA369IR	14 50 14 50		02.83- 05.89	CS355	12 0.85
	[150G (XY7)]	02.83- 10.90 02.83- 10.90	CA291IR CA369IR	14 50 14 50		02.83- 10.90	CS355	12 0.85
	[150H (XY8)]	10.85- 05.89 10.85- 05.89	CA291IR CA369IR	14 50 14 50		10.85- 05.89	CS355	12 0.85
	[K1D (TU3A)]	10.87- 10.90 10.87- 10.90	CA359IR CA533IR	14 50 14 70		10.87- 10.90	CS390	12 0.9
	[K2B (TU3S)]	06.87- 12.89 06.87- 12.89	CA359IR CA533IR	14 50 14 70		06.87- 12.89	CS390	12 0.9
	[KAY (TU3CP)]	08.87- 09.93 08.87- 09.93	CA359IR CA533IR	14 50 14 70		08.87- 09.93	CS390	12 0.9
	[KDY (TU3M)]	07.88- 09.98 07.88- 09.98 AC 07.88- 09.98	CA359IR CA533IR CA639IR	14 50 14 70 14 80		07.88- 09.98 07.90- 09.98	CS390 CS581	12 0.9 12 1.0
	[KDZ (TU3M)]	07.88- 09.98 07.88- 09.98 AC 07.88- 09.98	CA359IR CA533IR CA639IR	14 50 14 70 14 80		07.90- 09.98 07.88- 09.98	CS581 CS390	12 1.0 12 0.9
	[KFX (TU3JP)]	07.88- 09.98	CA715IR	14 80		07.88- 09.98	CS581	12 1.0
	[Y2A]	06.87- 10.90 AC 06.87- 10.90	CA369IR CA369IR	14 50 14 50		06.87- 10.90	CS306	12 1.05
		08.90- 07.98	CA533IR	14 70		08.90- 07.98	CS390	12 0.9
		08.90- 07.98	CA359IR	14 50				
205 1.4 CJ	[150D (XY7)]	03.88- 05.89 03.88- 05.89	CA291IR CA369IR	14 50 14 50		03.88- 05.89	CS355	12 0.85
	[150G (XY7)]	10.87- 10.90 10.87- 10.90	CA291IR CA369IR	14 50 14 50		10.87- 10.90	CS355	12 0.85
	[K1D (TU3A)]	03.89- 03.89-	CA359IR CA533IR	14 50 14 70		03.89-	CS390	12 0.9
	[KDY (TU3M)]	05.91- 12.94 05.91- 12.94	CA359IR CA533IR	14 50 14 70		05.91- 12.94	CS390	12 0.9
	[KDZ (TU3M)]	06.91- 12.94 A13 06.91- 12.94	CA359IR CA533IR	14 50 14 70		06.91- 12.94 06.91- 12.94	CS390 CS581	12 0.9 12 1.0
205 1.4 CT	[150B (XY8)]	02.83- 12.88 02.83- 12.88	CA291IR CA369IR	14 50 14 50		02.83- 12.88	CS355	12 0.85
	[150H (XY8)]	02.83- 12.88	CA291IR	14 50		02.83- 12.88	CS355	12 0.85
205 1.6	[B1A (XU51C)]	08.86- 10.90 08.86- 10.90	CA294IR CA380IR	14 50 14 70		08.86- 10.90	CS326	12 0.85
	[B1E (XU51C)]	03.87- 09.98 03.87- 09.98	CA294IR CA380IR	14 50 14 70		03.87- 09.98 10.87- 09.98	CS326 CS566	12 0.85 12 1.1
	[BAZ (XU5CP)]	02.83- 10.90 02.83- 10.90	CA294IR CA380IR	14 50 14 70		02.83- 10.90	CS326	12 0.85
	[BDY (XU5M2Z)]	05.90- 09.98 05.90- 09.98	CA294IR CA380IR	14 50 14 70		05.90- 09.98 05.90- 09.98	CS566 CS326	12 1.1 12 0.85
	[BDY (XU5M3Z)]	05.90- 09.98 05.90- 09.98	CA294IR CA380IR	14 50 14 70		05.90- 09.98 05.90- 09.98	CS566 CS326	12 1.1 12 0.85



	[XU5IC]	10.87- 09.98	CA294IR	14 50	10.87- 09.98	CS566	12 1.1
		10.87- 09.98	CA380IR	14 70	10.87- 09.98	CS326	12 0.85
		08.90- 07.92	CA380IR	14 70	08.90- 07.92	CS566	12 1.1
		08.90- 07.92	CA294IR	14 50	08.90- 07.92	CS326	12 0.85
205 1.6 CJ	[BDY (XU5M3Z)]	11.90- 09.98	CA294IR	14 50	11.90- 09.98	CS326	12 0.85
		11.90- 09.98	CA380IR	14 70	11.90- 09.98	CS566	12 1.1
205 1.6 CTi	[180A (XU5J)]	04.86- 10.90	CA294IR	14 50	04.86- 10.90	CS326	12 0.85
		04.86- 10.90	CA380IR	14 70	04.86- 10.90	CS566	12 1.1
		04.86- 10.90	CA532IR	14 80			
	[180Z (XU5J)]	10.83- 10.90	CA294IR	14 50	10.83- 10.90	CS326	12 0.85
		10.83- 10.90	CA380IR	14 70			
205 1.6 GTX		01.87- 10.91	CA369IR	14 50	01.87- 10.91	CS306	12 1.05
205 1.6 GTi	[180A (XU5J)]	12.84- 12.89	CA294IR	14 50	12.84- 12.89	CS326	12 0.85
		12.84- 10.87	CA380IR	14 70	10.87- 12.89	CS566	12 1.1
		10.87- 12.89	CA532IR	14 80			
	[180Z (XU5J)]	10.87- 10.90	CA294IR	14 50	10.87- 10.90	CS326	12 0.85
		10.87- 10.90	CA532IR	14 80			
	[XU5JA]	10.87- 12.89	CA294IR	14 50	10.87- 12.89	CS326	12 0.85
		10.87- 12.89	CA380IR	14 70			
205 1.7 Diesel	[161A (XUD7)]	07.87- 09.98	CA294IR	14 50	07.87- 09.98	CS373	12 1.7
		07.87- 09.98	CA532IR	14 80	A13 07.87- 09.98	CS570	12 3.1
205 1.8	[XUD7T]	08.90- 05.97	CA294IR	14 50	08.90- 05.97	CS373	12 1.7
		08.90- 05.97	CA532IR	14 80			
205 1.8 Diesel	[161A (XUD7)]	08.83- 12.89	CA294IR	14 50	08.83- 10.87	CS342#	12 1.5
		08.83- 12.89	CA532IR	14 80	08.83- 12.89	CS373	12 1.7
					A13 07.87- 12.89	CS570	12 3.1
	[A8B (XUD7TE)]	01.90- 09.98	CA294IR	14 50	11.90- 09.98	CS373	12 1.7
		01.90- 09.98	CA532IR	14 80			
	[A9A (XUD7)]	02.83- 07.90	CA294IR	14 50	02.83- 07.90	CS373	12 1.7
		02.83- 07.90	CA532IR	14 80	02.83- 07.90	CS570	12 3.1
205 1.9 CTi	[DFZ (XU9J1)]	10.87- 12.94	CA294IR	14 50	10.87- 12.94	CS326	12 0.85
		10.87- 12.94	CA380IR	14 70	10.87- 12.94	CS566	12 1.1
205 1.9 CTi		08.87- 07.90	CA294IR	14 50	08.87- 07.90	CS326	12 0.85
		08.87- 07.90	CA380IR	14 70	08.87- 07.90	CS566	12 1.1
205 1.9 GTi	[D2A (XU92C)]	10.87- 05.89	CA294IR	14 50	10.87- 05.89	CS326	12 0.85
		10.87- 05.89	CA380IR	14 70			
	[D6B (XU9JA)]	10.86- 09.98	CA294IR	14 50	10.86- 09.98	CS326	12 0.85
		10.86- 09.98	CA380IR	14 70	11.90- 09.98	CS566	12 1.1
	[DFZ (XU9J1)]	03.87- 07.94	CA294IR	14 50	11.90- 07.94	CS566	12 1.1
		03.87- 07.94	CA380IR	14 70	03.87- 07.94	CS326	12 0.85
	[DKZ (XU9JAZ)]	10.87- 10.94	CA294IR	14 50	10.87- 10.94	CS326	12 0.85
		10.87- 10.94	CA380IR	14 70	11.90- 10.94	CS566	12 1.1
205 1.9 Diesel	[DJZ (XUD9Y)]	10.87- 09.98	CA294IR	14 50	10.87- 09.98	CS373	12 1.7
		10.87- 09.98	CA380IR	14 70	A13 10.87- 09.98	CS570	12 3.1
206 1.1	[HFX (TU1JP)]	PS 07.02- ACPS 07.02- ACPS 07.02-	CA1498IR CA1499IR CA1589IR	14 70 14 80 14 90	07.02- 07.02-	CS1111 CS581	12 0.7 12 1.0
206 1.1 i	[HFX (TU1JP)]	03.00- 03.00- PS 03.00- PS 03.00- ACPS 03.00- ACPS 09.98-	CA1496IR CA1646IR CA1442IR CA1498IR CA1499IR CA1589IR	14 80 14 120 14 70 14 70 14 80 14 90	03.00- 03.00- 03.00- 03.00-	CS581 CS390 CS1111	12 1.0 12 0.9 12 0.7
	[HFZ (TU1JP)]	PS 09.98- ACPS 09.98- ACPS 09.98-	CA1498IR CA1499IR CA1589IR	14 70 14 80 14 90	06.98-	CS1111	12 0.7
206 1.4	[KFW (TU3JP)]	07.02- PS 07.02- ACPS 07.02- ACPS 07.02-	CA1932IR CA1498IR CA1499IR CA1589IR	14 60 14 70 14 80 14 90	07.02- 07.02-	CS581 CS1111	12 1.0 12 0.7
	[TU3JP]	03.07-	CA1498IR	14 70	03.07-	CS581	12 1.0
206 1.4 16V	[KFU (ET3J4)]	10.03- 10.03- 10.03- 10.03- 10.03- 10.03-	CA1498IR CA1499IR CA1589IR CA1674IR CA1741IR CA1932IR	14 70 14 80 14 90 14 150 14 120 14 60	10.03- 10.03-	CS1111 CS581	12 0.7 12 1.0
206 1.4 i	[KFW (TU3JP)]	03.00- 03.00- 01.03- PS 03.00- PS 09.98- PS 09.98- ACPS 09.98- ACPS 09.98-	CA1496IR CA1646IR CA1932IR CA1442IR CA1498IR CA1499IR CA1498IR CA1499IR	14 80 14 120 14 60 14 70 14 70 14 80 14 70 14 80	03.00- 03.00- 03.00-	CS581 CS1111 CS390	12 1.0 12 0.7 12 0.9
	[KFX (TU3JP)]	01.03- PS 09.98- PS 09.98- ACPS 09.98- ACPS 09.98-	CA1932IR CA1498IR CA1499IR CA1498IR CA1499IR	14 60 14 70 14 80 14 70 14 80	06.98- 09.98-	CS1111 CS581	12 0.7 12 1.0
206 1.4 HDi	[8HX (DV4TD)]	07.02- 07.02- 09.02- 02.07 09.02- 02.07	CA1674IR CA1850IR CA1850IR CA1674IR	14 150 14 150 14 150 14 150	07.02- 09.02- 02.07	CS1260	12 1.1
206 1.4 HDi eco	[8HX (DV4TD)]	09.01- 09.01-	CA1674IR CA1850IR	14 150 14 150	09.01- 09.01-	CS1260 CS1329	12 1.1 12 1.5
	[8HZ (DV4TD)]	09.01- 09.01-	CA1674IR CA1850IR	14 150 14 150	09.01- 09.01-	CS1260 CS1329	12 1.1 12 1.5
206 1.4 HDi eco 70	[8HX (DV4TD)]	09.08-	CA1761IR	14 150	09.08- 09.08-	CS1329 CS1260	12 1.5 12 1.1
206 1.6 16V	[NFU (TU5JP4)]	09.00- 09.00- 09.00- 09.00- 03.07- PS 07.02- ACPS 09.00- ACPS 07.02- ACPS 07.02-	CA1442IR CA1496IR CA1498IR CA1499IR CA1589IR CA1665IR CA1498IR CA1564IR CA1499IR CA1589IR	14 70 14 80 14 70 14 80 14 90 14 80 14 70 14 90 14 80 14 90	09.00- 09.00-	CS1111 CS581	12 0.7 12 1.0
206 1.6 i	[NFZ (TU5JP)]	09.98- PS 09.98- ACPS 09.98- ACPS 09.98-	CA1442IR CA1498IR CA1499IR CA1589IR	14 70 14 70 14 80 14 90	06.98- 06.98- 06.98-	CS390 CS581 CS1111	12 0.9 12 1.0 12 0.7



**PEUGEOT** *Continued*

206 1.6 HDi	[9HZ (DV6TED4)]	04.05-	CA1761IR	14 150	04.05-	CS1329	12 1.5	
					04.05-04.05-	CS1260	12 1.1	
206 1.6 HDi FAP	[9HY (DV6TED4)]	05.04-05.04-	CA1646IR	14 120	05.04-	CS1329	12 1.5	
			CA1761IR	14 150	05.04-	CS1391	12 2.2	
	[9HZ (DV6TED4)]	05.04-05.04-	CA1646IR	14 120	05.04-	CS1391	12 2.2	
			CA1761IR	14 150	05.04-05.04-	CS1329	12 1.5	
					05.04-	CS1260	12 1.1	
					05.04-	CS1391	12 2.2	
				05.04-	CS1260	12 1.1		
206 1.9 Diesel	[WJZ (DW8)]	09.98-09.98-09.98-11.01	CA1442IR	14 70	09.98-	CS594	12 1.4	
			CA1496IR	14 80				
			CA1932IR	14 60				
			CA1564IR	14 90				
		ACPS 09.98-	CA1674IR	14 150				
206 2.0 RC	[RFK (EW10J4S)]	07.03-	CA1674IR	14 150	07.03-	CS1277	12 1.4	
206 2.0 16V	[RFN (EW10J4)]	03.02-	CA1496IR	14 80	03.02-	CS1277	12 1.4	
		03.02-	CA1646IR	14 120	03.02-	CS1244	12 1.1	
206 2.0 S 16	[RFN (EW10J4)]	09.00-09.00-09.00-09.00-	CA1442IR	14 70	A13 09.00-09.00-	CS1244	12 1.1	
			CA1498IR	14 70				
			CA1564IR	14 90				
				CA1674IR	14 150			
				CA1442IR	14 70	04.99-10.00	CS1277	12 1.4
				CA1564IR	14 90	04.99-10.00	CS1244	12 1.1
206 2.0 HDi	[RHY (DW10TD)]	03.02-	CA1496IR	14 80	12.99-	CS594	12 1.4	
		03.02-	CA1646IR	14 120	12.99-	CS1177	12 1.7	
		07.02-12.02	CA1553IR	14 150				
		01.03-	CA1761IR	14 150				
		12.99-06.02	CA1509IR	14 150				
		12.99-	CA1564IR	14 90				
207 1.4	[KfV (TU3A)]	02.06-	CA1665IR	14 80	02.06-	CS390	12 0.9	
					02.06-	CS581	12 1.0	
					06.07-	CS1111	12 0.7	
					06.07-	CS390	12 0.9	
					06.07-	CS581	12 1.0	
207 1.4 16V	[EP3]	06.07-06.07-06.07-06.07-	CA1954IR	14 120	06.07-	CS1417	12 0.9	
			CA1990IR*	14 120				
			CA2006IR	14 150				
				CA2087IR*	14 80			
				CA1665IR	14 80	02.06-	CS581	12 1.0
				CA1741IR	14 120	02.06-	CS390	12 0.9
207 1.4 HDi	[8HZ (DV4TD)]	02.06-	CA1761IR	14 150	02.06-	CS1329	12 1.5	
					02.06-	CS1260	12 1.1	
207 1.6 16V Turbo	[5FX (EP6DT)]	10.09-10.09-10.09-10.09-	CA1954IR	14 120				
			CA1990IR*	14 120				
			CA2006IR	14 150				
			CA2087IR*	14 80				
207 1.6 16V	[5FW (EP6)]	06.07-06.07-06.07-06.07-	CA1954IR	14 120	06.07-	CS1417	12 0.9	
			CA1990IR*	14 120				
			CA2006IR	14 150				
				CA2087IR*	14 80			
				CA1954IR	14 120	02.07-	CS1417	12 0.9
				CA1990IR*	14 120			
			CA1665IR	14 80	02.06-	CS390	12 0.9	
			CA1687IR	14 70	02.06-	CS581	12 1.0	
207 1.6 16V RC	[EP6DTS]	02.07-02.07-02.07-	CA1954IR	14 120	02.07-	CS1417	12 0.9	
			CA1990IR*	14 120				
			CA2006IR	14 150				
207 1.6 Turbo 16V	[5FX (EP6DT)]	02.06-02.06-02.06-	CA1954IR	14 120	02.06-	CS1417	12 0.9	
			CA1990IR*	14 120				
			CA2006IR	14 150				
				CA1954IR	14 120	02.07-	CS1417	12 0.9
				CA2006IR	14 150			
				CA1990IR*	14 120			
207 1.6 VTi 16V	[EP6]	02.07-07.07-	CA1954IR	14 120	02.07-	CS1417	12 0.9	
			CA1990IR*	14 120				
207 1.6 HDi	[9HL (DV6C)]	08.09-08.09-	CA1761IR	14 150	08.09-	CS1329	12 1.5	
			CA2008IR	14 150				
				CA1761IR	14 150	02.06-	CS1391	12 2.2
						02.06-	CS1260	12 1.1
						02.06-	CS1329	12 1.5
						02.06-	CS1391	12 2.2
						02.06-	CS1260	12 1.1
						02.06-	CS1329	12 1.5
						02.06-	CS1391	12 2.2
						02.06-	CS1260	12 1.1
						02.06-	CS1329	12 1.5
					11.09-	CS1391	12 2.2	
					11.09-	CS1329	12 1.5	
					02.07-	CS1391	12 2.2	
					02.07-	CS1329	12 1.5	
208 1.4 HDi					03.12-	CS1260	12 1.1	
					03.12-	CS1329	12 1.5	
208 1.6		03.12-	CA1954IR	14 120	03.12-	CS1417	12 0.9	
208 1.6 HDi					03.12-	CS1329	12 1.5	
					03.12-	CS1260	12 1.1	
					03.12-	CS1391	12 2.2	
304 1.1	[XK5]				Chas. 4181230-08.76-08.78	CS168	12 0.8	
304 1.3	[XL5]				09.76-10.80	CS168	12 0.8	
305 1.3	[118 (XL5)]				11.77-08.86	CS168	12 0.8	
	[XL5]				11.77-09.82	CS168	12 0.8	
305 1.5	[117 (XR5S)]				05.80-09.82	CS168	12 0.8	
	[142 (XR5)]				11.79-08.86	CS168	12 0.8	
	[142 (XR5A)]				09.85-07.90	CS168	12 0.8	
305 1.6	[171 (XU5S)]	10.82-12.87	CA294IR	14 50	10.82-12.87	CS566	12 1.1	
					10.82-12.87	CS326	12 0.85	
				CA294IR	14 50	10.82-06.88	CS566	12 1.1
						10.82-06.88	CS326	12 0.85
				CA294IR	14 50	10.82-12.88	CS566	12 1.1
						10.82-12.88	CS326	12 0.85
			CA294IR	14 50	11.86-12.88	CS326	12 0.85	
					11.86-12.88	CS566	12 1.1	
305 1.9	[159 (XU9S)]	10.82-10.87	CA294IR	14 50	10.82-10.87	CS566	12 1.1	
			CA380IR	14 70				
			CA532IR	14 80				



	[DFZ (XU9J1)]	11.86- 12.88 11.86- 12.88 11.86- 12.88	CA294IR CA380IR CA532IR	14 50 14 70 14 80		11.86- 12.88 11.86- 12.88 11.86- 12.88	CS326 CS566 CS326	12 0.85 12 1.1 12 1.5
305 1.9 Diesel	[162 (XUD9)]	10.82- 07.90 10.82- 07.90 10.82- 07.90	CA294IR CA380IR CA532IR	14 50 14 70 14 80		10.82- 12.88 10.82- 07.90 10.82- 07.90	CS342# CS373 CS373	12 1.5 12 1.7 12 1.7
	[D9A (XUD9)]	10.82- 07.90 10.82- 07.90 10.82- 07.90	CA294IR CA380IR CA532IR	14 50 14 70 14 80		10.82- 07.90 10.82- 07.90 10.82- 07.90	CS373 CS342# CS342#	12 1.7 12 1.5 12 1.5
306 1.1	[HDZ (TU1M)]	01.93- 04.97 01.93- 04.97 01.93- 04.97	CA617IR CA618IR CA715IR	14 50 14 70 14 80		01.93- 04.97 01.93- 04.97 01.93- 04.97	CS581 CS581 CS581	12 1.0 12 1.0 12 1.0
306 1.4	[KDX (TU3MC)]	01.93- 04.97 01.93- 04.97 AC 01.93- 04.97	CA617IR CA618IR CA715IR	14 50 14 70 14 80		01.93- 04.97 01.93- 04.97 01.93- 04.97	CS581 CS581 CS581	12 1.0 12 1.0 12 1.0
	[KFW (TU3JP)]	10.00- 10.03 10.00- 10.03 PS 10.00- 10.03	CA618IR CA715IR CA1305IR	14 70 14 80 14 65		10.00- 10.03 10.00- 10.03 10.00- 10.03	CS390 CS581 CS581	12 0.9 12 1.0 12 1.0
	[KFX (TU3JP)]	09.96- 04.97 09.96- 10.03 09.96- 10.03 05.97- 10.03	CA617IR CA618IR CA715IR CA1305IR	14 50 14 70 14 80 14 65		05.97- 10.03 09.96- 10.03 09.96- 10.03 05.97- 10.03	CS1111 CS581 CS581 CS581	12 0.7 12 1.0 12 1.0 12 1.0
		04.93- 10.94 04.93- 10.94 04.93- 10.94	CA715IR CA618IR CA617IR	14 80 14 70 14 50		04.93- 10.94 04.93- 10.94 04.93- 10.94	CS581 CS581 CS581	12 1.0 12 1.0 12 1.0
306 1.4 SL	[KDX (TU3MC)]	02.93- 04.97 02.93- 04.97 ACPS 02.93- 04.97	CA617IR CA618IR CA715IR	14 50 14 70 14 80		02.93- 04.97 02.93- 04.97 02.93- 04.97	CS581 CS581 CS581	12 1.0 12 1.0 12 1.0
	[KFW (TU3JP)]	10.00- 10.03 10.00- 10.03 PS 10.00- 10.03	CA618IR CA715IR CA1305IR	14 70 14 80 14 65		10.00- 10.03 10.00- 10.03 10.00- 10.03	CS390 CS581 CS581	12 0.9 12 1.0 12 1.0
	[KFX (TU3JP)]	09.96- 04.97 09.96- 10.03 05.97- 10.03 05.97- 10.03 ACPS 09.96- 04.97	CA617IR CA618IR CA715IR CA1305IR CA715IR	14 50 14 70 14 80 14 65 14 80		05.97- 10.03 09.96- 10.03 09.96- 10.03 05.97- 10.03	CS1111 CS581 CS581 CS581	12 0.7 12 1.0 12 1.0 12 1.0
306 1.4 i	[KFW (TU3JP)]	10.00- 10.03 10.00- 10.03 PS 10.00- 10.03	CA618IR CA715IR CA1305IR	14 70 14 80 14 65		10.00- 10.03 10.00- 10.03 10.00- 10.03	CS390 CS581 CS581	12 0.9 12 1.0 12 1.0
	[KFX (TU3JP)]	03.97- 03.02 03.97- 03.02	CA1305IR CA1305IR	14 65 14 65		03.97- 03.02 03.97- 03.02	CS581 CS581	12 1.0 12 1.0
306 1.6	[NFT (TU5JP/L4)]	10.00- 04.02 10.00- 04.02	CA1640IR CA1641IR	14 70 14 80		10.00- 10.03 10.00- 10.03	CS581 CS390	12 1.0 12 0.9
	[NFZ (TU5JP)]	01.93- 04.97 01.93- 10.03 03.97- 10.03 03.97- 10.03 ACPS 03.97- 10.03	CA617IR CA618IR CA1305IR CA715IR CA715IR	14 50 14 70 14 65 14 80 14 80		05.97- 10.03 01.93- 10.03 01.93- 10.03 01.93- 10.03	CS1111 CS581 CS581 CS581	12 0.7 12 1.0 12 1.0 12 1.0
306 1.6 SR	[NFZ (TU5JP)]	01.93- 04.97 01.93- 10.03 05.97- 10.03 ACPS 01.93- 10.03	CA617IR CA618IR CA1305IR CA715IR	14 50 14 70 14 65 14 80		05.97- 10.03 01.93- 10.03 01.93- 10.03 01.93- 10.03	CS1111 CS581 CS581 CS581	12 0.7 12 1.0 12 1.0 12 1.0
306 1.8	[LFZ (XU7JP)]	01.93- 04.97 01.93- 10.03 01.93- 10.03 PS 05.97- 10.03 ACPS 05.97- 10.03 AC 03.97- 03.02	CA730IR CA820IR CA825IR CA820IR CA1086IR CA1086IR	14 80 14 70 14 95 14 70 14 80 14 80		01.93- 10.03 01.93- 10.03 01.93- 10.03 01.93- 10.03 01.93- 10.03	CS715 CS566 CS566 CS566 CS715 CS715	12 1.4 12 1.1 12 1.1 12 1.1 12 1.4 12 1.4
306 1.8 ST	[LFZ (XU7JP)]	06.94- 04.97 06.94- 04.97 06.94- 10.03 PS 05.97- 10.03 ACPS 05.97- 10.03	CA730IR CA820IR CA825IR CA820IR CA1086IR	14 80 14 70 14 95 14 70 14 80		06.94- 10.03 06.94- 10.03 06.94- 10.03 06.94- 10.03	CS566 CS715 CS715 CS566 CS566	12 1.1 12 1.4 12 1.4 12 1.1 12 1.1
306 1.8 16V	[LFY (XU7JP4)]	03.97- 10.03 03.97- 10.03 03.97- 10.03 AC 03.97- 10.03	CA1052IR CA1151IR CA1152IR CA1052IR	14 90 14 70 14 80 14 90		03.97- 10.03 03.97- 10.03 03.97- 10.03 03.97- 10.03	CS715 CS566 CS566 CS566	12 1.4 12 1.1 12 1.1 12 1.1
306 1.8 Diesel	[A9A (XUD7)]	05.93- 10.03 05.93- 10.03 05.93- 04.97 PS 05.97- 10.03 ACPS 07.95- 10.03 ACPS 07.95- 10.03	CA1086IR CA637IR CA638IR CA1155IR CA1043IR CA1065IR	14 80 14 70 14 80 14 70 14 80 14 95		04.97- 10.03 05.93- 04.97 04.97- 02.02 05.93- 04.97 05.93- 04.97	CS1177 CS373 CS594 CS712 CS712	12 1.7 12 1.7 12 1.4 12 2.2 12 2.2
306 1.9 Diesel	[DHW (XUD9BSD)]	03.98- 10.03 03.98- 10.03 PS 03.98- 10.03 PS 03.98- 10.03 PS 03.98- 10.03	CA1086IR CA637IR CA1043IR CA1065IR CA1155IR	14 80 14 70 14 80 14 95 14 70		05.97- 10.03 05.97- 10.03 05.97- 10.03 05.97- 10.03	CS1177 CS594 CS594 CS594	12 1.7 12 1.4 12 1.4 12 1.4
	[DJY (XUD9A)]	06.94- 10.03 06.94- 04.97 06.94- 10.03 06.94- 10.03 03.97- 03.02 PS 03.97- 03.02 PS 03.97- 03.02 PS 03.97- 03.02 ACPS 06.94- 04.97 ACPS 06.94- 06.95	CA1065IR CA636IR CA637IR CA638IR CA1086IR CA1043IR CA1065IR CA1155IR CA1043IR CA638IR	14 95 14 50 14 70 14 80 14 80 14 80 14 95 14 70 14 80 14 80		06.94- 10.03 06.94- 10.03 03.97- 03.02 03.97- 03.02 03.97- 03.02 03.97- 03.02 03.97- 03.02 03.97- 03.02 03.97- 03.02	CS373 CS712 CS594 CS594 CS373 CS551 CS551	12 1.7 12 2.2 12 1.4 12 1.4 12 1.7 12 1.4 12 1.4
	[DJZ (XUD9Y)]	05.93- 06.94 05.93- 06.94 05.93- 06.94	CA636IR CA637IR CA638IR	14 50 14 70 14 80		05.93- 06.94 05.93- 06.94 05.93- 06.94	CS373 CS551 CS551	12 1.7 12 1.4 12 1.4
	[WJY (DW8B)]	09.98- 10.03 09.98- 10.03 09.99- 10.03 09.99- 10.03 PS 09.98- 10.03 PS 09.98- 10.03 PS 09.98- 10.03	CA1086IR CA637IR CA1442IR CA1496IR CA1043IR CA1065IR CA1155IR	14 80 14 70 14 70 14 80 14 80 14 95 14 70		09.99- 10.03 09.99- 10.03 09.99- 10.03 09.99- 10.03 09.98- 10.03 09.98- 10.03 09.98- 10.03	CS594 CS1177 CS594 CS1177 CS594 CS1177 CS1177	12 1.4 12 1.7 12 1.4 12 1.7 12 1.4 12 1.4 12 1.4
	[WJZ (DW8)]	09.98- 10.03 09.98- 10.03 09.98- 10.03 09.98- 10.03 PS 09.98- 10.03 PS 09.98- 10.03 PS 09.98- 10.03	CA1086IR CA1442IR CA1496IR CA637IR CA1043IR CA1065IR CA1155IR	14 80 14 70 14 80 14 70 14 80 14 95 14 70		09.98- 10.03 09.98- 10.03 09.98- 10.03 09.98- 10.03 09.98- 10.03 09.98- 10.03 09.98- 10.03	CS594 CS1177 CS594 CS1177 CS594 CS1177 CS1177	12 1.4 12 1.4 12 1.4 12 1.4 12 1.4 12 1.4 12 1.4



**PEUGEOT** *Continued*

	[XUD9TE]	02.94- 04.99	CA1043IR	14 80	02.94- 04.99	CS373	12 1.7
		02.94- 04.99	CA637IR	14 70			
		ACPS 02.94- 04.99	CA638IR	14 80			
306 1.9 Diesel SLD	[DJY (XUD9A)]	06.94- 04.97	CA636IR	14 50	06.94- 10.03	CS594	12 1.4
		06.94- 10.03	CA637IR	14 70	06.97- 10.03	CS1177	12 1.7
		06.94- 04.97	CA638IR	14 80			
		07.95- 10.03	CA1065IR	14 95			
		05.97- 10.03	CA1086IR	14 80			
		PS 05.97- 10.03	CA1155IR	14 70			
		ACPS 06.94- 06.95	CA638IR	14 80			
		ACPS 07.95- 10.03	CA1043IR	14 80			
	[DJZ (XUD9Y)]	05.93- 06.94	CA636IR	14 50	05.93- 06.94	CS594	12 1.4
		05.93- 06.94	CA637IR	14 70	05.93- 06.94	CS1177	12 1.7
		05.93- 06.94	CA638IR	14 80			
306 1.9 Diesel SRDT	[DHY (XUD9TE)]	05.93- 10.03	CA637IR	14 70	06.94- 10.03	CS712	12 2.2
		05.93- 10.03	CA638IR	14 80	06.94- 10.03	CS373	12 1.7
		07.95- 10.03	CA1065IR	14 95			
		05.97- 10.03	CA1155IR	14 70			
		ACPS 05.93- 06.95	CA638IR	14 80			
		ACPS 07.95- 10.03	CA1043IR	14 80			
306 1.9 TD	[DHY (XUD9TE)]	05.93- 10.03	CA1065IR	14 95	05.93- 10.03	CS551	12 1.4
		05.93- 04.97	CA636IR	14 50	02.97- 03.02	CS712	12 2.2
		05.93- 10.03	CA637IR	14 70	05.93- 10.03	CS373	12 1.7
		05.93- 10.03	CA638IR	14 80			
		02.97- 03.02	CA1043IR	14 80			
		02.97- 03.02	CA1086IR	14 80			
		PS 02.97- 10.03	CA1155IR	14 70			
		ACPS 05.93- 10.03	CA1043IR	14 80			
		ACPS 05.93- 10.03	CA638IR	14 80			
306 2.0	[RFV (XU10J4R)]	03.97- 10.03	CA1052IR	14 90			
		03.97- 10.03	CA1151IR	14 70			
		03.97- 10.03	CA1152IR	14 80			
	[RFX (XU10J2)]	08.93- 06.96	CA1086IR	14 80	08.93- 04.97	CS715	12 1.4
		08.93- 06.96	CA820IR	14 70	08.93- 04.97	CS566	12 1.1
		08.93- 06.96	CA825IR	14 95			
		07.96- 04.97	CA1052IR	14 90			
		07.96- 04.97	CA1151IR	14 70			
		07.96- 04.97	CA1152IR	14 80			
		07.96- 04.97	CA1156IR	14 120			
		05.97- 06.00	CA1152IR	14 80			
		05.97- 06.00	CA1151IR	14 70			
		05.97- 06.00	CA1052IR	14 90			
306 2.0 ST	[RFX (XU10J2)]	07.94- 06.96	CA1086IR	14 80	07.94- 04.97	CS715	12 1.4
		07.94- 06.96	CA820IR	14 70	07.94- 04.97	CS566	12 1.1
		07.94- 06.96	CA825IR	14 95			
		07.96- 04.97	CA1052IR	14 90			
		07.96- 04.97	CA1151IR	14 70			
		07.96- 04.97	CA1152IR	14 80			
		07.96- 04.97	CA1156IR	14 120			
306 2.0 16V	[RFV (XU10J4R)]	03.97- 10.03	CA1052IR	14 90			
		03.97- 10.03	CA1151IR	14 70			
		03.97- 10.03	CA1152IR	14 80			
306 2.0 i 16V	[RFS (XU10J4RS)]	07.96- 10.03	CA1052IR	14 90			
		07.96- 10.03	CA1151IR	14 70			
		07.96- 10.03	CA1152IR	14 80			
	[RFT (XU10J4)]	06.94- 06.96	CA1086IR	14 80			
		06.94- 06.96	CA820IR	14 70			
		06.94- 06.96	CA825IR	14 95			
		07.96- 04.97	CA1052IR	14 90			
		07.96- 04.97	CA1151IR	14 70			
		07.96- 04.97	CA1152IR	14 80			
		07.96- 04.97	CA1156IR	14 120			
306 2.0 i XS	[RFX (XU10J2)]	05.93- 06.96	CA1086IR	14 80	05.93- 04.97	CS566	12 1.1
		05.93- 06.96	CA820IR	14 70	05.93- 04.97	CS715	12 1.4
		05.93- 06.96	CA825IR	14 95			
		07.96- 04.97	CA1052IR	14 90			
		07.96- 04.97	CA1151IR	14 70			
		07.96- 04.97	CA1152IR	14 80			
		07.96- 04.97	CA1156IR	14 120			
306 2.0 S 16	[RFT (XU10J4)]	06.94- 06.96	CA1086IR	14 80			
		06.94- 06.96	CA820IR	14 70			
		06.94- 06.96	CA825IR	14 95			
		07.96- 04.97	CA1052IR	14 90			
		07.96- 04.97	CA1151IR	14 70			
		07.96- 04.97	CA1152IR	14 80			
		07.96- 04.97	CA1156IR	14 120			
	[RFY (XU10J4Z)]	06.94- 06.96	CA1086IR	14 80			
		06.94- 06.96	CA820IR	14 70			
		06.94- 06.96	CA825IR	14 95			
		07.96- 04.97	CA1052IR	14 90			
		07.96- 04.97	CA1151IR	14 70			
		07.96- 04.97	CA1152IR	14 80			
		07.96- 04.97	CA1156IR	14 120			
306 2.0 HDi	[RHY (DW10TD)]	06.99- 10.03	CA1509IR	14 150	06.99- 10.03	CS1177	12 1.7
		06.99- 10.03	CA1564IR	14 90			
307 1.4	[KFW (TU3JP)]	08.00-	CA1665IR	14 80	08.00-	CS1111	12 0.7
		08.00-	CA1681IR	14 90	08.00-	CS581	12 1.0
		08.00-	CA1687IR	14 70			
		08.00-	CA1741IR	14 120			
307 1.4 16V	[KFU (ET3J4)]	11.03-	CA1665IR	14 80	11.03-	CS1111	12 0.7
		11.03-	CA1741IR	14 120	11.03-	CS581	12 1.0
307 1.4 HDi	[8HX (DV4TD)]	10.01-	CA1674IR	14 150	10.01- 02.02	CS1260	12 1.1
	[8HZ (DV4TD)]	10.01- 02.02	CA1674IR	14 150	10.01- 02.02	CS1260	12 1.1
307 1.6 16V	[NFU (TU5JP4)]	03.02-	CA1665IR	14 80	03.02-	CS581	12 1.0
		03.02-	CA1681IR	14 90	03.02-	CS1111	12 0.7
		03.02-	CA1687IR	14 70			
	[TU5JP4]	08.00-	CA1665IR	14 80	08.00-	CS390	12 0.9
		08.00-	CA1681IR	14 90	08.00-	CS581	12 1.0
		08.00-	CA1741IR	14 120	08.00-	CS1111	12 0.7
307 1.6 BioFlex BioFlex	[TU5JP4]	09.07-	CA1665IR	14 80	09.07-	CS581	12 1.0
		09.07-	CA1741IR	14 120	09.07-	CS1111	12 0.7
307 1.6 HDi	[9HX (DV6ATED4)]	04.05-	CA1761IR	14 150	04.05-	CS1391	12 2.2
	[DV6ATED4]	01.06-	CA1761IR	14 150	01.06-	CS1391	12 2.2





307 1.6 HDi FAP	[9HY (DV6TED4)]	02.04-	CA1761IR	14 150	02.04- 02.04- 02.04-	CS1260 CS1329 CS1391	12 1.1 12 1.5 12 2.2
307 2.0	[RFN (EW10J4)]	03.02-	CA1589IR	14 90	03.02-	CS1244	12 1.1
307 2.0 16V	[RFJ (EW10A)]	03.05- 03.05-	CA1914IR CA2015IR	14 150 14 120	06.05-	CS594	12 1.4
	[RFK (EW10J4S)]	10.03- 10.03- 10.03-	CA1589IR CA1674IR CA1741IR	14 90 14 150 14 120	10.03- 10.03-	CS1277 CS1244	12 1.4 12 1.1
	[RFN (EW10J4)]	08.00- 03.02- 03.02-	CA1589IR CA1674IR CA1741IR	14 90 14 150 14 120	08.00- 03.02-	CS1277 CS1244	12 1.4 12 1.1
307 2.0 HDi	[RHS (DW10ATED4)]	03.02- 03.02- 12.02 03.02- 03.02- 12.02-	CA1509IR CA1553IR CA1564IR CA1646IR CA1761IR	14 150 14 150 14 90 14 120 14 150	03.02- 03.02- 03.02-	CS594 CS1177 CS712	12 1.4 12 1.7 12 2.2
	[RHY (DW10TD)]	08.00- 12.02 08.00- 03.02- 03.02- 03.02-	CA1553IR CA1564IR CA1509IR CA1646IR CA1761IR	14 150 14 90 14 150 14 120 14 150	03.02- 08.00- 08.00-	CS594 CS1177 CS712	12 1.4 12 1.7 12 2.2
307 2.0 HDi FAP	[RHR (DW10BTED4)]	02.04- 02.08- Chas. 09520- 10.03- Chas. -09519 10.03-	CA1761IR CA1920IR CA1761IR CA1553IR	14 150 14 180 14 150 14 150	06.05- 10.03- 10.03- 10.03-	CS1342 CS1177 CS712 CS594	12 1.9 12 1.7 12 2.2 12 1.4
	[RHS (DW10ATED4)]	Chas. 9520- 01.03- 05.05 Chas. -9519 03.02- 12.02	CA1761IR CA1553IR	14 150 14 150	A13 03.02- 03.02-	CS594 CS712 CS1177	12 1.4 12 2.2 12 1.7
308 1.4 16V	[8FR (EP3C)]	12.09- 12.09- 06.10	CA1954IR CA2006IR	14 120 14 150	12.09-	CS1417	12 0.9
	[EP3]	09.07- 09.07- 09.07- 09.07-	CA1954IR CA1990IR* CA2006IR CA2087IR*	14 120 14 120 14 150 14 80	09.07-	CS1417	12 0.9
308 1.6 GTI	[5FU (EP6CDTX)]	07.10-	CA1954IR	14 120	07.10-	CS1417	12 0.9
308 1.6 16V	[5FT (EP6DT)]	09.07- 09.07- 09.07- 09.07-	CA1954IR CA1990IR* CA2006IR CA2087IR*	14 120 14 120 14 150 14 80	09.07-	CS1417	12 0.9
	[5FV (EP6CDT)]	10.09- 10.09- 06.10	CA1954IR CA2006IR	14 120 14 150	10.09-	CS1417	12 0.9
	[EP6]	09.07- 09.07- 09.07- 09.07-	CA1954IR CA1990IR* CA2006IR CA2087IR*	14 120 14 120 14 150 14 80	09.07-	CS1417	12 0.9
	[EP6DT]	09.07- 09.07- 09.07- 09.07-	CA1954IR CA1990IR* CA2006IR CA2087IR*	14 120 14 120 14 150 14 80	09.07-	CS1417	12 0.9
	[EP6DTS]	03.08- 03.08- 03.08- 03.08-	CA1954IR CA1990IR* CA2006IR CA2087IR*	14 120 14 120 14 150 14 80	03.08-	CS1417	12 0.9
308 1.6 16V CC	[5FX (EP6DT)]	06.09- 06.09- 06.09-	CA1954IR CA1990IR* CA2006IR	14 120 14 120 14 150	06.09-	CS1417	12 0.9
308 1.6 HDi	[9HP (DV6DTE)]	11.09-	CA2033IR	14 150	11.09-	CS1329	12 1.5
	[9HR (DV6C)]	12.09- 12.09-	CA1761IR CA2033IR	14 150 14 150	12.09- 12.09-	CS1329 CS1391	12 1.5 12 2.2
	[DV6ATED4]	09.07-	CA1761IR	14 150	09.07-	CS1260	12 1.1
	[DV6TED4]	09.07-	CA1761IR	14 150	09.07- 09.07-	CS1391 CS1329	12 2.2 12 1.5
308 2.0 Diesel CC	[RHR (DW10BTED4)]	04.09-	CA1761IR	14 150	04.09-	CS1416	12 2.5
308 2.0 HDi	[DW10BTED4]	09.07-	CA1761IR	14 150	09.07-	CS1416	12 2.5
	[RHR (DW10BTED4)]	09.07-	CA1761IR	14 150	09.07-	CS1416	12 2.5
309 1.1	[E1]	10.85- 07.89	CA369IR	14 50	10.85- 07.89	CS306	12 1.05
	[HDZ (TU1M)]	08.90- 12.93	CA369IR	14 50	01.92- 12.93 08.90- 01.92	CS581 CS390	12 1.0 12 0.9
309 1.3	[G1A]	10.85- 07.89	CA369IR	14 50	10.85- 07.89	CS306	12 1.05
309 1.4	[K1D (TU3A)]	03.89- 12.93	CA359IR	14 50	03.89- 01.92	CS390	12 0.9
	[K2B (TU3S)]	03.89- 12.93	CA533IR	14 70	01.92- 12.93	CS581	12 1.0
	[KDY (TU3M)]	03.89- 12.93	CA359IR	14 50	03.89- 01.92	CS390	12 0.9
		03.89- 12.93	CA533IR	14 70	01.92- 12.93	CS581	12 1.0
	[KDZ (TU3M)]	A13 06.90- 12.93	CA533IR	14 70	03.89- 12.93	CS390	12 0.9
		03.89- 12.93	CA533IR	14 70	01.92- 12.93	CS581	12 1.0
309 1.6	[180Z (XU5J)]	11.85- 09.88 11.85- 09.88	CA294IR CA380IR	14 50 14 70	11.85- 09.88	CS326	12 0.85
	[B1A (XU51C)]	10.85- 07.89 10.85- 07.89	CA294IR CA380IR	14 50 14 70	10.85- 07.89	CS326	12 0.85
	[B1E (XU51C)]	08.87- 07.89 08.87- 07.89	CA294IR CA380IR	14 50 14 70	08.87- 07.89	CS326	12 0.85
	[B2A (XU52C/K)]	07.89- 12.93 07.89- 12.93	CA294IR CA380IR	14 50 14 70	07.89- 12.93	CS326	12 0.85
	[B6B (XU5J)]	11.85- 09.88 11.85- 09.88	CA294IR CA380IR	14 50 14 70	11.85- 09.88	CS326	12 0.85
	[BDY (XU5M2Z)]	01.91- 12.93 01.91- 12.93	CA294IR CA380IR	14 50 14 70	01.91- 12.93	CS326	12 0.85
	[BDY (XU5M3Z)]	01.91- 12.93 01.91- 12.93	CA294IR CA380IR	14 50 14 70	01.91- 12.93	CS326	12 0.85
	[BDZ (XU5M)]	07.89- 12.93 07.89- 12.93	CA294IR CA380IR	14 50 14 70	07.89- 12.93	CS326	12 0.85
		10.85- 06.89 10.85- 12.90	CA294IR CA380IR	14 50 14 70	10.85- 12.90	CS326	12 0.85
309 1.8 Diesel	[161A (XUD7)]	07.89- 12.93 07.89- 12.93	CA294IR CA380IR	14 50 14 70	07.89- 12.93 07.89- 12.93	CS342# CS373	12 1.5 12 1.7
309 1.8 TD	[A8B (XUD7TE)]	08.89- 12.93 08.89- 12.93	CA294IR CA380IR	14 50 14 70	08.89- 12.93 08.89- 12.93	CS342# CS373	12 1.5 12 1.7
309 1.9	[D2B (XU9S)]	10.85- 07.89 10.85- 07.89	CA294IR CA380IR	14 50 14 70	10.85- 07.89 10.85- 07.89	CS326 CS566	12 0.85 12 1.1



**PEUGEOT** *Continued*

	[D6B (XU9JA)]	10.86- 07.89 CA294IR 14 50		10.86- 07.89 CS326 12 0.85
		10.86- 07.89 CA380IR 14 70		
	[DDZ (XU9M)]	07.88- 12.93 CA294IR 14 50		07.88- 12.93 CS326 12 0.85
		07.88- 12.93 CA380IR 14 70		
	[DFZ (XU9J1)]	03.86- 12.93 CA294IR 14 50		03.86- 12.93 CS326 12 0.85
		03.86- 12.93 CA380IR 14 70		
		08.89- 12.93 CA597IR# 14 80		
309 1.9 GTi 16V	[DFW (XU9J4Z)]	10.90- 12.93 CA380IR 14 70		10.90- 12.93 CS326 12 0.85
309 1.9 GTi	[D6C (XUD9J4)]	08.89- 07.90 CA380IR 14 70		08.89- 07.90 CS326 12 0.85
	[DKZ (XU9JAZ)]	07.88- 12.93 CA380IR 14 70		07.88- 12.93 CS326 12 0.85
309 1.9 Diesel	[162 (XUD9)]	06.86- 12.93 CA294IR 14 50	A13 06.86- 12.93 CS570 12 3.1	
		06.86- 12.93 CA380IR 14 70	06.86- 12.93 CS373 12 1.7	
	[D9A (XUD9)]	06.86- 12.93 CA294IR 14 50	A13 06.86- 12.93 CS570 12 3.1	
		06.86- 12.93 CA380IR 14 70	06.86- 12.93 CS373 12 1.7	
	[DJZ (XUD9Y)]	07.89- 12.93 CA294IR 14 50	06.86- 12.93 CS373 12 1.7	
		07.89- 12.93 CA380IR 14 70	A13 07.89- 12.93 CS570 12 3.1	
404 1.6	[XC6]		04.63- 12.71 CS129 12 0.9	
404 1.6 GT	[XC6]		07.71- 12.71 CS129 12 0.9	
405 1.4	[KDX (TU3MC)]	08.92- 04.97 CA617IR 14 50	08.92- 04.97 CS390 12 0.9	
		08.92- 04.97 CA618IR 14 70		
	[TU3]	01.87- 07.92 CA359IR 14 50	01.87- 07.92 CS390 12 0.9	
		01.87- 07.92 CA533IR 14 70	05.88- 07.92 CS581 12 1.0	
		07.93- 06.94 CA618IR 14 70	07.93- 06.94 CS390 12 0.9	
		07.93- 06.94 CA617IR 14 50		
405 1.6	[B1E (XU51C)]	07.87- 12.92 CA294IR 14 50	07.87- 12.92 CS326 12 0.85	
		07.87- 12.92 CA380IR 14 70	07.87- 12.92 CS566 12 1.1	
		07.87- 08.92 CA532IR 14 80		
		07.87- 12.92 CA597IR# 14 80		
	[BAZ (XU5CP)]	07.87- 08.92 CA294IR 14 50	07.87- 08.92 CS566 12 1.1	
		07.87- 08.92 CA380IR 14 70	07.87- 08.92 CS326 12 0.85	
		07.87- 08.92 CA532IR 14 80		
		10.88- 08.92 CA583IR 14 80		
		10.88- 08.92 CA597IR# 14 80		
	[BDY (XU5M2Z)]	09.90- 12.92 CA294IR 14 50	08.92- 04.97 CS715 12 1.4	
		09.90- 12.92 CA525IR 14 50	09.90- 04.97 CS566 12 1.1	
		09.90- 12.92 CA532IR 14 80	09.90- 12.92 CS326 12 0.85	
		09.90- 12.92 CA597IR# 14 80		
		08.92- 04.97 CA730IR 14 80		
		08.92- 04.97 CA820IR 14 70		
		08.92- 04.97 CA836IR 14 120		
		AC 08.92- 04.97 CA825IR 14 95		
	[BDY (XU5M3Z)]	09.90- 12.92 CA294IR 14 50	09.90- 12.92 CS326 12 0.85	
		09.90- 12.92 CA525IR 14 50	09.90- 04.97 CS566 12 1.1	
		09.90- 12.92 CA532IR 14 80	08.92- 04.97 CS715 12 1.4	
		09.90- 12.92 CA597IR# 14 80		
		08.92- 04.97 CA730IR 14 80		
		08.92- 04.97 CA820IR 14 70		
		08.92- 04.97 CA836IR 14 120		
		AC 08.92- 04.97 CA825IR 14 95		
	[BDZ (XU5M)]	07.87- 12.92 CA294IR 14 50	07.87- 12.92 CS566 12 1.1	
		07.87- 12.92 CA380IR 14 70	07.87- 12.92 CS326 12 0.85	
		07.87- 12.92 CA597IR# 14 80		
		10.88- 09.90 CA532IR 14 80		
	[BFZ (XU5JP)]	09.94- 04.97 CA730IR 14 80	09.94- 04.97 CS715 12 1.4	
		09.94- 04.97 CA820IR 14 70	09.94- 04.97 CS566 12 1.1	
		09.94- 04.97 CA836IR 14 120		
		AC 09.94- 04.97 CA825IR 14 95		
	[XU52C]	01.87- 12.92 CA294IR 14 50	01.87- 12.92 CS566 12 1.1	
		01.87- 12.92 CA380IR 14 70	01.87- 12.92 CS326 12 0.85	
		01.87- 12.92 CA597IR# 14 80		
	[XU5J]	10.88- 08.92 CA294IR 14 50	10.88- 08.92 CS326 12 0.85	
		10.88- 08.92 CA380IR 14 70	10.88- 08.92 CS566 12 1.1	
		10.88- 08.92 CA532IR 14 80		
		10.88- 08.92 CA597IR# 14 80		
		10.88- 08.92 CA294IR 14 50	10.88- 08.92 CS326 12 0.85	
		10.88- 08.92 CA380IR 14 70		
405 1.6 SRi 4x4		04.88- 07.92 CA380IR 14 70	04.88- 07.92 CS326 12 0.85	
		04.88- 07.92 CA294IR 14 50		
405 1.8	[LFZ (XU7JP)]	08.92- 04.97 CA730IR 14 80	08.92- 04.97 CS566 12 1.1	
		08.92- 04.97 CA820IR 14 70	08.92- 04.97 CS715 12 1.4	
		AC 08.92- 04.97 CA1086IR 14 80		
		AC 08.92- 04.97 CA825IR 14 95		
405 1.8 TD	[A8A (XUD7TE)]	03.88- 12.92 CA294IR 14 50	03.88- 12.92 CS373 12 1.7	
		03.88- 12.92 CA380IR 14 70	03.88- 12.92 CS570 12 3.1	
		03.88- 12.92 CA525IR 14 50		
		03.88- 12.92 CA583IR 14 80		
	[AJZ (XUD7TEY)]	10.90- 12.92 CA294IR 14 50	10.90- 08.92 CS570 12 3.1	
		10.90- 12.92 CA380IR 14 70	10.90- 12.92 CS373 12 1.7	
		10.90- 12.92 CA525IR 14 50		
		10.90- 12.92 CA583IR 14 80		
405 1.9	[D2C (XU92C)]	07.87- 12.92 CA294IR 14 50	07.87- 12.92 CS326 12 0.85	
		07.87- 12.92 CA380IR 14 70		
		07.87- 12.92 CA532IR 14 80		
	[D6A (XU9J2)]	01.89- 12.92 CA294IR 14 50	01.89- 12.92 CS326 12 0.85	
		01.89- 12.92 CA380IR 14 70	01.89- 12.92 CS566 12 1.1	
		01.89- 12.92 CA583IR 14 80		
	[DDZ (XU9M)]	07.88- 12.92 CA294IR 14 50	07.88- 12.92 CS326 12 0.85	
		07.88- 12.92 CA380IR 14 70		
		07.88- 12.92 CA532IR 14 80		
	[DFZ (XU9J1)]	10.88- 08.92 CA294IR 14 50	10.88- 08.92 CS326 12 0.85	
		10.88- 08.92 CA380IR 14 70		
		10.88- 08.92 CA532IR 14 80		
	[DKZ (XU9JAZ)]	07.88- 12.92 CA294IR 14 50	07.88- 12.92 CS326 12 0.85	
		07.88- 12.92 CA380IR 14 70		
		07.88- 12.92 CA532IR 14 80		
		07.87- 12.92 CA583IR 14 80	06.87- 12.92 CS326 12 0.85	
		06.87- 12.92 CA380IR 14 70	07.87- 12.92 CS566 12 1.1	
		06.87- 12.92 CA294IR 14 50		
405 1.9 4x4	[DDZ (XU9M)]	07.88- 12.92 CA294IR 14 50	07.88- 12.92 CS326 12 0.85	
		07.88- 12.92 CA380IR 14 70		
		07.88- 12.92 CA532IR 14 80		
		06.87- 07.92 CA380IR 14 70	06.87- 07.92 CS326 12 0.85	
		06.87- 07.92 CA294IR 14 50		



405 1.9 Sport MI 16	[D6C (XU9J4)]	07.87- 11.91	CA294IR	14 50	07.87- 11.91	CS326	12 0.85
		07.87- 11.91	CA380IR	14 70			
	[DFW (XU9J4Z)]	04.88- 12.92	CA294IR	14 50	04.88- 12.92	CS326	12 0.85
		04.88- 12.92	CA380IR	14 70			
405 1.9 Sport MI 16 4X4	[DFW (XU9J4Z)]	04.88- 12.92	CA294IR	14 50	04.88- 12.92	CS326	12 0.85
		04.88- 12.92	CA380IR	14 70			
405 1.9 i	[DFZ (XU9J1)]	07.87- 12.92	CA294IR	14 50	07.87- 12.92	CS326	12 0.85
		07.87- 12.92	CA380IR	14 70			
405 1.9 Diesel	[D9B (XUD9A)]	03.88- 12.92	CA380IR	14 70	03.88- 12.92	CS373	12 1.7
		03.88- 12.92	CA532IR	14 80	A13 03.88- 12.92	CS570	12 3.1
		03.88- 12.92	CA597IR#	14 80			
	[DJY (XUD9A)]	10.88- 08.92	CA380IR	14 70	06.94- 04.97	CS594	12 1.4
		10.88- 08.92	CA532IR	14 80	07.88- 12.92	CS373	12 1.7
		06.94- 04.97	CA637IR	14 70	A13 07.88- 12.92	CS570	12 3.1
		06.94- 04.97	CA638IR	14 80	06.94- 04.97	CS712	12 2.2
		06.94- 04.97	CA639IR	14 80			
		06.94- 04.97	CA729IR#	14 50			
	[DJZ (XUD9Y)]	07.88- 09.92	CA380IR	14 70	08.92- 06.94	CS712	12 2.2
		07.88- 09.92	CA532IR	14 80	A13 07.88- 09.92	CS570	12 3.1
		07.88- 09.92	CA597IR#	14 80	07.88- 09.92	CS373	12 1.7
		08.92- 06.94	CA637IR	14 70	08.92- 06.94	CS594	12 1.4
		08.92- 06.94	CA638IR	14 80			
		08.92- 06.94	CA639IR	14 80			
		08.92- 06.94	CA729IR#	14 50			
405 1.9 TD	[DHY (XUD9TE)]	08.92- 04.97	CA637IR	14 70	A13 08.92- 04.97	CS712	12 2.2
		08.92- 04.97	CA638IR	14 80	08.92- 04.97	CS594	12 1.4
		08.92- 04.97	CA639IR	14 80			
		08.92- 04.97	CA729IR#	14 50			
405 2.0	[RFX (XU10J2)]	08.92- 04.97	CA730IR	14 80	08.92- 04.97	CS715	12 1.4
		08.92- 04.97	CA820IR	14 70	08.92- 04.97	CS566	12 1.1
		AC 08.92- 04.97	CA825IR	14 95			
		AC 08.92- 04.97	CA836IR	14 120			
405 2.0 4x4	[RFX (XU10J2)]	08.92- 04.97	CA730IR	14 80	08.92- 04.97	CS566	12 1.1
		08.92- 04.97	CA820IR	14 70	08.92- 04.97	CS715	12 1.4
		AC 08.92- 04.97	CA825IR	14 95			
		AC 08.92- 04.97	CA836IR	14 120			
		AC 08.92- 12.95	CA836IR	14 120			
		AC 08.92- 12.95	CA825IR	14 95			
		08.92- 12.95	CA820IR	14 70			
405 2.0 MI 16	[RFY (XU10J4Z)]	08.92- 04.97	CA730IR	14 80			
		08.92- 04.97	CA820IR	14 70			
		AC 08.92- 04.97	CA825IR	14 95			
		AC 08.92- 04.97	CA836IR	14 120			
405 2.0 16V	[RFT (XU10J4)]	06.94- 04.97	CA730IR	14 80			
		06.94- 04.97	CA820IR	14 70			
		AC 06.94- 04.97	CA825IR	14 95			
		AC 06.94- 04.97	CA836IR	14 120			
405 2.0 Turbo 16 4x4	[RGZ (XU10J4TE/Z)]	08.92- 04.97	CA730IR	14 80			
		08.92- 04.97	CA820IR	14 70			
		AC 08.92- 04.97	CA825IR	14 95			
		AC 08.92- 04.97	CA836IR	14 120			
406 1.6	[BFZ (XU5JP)]	11.95- 05.04	CA730IR	14 80	11.95- 05.04	CS715	12 1.4
		11.95- 05.04	CA820IR	14 70	11.95- 05.04	CS566	12 1.1
		11.95- 05.04	CA825IR	14 95			
		AC 11.95- 05.04	CA1086IR	14 80			
		AC 11.95- 05.04	CA825IR	14 95			
406 1.8	[LFX (XU7JB)]	05.97- 06.04	CA1052IR	14 90	05.97- 06.04	CS715	12 1.4
		05.97- 06.04	CA1151IR	14 70	05.97- 06.04	CS566	12 1.1
		05.97- 06.04	CA1152IR	14 80			
		09.97- 06.04	CA1156IR	14 120			
		AC 05.97- 06.04	CA1156IR	14 120			
406 1.8 16V	[6FZ (EW7J4)]	10.00- 01.02	CA1496IR	14 80	A13 10.00- 06.04	CS1244	12 1.1
		10.00- 01.02	CA1564IR	14 90	10.00- 06.04	CS1277	12 1.4
		10.00- 01.02	CA1646IR	14 120			
		01.02- 05.04	CA1499IR	14 80			
		01.02- 05.04	CA1589IR	14 90			
		10.95- 06.04	CA1052IR	14 90	10.95- 06.04	CS566	12 1.1
		10.95- 06.04	CA1151IR	14 70	10.95- 06.04	CS715	12 1.4
		10.95- 06.04	CA1152IR	14 80			
		AC 10.95- 06.04	CA1052IR	14 90			
		AC 10.95- 06.04	CA1156IR	14 120			
406 1.9 Diesel	[DHW (XUD9SD)]	10.96- 03.99	CA1043IR	14 80	10.96- 10.03	CS594	12 1.4
		10.96- 10.03	CA1065IR	14 95	10.96- 10.03	CS712	12 2.2
		10.96- 10.03	CA1098IR	14 120	10.96- 03.99	CS373	12 1.7
		10.96- 10.03	CA1312IR	14 150			
406 1.9 TD	[DHX (XUD9TE)]	01.96- 06.04	CA1065IR	14 95	01.96- 06.04	CS594	12 1.4
		01.96- 06.04	CA1098IR	14 120	01.96- 06.04	CS712	12 2.2
		01.96- 06.04	CA1312IR	14 150			
		01.96- 03.99	CA1065IR	14 95	01.96- 03.99	CS594	12 1.4
		01.96- 03.99	CA1098IR	14 120	01.96- 03.99	CS712	12 2.2
		01.96- 03.99	CA1312IR	14 150			
406 2.0 16V	[RFN (EW10J4)]	08.00- 02.05	CA1496IR	14 80	A13 08.00- 02.05	CS1244	12 1.1
		08.00- 02.05	CA1509IR	14 150	08.00- 02.05	CS1277	12 1.4
		08.00- 02.05	CA1564IR	14 90			
		01.99- 10.00	CA1496IR	14 80	01.99- 10.00	CS1244	12 1.1
		01.99- 10.00	CA1509IR	14 150	01.99- 10.00	CS1277	12 1.4
		01.99- 10.00	CA1553IR	14 150			
		01.99- 10.00	CA1564IR	14 90			
		11.95- 02.05	CA1052IR	14 90	11.95- 02.05	CS715	12 1.4
		11.95- 06.04	CA1151IR	14 70	11.95- 02.05	CS566	12 1.1
		11.95- 02.05	CA1152IR	14 80			
		03.97- 02.05	CA1156IR	14 120			
		AC 11.95- 06.04	CA1052IR	14 90			
	AC 11.95- 06.04	CA1156IR	14 120				
406 2.0 HPI 16V	[RLZ (EW10D)]	10.00- 06.04	CA1564IR	14 90	10.00- 06.04	CS1244	12 1.1
					10.00- 06.04	CS1277	12 1.4
406 2.0 Turbo	[RGX (XU10J2TE)]	06.94- 03.97	CA1086IR	14 80	06.94- 08.02	CS715	12 1.4
		06.94- 03.97	CA820IR	14 70	06.94- 08.02	CS566	12 1.1
		06.94- 03.97	CA836IR	14 120			



PEUGEOT *Continued*

		10.96- 08.02	CA1052IR	14	90				
		10.96- 08.02	CA1151IR	14	70				
		10.96- 08.02	CA1152IR	14	80				
		10.96- 08.02	CA1156IR	14	120				
406 2.0 HDi	[RHY (DW10TD)]	02.99- 05.05	CA1553IR	14	150	02.99- 05.05	CS1177	12	1.7
		02.99- 05.05	CA1564IR	14	90	02.99- 05.05	CS594	12	1.4
		AC 02.99- 05.05	CA1509IR	14	150				
		AC 02.99- 05.05	CA1553IR	14	150				
	[RHZ (DW10ATED)]	10.98- 06.04	CA1496IR	14	80	02.99- 11.04	CS1177	12	1.7
		10.98- 06.04	CA1509IR	14	150	02.99- 11.04	CS594	12	1.4
		10.98- 06.04	CA1646IR	14	120				
		02.99- 11.04	CA1553IR	14	150				
		02.99- 11.04	CA1564IR	14	90				
		02.99- 04.04	CA1761IR	14	150				
406 2.0 HDi FAP	[RHS (DW10ATED4)]	08.01- 05.05	CA1553IR	14	150	08.01- 05.05	CS1342	12	1.9
	[RHZ (DW10ATED4)]	08.01- 05.05	CA1553IR	14	150	08.01- 05.05	CS1342	12	1.9
406 2.1 TD 12V	[P8C (XUD11BTE)]	01.96- 03.99	CA1043IR	14	80	01.96- 03.99	CS594	12	1.4
		01.96- 03.99	CA1065IR	14	95	01.96- 03.99	CS712	12	2.2
		01.96- 03.99	CA1098IR	14	120				
		01.96- 03.99	CA1312IR	14	150				
406 2.2	[3FZ (EW12J4)]	04.99- 02.05	CA1496IR	14	80	04.99- 02.05	CS1277	12	1.4
		04.99- 02.05	CA1509IR	14	150	07.00- 05.04	CS1244	12	1.1
		04.99- 02.05	CA1564IR	14	90				
406 2.2 HDi	[4HX (DW12TED4)]	03.00- 06.04	CA1509IR	14	150	06.02- 06.04	CS1342	12	1.9
		03.00- 06.04	CA1553IR	14	150	03.00- 06.04	CS1326	12	2.3
						03.00- 06.04	CS1177	12	1.7
						03.00- 06.04	CS594	12	1.4
		AC 03.00- 06.04	CA1553IR	14	150				
406 3.0 24V	[XFZ (ES9J4)]	10.96- 06.04	CA1338IR	14	120	10.96- 06.04	CS1108	12	1.5
		10.96- 06.04	CA1388IR	14	150				
		12.97- 06.04	CA1392IR	14	120				
406 3.0 V6 24V	[XFZ (ES9J4)]	03.97- 02.05	CA1338IR	14	120	03.97- 02.05	CS1108	12	1.5
		03.97- 02.05	CA1388IR	14	150				
406 3.0 V6	[XFX (ES9J4S)]	03.00- 02.05	CA1338IR	14	120	AT 03.00- 02.05	CS1290	12	1.3
		03.00- 02.05	CA1388IR	14	150				
		03.00- 02.05	CA1392IR	14	120				
407 1.6 HDi FAP	[9HY (DV6TED4)]	05.04- 05.04	CA1761IR	14	150	05.04- 05.04	CS1391	12	2.2
						05.04- 05.04	CS1260	12	1.1
						05.04- 05.04	CS1329	12	1.5
407 1.8	[6FZ (EW7J4)]	05.04- 05.04	CA1589IR	14	90	05.04- 05.04	CS1244	12	1.1
			CA1741IR	14	120	05.04- 05.04	CS1277	12	1.4
407 1.8 16V	[6FY (EW7A)]	09.05- 09.05	CA1914IR	14	150	09.05- 09.05	CS594	12	1.4
			CA2015IR	14	120	09.05- 09.05	CS1244	12	1.1
407 2.0	[RFN (EW10J4)]	05.04- 05.04	CA1674IR	14	150	05.04- 05.04	CS1177	12	1.7
			CA1741IR	14	120	05.04- 05.04	CS1244	12	1.1
						05.04- 05.04	CS1277	12	1.4
407 2.0 16V	[RFJ (EW10A)]	09.05- 09.05	CA1914IR	14	150	09.05- 09.05	CS594	12	1.4
			CA2015IR	14	120	09.05- 09.05	CS1244	12	1.1
407 2.0 Bioflex	[RFJ (EW10A)]	09.07- 09.07	CA1914IR	14	150	09.07- 09.07	CS594	12	1.4
407 2.0 HDi	[DW10BTED4]	08.08- 08.08	CA1761IR	14	150	08.08- 08.08	CS1391	12	2.2
						AT 08.08- 08.08	CS1416	12	2.5
						08.08- 08.08	CS1177	12	1.7
	[RHE (DW10CTED4)]	02.10- 02.10	CA2030IR	14	180	02.10- 02.10	CS1416	12	2.5
	[RHH (DW10CTED4)]	06.09- 06.09	CA2030IR	14	180	06.09- 06.09	CS1416	12	2.5
	[RHR (DW10BTED4)]	10.05- 10.05	CA1761IR	14	150	10.05- 10.05	CS594	12	1.4
		10.05- 10.05	CA1920IR	14	180	10.05- 10.05	CS1342	12	1.9
						10.05- 10.05	CS1177	12	1.7
						10.05- 10.05	CS373	12	1.7
407 2.0 HDi FAP	[RHR (DW10BTED4)]	05.04- 05.04	CA1761IR	14	150	05.04- 05.04	CS1342	12	1.9
			CA1920IR	14	180	AT 05.04- 05.04	CS1416	12	2.5
						A13 05.04- 05.04	CS712	12	2.2
						05.04- 05.04	CS1177	12	1.7
						05.04- 05.04	CS594	12	1.4
407 2.2	[3FZ (EW12J4)]	05.04- 05.04	CA1589IR	14	90	05.04- 05.04	CS1244	12	1.1
			CA1914IR	14	150	05.04- 05.04	CS1277	12	1.4
407 2.2 16V	[3FY (EW12J4)]	09.05- 09.05	CA1914IR	14	150	09.05- 09.05	CS594	12	1.4
			CA2015IR	14	120	10.05- 10.05	CS1244	12	1.1
407 2.2 HDi		06.08- 06.08	CA1920IR	14	180	06.08- 06.08	CS1416	12	2.5
407 2.2 HDi FAP	[4HT (DW12BTED4)]	05.06- 05.06	CA1920IR	14	180	05.06- 05.06	CS1416	12	2.5
	[9HY (DW12BTED4)]	05.06- 05.06	CA1920IR	14	180	05.06- 05.06	CS1416	12	2.5
407 2.7 HDi	[DT17TED4]	10.05- 07.08	CA1888IR	14	180	10.05- 07.08	JS1368*	12	2.2
407 3.0	[XVF (ES9A)]	05.04- 05.04	CA1388IR	14	150	05.04- 05.04	CS1108	12	1.5
						05.04- 05.04	CS1290	12	1.3
407 3.0 V6	[XVF (ES9A)]	10.05- 10.05	CA1388IR	14	150	10.05- 10.05	CS1290	12	1.3
407 3.0 HDi	[X8Z (DT20C)]	06.09- 06.09				06.09- 06.09	JS1368*	12	2.2
504 1.6	[XC7P]	10.79- 12.90	CA150IR	14	50	01.80- 06.87	CS352	12	0.85
504 1.8	[XM]	07.68- 02.71	CA150IR	14	50	07.68- 02.71	CS352	12	0.85
						07.68- 12.77	CS129	12	0.9
	[XM7]	01.71- 12.89	CA150IR	14	50	12.77- 12.89	CS352	12	0.85
						01.71- 12.77	CS129	12	0.9
504 1.8 i	[KF5]	07.68- 02.71	CA150IR	14	50	07.68- 02.71	CS352	12	0.85
	[KF6]	07.68- 02.71	CA150IR	14	50	07.68- 02.71	CS352	12	0.85
504 1.9 Diesel	[XD4X88]	10.79- 06.87	CA308IR	14	50				
504 2.0	[106 (XN1)]	03.71- 06.86	CA150IR	14	50	03.71- 12.77	CS129	12	0.9
						12.77- 06.86	CS352	12	0.85
	[107 (XN2)]	01.71- 08.84	CA150IR	14	50	01.71- 08.84	CS352	12	0.85
	[XN1]	04.71- 07.86	CA150IR	14	50	12.77- 07.86	CS352	12	0.85
						04.71- 12.77	CS129	12	0.9
	[XN2]	10.74- 08.82	CA150IR	14	50	10.74- 12.77	CS129	12	0.9
						12.77- 08.82	CS352	12	0.85
504 2.0 Ti	[107 (XN2)]	01.71- 06.83	CA150IR	14	50	12.77- 06.83	CS352	12	0.85
						01.71- 12.77	CS129	12	0.9
504 2.1 Diesel	[XD4X90]	02.71- 07.86	CA308IR	14	50	08.81- 07.86	CS314	12	2.0
		02.71- 07.86	CA315IR	14	70	07.81- 07.86	CS524	12	2.2
						02.71- 08.81	CS128	12	2.0
						09.79- 08.82	CS128	12	2.0
504 2.3 Diesel	[134 (XD2)]	07.75- 12.89	CA308IR	14	50	07.81- 07.86	CS524	12	2.2
		07.75- 07.86	CA315IR	14	70	08.81- 12.89	CS314	12	2.0
						07.75- 08.81	CS128	12	2.0
504 2.7	[140 (ZMJ)]	10.77- 08.84	CA150IR	14	50	10.77- 08.84	CS352	12	0.85
						10.77- 08.84	CS129	12	0.9
505 1.8	[105 (XM7)]	01.82- 10.85	CA150IR	14	50	01.82- 10.85	CS129	12	0.9
		01.82- 10.85	CA377IR	14	70	01.82- 10.85	CS352	12	0.85
	[XM7A]	09.85- 10.86	CA150IR	14	50	09.85- 10.86	CS352	12	0.85
		09.85- 10.86	CA377IR	14	70	09.85- 10.86	CS129	12	0.9



505 2.0	[106 (XN1)]	11.80- 12.85	CA1501R	14 50	11.80- 12.85	CS129	12 0.9	
		11.80- 12.85	CA3771R	14 70	11.80- 12.85	CS352	12 0.85	
	[106E (XN1A)]	09.85- 11.87	CA1501R	14 50	09.85- 11.87	CS352	12 0.85	
		09.85- 11.87	CA3771R	14 70				
	[829 (ZEJ)]	08.79- 10.86	CA1501R	14 50	08.79- 10.86	CS317	12 1.05	
		08.79- 10.86	CA3771R	14 70				
[XN1]	04.82- 11.87	CA1501R	14 50	04.82- 11.87	CS352	12 0.85		
	04.82- 11.87	CA3771R	14 70					
	08.79- 10.86	CA3771R	14 70	09.79- 10.86	CS317	12 1.05		
	08.79- 10.86	CA1501R	14 50	05.81- 10.84	CS317	12 1.05		
505 2.2	[851 (ZDJ)]	05.81- 10.84	CA1501R	14 50	05.81- 10.84	CS317	12 1.05	
		05.81- 10.84	CA3771R	14 70				
505 2.2 GTi	[851B (ZDJL)]	01.86- 12.93	CA1501R	14 50	01.86- 12.93	CS317	12 1.05	
		01.86- 12.93	CA3771R	14 70				
		08.83- 12.93	CA1501R	14 50	08.83- 12.93	CS317	12 1.05	
		08.83- 12.93	CA3151R	14 70				
		08.83- 12.93	CA3771R	14 70	08.83- 12.93	CS317	12 1.05	
505 2.2 iTurbo	[176W (N9TEA)]	03.84- 12.88	CA3771R	14 70				
505 2.3 TD	[147 (XD2S)]	09.80- 06.86	CA3081R	14 50	09.80- 06.86	CS128	12 2.0	
		09.80- 06.86	CA3151R	14 70	09.80- 06.86	CS314	12 2.0	
					09.80- 06.86	CS524	12 2.2	
505 2.5	[152B (XD3TE)]	10.86- 12.93	CA3081R	14 50	10.86- 12.93	CS524	12 2.2	
		10.86- 12.93	CA3151R	14 70	10.86- 12.93	CS314	12 2.0	
505 2.5 Diesel	[155 (XD3)]	06.81- 12.93	CA3081R	14 50	06.81- 12.93	CS524	12 2.2	
		06.81- 12.93	CA3151R	14 70	06.81- 12.93	CS314	12 2.0	
505 2.5 TD	[152A (XD3T)]	10.83- 12.93	CA3081R	14 50	10.83- 12.93	CS524	12 2.2	
		10.83- 12.93	CA3151R	14 70	10.83- 12.93	CS314	12 2.0	
	[152B (XD3TE)]	10.86- 12.93	CA3081R	14 50	10.86- 12.93	CS524	12 2.2	
		10.86- 12.93	CA3151R	14 70	10.86- 12.93	CS314	12 2.0	
		10.83- 12.93	CA3081R	14 50	10.83- 12.93	CS314	12 2.0	
		10.83- 12.93	CA3151R	14 70				
505 2.8 V6	[154X (ZN3J)]	06.86- 12.93	CA1501R	14 50				
508 1.6 THP	[5FV (EP6DT)]	11.10-	CA19541R	14 120	11.10-	CS1417	12 0.9	
		11.10-	CA19901R*	14 120				
		11.10-	CA20061R	14 150				
508 1.6 VTi	[5FS (EP6C)]	11.10-	CA19541R	14 120	11.10-	CS1417	12 0.9	
		11.10-	CA19901R*	14 120				
		11.10-	CA20061R	14 150				
508 1.6 HDi	[9HR (DV6C)]	11.10-	CA20301R	14 180	11.10-	CS1329	12 1.5	
		11.10-	CA20331R	14 150	11.10-	CS1391	12 2.2	
				02.12-	CS566	12 1.1		
				02.12-	CS1391	12 2.2		
				02.12-	CS1329	12 1.5		
508 2.0 HDi	[DW10BTED4]	11.10-			11.10-	CS1342	12 1.9	
		11.10-			11.10-	CS594	12 1.4	
	[DW10C]				11.10-	CS1342	12 1.9	
				11.10-	CS594	12 1.4		
508 2.2 HDi	[DW12C]	11.10-	CA20301R	14 180	11.10-	CS1416	12 2.5	
604 2.3 TD	[147 (XD2S)]	09.79- 05.83	CA3081R	14 50	09.79- 02.81	CS128	12 2.0	
		09.79- 05.83	CA3151R	14 70	03.81- 05.83	CS314	12 2.0	
604 2.5 TD	[152A (XD3T)]	08.83- 12.86	CA3081R	14 50	08.83- 12.86	CS314	12 2.0	
		08.83- 12.86	CA3151R	14 70	08.83- 12.86	CS128	12 2.0	
604 2.7	[112 (ZM)]	08.77- 05.83	CA1751R	14 70				
		08.77- 05.83	CA1751R	14 70				
604 2.8 GTi	[154A (ZMJJK)]	09.83- 07.87	CA1751R	14 70				
605 2.0	[R5A (XU102C)]	10.89- 06.94	CA5561R	14 80	10.89- 05.99	CS566	12 1.1	
		10.89- 06.94	CA5871R	14 70	10.89- 05.99	CS715	12 1.4	
		07.94- 05.99	CA8321R	14 120				
		02.90- 05.99	CA5561R	14 80	02.90- 05.99	CS566	12 1.1	
	[RDZ (XU10MZ)]	02.90- 06.95	CA5871R	14 70	06.92- 05.99	CS715	12 1.4	
		02.90- 05.99	CA6141R	14 90				
			02.90- 05.99	CA8321R	14 120			
	[RFZ (XU10J2Z)]	06.89- 06.95	CA5561R	14 80	06.89- 06.95	CS566	12 1.1	
		06.89- 06.95	CA5871R	14 70	06.89- 06.95	CS715	12 1.4	
		06.89- 06.95	CA6141R	14 90				
06.89- 06.95		CA8321R	14 120					
605 2.0 16V	[RFV (XU10J4R)]	07.94- 06.95	CA10861R	14 80	07.94- 05.99	CS566	12 1.1	
		07.94- 06.95	CA8251R	14 95	07.94- 05.99	CS715	12 1.4	
		07.94- 06.95	CA8361R	14 120				
		06.95- 05.99	CA10521R	14 90				
		06.95- 05.99	CA11511R	14 70				
		06.95- 05.99	CA11521R	14 80				
		06.95- 05.99	CA11561R	14 120				
		06.95- 05.99	CA11561R	14 120				
605 2.0 Turbo	[RGX (XU10J2TE)]	07.91- 06.95	CA5561R	14 80	06.92- 05.99	CS715	12 1.4	
		07.95- 05.99	CA10521R	14 90	07.91- 05.99	CS566	12 1.1	
		07.95- 05.99	CA11511R	14 70				
		07.95- 05.99	CA11521R	14 80				
	[RGY (XU10J2TE)]	07.95- 05.99	CA11561R	14 120				
		07.92- 06.95	CA5561R	14 80	07.92- 06.95	CS715	12 1.4	
		07.92- 06.94	CA5871R	14 70	07.92- 06.95	CS566	12 1.1	
		07.92- 06.94	CA6141R	14 90				
		07.94- 06.95	CA12381R#	14 80				
605 2.1 Diesel	[P9A (XUD11A)]	05.89- 07.95	CA5561R	14 80	05.89- 07.95	CS594	12 1.4	
		05.89- 07.95	CA5871R	14 70	05.89- 07.95	CS712	12 2.2	
		05.89- 07.95	CA6141R	14 90				
		05.89- 07.95	CA8321R	14 120				
605 2.1 TD 12V	[P8C (XUD11BTE)]	08.94- 06.95	CA12381R#	14 80	08.94- 09.99	CS712	12 2.2	
		07.95- 09.99	CA10651R	14 95	08.94- 09.99	CS594	12 1.4	
		07.95- 09.99	CA10981R	14 120				
605 2.1 TD	[PHZ (XUD11ATE)]	06.89- 06.93	CA6141R	14 90	06.89- 10.96	CS712	12 2.2	
		07.93- 06.95	CA12381R#	14 80	06.89- 10.96	CS373	12 1.7	
		07.93- 06.95	CA8351R	14 90				
		06.95- 10.96	CA10651R	14 95				
		06.95- 10.96	CA10981R	14 120				
		06.95- 10.96	CA13121R	14 150				
605 2.5 TD	[THY (DK5ATE)]	07.94- 05.99	CA10991R	14 120	07.94- 05.99	CS885	12 2.2	
605 3.0	[UFZ (ZPJ)]	07.93- 05.99	CA5561R	14 80	07.93- 05.99	CS551	12 1.4	
		07.93- 05.99	CA5871R	14 70				
		07.93- 05.99	CA8321R	14 120				
605 3.0 i 24V	[LUKZ (ZPJ4Z)]	07.93- 05.99	CA8321R	14 120	07.93- 05.99	CS551	12 1.4	
605 3.0 V6	[ES9J4]	04.97- 05.99	CA13381R	14 120	04.97- 05.99	CS1108	12 1.5	
607 2.0	[RFN (EW10J4)]	02.00-	CA14991R	14 80	02.00-	CS1244	12 1.1	
		02.00-	CA15891R	14 90	02.00-	CS1277	12 1.4	
		02.00-	CA16411R	14 80				
		02.00-	CA17411R	14 120				



**PEUGEOT** *Continued*

607 2.0 HDi	[RHR (DW10BTED4)]	09.05-	CA1920IR	14 180	09.05-	CS1342	12 1.9
	[RHS (DW10ATED)]	03.01- 07.04	CA1509IR	14 150 BO	03.01- 07.04	CS1177	12 1.7
		03.01- 07.04	CA1553IR	14 150 VA	03.01- 07.04	CS1326	12 2.3
		03.01- 07.04	CA1761IR	14 150			
	[RHZ (DW10ATED)]	05.00-	CA1509IR	14 150	05.00-	CS1177	12 1.7
		05.00-	CA1553IR	14 150	05.00-	CS1326	12 2.3
607 2.2 16V	[3FZ (EW12J4)]	02.00- 11.04	CA1564IR	14 90	03.00- 11.04	CS1277	12 1.4
		02.00- 11.04	CA1646IR	14 120	AT 03.00- 11.04	CS1244	12 1.1
		12.04-	CA1674IR	14 150			
	[EW12J4]	09.05-	CA1674IR	14 150	09.05-	CS594	12 1.4
		09.05-	CA1741IR	14 120			
607 2.2 HDi	[4HX (DW12TED4/FAP)]	02.00-	CA1509IR	14 150	02.00-	CS1326	12 2.3
		02.00-	CA1553IR	14 150	02.00-	CS1177	12 1.7
					02.00-	CS594	12 1.4
607 2.2 HDi FAP	[4HT (DW12BTED4)]	05.06-	CA1920IR	14 180	05.06-	CS1416	12 2.5
607 2.7 HDi 24V	[DT17TED4]	12.04-	CA1888IR	14 180	12.04-	JS1368*	12 2.2
607 3.0 V6 24V	[XFV (ES9A)]	12.04-	CA1388IR	14 150	12.04-	CS1290	12 1.3
		12.04-	CA1392IR	14 120			
	[XFX (ES9J4S)]	02.00- 11.04	CA1388IR	14 150	A34 02.00- 11.04	CS1290	12 1.3
		02.00- 11.04	CA1392IR	14 120			
806 1.8	[LFW (XU7JP)]	07.95- 08.02	CA1086IR	14 80	07.95- 08.02	CS566	12 1.1
		07.95- 08.02	CA820IR	14 70	07.95- 08.02	CS715	12 1.4
		07.95- 08.02	CA825IR	14 95			
		07.95- 08.02	CA836IR	14 120			
806 1.9 TD	[DHX (XUD9TE)]	08.94- 08.02	CA1043IR	14 80	07.95- 08.02	CS1177	12 1.7
		08.94- 08.02	CA1065IR	14 95	07.95- 08.02	CS712	12 2.2
		08.94- 08.02	CA1098IR	14 120	08.94- 08.02	CS594	12 1.4
		08.94- 08.02	CA1155IR	14 70	08.94- 08.02	CS373	12 1.7
	[DHY (XUD9TE)]	03.94- 08.02	CA1043IR	14 80	07.95- 08.02	CS1177	12 1.7
		03.94- 08.02	CA1065IR	14 95	03.94- 08.02	CS594	12 1.4
	03.94- 08.02	CA1098IR	14 120	03.94- 08.02	CS373	12 1.7	
	03.94- 08.02	CA1155IR	14 70				
806 2.0	[RFU (XU10J2)]	06.94- 08.02	CA1086IR	14 80	06.94- 08.02	CS566	12 1.1
		06.94- 08.02	CA820IR	14 70	06.94- 08.02	CS715	12 1.4
		06.94- 08.02	CA825IR	14 95			
		06.94- 08.02	CA836IR	14 120			
806 2.0 16V	[RFN (EW10J4)]	09.00-	CA1564IR	14 90	09.00-	CS1244	12 1.1
		09.00-	CA1646IR	14 120	09.00-	CS1277	12 1.4
	[RFV (XU10J4R)]	05.98- 09.00	CA1052IR	14 90	05.98- 09.00	CS566	12 1.1
		05.98- 09.00	CA1151IR	14 70	05.98- 09.00	CS715	12 1.4
		05.98- 09.00	CA1152IR	14 80			
806 2.0 Turbo	[RGX (XU10J2TE)]	Eng. 7390- 04.97- 08.02	CA1052IR	14 90	06.94- 08.02	CS715	12 1.4
		Eng. 7390- 04.97- 08.02	CA1151IR	14 70	06.94- 08.02	CS566	12 1.1
		Eng. 7390- 04.97- 08.02	CA1152IR	14 80			
		Eng. 7390- 04.97- 08.02	CA1156IR	14 120			
		Eng. -7389 06.94- 03.97	CA1086IR	14 80			
		Eng. -7389 06.94- 03.97	CA820IR	14 70			
		Eng. -7389 06.94- 03.97	CA825IR	14 95			
		Eng. -7389 06.94- 03.97	CA836IR	14 120			
806 2.0 HDi 16V	[RHW (DW10ATED4)]	08.99- 08.02	CA1509IR	14 150	08.99- 08.02	CS712	12 2.2
		08.99- 08.02	CA1553IR	14 150	08.99- 08.02	CS594	12 1.4
		08.99- 08.02	CA1564IR	14 90	08.99- 08.02	CS1177	12 1.7
		08.99- 08.02	CA1646IR	14 120			
		AC 08.99- 08.02	CA1509IR	14 150			
		AC 08.99- 08.02	CA1553IR	14 150			
	AC 08.99- 08.02	CA1646IR	14 120				
806 2.0 HDi	[RHZ (DW10ATED)]	08.99- 08.02	CA1509IR	14 150	08.99- 08.02	CS1177	12 1.7
		08.99- 08.02	CA1553IR	14 150	08.99- 08.02	CS594	12 1.4
		08.99- 08.02	CA1564IR	14 90			
		08.99- 08.02	CA1646IR	14 120			
		AC 08.99- 08.02	CA1509IR	14 150			
		AC 08.99- 08.02	CA1553IR	14 150			
	AC 08.99- 08.02	CA1646IR	14 120				
806 2.1 TD	[P8C (XUD11BTE)]	06.96- 08.00	CA1043IR	14 80	06.96- 08.00	CS712	12 2.2
		06.96- 08.00	CA1065IR	14 95	06.96- 08.00	CS1177	12 1.7
		06.96- 08.00	CA1098IR	14 120	06.96- 08.00	CS373	12 1.7
		06.96- 08.00	CA1155IR	14 70	06.96- 08.00	CS594	12 1.4
807 2.0	[RFN (EW10J4)]	06.02-	CA1589IR	14 90	06.02-	CS1277	12 1.4
		06.02-	CA1674IR	14 150	06.02-	CS1244	12 1.1
		06.02-	CA1741IR	14 120			
807 2.0 16V	[RFJ (EW10A)]	09.05-	CA1914IR	14 150	09.05-	CS594	12 1.4
		09.05-	CA2015IR	14 120	09.05-	CS1244	12 1.1
807 2.0 HDi	[DW10UTED4]	11.06-	CA1761IR	14 150	11.06-	CS1177	12 1.7
		11.06-	CA1920IR	14 180	11.06-	CS594	12 1.4
					11.06-	CS1342	12 1.9
	[RHH (DW10CTED4)]	06.09-	CA2030IR	14 180	06.09-	CS1342	12 1.9
		06.09-	CA2033IR	14 150	06.09-	CS1177	12 1.7
	[RHK (DW10UTED4)]	06.02-	CA1553IR	14 150	06.02-	CS594	12 1.4
					06.02-	CS1177	12 1.7
					06.02-	CS1326	12 2.3
	[RHM (DW10ATED4)]	06.02- 12.02	CA1553IR	14 150	06.02-	CS1177	12 1.7
		01.03-	CA1761IR	14 150	06.02-	CS594	12 1.4
					06.02-	CS1326	12 2.3
	[RHR (DW10BTED4)]	06.06-	CA1761IR	14 150	06.06-	CS1342	12 1.9
	[RHT (DW10ATED4)]	06.02-	CA1553IR	14 150	06.02-	CS1326	12 2.3
					06.02-	CS1177	12 1.7
					06.02-	CS594	12 1.4
	[RHW (DW10ATED4)]	06.02-	CA1553IR	14 150	06.02-	CS594	12 1.4
					06.02-	CS1177	12 1.7
				06.02-	CS1326	12 2.3	
		04.04- 05.06	CA1553IR	14 150	04.04- 05.06	CS594	12 1.4
				04.04- 05.06	CS1326	12 2.3	
				04.04- 05.06	CS1177	12 1.7	
807 2.2	[3FZ]	06.02-	CA1589IR	14 90	06.02-	CS1244	12 1.1
		06.02-	CA1674IR	14 150	06.02-	CS1277	12 1.4
		06.02-	CA1741IR	14 120			
807 2.2 HDi	[4HT (DW12BTED4)]	06.06-	CA1761IR	14 150	06.06-	CS1416	12 2.5
		06.06-	CA1920IR	14 180			
807 2.2 HDi FAP	[4HX (DW12TED4)]	06.02-	CA1553IR	14 150	06.02-	CS594	12 1.4
				06.02-	CS1177	12 1.7	
				06.02-	CS1326	12 2.3	
807 3.0 V6	[XFX (ES9J4S)]	06.02-	CA1388IR	14 150	06.02-	CS1277	12 1.4
		06.02-	CA1392IR	14 120	06.02-	CS1244	12 1.1



1007 1.4	[KFV (TU3JP)]	04.05- 04.05-	CA1665IR CA1687IR	14 80 14 70	04.05- 04.05-	CS1111 CS581	12 0.7 12 1.0
1007 1.4 16V	[KFU (ET3J4)]	10.05-	CA1665IR	14 80	10.05- 10.05-	CS581 CS390	12 1.0 12 0.9
1007 1.4 HDi	[8HX (DV4TD)]	04.05-	CA1674IR	14 150	04.05- 04.05-	CS1329 CS1260	12 1.5 12 1.1
	[8HZ (DV4TD)]	04.05-	CA1674IR	14 150	04.05- 04.05-	CS1260 CS1329	12 1.1 12 1.5
1007 1.6	[NFU (TU5JP4)]	04.05-	CA1665IR	14 80	04.05-	CS390	12 0.9
1007 1.6 HDi	[9HZ (DV6TED4)]	06.07-	CA1761IR	14 150	06.07-	CS1391	12 2.2
3008 1.6 THP	[5FV (EP6DT)]	06.09- 06.09- 06.09-	CA1954IR CA1990IR* CA2006IR	14 120 14 120 14 150	06.09-	CS1417	12 0.9
3008 1.6 i	[EP6CDT]	05.09-	CA2006IR	14 150	05.09-	CS1417	12 0.9
3008 1.6 i THP 150	[5FX (EP6DT)]	06.09- 06.09- 06.09-	CA1954IR CA1990IR* CA2006IR	14 120 14 120 14 150	06.09-	CS1417	12 0.9
3008 1.6 VTi	[5FW (EP6)]	06.09- 06.09- 06.09-	CA1954IR CA1990IR* CA2006IR	14 120 14 120 14 150	06.09-	CS1417	12 0.9
3008 1.6 HDi	[9HR (DV6C)]	08.10-	CA2033IR	14 150	08.10- 08.10-	CS1391 CS1329	12 2.2 12 1.5
	[9HZ (DV6ATED4)]	06.09-	CA1761IR	14 150	06.09- 06.09-	CS1391 CS1329	12 2.2 12 1.5
3008 2.0 Diesel Hybrid4	[DW10CTED4]				02.11-	CS1342	12 1.9
3008 2.0 HDi	[RHE (DW10CTED4)]	06.09-	CA2030IR	14 180	06.09-	CS1416	12 2.5
	[RHH (DW10CTED4)]	06.09-	CA2030IR	14 180	06.09-	CS1416	12 2.5
4007 2.2 HDi	[DW12MTED4]	02.07-	CA2008IR	14 150	02.07- 02.07- 02.07- 02.07-	CS594 CS1177 CS1416 CS373	12 1.4 12 1.7 12 2.5 12 1.7
4007 2.4 16V	[MMC]	01.08-	CA2013IR*	14 120			
5008 1.6 16V	[5FV (EP6DT)]	09.09-	CA2006IR	14 150	09.09-	CS1417	12 0.9
	[5FW (EP6)]	09.09- 09.09- AC 09.09-	CA1954IR CA1990IR* CA2006IR	14 120 14 120 14 150	09.09-	CS1417	12 0.9
5008 1.6 HDi	[9HR (DV6C)]	08.10- AC 08.10-	CA2030IR CA2033IR	14 180 14 150	08.10- 08.10-	CS1391 CS1329	12 2.2 12 1.5
	[9HZ (DV6TED4)]	09.09-	CA1761IR	14 150	09.09- 09.09-	CS1391 CS1329	12 2.2 12 1.5
	[9HZP (DV6TED4)]	09.09-	CA1761IR	14 150	09.09- 09.09-	CS1329 CS1391	12 1.5 12 2.2
5008 2.0 HDi	[RHE (DW10CTED4)]	06.09-	CA2030IR	14 180	06.09-	CS1416	12 2.5
	[RHH (DW10CTED4)]	09.09-	CA2030IR	14 180	09.09-	CS1416	12 2.5
206+ 1.1	[HFX (TU1AE5)]	01.09-	CA1498IR	14 70	01.09- 01.09- 01.09-	CS581 CS1111 CS390	12 1.0 12 0.7 12 0.9
206+ 1.4	[KFV (TU3A)]	01.09- 01.09-	CA1499IR CA1589IR	14 80 14 90	01.09- 01.09- 01.09-	CS581 CS1111 CS390	12 1.0 12 0.7 12 0.9
206+ 1.4 HDi eco 70	[8HX (DV4TD)]	01.09-	CA1761IR	14 150	01.09- 01.09-	CS1329 CS1260	12 1.5 12 1.1
	[8HZ (DV4TD)]	01.09-	CA1761IR	14 150	01.09- 01.09-	CS1329 CS1260	12 1.5 12 1.1
207 CC 1.6 16V Turbo	[EP6CDT]	10.09- 10.09-	CA1990IR* CA2006IR	14 120 14 150	10.09-	CS1417	12 0.9
207 SW 1.6 16V	[5FY (EP6DTS)]	02.07- 02.07- 02.07-	CA1954IR CA1990IR* CA2006IR	14 120 14 120 14 150	02.07-	CS1417	12 0.9
207 SW 1.6 HDi	[9HL (DV6C)]	08.09-	CA2033IR	14 150	08.09- 08.09-	CS1391 CS1329	12 2.2 12 1.5
	[DV6DTEd]	11.09-	CA2033IR	14 150	11.09- 11.09-	CS1391 CS1329	12 2.2 12 1.5
270 CC 1.6 HDi	[9HL (DV6C)]	08.09- 08.09-	CA1761IR CA2008IR	14 150 14 150	08.09- 08.09-	CS1329 CS1391	12 1.5 12 2.2
308 CC 1.6 THP	[EP6CDTX]	10.10-	CA1954IR	14 120	10.10-	CS1417	12 0.9
308 CC 1.6 16V	[5FS (EP6C)]	06.09- 06.09- 06.09- 06.09-	CA1954IR CA1990IR* CA1954IR CA1990IR* CA2006IR CA2087IR*	14 120 14 120 14 120 14 120 14 150 14 80	06.09- 06.09-	CS1417	12 0.9 12 0.9
	[5FT (EP6DT)]	06.09- 06.09- 06.09- 06.09-	CA1954IR CA1990IR* CA2006IR CA2087IR*	14 120 14 120 14 150 14 80	06.09-	CS1417	12 0.9
	[5FV (EP6CDT)]	06.09-	CA2006IR	14 150	06.09-	CS1417	12 0.9
308 CC 1.6 HDi	[9HL (DV6C)]	06.09- 06.09-	CA2030IR CA2033IR	14 180 14 150	06.09-	CS1391	12 2.2
	[9HR (DV6C)]	06.09- 06.09-	CA2030IR CA2033IR	14 180 14 150	06.09-	CS1391	12 2.2
308 CC 2.0 HDi	[RHR (DW10BTED4)]	04.09- 06.09-	CA1761IR CA1761IR	14 150 14 150	04.09- 06.09-	CS1416 CS1416	12 2.5 12 2.5
308 SW 1.4 16V	[8FS (EP3)]	12.09- 12.09- 12.09-	CA1954IR CA1990IR* CA2006IR	14 120 14 120 14 150	12.09-	CS1417	12 0.9
308 SW 1.6 16V	[5FT (EP6DT)]	09.07- 09.07- 09.07- 09.07-	CA1954IR CA1990IR* CA2006IR CA2087IR*	14 120 14 120 14 150 14 80	09.07-	CS1417	12 0.9
	[5FV (EP6CDT)]	10.09- 10.09- 06.10	CA1954IR CA2006IR	14 120 14 150	10.09-	CS1417	12 0.9
308 SW 1.6 HDi	[9HR (DV6C)]	12.09- 12.09-	CA2030IR CA2033IR	14 180 14 150	12.09- 12.09-	CS1329 CS1391	12 1.5 12 2.2
308 SW 2.0 Bioflex	[RFJ (EW10A)]	01.08- 01.08-	CA1914IR CA2015IR	14 150 14 120	01.08-	CS1244	12 1.1
308 SW 2.0 HDi	[RHF (DW10BTED4)]	09.07-	CA1761IR	14 150	09.07-	CS1416	12 2.5
	[RHR (DW10BTED4)]	09.07- 06.09-	CA1761IR	14 150	09.07- 06.09-	CS1416 CS1416	12 2.5 12 2.5
380 SW 1.6 HDi		11.09- 11.09-	CA2030IR CA2033IR	14 180 14 150	11.09- 11.09-	CS1260	12 1.1
407 SW 2.0 Bioflex	[RFJ (EW10A)]	01.08- 01.08-	CA1914IR CA2015IR	14 150 14 120	01.08-	CS1244	12 1.1
407 SW 2.0 HDi	[RHE (DW10CTED4)]	02.10-	CA2030IR	14 180	02.10-	CS1416	12 2.5
	[RHH (DW10CTED4)]	07.09-	CA2030IR	14 180	07.09-	CS1416	12 2.5
407 SW 2.2 HDi		06.08-	CA1920IR	14 180	06.08-	CS1416	12 2.5



**PEUGEOT** *Continued*

508 SW 1.6 THP	[5FV (EP6DT)]	11.10-	CA1954IR	14	120	11.10-	CS1417	12	0.9
		11.10-	CA1990IR*	14	120				
		11.10-	CA2006IR	14	150				
508 SW 1.6 VTi	[5FS (EP6C)]	11.10-	CA1954IR	14	120	11.10-	CS1417	12	0.9
		11.10-	CA1990IR*	14	120				
		11.10-	CA2006IR	14	150				
508 SW 1.6 HDi	[9HD (DV6CTED)]					02.12-	CS1329	12	1.5
						02.12-	CS1391	12	2.2
						02.12-	CS566	12	1.1
	[9HR (DV6C)]	11.10-	CA2030IR	14	180	11.10-	CS1329	12	1.5
508 SW 2.0 HDi	[DW10BTED4]	11.10-	CA2033IR	14	150	11.10-	CS1391	12	2.2
						11.10-	CS1342	12	1.9
	[DW10C]					11.10-	CS594	12	1.4
508 SW 2.2 HDi	[DW12C]	11.10-	CA2030IR	14	180	11.10-	CS1416	12	2.5
						11.10-	CS90	12	0.9
						02.08-	CS581	12	1.0
Bipper 1.4	[TU3A]	02.08-	CA1499IR	14	80	02.08-	CS390	12	0.9
		02.08-	CA1589IR	14	90	02.08-	CS594	12	1.4
Bipper 1.4 Tepee	[KVF (TU3A)]	04.08-	CA1499IR	14	80	04.08-	CS390	12	0.9
						04.08-	CS581	12	1.0
Bipper 1.4 HDi	[8HS (DV4TED)]	04.08-	CA2031IR	14	90	04.08-	CS1329	12	1.5
						04.08-	CS1260	12	1.1
	[DV4TED]	02.08-	CA2031IR	14	90	02.08-	CS1329	12	1.5
Boxer 1.9 Diesel	[D8C (XUD9AU)]	03.94- 04.02	CA638IR	14	80	03.94- 04.02	CS712	12	2.2
						03.94- 04.02	CS1177	12	1.7
	[DJY (XUD9A)]	07.98- 02.02	CA638IR	14	80	03.94- 04.02	CS594	12	1.4
Boxer 1.9 DT 4x4	[XUD9TE]	03.96- 09.98	CA638IR	14	80	07.98- 02.02	CS1177	12	1.7
						03.96- 09.98	CS712	12	2.2
						03.96- 09.98	CS1177	12	1.7
Boxer 1.9 TD	[D8C (XUD9UTF)]	03.94- 04.02	CA638IR	14	80	03.96- 09.98	CS594	12	1.4
						03.94- 04.02	CS712	12	2.2
	[DHX (XUD9TE)]	02.94- 02.02	CA638IR	14	80	03.94- 04.02	CS177	12	1.7
Boxer 1.9 TD 4x4	[D8C (XUD9UTF)]	07.96- 04.02	CA638IR	14	80	02.96- 04.02	CS712	12	2.2
						03.94- 04.02	CS177	12	1.7
						02.96- 04.02	CS373	12	1.7
Boxer 2.0	[RFL (XU10J2U)]	04.02-	CA1086IR	14	80	03.94- 04.02	CS712	12	2.2
						02.94- 02.02	CS1177	12	1.7
						02.94- 02.02	CS594	12	1.4
Boxer 2.0 4x4		03.96- 09.98	CA836IR	14	120	03.96- 04.02	CS712	12	2.2
		AC 03.96- 09.98	CA825IR	14	95	03.94- 04.02	CS1177	12	1.7
		03.96- 09.98	CA1086IR	14	80	08.94- 04.02	CS594	12	1.4
Boxer 2.0 i	[RFW (XU10J2U)]	02.94- 04.02	CA1086IR	14	80	07.96- 04.02	CS712	12	2.2
		02.94- 04.02	CA836IR	14	120	07.96- 04.02	CS594	12	1.4
		AC 02.94- 04.02	CA825IR	14	95	04.02-	CS715	12	1.4
Boxer 2.0 i 4x4	[RFW (XU10J2U)]	08.96- 04.02	CA1086IR	14	80	04.02-	CS566	12	1.1
		08.96- 04.02	CA836IR	14	120	02.94- 04.02	CS715	12	1.4
		AC 08.96- 04.02	CA825IR	14	95	02.94- 04.02	CS566	12	1.1
Boxer 2.0 HDi	[RHV (DW10TD)]	08.01- 04.02	CA1553IR	14	150	08.01- 04.02	CS594	12	1.4
		08.01- 04.02	CA1564IR	14	90	A13 08.01- 04.02	CS712	12	2.2
	[RHV (DW10UTD)]	04.02- 05.05	CA1564IR	14	90	08.01- 04.02	CS1177	12	1.7
Boxer 2.2 HDi	[22DT] [4HY (DW12UTED)]	04.06-	CA1928IR	14	150	04.02-	CS570	12	3.1
		04.02- 05.04	CA1564IR	14	90	04.02-	CS1177	12	1.7
		05.04-	CA1879IR	14	90	04.02-	CS1326	12	2.3
		AC 04.02- 05.04	CA1509IR	14	150				
		AC 04.02- 05.04	CA1564IR	14	90				
		AC 04.02- 05.04	CA1761IR	14	150				
		AC 05.04-	CA1879IR	14	90				
Boxer 2.4 TDi	[THX (DJ5TED)]	10.96- 02.02	CA1086IR	14	80	10.96- 02.02	CS885	12	2.2
		10.96- 04.02	CA825IR	14	95				
		10.96- 04.02	CA836IR	14	120				
Boxer 2.4 TDi 4x4	[THX (DJ5TED)]	10.96- 04.02	CA1086IR	14	80	10.96- 04.02	CS885	12	2.2
		10.96- 04.02	CA825IR	14	95				
		10.96- 04.02	CA836IR	14	120				
Boxer 2.5 i	[RFW (XU10J2U)]	06.94- 04.02	CA1086IR	14	80	06.94- 04.02	CS715	12	1.4
		06.94- 04.02	CA836IR	14	120	06.94- 04.02	CS566	12	1.1
		AC 06.94- 04.02	CA825IR	14	95				
Boxer 2.5 Diesel	[T9A (DJ5)]	03.94- 04.02	CA1086IR	14	80	03.94- 04.02	CS885	12	2.2
		03.94- 04.02	CA825IR	14	95				
		03.94- 04.02	CA836IR	14	120				
Boxer 2.5 Diesel 4x4	[T9A (DJ5)]	02.94- 04.02	CA825IR	14	95	02.94- 04.02	CS885	12	2.2
		02.94- 04.02	CA836IR	14	120				
		07.96- 04.02	CA1086IR	14	80				
Boxer 2.5 DT		10.97- 11.01	CA836IR	14	120	10.97- 11.01	CS885	12	2.2
		10.97- 11.01	CA825IR	14	95				
		10.97- 11.01	CA1086IR	14	80				
Boxer 2.5 TD	[T8A (DJ5T)]	03.94- 04.02	CA1086IR	14	80	03.94- 04.02	CS885	12	2.2
		03.94- 04.02	CA825IR	14	95				
		03.94- 04.02	CA836IR	14	120				
Boxer 2.5 TD 4x4	[T8A (DJ5T)]	07.96- 04.02	CA1086IR	14	80	07.96- 04.02	CS885	12	2.2
		07.96- 04.02	CA825IR	14	95				
		07.96- 04.02	CA836IR	14	120				
Boxer 2.5 TDi	[THX (DJ5TED)]	01.97- 04.02	CA1086IR	14	80	01.97- 04.02	CS885	12	2.2
		01.97- 04.02	CA825IR	14	95				
		01.97- 04.02	CA836IR	14	120				
Boxer 2.5 TDi 4x4	[THX (DJ5TED)]	10.96- 02.02	CA825IR	14	95	10.96- 04.02	CS885	12	2.2
		10.96- 02.02	CA836IR	14	120				
Boxer 2.8 Diesel	[8140.63 (F28D)]					01.99- 02.02	CS973	12	2.2





Boxer 2.8 HDi	[8140.43S]	11.00-	CA1643IR	14 120	Chas. 17600144- 11.00-	CS1389	12 2.5	
		11.00-	CA1781IR	14 90	Chas. -17600143 11.00-	CS1198	12 2.3	
		11.00- 04.02	CA2037IR	14 150				
		10.00- 11.01	CA2037IR	14 150	10.00- 11.01	CS1389	12 2.5	
		10.00- 11.01	CA1781IR	14 90	10.00- 11.01	CS1198	12 2.3	
		10.00- 11.01	CA1643IR	14 120				
Boxer 2.8 HDi 4x4	[8140.43S]	10.00- 04.02	CA1643IR	14 120	Chas. -17600143 10.00- 04.02	CS1198	12 2.3	
		10.00- 04.02	CA2037IR	14 150	Chas. 17600144- 04.02-	CS1389	12 2.5	
		04.02-	CA1781IR	14 90	10.00- 04.02	CS1109	12 2.6	
Boxer 2.8 TD	[8140.43]	12.01- 03.05	CA1039IR	14 80	12.01- 03.05	CS1109	12 2.6	
		12.01- 03.05	CA1157IR	14 110	12.01- 03.05	CS1198	12 2.3	
		12.01- 03.05	CA1835IR	14 120				
Boxer 3.0 HDi	[F30DTE5]	04.10-	CA1913IR	14 140	04.10-	CS1449	12 2.5	
		03.11-	CA1913IR	14 140				
Expert 1.6 HDi	[DV6UTED4]	01.07-	CA1761IR	14 150	01.07-	CS1260	12 1.1	
Expert 1.6 HDi Tepee	[DV6UTED4]	01.07-	CA1761IR	14 150	01.07-	CS1260	12 1.1	
Expert 1.8		10.96- 09.00	CA825IR	14 95	10.96- 09.00	CS566	12 1.1	
		10.96- 09.00	CA820IR	14 70				
		AC 10.96- 09.00	CA1086IR	14 80				
		AC 10.96- 09.00	CA836IR	14 120				
Expert 1.9 Diesel	[D9B (XUD9AU)]	02.96-	CA1043IR	14 80	02.96-	CS594	12 1.4	
		02.96-	CA1065IR	14 95	02.96-	CS1177	12 1.7	
		02.96-	CA1098IR	14 120	02.96-	CS712	12 2.2	
		02.96-	CA1155IR	14 70				
	[DW8]	06.98-	CA1442IR	14 70	06.98-	CS594	12 1.4	
		06.98-	CA1496IR	14 80	06.98-	CS1177	12 1.7	
		06.98-	CA1564IR	14 90				
		06.98-	CA1932IR	14 60				
	[WJY (DW8B)]	12.98-	CA1442IR	14 70	12.98-	CS712	12 2.2	
		12.98-	CA1496IR	14 80	12.98-	CS594	12 1.4	
		12.98-	CA1932IR	14 60	12.98-	CS1177	12 1.7	
		AC 12.98-	CA1564IR	14 90				
			AC 12.98-	CA1646IR	14 120			
	[WJZ (DW8)]	12.98-	CA1442IR	14 70	12.98-	CS1177	12 1.7	
		12.98-	CA1496IR	14 80	12.98-	CS594	12 1.4	
		12.98-	CA1932IR	14 60	12.98-	CS712	12 2.2	
AC 12.98-		CA1564IR	14 90					
		AC 12.98-	CA1646IR	14 120				
Expert 1.9 TD	[D8B (XUD9TE)]	02.96-	CA1043IR	14 80	02.96-	CS594	12 1.4	
		02.96-	CA1065IR	14 95	02.96-	CS712	12 2.2	
		02.96-	CA1098IR	14 120	02.96-	CS1177	12 1.7	
		02.96-	CA1155IR	14 70				
	[D8X (XUD9TE)]	02.96-	CA1043IR	14 80	02.96-	CS712	12 2.2	
		02.96-	CA1065IR	14 95	02.96-	CS594	12 1.4	
		02.96-	CA1098IR	14 120				
		02.96-	CA1153IR	14 65				
		02.96-	CA1155IR	14 70				
Expert 2.0	[RFN (EW10J4)]	03.00-	CA1564IR	14 90	03.00- 12.03	CS1244	12 1.1	
		03.00-	CA1646IR	14 120	09.02-	CS1277	12 1.4	
		07.00-	CA1932IR	14 60				
Expert 2.0 16V	[RFJ (EW10A)]	01.07-	CA1914IR	14 150	01.07-	CS1244	12 1.1	
		01.07-	CA2015IR	14 120				
Expert 2.0 HDi	[RHH (DW10CTED4)]	09.09- 02.11	CA2030IR	14 180	09.09-	CS1177	12 1.7	
		09.09- 02.11	CA2033IR	14 150	09.09-	CS1342	12 1.9	
	[RHK (DW10UTED4)]	01.07-	CA1761IR	14 150	01.07-	CS1342	12 1.9	
		01.07-	CA1920IR	14 180				
	[RHR (DW10BTED4)]	01.07-	CA1761IR	14 150	01.07-	CS1342	12 1.9	
		01.07-	CA1920IR	14 180				
	[RHW (DW10ATED4)]	07.00-	CA1496IR	14 80	07.00-	CS594	12 1.4	
		07.00-	CA1564IR	14 90	07.00-	CS1177	12 1.7	
		07.00-	CA1646IR	14 120	07.00-	CS712	12 2.2	
		Chas. 09520- 07.00-	CA1761IR	14 150				
Chas. 09520- 07.00-	CA1761IR	14 150						
Chas. -09519 07.00-	CA1509IR	14 150						
Chas. -09519 07.00-	CA1553IR	14 150						
[RHX (DW10BTED)]	01.03-	CA1761IR	14 150	10.99-	CS1177	12 1.7		
	10.99- 12.02	CA1553IR	14 150	10.99-	CS594	12 1.4		
	AC 10.99- 12.02	CA1509IR	14 150					
[RHZ (DW10ATED)]	07.00-	CA1496IR	14 80	10.99-	CS594	12 1.4		
	01.03-	CA1761IR	14 150	10.99-	CS1177	12 1.7		
	10.99- 12.02	CA1553IR	14 150					
	AC 07.00- 01.03	CA1553IR	14 150					
	AC 10.99- 01.03	CA1509IR	14 150					
Expert 2.0 HDi Tepee	[RHH (DW10CTED4)]	09.09- 02.11	CA2030IR	14 180	09.09-	CS1342	12 1.9	
		09.09- 02.11	CA2033IR	14 150	09.09-	CS1177	12 1.7	
	[RHK (DW10UTED4)]	01.07-	CA1761IR	14 150	01.07-	CS1342	12 1.9	
		01.07-	CA1920IR	14 180				
[RHR (DW10BTED4)]	01.07-	CA1761IR	14 150	01.07-	CS1342	12 1.9		
	01.07-	CA1920IR	14 180					
J5 1.8	[169B (XM7T)]	01.83- 11.88	CA150IR	14 50	01.83- 11.88	CS352	12 0.85	
		01.83- 11.88	CA377IR	14 70	01.83- 11.88	CS129	12 0.9	
J5 1.9 Diesel	[D9B (XUD9A)]	11.87- 12.93	CA294IR	14 50	11.87- 12.93	CS373	12 1.7	
J5 2.0	[170 (XN1T)]	01.83- 09.90	CA150IR	14 50	01.83- 09.90	CS129	12 0.9	
		01.83- 09.90	CA377IR	14 70	01.83- 09.90	CS352	12 0.85	
	[170B (XN1T)]	09.81- 09.90	CA150IR	14 50	09.81- 09.90	CS129	12 0.9	
		09.81- 09.90	CA377IR	14 70	09.81- 09.90	CS352	12 0.85	
[170D (XN1TACP)]	10.90- 12.93	CA150IR	14 50	10.90- 12.93	CS129	12 0.9		
	10.90- 12.93	CA377IR	14 70	10.90- 12.93	CS352	12 0.85		
J5 2.5 Diesel	[CRD93]	09.81- 12.93	CA175IR	14 70	09.81- 09.90	CS155	12 2.4	
		09.81- 12.93	CA735IR	14 75	09.81- 12.93	CS382	12 2.8	
					07.87- 12.93	CS361	12 2.2	
J5 2.5 Diesel 4x4	[CDR93]	10.90- 12.93	CA175IR	14 70	10.90- 12.93	CS155	12 2.4	
		10.90- 12.93	CA735IR	14 75	10.90- 12.93	CS382	12 2.8	
	[CRD93]	10.90- 12.93	CA175IR	14 70	10.90- 12.93	CS382	12 2.8	
		10.90- 12.93	CA735IR	14 75	10.90- 12.93	CS155	12 2.4	
J5 2.5 TD	[CRD93LS]	10.90- 12.93	CA735IR	14 75	10.90- 12.93	CS361	12 2.2	
J5 2.5 TD 4x4	[CRD93LS]	10.90- 12.93	CA735IR	14 75	10.90- 12.93	CS361	12 2.2	
J7 1.5	[XB5P]	10.67- 07.71	CA150IR	14 50				
J7 1.6	[XC5P]	10.67- 03.80	CA150IR	14 50	08.68- 03.80	CS362	12 1.0	
					07.70- 03.80	CS362	12 1.0	
	[XC7P]	08.68- 09.80	CA150IR	14 50	07.70- 03.80	CS362	12 1.0	
J7 1.8	[XM7P]	07.70- 09.80	CA150IR	14 50	07.70- 09.80	CS362	12 1.0	
J9 1.6	[XC7P]	10.80- 06.87	CA315IR	14 70	10.80- 06.87	CS362	12 1.0	
		10.80- 06.87	CA377IR	14 70				



**PEUGEOT** *Continued*

J9 2.0	[XN1P]	03.80- 06.87 CA1501R 14 50	03.80- 06.87 CS362 12 1.0	
		10.80- 06.87 CA3151R 14 70		
		10.80- 06.87 CA3771R 14 70		
J9 2.1 Diesel	[XDPX90]	10.80- 06.87 CA3081R 14 50		
		10.80- 06.87 CA3151R 14 70		
J9 2.3 Diesel	[XD2PX94]	03.80- 10.82 CA3081R 14 50	03.80- 07.82 CS366 12 2.5	
		03.80- 07.82 CA3151R 14 70		
J9 2.5 Diesel	[XD3P]	07.82- 06.87 CA3081R 14 50	07.82- 06.87 CS366 12 2.5	
		07.82- 06.87 CA3151R 14 70		
Partner 1.1	[HDZ (TU1M)]	06.96- 08.02 CA12431R 14 90	06.96- 08.02 CS581 12 1.0	
		06.96- 08.02 CA13051R 14 65		
		06.96- 08.02 CA7151R 14 80		
	[HFX (TU1JP)]	09.00- CA12431R 14 90	06.96- CS581 12 1.0	
		09.00- CA13051R 14 65	06.96- CS1111 12 0.7	
		06.96- 08.02 CA6181R 14 70		
Partner 1.4	[KFW (TU3JP)]	09.00- 08.02 CA12431R 14 90	06.96- CS581 12 1.0	
		09.00- 08.02 CA6181R 14 70		
		09.00- 08.02 CA7151R 14 80		
		06.96- CA13051R 14 65		
	[KFX (TU3JP)]	06.96- 08.02 CA12431R 14 90	06.96- 08.02 CS581 12 1.0	
		06.96- 08.02 CA13051R 14 65		
		06.96- 08.02 CA7151R 14 80		
		11.02- 10.06 CA15891R 14 90	11.02- 10.06 CS581 12 1.0	
		11.02- 10.06 CA14981R 14 70		
Partner 1.4 Bifuel	[KFW (TU3JP)]	09.02- CA14981R 14 70	09.02- CS581 12 1.0	
		09.02- CA15891R 14 90		
Partner 1.6	[5FK (EP6C) DTR]	11.10- CA19541R 14 120	11.10- CS1417 12 0.9	
	[TU5JP4]	04.08- CA14991R 14 80	04.08- CS581 12 1.0	
		04.08- CA17411R 14 120	04.08- CS390 12 0.9	
Partner 1.6 Tepee	[5FK (EP6C) DTR]	08.10- CA19541R 14 120	08.10- CS1417 12 0.9	
		04.10- CA19541R 14 120	04.10- CS1417 12 0.9	
		04.10- CA20061R 14 150		
	[5FS (EP6C)]	04.10- CA20871R* 14 80		
	[TU5JP4]	04.08- CA14991R 14 80	04.08- CS581 12 1.0	
		04.08- CA17411R 14 120		
		04.08- CA14991R 14 80	04.08- CS581 12 1.0	
		04.08- CA17411R 14 120		
	Partner 1.6 16V	[TU5JP]	07.01- 08.02 CA16411R 14 80	07.01- 08.02 CS1111 12 0.7
07.01- 08.02 CA16421R 14 97			07.01- 08.02 CS581 12 1.0	
Partner 1.6 HDi	[9HX (DV6ATED4)]	04.08- CA17611R 14 150	04.08- CS1391 12 2.2	
			04.08- CS1260 12 1.1	
			04.08- CS1260 12 1.1	
	[DV6ATED4]	02.06- CA17611R 14 150	02.06- CS1260 12 1.1	
		02.06- CA19201R 14 180		
	[DV6B]	02.06- CA17611R 14 150	02.06- CS1260 12 1.1	
	[DV6BTED4]	04.08- CA17611R 14 150	04.08- CS1391 12 2.2	
			04.08- CS1260 12 1.1	
		04.08- CA17611R 14 150	04.08- CS1391 12 2.2	
04.08- CA19201R 14 180				
04.10- CA20301R 14 180		04.10- CS1329 12 1.5		
Partner 1.6 HDi Tepee	[9HR (DV6C)]	08.10- CA20301R 14 180	08.10- CS1391 12 2.2	
		08.10- CA20331R 14 150	08.10- CS1329 12 1.5	
	[9HX (DV6ATED4)]	04.08- CA17611R 14 150	04.08- CS1391 12 2.2	
			04.08- CS1260 12 1.1	
	[DV6BTED4]	04.08- CA17611R 14 150	04.08- CS1391 12 2.2	
			04.08- CS1260 12 1.1	
	[DV6TED4]	04.08- CA17611R 14 150	04.08- CS1391 12 2.2	
		04.08- CA19201R 14 180		
	Partner 1.8	[LFX (XU7JB)]	05.97- 08.02 CA10521R 14 90	05.97- 08.02 CS715 12 1.4
			05.97- 08.02 CA11511R 14 70	05.97- 08.02 CS566 12 1.1
05.97- 08.02 CA11521R 14 80				
Partner 1.8 Diesel		[A9A (XUD7)]	06.96- 08.02 CA10651R 14 95	06.96- 08.02 CS594 12 1.4
			06.96- 08.02 CA6371R 14 70	06.96- 08.02 CS712 12 2.2
			06.96- 08.02 CA6381R 14 80	
Partner 1.9 Diesel	[DJY (XUD9A)]	PS 06.96- 08.02 CA10431R 14 80		
		PS 06.96- 08.02 CA11551R 14 70		
		AC 06.96- 08.02 CA10981R 14 120		
		06.96- 08.02 CA10651R 14 95	06.96- 08.02 CS712 12 2.2	
		06.96- 08.02 CA6371R 14 70	06.96- 08.02 CS594 12 1.4	
		06.96- 08.02 CA6381R 14 80		
	[WJY (DW8)]	09.00- CA14421R 14 70	09.00- CS1177 12 1.7	
		09.00- CA14961R 14 80	09.00- CS594 12 1.4	
		09.00- CA15641R 14 90		
	[WJY (DW8B)]	06.96- CA14421R 14 70	06.96- CS594 12 1.4	
		06.96- CA14961R 14 80	06.96- CS712 12 2.2	
		06.96- CA15091R 14 150	06.96- CS1177 12 1.7	
	[WJZ (DW8)]	06.96- CA15641R 14 90		
		06.96- 08.02 CA14421R 14 70	06.96- 08.02 CS594 12 1.4	
06.96- 08.02 CA14961R 14 80		06.96- CS712 12 2.2		
[XUD9]	06.96- 08.02 CA15091R 14 150	06.96- 08.02 CS1177 12 1.7		
	06.96- 08.02 CA15641R 14 90			
	05.96- 12.98 CA6371R 14 70	05.96- 12.98 CS373 12 1.7		
	PS 05.96- 12.98 CA10431R 14 80			
	PS 05.96- 12.98 CA11551R 14 70			
	ACPS 05.96- 12.98 CA10981R 14 120			
Partner 1.9 Diesel 4x4	[WJY (DW8B)]	04.04- CA14421R 14 70	04.04- CS594 12 1.4	
		04.04- CA14961R 14 80	04.04- CS1177 12 1.7	
		04.04- CA15641R 14 90	04.04- CS712 12 2.2	
		A13 04.04- CS712 12 2.2		
		04.04- 08.05 CA15641R 14 90	04.04- 08.05 CS712 12 2.2	
		04.04- 08.05 CA14961R 14 80	04.04- 08.05 CS594 12 1.4	
		04.04- 08.05 CA14421R 14 70	04.04- 08.05 CS1177 12 1.7	
Partner 2.0 HDi	[RHY (DW10TD)]	02.00- CA16741R 14 150	12.99- CS712 12 2.2	
		12.02- CA18501R 14 150	12.99- CS594 12 1.4	
		12.99- 11.02 CA15091R 14 150	12.99- CS1177 12 1.7	
		12.99- 11.02 CA15641R 14 90		



Partner 2.0 HDi 4x4	[RHY (DW10TD)]	04.04-	CA1442IR	14 70		04.04-	CS1177	12 1.7
		04.04-	CA1496IR	14 80		A13 04.04-	CS712	12 2.2
		04.04-	CA1564IR	14 90		04.04-	CS1131#	12 2.2
		04.04-	CA1674IR	14 150		04.04-	CS594	12 1.4
		04.04- 08.05	CA1674IR	14 150		04.04- 08.05	CS1131#	12 2.2
		04.04- 08.05	CA1564IR	14 90		04.04- 08.05	CS712	12 2.2
		04.04- 08.05	CA1496IR	14 80		04.04- 08.05	CS594	12 1.4
RCZ 1.6 16V	[5FV (EP6CDT)]	04.04- 08.05	CA1442IR	14 70		04.04- 08.05	CS1177	12 1.7
		03.10-	CA1954IR	14 120		03.10-	CS1417	12 0.9
		03.10-	CA1990IR*	14 120				
		03.10-	CA2006IR	14 150				
		03.10-	CA2087IR*	14 80				
		06.10-	CA1990IR*	14 120		06.10-	CS1417	12 0.9
		06.10-	CA2006IR	14 150				
RCZ 2.0 HDi	[RHH (DW10CTED4)]	06.10-	CA1954IR	14 120				
		06.10-	CA2087IR*	14 80				
<b>PASSENGER CARS US</b>								
404 1.6						01.68- 01.69	CS352	12 0.85
404 1.8						01.70- 01.70	CS352	12 0.85
405 1.9 DL		01.89- 01.91	CA532IR	14 80		01.89- 01.91	CS326	12 0.85
405 1.9 MI16		01.89- 01.91	CA294IR	14 50				
		01.89- 01.91	CA532IR	14 80		01.89- 01.91	CS326	12 0.85
405 1.9 S		01.89- 01.91	CA294IR	14 50				
		01.89- 01.91	CA532IR	14 80		01.89- 01.91	CS326	12 0.85
504 2.0						01.71- 01.78	CS352	12 0.85
504 2.3		01.81- 01.83	CA315IR	14 70				
505 2.0						01.80- 01.85	CS352	12 0.85
505 2.0 GL						01.84- 01.86	CS352	12 0.85
505 2.0 Liberte						01.87- 01.87	CS352	12 0.85
505 2.0 S						01.84- 01.86	CS352	12 0.85
505 2.0 STI						01.84- 01.86	CS352	12 0.85
505 2.2		01.90- 01.90	CA377IR	14 70		01.90- 01.90	CS317	12 1.05
505 2.2 DL		01.88- 01.91	CA377IR	14 70		01.88- 01.91	CS317	12 1.05
505 2.2 GL		01.87- 01.87	CA377IR	14 70		01.87- 01.87	CS317	12 1.05
505 2.2 GLS		01.87- 01.88	CA377IR	14 70		01.87- 01.88	CS317	12 1.05
505 2.2 S		01.89- 01.89	CA377IR	14 70		01.89- 01.89	CS317	12 1.05
505 2.2 STI		01.87- 01.88	CA377IR	14 70		01.87- 01.88	CS317	12 1.05
505 2.2 SW8		01.89- 01.91	CA377IR	14 70		01.89- 01.91	CS317	12 1.05
505 2.3		01.80- 01.83	CA315IR	14 70				
		01.80- 01.83	CA308IR	14 50				
505 2.3 Turbo		01.81- 01.85	CA315IR	14 70				
		01.81- 01.85	CA308IR	14 50				
505 2.3 Turbo GL		01.84- 01.85	CA315IR	14 70		01.84- 01.85	CS314	12 2.0
		01.84- 01.85	CA308IR	14 50				
505 2.3 Turbo S		01.85- 01.85	CA315IR	14 70		01.85- 01.85	CS314	12 2.0
		01.85- 01.85	CA308IR	14 50				
505 2.5 Turbo		01.85- 01.87	CA308IR	14 50		01.85- 01.87	CS314	12 2.0
		01.85- 01.87	CA315IR	14 70				
604 2.3 Turbo		01.82- 01.84	CA308IR	14 50		01.82- 01.84	CS314	12 2.0
		01.82- 01.84	CA315IR	14 70				
<b>PASSENGER CARS AO</b>								
205 1.0	[CDZ (TU9M)]	08.92- 05.97	CA617IR	14 50		08.92- 05.97	CS390	12 0.9
		08.92- 05.97	CA618IR	14 70		08.92- 05.97	CS581	12 1.0
205 1.3	[G1A]	AC 08.92- 05.97	CA715IR	14 80				
		08.90- 07.92	CA369IR	14 50		08.90- 07.92	CS306	12 1.05
205 1.9 Diesel	[XUD9]	08.87- 06.94	CA294IR	14 50		08.87- 04.89	CS342#	12 1.5
		08.87- 06.94	CA380IR	14 70		04.89- 06.94	CS373	12 1.7
206 1.1		PS 08.98- 07.00	CA1442IR	14 70		08.98- 07.00	CS1111	12 0.7
		08.98- 07.00	CA618IR	14 70		08.98- 07.00	CS390	12 0.9
		08.98- 07.00	CA1496IR	14 80				
307 1.4	[TU3JP]	04.02- 09.03	CA1665IR	14 80		04.02- 09.03	CS390	12 0.9
		04.02- 09.03	CA1681IR	14 90		04.02- 09.03	CS1111	12 0.7
		04.02- 09.03	CA1687IR	14 70		04.02- 09.03	CS581	12 1.0
307 1.4 SW	[TU3JP]	04.02- 09.03	CA1665IR	14 80		04.02- 09.03	CS1111	12 0.7
		04.02- 09.03	CA1681IR	14 90		04.02- 09.03	CS581	12 1.0
		04.02- 09.03	CA1687IR	14 70		04.02- 09.03	CS390	12 0.9
309 1.1	[H1B (TU1)]	09.89- 10.93	CA359IR	14 50		09.89- 01.92	CS390	12 0.9
		09.89- 10.93	CA533IR	14 70		01.92- 10.93	CS581	12 1.0
405 1.6 4x4	[BDZ (XU5M)]	04.88- 07.92	CA294IR	14 50		04.88- 07.92	CS326	12 0.85
405 1.8 Diesel 4x4	[A8A (XUD7TE)]	04.88- 07.92	CA380IR	14 70				
		10.87- 07.92	CA294IR	14 50		10.87- 07.92	CS373	12 1.7
405 1.9 4x4	[D6C (XU9J4)]	10.87- 07.92	CA380IR	14 70				
		06.87- 07.92	CA294IR	14 50	MI	06.87- 07.92	CS326	12 0.85
		06.87- 07.92	CA380IR	14 70				
406 1.8		AC 10.96- 03.99	CA1086IR	14 80		10.96- 03.99	CS566	12 1.1
		10.96- 03.99	CA836IR	14 120		10.96- 03.99	CS715	12 1.4
		10.96- 03.99	CA820IR	14 70				
		10.97- 03.99	CA1052IR	14 90				
		10.97- 03.99	CA1156IR	14 120				
		10.97- 03.99	CA1151IR	14 70				
		10.97- 03.99	CA1152IR	14 80				
505 2.8		10.96- 03.99	CA825IR	14 95				
605 3.0		06.86- 08.90	CA377IR	14 70		RHD 06.86- 08.90	CS135	12 1.1
		08.89- 06.94	CA825IR	14 95		08.89- 06.94	CS551	12 1.4
Boxer 2.0	[RFL (XU10J2U)]	08.89- 06.94	CA832IR	14 120				
		12.01-	CA1086IR	14 80		12.01-	CS566	12 1.1
Expert 1.9 Diesel Comfort		AC 12.01-	CA825IR	14 95		12.01-	CS715	12 1.4
		12.03-	CA1098IR	14 120		12.03-	CS1177	12 1.7
		12.03-	CA1155IR	14 70				
Expert 2.0 HDi Comfort		12.03-	CA1043IR	14 80				
		10.00- 11.03	CA1496IR	14 80		10.00- 11.03	CS1177	12 1.7
		01.03- 11.03	CA1761IR	14 150				
Plaggio	<b>PASSENGER CARS EU</b>	AC 10.00- 12.02	CA1509IR	14 150				
		10.00- 12.02	CA1553IR	14 150				
Porter 1.0	[CB41]	02.93- 06.94	CA503IR	14 90		02.94- 05.98	JS901	12 0.8
Porter 1.3 i 16V		02.94- 05.98	JA551IR	14 40				
Plymouth		05.98-	JA880IR	14 45				



**PLYMOUTH Continued**

PASSENGER CARS EU							
Breeze 2.0 16V		12.95-	UA1215	14	90		CS1189 12 1.1
						12.95-	CS990 12 1.1
Breeze 2.4 16V		12.95- 04.01	UA1215	14	90		
Neon 2.0 16V						12.99	CS1189 12 1.1
						05.94- 12.99	CS990 12 1.1
Voyager 2.4 i		01.95- 03.01	UA1215	14	90		
Voyager 3.3 Flex-Fuel	[EGM]	01.98- 03.01	JA1706	14	90 ND	01.98- 03.01	JS942 12 1.2
		01.98- 03.01	JA1707	14	120 ND	01.98- 03.01	CS1501* 12 1.4
		01.98- 03.01	UA1212	14	90 BO		
Voyager 3.3 i						01.95- 03.01	CS1501* 12 1.4
						01.95- 03.01	JS942 12 1.2
Voyager 3.8 i						01.95- 03.01	JS942 12 1.2
						01.95- 03.01	CS1501* 12 1.4
Voyager 3.8 i 4WD						01.95- 03.01	CS1501* 12 1.4
						01.95- 03.01	JS942 12 1.2
PASSENGER CARS US							
Acclaim 2.5		01.92- 01.95	UA960	14	90	01.89- 01.95	CS979# 12 1.4
		01.89- 01.91	UA1212	14	90 BO		
Acclaim 2.5 LE		01.89- 01.91	UA1212	14	90 BO	01.89- 01.91	CS979# 12 1.4
Acclaim 2.5 Turbo		01.89- 01.90	UA1212	14	90 BO	01.89- 01.90	CS979# 12 1.4
Acclaim 2.5 Turbo LE		01.89- 01.91	UA1212	14	90 BO	01.89- 01.91	CS979# 12 1.4
Acclaim 2.5		01.93- 01.94	UA960	14	90	01.93- 01.94	CS979# 12 1.4
Acclaim 3.0						01.90- 01.95	JS762 12 1.4
Acclaim 3.0 LE						01.90- 01.91	JS762 12 1.4
Acclaim 3.0 LX						01.89- 01.91	JS762 12 1.4
Arrow 1.6		01.79- 01.80	JA1501R	14	45	01.79- 01.80	JS350 12 0.7
Arrow 1.6 GS		01.79- 01.79	JA1501R	14	45	01.79- 01.79	JS350 12 0.7
Arrow 1.6 GT		01.79- 01.79	JA1501R	14	45	01.79- 01.79	JS350 12 0.7
Arrow 2.0 Pickup		01.79- 01.82	JA1481R	14	45	01.79- 01.82	JS350 12 0.7
Arrow 2.6		01.80- 01.80	JA1481R	14	45	01.80- 01.80	JS350 12 0.7
Arrow 2.6 GS		01.79- 01.79	JA1481R	14	45	01.79- 01.79	JS350 12 0.7
Arrow 2.6 GT		01.79- 01.79	JA1481R	14	45	01.79- 01.79	JS350 12 0.7
Arrow 2.6 Pickup		01.79- 01.82	JA1481R	14	45	01.79- 01.82	JS350 12 0.7
Breeze 2.0	[ECB]	01.96- 01.98	UA1215	14	90		
		01.99- 01.00	UA1215	14	90		
Breeze 2.4	[EDZ]	01.98- 01.98	UA1215	14	90		
		01.99- 01.00	UA1215	14	90		
Caravelle 2.2		01.85- 01.88	UA1212	14	90 BO	01.87- 01.88	CS979# 12 1.4
Caravelle 2.2 SE		01.85- 01.87	UA1212	14	90 BO		
Caravelle 2.2 Turbo		01.85- 01.88	UA1212	14	90 BO		
Caravelle 2.2 Turbo SE		01.85- 01.88	UA1212	14	90 BO		
Caravelle 2.5		01.86- 01.88	UA1212	14	90 BO	01.86- 01.88	CS979# 12 1.4
Caravelle 2.5 SE		01.86- 01.88	UA1212	14	90 BO	01.86- 01.88	CS979# 12 1.4
Caravelle 2.6						01.85- 01.85	JS339 12 1.0
Caravelle 2.6 SE						01.85- 01.85	JS339 12 1.0
Champ 1.4		01.79- 01.82	JA1501R	14	45	01.79- 01.82	JS350 12 0.7
Champ 1.4 Custom		01.79- 01.79	JA1501R	14	45	01.79- 01.79	JS350 12 0.7
Champ 1.6		01.80- 01.81	JA1501R	14	45	01.80- 01.81	JS350 12 0.7
Champ 1.6 Custom		01.79- 01.82	JA1501R	14	45	01.79- 01.82	JS350 12 0.7
Colt 1.4		01.83- 01.83	JA1501R	14	45	01.83- 01.83	JS350 12 0.7
Colt 1.4 Deluxe		01.83- 01.83	JA1501R	14	45	01.83- 01.83	JS350 12 0.7
Colt 1.4 DL		01.84- 01.84	JA1501R	14	45	01.84- 01.84	JS350 12 0.7
Colt 1.4 E		01.84- 01.84	JA1501R	14	45	01.84- 01.84	JS350 12 0.7
Colt 1.5		01.89- 01.94	JA6891R	14	75	01.89- 01.94	JS350 12 0.7
						01.91- 01.94	JS643 12 0.9
Colt 1.5 100		01.90- 01.90	JA6891R	14	75		
Colt 1.5 100 DL		01.89- 01.91	JA6891R	14	75	01.91- 01.91	JS350 12 0.7
						01.91- 01.91	JS643 12 0.9
Colt 1.5 100 E		01.89- 01.92	JA6891R	14	75	01.91- 01.92	JS350 12 0.7
						01.91- 01.92	JS643 12 0.9
Colt 1.5 100 LX		01.89- 01.90	JA6891R	14	75		
Colt 1.5 200 DL		01.89- 01.90	JA6891R	14	75		
Colt 1.5 200 E		01.89- 01.92	JA6891R	14	75	01.92- 01.92	JS350 12 0.7
						01.92- 01.92	JS643 12 0.9
Colt 1.5 200 GT		01.91- 01.92	JA6891R	14	75	01.91- 01.92	JS643 12 0.9
						01.91- 01.92	JS350 12 0.7
Colt 1.5 200 LX		01.89- 01.89	JA6891R	14	75		
Colt 1.5 DL		01.85- 01.88	JA1591R#	14	65	01.85- 01.90	JS350 12 0.7
		01.88- 01.90	JA6891R	14	75	01.85- 01.85	JS349 12 0.9
Colt 1.5 E		01.85- 01.88	JA1591R#	14	65	01.85- 01.89	JS350 12 0.7
		01.89- 01.89	JA6891R	14	75	01.85- 01.85	JS349 12 0.9
Colt 1.5 GL		01.90- 01.94	JA6891R	14	75	01.90- 01.94	JS350 12 0.7
						01.91- 01.94	JS643 12 0.9
Colt 1.5 GT		01.89- 01.90	JA6891R	14	75	01.89- 01.90	JS350 12 0.7
Colt 1.5 Premier		01.85- 01.88	JA1591R#	14	65	01.85- 01.85	JS349 12 0.9
						01.85- 01.88	JS350 12 0.7
Colt 1.6		01.83- 01.83	JA1501R	14	45	01.83- 01.83	JS350 12 0.7
Colt 1.6 200 LX		01.89- 01.89	JA6711R	14	75		
Colt 1.6 Custom		01.83- 01.83	JA1501R	14	45	01.83- 01.83	JS350 12 0.7
Colt 1.6 Deluxe		01.83- 01.83	JA1501R	14	45	01.83- 01.83	JS350 12 0.7
Colt 1.6 DL		01.84- 01.84	JA1501R	14	45	01.84- 01.84	JS350 12 0.7
Colt 1.6 E		01.84- 01.84	JA1501R	14	45	01.84- 01.84	JS350 12 0.7
Colt 1.6 GT		01.90- 01.90	JA6711R	14	75	01.90- 01.90	JS628 12 1.2
Colt 1.6 Turbo 100		01.90- 01.90	JA6711R	14	75		
Colt 1.6 Turbo 100 DL		01.89- 01.89	JA6711R	14	75		
Colt 1.6 Turbo 100 LX		01.89- 01.90	JA6711R	14	75		
Colt 1.6 Turbo DL		01.84- 01.84	JA1501R	14	45	01.85- 01.85	JS349 12 0.9
		01.85- 01.88	JA1591R#	14	65	01.84- 01.88	JS350 12 0.7
Colt 1.6 Turbo GT		01.89- 01.89	JA6711R	14	75	01.89- 01.89	JS628 12 1.2
Colt 1.6 Turbo GTS						01.88-	JS350 12 0.7
Colt 1.6 Turbo Premier		01.85- 01.88	JA1591R#	14	65	01.85- 01.85	JS349 12 0.9
						01.85- 01.88	JS350 12 0.7
Colt 1.8						01.92- 01.94	JS1003 12 0.9
Colt 1.8 DL						01.89- 01.90	JS350 12 0.7
Colt 1.8 GL						01.93- 01.94	JS1003 12 0.9
Colt 1.8 Vista						01.92- 01.94	JS1003 12 0.9
Colt 1.8 Vista SE						01.92- 01.92	JS1003 12 0.9
Colt 2.0 Vista		01.87- 01.91	JA5981R	14	60	01.87- 01.91	JS628 12 1.2
						01.84- 01.91	JS350 12 0.7
Colt 2.0 Vista Custom						01.86- 01.86	JS350 12 0.7
Colt 2.4		01.93- 01.94	JA11671R	14	75	01.93- 01.94	JS350 12 0.7
Colt 2.4 4x4		01.92- 01.92	JA6711R	14	75	01.92- 01.92	JS350 12 0.7



Colt 2.4 Vista	01.92- 01.92	JA671IR	14 75		01.92- 01.94	JS350	12 0.7
	01.93- 01.94	JA1167IR	14 75				
Colt 2.4 Vista SE	01.92- 01.92	JA671IR	14 75		01.92- 01.94	JS350	12 0.7
	01.93- 01.94	JA1167IR	14 75				
Conquest 2.6 Turbo	01.84- 01.86	JA151IR	14 50		01.84- 01.85	JS350	12 0.7
Cricket 1.5	01.71- 01.73	CA17h	14 34		01.71- 01.73	CS18	12 0.8
Gran Fury 5.2					01.88- 01.89	JS762	12 1.4
Grand Voyager 2.5 SE	01.88- 01.89	UA1212	14 90	BO	01.88- 01.89	CS979#	12 1.4
Grand Voyager 3.0					01.94- 01.95	JS762	12 1.4
Grand Voyager 3.0 LE					01.88- 01.93	JS762	12 1.4
Grand Voyager 3.0 SE					01.89- 01.95	JS762	12 1.4
Grand Voyager 3.3 [EGA]					01.98- 01.98	JS942	12 1.2
					01.97- 01.99	JS942	12 1.2
Grand Voyager 3.3 LE					01.90- 01.95	JS942	12 1.2
Grand Voyager 3.3 SE					01.90- 01.97	JS942	12 1.2
Grand Voyager 3.3 [EGM]					01.98- 01.99	JS942	12 1.2
Grand Voyager 3.8					01.99- 01.99	JS942	12 1.2
Grand Voyager 3.8 LE					01.94- 01.95	JS942	12 1.2
Grand Voyager 3.8 SE					01.95- 01.95	JS942	12 1.2
Horizon 2.2	01.86- 01.90	UA1212	14 90	BO	01.87- 01.90	CS979#	12 1.4
Horizon 2.2 Turismo	01.86- 01.86	UA1212	14 90	BO			
Laser 1.8	01.90- 01.94	JA666IR	14 60		01.90- 01.94	JS350	12 0.7
					01.93- 01.94	JS643	12 0.9
Laser 1.8 RS	01.90- 01.90	JA666IR	14 60		01.90- 01.90	JS350	12 0.7
Laser 2.0 RS	01.90- 01.94	JA684IR	14 90		01.90- 01.94	JS628	12 1.2
	01.90- 01.94	JA671IR	14 75				
Laser 2.0 Turbo RS	01.90- 01.94	JA671IR	14 75		01.90- 01.94	JS628	12 1.2
	01.90- 01.94	JA684IR	14 90				
Neon 2.0					01.95- 01.95	CS990	12 1.1
Neon 2.0 Highline					01.95- 01.95	CS990	12 1.1
Neon 2.0 Sport					01.95- 01.95	CS990	12 1.1
Reliant 2.2	01.85- 01.87	UA1212	14 90	BO			
Reliant 2.2 LE	01.85- 01.89	UA1212	14 90	BO			
Reliant 2.2 SE	01.85- 01.86	UA1212	14 90	BO			
Reliant 2.5	01.86- 01.87	UA1212	14 90	BO	01.86- 01.87	CS979#	12 1.4
Reliant 2.5 LE	01.86- 01.89	UA1212	14 90	BO	01.86- 01.89	CS979#	12 1.4
Reliant 2.5 SE	01.86- 01.86	UA1212	14 90	BO	01.86- 01.86	CS979#	12 1.4
Reliant 2.6					01.81- 01.85	JS339	12 1.0
Reliant 2.6 Custom					01.81- 01.84	JS339	12 1.0
Reliant 2.6 LE					01.85- 01.85	JS339	12 1.0
Reliant 2.6 SE					01.81- 01.85	JS339	12 1.0
Sapporo 1.6					01.78- 01.79	JS350	12 0.7
Sapporo 2.6	01.81- 01.83	JA148IR	14 45		01.78- 01.83	JS350	12 0.7
Sundance 2.2	01.90- 01.94	UA960	14 90		01.87- 01.94	CS979#	12 1.4
	01.87- 01.89	UA1212	14 90	BO			
Sundance 2.2 America	01.91- 01.92	UA960	14 90		01.91- 01.92	CS979#	12 1.4
Sundance 2.2 Turbo	01.87- 01.88	UA1212	14 90	BO	01.87- 01.88	CS979#	12 1.4
Sundance 2.5	01.88- 01.91	UA1212	14 90	BO	01.88- 01.94	CS979#	12 1.4
	01.92- 01.94	UA960	14 90				
Sundance 2.5 America	01.92- 01.92	UA960	14 90		01.92- 01.92	CS979#	12 1.4
Sundance 2.5 Duster	01.92- 01.94	UA960	14 90		01.92- 01.94	CS979#	12 1.4
Sundance 2.5 RS	01.91- 01.91	UA960	14 90		01.91- 01.91	CS979#	12 1.4
Sundance 2.5 Turbo	01.89- 01.90	UA1212	14 90	BO	01.89- 01.90	CS979#	12 1.4
Sundance 2.5 Turbo RS	01.91- 01.91	UA960	14 90		01.91- 01.91	CS979#	12 1.4
Sundance 3.0 Duster					01.92- 01.94	JS762	12 1.4
Sundance 3.0 RS					01.92- 01.92	JS762	12 1.4
Voyager 3.0 LX					01.94- 01.94	JS762	12 1.4
Voyager 3.3					01.98- 01.99	JS942	12 1.2
Voyager 3.3 LX					01.94- 01.94	JS942	12 1.2
Voyager 3.3 SE					01.94- 01.94	JS942	12 1.2
Voyager 3.3 [EGM]					01.98- 01.99	JS942	12 1.2
Voyager 3.8 [EGH]					01.98- 01.98	CS1501*	12 1.4
					01.98- 01.98	JS942	12 1.2
					01.99- 01.99	JS942	12 1.2
					01.99- 01.99	CS1501*	12 1.4
Voyger 2.5	01.88- 01.91	UA1212	14 90	BO	01.88- 01.95	CS979#	12 1.4
	01.92- 01.95	UA960	14 90				
Voyger 2.5 LE	01.90- 01.91	UA960	14 90		01.87- 01.91	CS979#	12 1.4
	01.87- 01.89	UA1212	14 90	BO			
Voyger 2.5 SE	01.90- 01.93	UA960	14 90		01.87- 01.93	CS979#	12 1.4
	01.87- 01.89	UA1212	14 90	BO			
Voyger 2.5 Turbo	01.89- 01.90	UA1212	14 90	BO	01.89- 01.90	CS979#	12 1.4
Voyger 2.5 Turbo LE	01.89- 01.90	UA1212	14 90	BO	01.89- 01.90	CS979#	12 1.4
Voyger 2.5 Turbo SE	01.89- 01.90	UA1212	14 90	BO	01.89- 01.90	CS979#	12 1.4
Voyger 2.6					01.84- 01.87	JS339	12 1.0
Voyger 2.6 LE					01.84- 01.87	JS339	12 1.0
Voyger 2.6 SE					01.84- 01.87	JS339	12 1.0
Voyger 3.0					01.90- 01.95	JS762	12 1.4
Voyger 3.0 LE					01.87- 01.95	JS762	12 1.4
Voyger 3.0 SE					01.87- 01.95	JS762	12 1.4
Voyger 3.3					01.95- 01.97	JS942	12 1.2
Voyger 3.3 LE					01.91- 01.95	JS942	12 1.2
Voyger 3.3 SE					01.91- 01.97	JS942	12 1.2
Voyger 3.3					01.94- 01.95	JS942	12 1.2
<b>Polski-Flat</b>							
<b>PASSENGER CARS EU</b>							
126p 0.6					07.72- 12.91	CS692	12 0.6
<b>Pontiac</b>							
<b>PASSENGER CARS US</b>							
6000 2.5	01.82- 01.86	UA943IR	14 60		01.87- 01.88	US810#	12
	01.87- 01.88	UA938IR	14 100				
6000 2.5 LE	01.82- 01.86	UA943IR	14 60		01.87- 01.91	US810#	12
	01.87- 01.91	UA938IR	14 100				
6000 2.8	01.83- 01.88	UA945IR	14 65				
	01.82- 01.84	UA943IR	14 60				
6000 2.8 LE	01.83- 01.89	UA945IR	14 65				
	01.82- 01.84	UA943IR	14 60				
6000 2.8 SE	01.86- 01.89	UA945IR	14 65				
6000 2.8 STE	01.85- 01.88	UA945IR	14 65				
6000 3.1 LE	01.90- 01.91	UA1109IR	14 105				
6000 3.1 SE	01.90- 01.91	UA1109IR	14 105				
6000 3.1 STE	01.88- 01.89	UA1109IR	14 105				
6000 4.3	01.82- 01.85	UA943IR	14 60				
	01.84- 01.85	UA945IR	14 65				



**PONTIAC** *Continued*

6000 4.3 LE	01.82- 01.85	UA943IR	14	60				
	01.84- 01.85	UA945IR	14	65				
Astre 2.3	01.75- 01.77	UA943IR	14	60				
Astre 2.3 S	01.75- 01.75	UA943IR	14	60				
Astre 2.3 S Safari	01.75- 01.75	UA943IR	14	60				
Astre 2.3 Safari	01.75- 01.77	UA943IR	14	60				
Astre 2.3 SJ	01.75- 01.75	UA943IR	14	60				
Astre 2.3 SJ Safari	01.75- 01.75	UA943IR	14	60				
Astre 2.5	01.77- 01.77	UA943IR	14	60	01.77- 01.77	US818	12	1.5
Astre 2.5 Safari	01.77- 01.77	UA943IR	14	60	01.77- 01.77	US818	12	1.5
Bonneville 3.8	01.80- 01.86	UA943IR	14	60	01.80- 01.86	US818	12	1.5
	01.83- 01.83	UA945IR	14	65	01.87- 01.87	US810#	12	
Bonneville 3.8 Brougham	01.81- 01.86	UA943IR	14	60	01.81- 01.86	US818	12	1.5
	01.83- 01.83	UA945IR	14	65				
Bonneville 3.8 LE	01.84- 01.86	UA943IR	14	60	01.87- 01.91	US810#	12	
	01.88- 01.91	UA964IR	14	100	01.84- 01.86	US818	12	1.5
Bonneville 3.8 SE	01.88- 01.94	UA964IR	14	100	01.88- 01.95	US810#	12	
Bonneville 3.8 SSE	01.88- 01.91	UA964IR	14	100	01.88- 01.91	US810#	12	
Bonneville 3.8 Super SSE	01.92- 01.94	UA964IR	14	100	01.94- 01.94	US810#	12	
Bonneville 3.8 Super SSEI	01.92- 01.93	UA964IR	14	100				
Bonneville 4.1	01.82- 01.82	UA943IR	14	60	01.82- 01.82	US818	12	1.5
Bonneville 4.1 Brougham	01.82- 01.82	UA943IR	14	60	01.82- 01.82	US818	12	1.5
Bonneville 4.3	01.80- 01.81	UA943IR	14	60	01.86- 01.86	US818	12	1.5
Bonneville 4.3 Brougham	01.80- 01.81	UA943IR	14	60	01.86- 01.86	US818	12	1.5
Bonneville 4.3 LE					01.86- 01.86	US818	12	1.5
Bonneville 4.9	01.77- 01.80	UA943IR	14	60	01.77- 01.79	US818	12	1.5
Bonneville 4.9 Brougham	01.77- 01.80	UA943IR	14	60	01.77- 01.79	US818	12	1.5
Bonneville 4.9 Safari	01.79- 01.80	UA943IR	14	60				
Bonneville 5.0	01.81- 01.86	UA943IR	14	60	01.85- 01.86	US818	12	1.5
Bonneville 5.0 Brougham	01.81- 01.86	UA943IR	14	60	01.85- 01.86	US818	12	1.5
Bonneville 5.0 LE	01.84- 01.86	UA943IR	14	60	01.84- 01.86	US818	12	1.5
Bonneville 5.0 Safari	01.81- 01.81	UA943IR	14	60				
Bonneville 5.7	01.77- 01.80	UA943IR	14	60	01.70- 01.79	US818	12	1.5
	01.70- 01.70	UA916#	14	60				
Bonneville 5.7 Brougham	01.77- 01.80	UA943IR	14	60	01.77- 01.80	US818	12	1.5
Bonneville 5.7 Safari	01.79- 01.80	UA943IR	14	60	01.79- 01.80	US818	12	1.5
Bonneville 5.7	01.84- 01.84	UA945IR	14	65				
	01.80- 01.83	UA943IR	14	60				
Bonneville 5.7 Brougham	01.80- 01.83	UA943IR	14	60				
	01.84- 01.84	UA945IR	14	65				
Bonneville 5.7 LE	01.84- 01.84	UA945IR	14	65				
Bonneville 5.7 Safari	01.80- 01.81	UA943IR	14	60				
Bonneville 6.4	01.63- 01.66	UA916#	14	60	01.63- 01.66	US818	12	1.5
Bonneville 6.6	01.73- 01.79	UA943IR	14	60				
	01.68- 01.71	UA916#	14	60				
Bonneville 6.6 Brougham	01.76- 01.79	UA943IR	14	60				
Bonneville 6.6 Safari	01.79- 01.79	UA943IR	14	60				
Bonneville 6.9	01.63- 01.65	UA916#	14	60				
Bonneville 7.0	01.67- 01.69	UA916#	14	60				
Bonneville 7.5	01.70- 01.71	UA916#	14	60				
	01.72- 01.76	UA943IR	14	60				
Bonneville 7.5 Brougham	01.76- 01.76	UA943IR	14	60				
Catalina 3.8	01.77- 01.81	UA943IR	14	60	01.77- 01.81	US818	12	1.5
Catalina 4.3	01.80- 01.81	UA943IR	14	60				
Catalina 4.9	01.77- 01.80	UA943IR	14	60	01.77- 01.79	US818	12	1.5
Catalina 4.9 Safari	01.77- 01.80	UA943IR	14	60	01.77- 01.79	US818	12	1.5
Catalina 5.0	01.81- 01.81	UA943IR	14	60				
Catalina 5.0 Safari	01.81- 01.81	UA943IR	14	60				
Catalina 5.7	01.72- 01.80	UA943IR	14	60	01.70- 01.79	US818	12	1.5
	01.70- 01.71	UA916#	14	60				
Catalina 5.7 Safari	01.72- 01.80	UA943IR	14	60	01.72- 01.80	US818	12	1.5
Catalina 5.7 Ventura	01.70- 01.70	UA916#	14	60	01.70- 01.70	US818	12	1.5
Catalina 5.7	01.80- 01.81	UA943IR	14	60				
Catalina 5.7 Safari	01.80- 01.81	UA943IR	14	60				
Catalina 6.4	01.63- 01.66	UA916#	14	60	01.63- 01.66	US818	12	1.5
Catalina 6.6	01.68- 01.71	UA916#	14	60				
	01.72- 01.78	UA943IR	14	60				
Catalina 6.6 Brougham	01.71- 01.72	UA943IR	14	60				
Catalina 6.6 Safari	01.71- 01.79	UA943IR	14	60				
Catalina 6.6 Ventura	01.68- 01.70	UA916#	14	60				
Catalina 6.9	01.63- 01.66	UA916#	14	60				
Catalina 7.0	01.67- 01.69	UA916#	14	60				
Catalina 7.0 Ventura	01.68- 01.69	UA916#	14	60				
Catalina 7.5	01.72- 01.76	UA943IR	14	60				
	01.70- 01.70	UA916#	14	60				
Catalina 7.5 Brougham	01.72- 01.72	UA943IR	14	60				
Catalina 7.5 Safari	01.71- 01.76	UA943IR	14	60				
Catalina 7.5 Ventura	01.70- 01.70	UA916#	14	60				
Executive 5.7	01.70- 01.70	UA916#	14	60	01.70- 01.70	US818	12	1.5
Executive 5.7 Safari	01.70- 01.70	UA916#	14	60	01.70- 01.70	US818	12	1.5
Executive 6.6	01.67- 01.70	UA916#	14	60				
Executive 6.6 Safari	01.68- 01.70	UA916#	14	60				
Executive 7.0	01.67- 01.69	UA916#	14	60				
Executive 7.0 Safari	01.68- 01.69	UA916#	14	60				
Executive 7.5	01.70- 01.70	UA916#	14	60				
Executive 7.5 Safari	01.70- 01.70	UA916#	14	60				
Fiero 2.5	01.84- 01.88	UA943IR	14	60				
Fiero 2.5 SE	01.84- 01.87	UA943IR	14	60				
Fiero 2.5 Sport	01.84- 01.87	UA943IR	14	60				
Fiero 2.8 GT	01.85- 01.88	UA943IR	14	60				
Fiero 2.8 SE	01.85- 01.87	UA943IR	14	60				
Fiero 2.8 Sport	01.85- 01.85	UA943IR	14	60				
Firebird 2.5	01.82- 01.85	UA943IR	14	60	01.86- 01.86	US810#	12	
Firebird 2.5 S/E	01.82- 01.84	UA943IR	14	60				
Firebird 2.8	01.82- 01.84	UA943IR	14	60	01.85- 01.89	US858	12	
	01.85- 01.89	UA945IR	14	65				
Firebird 2.8 S/E	01.83- 01.86	UA945IR	14	65	01.85- 01.86	US858	12	
	01.82- 01.84	UA943IR	14	60				
Firebird 3.1					01.90- 01.92	US858	12	
Firebird 3.4					01.93- 01.95	US858	12	
Firebird 3.8	01.77- 01.81	UA943IR	14	60	01.67- 01.81	US818	12	1.5
	01.67- 01.67	UA916#	14	60				



Firebird 3.8 Esprit	01.77- 01.81	UA943IR	14 60	01.77- 01.81	US818	12 1.5
Firebird 3.8 Formula	01.81- 01.81	UA943IR	14 60	01.81- 01.81	US818	12 1.5
Firebird 3.8 Turbo Trans Am				01.89- 01.89	US818	12 1.5
Firebird 3.8 Turbo Trans Am GTA SE				01.89- 01.89	US818	12 1.5
Firebird 4.1	01.70- 01.76	UA943IR	14 60	01.68- 01.76	US818	12 1.5
	01.68- 01.69	UA916#	14 60			
Firebird 4.1 Esprit	01.75- 01.76	UA943IR	14 60	01.75- 01.76	US818	12 1.5
Firebird 4.3	01.80- 01.81	UA943IR	14 60			
Firebird 4.3 Esprit	01.80- 01.81	UA943IR	14 60			
Firebird 4.3 Formula	01.81- 01.81	UA943IR	14 60			
Firebird 4.9	01.77- 01.81	UA943IR	14 60	01.77- 01.79	US818	12 1.5
Firebird 4.9 Esprit	01.77- 01.81	UA943IR	14 60	01.77- 01.79	US818	12 1.5
Firebird 4.9 Formula	01.77- 01.81	UA943IR	14 60	01.77- 01.79	US818	12 1.5
Firebird 4.9 Trans Am	01.79- 01.81	UA943IR	14 60			
Firebird 4.9 Turbo Formula	01.80- 01.81	UA943IR	14 60			
Firebird 4.9 Turbo Trans Am	01.80- 01.81	UA943IR	14 60			
Firebird 5.0	01.77- 01.87	UA943IR	14 60	01.85- 01.90	US818	12 1.5
	01.85- 01.87	UA945IR	14 65			
Firebird 5.0 Esprit	01.77- 01.80	UA943IR	14 60			
Firebird 5.0 Formula	01.77- 01.81	UA943IR	14 60			
				01.89- 01.90	US818	12 1.5
Firebird 5.0 S/E	01.82- 01.86	UA943IR	14 60	01.85- 01.86	US818	12 1.5
	01.85- 01.86	UA945IR	14 65			
Firebird 5.0 Trans Am	01.80- 01.87	UA943IR	14 60			
	01.85- 01.87	UA945IR	14 65	01.85- 01.90	US818	12 1.5
Firebird 5.0 Trans Am GTA				01.89- 01.90	US818	12 1.5
Firebird 5.3	01.67- 01.67	UA916#	14 60			
Firebird 5.7	01.72- 01.79	UA943IR	14 60	01.68- 01.88	US818	12 1.5
	01.68- 01.71	UA916#	14 60			
Firebird 5.7 Esprit	01.70- 01.79	UA943IR	14 60	01.70- 01.77	US818	12 1.5
Firebird 5.7 Formula	01.72- 01.79	UA943IR	14 60	01.72- 01.92	US818	12 1.5
Firebird 5.7 Trans Am	01.70- 01.75	UA943IR	14 60	01.70- 01.92	US818	12 1.5
Firebird 5.7 Trans Am GTA				01.89- 01.92	US818	12 1.5
Firebird 6.6	01.74- 01.77	UA943IR	14 60			
	01.67- 01.70	UA916#	14 60			
Firebird 6.6 Esprit	01.70- 01.76	UA943IR	14 60			
Firebird 6.6 Formula	01.70- 01.79	UA943IR	14 60			
Firebird 6.6 Trans Am	01.70- 01.79	UA943IR	14 60			
Firebird 7.5 Esprit	01.71- 01.71	UA943IR	14 60			
Firebird 7.5 Formula	01.71- 01.74	UA943IR	14 60			
Firebird 7.5 Trans Am	01.71- 01.76	UA943IR	14 60			
Firefly 1.0				01.85- 01.86	JS512	12 0.8
Firefly 1.0 FE				01.86- 01.86	JS512	12 0.8
Grand Am 2.3	01.88- 01.88	UA938IR	14 100			
Grand Am 2.3 LE	01.88- 01.91	UA938IR	14 100			
Grand Am 2.3 SE	01.88- 01.95	UA938IR	14 100			
Grand Am 3.0				01.85- 01.87	US810#	12
Grand Am 3.0 LE				01.85- 01.87	US810#	12
Grand Am 3.0 SE				01.86- 01.87	US810#	12
Grand Am 3.3 GT				01.92- 01.93	US810#	12
Grand Am 3.3 SE				01.92- 01.93	US810#	12
Grand Am 3.8	01.79- 01.79	UA943IR	14 60	01.79- 01.79	US818	12 1.5
Grand Am 4.9	01.78- 01.80	UA943IR	14 60	01.78- 01.80	US818	12 1.5
Grand Am 5.0	01.78- 01.80	UA943IR	14 60			
Grand Am 5.7	01.73- 01.75	UA943IR	14 60	01.73- 01.75	US818	12 1.5
Grand Am 6.6	01.73- 01.75	UA943IR	14 60			
Grand Am 7.5	01.73- 01.75	UA943IR	14 60			
Grand Lemans 3.8	01.77- 01.81	UA943IR	14 60	01.77- 01.81	US818	12 1.5
Grand Lemans 3.8 LE	01.81- 01.81	UA943IR	14 60	01.81- 01.81	US818	12 1.5
Grand Lemans 3.8 Safari	01.78- 01.81	UA943IR	14 60	01.78- 01.81	US818	12 1.5
Grand Lemans 4.1	01.75- 01.76	UA943IR	14 60	01.75- 01.76	US818	12 1.5
Grand Lemans 4.3	01.76- 01.81	UA943IR	14 60	01.76- 01.76	US818	12 1.5
Grand Lemans 4.3 Safari	01.80- 01.81	UA943IR	14 60			
Grand Lemans 4.9	01.77- 01.80	UA943IR	14 60	01.77- 01.79	US818	12 1.5
Grand Lemans 4.9 Safari	01.77- 01.81	UA943IR	14 60	01.77- 01.79	US818	12 1.5
Grand Lemans 5.0	01.77- 01.80	UA943IR	14 60	01.77- 01.78	US818	12 1.5
Grand Lemans 5.0 LE	01.81- 01.81	UA943IR	14 60			
Grand Lemans 5.0 SA	01.78- 01.81	UA943IR	14 60			
Grand Lemans 5.0 Safari	01.78- 01.80	UA943IR	14 60			
Grand Lemans 5.7	01.75- 01.77	UA943IR	14 60	01.75- 01.77	US818	12 1.5
Grand Lemans 5.7 LE	01.76- 01.76	UA943IR	14 60			
Grand Lemans 5.7 SA	01.78- 01.78	UA943IR	14 60			
Grand Lemans 5.7 Safari	01.77- 01.79	UA943IR	14 60	01.77- 01.77	US818	12 1.5
Grand Lemans 6.6	01.75- 01.77	UA943IR	14 60			
Grand Lemans 6.6 Safari	01.75- 01.77	UA943IR	14 60			
Grand Lemans 7.5	01.75- 01.76	UA943IR	14 60			
Grand Prix 2.8	01.88- 01.89	UA1113IR	14 100			
Grand Prix 2.8 LE	01.88- 01.89	UA1113IR	14 100			
Grand Prix 2.8 SE	01.88- 01.89	UA1113IR	14 100			
Grand Prix 3.1	01.89- 01.89	UA1113IR	14 100			
Grand Prix 3.1 GT	01.91- 01.93	UA1113IR	14 100			
Grand Prix 3.1 LE	01.89- 01.93	UA1113IR	14 100			
Grand Prix 3.1 SE	01.89- 01.93	UA1113IR	14 100			
Grand Prix 3.1 STE	01.90- 01.93	UA1113IR	14 100			
Grand Prix 3.1 Turbo McLaren	01.90- 01.90	UA1113IR	14 100			
Grand Prix 3.1 Turbo SE	01.89- 01.89	UA1113IR	14 100			
Grand Prix 3.1 Turbo STE	01.90- 01.90	UA1113IR	14 100			
Grand Prix 3.4 LE	01.92- 01.93	UA938IR	14 100			
Grand Prix 3.8	01.78- 01.87	UA943IR	14 60	01.78- 01.87	US818	12 1.5
	01.83- 01.83	UA945IR	14 65			
Grand Prix 3.8 Brougham	01.81- 01.87	UA943IR	14 60	01.81- 01.87	US818	12 1.5
	01.83- 01.83	UA945IR	14 65			
Grand Prix 3.8 LE	01.84- 01.87	UA943IR	14 60	01.84- 01.87	US818	12 1.5
Grand Prix 3.8 LJ	01.79- 01.83	UA943IR	14 60	01.79- 01.83	US818	12 1.5
	01.83- 01.83	UA945IR	14 65			
Grand Prix 3.8 SJ	01.79- 01.79	UA943IR	14 60	01.79- 01.79	US818	12 1.5
Grand Prix 4.1	01.82- 01.82	UA943IR	14 60	01.82- 01.82	US818	12 1.5
Grand Prix 4.1 Brougham	01.82- 01.82	UA943IR	14 60	01.82- 01.82	US818	12 1.5
Grand Prix 4.1 LJ	01.82- 01.82	UA943IR	14 60	01.82- 01.82	US818	12 1.5



**PONTIAC Continued**

Grand Prix 4.3	01.86- 01.87	UA945IR	14 65	01.86- 01.87	US818	12 1.5
	01.80- 01.87	UA943IR	14 60			
Grand Prix 4.3 Brougham	01.81- 01.87	UA943IR	14 60	01.86- 01.87	US818	12 1.5
	01.86- 01.87	UA945IR	14 65			
Grand Prix 4.3 LE	01.86- 01.87	UA943IR	14 60	01.86- 01.87	US818	12 1.5
	01.86- 01.87	UA945IR	14 65			
Grand Prix 4.3 LJ	01.80- 01.81	UA943IR	14 60			
Grand Prix 4.4	01.81- 01.82	UA943IR	14 60			
Grand Prix 4.4 Brougham	01.81- 01.82	UA943IR	14 60			
Grand Prix 4.4 LJ	01.81- 01.82	UA943IR	14 60			
Grand Prix 4.9	01.77- 01.80	UA943IR	14 60	01.77- 01.79	US818	12 1.5
Grand Prix 4.9 LJ	01.77- 01.80	UA943IR	14 60	01.77- 01.79	US818	12 1.5
Grand Prix 4.9 SJ	01.78- 01.80	UA943IR	14 60			
Grand Prix 5.0	01.78- 01.86	UA943IR	14 60	01.85- 01.87	US818	12 1.5
Grand Prix 5.0 Brougham	01.83- 01.86	UA943IR	14 60	01.85- 01.87	US818	12 1.5
Grand Prix 5.0 LE	01.84- 01.87	UA943IR	14 60	01.84- 01.87	US818	12 1.5
Grand Prix 5.0 LJ	01.78- 01.83	UA943IR	14 60			
Grand Prix 5.0 SJ	01.78- 01.80	UA943IR	14 60			
Grand Prix 5.7	01.76- 01.77	UA943IR	14 60	01.76- 01.77	US818	12 1.5
Grand Prix 5.7 LJ	01.77- 01.77	UA943IR	14 60	01.77- 01.77	US818	12 1.5
Grand Prix 5.7	01.83- 01.84	UA945IR	14 65			
	01.81- 01.83	UA943IR	14 60			
Grand Prix 5.7 Brougham	01.81- 01.83	UA943IR	14 60			
	01.83- 01.84	UA945IR	14 65			
Grand Prix 5.7 LE	01.84- 01.84	UA945IR	14 65			
Grand Prix 5.7 LJ	01.81- 01.83	UA943IR	14 60			
	01.83- 01.83	UA945IR	14 65			
Grand Prix 6.4	01.62- 01.66	UA916#	14 60			
Grand Prix 6.6	01.72- 01.77	UA943IR	14 60			
	01.68- 01.71	UA916#	14 60			
Grand Prix 6.6 LJ	01.77- 01.77	UA943IR	14 60			
Grand Prix 6.6 SJ	01.77- 01.77	UA943IR	14 60			
Grand Prix 7.0	01.68- 01.69	UA916#	14 60			
Grand Prix 7.5	01.70- 01.76	UA943IR	14 60			
Grand Safari 4.9	01.77- 01.78	UA943IR	14 60	01.77- 01.78	US818	12 1.5
Grand Safari 5.7	01.77- 01.78	UA943IR	14 60	01.77- 01.78	US818	12 1.5
Grand Safari 6.6	01.71- 01.78	UA943IR	14 60			
Grand Safari 7.5	01.71- 01.76	UA943IR	14 60			
Grandville 6.6	01.71- 01.73	UA943IR	14 60			
Grandville 6.6 Brougham	01.75- 01.75	UA943IR	14 60			
Grandville 7.5	01.71- 01.74	UA943IR	14 60			
Grandville 7.5 Brougham	01.75- 01.75	UA943IR	14 60			
GTO 3.5	01.64- 01.64	UA916#	14 60			
GTO 5.3	01.64- 01.66	UA916#	14 60	01.64- 01.66	US818	12 1.5
GTO 5.7	01.70- 01.70	UA916#	14 60	01.70- 01.70	US818	12 1.5
GTO 6.4	01.64- 01.66	UA916#	14 60	01.64- 01.66	US818	12 1.5
GTO 6.6	01.67- 01.71	UA916#	14 60			
GTO 7.5	01.70- 01.71	UA916#	14 60			
J2000 1.8	01.82- 01.83	UA943IR	14 60			
J2000 1.8 Sunbird	01.84- 01.84	UA945IR	14 65			
J2000 1.8 Sunbird LE	01.84- 01.84	UA945IR	14 65			
J2000 1.8 Turbo Sunbird	01.84- 01.84	UA945IR	14 65			
J2000 1.8 Turbo Sunbird LE	01.84- 01.84	UA945IR	14 65			
J2000 1.8 Turbo Sunbird SE	01.84- 01.84	UA945IR	14 65			
Lemans 1.6				01.88- 01.89	CS535	12 0.9
				01.88- 01.88	CS162	12 0.7
Lemans 1.6 Aerocoupe				01.88- 01.88	CS162	12 0.7
				01.88- 01.88	CS535	12 0.9
Lemans 1.6 LE				01.90- 01.91	CS535	12 0.9
Lemans 1.6 LE Aerocoupe				01.90- 01.91	CS535	12 0.9
Lemans 1.6 SE				01.88- 01.88	CS535	12 0.9
				01.88- 01.88	CS162	12 0.7
Lemans 1.6 Value Leader				01.90- 01.93	CS535	12 0.9
Lemans 1.6 YL Aerocoupe				01.88- 01.89	CS535	12 0.9
				01.88- 01.88	CS162	12 0.7
Lemans 3.5	01.64- 01.65	UA916#	14 60	01.64- 01.65	US818	12 1.5
Lemans 3.8	01.66- 01.67	UA916#	14 60	01.66- 01.81	US818	12 1.5
	01.77- 01.81	UA943IR	14 60			
Lemans 3.8 Safari	01.78- 01.81	UA943IR	14 60	01.78- 01.81	US818	12 1.5
Lemans 3.8 Sport	01.77- 01.77	UA943IR	14 60	01.77- 01.77	US818	12 1.5
Lemans 4.1	01.68- 01.71	UA916#	14 60	01.68- 01.76	US818	12 1.5
	01.72- 01.76	UA943IR	14 60			
Lemans 4.1 Safari	01.69- 01.69	UA916#	14 60	01.69- 01.73	US818	12 1.5
	01.73- 01.73	UA943IR	14 60			
Lemans 4.1 Sport	01.73- 01.76	UA943IR	14 60	01.70- 01.76	US818	12 1.5
	01.70- 01.71	UA916#	14 60			
Lemans 4.1 T37	01.71- 01.71	UA916#	14 60	01.71- 01.71	US818	12 1.5
Lemans 4.3	01.76- 01.81	UA943IR	14 60	01.76- 01.76	US818	12 1.5
Lemans 4.3 Safari	01.80- 01.81	UA943IR	14 60			
Lemans 4.3 Sport	01.76- 01.76	UA943IR	14 60	01.76- 01.76	US818	12 1.5
Lemans 4.9	01.77- 01.80	UA943IR	14 60	01.77- 01.79	US818	12 1.5
Lemans 4.9 Safari	01.77- 01.81	UA943IR	14 60	01.77- 01.79	US818	12 1.5
Lemans 4.9 Sport	01.77- 01.77	UA943IR	14 60	01.77- 01.77	US818	12 1.5
Lemans 5.0	01.77- 01.81	UA943IR	14 60	01.77- 01.78	US818	12 1.5
Lemans 5.0 Safari	01.78- 01.81	UA943IR	14 60			
Lemans 5.0 Sport	01.77- 01.77	UA943IR	14 60	01.77- 01.77	US818	12 1.5
Lemans 5.3	01.63- 01.67	UA916#	14 60	01.63- 01.67	US818	12 1.5
Lemans 5.7	01.72- 01.77	UA943IR	14 60	01.68- 01.77	US818	12 1.5
	01.68- 01.71	UA916#	14 60			
Lemans 5.7 Safari	01.69- 01.69	UA916#	14 60	01.69- 01.77	US818	12 1.5
	01.73- 01.79	UA943IR	14 60			
Lemans 5.7 Sport	01.73- 01.77	UA943IR	14 60	01.70- 01.77	US818	12 1.5
	01.70- 01.71	UA916#	14 60			
Lemans 5.7 T37	01.71- 01.71	UA916#	14 60	01.71- 01.71	US818	12 1.5
Lemans 6.4	01.64- 01.65	UA916#	14 60			
Lemans 6.6	01.72- 01.77	UA943IR	14 60			
	01.68- 01.71	UA916#	14 60			
Lemans 6.6 Safari	01.73- 01.77	UA943IR	14 60			
	01.69- 01.69	UA916#	14 60			
Lemans 6.6 Sport	01.73- 01.77	UA943IR	14 60			
	01.70- 01.71	UA916#	14 60			
Lemans 7.0	01.68- 01.69	UA916#	14 60			
Lemans 7.0 Safari	01.69- 01.69	UA916#	14 60			





Lemans 7.5	01.70- 01.70	<b>UA916#</b>	14 60				
	01.72- 01.76	<b>UA943IR</b>	14 60				
Lemans 7.5 Safari	01.73- 01.76	<b>UA943IR</b>	14 60				
Lemans 7.5 Sport	01.73- 01.76	<b>UA943IR</b>	14 60				
	01.70- 01.70	<b>UA916#</b>	14 60				
Parisienne 3.8	01.83- 01.85	<b>UA943IR</b>	14 60	01.83- 01.85	<b>US818</b>	12 1.5	
	01.84- 01.84	<b>UA945IR</b>	14 65				
Parisienne 3.8 Brougham	01.83- 01.85	<b>UA943IR</b>	14 60	01.83- 01.85	<b>US818</b>	12 1.5	
	01.84- 01.84	<b>UA945IR</b>	14 65				
Parisienne 4.3	01.85- 01.86	<b>UA943IR</b>	14 60	01.85- 01.86	<b>US818</b>	12 1.5	
Parisienne 4.3 Brougham	01.85- 01.86	<b>UA943IR</b>	14 60	01.85- 01.86	<b>US818</b>	12 1.5	
Parisienne 5.0	01.83- 01.86	<b>UA943IR</b>	14 60	01.84- 01.86	<b>US818</b>	12 1.5	
	01.86- 01.86	<b>UA945IR</b>	14 65				
Parisienne 5.0 Brougham	01.83- 01.86	<b>UA943IR</b>	14 60	01.84- 01.86	<b>US818</b>	12 1.5	
	01.86- 01.86	<b>UA945IR</b>	14 65				
Parisienne 5.7	01.84- 01.85	<b>UA945IR</b>	14 65				
	01.83- 01.83	<b>UA943IR</b>	14 60				
Parisienne 5.7 Brougham	01.83- 01.83	<b>UA943IR</b>	14 60				
	01.84- 01.85	<b>UA945IR</b>	14 65				
Phoenix 2.5	01.78- 01.84	<b>UA943IR</b>	14 60	01.80- 01.81	<b>US810#</b>	12	
Phoenix 2.5 LE	01.84- 01.84	<b>UA943IR</b>	14 60	01.84- 01.84	<b>US810#</b>	12	
Phoenix 2.5 LJ	01.78- 01.83	<b>UA943IR</b>	14 60	01.80- 01.81	<b>US810#</b>	12	
Phoenix 2.8	01.80- 01.84	<b>UA943IR</b>	14 60	01.80- 01.84	<b>US810#</b>	12	
	01.84- 01.84	<b>UA945IR</b>	14 65				
Phoenix 2.8 LE	01.84- 01.84	<b>UA943IR</b>	14 60				
	01.84- 01.84	<b>UA945IR</b>	14 65				
Phoenix 2.8 LJ	01.80- 01.83	<b>UA943IR</b>	14 60	01.80- 01.83	<b>US810#</b>	12	
Phoenix 2.8 SE	01.84- 01.84	<b>UA945IR</b>	14 65				
	01.84- 01.84	<b>UA943IR</b>	14 60				
Phoenix 2.8 SJ	01.82- 01.83	<b>UA943IR</b>	14 60				
	01.83- 01.83	<b>UA945IR</b>	14 65				
Phoenix 3.8	01.77- 01.79	<b>UA943IR</b>	14 60	01.77- 01.79	<b>US818</b>	12 1.5	
Phoenix 3.8 LJ	01.78- 01.79	<b>UA943IR</b>	14 60	01.78- 01.79	<b>US818</b>	12 1.5	
Phoenix 5.0	01.77- 01.79	<b>UA943IR</b>	14 60				
Phoenix 5.0 LJ	01.78- 01.79	<b>UA943IR</b>	14 60				
Phoenix 5.7	01.77- 01.79	<b>UA943IR</b>	14 60				
				01.77- 01.77	<b>US818</b>	12 1.5	
Phoenix 5.7 LJ	01.78- 01.79	<b>UA943IR</b>	14 60				
Safari 4.1	01.68- 01.70	<b>UA916#</b>	14 60	01.68- 01.70	<b>US818</b>	12 1.5	
Safari 5.0	01.87- 01.89	<b>UA945IR</b>	14 65				
Safari 5.7	01.68- 01.70	<b>UA916#</b>	14 60	01.68- 01.70	<b>US818</b>	12 1.5	
Safari 6.4	01.63- 01.65	<b>UA916#</b>	14 60				
Safari 6.6	01.70- 01.70	<b>UA916#</b>	14 60				
Safari 6.9	01.63- 01.65	<b>UA916#</b>	14 60				
Star Chief 6.4	01.63- 01.66	<b>UA916#</b>	14 60				
Star Chief 6.9	01.63- 01.66	<b>UA916#</b>	14 60				
Sundbird 1.8	01.85- 01.86	<b>UA945IR</b>	14 65				
Sundbird 1.8 GT	01.86- 01.86	<b>UA945IR</b>	14 65				
Sundbird 1.8 LE	01.85- 01.85	<b>UA945IR</b>	14 65				
Sundbird 1.8 SE	01.86- 01.86	<b>UA945IR</b>	14 65				
Sundbird 1.8 Turbo	01.85- 01.86	<b>UA945IR</b>	14 65				
Sundbird 1.8 Turbo GT	01.86- 01.86	<b>UA945IR</b>	14 65				
Sundbird 1.8 Turbo LE	01.85- 01.85	<b>UA945IR</b>	14 65				
Sundbird 1.8 Turbo SE	01.85- 01.86	<b>UA945IR</b>	14 65				
Sundbird 2.3	01.76- 01.77	<b>UA943IR</b>	14 60				
Sundbird 2.5	01.77- 01.80	<b>UA943IR</b>	14 60	01.77- 01.80	<b>US818</b>	12 1.5	
Sundbird 2.5 Safari	01.78- 01.79	<b>UA943IR</b>	14 60				
Sundbird 3.1 GT	01.91- 01.93	<b>UA1109IR</b>	14 105				
Sundbird 3.1 LE	01.91- 01.94	<b>UA1109IR</b>	14 105				
Sundbird 3.1 SE	01.91- 01.94	<b>UA1109IR</b>	14 105				
Sundbird 3.8	01.76- 01.80	<b>UA943IR</b>	14 60	01.76- 01.80	<b>US818</b>	12 1.5	
Sundbird 3.8 Safari	01.78- 01.79	<b>UA943IR</b>	14 60	01.78- 01.79	<b>US818</b>	12 1.5	
Sundbird 5.0	01.78- 01.79	<b>UA943IR</b>	14 60				
Tempest 3.5	01.64- 01.65	<b>UA916#</b>	14 60	01.64- 01.65	<b>US818</b>	12 1.5	
Tempest 3.8	01.66- 01.67	<b>UA916#</b>	14 60	01.66- 01.67	<b>US818</b>	12 1.5	
Tempest 4.1	01.68- 01.70	<b>UA916#</b>	14 60	01.68- 01.70	<b>US818</b>	12 1.5	
Tempest 4.1 Custom	01.68- 01.69	<b>UA916#</b>	14 60	01.68- 01.69	<b>US818</b>	12 1.5	
Tempest 5.3	01.63- 01.67	<b>UA916#</b>	14 60	01.63- 01.67	<b>US818</b>	12 1.5	
Tempest 5.7	01.68- 01.70	<b>UA916#</b>	14 60	01.68- 01.70	<b>US818</b>	12 1.5	
Tempest 5.7 Custom	01.68- 01.68	<b>UA916#</b>	14 60	01.68- 01.68	<b>US818</b>	12 1.5	
Tempest 6.4	01.63- 01.64	<b>UA916#</b>	14 60				
Tempest 6.6	01.68- 01.70	<b>UA916#</b>	14 60				
Tempest 6.6 Custom	01.68- 01.68	<b>UA916#</b>	14 60				
Tempest 7.0	01.69- 01.69	<b>UA916#</b>	14 60				
Tempest 7.0 Custom	01.69- 01.69	<b>UA916#</b>	14 60				
Trans Sport 3.1	01.90- 01.95	<b>UA1109IR</b>	14 105				
Trans Sport 3.8	01.92- 01.95	<b>UA964IR</b>	14 100	01.92- 01.95	<b>US810#</b>	12	
Ventura 2.5	01.77- 01.77	<b>UA943IR</b>	14 60	01.77- 01.77	<b>US818</b>	12 1.5	
Ventura 3.8	01.77- 01.77	<b>UA943IR</b>	14 60	01.77- 01.77	<b>US818</b>	12 1.5	
Ventura 3.8 SJ	01.77- 01.77	<b>UA943IR</b>	14 60	01.77- 01.77	<b>US818</b>	12 1.5	
Ventura 4.1	01.71- 01.71	<b>UA916#</b>	14 60	01.71- 01.76	<b>US818</b>	12 1.5	
	01.72- 01.76	<b>UA943IR</b>	14 60				
Ventura 4.1 Custom	01.73- 01.75	<b>UA943IR</b>	14 60	01.73- 01.75	<b>US818</b>	12 1.5	
Ventura 4.1 S	01.75- 01.75	<b>UA943IR</b>	14 60				
				01.75- 01.75	<b>US818</b>	12 1.5	
Ventura 4.1 SJ	01.75- 01.76	<b>UA943IR</b>	14 60				
				01.75- 01.76	<b>US818</b>	12 1.5	
Ventura 4.3	01.75- 01.76	<b>UA943IR</b>	14 60	01.75- 01.76	<b>US818</b>	12 1.5	
Ventura 4.3 Custom	01.75- 01.75	<b>UA943IR</b>	14 60	01.75- 01.75	<b>US818</b>	12 1.5	
Ventura 4.3 S	01.75- 01.75	<b>UA943IR</b>	14 60	01.75- 01.75	<b>US818</b>	12 1.5	
Ventura 4.3 SJ	01.75- 01.76	<b>UA943IR</b>	14 60	01.75- 01.76	<b>US818</b>	12 1.5	
Ventura 4.9	01.77- 01.77	<b>UA943IR</b>	14 60	01.77- 01.77	<b>US818</b>	12 1.5	
Ventura 4.9 SJ	01.77- 01.77	<b>UA943IR</b>	14 60	01.77- 01.77	<b>US818</b>	12 1.5	
Ventura 5.0	01.71- 01.71	<b>UA916#</b>	14 60	01.71- 01.72	<b>US818</b>	12 1.5	
	01.72- 01.77	<b>UA943IR</b>	14 60				
Ventura 5.0 SJ	01.77- 01.77	<b>UA943IR</b>	14 60				
Ventura 5.7	01.72- 01.77	<b>UA943IR</b>	14 60				
				01.72- 01.77	<b>US818</b>	12 1.5	
Ventura 5.7 Custom	01.73- 01.75	<b>UA943IR</b>	14 60	01.73- 01.75	<b>US818</b>	12 1.5	
Ventura 5.7 S	01.75- 01.75	<b>UA943IR</b>	14 60	01.75- 01.75	<b>US818</b>	12 1.5	
Ventura 5.7 SJ	01.75- 01.77	<b>UA943IR</b>	14 60	01.75- 01.77	<b>US818</b>	12 1.5	



Porsche							
PASSENGER CARS EU							
911 2.2 Targa	[911.01]					09.69- 08.71	CS117 12 0.7
	[911.02]					09.69- 08.71	CS117 12 0.7
	[911.04]					09.69- 08.71	CS117 12 0.7
911 2.3	[911.52]					09.71- 08.73	CS508 12 1.5
	[911.62]					09.71- 08.73	CS508 12 1.5
911 2.3 S	[911.53]					09.71- 08.73	CS508 12 1.5
	[911.63]					09.71- 08.73	CS508 12 1.5
911 2.3 Targa	[911.52]					09.71- 08.73	CS508 12 1.5
	[911.62]					09.71- 08.73	CS508 12 1.5
911 2.7 Carrera RS	[911.83]					09.72- 08.75	CS508 12 1.5
911 2.7 Carrera RS Targa	[911.83]					09.72- 08.75	CS508 12 1.5
911 2.7 S Carrera	[911.42]					09.73- 08.75	CS508 12 1.5
	[911.47]					09.73- 08.75	CS508 12 1.5
	[911.93]					09.73- 08.75	CS508 12 1.5
	[911.98]					09.73- 08.75	CS508 12 1.5
911 2.7 S Targa	[911.42]					09.73- 08.75	CS508 12 1.5
	[911.47]					09.73- 08.75	CS508 12 1.5
	[911.93]					09.73- 08.75	CS508 12 1.5
	[911.98]					09.73- 08.75	CS508 12 1.5
911 3.0 Carrera					07.77- 07.83	CS508 12 1.5	
911 3.0 SC Carrera	[930.03/13]				07.77- 06.80	CS508 12 1.5	
911 3.0 SC Carrera Targa	[930.03/13]				07.77- 06.80	CS508 12 1.5	
911 3.0 Turbo	[930.52]				01.75- 12.77	CS117 12 0.7	
911 3.1 Carrera	[930.20]					08.84- 07.88	CS508 12 1.5
	[930.25]					08.86- 08.89	CS508 12 1.5
911 3.1 SC Carrera	[930.20]					08.83- 08.89	CS508 12 1.5
	[930.21]					09.83- 07.86	CS508 12 1.5
911 3.2 Carrera	[930.21]					08.83- 08.89	CS508 12 1.5
911 3.3	[930.66]					08.82- 08.89	CS508 12 1.5
911 3.3 Turbo	[930.66]					08.82- 08.89	CS508 12 1.5
	[M30.69]	08.90- 09.93	CA1074IR	14 115		12.90- 08.92	CS888 12 1.7
911 3.3 Turbo S	[930.60]					08.82- 08.89	CS508 12 1.5
	[M30.69S]					12.90- 08.92	CS888 12 1.7
911 3.3 Turbo SC	[930.60]	09.77- 07.82	CA813IR	14 75		10.77- 07.82	CS508 12 1.5
	[930.66]	08.82- 01.83	CA813IR	14 75		08.82- 08.88	CS508 12 1.5
		01.83- 08.88	CA814IR	14 90			
911 3.4	[M96.02]					02.98- 09.01	CS1440 12 1.7
	[M96.04]					02.98- 09.01	CS1440 12 1.7
911 3.4 Carrera	[M96.01]					09.97- 09.01	CS1440 12 1.7
	[M96.04]					09.97- 08.05	CS1440 12 1.7
						05.01- 08.05	CS1440 12 1.7
911 3.4 Carrera 4	[M96.01]					09.97- 09.01	CS1440 12 1.7
	[M96.02]					05.01- 08.05	CS1440 12 1.7
	[M96.04]					09.97- 09.01	CS1440 12 1.7
911 3.6	[M96.03]					10.01- 08.05	CS1440 12 1.7
	[M96.05]					07.04-	CS1440 12 1.7
	[M96.70]					06.00- 08.05	CS888 12 1.7
911 3.6 Carrera	[M64.05]	09.93- 08.95	CA1074IR	14 115		09.93- 08.95	CS888 12 1.7
	[M64.06]	09.93- 08.95	CA1074IR	14 115		09.93- 08.95	CS888 12 1.7
	[M64.07]	09.93- 08.95	CA1074IR	14 115		09.93- 08.95	CS888 12 1.7
	[M64.08]	09.93- 08.95	CA1074IR	14 115		09.93- 08.95	CS888 12 1.7
	[M64.21]	08.95- 09.97	CA1074IR	14 115		08.95- 09.97	CS888 12 1.7
	[M64.22]	08.95- 09.97	CA1074IR	14 115		08.95- 09.97	CS888 12 1.7
	[M64.23]	08.95- 09.97	CA1074IR	14 115		08.95- 09.97	CS888 12 1.7
	[M64.24]	08.95- 09.97	CA1074IR	14 115		08.95- 09.97	CS888 12 1.7
	[M96.05]					04.05-	CS1440 12 1.7
						08.89- 05.94	CS888 12 1.7
911 3.6 Carrera 2	[M64.01]	07.89- 05.94	CA1074IR	14 115		08.89- 05.94	CS888 12 1.7
	[M64.02]	07.89- 05.94	CA1074IR	14 115		08.89- 05.94	CS888 12 1.7
911 3.6 Carrera 4	[M64.01]	12.88- 09.93	CA1074IR	14 115		08.89- 08.93	CS888 12 1.7
	[M64.05]	09.93- 08.95	CA1074IR	14 115		09.93- 08.95	CS888 12 1.7
	[M64.07]	09.93- 08.95	CA1074IR	14 115		09.93- 08.95	CS888 12 1.7
	[M64.21]	08.95- 09.97	CA1074IR	14 115		08.95- 09.97	CS888 12 1.7
	[M64.23]	08.95- 09.97	CA1074IR	14 115		08.95- 09.97	CS888 12 1.7
	[M96.03]					10.01- 08.05	CS1440 12 1.7
	[M96.05]					07.04-	CS1440 12 1.7
911 3.6 Carrera RS	[64.03]	06.91- 09.93	CA1074IR	14 115		08.91- 08.93	CS888 12 1.7
911 3.6 Carrera Targa	[M64.21]	08.95- 09.97	CA1074IR	14 115		08.95- 09.97	CS888 12 1.7
	[M64.22]	08.95- 09.97	CA1074IR	14 115		08.95- 09.97	CS888 12 1.7
	[M64.23]	08.95- 09.97	CA1074IR	14 115		08.95- 09.97	CS888 12 1.7
	[M64.24]	08.95- 09.97	CA1074IR	14 115		08.95- 09.97	CS888 12 1.7
911 3.6 GT 2	[M97.70S]					09.07-	CS888 12 1.7
911 3.6 GT 3	[M97.76]					03.06-	CS888 12 1.7
911 3.6 GT2						04.01- 08.05	CS888 12 1.7
911 3.6 GT2 RS	[M97.70]					05.10-	CS888 12 1.7
911 3.6 GT3	[M96.76]					03.99- 08.05	CS888 12 1.7
						03.03- 08.05	CS888 12 1.7
911 3.6 Targa	[M96.03]					12.01- 08.05	CS1440 12 1.7
911 3.6 M96.05 Carrera 4	[M96.05]					04.05-	CS1440 12 1.7
911 3.6 S Carrera	[M96.03]					06.02- 08.05	CS1440 12 1.7
911 3.6 S Carrera 4	[M96.03]					06.02- 08.05	CS1440 12 1.7
911 3.6 Turbo 4	[M96.70]					10.03- 08.05	CS888 12 1.7
911 3.6 Turbo 4 S						02.03- 08.05	CS888 12 1.7
911 3.6 Turbo	[M64.50]	01.93- 09.93	CA1074IR	14 115		01.93- 09.93	CS888 12 1.7
	[M64.60]	03.95- 09.97	CA1074IR	14 115		09.94- 09.97	CS888 12 1.7
	[M64.60R]	03.95- 09.97	CA1074IR	14 115		03.95- 09.97	CS888 12 1.7
	[M97.70]					03.06-	CS888 12 1.7
911 3.6 Turbo 4S						10.03- 08.05	CS888 12 1.7
911 3.8	[M97.01]					07.04-	CS1440 12 1.7
911 3.8 Carrea RS	[M64.20]	09.94- 09.97	CA1074IR	14 115		09.94- 09.97	CS888 12 1.7
	[M64.21S]	06.95- 09.97	CA1074IR	14 115		06.95- 09.97	CS888 12 1.7
911 3.8 Carrera	[M97.01]					11.06-	CS1440 12 1.7
911 3.8 Carrera 4S	[M97.01]					07.04-	CS1440 12 1.7
911 3.8 Carrera RS	[M64.21S]	09.94- 09.97	CA1074IR	14 115		09.94- 09.97	CS888 12 1.7
911 3.8 Carrera RS 4	[M64.20]	09.94- 09.97	CA1074IR	14 115		09.94- 07.97	CS888 12 1.7
	[M64.21S]					08.95- 09.97	CS888 12 1.7
911 3.8 Carrera S	[M97.01]					04.05-	CS1440 12 1.7
911 3.8 Carrera Targa	[M64.20]	05.96- 09.97	CA1074IR	14 115		09.94- 09.97	CS888 12 1.7
911 3.8 GT3 RS	[M97.77]					08.09-	CS888 12 1.7
911 3.8 GT3	[M97.77]					05.09-	CS888 12 1.7
914 1.7	[W]					AT 01.69- 10.73	CS117 12 0.7
						01.69- 10.73	CS62 12 0.7
914 1.8	[AN]					08.73- 08.74	CS62 12 0.7



914 2.0	[GB]					08.72- 12.75	CS117	12 0.7
924 2.0	[XJ]	11.75- 08.85	CA163IR	14 75		01.76- 08.85	CS83	12 0.8
						A13 01.76- 08.85	CS132	12 1.1
	[XK]	11.75- 08.85	CA163IR	14 75		01.76- 08.85	CS83	12 0.8
						A13 01.76- 08.85	CS132	12 1.1
924 2.0 Carrera GT	[M31.50]					07.80- 06.81	CS578	12 1.4
924 2.0 Turbo	[M31.01]	11.78- 06.80	CA163IR	14 75		02.79- 06.80	CS578	12 1.4
	[M31.03]	06.80- 10.86	CA163IR	14 75		07.80- 06.83	CS578	12 1.4
924 2.5 S	[M44.01]	07.81- 06.84	CA322IR	14 90		07.84- 12.84	CS578	12 1.4
	[M44.03]	07.81- 06.84	CA322IR	14 90		07.84- 12.84	CS578	12 1.4
	[M44.07]	09.85- 07.87	CA322IR	14 90	▲	09.85- 07.87	CS578	12 1.4
	[M44.08]	09.85- 07.87	CA322IR	14 90	▲	09.85- 07.87	CS578	12 1.4
	[M44.09]	08.87- 07.88	CA322IR	14 90	▲	08.87- 07.88	CS578	12 1.4
	[M44.10]	08.87- 07.88	CA322IR	14 90	▲	08.87- 07.88	CS578	12 1.4
944 2.5	[M44.01]	06.81- 06.84	CA322IR	14 90	▲	07.81- 12.84	CS578	12 1.4
	[M44.02]	07.82- 06.84	CA322IR	14 90		07.84- 12.84	CS578	12 1.4
	[M44.03]	06.81- 06.84	CA322IR	14 90	▲	07.81- 12.84	CS578	12 1.4
	[M44.04]	07.82- 06.84	CA322IR	14 90		07.84- 12.84	CS578	12 1.4
	[M44.05]	09.85- 07.87	CA322IR	14 90		01.85- 07.87	CS578	12 1.4
	[M44.06]					01.85- 07.87	CS578	12 1.4
	[M44.07]	09.85- 07.87	CA322IR	14 90		09.85- 07.87	CS578	12 1.4
	[M44.08]	09.85- 07.87	CA322IR	14 90		08.85- 07.87	CS578	12 1.4
	[M44.09]	08.87- 07.88	CA322IR	14 90		08.87- 07.88	CS578	12 1.4
	[M44.10]	08.87- 08.88	CA322IR	14 90		08.87- 07.88	CS578	12 1.4
944 2.5 S	[M44.40]					08.86- 07.88	CS578	12 1.4
944 2.5 Turbo	[M44.50]					08.85- 07.86	CS578	12 1.4
	[M44.51]					08.85- 07.88	CS578	12 1.4
	[M44.52]					09.87- 07.91	CS578	12 1.4
944 2.7	[M44.11]					11.88- 08.89	CS578	12 1.4
	[M44.12]					11.88- 08.89	CS578	12 1.4
959 2.8	[959.50]					05.86- 07.88	CS508	12 1.5
968 3.0	[M44.43]	03.93- 11.95	CA322IR	14 90	▲			
	[M44.44]	06.91- 11.95	CA322IR	14 90	▲			
968 3.0 Turbo S		03.93- 11.95	CA322IR	14 90	▲			
997 3.6 Turbo	[M97.70]					09.07-	CS888	12 1.7
914/6 2.0	[901.36]					12.69- 08.72	CS117	12 0.7
	[901.37]					12.69- 08.72	CS117	12 0.7
Boxster 2.5	[M96.20]					A24 09.96- 08.99	CS1440	12 1.7
Boxster 2.7	[M96.22]					A24 08.99- 07.02	CS1440	12 1.7
	[M96.25]					11.04-	CS1440	12 1.7
	[M97.20]					07.06-	CS1440	12 1.7
Boxster 2.7 24V	[M96.23]					A24 07.02-	CS1440	12 1.7
Boxster 3.2	[M96.21]					A24 08.99- 07.02	CS1440	12 1.7
Boxster 3.2 S	[M96.24]					A24 07.02-	CS1440	12 1.7
						11.04-	CS1440	12 1.7
Boxster 3.4 S	[M97.21]					07.06-	CS1440	12 1.7
Carrera 5.7 GT	[M80.01]					07.03-	CS1440	12 1.7
Cayenne 3.2	[M48.10]	10.03-	CA1749IR	14 150		10.03-	CS1327	12 1.7
Cayenne 3.6						02.07-	CS1327	12 1.7
Cayman 2.7	[M97.20]					07.06-	CS1440	12 1.7
Cayman 3.4 S	[M97.21]					11.05-	CS1440	12 1.7
<b>PASSENGER CARS US</b>								
911 2.0						01.65- 01.68	CS117	12 0.7
911 2.0 E						01.69- 01.69	CS117	12 0.7
911 2.0 L						01.68- 01.68	CS117	12 0.7
911 2.0 S						01.69- 01.69	CS117	12 0.7
911 2.0 T						01.69- 01.69	CS117	12 0.7
911 2.2 E						01.70- 01.71	CS117	12 0.7
911 2.2 S						01.70- 01.71	CS117	12 0.7
911 2.2 T						01.70- 01.71	CS117	12 0.7
911 3.0 SC		01.78- 01.83	CA813IR	14 75				
911 3.2 Carrera		01.84- 01.89	CA814IR	14 90				
911 3.2 Speedster		01.89- 01.89	CA814IR	14 90				
		01.89- 01.89	CA1074IR	14 115				
911 3.2 Turbo		01.84- 01.85	CA814IR	14 90				
911 3.3 Turbo	[930.6]	01.82- 01.82	CA813IR	14 75				
	[930.66]	01.81- 01.85	CA813IR	14 75				
		01.86- 01.89	CA814IR	14 90		01.91- 01.92	CS684	12 1.7
		01.91- 01.92	CA1074IR	14 115				
911 3.6 Carrera		01.90- 01.93	CA1074IR	14 115		01.90- 01.93	CS684	12 1.7
911 3.6 Carrera 2						01.94- 01.98	CS684	12 1.7
911 3.6 Carrera 4		01.89- 01.94	CA1074IR	14 115		01.90- 01.98	CS684	12 1.7
		01.89- 01.89	CA814IR	14 90				
911 3.6 Carrera 4S						01.96- 01.98	CS684	12 1.7
911 3.6 RS America		01.93- 01.93	CA1074IR	14 115		01.93- 01.94	CS684	12 1.7
911 3.6 Speedster						01.94- 01.94	CS684	12 1.7
911 3.6 Taga						01.94- 01.97	CS684	12 1.7
911 3.6 Targa		01.98- 01.98	CA1074IR	14 115				
911 3.6 Turbo						01.94- 01.97	CS684	12 1.7
911 3.6 Turbo Look		01.92- 01.94	CA1074IR	14 115		01.92- 01.94	CS684	12 1.7
912 1.6						01.66- 01.69	CS117	12 0.7
912 2.0 E						01.76- 01.76	CS117	12 0.7
914 1.7						01.70- 01.73	CS117	12 0.7
						01.70- 01.73	CS62	12 0.7
914 1.8						01.74- 01.75	CS62	12 0.7
914 2.0						01.74- 01.76	CS117	12 0.7
914 2.0 6						01.70- 01.71	CS117	12 0.7
924 2.0		01.77- 01.82	CA163IR	14 75		01.77- 01.82	CS132	12 1.1
						01.77- 01.82	CS83	12 0.8
924 2.0 Turbo		01.80- 01.82	CA163IR	14 75				
924 2.5 S		01.87- 01.88	CA322IR	14 90				
928 4.5		01.81- 01.82	CA163IR	14 75				
928 4.7 S		01.83- 01.84	CA163IR	14 75				
930 3.3 Turbo		01.78- 01.79	CA813IR	14 75				
944 2.5		01.83- 01.86	CA322IR	14 90				
<b>PASSENGER CARS AO</b>								
911 3.6 S						08.04- 08.05	CS888	12 1.7
911 3.8 Carrera S	[M97.01S]					08.05-	CS1440	12 1.7
911 3.8 Carrera S S4	[M97.01S]					08.05-	CS1440	12 1.7
Cayenne 3.2 S4		08.03-	CA1749IR	14 150		08.03-	CS1327	12 1.7
<b>Proton</b>								
<b>PASSENGER CARS EU</b>								
Aeroback 1.5						01.91- 11.96	JS349	12 0.9
Jumbuck 1.5	[4G15]					05.02-	JS396#	12 0.7

**PROTON Continued**

Persona 313 1.3 i	[G13B]	03.96-	JA1126IR	14 75	03.96-	JS396#	12 0.7
Persona 315 1.5 GLi / GLSi	[4G15]	03.96-	JA879IR	14 75	12.95- 03.96-	JS350 JS349	12 0.7 12 0.9
Persona 315 1.5 GLSi	[G15B]	09.96-	JA879IR	14 75	09.96-	JS396#	12 0.7
Persona 316 1.6	[4G92]	03.96-	JA879IR	14 75	03.96-	JS349	12 0.9
Persona 316 1.6 GLXi	[4G92]	03.96-	JA879IR	14 75			
Persona 318 1.8 GTi 16V	[4G93]	03.96-	JA1126IR	14 75			
Persona 413 1.3	[4G13]	01.94-	JA1126IR	14 75	01.94-	JS349	12 0.9
Persona 413 1.3 GLSi	[4G13]	01.94-	JA1126IR	14 75	01.94-	JS349	12 0.9
Persona 415 1.5	[4G15]	01.94-	JA879IR	14 75	01.94-	JS349	12 0.9
Persona 416 1.6 GLXi	[4G92]	01.94-	JA879IR	14 75	01.94-	JS396#	12 0.7
		AT 01.94-	JA1126IR	14 75	01.94-	JS1003	12 0.9
Persona 416 1.6 i	[4G92]	12.95- AT 12.95-	JA1126IR JA879IR	14 75 14 75	12.95-	JS349	12 0.9
Persona 418 1.8		05.96-	JA1126IR	14 75			
Persona 418 1.8 GLXi	[4G93]	05.96-	JA1126IR	14 75			
Persona 420 2.0 Diesel	[4D88]	09.96-	JA1133IR	14 75	09.96-	JS344	12 2.0
		09.96-	JA1187IR#	14 65			
Persona 420 2.0 Diesel GLS	[4D88]	05.96-	JA1126IR	14 75	05.96-	JS344	12 2.0
Saloon 1.5					01.91- 11.96	JS349	12 0.9
Satria 1.5	[4G15]				07.00- 07.00-	JS349 JS396#	12 0.9 12 0.7
Wira 1.3					08.00-	JS396#	12 0.7
					08.00-	JS349	12 0.9
Wira 1.5	[4G15]				08.00-	JS396#	12 0.7
					08.00-	JS396#	12 0.7
					08.00-	JS349	12 0.9
<b>Puch (Steyr-Daimler)</b>							
<b>PASSENGER CARS EU</b>							
230 GE 2.3	[M102.981]				04.82- 08.85	CS268	12 1.5
	[M102.987]				09.85- 08.92	CS268	12 1.5
<b>Renault</b>							
<b>PASSENGER CARS EU</b>							
7 1.0					03.75- 12.82	CS95	12 0.6
Alpine 2.5 i Turbo	[Z7U]	01.88- 12.92	CA534IR	14 90	03.85- 12.92	CS280	12 1.1
		01.88- 12.92	CA579IR	14 105			
	[Z7U734]	01.85- 12.92	CA534IR	14 90	01.85- 12.92	CS280	12 1.1
		01.85- 12.92	CA579IR	14 105			
Alpine 2.7 V6	[PRV112730]				01.76- 12.84	CS280	12 1.1
Alpine 2.9	[Z6W]	01.85- 12.92	CA534IR	14 90	01.85- 12.92	CS280	12 1.1
		01.85- 12.92	CA579IR	14 105			
Alpine 3.0 Turbo	[Z7X744]				01.91- 12.95	CS882	12 1.1
Avantime 2.0 Turbo 16V	[F4R760]	09.01- 12.03	CA1661IR	14 125	09.01- 12.03	CS1255	12 0.9
	[F4R761]	09.01- 12.03	CA1661IR	14 125	09.01- 12.03	CS1255	12 0.9
Avantime 2.2 DCi	[G9T712]	12.01- 12.03	CA1661IR	14 125	12.01- 12.03	CS1207	12 2.0
Avantime 3.0 V6	[L7X720]	09.01- 12.03	CA1388IR	14 150	09.01- 12.03	CS1108	12 1.5
					09.01- 12.03	CS1290	12 1.3
	[L7X721]	09.01- 12.03	CA1388IR	14 150	09.01- 12.03	CS1290	12 1.3
					09.01- 12.03	CS1108	12 1.5
Clio 1.1	[C1E700]	06.90- 03.96	CA317IR	14 50	06.90- 03.96	CS310	12 0.9
		06.90- 03.96	CA375IR	14 60			
		06.90- 03.96	CA728IR#	14 70			
	[D7F720]	03.98- 09.99	CA1253IR	14 75	03.98-	CS1057	12 0.7
		10.99- 03.00	CA1637IR	14 70			
	[D7F722]	10.99- 03.00	CA1637IR	14 70	▲	CS1057	12 0.7
Clio 1.1 Hi-Flex	[D4F740]	07.08-	CA1878IR	14 120	07.08-	CS1057	12 0.7
		07.08-	CA2054IR	14 110			
Clio 1.2	[C3G720]	06.94- 02.98	CA549IR	14 60	06.94- 02.98	CS681	12 1.1
		06.94- 02.98	CA632IR	14 90	09.95- 03.96	CS310	12 0.9
		06.94- 02.98	CA649IR	14 70			
		09.95- 03.96	CA317IR	14 50			
		09.95- 03.96	CA375IR	14 60			
	[D4F706]	06.01- 10.03	CA1637IR	14 70	06.01- 10.03	CS1057	12 0.7
		06.01- 10.03	CA1976IR	14 95	06.01- 10.03	CS1385	12 0.85
	[D4F722]	10.03- 10.07	CA1637IR	14 70	10.03- 10.07	CS1057	12 0.7
		10.03- 10.07	CA1976IR	14 95			
	[D7F710]	09.98- 10.99	CA1253IR	14 75	DR	CS1057	12 0.7
		09.98- 04.99	CA1298IR	14 75	VA		
		09.98- 05.05	CA1976IR	14 95			
		10.99- 10.07	CA1637IR	14 70			
	[D7F720]	09.98- 09.99	CA1253IR	14 75	09.98- 10.07	CS1057	12 0.7
		10.99- 10.07	CA1637IR	14 70			
	[D7F722]	03.99- 05.01	CA1253IR	14 75	03.99- 05.01	CS1057	12 0.7
		03.99- 05.01	CA1637IR	14 70			
	[D7F726]	03.99- 10.07	CA1637IR	14 70	03.99- 10.03	CS1385	12 0.85
		03.99- 10.03	CA1976IR	14 95	03.99- 10.07	CS1057	12 0.7
		10.99- 03.00	CA1253IR	14 75			
	[D7F730]	04.96- 09.98	CA1253IR	14 75	DR	CS1057	12 0.7
		04.96- 09.98	CA1302IR	14 75	VA		
	[D7F746]	03.99- 10.03	CA1637IR	14 70	03.99- 10.03	CS1057	12 0.7
		03.99- 10.03	CA1976IR	14 95	03.99- 10.03	CS1385	12 0.85
	[E5F710]	05.90- 03.96	CA549IR	14 60	05.90- 03.96	CS310	12 0.9
	[E7F700]	06.90- 02.98	CA549IR	14 60	06.90- 03.94	CS681	12 1.1
		06.90- 03.94	CA649IR	14 70			
		AC 06.90- 03.94	CA632IR	14 90			
	[E7F706]	06.90- 02.98	CA649IR	14 70	06.90- 02.98	CS681	12 1.1
		01.91- 02.98	CA549IR	14 60			
		AC 06.90- 02.98	CA632IR	14 90			
	[E7F708]	06.90- 02.98	CA549IR	14 60	06.90- 02.98	CS681	12 1.1
		06.90- 02.98	CA649IR	14 70			
		AC 06.90- 02.98	CA632IR	14 90			
	[E7F750]	01.94- 02.98	CA549IR	14 60	01.94- 02.98	CS681	12 1.1
		01.94- 02.98	CA649IR	14 70			
		AC 01.94- 02.98	CA632IR	14 90			
Clio 1.2 16V	[D4F712]	03.00-	CA1637IR	14 70	03.00-	CS1057	12 0.7
		03.00-	CA1976IR	14 95			
	[D4F714]	03.00- 03.04	CA1637IR	14 70	03.00- 03.04	CS1057	12 0.7
		06.01- 03.04	CA1976IR	14 95			
	[D4F740]	06.05-	CA1637IR	14 70	06.05-	CS1385	12 0.85
		06.05-	CA1866IR	14 90	06.05-	CS1057	12 0.7
		06.05-	CA1878IR	14 120			
		06.05-	CA2054IR	14 110			
	[D4F764]	02.08-	CA1866IR	14 90	02.08-	CS1057	12 0.7
		02.08-	CA2054IR	14 110			



	[D4F784]	05.07-05.07-05.07-	CA1866IR CA1878IR CA2054IR	14 90 14 120 14 110	05.07-05.07-	CS1385 CS1057	12 0.85 12 0.7
Clio 1.2 i	[C3G720]	09.95-09.95-09.95-03.96	CA3171R CA3751R CA728IR#	14 50 14 60 14 70	09.95-03.96	CS310	12 0.9
Clio 1.2 16V Hi-Flex	[D4F740]	07.08-07.08-07.08- w/Seat heating 07.08-	CA1866IR CA2054IR CA1878IR	14 90 14 110 14 120	07.08-07.08-	CS1385 CS1057	12 0.85 12 0.7
Clio 1.4	[E7J718]	06.90-06.90-06.90-02.98 PS 06.91-02.98 AC 06.90-02.98	CA5491R CA6491R CA6491R CA6321R	14 60 14 70 14 70 14 90	06.90-02.98	CS681	12 1.1
	[E7J719]	06.90-06.90-06.90-02.98 PS 06.91-02.98 AC 06.90-02.98	CA5491R CA6491R CA6491R CA6321R	14 60 14 70 14 70 14 90	06.90-02.98	CS681	12 1.1
	[E7J754]	06.90-06.90-06.90-02.98 PS 06.91-02.98 AC 06.90-02.98	CA5491R CA6491R CA6491R CA6321R	14 60 14 70 14 70 14 90	06.90-02.98	CS681	12 1.1
	[E7J756]	04.96-04.96-04.96-02.98 AC 04.96-02.98	CA1333IR CA6321R	14 80 14 90	04.96-02.98	CS681	12 1.1
	[E7J757]	04.96-04.96-04.96-02.98 AC 04.96-02.98	CA1333IR CA6321R	14 80 14 90	04.96-02.98	CS681	12 1.1
	[E7J780]	03.98-03.98-03.98-05.05	CA1344IR CA1345IR	14 75 14 110	09.98-05.05	CS1186	12 1.0
Clio 1.4 16V	[K4J700]	08.00-08.00-	CA1470IR CA1484IR	14 98 14 75	08.00-	CS1174	12 0.8
	[K4J712]	10.99-10.99-10.99-10.07 PS 10.99-10.07 AC 10.99-10.07	CA1484IR CA1484IR CA1470IR	14 75 14 75 14 98	10.99-10.07	CS1174 CS1186	12 0.8 12 1.0
	[K4J713]	10.99-10.99-10.99-10.07 PS 10.99-10.07 AC 10.99-10.07	CA1484IR CA1484IR CA1470IR	14 75 14 75 14 98	10.99-10.07	CS1186 CS1174	12 1.0 12 0.8
	[K4J780]	06.05-06.05-06.05-02.10-02.98	CA1860IR CA1887IR CA1887IR	14 120 14 120 14 120	06.05-	CS1425	12 1.1
Clio 1.4 i	[E7J601]	06.90-06.90-06.90-02.98 AC 06.90-02.98	CA5491R CA6491R CA6321R	14 60 14 70 14 90	06.90-02.98	CS681	12 1.1
	[E7J710]	06.90-06.90-06.90-02.98 AC 06.90-02.98	CA5491R CA6491R CA6321R	14 60 14 70 14 90	06.90-02.98	CS681	12 1.1
	[E7J711]	06.90-06.90-06.90-02.98 AC 06.90-02.98	CA5491R CA6491R CA6321R	14 60 14 70 14 90	06.90-02.98	CS681	12 1.1
Clio 1.5 DCi	[K9K700]	06.01-06.01-06.01-06.05-06.05-06.01-06.01-	CA1652IR CA1881IR CA1860IR CA1974IR CA1881IR	14 110 14 120 14 120 14 150 14 120	06.01-	CS1273	12 1.1
	[K9K702]	06.01-06.01-11.03-11.03-11.03-06.01-10.07	CA1652IR CA1881IR CA1762IR CA1933IR CA1948IR	14 110 14 120 14 110 14 125 14 110	06.01-10.07	CS1273	12 1.1
	[K9K704]	06.01-06.01-06.01-10.07	CA1652IR CA1881IR CA1881IR	14 110 14 120 14 120	06.01-10.07	CS1273	12 1.1
	[K9K710]	06.01-06.01-06.01-10.04-10.04-10.04-06.01-10.04-06.01-10.04	CA1652IR CA1762IR CA1881IR CA1933IR CA1948IR	14 110 14 110 14 120 14 125 14 110	06.01-10.04	CS1273	12 1.1
	[K9K712]	Chas. -040609 01.04-10.07 Chas. 040609- 01.04-10.07	CA1823IR CA1762IR	14 150 14 110	01.04-10.07	CS1332	12 1.4
	[K9K718]	02.07-02.07-	CA1881IR CA1948IR	14 120 14 110	02.07-	CS1332	12 1.4
	[K9K750]	08.10-08.10-	CA1860IR CA1974IR	14 120 14 150	08.10-	CS1273	12 1.1
	[K9K752]	05.05-05.05-10.06-10.06	CA1860IR CA1974IR	14 120 14 150	05.05-10.06	CS1273	12 1.1
	[K9K762]	06.05-06.05-	CA1860IR CA1974IR	14 120 14 150	06.05-	CS1332	12 1.4
	[K9K764]	06.05-06.05-	CA1860IR CA1974IR	14 120 14 150	06.05-	CS1332	12 1.4
	[K9K766]	06.05-06.05-	CA1860IR CA1974IR	14 120 14 150	06.05-	CS1332	12 1.4
	[K9K768]	06.05-06.05-	CA1860IR CA1974IR	14 120 14 150	06.05-	CS1332	12 1.4
	[K9K772]	02.08-	CA1974IR	14 150	02.08-	CS1332	12 1.4
Clio 1.5 Diesel	[K9K714]	08.04-08.04-08.04-08.04-08.04-08.04-	CA1652IR CA1762IR CA1823IR CA1860IR CA1933IR CA1948IR	14 110 14 110 14 150 14 120 14 125 14 110	08.04-	CS1332	12 1.4
Clio 1.6	[K7M744]	03.98-03.98-10.99-05.05-05.05-05.05-10.99-05.05-AC 10.99-05.05	CA1344IR CA1345IR CA1484IR CA1470IR	14 75 14 110 14 75 14 98	09.98-05.05 03.98-05.05	CS1186 CS681	12 1.0 12 1.1
	[K7M745]	03.98-03.98-10.99-05.05-05.05-10.99-05.05-AC 10.99-05.05	CA1344IR CA1345IR CA1484IR CA1470IR	14 75 14 110 14 75 14 98	09.98-05.05 03.98-05.05	CS1186 CS681	12 1.0 12 1.1
Clio 1.6 16V	[K4M708]	08.00-08.00-08.00-05.05-05.05-05.05-	CA1470IR CA1484IR CA1771IR	14 98 14 75 14 120	08.00-05.05	CS1174	12 0.8
	[K4M748]	09.98-09.98-09.98-05.05-05.05-05.05-	CA1470IR CA1484IR CA1771IR	14 98 14 75 14 120	09.98-05.05	CS1174	12 0.8



**RENAULT** *Continued*

	[K4M800]	06.05-02.08-AC 06.05-	CA1860IR CA1887IR CA1887IR	14 120 14 120 14 120		06.05-	CS1425	12 1.1
	[K4M801]	06.05-AC 06.05-	CA1860IR CA1887IR	14 120 14 120		06.05-	CS1425	12 1.1
	[K4M804]	06.05-AC 06.05-	CA1860IR CA1887IR	14 120 14 120		06.05-	CS1425	12 1.1
	[K4M862]							
Clio 1.6 16V GT		06.09-	CA2003IR	14 110		11.08-	CS1425	12 1.1
Clio 1.7	[F2N770]	PS 06.90-03.96 ACPS 06.90-03.96 AC 06.90-03.96	CA607IR CA716IR CA634IR	14 70 14 110 14 90		06.90-03.96	CS310	12 0.9
Clio 1.8	[F3P710]	PS 06.90-02.98 ACPS 06.90-01.93 ACPS 01.93-02.98	CA607IR CA716IR CA1060IR	14 70 14 110 14 110		06.90-07.94 06.90-02.98	CS310 CS681	12 0.9 12 1.1
	[F3P714]	PS 06.90-04.96 ACPS 06.90-04.96 ACPS 08.90-04.96	CA607IR CA716IR CA1060IR	14 70 14 110 14 110		06.90-04.96 06.90-04.96	CS310 CS681	12 0.9 12 1.1
	[F3P754]	PS 01.94-02.98 ACPS 01.94-02.98	CA607IR CA1060IR	14 70 14 110		01.94-02.98	CS681	12 1.1
	[F3P755]	PS 01.94-02.98 ACPS 01.94-02.98	CA607IR CA1060IR	14 70 14 110		01.94-02.98	CS681	12 1.1
Clio 1.8 RSi	[F3P758]	PS 01.94-02.98 ACPS 01.94-02.98	CA607IR CA1060IR	14 70 14 110		01.94-02.98	CS681	12 1.1
Clio 1.8 16V	[F7P722]	03.91-03.96	CA605IR	14 70		03.91-03.96 A13 03.91-03.96 08.91-03.96	CS784 CS684 CS310	12 1.4 12 1.7 12 0.9
Clio 1.8 i	[F3P712]	PS 07.92-03.96 ACPS 01.93-03.96	CA607IR CA1060IR	14 70 14 110		07.92-03.96 07.92-03.96	CS310 CS681	12 0.9 12 1.1
Clio 1.9 Diesel	[F8Q630]	03.98-10.07 AC 03.98-10.07	CA1304IR CA1444IR	14 75 14 110		09.98-05.05 03.98-10.07	CS684 CS784	12 1.7 12 1.4
	[F8Q632]	02.00-05.01 AC 02.00-05.01	CA1304IR CA1444IR	14 75 14 110		02.00-05.01	CS784	12 1.4
	[F8Q662]	02.00-05.01 02.00-05.01	CA1304IR CA1444IR	14 75 14 110		02.00-05.01	CS784	12 1.4
	[F8Q676]	05.96-02.98 05.96-02.98	CA1077IR CA1331IR	14 75 14 80		05.96-02.98	CS784	12 1.4
	[F8Q678]	01.97-06.97 06.97-02.98	CA849IR CA1331IR	14 70 14 80		01.97-09.98 01.97-09.98	CS684 CS784	12 1.7 12 1.4
	[F8Q696]	05.96-02.98 05.96-02.98	CA1077IR CA1331IR	14 75 14 80		05.96-02.98	CS784	12 1.4
	[F8Q730]	06.90-04.91 06.90-02.98 PS 06.90-03.96 PS 04.94-02.98	CA635IR CA849IR CA838IR CA1080IR	14 60 14 70 14 90 14 80		06.90-02.98 06.90-03.96	CS684 CS784	12 1.7 12 1.4
	[F8Q732]	06.90-04.91 06.90-02.98 PS 06.90-02.98 PS 04.94-02.98	CA635IR CA849IR CA838IR CA1080IR	14 60 14 70 14 90 14 80		06.90-02.98 06.90-02.98	CS784 CS684	12 1.4 12 1.7
	[F9Q780]	02.00-05.01 02.00-05.01 02.00-05.01	CA1304IR CA1621IR CA1622IR	14 75 14 110 14 120		02.00-05.01	CS684	12 1.7
Clio 1.9 DTi	[F9Q780]	03.99-05.05 03.99-05.05 03.99-05.05	CA1304IR CA1621IR CA1622IR	14 75 14 110 14 120		03.99-05.05	CS684	12 1.7
Clio 2.0 16V	[F4R736]	06.01-AC 06.01-	CA1304IR CA1444IR	14 75 14 110		06.01-	CS1179	12 0.9
	[F7R700]	07.92-03.96	CA605IR	14 70		01.94-03.96 07.92-03.96	CS684 CS784	12 1.7 12 1.4
	[M4R700]					09.06-	CS1418*	12 1.0
	[M4R701]					09.06-	CS1418*	12 1.0
Clio 2.0 16V Sport	[F4R730]	02.00-	CA1444IR	14 110		02.00-	CS1179	12 0.9
	[F4R738]	01.04-10.07 AC 01.04-10.07	CA1304IR CA1444IR	14 75 14 110		01.04-10.07	CS1179	12 0.9
	[F4R830]	02.06-	CA1878IR	14 120		02.06-	CS1255	12 0.9
Clio 3.0 V6 Sport	[L7X760]	11.00-	CA1392IR	14 120		11.00-	CS1290 CS1108	12 1.3 12 1.5
	[L7X762]	12.02-06.05	CA1388IR	14 150		12.02-06.05 12.02-06.05	CS1290 CS1108	12 1.3 12 1.5
Espace 1.9 DCi	[F9Q680]	11.02-11.02-	CA1767IR CA2025IR	14 155 A35 14 155 A35		11.02-	CS1193	12 1.8
	[F9Q820]	11.02-11.02-	CA1767IR CA2025IR	14 155 A35 14 155 A35		11.02-	CS1193	12 1.8
	[F9Q826]	11.02-11.02-	CA1767IR CA2025IR	14 155 A35 14 155 A35		11.02-	CS1193	12 1.8
Espace 1.9 DTi	[F9Q722]	07.00-10.02 10.99-06.00 10.99-06.00 10.99-06.00 AC 07.00-10.02 AC 10.99-06.00	CA1622IR CA1306IR CA1307IR# CA1322IR CA1572IR CA1303IR	14 120 14 75 14 110 14 120 14 120 14 120		10.99-10.02	CS784	12 1.4
Espace 2.0	[F3R728]	11.96-06.97 PS 11.96-06.97 AC 11.96-06.97 AC 11.96-06.97	CA1079IR CA1306IR CA1036IR CA1309IR	14 75 14 75 14 110 14 110		11.96-06.97	CS681	12 1.1
	[F3R729]	11.96-10.97 11.96-10.97 PS 11.96-10.97 AC 11.96-10.97	CA1079IR CA1309IR CA1306IR CA1036IR	14 75 14 110 14 75 14 110		11.96-10.97	CS681	12 1.1
	[F3R742]	02.98-10.02 AC 02.98-10.02	CA1306IR CA1309IR	14 75 14 110		02.98-10.02	CS681	12 1.1
	[F3R768]	10.96-10.02 AC 10.96-10.02	CA1306IR CA1309IR	14 75 14 110		10.96-10.02	CS681	12 1.1
	[F3R769]	10.96-10.02 AC 10.96-10.02	CA1306IR CA1309IR	14 75 14 110		10.96-10.02	CS681	12 1.1
	[F4R700]	09.01-10.02 09.01-10.02 AC 09.01-10.02	CA1621IR CA1622IR CA1628IR	14 110 14 120 14 98		09.01-10.02	CS1179	12 0.9
	[F4R701]	09.01-10.02 09.01-10.02 AC 09.01-10.02	CA1621IR CA1622IR CA1628IR	14 110 14 120 14 98		09.01-10.02	CS1179	12 0.9
	[F4R790]	11.02-11.02-	CA1767IR CA2025IR	14 155 A35 14 155 A35		11.02-	CS1255	12 0.9



	[F4R791]	11.02- 11.02-	CA1767IR CA2025IR	14 155 A35 14 155 A35		11.02-	CS1255	12 0.9
	[F4R796]	04.05- 04.05-	CA1767IR CA2025IR	14 155 A35 14 155 A35		04.05-	CS1255	12 0.9
	[F4R797]	04.05- 04.05-	CA1767IR CA2025IR	14 155 A35 14 155 A35		04.05-	CS1255	12 0.9
	[F4R897]	04.05- 04.05-	CA1767IR CA2025IR	14 155 A35 14 155 A35		04.05-	CS1255	12 0.9
	[J6R234]	07.86- 12.87	CA378IR	14 60		07.84- 12.87	CS317	12 1.05
	[J6R236]	07.86- 09.88 10.88- 12.90 AC 10.88- 12.90	CA378IR CA640IR CA634IR	14 60 14 70 14 90		07.86- 12.90	CS317	12 1.05
	[J6R734]	01.88- 09.88 10.88- 04.91 AC 10.88- 04.91	CA378IR CA640IR CA634IR	14 60 14 70 14 90		01.88- 04.91	CS317	12 1.05
	[J7R768]	04.91- 10.96 AC 04.91- 10.96	CA640IR CA535IR	14 70 14 105		04.91- 10.96	CS317	12 1.05
		11.02- 02.05 11.02- 02.05	CA2025IR CA1767IR	14 155 A35 14 155 A35		11.02- 02.05	CS1255	12 0.9
Espace 2.0 16V	[F4R700]	10.98- 10.02 10.98- 10.02	CA1484IR CA1628IR	14 75 14 98		10.98- 10.02	CS1179	12 0.9
	[F4R701]	07.00- 10.02 07.00- 10.02 AC 07.00- 10.02	CA1621IR CA1622IR CA1628IR	14 110 14 120 14 98		07.00- 10.02	CS1179	12 0.9
Espace 2.0 i	[J7R760]	01.89- 04.91 AC 01.89- 04.91	CA640IR CA634IR	14 70 14 90		01.89- 04.91	CS317	12 1.05
Espace 2.0 i 4x4	[J7R760]	03.88- 04.91 AC 03.88- 04.91	CA640IR CA634IR	14 70 14 90		03.88- 04.91	CS317	12 1.05
Espace 2.0 Turbo	[F4R794]	11.02- 11.02-	CA1767IR CA2025IR	14 155 A35 14 155 A35		11.02-	CS1255	12 0.9
	[F4R795]	11.02- 11.02-	CA1767IR CA2025IR	14 155 A35 14 155 A35		11.02-	CS1255	12 0.9
	[F4R797]	11.02- 11.02-	CA1767IR CA2025IR	14 155 A35 14 155 A35		11.02-	CS1255	12 0.9
	[F4R896]	06.05- 06.05-	CA1767IR CA2025IR	14 155 A35 14 155 A35		06.05-	CS1255	12 0.9
	[F4R897]	06.05- 06.05-	CA1767IR CA2025IR	14 155 A35 14 155 A35		06.05-	CS1255	12 0.9
Espace 2.0 DCi	[M9R740]	01.06-	CA1959IR	14 150		01.06-	CS1415	12 2.2
	[M9R760]	01.06-	CA1959IR	14 150		01.06-	CS1415	12 2.2
Espace 2.1 TD	[J8S240]	10.84- 12.90	CA643IR	14 75		10.84- 12.90	CS353	12 3.1
	[J8S610]	06.92- 08.96 AC 06.92- 08.96	CA526IR CA535IR	14 70 14 105		06.92- 08.96	CS353	12 3.1
	[J8S612]	11.94- 10.96 AC 11.94- 10.96	CA526IR CA535IR	14 70 14 105		11.94- 10.96	CS353	12 3.1
	[J8S772]	01.91- 10.93 AC 01.91- 10.93	CA526IR CA535IR	14 70 14 105		01.91- 10.93	CS353	12 3.1
	[J8S774]	06.89- 12.90	CA643IR	14 75		06.89- 12.90	CS353	12 3.1
	[J8S776]	01.91- 08.96 AC 01.91- 08.96	CA526IR CA535IR	14 70 14 105		01.91- 08.96	CS353	12 3.1
	[J8S778]	06.92- 08.96 AC 06.92- 08.96	CA526IR CA535IR	14 70 14 105		06.92- 08.96	CS353	12 3.1
Espace 2.2	[J7T770]	07.86- 09.88 10.88- 12.90	CA378IR CA640IR	14 60 14 70		07.86- 12.90	CS317	12 1.05
	[J7T772]	01.91- 10.96 AC 01.91- 10.96	CA640IR CA535IR	14 70 14 105		01.91- 10.96 A13 01.91- 10.96	CS317 CS523	12 1.05 12 2.2
	[J7T773]	01.91- 10.96 AC 01.91- 10.96	CA640IR CA535IR	14 70 14 105		01.91- 10.96 A13 01.91- 10.96	CS317 CS523	12 1.05 12 2.2
	[J7T776]	05.93- 10.96 AC 05.93- 10.96	CA640IR CA535IR	14 70 14 105		05.93- 10.96 A13 05.93- 10.96	CS317 CS523	12 1.05 12 2.2
Espace 2.2 4x4	[J7T770]	01.88- 09.88 10.88- 12.90	CA378IR CA640IR	14 60 14 70		01.88- 12.90	CS317	12 1.05
	[J7T772]	03.91- 12.96 AC 03.91- 12.96	CA640IR CA535IR	14 70 14 105		03.91- 12.96	CS523 CS317	12 2.2 12 1.05
	[J7T773]	03.91- 12.96 AC 03.91- 12.96	CA640IR CA535IR	14 70 14 105		03.91- 12.96	CS523 CS317	12 2.2 12 1.05
Espace 2.2 Quadra	[J7T770]	06.87- 12.87 06.87- 12.87 06.87- 12.87	CA378IR CA634IR CA640IR	14 60 14 90 14 70		06.87- 12.87	CS317	12 1.05
Espace 2.2 DCi	[G9T642]	10.00- 10.00-	CA1627IR CA1661IR	14 125 14 125		10.00- 10.00-	CS1055 CS1207	12 2.2 12 2.0
	[G9T645]					02.06-	CS1288	12 2.4
	[G9T710]	07.00- 10.02	CA1661IR CA1627IR	14 125 14 125		07.00- 10.02	CS1207 CS1055	12 2.0 12 2.2
	[G9T742]	11.02- 11.02-	CA1767IR CA2025IR	14 155 A35 14 155 A35		11.02-	CS1288	12 2.4
	[G9T743]	11.02- 11.02-	CA1767IR CA2025IR	14 155 A35 14 155 A35		11.02-	CS1288	12 2.4
Espace 2.2 Diesel	[G8T716]	11.97- 01.00 11.97- 01.00 11.97- 01.00 AC 11.97- 01.00	CA1036IR CA1308IR CA896IR CA1309IR	14 110 14 80 14 75 14 110		11.97- 01.00 11.97- 01.00	CS1055 CS1207	12 2.2 12 2.0
Espace 2.2 TD	[G8T714]	11.96- 10.02 11.96- 10.02 11.96- 10.02 11.96- 10.02 11.96- 10.02	CA1036IR CA1308IR CA1309IR CA896IR	14 110 14 80 14 110 14 75		11.96- 10.02	CS1055	12 2.2
	[G8T716]	11.96- 10.02 11.96- 10.02 11.96- 10.02 11.96- 10.02 11.96- 10.02	CA1036IR CA1308IR CA1309IR CA896IR	14 110 14 80 14 110 14 75		11.96- 10.02	CS1055	12 2.2
Espace 2.8 V6	[Z7W712]	01.91- 10.96 AC 01.91- 10.96	CA534IR CA579IR	14 90 14 105		01.91- 10.96	CS280	12 1.1
	[Z7W713]	01.91- 10.96 AC 01.91- 10.96	CA534IR CA579IR	14 90 14 105		01.91- 10.96	CS280	12 1.1
	[Z7W717]					04.94- 10.96 04.94- 10.96	CS280 CS882	12 1.1 12 1.1
Espace 3.0	[Z7X775]	AC 11.96- 10.02	CA1040IR	14 110		11.96- 10.02	CS882	12 1.1
Espace 3.0 V6 24V	[L7X727]	10.98- 10.02	CA1392IR	14 120		10.98- 10.02	CS1108	12 1.5
Estafette 1.3	[810-01]					10.75- 12.81	CS95	12 0.6
Fluence 1.5 DCi	[K9K830]	02.10-	CA1974IR	14 150		02.10-	CS1332	12 1.4
	[K9K832]	06.05- 06.05-	CA1974IR CA2086IR*	14 150 14 210		06.05- 06.05-	CS1332 CS1332	12 1.4 12 1.4
	[K9K834]	02.10-	CA1974IR	14 150		02.10-	CS1332	12 1.4



**RENAULT** *Continued*

	[K9K836]	02.10- 02.10-	CA1974IR CA2086IR*	14 150 14 210		02.10-	CS1332	12 1.4
Fluence 1.6 16V	[K4M838]	02.10- 02.10-	CA1860IR CA1887IR	14 120 14 120				
Fuego 1.4	[847720]	02.80- 10.85	CA170IR	14 55		02.80- 10.85	CS321	12 0.9
Fuego 1.6	[843723]	10.80- 10.85	CA170IR	14 55		10.80- 10.85	CS316	12 1.05
	[843724]	10.80- 10.85	CA170IR	14 55		10.80- 10.85	CS316	12 1.05
	[A2M723]	10.82- 10.85	CA170IR CA375IR	14 55 14 60		10.82- 10.85	CS316	12 1.05
	[A6M725]	10.80- 10.85	CA170IR	14 55		10.80- 10.85	CS316	12 1.05
	[A6M726]	10.80- 10.85	CA170IR	14 55		10.80- 10.85	CS316	12 1.05
Fuego 1.6 Turbo	[A5L750]					08.83- 10.85	CS316	12 1.05
Fuego 2.0	[829710]					10.80- 10.85	CS317 CS523	12 1.05 12 2.2
	[J6R710]					10.80- 10.85	CS317	12 1.05
	[J6R712]					10.80- 10.85	CS317 CS523	12 1.05 12 2.2
	[J6R713]					10.80- 10.85	CS317	12 1.05
	[J6R715]					10.80- 10.85	CS317 CS523	12 1.05 12 2.2
	[J6R726]					10.80- 10.85	CS317	12 1.05
Fuego 2.1 TD	[J8S712]	08.82- 10.85	CA268IR	14 50		08.82- 10.85	CS338 CS353	12 2.5 12 3.1
Grand Scénic 1.5 DCi	[K9K728]	04.04- 04.04- 08.07-	CA1762IR CA1823IR CA1876IR	14 110 14 150 14 150		04.04-	CS1332	12 1.4
	[K9K729]	04.04- 04.04-	CA1762IR CA1823IR	14 110 14 150		04.04-	CS1332	12 1.4
	[K9K830]	04.09-	CA1974IR	14 150		04.09-	CS1332	12 1.4
	[K9K832]	02.09- 02.09- 02.09-	CA1762IR CA1823IR CA2086IR*	14 110 14 150 14 210		02.09-	CS1332	12 1.4
	[K9K836]	04.09- 04.09-	CA1974IR CA2086IR*	14 150 14 210		04.09-	CS1332	12 1.4
	[K9K846]	11.10- 11.10-	CA1974IR CA2086IR*	14 150 14 210				
Grand Scénic 1.6	[K4M761]	04.04- 04.04- 04.04- 04.04-	CA1762IR CA1823IR CA1944IR CA2043IR	14 110 14 150 14 150 14 110		04.04-	CS1276	12 0.85
	[K4M782]	04.04- 04.04- 04.04- 04.04-	CA1762IR CA1823IR CA1944IR CA2043IR	14 110 14 150 14 150 14 110		04.04-	CS1276	12 0.85
	[K4M788]	06.06- 06.06- 06.06-	CA1762IR CA1823IR CA2043IR	14 110 14 150 14 110		06.06-	CS1276	12 0.85
Grand Scénic 1.6 16V	[K4M9766]	02.09-	CA1887IR	14 120				
Grand Scénic 1.6 Flexfuel	[K4M866]	02.09-	CA1887IR	14 120				
Grand Scénic 1.9 DCi	[F9Q804]	05.05-	CA1823IR	14 150		05.05-	CS1193	12 1.8
	[F9Q812]	04.04- 04.04- 04.04- 04.04-	CA1767IR CA1768IR CA1814IR CA1918IR CA2025IR	14 155 A35 14 110 14 125 14 150 14 155 A35		04.04-	CS1193	12 1.8
	[F9Q814]	05.05- 05.05- 05.05- 05.05-	CA1767IR CA1768IR CA1814IR CA2025IR	14 155 A35 14 110 14 125 14 155 A35		05.05-	CS1193	12 1.8
	[F9Q870]	02.09- 02.09-	CA1918IR CA2101IR*	14 150 14 120		02.09-	CS1509*	12 1.4
Grand Scénic 2.0	[F4R770]	04.04- 04.04- 04.04-	CA1768IR CA1814IR CA2058IR*	14 110 14 125 14 120		04.04-	CS1255	12 0.9
	[F4R771]	04.04- 04.04- 04.04-	CA1768IR CA1814IR CA2058IR*	14 110 14 125 14 120		04.04-	CS1255	12 0.9
	[F4R776]	04.04- 04.04- 04.04-	CA1768IR CA1814IR CA2058IR*	14 110 14 125 14 120		04.04-	CS1255	12 0.9
Grand Scénic 2.0 16V	[M4RF713]					02.09-	CS1418*	12 1.0
Grand Scénic 2.0 DCi	[M9R610]	04.09-	CA1971IR	14 210		04.09-	CS1415	12 2.2
	[M9R615]	02.09-	CA1971IR	14 210		02.09-	CS1415	12 2.2
	[M9R700]	09.05- 09.05-	CA1936IR CA1945IR	14 150 14 120		09.05-	CS1415	12 2.2
Kangoo 1.2	[D7F710]	10.97- 04.98 03.98-	CA1253IR CA1976IR	14 75 14 95		10.97- 04.98	CS1057	12 0.7
	[D7F720]	03.98- 09.99 10.99-	CA1253IR CA1637IR	14 75 14 70		03.98-	CS1057	12 0.7
	[D7F722]	03.98-	CA1637IR	14 70		03.98-	CS1057	12 0.7
	[D7F726]	04.00- 09.98- 03.00	CA1637IR CA1253IR	14 70 14 75		09.98-	CS1057	12 0.7
	[D7F744]	05.00-	CA1637IR	14 70		05.00-	CS1057	12 0.7
	[D7F746]	05.00-	CA1637IR	14 70		05.00-	CS1057	12 0.7
Kangoo 1.2 Express	[D7F710]	10.97- 04.98 03.98- 04.98 03.98-	CA1253IR CA1298IR CA1976IR	14 75 14 75 14 95	DR VA	10.97- 04.98	CS1057	12 0.7
	[D7F720]	03.98- 09.99 10.99-	CA1253IR CA1637IR	14 75 14 70		03.98-	CS1057	12 0.7
	[D7F722]	03.98-	CA1637IR	14 70		03.98-	CS1057	12 0.7
	[D7F726]	04.00- 09.98- 03.00	CA1637IR CA1253IR	14 70 14 75		09.98-	CS1057	12 0.7
	[D7F744]	05.00- 05.00-	CA1253IR CA1637IR	14 75 14 70	DR	05.00-	CS1057	12 0.7
	[D7F746]	05.00- 05.00-	CA1253IR CA1637IR	14 75 14 70	DR	05.00-	CS1057	12 0.7
	[D7F764]	07.98- 07.01 07.98- 07.01 07.98- 07.01	CA1253IR CA1298IR CA1976IR	14 75 14 75 14 95		07.98- 07.01	CS1057	12 0.7
Kangoo 1.2 16V	[D4F712]	05.00- 06.01-	CA1637IR CA1976IR	14 70 14 95		05.00-	CS1057	12 0.7





	[D4F714]	05.00- AC 05.00-	CA1637IR CA1976IR	14 70 14 95		05.00-	CS1057	12 0.7
	[D4F716]	09.01- AC 09.01-	CA1637IR CA1976IR	14 70 14 95		09.01-	CS1057	12 0.7
Kangoo 1.2 16V Express	[D4F712]	05.00- AC 10.01-	CA1637IR CA1976IR	14 70 14 95		05.00-	CS1057	12 0.7
	[D4F714]	05.00- AC 10.01-	CA1637IR CA1976IR	14 70 14 95		05.00-	CS1057	12 0.7
Kangoo 1.4	[E7J634]	09.98- AC 09.98-	CA1484IR CA1544IR	14 75 14 85		09.98- 09.98-	CS1186 CS681	12 1.0 12 1.1
	[E7J635]	09.98- AC 09.98-	CA1484IR CA1544IR	14 75 14 85		09.98- 09.98-	CS681	12 1.1
	[E7J780]	10.97- AC 10.97-	CA1344IR CA1345IR	14 75 14 110		10.97- 10.97-	CS681 CS1186	12 1.1 12 1.0
	[K7J700]	06.00- AC 06.00-	CA1484IR CA1544IR	14 75 14 85		06.00- 06.00-	CS1186 CS681	12 1.0 12 1.1
	[K7J701]	06.00- AC 06.00-	CA1484IR CA1544IR	14 75 14 85		06.00- 06.00-	CS681 CS1186	12 1.1 12 1.0
Kangoo 1.4 Express	[E7J634]	09.98- AC 09.98- AC 09.98-	CA1484IR CA1345IR CA1544IR	14 75 14 110 14 85		09.98-	CS1186	12 1.0
	[E7J635]	09.98- AC 03.98- AC 09.98-	CA1484IR CA1345IR CA1544IR	14 75 14 110 14 85		03.98-	CS1186	12 1.0
	[E7J780]	10.97- AC 10.97-	CA1344IR CA1345IR	14 75 14 110		10.97-	CS681	12 1.1
	[K7J701]	06.00- 06.00- AC 06.00- AC 06.00-	CA1484IR CA1628IR CA1345IR CA1544IR	14 75 14 98 14 110 14 85		06.00-	CS1186	12 1.0
Kangoo 1.5 DCi	[K9K700]	05.00- 05.00-	CA1652IR CA1881IR	14 110 14 120		05.00-	CS1273	12 1.1
	[K9K702]	02.01- 02.01- AC 02.01-	CA1652IR CA1881IR CA1933IR	14 110 14 120 14 125		02.01-	CS1273	12 1.1
	[K9K704]	05.00- 05.00- 07.03- AC 07.03-	CA1652IR CA1881IR CA1762IR CA1933IR	14 110 14 120 14 110 14 125		07.03- 05.00-	CS1332 CS1273	12 1.4 12 1.1
	[K9K710]	02.01- 02.01- AC 02.01-	CA1652IR CA1881IR CA1933IR	14 110 14 120 14 125		02.01-	CS1273	12 1.1
	[K9K714]	06.05- AC 06.05- AC 06.05-	CA1652IR CA1933IR CA1948IR	14 110 14 125 14 110		06.05-	CS1332	12 1.4
	[K9K718]	06.05- AC 06.05- AC 06.05-	CA1652IR CA1933IR CA1948IR	14 110 14 125 14 110		06.05-	CS1332	12 1.4
	[K9K800]	06.09-	CA1974IR	14 150		06.09-	CS1332	12 1.4
	[K9K802]	02.08-	CA1974IR	14 150		02.08-	CS1332	12 1.4
	[K9K804]	02.08-	CA1974IR	14 150		02.08-	CS1332	12 1.4
	[K9K812]	06.09-	CA1974IR	14 150		06.09-	CS1332	12 1.4
	[K9K840]	02.08-	CA1974IR	14 150		02.08-	CS1332	12 1.4
Kangoo 1.5 DCi Be Bop	[K9K]	02.09-	CA1974IR	14 150		02.09-	CS1332	12 1.4
	[K9K800]	06.09-	CA1974IR	14 150		06.09-	CS1332	12 1.4
Kangoo 1.5 DCi Express	[K9K700]	05.00- 05.00-	CA1652IR CA1881IR	14 110 14 120		05.00-	CS1273	12 1.1
	[K9K702]	02.01- 02.01-	CA1652IR CA1881IR	14 110 14 120		02.01-	CS1273	12 1.1
	[K9K704]	05.00- 05.00-	CA1652IR CA1881IR	14 110 14 120		05.00-	CS1273	12 1.1
	[K9K710]	02.01- 02.01- AC 02.01-	CA1652IR CA1881IR CA1933IR	14 110 14 120 14 125		02.01-	CS1273	12 1.1
	[K9K714]	06.05- AC 06.05- AC 06.05-	CA1652IR CA1933IR CA1948IR	14 110 14 125 14 110		06.05-	CS1332	12 1.4
	[K9K716]	10.05- 10.05- 10.05-	CA1652IR CA1762IR CA1933IR	14 110 14 110 14 125		10.05-	CS1332	12 1.4
	[K9K718]	06.05- AC 06.05- AC 06.05-	CA1881IR CA1933IR CA1948IR	14 120 14 125 14 110		06.05-	CS1332	12 1.4
	[K9K800]	02.08-	CA1974IR	14 150		02.08-	CS1332	12 1.4
	[K9K802]	02.08-	CA1974IR	14 150		02.08-	CS1332	12 1.4
	[K9K806]	02.08-	CA1974IR	14 150		02.08-	CS1332	12 1.4
	[K9K840]	02.08-	CA1974IR	14 150		02.08-	CS1332	12 1.4
Kangoo 1.6	[K7M750]					02.08-	CS1442	12 0.8
Kangoo 1.6 Be Bop	[K4M]	02.09- 02.09-	CA1975IR CA2003IR	14 110 14 110		02.09-	CS1276	12 0.85
Kangoo 1.6 Express	[K7M750]					02.08-	CS1442	12 0.8
Kangoo 1.6 16V	[K4M750]	06.01- 09.01-	CA1470IR CA1484IR	14 98 14 75		09.01-	CS1174	12 0.8
	[K4M752]	06.01- 09.01-	CA1470IR CA1484IR	14 98 14 75		09.01-	CS1174	12 0.8
	[K4M753]	06.01- 09.01-	CA1470IR CA1484IR	14 98 14 75		09.01-	CS1174	12 0.8
	[K4M830]	02.08- 02.08-	CA1975IR CA2003IR	14 110 14 110		02.08-	CS1276	12 0.85
Kangoo 1.6 16V 4x4	[K4M750]	PS 09.01- AC 09.01-	CA1484IR CA1470IR	14 75 14 98		09.01-	CS1174	12 0.8
	[K4M752]	PS 06.00- AC 06.00-	CA1484IR CA1470IR	14 75 14 98		06.00-	CS1174	12 0.8
	[K4M753]	PS 09.01- AC 09.01-	CA1484IR CA1470IR	14 75 14 98		09.01-	CS1174	12 0.8
Kangoo 1.6 16V Express	[K4M752]	04.01- AC 04.01-	CA1484IR CA1470IR	14 75 14 98		04.01-	CS1174	12 0.8
	[K4M830]	02.08- 02.08-	CA1975IR CA2003IR	14 110 14 110		02.08-	CS1276	12 0.85
Kangoo 1.6 16V Express 4x4	[K4M750]	PS 06.00- AC 06.00-	CA1484IR CA1470IR	14 75 14 98		06.00- 10.01-	CS1174 CS1276	12 0.8 12 0.85
	[K4M752]	PS 06.00- AC 06.00-	CA1484IR CA1470IR	14 75 14 98		06.00-	CS1174	12 0.8



**RENAULT** *Continued*

	[K4M753]	PS 09.01- AC 09.01-	CA1484IR CA1470IR	14 75 14 98		09.01-	CS1174	12 0.8
Kangoo 1.6 16V Express LPG	[K4M834]	02.08- 02.08-	CA1975IR CA2003IR	14 110 14 110		02.08-	CS1276	12 0.85
Kangoo 1.6 16V Bivalent Express	[K7M746]	06.05- 06.05-	CA1544IR CA1628IR	14 85 14 98		06.05-	CS1186	12 1.0
Kangoo 1.6 16V Hi-Flex Hi-Flex	[K4M830]	02.08- 02.08-	CA1975IR CA2003IR	14 110 14 110		02.08-	CS1276	12 0.85
Kangoo 1.9 DCi 4x4	[F9Q782] [F9Q790]	AC 05.00- 05.00-	CA1622IR CA1622IR	14 120 14 120		05.00- 05.00- 10.03-	CS1252 CS1252 CS1344	12 1.4 12 1.4 12 1.2
Kangoo 1.9 DCi Express	[F9Q790]	07.03-	CA1622IR	14 120		07.03-	CS684	12 1.7
Kangoo 1.9 DCi Express 4x4	[F9Q] [F9Q782] [F9Q790]	07.03- 07.03- 10.01- 10.01- 10.01- 10.01-	CA1304IR CA1622IR CA1304IR CA1622IR CA1304IR CA1622IR	14 75 14 120 14 75 14 120 14 75 14 120		07.03- 10.01- 10.01- 10.01- 10.01-	CS1252 CS1344 CS1252 CS1344	12 1.4 12 1.4 12 1.4 12 1.2 12 1.4 12 1.2
Kangoo 1.9 Diesel	[F8Q630] [F8Q632] [F8Q662]	10.97- 10.97- 10.97- AC 10.97- 01.98- AC 01.98- 10.97- 10.97- 10.97- AC 10.97-	CA1304IR CA1621IR CA1622IR CA1444IR CA1304IR CA1444IR CA1304IR CA1621IR CA1622IR CA1444IR	14 75 14 110 14 120 14 110 14 75 14 110 14 75 14 110 14 120 14 110		10.97- 10.97- 10.97- 10.97- 01.98- 01.98- 10.97- 10.97- 10.97- 10.97-	CS784 CS684 CS784 CS784 CS684 CS784	12 1.4 12 1.7 12 1.4 12 1.4 12 1.4 12 1.4 12 1.4 12 1.4 12 1.7 12 1.4
Kangoo 1.9 Diesel Express	[F8Q630] [F8Q632] [F8Q662]	10.97- 06.03 10.97- 06.03 10.97- 06.03 AC 10.97- 06.03 01.98- 01.98- 01.98- AC 01.98- 10.97- 10.97- 10.97- AC 10.97-	CA1304IR CA1621IR CA1622IR CA1444IR CA1304IR CA1621IR CA1622IR CA1444IR CA1304IR CA1621IR CA1622IR CA1444IR	14 75 14 110 14 120 14 110 14 75 14 110 14 120 14 110 14 75 14 110 14 120 14 110		10.97- 06.03 10.97- 06.03 10.97- 06.03 10.97- 06.03 01.98- 01.98- 01.98- 01.98- 10.97- 10.97- 10.97- 10.97-	CS684 CS784 CS684 CS784 CS684 CS784	12 1.7 12 1.4 12 1.4 12 1.4 12 1.7 12 1.4 12 1.4 12 1.4 12 1.4 12 1.7 12 1.7
Kangoo 1.9 DTi	[F9Q780]	02.00- 02.00- 02.00- AC 02.00-	CA1304IR CA1621IR CA1622IR CA1444IR	14 75 14 110 14 120 14 110		02.00- 02.00- 02.00-	CS784 CS684	12 1.4 12 1.7
Kangoo 1.9 DTi Express	[F9Q780] [F9Q782]	02.00- 02.00- 02.00- AC 02.00- 02.00-	CA1304IR CA1621IR CA1622IR CA1444IR CA1622IR	14 75 14 110 14 120 14 110 14 120		02.00- 02.00- 02.00- 02.00-	CS684 CS784 CS1344 CS1252	12 1.7 12 1.4 12 1.2 12 1.4
Koleos 2.0 DCi	[M9R832] [M9R834]	09.08- 09.08-	CA1979IR CA1979IR	14 150 14 150		09.08- 09.08-	CS1415 CS1415	12 2.2 12 2.2
Koleos 2.0 DCi 4x4	[M9R830] [M9R832]	09.08- 09.08-	CA1979IR CA1979IR	14 150 14 150		09.08- 09.08-	CS1415 CS1415	12 2.2 12 2.2
Laguna 1.5 DCi	[K9K780]	10.07-	CA2086IR*	14 210		10.07-	CS1332	12 1.4
Laguna 1.6 16V	[K4M710] [K4M711] [K4M716] [K4M720] [K4M724] [K4M824]	03.01- AC 03.01- 03.01- 03.01- 02.05- 05.98- 03.01 05.98- 03.01 05.98- 03.01 AC 05.98- 03.01 03.99- 03.01 03.99- 03.01 03.99- 03.01 AC 05.98- 02.01 10.07-	CA1628IR CA1470IR CA1470IR CA1628IR CA1771IR CA1470IR CA1484IR CA1628IR CA1470IR CA1470IR CA1484IR CA1628IR CA1470IR CA1887IR	14 98 14 98 14 98 14 98 14 120 14 98 14 75 14 98 14 98 14 98 14 75 14 75 14 98 14 98 14 120		03.01- 03.01- 01.05- 05.98- 03.01 11.97- 03.01	CS1174 CS1174 CS1276 CS1174	12 0.8 12 0.8 12 0.85 12 0.8 12 0.8 12 0.8
Laguna 1.8	[F3P670] [F3P674] [F3P678] [F3P720] [F3P724]	09.95- 04.97 09.95- 04.97 09.95- 04.97 09.95- 04.97 AC 09.95- 04.97 AC 09.95- 04.97 01.94- 11.95 11.95- 03.01 AC 01.94- 11.95 AC 01.94- 10.95 11.93- 03.01 AC 11.93- 03.01 11.93- 01.96 01.94- 06.98 01.94- 06.98 05.95- 03.01 05.95- 03.01 AC 11.93- 06.98 AC 11.93- 03.01	CA1079IR CA1306IR CA1307IR# CA848IR CA1036IR CA1309IR CA896IR CA1306IR CA1036IR CA1309IR CA896IR CA1036IR CA896IR CA1079IR CA848IR CA848IR CA1306IR CA1307IR# CA1036IR CA1309IR	14 75 A28 14 75 A27 14 110 A27 14 110 A28 14 110 A28 14 110 A27 14 75 A28 14 75 14 110 A28 14 110 A27 14 75 A28 14 75 14 110 A28 14 110 A27 14 75 A28 14 75 A28 14 110 A28 14 75 A27 14 110 A27 14 110 A28 14 110 A27		A13 09.95- 04.97 09.95- 04.97 A13 06.95- 02.01 06.95- 02.01 A13 01.94- 03.01 01.94- 03.01 A13 11.93- 03.01 11.93- 03.01 A13 11.93- 03.01 11.93- 03.01	CS784 CS681 CS784 CS681 CS784 CS681 CS784 CS681 CS784 CS681	12 1.4 12 1.1 12 1.4 12 1.1 12 1.4 12 1.1 12 1.4 12 1.1 12 1.4 12 1.1 12 1.4 12 1.1
Laguna 1.8 RT	[F3P670] [F3P678]	08.95- 04.97 08.95- 04.97 08.95- 04.97 AC 08.95- 04.97 AC 08.95- 04.97 01.94- 10.95 11.95- 03.01 AC 01.94- 01.96 AC 01.94- 03.01	CA1079IR CA1306IR CA1307IR# CA848IR CA1036IR CA1309IR CA896IR CA1306IR CA1036IR CA1309IR	14 75 A28 14 75 A27 14 110 A27 14 110 A28 14 110 A28 14 110 A27 14 75 A28 14 75 14 110 A28 14 110 A27		08.95- 04.97 A13 08.95- 04.97	CS681 CS784	12 1.1 12 1.4 12 1.1 12 1.4



	[F3P720]	01.94- 03.01 08.95- 03.01 AC 01.94- 03.01 AC 08.95- 03.01	CA896IR 14 75 CA1309IR 14 110 CA1036IR 14 110 CA1309IR 14 110		01.94- 03.01 A13 01.94- 03.01	CS681 12 1.1 CS784 12 1.4
	[F3P724]	01.94- 03.01 08.95- 03.01 AC 01.94- 03.01 AC 08.95- 03.01	CA896IR 14 75 CA1309IR 14 110 CA1036IR 14 110 CA1309IR 14 110		A13 01.94- 03.01 01.94- 03.01	CS784 12 1.4 CS681 12 1.1
Laguna 1.8 16V	[F4P760]	04.98- 03.01 04.98- 03.01 04.98- 03.01 AC 04.98- 03.01	CA1304IR 14 75 CA1621IR 14 110 CA1628IR 14 98 CA1470IR 14 98		04.98- 03.01	CS1179 12 0.9
	[F4P770]	03.01- 03.01- 03.01- 03.01- AC 03.01-	CA1627IR 14 125 CA1661IR 14 125 CA1662IR 14 125 CA1829IR 14 100 CA1662IR 14 125		03.01-	CS1179 12 0.9
	[F4P771]	03.01- 08.02 09.02-	CA1662IR 14 125 CA1661IR 14 125		03.01-	CS1179 12 0.9
	[F4P773]	03.01- 03.01- 03.01- 08.02 03.01- AC 03.01-	CA1627IR 14 125 CA1661IR 14 125 CA1662IR 14 125 CA1829IR 14 100 CA1662IR 14 125		03.01-	CS1179 12 0.9
	[F4P774]	03.01- 03.01- 08.02 03.01-	CA1661IR 14 125 CA1662IR 14 125 CA1829IR 14 100		03.01- 03.01-	CS1179 12 0.9 CS1255 12 0.9
	[F4P775]	03.01- 09.07 03.01- 08.02 03.01- 09.07	CA1661IR 14 125 CA1662IR 14 125 CA1829IR 14 100		03.01- 03.01- 09.07	CS1179 12 0.9 CS1255 12 0.9
Laguna 1.9 DCi	[F9Q664]	03.04-	CA1877IR 14 150		03.04-	CS1193 12 1.8
	[F9Q670]	03.01- 03.01-	CA1627IR 14 125 CA1645IR 14 125		03.01-	CS1193 12 1.8
	[F9Q674]	01.05-	CA1877IR 14 150		01.05-	CS1193 12 1.8
	[F9Q718]	03.03- 09.99- 03.01	CA1863IR 14 150 CA1627IR 14 125		09.99- 03.01	CS1193 12 1.8
	[F9Q750]	03.01- 03.01-	CA1627IR 14 125 CA1645IR 14 125		03.01-	CS1193 12 1.8
	[F9Q752]	03.01- AC 03.01- 01.03 AC 02.03-	CA1645IR 14 125 CA1627IR 14 125 CA1863IR 14 150		03.01- 03.01-	CS1478* 12 2.4 CS1193 12 1.8
	[F9Q754]	03.01- 03.03- 03.03- AC 03.01- 01.03 AC 02.03-	CA1645IR 14 125 CA1627IR 14 125 CA1863IR 14 150 CA1627IR 14 125 CA1863IR 14 150		03.01-	CS1193 12 1.8
	[F9Q756]	03.01- 03.01-	CA1627IR 14 125 CA1645IR 14 125		03.01-	CS1193 12 1.8
	[F9Q758]	05.05-	CA1877IR 14 150		05.05-	CS1193 12 1.8
	[F9Q759]	05.05-	CA1877IR 14 150		05.05-	CS1193 12 1.8
Laguna 1.9 TDi	[F9Q710]	09.99- 02.01 AC 09.99- 02.01	CA1622IR 14 120 CA1572IR 14 120		09.99- 02.01	CS684 12 1.7
	[F9Q716]	10.97- 09.99 10.97- 09.99 AC 10.97- 09.99	CA1322IR 14 120 CA1506IR 14 120 CA1303IR 14 120		10.97- 09.99 10.97- 09.99	CS684 12 1.7 CS784 12 1.4
Laguna 2.0	[F3R611]	01.99- 03.01	CA1036IR 14 110		01.99- 03.01 A13 01.99- 03.01	CS681 12 1.1 CS784 12 1.4
	[F3R722]	11.93- 05.97 11.93- 01.96 02.95- 05.97 07.95- 03.01 07.95- 03.01 AC 11.93- 05.97 AC 01.94- 03.01	CA848IR 14 110 A28 CA896IR 14 75 A28 CA1079IR 14 75 A28 CA1306IR 14 75 A27 CA1307IR# 14 110 A27 CA1036IR 14 110 A28 CA1309IR 14 110 A27		11.93- 03.01 A13 11.93- 03.01	CS681 12 1.1 CS784 12 1.4
	[F3R723]	11.93- 05.97 11.93- 01.96 02.95- 05.97 07.95- 03.01 07.95- 03.01 AC 11.93- 05.97 AC 01.94- 03.01	CA848IR 14 110 A28 CA896IR 14 75 A28 CA1079IR 14 75 A28 CA1306IR 14 75 A27 CA1307IR# 14 110 A27 CA1036IR 14 110 A28 CA1309IR 14 110 A27		A13 11.93- 03.01 11.93- 03.01	CS784 12 1.4 CS681 12 1.1
	[F3R768]	06.95- 02.01 10.98- 01.01 AC 06.95- 02.01	CA1306IR 14 75 CA1077IR 14 75 CA1309IR 14 110		06.95- 02.01 A13 10.98- 01.01	CS681 12 1.1 CS784 12 1.4
	[F4R780]	09.99- 02.01 09.99- 02.01	CA1622IR 14 120 CA1628IR 14 98		09.99- 02.01	CS1179 12 0.9
	[F4R800]				03.08-	CS1255 12 0.9
	[N7Q700]	06.95- 02.01	CA1056IR 14 120		A13 06.95- 02.01 06.95- 02.01	CS978 12 1.7 CS1060 12 1.1
	[N7Q704]	06.95- 02.01	CA1056IR 14 120		A13 06.95- 02.01 06.95- 02.01	CS978 12 1.7 CS1060 12 1.1
Laguna 2.0 GT	[F4R800]				03.08-	CS1255 12 0.9
Laguna 2.0 16V Turbo	[F4R811]				10.07-	CS1255 12 0.9
Laguna 2.0 16V	[F4R712]	03.01- A22 03.01- 08.02 A22 09.02-	CA1829IR 14 100 CA1661IR 14 125 CA1662IR 14 125		03.01-	CS1255 12 0.9
	[F4R713]	06.01- 09.02- A22 06.01- 08.02 A22 09.02-	CA1829IR 14 100 CA1662IR 14 125 CA1661IR 14 125 CA1662IR 14 125		06.01-	CS1255 12 0.9
	[F4R714]	09.01- 08.02- A22 09.01- 08.02 A22 09.02-	CA1829IR 14 100 CA1827IR 14 150 CA1661IR 14 125 CA1662IR 14 125		09.01-	CS1255 12 0.9
	[F4R715]	09.01- A22 09.01- 08.02 A22 09.02-	CA1829IR 14 100 CA1661IR 14 125 CA1662IR 14 125		09.01- 09.01-	CS1179 12 0.9 CS1255 12 0.9
	[F4R780]	09.99- 03.01 09.99- 03.01 09.99- 03.01 AC 09.99- 03.01	CA1304IR 14 75 CA1621IR 14 110 CA1628IR 14 98 CA1470IR 14 98		09.99- 03.01	CS1179 12 0.9
	[F4R784]	01.05-	CA1827IR 14 150		01.05-	CS1255 12 0.9
	[F4R786]	01.05-	CA1827IR 14 150		01.05-	CS1255 12 0.9
	[F4R787]	01.05-	CA1827IR 14 150		01.05-	CS1255 12 0.9



RENAULT Continued

	[F4R886]	01.05-	CA1827IR	14 150		01.05-	CS1255	12 0.9
	[M4R704]					10.07-	CS1418*	12 1.0
	[N7Q700]	06.95- 03.01	CA1056IR	14 120		A13 06.95- 03.01	CS978	12 1.7
		06.95- 03.01	CA1088IR	14 100	BO	06.95- 03.01	CS1060	12 1.1
		06.95- 03.01	CA1096IR	14 80				
		06.95- 03.01	CA1822IR	14 100	ND			
	[N7Q704]	06.95- 03.01	CA1056IR	14 120		06.95- 03.01	CS1060	12 1.1
		06.95- 03.01	CA1088IR	14 100	BO	A13 06.95- 03.01	CS978	12 1.7
		06.95- 03.01	CA1096IR	14 80				
		06.95- 03.01	CA1822IR	14 100	ND			
Laguna 2.0 iDE 16V	[F5R700]	04.01-	CA1661IR	14 125		04.01-	CS1255	12 0.9
		04.01-	CA1829IR	14 100				
Laguna 2.0 Turbo 16V	[F4R764]	07.02-	CA1661IR	14 125		07.02-	CS1255	12 0.9
		07.02-	CA1824IR	14 150				
		07.02-	CA1829IR	14 100				
	[F4R765]	07.02-	CA1661IR	14 125		07.02-	CS1255	12 0.9
		07.02-	CA1824IR	14 150				
	[F4R786]	04.04-	CA1827IR	14 150		04.04-	CS1255	12 0.9
	[F4R787]	04.04-	CA1827IR	14 150		04.04-	CS1255	12 0.9
Laguna 2.0 Turbo	[F4R887]	01.05- 09.07	CA1918IR	14 150		01.05- 09.07	CS1255	12 0.9
Laguna 2.0 16V Hi-Flex	[M4R704]					10.07-	CS1418*	12 1.0
Laguna 2.0 16V Hi-Flex Grandtour	[M4R704]					10.07-	CS1418*	12 1.0
Laguna 2.0 DCi	[M9R700]	08.05-	CA1771IR	14 120		08.05-	CS1290	12 1.3
	[M9R740]	08.05-	CA1771IR	14 120		08.05-	CS1290	12 1.3
		08.05-	CA1959IR	14 150		10.07-	CS1415	12 2.2
		10.07-	CA1971IR	14 210				
	[M9R742]	10.07-	CA1971IR	14 210		10.07-	CS1415	12 2.2
	[M9R744]	10.07-	CA1971IR	14 210		10.07-	CS1415	12 2.2
	[M9R746]	10.07-	CA1971IR	14 210		10.07-	CS1415	12 2.2
	[M9R748]	10.07-	CA1971IR	14 210		10.07-	CS1415	12 2.2
	[M9R760]	01.06-	CA1959IR	14 150		01.06-	CS1415	12 2.2
	[M9R802]	10.07-	CA1971IR	14 210		10.07-	CS1415	12 2.2
	[M9R805]	10.07-	CA1971IR	14 210		10.07-	CS1415	12 2.2
	[M9R809]	01.08-	CA1971IR	14 210		01.08-	CS1415	12 2.2
	[M9R816]	03.08-	CA1971IR	14 210		03.08-	CS1415	12 2.2
	[M9RA742]	10.07-	CA1971IR	14 210		10.07-	CS1415	12 2.2
Laguna 2.0 DCi GT	[M9R816]	03.08-	CA1971IR	14 210		03.08-	CS1415	12 2.2
Laguna 2.2 DCi	[G9T600]	05.05-	CA1824IR	14 150		05.05-	CS1288	12 2.4
	[G9T605]	05.05-	CA1824IR	14 150		05.05-	CS1288	12 2.4
	[G9T702]	03.01- 02.03	CA1661IR	14 125		03.01-	CS1207	12 2.0
		03.03-	CA1824IR	14 150		11.02-	CS1288	12 2.4
	[G9T706]	05.05-	CA1824IR	14 150		05.05-	CS1288	12 2.4
	[G9T707]	05.05-	CA1824IR	14 150		05.05-	CS1288	12 2.4
Laguna 2.2 Diesel	[G8T706]	11.93- 11.95	CA913IR	14 80		11.93- 11.95	CS1131#	12 2.2
		AC 11.93- 11.95	CA914IR	14 110		11.93- 11.95	CS964	12 2.2
	[G8T752]	11.95- 03.01	CA1036IR	14 110	A28	11.95- 03.01	CS964	12 2.2
		11.95- 03.01	CA1308IR	14 80	A27	11.95- 03.01	CS1131#	12 2.2
		11.95- 03.01	CA1309IR	14 110	A27			
		11.95- 03.01	CA896IR	14 75	A28			
		AC 11.95- 02.01	CA1036IR	14 110				
	[G8T760]	03.96- 03.01	CA1308IR	14 80		03.96- 03.01	CS1055	12 2.2
		03.96- 03.01	CA1309IR	14 110				
	[G8T790]	11.93- 11.95	CA913IR	14 80		11.93- 11.95	CS1131#	12 2.2
		AC 11.93- 11.95	CA914IR	14 110		11.93- 11.95	CS964	12 2.2
	[G8T794]	11.95- 03.01	CA1036IR	14 110	A28	11.95- 03.01	CS964	12 2.2
		11.95- 03.01	CA1308IR	14 80	A27	11.95- 03.01	CS1131#	12 2.2
		11.95- 03.01	CA1309IR	14 110	A27			
		11.95- 03.01	CA896IR	14 75	A28			
		AC 11.95- 02.01	CA1036IR	14 110				
Laguna 2.2 TD	[G8T760]	03.96- 03.01	CA1308IR	14 80		03.96- 03.01	CS1055	12 2.2
		03.96- 03.01	CA1309IR	14 110				
Laguna 3.0	[Z7X760]	AC 11.93- 03.01	CA1040IR	14 110		11.93- 03.01	CS882	12 1.1
	[Z7X765]	AC 11.93- 03.01	CA1040IR	14 110		11.93- 03.01	CS882	12 1.1
Laguna 3.0 24V	[L7X700]	03.97- 03.01	CA1388IR	14 150		03.97- 03.01	CS1108	12 1.5
		03.97- 03.01	CA1392IR	14 120				
	[L7X701]	03.97- 03.01	CA1388IR	14 150		03.97- 03.01	CS1108	12 1.5
		05.98- 03.01	CA1392IR	14 120				
Laguna 3.0 V6 24V	[L7X731]	03.01- 09.07	CA1388IR	14 150		AT 03.01- 09.07	CS1290	12 1.3
		03.01- 09.07	CA1392IR	14 120				
Laguna 3.0 DCi	[V9X791]	09.08-	CA1971IR	14 210				
Latitude 2.0 DCi	[M9R8..]	05.11-	CA1971IR	14 210		05.11-	CS1415	12 2.2
Latitude 2.0 DCi 150	[M9R824]	02.11-	CA1971IR	14 210		02.11-	CS1415	12 2.2
Latitude 3.0 DCi 240	[V9X891]	02.11-	CA1971IR	14 210				
Logan 1.5 DCi	[K9K796]	02.08-	CA1762IR	14 110		02.08-	CS1332	12 1.4
		02.08-	CA1933IR	14 125				
Logan 1.6	[K4M690]	04.07-	CA2043IR	14 110		04.07-	CS1276	12 0.85
Logan 1.6 MCV	[K4M690]	04.07-	CA2043IR	14 110		04.07-	CS1276	12 0.85
Master 1.9 DCi 80	[F9Q772]	11.01-	CA1645IR	14 125		11.01-	CS1193	12 1.8
		AC 11.01-	CA1627IR	14 125				
	[F9Q774]	11.01-	CA1645IR	14 125		11.01-	CS1193	12 1.8
		AC 11.01-	CA1627IR	14 125				
Master 1.9 DTi	[F9Q770]	09.00-	CA1622IR	14 120		09.00-	CS1263	12 2.0
Master 2.0	[J5R718]	11.89- 07.93	CA165IR	14 50		11.89- 07.93	CS317	12 1.05
	[J5R728]	11.89- 12.95	CA165IR	14 50		11.89- 12.95	CS317	12 1.05
Master 2.1 Diesel	[J8S330]	11.89- 04.95	CA224IR	14 50		11.89- 04.95	CS353	12 3.1
Master 2.2	[J7T788]	08.93- 02.98	CA378IR	14 60		08.93- 02.98	CS317	12 1.05
						08.93- 02.98	CS791	12 1.1
Master 2.2 DCi 90	[G9T720]	09.00-	CA1645IR	14 125		09.00-	CS1207	12 2.0
		AC 09.00-	CA1627IR	14 125				
	[G9T722]	09.00-	CA1645IR	14 125		09.00-	CS1207	12 2.0
		AC 09.00-	CA1627IR	14 125				
	[G9T750]	09.00-	CA1645IR	14 125		09.00-	CS1207	12 2.0
		AC 09.00-	CA1627IR	14 125				
Master 2.3 DCi	[M9T670]					02.10-	CS1415	12 2.2
	[M9T676]					02.10-	CS1415	12 2.2
	[M9T678]					02.10-	CS1415	12 2.2
	[M9T680]					02.10-	CS1415	12 2.2
	[M9T690]					02.10-	CS1415	12 2.2
	[M9T692]					02.10-	CS1415	12 2.2
	[M9T698]					02.10-	CS1415	12 2.2
Master 2.3 DCi FWD	[M9T670]					02.10-	CS1415	12 2.2
	[M9T690]					02.10-	CS1415	12 2.2
Master 2.4 Diesel	[S8U730]	07.83- 02.98	CA314IR	14 75		07.83- 02.98	CS370	12 2.2
						07.83- 02.98	CS333	12 3.5



	[S8U731]	09.86- 10.89	CA314IR	14 75	09.86- 10.89	CS370	12 2.2	
					09.86- 10.89	CS333	12 3.5	
Master 2.5 DCi	[G9U632]	08.06- 08.06	CA1827IR CA1877IR	14 150 14 150	08.06-	CS1207	12 2.0	
	[G9U650]	08.06- 08.06	CA1827IR CA1877IR	14 150 14 150	08.06-	CS1207	12 2.0	
	[G9U754]	01.04- 01.04	CA1827IR CA1877IR	14 150 14 150	01.04-	CS1207	12 2.0	
		10.03- 10.06 10.03- 10.06	CA1827IR CA1824IR	14 150 14 150	10.03- 10.06	CS1207	12 2.0	
Master 2.5 DCi 100	[G9U754]	10.03- 10.06 10.03- 10.06	CA1827IR CA1824IR	14 150 14 150	10.03- 10.06	CS1207	12 2.0	
Master 2.5 DCi 120	[G9U754]	10.03- 10.06 10.03- 10.06 AC 10.03- 10.06	CA1827IR CA1824IR CA1661IR	14 150 14 150 14 125				
Master 2.5 DCi 90	[G9U720]	AC 10.01-	CA1661IR	14 125	10.01-	CS1207	12 2.0	
Master 2.5 Diesel	[S8U770]	10.97- 09.03 10.97- 09.03	CA1343IR CA1434IR	14 75 14 110	10.97- 09.03	CS1160	12 2.2	
Master 2.5 DT	[S9U702]	11.89- 10.93 11.89- 10.93	CA1339IR CA314IR	14 90 14 75	11.89- 10.93	CS370	12 2.2	
	[S9U740]	08.93- 02.98 08.93- 02.98	CA1339IR CA314IR	14 90 14 75	08.93- 02.98	CS370	12 2.2	
Master 2.8 Diesel	[S9W702]	10.97- 09.03 10.97- 09.03	CA1343IR CA1434IR	14 75 14 110	10.97- 09.03	CS1160	12 2.2	
Master 2.8 DTi	[S9W702]	10.97- 09.03 10.97- 09.03	CA1343IR CA1434IR	14 75 14 110	10.97- 09.03	CS1160	12 2.2	
Master 3.0 DCi	[ZD3]	06.05- 06.05	CA2081IR* CA2082IR*	14 120 14 135	06.05-	CS1491*	12 2.5	
Master 3.0 DCi 140	[ZD3200]	10.03- 10.03	CA2081IR* CA2082IR*	14 120 14 135	10.03-	CS1491*	12 2.5	
	[ZD3202]	10.03- 10.03	CA2081IR* CA2082IR*	14 120 14 135	10.03-	CS1491*	12 2.5	
Master 28-35 2.0	[829730]	10.82- 09.86	CA165IR	14 50	10.82- 09.86	CS317	12 1.05	
	[829731]	08.80- 10.86	CA165IR	14 50	08.80- 10.86	CS317	12 1.05	
	[J5R718]	10.86- 09.97	CA165IR	14 50	10.86- 09.97	CS317	12 1.05	
	[J5R728]	10.86- 09.97	CA165IR	14 50	10.86- 09.97	CS317	12 1.05	
Master 28-35 2.1 Diesel	[J8S330]	08.80- 09.97	CA224IR	14 50	08.80- 09.97	CS353	12 3.1	
Master 28-35 2.4 Diesel	[8140.61.2300]	08.80- 08.89	CA314IR	14 75	01.85- 08.89 08.80- 12.84	CS370 CS333	12 2.2 12 3.5	
					01.85- 08.89 08.80- 12.84	CS370 CS333	12 2.2 12 3.5	
	[S8U731]	08.80- 08.89	CA314IR	14 75				
Master 28-35 2.5 Diesel	[8140.61.2300]	09.80- 07.98	CA314IR	14 75	01.85- 07.98 09.80- 12.84	CS370 CS333	12 2.2 12 3.5	
	[8140.67.2510]	08.89- 07.98	CA314IR	14 75	08.89- 07.98	CS370	12 2.2	
	[S8U731]	09.80- 07.98	CA314IR	14 75	01.85- 07.98 09.80- 12.84	CS370 CS333	12 2.2 12 3.5	
	[S8U742]	08.89- 07.98	CA314IR	14 75	08.89- 07.98	CS370	12 2.2	
Master 28-35 2.5 TD	[8140.27.2580]	08.89- 07.98 10.94- 07.98	CA314IR CA1339IR	14 75 14 90	08.89- 07.98	CS370	12 2.2	
	[S9U702]	09.80- 07.98 10.94- 07.98	CA314IR CA1339IR	14 75 14 90	09.80- 07.98	CS370	12 2.2	
Master 30 2.2	[J7T782]	08.80- 07.98	CA378IR	14 60	10.94- 07.98 08.80- 07.98	CS791 CS317	12 1.1 12 1.05	
	[J7T788]	01.94- 07.98	CA378IR	14 60	10.94- 07.98 01.94- 09.94	CS791 CS317	12 1.1 12 1.05	
Master 35 2.5 TD	[8140.27.2500]	08.89- 07.98 10.94- 07.98	CA314IR CA1339IR	14 75 14 90	08.89- 07.98	CS370	12 2.2	
	[8140.27.2510]	08.89- 07.98 10.94- 07.98	CA314IR CA1339IR	14 75 14 90	08.89- 07.98	CS370	12 2.2	
	[S9U714]	08.89- 07.98 10.94- 07.98	CA314IR CA1339IR	14 75 14 90	08.89- 07.98	CS370	12 2.2	
Megane 1.4	[E7J626]	03.99- 09.03 AC 03.99- 09.03	CA1484IR CA1544IR	14 75 14 85	03.99- 09.03 03.99- 09.03	CS784 CS1186	12 1.4 12 1.0	
	[E7J664]	01.96- 06.97 06.97- 09.03 AC 01.96- 06.97 AC 06.97- 09.03	CA1077IR CA1333IR CA1078IR CA1319IR	14 75 14 80 14 110 14 110	01.96- 09.03 02.99- 09.03 01.96- 09.03	CS681 CS784 CS1186	12 1.1 12 1.4 12 1.0	
	[K4J730]	09.03- 09.03 AC 09.03- 09.03	CA1944IR CA1762IR	14 150 14 110	09.03-	CS1276	12 0.85	
	[K4J732]	AC 09.03- 09.03	CA1823IR	14 150				
	[K4J740]	09.03- 09.03 AC 09.03- 09.03	CA1762IR CA1944IR CA1762IR	14 110 14 150 14 110	09.03-	CS1276	12 0.85	
		AC 09.03- 09.03	CA1823IR	14 150				
	Megane 1.4 ECO	[E7J624]	02.96- 06.97 06.97- 03.99 AC 02.96- 06.97 AC 06.97- 03.99	CA1077IR CA1333IR CA1078IR CA1319IR	14 75 14 80 14 110 14 110	02.96- 03.99	CS1186 CS681	12 1.0 12 1.1
Megane 1.4 16V	[K4J714]	03.99- 09.03 03.99- 10.02 AC 03.99- 09.03 AC 03.99- 10.02 AC 03.99- 10.02 A22 05.00- 09.03 A22 05.00- 09.03 A13 05.00- 10.02	CA1484IR CA1771IR CA1470IR CA1544IR CA1771IR CA1628IR CA1771IR CA1771IR	14 75 14 120 14 98 14 85 14 120 14 98 14 120 14 120	05.00- 10.02 03.99- 09.03	CS1276 CS1174	12 0.85 12 0.8	
	[K4J730]	11.02- 11.02 AC 11.02- 11.02	CA1944IR CA1762IR CA1823IR	14 150 14 110 14 150	11.02-	CS1276	12 0.85	
	[K4J732]	10.03-	CA1762IR	14 110	10.03-	CS1276	12 0.85	
	[K4J740]	11.02- 11.02 AC 11.02- 11.02 AC 11.02- 11.02	CA1944IR CA1762IR CA1823IR	14 150 14 110 14 150	11.02-	CS1276	12 0.85	
	[K4J750]	03.99- 09.03 03.99- 09.03 03.99- 09.03 AC 03.99- 09.03 A22 03.99- 09.03	CA1484IR CA1628IR CA1771IR CA1544IR CA1470IR	14 75 14 98 14 120 14 85 14 98	03.99- 09.03	CS1174	12 0.8	
	Megane 1.4 i	[E7J626]	01.96- 10.02 01.97- 06.97 06.97- 09.03 AC 01.96- 10.02 AC 01.97- 06.97 AC 06.97- 09.03	CA1484IR CA1077IR CA1333IR CA1544IR CA1078IR CA1319IR	14 75 14 75 14 80 14 85 14 110 14 110	01.96- 09.03 03.99- 10.02	CS681 CS1186	12 1.1 12 1.0



RENAULT Continued

	[E7J764]	01.96- 06.97 06.97- 09.03 AC 01.96- 06.97 AC 06.97- 09.03	CA1077IR CA1333IR CA1078IR CA1319IR	14 75 14 80 14 110 14 110		01.96- 09.03 01.96- 09.03	CS681 CS1186	12 1.1 12 1.0
Megane 1.5 DCi	[K9K722]	08.03- 09.03- 09.03- 09.03- AC 11.02- AC 11.02-	CA1881IR CA1762IR CA1771IR CA1876IR CA1762IR CA1823IR	14 120 14 110 14 120 14 150 14 110 14 150		11.02-	CS1273	12 1.1
	[K9K724]	10.04- 05.05-	CA1876IR CA1762IR	14 150 14 110		10.04-	CS1332	12 1.4
	[K9K728]	02.04- 02.04- 02.04-	CA1876IR CA1881IR CA1974IR	14 150 14 120 14 150		02.04-	CS1332	12 1.4
	[K9K729]	10.03- 10.03- 10.03- 02.04- 02.04-	CA1762IR CA1823IR CA1876IR CA1881IR CA1974IR	14 110 VA 14 150 BO 14 150 BO 14 120 14 150		10.03-	CS1332	12 1.4
	[K9K732]	10.03- 10.03- 10.03- 02.04- 02.04- 05.05- 01.07-	CA1762IR CA1823IR CA1876IR CA1881IR CA1974IR CA2086IR* CA1627IR	14 110 VA 14 150 BO 14 150 BO 14 120 14 150 14 210 14 125		10.03-	CS1332	12 1.4
	[K9K734]	10.04- 05.05- 05.05-	CA1876IR CA1974IR CA2086IR*	14 150 14 150 14 210		09.04-	CS1332	12 1.4
	[K9K830]	11.08-	CA1974IR	14 150		11.08-	CS1332	12 1.4
	[K9K832]	02.09- 02.09-	CA1974IR CA2086IR*	14 150 14 210		02.09-	CS1332	12 1.4
	[K9K834]	02.09- 02.09-	CA1974IR CA2086IR*	14 150 14 210		02.09-	CS1332	12 1.4
	[K9K836]	02.09- 02.09-	CA1974IR CA2086IR*	14 150 14 210		02.09-	CS1332	12 1.4
Megane 1.6	[K4M760]	08.03- 09.03- AC 09.03- AC 09.03-	CA2043IR CA1944IR CA1762IR CA1823IR	14 110 14 150 14 110 14 150		09.03-	CS1276	12 0.85
	[K4M761]	09.03- 09.03- AC 09.03- AC 09.03-	CA1944IR CA2043IR CA1762IR CA1823IR	14 150 14 110 14 110 14 150		09.03-	CS1276	12 0.85
	[K4M762]	05.05- 05.05- 05.05-	CA1658IR CA1887IR CA1944IR	14 120 14 120 14 150		05.05- 05.05-	CS1174 CS1276	12 0.8 12 0.85
	[K7M702]	10.96- 09.03 06.97- 09.03 AC 10.96- 09.03 AC 06.97- 09.03	CA1077IR CA1333IR CA1078IR CA1319IR	14 75 A28 14 80 A27 14 110 A28 14 110 A27		10.96- 09.03	CS681	12 1.1
	[K7M703]	10.96- 03.99 06.97- 03.99 AC 10.96- 03.99 AC 06.97- 03.99	CA1077IR CA1333IR CA1078IR CA1319IR	14 75 A28 14 80 A27 14 110 A28 14 110 A27		10.96- 03.99	CS681	12 1.1
Megane 1.6 Classic	[K7M704]	02.00- 09.00 02.00- 09.00 02.00- 09.00	CA1484IR CA1544IR CA1628IR	14 75 14 85 14 98		02.00- 09.00 02.00- 09.00	CS1186 CS681	12 1.0 12 1.1
Megane 1.6 E	[K7M702]	01.96- 10.02 01.96- 09.03 ACPS 03.99- AC 01.96- 10.02 AC 01.96- 09.03	CA1077IR CA1333IR CA1319IR CA1078IR CA1319IR	14 75 A28 14 80 A27 14 110 A27 14 110 A28 14 110 A27		01.96- 10.02 01.96- 09.03	CS681 CS1174	12 1.1 12 0.8
	[K7M703]	01.96- 09.03 01.96- 09.03 ACPS 03.99- AC 01.96- 09.03 AC 01.96- 09.03	CA1077IR CA1333IR CA1319IR CA1078IR CA1319IR	14 75 A28 14 80 A27 14 110 A27 14 110 A28 14 110 A27		01.96- 09.03	CS681	12 1.1
	[K7M790]	01.96- 03.99 01.96- 03.99 AC 01.96- 03.99 AC 01.96- 03.99	CA1077IR CA1333IR CA1078IR CA1319IR	14 75 A28 14 80 A27 14 110 A28 14 110 A27		01.96- 03.99	CS681	12 1.1
Megane 1.6 16V Flex-Fuel	[K4M856]	02.08-	CA2003IR	14 110		02.08-	CS1276	12 0.85
Megane 1.6 16V	[K4M700]	03.99- 09.03 03.99- 09.03 03.99- 09.03 AC 03.99- 09.03 A22 03.99- 09.03	CA1484IR CA1628IR CA1771IR CA1544IR CA1470IR	14 75 14 98 14 120 14 85 14 98		03.99- 09.03	CS1174	12 0.8
	[K4M701]	05.00- 10.02 08.98- 09.03 03.99- 09.03 AC 08.98- 09.03 AC 03.99- 09.03 A22 08.98- 09.03 A22 03.99- 09.03 A22 03.99- 09.03	CA1771IR CA1484IR CA1628IR CA1544IR CA1470IR CA1771IR CA1470IR CA1628IR	14 120 14 75 14 98 14 85 14 98 14 120 14 98 14 98		08.98- 09.03	CS1174	12 0.8
	[K4M704]	03.99- 09.03 03.99- 09.03 AC 03.99- 09.03 AC 03.99- 09.03 A22 03.99- 09.03	CA1484IR CA1628IR CA1470IR CA1544IR CA1470IR	14 75 14 98 14 98 14 85 14 98		03.99- 09.03	CS1174	12 0.8
	[K4M708]	05.00- 10.02 03.99- 09.03 03.99- 09.03 AC 03.99- 09.03 AC 03.99- 09.03 A22 05.00- 09.03 A22 11.00- 09.03 A22 03.99- 09.03	CA1771IR CA1484IR CA1628IR CA1470IR CA1544IR CA1628IR CA1771IR CA1470IR	14 120 14 75 14 98 14 98 14 85 14 98 14 120 14 98		03.99- 09.03	CS1174	12 0.8
	[K4M760]	11.02- 11.02- 01.07- 01.07-	CA1944IR CA2043IR CA1887IR CA2003IR	14 150 14 110 14 120 14 110		11.02-	CS1276	12 0.85



		AC 11.02-	CA1762IR	14 110				
		AC 11.02-	CA1823IR	14 150				
[K4M761]		01.07-	CA1887IR	14 120	01.07-	CS1276	12 0.85	
		01.07-	CA2003IR	14 110				
		01.07-	CA2043IR	14 110				
[K4M768]		01.07-	CA1887IR	14 120	01.07-	CS1276	12 0.85	
		01.07-	CA2043IR	14 110				
[K4M788]					01.07-	CS1276	12 0.85	
[K4M812]		05.05-	CA1944IR	14 150	05.05-	CS1276	12 0.85	
		05.05-	CA2003IR	14 110				
		05.05-	CA2043IR	14 110				
		01.07-	CA1887IR	14 120				
[K4M813]		01.07-	CA1887IR	14 120	01.07-	CS1276	12 0.85	
		01.07-	CA2003IR	14 110				
		01.07-	CA2043IR	14 110				
[K4M848]		11.08-	CA1887IR	14 120	11.08-	CS1276	12 0.85	
[K4M858]		11.08-	CA1887IR	14 120				
[K4M866]		11.08-	CA1887IR	14 120				
		06.09-	CA1887IR	14 120				
Megane 1.6 Flex-Fuel	[K4M856]	01.07-	CA2003IR	14 110	01.07-	CS1276	12 0.85	
Megane 1.6 i	[K7M720]	01.96- 03.99	CA1077IR	14 75	01.96- 03.99	CS681	12 1.1	
		06.97- 03.99	CA1333IR	14 80				
		AC 01.96- 06.97	CA1078IR	14 110				
		AC 06.97- 03.99	CA1319IR	14 110				
Megane 1.6 16V Bifuel	[K4M866]	11.08-	CA1887IR	14 120				
Megane 1.8 16V	[F4P720]	05.00- 09.03	CA1628IR	14 98	03.99- 09.03	CS1179	12 0.9	
		AC 03.99- 10.02	CA1628IR	14 98				
	[F4P722]	05.00- 09.03	CA1628IR	14 98	03.99- 09.03	CS1179	12 0.9	
		AC 03.99- 10.02	CA1628IR	14 98				
Megane 1.9 DCi	[F9Q732]	02.01-	CA1506IR	14 120	02.01- 10.02	CS1344	12 1.2	
		02.01- 10.02	CA1621IR	14 110	03.99- 07.03	CS1252	12 1.4	
		02.01-	CA1653IR	14 80				
		03.99- 07.03	CA1304IR	14 75				
		03.99- 07.03	CA1622IR	14 120				
		AC 03.99- 07.03	CA1572IR	14 120				
	[F9Q733]	05.00- 10.02	CA1572IR	14 120	05.00- 10.02	CS1252	12 1.4	
		02.01-	CA1622IR	14 120				
		02.01-	CA1653IR	14 80				
		AC 02.01-	CA1572IR	14 120				
	[F9Q738]	02.01-	CA1304IR	14 75	02.01-	CS1252	12 1.4	
		02.01-	CA1506IR	14 120				
		02.01-	CA1622IR	14 120				
		02.01-	CA1653IR	14 80				
		AC 02.01-	CA1572IR	14 120				
	[F9Q750]	AC 11.02-	CA1767IR	14 155 A35	11.02-	CS1193	12 1.8	
		AC 11.02-	CA1768IR	14 110				
		AC 11.02-	CA1814IR	14 125				
		AC 11.02-	CA2025IR	14 155 A35				
	[F9Q800]	08.03-	CA2025IR	14 155 A35	09.03-	CS1193	12 1.8	
		09.03-	CA1762IR	14 110				
		09.03-	CA1767IR	14 155 A35				
		09.03-	CA1768IR	14 110				
		09.03-	CA1814IR	14 125				
		09.03-	CA1827IR	14 150				
		09.03-	CA1918IR	14 150				
		09.03-	CA2058IR*	14 120				
		05.05-	CA1628IR	14 98				
	[F9Q803]	05.05-	CA1768IR	14 110	05.05-	CS1193	12 1.8	
		05.05-	CA1814IR	14 125	05.05-	CS1332	12 1.4	
		05.05-	CA1918IR	14 150	05.05-	CS1478*	12 2.4	
		05.05-	CA2058IR*	14 120				
	[F9Q804]	05.05-	CA1628IR	14 98	05.05-	CS1193	12 1.8	
		05.05-	CA1767IR	14 155 A35	05.05-	CS1332	12 1.4	
		05.05-	CA1768IR	14 110	05.05-	CS1478*	12 2.4	
		05.05-	CA1814IR	14 125				
		05.05-	CA1827IR	14 150				
		05.05-	CA1918IR	14 150				
		05.05-	CA2025IR	14 155 A35				
		05.05-	CA2058IR*	14 120				
	[F9Q808]	11.02- 12.05	CA1768IR	14 110	11.02- 12.05	CS1193	12 1.8	
		11.02- 12.05	CA1814IR	14 125				
		04.04- 12.05	CA1628IR	14 98				
		04.04- 12.05	CA1767IR	14 155 A35				
		04.04- 12.05	CA2025IR	14 155 A35				
	[F9Q816]	01.06-	CA1628IR	14 98	01.06-	CS1193	12 1.8	
		01.06-	CA1767IR	14 155				
		01.06-	CA1768IR	14 110				
		01.06-	CA1814IR	14 125				
		01.06-	CA2058IR*	14 120				
	[F9Q818]	01.06-	CA1628IR	14 98	01.06-	CS1193	12 1.8	
		01.06-	CA1767IR	14 155				
		01.06-	CA1768IR	14 110				
		01.06-	CA1814IR	14 125				
		01.06-	CA2058IR*	14 120				
	[F9Q870]	11.08-	CA1918IR	14 150	11.08-	CS1509*	12 1.4	
		11.08-	CA2101IR*	14 120				
	[F9Q872]	11.08-	CA1918IR	14 150	11.08-	CS1509*	12 1.4	
		11.08-	CA2101IR*	14 120				
		06.09-	CA1918IR	14 150	06.09-	CS1509*	12 1.4	
Megane 1.9 DCi Coach	[F9Q732]	03.99- 09.00	CA1304IR	14 75	03.99- 09.00	CS1252	12 1.4	
		03.99- 09.00	CA1622IR	14 120				
		AC 03.99- 09.00	CA1572IR	14 120				
Megane 1.9 Diesel	[F8Q620]	09.96- 12.96	CA1079IR	14 75	09.96- 02.99	CS784	12 1.4	
		09.96- 12.96	CA848IR	14 110	09.96- 02.99	CS684	12 1.7	
		01.97- 02.99	CA1306IR	14 75				
		01.97- 02.99	CA1307IR#	14 110				
		04.97- 02.99	CA1322IR	14 120				
		AC 09.96- 05.97	CA1036IR	14 110				
		AC 04.97- 02.99	CA1303IR	14 120				
		AC 05.97- 02.99	CA1309IR	14 110				
	[F8Q622]	01.01- 09.03	CA1304IR	14 75	01.01- 09.03	CS684	12 1.7	
		01.01- 09.03	CA1621IR	14 110				
		01.01- 09.03	CA1622IR	14 120				
		AC 01.01- 09.03	CA1572IR	14 120				



RENAULT Continued

	[F8Q624]	09.96- 09.03 CA1306IR 14 75		09.96- 09.03 CS684 12 1.7
		AC 09.96- 09.03 CA1309IR 14 110		
	[F8Q784]	10.96- 02.99 CA1079IR 14 75		10.96- 02.99 CS684 12 1.7
		10.96- 02.99 CA1306IR 14 75		
		10.96- 02.99 CA1307IR# 14 110		
		10.96- 02.99 CA848IR 14 110		
		AC 10.96- 02.99 CA1036IR 14 110		
		AC 10.96- 02.99 CA1303IR 14 120		
		AC 10.96- 02.99 CA1309IR 14 110		
	[F8Q790]	03.97- 09.03 CA1306IR 14 75		03.97- 09.03 CS684 12 1.7
		03.97- 09.03 CA1307IR# 14 110		
		05.97- 09.03 CA1322IR 14 120		
		04.99- 09.03 CA1621IR 14 110		
		04.99- 09.03 CA1622IR 14 120		
		AC 03.97- 05.97 CA1036IR 14 110		
		AC 05.97- 09.03 CA1303IR 14 120		
		AC 05.97- 09.03 CA1309IR 14 110		
Megane 1.9 Diesel Eco	[F8Q620]	01.96- 12.96 CA1079IR 14 75		01.96- 02.99 CS684 12 1.7
		01.96- 12.96 CA848IR 14 110		01.96- 02.99 CS784 12 1.4
		01.97- 02.99 CA1306IR 14 75		
		01.97- 02.99 CA1307IR# 14 110		
		04.97- 02.99 CA1322IR 14 120		
		AC 01.96- 05.97 CA1036IR 14 110		
		AC 04.97- 02.99 CA1303IR 14 120		
		AC 05.97- 02.99 CA1309IR 14 110		
	[F8Q624]	01.97- 02.99 CA1306IR 14 75		01.97- 02.99 CS684 12 1.7
		AC 01.97- 02.99 CA1309IR 14 110		
Megane 1.9 DTI	[F9Q731]	03.99- 09.03 CA1304IR 14 75		03.99- 09.03 CS784 12 1.4
		03.99- 09.03 CA1622IR 14 120		03.99- 09.03 CS684 12 1.7
		AC 03.99- 09.03 CA1506IR 14 120		
	[F9Q736]	03.99- 09.03 CA1304IR 14 75		03.99- 09.03 CS784 12 1.4
		03.99- 09.03 CA1622IR 14 120		03.99- 09.03 CS684 12 1.7
		AC 03.99- 09.03 CA1506IR 14 120		
	[F9Q744]	02.01- CA1304IR 14 75		02.01- CS1344 12 1.2
		02.01- CA1572IR 14 120		02.01- CS1252 12 1.4
		02.01- CA1621IR 14 110		
		02.01- CA1622IR 14 120		
		02.01- CA1653IR 14 80		
		AC 02.01- CA1572IR 14 120		
		A22 02.01- CA1622IR 14 120		
Megane 1.9 TD	[F8Q784]	01.96- 12.96 CA1079IR 14 75		01.96- 09.99 CS684 12 1.7
		01.96- 12.96 CA848IR 14 110		01.96- 09.99 CS784 12 1.4
		01.97- 09.99 CA1306IR 14 75		
		01.97- 09.99 CA1307IR# 14 110		
		04.97- 09.99 CA1322IR 14 120		
		AC 01.96- 05.97 CA1036IR 14 110		
		AC 04.97- 09.99 CA1303IR 14 120		
		AC 05.97- 09.99 CA1309IR 14 110		
	[F8Q786]	01.96- 09.03 CA1306IR 14 75		01.96- 09.03 CS684 12 1.7
		AC 01.96- 09.03 CA1309IR 14 110		01.97- 09.03 CS784 12 1.4
Megane 1.9 TDi	[F8Q784]	06.97- 02.99 CA1306IR 14 75		06.97- 02.99 CS684 12 1.7
		06.97- 02.99 CA1307IR# 14 110		
		06.97- 02.99 CA1309IR 14 110		
		06.97- 02.99 CA1322IR 14 120		
		AC 06.97- 02.99 CA1303IR 14 120		
	[F9Q730]	06.97- 09.03 CA1306IR 14 75		06.97- 09.03 CS684 12 1.7
		06.97- 09.03 CA1307IR# 14 110		06.97- 09.03 CS784 12 1.4
		06.97- 09.03 CA1322IR 14 120		
		AC 06.97- 09.03 CA1303IR 14 120		
		AC 06.97- 09.03 CA1309IR 14 110		
	[F9Q731]	03.99- 09.03 CA1304IR 14 75		03.99- 09.03 CS784 12 1.4
		03.99- 09.03 CA1622IR 14 120		03.99- 09.03 CS684 12 1.7
		AC 03.99- 09.03 CA1572IR 14 120		
		A22 03.99- 10.02 CA1622IR 14 120		
	[F9Q734]	06.97- 02.99 CA1306IR 14 75		03.97- 02.99 CS684 12 1.7
		06.97- 02.99 CA1307IR# 14 110		03.97- 02.99 CS784 12 1.4
		06.97- 02.99 CA1322IR 14 120		
		AC 06.97- 02.99 CA1303IR 14 120		
	[F9Q736]	03.99- 09.03 CA1304IR 14 75		03.99- 09.03 CS684 12 1.7
		03.99- 09.03 CA1622IR 14 120		03.99- 09.03 CS784 12 1.4
		AC 03.99- 09.03 CA1572IR 14 120		
		A22 03.99- 10.02 CA1622IR 14 120		
Megane 2.0	[F3R750]	04.97- CA1306IR 14 75		04.97- CS681 12 1.1
		04.97- CA1307IR# 14 110		A13 04.97- CS784 12 1.4
		AC 04.97- CA1309IR 14 110		
	[F4R770]	09.02- CA1768IR 14 110		09.02- CS1255 12 0.9
		09.02- CA1814IR 14 125		
		09.03- CA2058IR* 14 120		
	[F4R771]	09.03- CA1768IR 14 110		09.03- CS1255 12 0.9
		09.03- CA1814IR 14 125		
		09.03- CA2057IR 14 110		
		09.03- CA2058IR* 14 120		
	[F4R774]	08.06- CA1768IR 14 110		08.06- CS1255 12 0.9
		08.06- CA1814IR 14 125		
Megane 2.0 Sport	[F4R774]	05.04- CA1768IR 14 110		05.04- CS1255 12 0.9
		05.04- CA1814IR 14 125		
Megane 2.0 16V	[F4R746]	09.01- 10.02 CA1628IR 14 98		09.01- 10.02 CS1179 12 0.9
	[F4R770]	10.03- CA1628IR 14 98		11.02- CS1255 12 0.9
		AC 11.02- CA1768IR 14 110		10.03- CS1179 12 0.9
		AC 11.02- CA1814IR 14 125		
	[F7R710]	01.96- 04.97 CA1079IR 14 75		01.96- 04.97 CS681 12 1.1
		01.96- 04.97 CA1304IR 14 75		A13 01.96- 04.97 CS784 12 1.4
	[F7R714]	05.97- 09.03 CA1079IR 14 75		03.99- 10.02 CS1179 12 0.9
		05.97- 10.02 CA1304IR 14 75		05.97- 09.03 CS681 12 1.1
		02.99- 09.03 CA1307IR# 14 110		A13 05.97- 09.03 CS784 12 1.4
		03.99- 10.02 CA1470IR 14 98		
		03.99- 10.02 CA1628IR 14 98		
	[M4R711]			02.09- CS1418* 12 1.0
Megane 2.0 i	[F3R750]	01.96- 08.96 CA1079IR 14 75		01.96- 03.99 CS681 12 1.1
		01.96- 08.96 CA848IR 14 110		A13 01.96- 03.99 CS784 12 1.4
		09.96- 03.99 CA1306IR 14 75		
		09.96- 03.99 CA1307IR# 14 110		





		03.99- AC 01.96- 04.97 AC 05.97- 03.99	CA1309IR CA1036IR CA1309IR	14 110 14 110 14 110				
[F3R751]		01.96- 03.99 01.97- 03.99 AC 01.96- 03.99 AC 01.97- 04.97	CA1306IR CA1307IR# CA1309IR CA1036IR	14 75 14 110 14 110 14 110		01.96- 03.99 A13 01.96- 03.99	CS681 CS784	12 1.1 12 1.4
[F3R752]		03.99- 03.99- 03.99-	CA1306IR CA1307IR# CA1309IR	14 75 14 110 14 110		03.99- A13 03.99-	CS681 CS784	12 1.1 12 1.4
[F3R791]		09.96- 09.03 09.96- 09.03 09.96- 09.03 09.96- 09.03	CA1303IR CA1306IR CA1307IR# CA1309IR	14 120 14 75 14 110 14 110		A13 09.96- 09.03 09.96- 09.03	CS784 CS681	12 1.4 12 1.1
[F3R796]		09.96- 09.03 01.99- 04.03 01.99- 04.03 AC 09.96- 09.03	CA1306IR CA1307IR# CA1309IR CA1309IR	14 75 14 110 14 110 14 110		A13 01.99- 04.03 09.96- 09.03	CS784 CS681	12 1.4 12 1.1
Megane 2.0 iDE 16V	[F5R740]	11.99- AC 11.99- AC 11.99-	CA1304IR CA1470IR CA1628IR	14 75 14 98 14 98		11.99-	CS1179	12 0.9
Megane 2.0 TCe	[F4R874]	05.09-	CA2101IR*	14 120				
Megane 2.0 Turbo 16V	[F4R776]	05.04- 05.04- 05.04-	CA1768IR CA1814IR CA2058IR*	14 110 14 125 14 120		05.04-	CS1255	12 0.9
Megane 2.0 DCi	[M9R610] [M9R615] [M9R700] [M9R724]	04.09- 04.09- 09.05- 09.05- 01.07-	CA1971IR CA1971IR CA1936IR CA1945IR CA1936IR	14 210 14 210 14 150 14 120 14 150		04.09- 04.09- 09.05- 09.05- 01.07-	CS1415 CS1415 CS1415 CS1415	12 2.2 12 2.2 12 2.2 12 2.2
Megane CC 1.5 DCi	[K9K837]	06.10-	CA2086IR*	14 210				
Megane CC 1.6 16V	[K4M866]	06.10- 06.10- 06.10-	CA1860IR CA1887IR CA1974IR	14 120 14 120 14 150				
Megane CC 1.9 DCi		06.10- 06.10-	CA2101IR* CA1918IR	14 120 14 150		06.10-	CS1509*	12 1.4
Megane CC 2.0 CVT	[M4R713]					06.10-	CS1418*	12 1.0
Megane CC 2.0 TCe	[F4R870]	06.10-	CA2101IR*	14 120				
Megane CC 2.0 DCi		06.10-	CA1971IR	14 210		06.10-	CS1415	12 2.2
Modus 1.2	[D4F740] [D4F764]	09.04- w/Seat heating 09.04- 12.04- w/Seat heating 12.04-	CA1866IR CA1878IR CA1866IR CA1878IR	14 90 14 120 14 90 14 120		09.04- 12.04-	CS1057 CS1385	12 0.7 12 0.85 12 0.7 12 0.85
Modus 1.2 16V	[D4F784]	05.07- w/Seat heating 05.07-	CA1866IR CA1878IR	14 90 14 120		05.07- 05.07-	CS1057 CS1385	12 0.7 12 0.85
Modus 1.2 16V Hi-Flex	[D4F740]	10.08- w/Seat heating 10.08-	CA1866IR CA2054IR CA1878IR	14 90 14 110 14 120		10.08- 10.08-	CS1385 CS1057	12 0.85 12 0.7
Modus 1.4	[K4J770]	12.04- AC 09.04-	CA1860IR CA1887IR	14 120 14 120		06.04-	CS1425	12 1.1
Modus 1.5 DCi	[K9K752] [K9K760] [K9K762] [K9K764] [K9K766] [K9K770]	09.04- 01.05 12.04- 09.04- 01.05 09.04- 01.05 12.04- 05.05- 05.05- 09.04- 01.05 12.04- 10.10- 10.10-	CA1860IR CA1974IR CA1860IR CA1974IR CA1860IR CA1974IR CA1860IR CA1974IR CA1860IR CA1974IR CA1860IR CA1974IR CA1860IR CA1974IR	14 120 14 150 14 120 14 150 14 120 14 150 14 120 14 150 14 120 14 150 14 120 14 150		09.04- 09.04- 09.04- 05.05- 09.04-	CS1332 CS1332 CS1332 CS1332 CS1332	12 1.4 12 1.4 12 1.4 12 1.4 12 1.4 12 1.4
Modus 1.6	[K4M790]	12.04- AC 09.04-	CA1860IR CA1887IR	14 120 14 120		12.04-	CS1425	12 1.1
Modus 1.6 i 16V	[K4M791] [K4M792] [K4M794]	09.04- 12.04- AC 09.04- 12.04- AC 09.04-	CA1887IR CA1860IR CA1860IR CA1887IR CA1860IR CA1887IR	14 120 14 120 14 120 14 120 14 120 14 120		12.04- 12.04-	CS1425 CS1425 CS1425	12 1.1 12 1.1 12 1.1
R11 1.1	[C1E715] [C1E720]	03.83- 03.91 03.83- 10.87 10.84- 03.91 10.84- 03.91 03.83- 03.91 03.83- 10.87 10.84- 03.91 10.84- 03.91	CA288IR CA512IR CA375IR CA728IR# CA288IR CA512IR CA375IR CA728IR#	14 50 14 60 14 60 14 70 14 50 14 60 14 60 14 70		03.83- 03.91	CS310 CS310	12 0.9 12 0.9
R11 1.2	[C1G700] [C1G710]	10.84- 12.86 10.84- 02.86 10.84- 12.86 10.84- 12.86 06.86- 03.91 06.86- 03.91 06.86- 10.87 06.86- 03.91	CA288IR CA375IR CA512IR CA728IR# CA288IR CA375IR CA375IR CA512IR CA728IR#	14 50 14 60 14 60 14 70 14 50 14 60 14 60 14 70		10.84- 12.86 06.86- 03.91	CS310 CS310	12 0.9 12 0.9
R11 1.4	[C1J715] [C2J717] [C2J718] [C2J720]	03.83- 12.85 03.83- 12.85 10.84- 12.85 10.84- 12.85 05.83- 10.84 05.83- 10.84 10.84- 03.91 10.84- 03.91 03.83- 10.84 03.83- 10.84 10.84- 03.91 10.84- 03.91	CA288IR CA512IR CA375IR CA728IR# CA288IR CA512IR CA375IR CA728IR# CA288IR CA512IR CA375IR CA728IR# CA288IR CA512IR CA375IR CA728IR#	14 50 14 60 14 60 14 70 14 50 14 60 14 60 14 70 14 50 14 60 14 60 14 70		03.83- 12.85 05.83- 03.91 03.83- 03.91	CS310 CS310 CS310	12 0.9 12 0.9 12 0.9 12 0.9



**RENAULT** Continued

	[C2J730]	03.83- 03.91 CA288IR 14 50 03.83- 03.91 CA512IR 14 60 10.84- 03.91 CA375IR 14 60 10.84- 03.91 CA728IR# 14 70		03.83- 03.91 CS310 12 0.9
	[C2J755]	05.83- 10.84 CA288IR 14 50 05.83- 10.84 CA512IR 14 60 10.84- 03.91 CA375IR 14 60 10.84- 03.91 CA728IR# 14 70		05.83- 03.91 CS310 12 0.9
	[C2J757]	03.83- 10.84 CA288IR 14 50 03.83- 10.84 CA512IR 14 60 10.84- 12.84 CA375IR 14 60 10.84- 12.84 CA728IR# 14 70		03.83- 12.84 CS310 12 0.9
	[C2J766]	03.83- 10.84 CA288IR 14 50 03.83- 10.84 CA512IR 14 60 10.84- 03.91 CA375IR 14 60 10.84- 03.91 CA728IR# 14 70		03.83- 03.91 CS310 12 0.9
	[C2J767]	03.83- 10.84 CA288IR 14 50 03.83- 10.84 CA512IR 14 60 10.84- 03.91 CA375IR 14 60 10.84- 03.91 CA728IR# 14 70		03.83- 03.91 CS310 12 0.9
	[C2J768]	06.85- 03.91 CA288IR 14 50 06.85- 03.91 CA375IR 14 60 06.85- 10.87 CA512IR 14 60 06.85- 03.91 CA728IR# 14 70		06.85- 03.91 CS310 12 0.9
R11 1.4 Turbo	[C1J760]	09.83- 10.84 CA288IR 14 50 09.83- 10.84 CA512IR 14 60 10.84- 12.86 CA375IR 14 60 10.84- 12.86 CA728IR# 14 70		09.83- 12.86 CS310 12 0.9
	[C1J764]	09.83- 10.84 CA288IR 14 50 09.83- 10.84 CA512IR 14 60 10.84- 03.91 CA375IR 14 60 10.84- 03.91 CA728IR# 14 70		09.83- 03.91 CS310 12 0.9
	[C1J770]	06.85- 03.91 CA375IR 14 60 06.85- 03.91 CA728IR# 14 70		06.85- 03.91 CS310 12 0.9
	[C1J782]	06.85- 03.91 CA375IR 14 60 06.85- 03.91 CA728IR# 14 70		06.85- 03.91 CS310 12 0.9
R11 1.6 Diesel	[F8M700]	08.83- 09.86 CA373IR 14 60 10.86- 03.91 CA529IR 14 60		08.83- 03.91 CS354 12 1.7
	[F8M720]	08.83- 09.86 CA373IR 14 60 10.86- 09.87 CA529IR 14 60		08.83- 09.87 CS354 12 1.7
	[F8M730]	10.87- 03.91 CA529IR 14 60		10.87- 03.91 CS354 12 1.7
R11 1.7	[F2N700]	10.83- 12.87 CA372IR 14 60 PS 10.83- 12.87 CA612IR 14 70		10.83- 12.87 CS310 12 0.9
	[F2N704]	10.83- 06.87 CA372IR 14 60 PS 10.83- 06.87 CA612IR 14 70		10.83- 06.87 CS310 12 0.9
	[F2N708]	10.86- 03.91 CA372IR 14 60 PS 10.86- 03.91 CA612IR 14 70		10.86- 03.91 CS310 12 0.9
	[F2N710]	10.86- 03.91 CA372IR 14 60 PS 10.86- 03.91 CA612IR 14 70		10.86- 03.91 CS310 12 0.9
	[F2N730]	10.86- 03.91 CA372IR 14 60 PS 10.86- 03.91 CA612IR 14 70		10.86- 03.91 CS310 12 0.9
	[F2N732]	06.87- 03.91 CA372IR 14 60 PS 06.87- 03.91 CA612IR 14 70		06.87- 03.91 CS310 12 0.9
	[F2N742]	06.87- 03.91 CA372IR 14 60 PS 06.87- 03.91 CA612IR 14 70		06.87- 03.91 CS310 12 0.9
	[F2N798]	10.86- 03.91 CA372IR 14 60 PS 10.86- 03.91 CA612IR 14 70		10.86- 03.91 CS310 12 0.9
	[F3N708]	06.87- 12.88 CA372IR 14 60 PS 06.87- 12.88 CA612IR 14 70		06.87- 12.88 CS310 12 0.9
	[F3N718]	10.84- 03.91 CA372IR 14 60 PS 10.86- 03.91 CA612IR 14 70		10.84- 03.91 CS310 12 0.9
R12 1.3	[810]			06.80- 08.80 CS315 12 0.9 10.69- 06.80 CS95 12 0.6
	[810-02]			07.75- 04.80 CS95 12 0.6
	[810-06]			06.80- 08.80 CS315 12 0.9 08.73- 06.80 CS95 12 0.6
R12 1.3 Turbo TS	[810-06]			06.80- 08.80 CS315 12 0.9 08.72- 06.80 CS95 12 0.6
R14 1.2	[129]			05.76- 12.83 CS142 12 0.85
R14 1.4	[150]			09.79- 06.83 CS142 12 0.85
	[X5J]			12.81- 12.83 CS142 12 0.85
R16 1.6 TL	[821]	01.71- 04.77 CA190IR 14 35 05.77- 08.80 CA96IR 14 55		
R16 1.6 TX	[843]	06.74- 08.80 CA190IR 14 35 06.74- 08.80 CA96IR 14 55		
R18 1.4	[847720]	04.78- 02.86 CA170IR 14 55		A34 04.78- 02.86 CS321 12 0.9
	[847722]	04.78- 02.86 CA170IR 14 55		A34 04.78- 02.86 CS321 12 0.9
R18 1.6	[841717]	04.78- 02.86 CA170IR 14 55		A34 04.78- 02.86 CS321 12 0.9
	[841725]	04.78- 09.83 CA170IR 14 55		12.81- 09.83 CS316 12 1.05
	[841726]	04.78- 09.83 CA170IR 14 55		12.81- 09.83 CS316 12 1.05
	[A2M723]	04.78- 02.86 CA170IR 14 55		A34 04.78- 02.86 CS321 12 0.9
R18 1.6 4x4	[841717]	01.83- 07.86 CA170IR 14 55		06.83- 07.86 CS316 12 1.05
	[A2M723]	01.83- 02.86 CA170IR 14 55		06.83- 02.86 CS316 12 1.05
R18 1.6 TS	[A6M725]	05.82- 02.86 CA170IR 14 55		05.82- 02.86 CS316 12 1.05
	[A6M726]	05.82- 02.86 CA170IR 14 55		05.82- 02.86 CS316 12 1.05
R18 1.6 Turbo	[807727]	10.80- 02.86 CA170IR 14 55		09.82- 02.86 CS316 12 1.05
	[A5L717]	10.82- 02.86 CA170IR 14 55		10.82- 02.86 CS316 12 1.05
	[A5L718]	10.82- 02.86 CA170IR 14 55		10.82- 02.86 CS316 12 1.05
	[A7L752]	09.82- 02.86 CA170IR 14 55		09.82- 02.86 CS316 12 1.05
R18 2.0	[J6R716]	05.82- 07.86 CA165IR 14 50		A13 10.81- 07.86 CS523 12 2.2 10.81- 07.86 CS317 12 1.05
R18 2.0 4x4	[J6R714]	05.83- 12.86 CA165IR 14 50		A13 05.83- 12.86 CS523 12 2.2 05.83- 12.86 CS317 12 1.05
R18 2.1 Diesel	[852710]	11.80- 02.86 CA268IR 14 50 11.81- 02.86 CA643IR 14 75		11.80- 02.86 CS338 12 2.5 01.84- 02.86 CS353 12 3.1
	[J8S711]	11.80- 02.86 CA268IR 14 50 11.81- 02.86 CA643IR 14 75		11.80- 02.86 CS338 12 2.5 01.84- 02.86 CS353 12 3.1
R18 2.1 TD	[J8S712]	11.81- 02.86 CA268IR 14 50 11.81- 02.86 CA643IR 14 75		11.81- 02.86 CS338 12 2.5 01.84- 02.86 CS353 12 3.1
R18 2.2 i	[J7T718]			A13 06.84- 07.86 CS523 12 2.2 06.84- 07.86 CS317 12 1.05
R19 1.2	[C1G730]	01.88- 12.95 CA317IR 14 50 01.88- 12.01 CA375IR 14 60		01.88- 12.01 CS310 12 0.9



R19 1.4	[C2J772]	01.89- 04.92	<b>CA3171R</b>	14 50	01.89- 04.92	<b>CS310</b>	12 0.9	
		01.89- 04.92	<b>CA3751R</b>	14 60	10.89- 04.92	<b>CS681</b>	12 1.1	
		01.89- 12.89	<b>CA7281R#</b>	14 70				
	[C3J710]	01.89- 10.95	<b>CA3171R</b>	14 50	01.89- 10.95	<b>CS310</b>	12 0.9	
		01.89- 10.95	<b>CA3751R</b>	14 60	10.89- 04.92	<b>CS681</b>	12 1.1	
	[E6J700]	01.88- 12.95	<b>CA5491R</b>	14 60	01.88- 12.01	<b>CS681</b>	12 1.1	
		01.88- 12.01	<b>CA6491R</b>	14 70	01.88- 12.01	<b>CS310</b>	12 0.9	
		PS 01.88- 12.95	<b>CA6321R</b>	14 90				
		AC 01.88- 06.91	<b>CA8301R</b>	14 90				
		AC 07.91- 12.01	<b>CA6321R</b>	14 90				
	[E6J701]	PS 09.88- 12.01	<b>CA6321R</b>	14 90	09.88- 12.01	<b>CS310</b>	12 0.9	
		PS 09.88- 12.01	<b>CA6491R</b>	14 70	09.88- 12.01	<b>CS681</b>	12 1.1	
		AC 09.88- 06.91	<b>CA8301R</b>	14 90				
		AC 07.91- 12.01	<b>CA6321R</b>	14 90				
	[E7J]	03.92- 12.95	<b>CA5491R</b>	14 60	03.92- 12.95	<b>CS681</b>	12 1.1	
		03.92- 12.95	<b>CA6491R</b>	14 70				
		PS 03.92- 12.95	<b>CA5491R</b>	14 60				
		PS 03.92- 12.95	<b>CA6321R</b>	14 90				
		PS 03.92- 12.95	<b>CA6491R</b>	14 70				
		AC 03.92- 12.95	<b>CA6321R</b>	14 90				
		AC 03.92- 12.95	<b>CA6491R</b>	14 70				
	[E7J706]	01.92- 12.95	<b>CA5491R</b>	14 60	01.92- 12.95	<b>CS784</b>	12 1.4	
		01.92- 12.95	<b>CA6491R</b>	14 70	01.92- 12.95	<b>CS310</b>	12 0.9	
		PS 01.92- 12.95	<b>CA6321R</b>	14 90	01.92- 12.95	<b>CS681</b>	12 1.1	
		AC 01.92- 12.95	<b>CA6321R</b>	14 90				
	[E7J742]	01.92- 12.01	<b>CA5491R</b>	14 60	01.92- 12.01	<b>CS681</b>	12 1.1	
		01.92- 12.01	<b>CA6491R</b>	14 70				
		ACPS 01.92- 12.01	<b>CA6321R</b>	14 90				
		PS 09.91- 12.01	<b>CA6491R</b>	14 70	01.88- 12.01	<b>CS310</b>	12 0.9	
		AC 07.91- 12.92	<b>CA6321R</b>	14 90				
	R19 1.4 Chamade	[C1J742] [E7J745]	05.92- 09.94	<b>CA3751R</b>	14 60	05.92- 09.94	<b>CS310</b>	12 0.9
			10.94- 11.95	<b>CA6491R</b>	14 70	10.94- 11.95	<b>CS681</b>	12 1.1
			AC 10.94- 11.95	<b>CA6321R</b>	14 90			
R19 1.7	[F3N740]	09.88- 12.95	<b>CA3721R</b>	14 60	09.88- 12.95	<b>CS681</b>	12 1.1	
		09.88- 12.95	<b>CA5241R</b>	14 70	A13 09.88- 12.95	<b>CS684</b>	12 1.7	
		PS 09.88- 12.95	<b>CA6121R</b>	14 70				
		AC 09.88- 12.95	<b>CA8311R</b>	14 90				
	[F3N741]	09.88- 12.95	<b>CA3721R</b>	14 60	09.88- 12.95	<b>CS681</b>	12 1.1	
		09.88- 12.95	<b>CA5241R</b>	14 70	A13 09.88- 12.95	<b>CS684</b>	12 1.7	
		PS 09.88- 12.95	<b>CA6121R</b>	14 70				
		AC 09.88- 12.95	<b>CA8311R</b>	14 90				
	[F3N742]	09.88- 06.96	<b>CA3721R</b>	14 60	09.88- 06.96	<b>CS681</b>	12 1.1	
		09.88- 06.96	<b>CA5241R</b>	14 70	A13 09.88- 12.95	<b>CS684</b>	12 1.7	
		PS 09.88- 06.96	<b>CA6121R</b>	14 70				
		PS 04.92- 12.95	<b>CA3721R</b>	14 60				
		AC 09.88- 06.96	<b>CA8311R</b>	14 90				
	[F3N743]	09.88- 06.96	<b>CA3721R</b>	14 60	04.92- 12.95	<b>CS354</b>	12 1.7	
		09.88- 06.96	<b>CA5241R</b>	14 70	09.88- 06.96	<b>CS681</b>	12 1.1	
		04.92- 12.95	<b>CA6341R</b>	14 90	AT 09.88- 12.95	<b>CS684</b>	12 1.7	
		PS 09.88- 06.96	<b>CA6121R</b>	14 70				
		PS 04.92- 12.95	<b>CA3721R</b>	14 60				
		AC 09.88- 06.96	<b>CA8311R</b>	14 90				
	[F3N746]	07.91- 04.92	<b>CA6341R</b>	14 90				
		08.88- 12.92	<b>CA5241R</b>	14 70	08.88- 12.92	<b>CS681</b>	12 1.1	
		PS 08.88- 12.92	<b>CA3721R</b>	14 60	08.88- 12.92	<b>CS684</b>	12 1.7	
		PS 07.91- 04.92	<b>CA6121R</b>	14 70	AT 07.91- 04.92	<b>CS684</b>	12 1.7	
	R19 1.7 Chamade	[F2N720]	07.91- 04.92	<b>CA6341R</b>	14 90	07.91- 04.92	<b>CS681</b>	12 1.1
07.91- 04.92			<b>CA5241R</b>	14 70				
09.88- 08.95			<b>CA3721R</b>	14 60	09.88- 12.92	<b>CS681</b>	12 1.1	
09.88- 08.95		<b>CA5241R</b>	14 70	AT 09.88- 08.95	<b>CS310</b>	12 0.9		
PS 09.88- 08.95		<b>CA6121R</b>	14 70					
AC 09.88- 08.95		<b>CA8311R</b>	14 90					
[F2N721]		09.88- 08.95	<b>CA3721R</b>	14 60	AT 09.88- 08.95	<b>CS310</b>	12 0.9	
		09.88- 08.95	<b>CA5241R</b>	14 70	09.88- 12.92	<b>CS681</b>	12 1.1	
		PS 09.88- 08.95	<b>CA6121R</b>	14 70				
[F2N724]		AC 09.88- 08.95	<b>CA8311R</b>	14 90				
	05.92- 11.95	<b>CA5241R</b>	14 70	05.92- 11.95	<b>CS681</b>	12 1.1		
	PS 05.92- 11.95	<b>CA6121R</b>	14 70					
R19 1.8	[F3P682]	AC 05.92- 11.95	<b>CA8311R</b>	14 90				
		05.92- 06.96	<b>CA5241R</b>	14 70	A13 05.94- 06.96	<b>CS784</b>	12 1.4	
		PS 05.92- 06.96	<b>CA6121R</b>	14 70	05.92- 06.96	<b>CS681</b>	12 1.1	
	[F3P700]	AC 05.92- 06.96	<b>CA8311R</b>	14 90				
		04.92- 05.94	<b>CA5241R</b>	14 70	04.92- 05.94	<b>CS681</b>	12 1.1	
		PS 04.92- 05.94	<b>CA6121R</b>	14 70				
	[F3P704]	AC 04.92- 05.94	<b>CA8311R</b>	14 90				
		04.92- 06.96	<b>CA5241R</b>	14 70	04.92- 06.96	<b>CS681</b>	12 1.1	
		PS 04.92- 06.96	<b>CA6121R</b>	14 70				
	[F3P705]	AC 04.92- 06.96	<b>CA8311R</b>	14 90				
		04.92- 06.96	<b>CA5241R</b>	14 70	04.92- 06.96	<b>CS681</b>	12 1.1	
		PS 04.92- 06.96	<b>CA6121R</b>	14 70				
	[F3P706]	AC 04.92- 06.96	<b>CA8311R</b>	14 90				
		04.92- 06.96	<b>CA5241R</b>	14 70	04.92- 06.96	<b>CS681</b>	12 1.1	
		05.92- 12.95	<b>CA6121R</b>	14 70				
		05.92- 12.95	<b>CA8311R</b>	14 90				
		PS 04.92- 06.96	<b>CA6121R</b>	14 70				
	[F3P707]	AC 04.92- 06.96	<b>CA8311R</b>	14 90				
		04.92- 06.96	<b>CA5241R</b>	14 70	04.92- 06.96	<b>CS681</b>	12 1.1	
		PS 04.92- 06.96	<b>CA6121R</b>	14 70				
	[F3P708]	AC 04.92- 06.96	<b>CA8311R</b>	14 90				
		04.92- 06.96	<b>CA5241R</b>	14 70	04.92- 06.96	<b>CS681</b>	12 1.1	
		PS 04.92- 06.96	<b>CA6121R</b>	14 70				
	[F3P760]	AC 04.92- 06.96	<b>CA8311R</b>	14 90				
04.92- 06.96		<b>CA5241R</b>	14 70	04.92- 06.96	<b>CS681</b>	12 1.1		
02.93- 12.95		<b>CA6121R</b>	14 70					
02.93- 12.95		<b>CA6341R</b>	14 90					
PS 04.92- 06.96		<b>CA6121R</b>	14 70					
AC 04.92- 06.96	<b>CA8311R</b>	14 90						



RENAULT Continued

	[F3P764]	11.94- 06.96 CA524IR 14 70 PS 11.94- 06.96 CA612IR 14 70 AC 11.94- 06.96 CA831IR 14 90		11.94- 06.96 CS681 12 1.1
	[F3P765]	10.94- 06.96 CA524IR 14 70 PS 10.94- 06.96 CA612IR 14 70 AC 10.94- 06.96 CA831IR 14 90		10.94- 06.96 CS784 12 1.4 10.94- 06.96 CS681 12 1.1
R19 1.8 Chamade	[F3P700]	05.92- 11.95 CA524IR 14 70 PS 05.92- 11.95 CA612IR 14 70 AC 05.92- 11.95 CA831IR 14 90		05.92- 11.95 CS681 12 1.1 05.92- 11.95 CS784 12 1.4
	[F3P765]	05.92- 09.94 CA524IR 14 70 PS 05.92- 09.94 CA612IR 14 70 AC 05.92- 09.94 CA831IR 14 90		05.92- 09.94 CS681 12 1.1
R19 1.8 RT	[F3P700]	04.92- 05.94 CA524IR 14 70 PS 04.92- 05.94 CA612IR 14 70 AC 04.92- 05.94 CA831IR 14 90		04.92- 05.94 CS681 12 1.1
	[F3P706]	04.92- 12.95 CA524IR 14 70 PS 04.92- 12.95 CA612IR 14 70 AC 04.92- 12.95 CA831IR 14 90		04.92- 12.95 CS681 12 1.1
	[F3P760]	04.92- 12.95 CA524IR 14 70 PS 04.92- 12.95 CA612IR 14 70 AC 04.92- 12.95 CA831IR 14 90		04.92- 12.95 CS681 12 1.1
R19 1.8 16V	[F7P704]	06.89- 06.96 CA605IR 14 70 AC 06.89- 12.95 CA848IR 14 110		06.89- 06.96 CS784 12 1.4 06.89- 06.96 CS310 12 0.9
R19 1.9 Diesel	[F8Q706]	01.88- 12.01 CA602IR 14 70 09.88- 04.92 CA527IR 14 70 AC 01.88- 12.01 CA1105IR 14 90 AC 01.88- 12.01 CA716IR 14 110		09.88- 04.92 CS684 12 1.7 01.88- 12.01 CS784 12 1.4
	[F8Q742]	06.90- 10.95 CA527IR 14 70 06.90- 12.01 CA602IR 14 70 AC 06.90- 12.01 CA1105IR 14 90 AC 06.90- 12.01 CA716IR 14 110		06.90- 10.95 CS684 12 1.7 06.90- 12.01 CS784 12 1.4 04.92- 10.95 CS354 12 1.7
R19 1.9 Diesel Chamade	[F8Q744]	05.92- 11.95 CA602IR 14 70 AC 05.92- 11.95 CA716IR 14 110		05.92- 11.95 CS684 12 1.7 05.92- 11.95 CS784 12 1.4
R19 1.9 DT	[F8Q740]	09.90- 12.95 CA602IR 14 70 AC 09.90- 04.92 CA716IR 14 110		09.90- 12.95 CS784 12 1.4 09.90- 12.95 CS684 12 1.7
	[F8Q744]	04.92- 12.95 CA602IR 14 70 AC 04.92- 12.95 CA1105IR 14 90		04.92- 12.95 CS684 12 1.7 04.92- 12.95 CS354 12 1.7
R20 1.6	[843]	12.79- 10.81 CA224IR 14 50		
	[843720]	10.75- 10.81 CA170IR 14 55		
	[843721]	10.75- 10.81 CA170IR 14 55		
R20 2.0	[829700]	12.79- 12.83 CA224IR 14 50 09.80- 12.83 CA378IR 14 60		09.80- 12.83 CS317 12 1.05
	[829701]	10.77- 12.83 CA378IR 14 60 12.79- 12.83 CA224IR 14 50		09.80- 12.83 CS317 12 1.05
	[829702]	10.80- 12.83 CA224IR 14 50 10.80- 12.83 CA378IR 14 60		07.82- 12.83 CS317 12 1.05 A13 07.82- 12.83 CS523 12 2.2
	[829703]	10.80- 12.83 CA224IR 14 50 10.80- 12.83 CA378IR 14 60		A13 07.82- 12.83 CS523 12 2.2 07.82- 12.83 CS317 12 1.05
R20 2.1 TD	[852]	10.80- 12.83 CA224IR 14 50 10.80- 12.83 CA378IR 14 60		10.80- 12.83 CS338 12 2.5 10.80- 12.83 CS353 12 3.1
	[J6S702]	01.82- 12.83 CA224IR 14 50 01.82- 12.83 CA378IR 14 60		01.82- 12.83 CS338 12 2.5 01.82- 12.83 CS353 12 3.1
R20 2.2	[851700]	10.80- 12.83 CA224IR 14 50 10.80- 12.83 CA378IR 14 60		A13 07.82- 12.83 CS523 12 2.2 07.82- 12.83 CS317 12 1.05
R21 1.4	[C2J770]	09.89- 05.93 CA317IR 14 50		09.89- 03.93 CS310 12 0.9
R21 1.7	[F2N710]	03.86- 12.95 CA372IR 14 60 03.86- 12.95 CA524IR 14 70 PS 03.86- 12.95 CA612IR 14 70 AC 03.86- 12.95 CA831IR 14 90		03.86- 12.95 CS310 12 0.9 AT 03.86- 12.88 CS681 12 1.1
	[F2N712]	03.86- 03.93 CA372IR 14 60 03.86- 03.93 CA524IR 14 70 PS 03.86- 03.93 CA612IR 14 70 AC 03.86- 03.93 CA831IR 14 90		03.86- 03.93 CS681 12 1.1 03.86- 03.93 CS310 12 0.9
	[F2N750]	03.86- 12.94 CA372IR 14 60 03.86- 12.94 CA524IR 14 70 PS 03.86- 12.94 CA612IR 14 70 AC 03.86- 12.94 CA831IR 14 90		12.89- 12.94 CS681 12 1.1 03.86- 12.89 CS310 12 0.9
	[F2N752]	06.87- 04.89 CA372IR 14 60 06.87- 04.89 CA524IR 14 70 PS 06.87- 04.89 CA612IR 14 70 AC 06.87- 04.89 CA831IR 14 90		06.87- 04.89 CS310 12 0.9
	[F3N722]	03.86- 12.95 CA372IR 14 60 03.86- 12.95 CA524IR 14 70 PS 03.86- 12.95 CA612IR 14 70 AC 03.86- 12.95 CA831IR 14 90		AT 03.86- 12.94 CS684 12 1.7 03.86- 11.89 CS310 12 0.9 06.86- 12.95 CS681 12 1.1
	[F3N723]	03.86- 12.95 CA372IR 14 60 03.86- 12.95 CA524IR 14 70 PS 03.86- 12.95 CA612IR 14 70 AC 03.86- 12.95 CA831IR 14 90		03.86- 11.89 CS310 12 0.9 06.86- 12.95 CS681 12 1.1 AT 03.86- 12.94 CS684 12 1.7
	[F3N726]	03.86- 12.95 CA372IR 14 60 03.86- 12.95 CA524IR 14 70 PS 03.86- 12.95 CA612IR 14 70 AC 03.86- 12.95 CA831IR 14 90		09.89- 12.95 CS681 12 1.1 03.86- 11.89 CS310 12 0.9
R21 1.9 Diesel	[F8Q710]	03.86- 08.94 CA602IR 14 70 03.86- 08.94 CA838IR 14 90		03.86- 08.94 CS684 12 1.7
R21 2.0	[J6R758]	03.86- 10.93 CA378IR 14 60 03.86- 03.93 CA526IR 14 70 05.91- 10.93 CA229IR 14 70 AC 03.86- 10.93 CA535IR 14 105		03.86- 10.93 CS317 12 1.05
	[J6R759]	03.86- 03.93 CA378IR 14 60 03.86- 03.93 CA526IR 14 70 AC 03.86- 03.93 CA535IR 14 105		03.86- 03.93 CS317 12 1.05
	[J6R792]	03.86- 05.93 CA378IR 14 60 03.86- 05.93 CA526IR 14 70 AC 03.86- 05.93 CA535IR 14 105		03.86- 05.93 CS317 12 1.05
	[J6R793]	03.86- 03.93 CA378IR 14 60 03.86- 03.93 CA526IR 14 70 AC 03.86- 03.93 CA535IR 14 105		03.86- 03.93 CS317 12 1.05
	[J7R740]	09.89- 02.94 CA378IR 14 60 09.89- 06.94 CA534IR 14 90 02.90- 06.94 CA526IR 14 70 AC 09.89- 06.94 CA535IR 14 105		A13 09.89- 06.94 CS523 12 2.2 09.89- 06.94 CS317 12 1.05



	[J7R746]	03.86- 12.94 CA378IR 14 60	A13 03.86- 12.94 CS523 12 2.2	
		03.86- 12.93 CA526IR 14 70	03.86- 12.94 CS317 12 1.05	
		03.86- 12.94 CA534IR 14 90		
		03.86- 12.93 CA535IR 14 105		
		AC 03.86- 12.94 CA535IR 14 105		
	[J7R747]	03.86- 12.94 CA378IR 14 60	03.86- 12.94 CS317 12 1.05	
		03.86- 12.93 CA526IR 14 70	A13 03.86- 12.94 CS523 12 2.2	
		03.86- 12.94 CA534IR 14 90		
		03.86- 12.93 CA535IR 14 105		
		AC 03.86- 12.94 CA535IR 14 105		
	[J7R750]	03.86- 03.93 CA378IR 14 60	A13 03.86- 03.93 CS523 12 2.2	
		03.86- 03.93 CA526IR 14 70	03.86- 03.93 CS317 12 1.05	
		09.86- 03.93 CA534IR 14 90		
		07.89- 06.92 CA229IR 14 70		
		AC 03.86- 03.93 CA535IR 14 105		
	[J7R751]	03.86- 03.93 CA378IR 14 60	A13 03.86- 03.93 CS523 12 2.2	
		03.86- 03.93 CA526IR 14 70	03.86- 03.93 CS317 12 1.05	
		09.86- 03.93 CA534IR 14 90		
		AC 03.86- 03.93 CA535IR 14 105		
		AC 04.86- 06.89 CA535IR 14 105	04.86- 06.89 CS317 12 1.05	
		04.86- 06.89 CA526IR 14 70		
		04.86- 06.89 CA378IR 14 60		
R21 2.0 4x4	[J7R740]	12.89- 02.94 CA526IR 14 70	A13 12.89- 02.94 CS523 12 2.2	
		12.89- 02.94 CA534IR 14 90	12.89- 02.94 CS317 12 1.05	
		AC 12.89- 02.94 CA535IR 14 105		
		[J7R746]	AC 06.90- 12.95 CA535IR 14 105	A13 06.90- 12.95 CS523 12 2.2
		[J7R747]	AC 06.90- 12.95 CA535IR 14 105	A13 06.90- 12.95 CS523 12 2.2
R21 2.0 Turbo	[J7R752]	04.87- 03.92 CA526IR 14 70	04.87- 03.92 CS317 12 1.05	
		04.87- 03.92 CA534IR 14 90	A13 04.87- 03.92 CS523 12 2.2	
		AC 04.87- 03.92 CA535IR 14 105		
		[J7R756]	02.90- 10.92 CA534IR 14 90	02.90- 10.92 CS317 12 1.05
		AC 02.90- 10.92 CA535IR 14 105	A13 02.90- 10.92 CS523 12 2.2	
R21 2.0 Turbo 4x4	[J7R752]	08.89- 10.93 CA526IR 14 70	08.89- 10.93 CS317 12 1.05	
		08.89- 10.93 CA534IR 14 90	A13 08.89- 10.93 CS523 12 2.2	
		AC 08.89- 10.93 CA535IR 14 105		
		[J7R756]	02.90- 10.92 CA534IR 14 90	02.90- 10.92 CS317 12 1.05
		AC 02.90- 10.92 CA535IR 14 105	A13 02.90- 10.92 CS523 12 2.2	
R21 2.1 Diesel	[J8S600]	04.92- 12.95 CA526IR 14 70	04.92- 12.95 CS353 12 3.1	
		AC 04.92- 12.95 CA535IR 14 105		
		[J8S704]	03.86- 12.95 CA378IR 14 60	06.86- 08.94 CS338 12 2.5
		03.86- 12.95 CA526IR 14 70	03.86- 12.95 CS353 12 3.1	
		06.86- 08.94 CA535IR 14 105		
		AC 03.86- 12.95 CA535IR 14 105		
	[J8S740]	05.89- 12.95 CA526IR 14 70	05.89- 12.95 CS353 12 3.1	
		AC 05.89- 12.95 CA535IR 14 105		
	[J8S784]	02.92- 09.95 CA526IR 14 70	02.92- 09.95 CS353 12 3.1	
		AC 02.92- 09.95 CA535IR 14 105		
R21 2.1 Diesel 4x4	[J8S704]	10.88- 05.92 CA378IR 14 60	10.88- 05.92 CS353 12 3.1	
		10.88- 05.92 CA526IR 14 70		
		AC 10.88- 05.92 CA535IR 14 105		
R21 2.1 TD	[J8S704]	04.86- 06.89 CA378IR 14 60	04.86- 06.89 CS353 12 3.1	
		04.86- 06.89 CA526IR 14 70		
		AC 04.86- 06.89 CA535IR 14 105		
	[J8S714]	03.86- 03.93 CA378IR 14 60	03.86- 03.93 CS353 12 3.1	
		07.89- 03.93 CA526IR 14 70		
		AC 03.86- 03.93 CA535IR 14 105		
	[J8S786]	06.91- 12.95 CA378IR 14 60	06.91- 12.95 CS353 12 3.1	
		06.91- 12.95 CA526IR 14 70		
		AC 06.91- 12.95 CA535IR 14 105		
	[J8S788]	09.89- 03.93 CA378IR 14 60	09.89- 12.95 CS353 12 3.1	
	09.89- 12.95 CA526IR 14 70			
	AC 09.89- 12.95 CA535IR 14 105			
R21 2.2	[J7T754]	07.86- 12.95 CA378IR 14 60	A13 07.86- 12.95 CS523 12 2.2	
		AC 07.86- 12.95 CA535IR 14 105	07.86- 12.95 CS317 12 1.05	
		[J7T755]	07.86- 12.95 CA378IR 14 60	A13 07.86- 12.95 CS523 12 2.2
	AC 07.86- 12.95 CA535IR 14 105	07.86- 12.95 CS317 12 1.05		
R21 2.2 4x4	[J7T754]	06.86- 06.94 CA378IR 14 60	06.86- 06.94 CS317 12 1.05	
		AC 06.86- 06.94 CA535IR 14 105	A13 06.86- 06.94 CS523 12 2.2	
		[J7T755]	06.86- 06.94 CA378IR 14 60	A13 06.86- 06.94 CS523 12 2.2
	AC 06.86- 06.94 CA535IR 14 105	06.86- 06.94 CS317 12 1.05		
R25 2.0	[J6R706]	04.84- 12.92 CA378IR 14 60	04.84- 12.92 CS317 12 1.05	
		AC 04.84- 12.92 CA535IR 14 105		
	[J6R707]	04.84- 12.92 CA378IR 14 60	04.84- 12.92 CS317 12 1.05	
		AC 04.84- 12.92 CA535IR 14 105		
	[J6R760]	04.84- 12.92 CA378IR 14 60	04.84- 12.92 CS317 12 1.05	
		AC 04.84- 12.92 CA535IR 14 105		
	[J6R762]	04.84- 12.92 CA378IR 14 60	04.84- 12.92 CS317 12 1.05	
		AC 04.84- 12.92 CA535IR 14 105		
R25 2.0 12V	[J7R720]	06.88- 12.93 CA229IR 14 70	06.88- 12.93 CS317 12 1.05	
		06.88- 12.93 CA378IR 14 60		
		AC 06.88- 12.93 CA535IR 14 105		
	[J7R721]	06.88- 12.93 CA229IR 14 70	06.88- 12.93 CS317 12 1.05	
		06.88- 12.93 CA378IR 14 60		
	AC 06.88- 12.93 CA535IR 14 105			
R25 2.1 Diesel	[J8S706]	04.84- 05.89 CA378IR 14 60	04.84- 05.89 CS338 12 2.5	
		04.84- 05.89 CA526IR 14 70	04.84- 05.89 CS353 12 3.1	
		AC 04.84- 05.89 CA535IR 14 105		
	[J8S736]	06.89- 12.92 CA378IR 14 60	06.89- 12.92 CS353 12 3.1	
		06.89- 12.92 CA526IR 14 70	06.89- 12.92 CS338 12 2.5	
	AC 06.89- 12.92 CA535IR 14 105			
R25 2.1 TD	[J8S708]	04.84- 12.92 CA378IR 14 60	04.84- 12.92 CS338 12 2.5	
		04.84- 12.92 CA526IR 14 70	04.84- 12.92 CS353 12 3.1	
		AC 04.84- 12.92 CA535IR 14 105		
	[J8S738]	06.89- 12.92 CA526IR 14 70	06.89- 12.92 CS353 12 3.1	
	AC 06.89- 12.92 CA535IR 14 105	06.89- 12.92 CS338 12 2.5		
R25 2.2	[J7T706]	01.84- 06.92 CA229IR 14 70	01.84- 06.92 CS317 12 1.05	
		01.84- 06.92 CA526IR 14 70		
		AC 01.84- 06.92 CA535IR 14 105		



RENAULT Continued

	[J7T707]	01.84- 06.92 CA229IR 14 70 01.84- 06.92 CA526IR 14 70 AC 01.84- 06.92 CA535IR 14 105		01.84- 06.92 CS317 12 1.05
	[J7T708]	10.85- 10.86 CA229IR 14 70 10.85- 10.86 CA526IR 14 70 AC 10.85- 10.86 CA535IR 14 105		10.85- 10.86 CS317 12 1.05
	[J7T714]	01.84- 06.92 CA229IR 14 70 01.84- 06.92 CA526IR 14 70 AC 01.84- 06.92 CA535IR 14 105		01.84- 06.92 CS317 12 1.05
	[J7T715]	01.84- 06.92 CA229IR 14 70 01.84- 06.92 CA526IR 14 70 AC 01.84- 06.92 CA535IR 14 105		04.84- 06.92 CS317 12 1.05
	[J7T730]	04.84- 12.89 CA229IR 14 70 04.84- 12.89 CA526IR 14 70 AC 04.84- 12.89 CA535IR 14 105		04.84- 12.89 CS317 12 1.05
	[J7T731]	04.84- 12.89 CA229IR 14 70 04.84- 12.89 CA526IR 14 70 AC 04.84- 12.89 CA535IR 14 105		04.84- 12.89 CS317 12 1.05
	[J7T732]	11.85- 12.92 CA229IR 14 70 11.85- 12.92 CA526IR 14 70 AC 11.85- 12.92 CA535IR 14 105		11.85- 12.92 CS317 12 1.05
	[J7T733]	09.86- 12.92 CA229IR 14 70 09.86- 12.92 CA526IR 14 70 AC 09.86- 12.92 CA535IR 14 105		09.86- 12.92 CS317 12 1.05
R25 2.5 Turbo V6	[Z7U700]	01.90- 12.92 CA380IR 14 70 01.90- 12.92 CA534IR 14 90 01.90- 12.92 CA579IR 14 105		01.90- 12.92 CS280 12 1.1
	[Z7U702]	10.84- 05.90 CA534IR 14 90 10.84- 05.90 CA579IR 14 105		10.84- 05.90 CS280 12 1.1
R25 2.6 i V6	[Z7V708]	04.84- 08.89 CA534IR 14 90 04.84- 08.89 CA579IR 14 105		04.84- 08.89 CS280 12 1.1
	[Z7V709]	04.84- 08.89 CA534IR 14 90 04.84- 08.89 CA579IR 14 105		04.84- 08.89 CS280 12 1.1
	[Z7V711]	04.84- 08.89 CA534IR 14 90 04.84- 08.89 CA579IR 14 105		04.84- 08.89 CS280 12 1.1
R25 2.8 i V6	[Z7W702]	09.86- 06.87 CA534IR 14 90 09.86- 06.87 CA579IR 14 105		09.86- 06.87 CS280 12 1.1
R25 2.9	[Z7W700]	06.87- 02.90 CA534IR 14 90 06.87- 02.90 CA579IR 14 105 AC 06.87- 02.90 CA579IR 14 105		06.87- 02.90 CS280 12 1.1
R25 2.9 i	[Z7W706]	09.87- 12.92 CA534IR 14 90 09.87- 12.92 CA579IR 14 105 AC 09.87- 12.92 CA579IR 14 105		09.87- 12.92 CS280 12 1.1
	[Z7W707]	09.87- 12.92 CA534IR 14 90 09.87- 12.92 CA579IR 14 105 AC 09.87- 12.92 CA579IR 14 105		09.87- 12.92 CS280 12 1.1
	[Z7W709]	09.87- 12.92 CA534IR 14 90 09.87- 12.92 CA579IR 14 105 AC 09.87- 12.92 CA579IR 14 105		09.87- 12.92 CS280 12 1.1
R30 2.1 TD	[J8S702]	02.82- 03.86 CA378IR 14 60 02.82- 03.86 CA526IR 14 70		02.82- 03.86 CS338 12 2.5 02.82- 03.86 CS353 12 3.1
R30 2.6	[112] [140]	02.75- 08.78 CA268IR 14 50 10.78- 12.83 CA268IR 14 50		02.75- 08.78 CS280 12 1.1 10.78- 12.83 CS280 12 1.1
R30 2.7 TS	[144]	07.78- 01.84 CA268IR 14 50		07.78- 01.84 CS280 12 1.1
R4 0.8	[800] [80001] [800705] [B1B707]			04.68- 09.83 CS94 12 0.6 09.66- 12.88 CS94 12 0.6 04.68- 12.93 CS94 12 0.6 04.83- 12.93 CS94 12 0.6
R4 1.0	[C1C708]	10.86- 12.93 CA361IR 14 50		10.86- 12.93 CS95 12 0.6
R4 1.1	[688711]  [688712] [C1E714] [C1E718] [C1E719]	10.75- 07.89 CA361IR 14 50  10.76- 12.93 CA361IR 14 50 10.76- 12.93 CA361IR 14 50 10.76- 12.93 CA361IR 14 50 06.78- 12.93 CA361IR 14 50		12.81- 07.89 CS315 12 0.9 10.75- 11.81 CS95 12 0.6 10.76- 11.81 CS95 12 0.6 12.81- 12.93 CS315 12 0.9 12.81- 12.93 CS315 12 0.9 10.76- 11.81 CS95 12 0.6 12.81- 12.93 CS315 12 0.9 06.78- 11.81 CS95 12 0.6
		02.78- 03.84 CA361IR 14 50		02.78- 03.84 CS315 12 0.9
R5 0.8	[800710]			01.82- 12.84 CS94 12 0.6
R5 1.0	[689710] [C1C700]	01.72- 12.85 CA169IR 14 50 10.84- 12.96 CA317IR 14 50 10.84- 12.96 CA375IR 14 60		01.72- 12.85 CS95 12 0.6 10.84- 12.96 CS681 12 1.1 10.84- 12.96 CS310 12 0.9
R5 1.1	[688713] [C1E726] [C1E750]  [C1E752]  [C1E754]  [C1E756]  [C1E760]	09.80- 12.85 CA169IR 14 50 10.79- 12.85 CA169IR 14 50 10.84- 12.96 CA317IR 14 50 10.84- 12.96 CA375IR 14 60 10.84- 06.89 CA317IR 14 50 10.84- 06.89 CA375IR 14 60 10.84- 06.89 CA317IR 14 50 10.84- 06.89 CA375IR 14 60 06.87- 08.90 CA317IR 14 50 06.87- 08.90 CA375IR 14 60 01.86- 03.95 CA317IR 14 50 01.86- 03.95 CA375IR 14 60		09.80- 12.85 CS95 12 0.6 10.79- 12.85 CS315 12 0.9 10.84- 12.96 CS681 12 1.1 10.84- 12.96 CS310 12 0.9 10.84- 06.89 CS681 12 1.1 10.84- 06.89 CS310 12 0.9 10.84- 06.89 CS681 12 1.1 10.84- 06.89 CS310 12 0.9 06.87- 08.90 CS310 12 0.9 06.87- 08.90 CS681 12 1.1 01.86- 03.95 CS310 12 0.9 01.86- 03.95 CS681 12 1.1
R5 1.3	[810719] [810725] [810726] [810729]	06.79- 09.84 CA169IR 14 50 09.75- 09.84 CA169IR 14 50 09.76- 09.79 CA169IR 14 50 06.79- 09.84 CA169IR 14 50		06.79- 09.84 CS95 12 0.6 09.75- 09.84 CS95 12 0.6 09.76- 09.79 CS95 12 0.6 06.79- 09.84 CS95 12 0.6
R5 1.4	[847712] [847725] [C1J768]  [C1J780]  [C2J700]  [C2J713] [C2J780]  [C2J781]	06.82- 09.84 CA169IR 14 50 01.82- 12.85 CA169IR 14 50 10.84- 12.96 CA317IR 14 50 10.84- 12.96 CA375IR 14 60 10.84- 06.89 CA317IR 14 50 10.84- 06.89 CA375IR 14 60 06.87- 12.96 CA317IR 14 50 06.87- 12.96 CA375IR 14 60 01.82- 12.85 CA169IR 14 50 10.84- 06.87 CA317IR 14 50 10.84- 06.87 CA375IR 14 60 10.84- 12.96 CA317IR 14 50 10.84- 12.96 CA375IR 14 60		06.82- 09.84 CS315 12 0.9 01.82- 12.85 CS95 12 0.6 10.84- 12.96 CS310 12 0.9 10.84- 12.96 CS681 12 1.1 10.84- 06.89 CS681 12 1.1 10.84- 06.89 CS310 12 0.9 06.87- 12.96 CS681 12 1.1 06.87- 12.96 CS310 12 0.9 01.82- 12.85 CS95 12 0.6 10.84- 06.87 CS681 12 1.1 10.84- 06.87 CS310 12 0.9 10.84- 12.96 CS681 12 1.1 10.84- 12.96 CS310 12 0.9



	[C2J782]	06.87- 12.96	CA3171R	14 50	06.87- 12.96	CS681	12 1.1
		06.87- 12.96	CA3751R	14 60	06.87- 12.96	CS310	12 0.9
	[C2J784]	06.87- 12.96	CA3171R	14 50	06.87- 12.96	CS310	12 0.9
		06.87- 12.96	CA3751R	14 60	06.87- 12.96	CS681	12 1.1
	[C2J788]	10.84- 12.96	CA3171R	14 50	10.84- 12.96	CS310	12 0.9
		10.84- 12.96	CA3751R	14 60	10.84- 12.96	CS681	12 1.1
	[C2J789]	10.84- 12.96	CA3171R	14 50	10.84- 12.96	CS681	12 1.1
		10.84- 12.96	CA3751R	14 60	10.84- 12.96	CS310	12 0.9
	[C2J798]	10.84- 07.89	CA3171R	14 50	10.84- 07.89	CS681	12 1.1
		10.84- 07.89	CA3751R	14 60	10.84- 07.89	CS310	12 0.9
	[C3J700]	10.84- 10.87	CA3171R	14 50	10.84- 10.87	CS310	12 0.9
		10.84- 10.87	CA3751R	14 60			
	[C3J702]	10.85- 02.88	CA3171R	14 50	10.85- 02.88	CS310	12 0.9
		10.85- 02.88	CA3751R	14 60			
	[C3J760]	10.85- 12.96	CA3171R	14 50	10.85- 12.96	CS310	12 0.9
		10.85- 12.96	CA3751R	14 60			
		09.80- 03.85	CA1691R	14 50	09.80- 03.85	CS315	12 0.9
R5 1.4 Alpine A5	[840725]	09.77- 09.81	CA1691R	14 50	09.77- 09.81	CS315	12 0.9
R5 1.4 Turbo	[840730]	06.80- 01.85	CA1691R	14 50	06.80- 01.85	CS315	12 0.9
R5 1.4 Turbo Alpine	[840726]	10.81- 01.85	CA1691R	14 50	10.81- 01.85	CS315	12 0.9
	[C6J750]	10.81- 01.85	CA1691R	14 50	10.81- 01.85	CS315	12 0.9
R5 1.4 Turbo GT	[C1J782]	04.84- 08.90	CA7281R#	14 70	04.84- 08.90	CS310	12 0.9
		10.84- 08.90	CA3751R	14 60			
	[C1J784]	10.84- 12.96	CA3751R	14 60	10.84- 12.96	CS310	12 0.9
		10.84- 12.96	CA7281R#	14 70			
	[C1J788]	06.87- 12.96	CA3751R	14 60	06.87- 12.96	CS310	12 0.9
		06.87- 12.96	CA7281R#	14 70			
R5 1.6 Diesel	[F8M720]	10.87- 12.96	CA5571R	14 50	10.87- 12.96	CS354	12 1.7
	[F8M730]	10.87- 12.96	CA5571R	14 50	10.87- 12.96	CS354	12 1.7
R5 1.7	[F2N740]	06.87- 12.96	CA5801R	14 50	06.87- 12.96	CS681	12 1.1
	[F2N742]	06.87- 12.96	CA5801R	14 50	06.87- 12.96	CS681	12 1.1
	[F3N702]	10.86- 12.96	CA5801R	14 50	10.86- 12.96	CS681	12 1.1
		PS 10.86- 12.96	CA6071R	14 70			
	[F3N716]	10.86- 12.96	CA5801R	14 50	10.86- 12.96	CS681	12 1.1
		PS 10.86- 12.96	CA6071R	14 70			
	[F3N717]	10.86- 12.96	CA5801R	14 50	10.86- 12.96	CS681	12 1.1
		PS 10.86- 12.96	CA6071R	14 70			
	[F3N722]	10.86- 12.96	CA5801R	14 50	10.86- 12.96	CS681	12 1.1
		PS 10.86- 12.96	CA6071R	14 70			
R9 1.1	[C1E715]	09.81- 10.84	CA2881R	14 50	09.81- 10.87	CS310	12 0.9
		09.81- 10.84	CA5121R	14 60			
		10.84- 10.87	CA3171R	14 50			
		10.84- 10.87	CA3751R	14 60			
		10.84- 10.87	CA7281R#	14 70			
	[C1E720]	09.81- 10.84	CA2881R	14 50	09.81- 10.87	CS310	12 0.9
		09.81- 10.84	CA5121R	14 60			
		10.84- 10.87	CA3171R	14 50			
		10.84- 10.87	CA3751R	14 60			
		10.84- 10.87	CA7281R#	14 70			
R9 1.2	[C1G700]	09.85- 12.86	CA3171R	14 50	09.85- 12.86	CS310	12 0.9
		09.85- 12.86	CA3751R	14 60			
		09.85- 12.86	CA7281R#	14 70			
	[C1G710]	09.86- 03.91	CA3171R	14 50	09.86- 03.91	CS310	12 0.9
		09.86- 03.91	CA3751R	14 60			
		09.86- 03.91	CA7281R#	14 70			
R9 1.4	[C1J715]	12.81- 10.84	CA2881R	14 50	12.81- 03.91	CS310	12 0.9
		12.81- 10.84	CA5121R	14 60			
		10.84- 03.91	CA3171R	14 50			
		10.84- 03.91	CA3751R	14 60			
		10.84- 03.91	CA7281R#	14 70			
	[C1J792]	12.81- 10.84	CA2881R	14 50	12.81- 03.91	CS310	12 0.9
		12.81- 10.84	CA5121R	14 60			
		10.84- 03.91	CA3171R	14 50			
		10.84- 03.91	CA3751R	14 60			
		10.84- 03.91	CA7281R#	14 70			
	[C1J796]	12.81- 10.84	CA2881R	14 50	12.81- 03.91	CS310	12 0.9
		12.81- 10.84	CA5121R	14 60			
		10.84- 03.91	CA3171R	14 50			
		10.84- 03.91	CA3751R	14 60			
		10.84- 03.91	CA7281R#	14 70			
	[C2J717]	09.81- 10.84	CA2881R	14 50	09.81- 03.91	CS310	12 0.9
		09.81- 10.84	CA5121R	14 60			
		10.84- 03.91	CA3171R	14 50			
		10.84- 03.91	CA3751R	14 60			
		10.84- 03.91	CA7281R#	14 70			
	[C2J718]	09.81- 10.84	CA2881R	14 50	09.81- 03.91	CS310	12 0.9
		09.81- 10.84	CA5121R	14 60			
		10.84- 03.91	CA3171R	14 50			
		10.84- 03.91	CA3751R	14 60			
		10.84- 03.91	CA7281R#	14 70			
	[C2J720]	10.86- 06.87	CA3171R	14 50	10.86- 06.87	CS310	12 0.9
		10.86- 06.87	CA3751R	14 60			
		10.86- 06.87	CA7281R#	14 70			
	[C2J730]	10.86- 03.91	CA3171R	14 50	10.86- 03.91	CS310	12 0.9
		10.86- 03.91	CA3751R	14 60			
		10.86- 03.91	CA7281R#	14 70			
	[C2J755]	09.81- 10.84	CA2881R	14 50	09.81- 03.91	CS310	12 0.9
		09.81- 10.84	CA5121R	14 60			
		10.84- 03.91	CA3171R	14 50			
		10.84- 03.91	CA3751R	14 60			
		10.84- 03.91	CA7281R#	14 70			
	[C2J757]	09.81- 10.84	CA2881R	14 50	09.81- 10.84	CS310	12 0.9
		09.81- 10.84	CA5121R	14 60			
	[C2J766]	10.84- 03.91	CA3171R	14 50	10.84- 03.91	CS310	12 0.9
		10.84- 03.91	CA3751R	14 60			
		10.84- 03.91	CA7281R#	14 70			
	[C2J767]	10.84- 03.91	CA3171R	14 50	10.84- 03.91	CS310	12 0.9
		10.84- 03.91	CA3751R	14 60			
		10.84- 03.91	CA7281R#	14 70			
	[C2J768]	09.85- 03.91	CA3171R	14 50	09.85- 03.91	CS310	12 0.9
		09.85- 03.91	CA3751R	14 60			
		09.85- 03.91	CA7281R#	14 70			

**RENAULT** *Continued*

R9 1.4 Turbo	[C1J760]	10.84- 03.91 CA3171R	14 50	10.84- 03.91	CS310	12 0.9	
		10.84- 03.91 CA3751R	14 60				
		10.84- 03.91 CA7281R#	14 70				
	[C1J764]	10.84- 03.91 CA3171R	14 50	10.84- 03.91	CS310	12 0.9	
		10.84- 03.91 CA3751R	14 60				
		10.84- 03.91 CA7281R#	14 70				
R9 1.6 Diesel	[F8M700]	10.82- 09.86 CA3731R	14 60	10.82- 12.92	CS354	12 1.7	
		10.86- 12.92 CA5291R	14 60				
	[F8M720]	10.82- 09.86 CA3731R	14 60	10.82- 03.91	CS354	12 1.7	
		10.86- 03.91 CA5291R	14 60				
	[F8M730]	10.82- 09.86 CA3731R	14 60	10.82- 12.92	CS354	12 1.7	
		10.86- 12.92 CA5291R	14 60				
R9 1.7	[F2N708]	10.86- 03.91 CA3721R	14 60	10.86- 03.91	CS310	12 0.9	
		PS 10.86- 03.91 CA6121R	14 70				
	[F2N710]	10.86- 03.91 CA3721R	14 60	10.86- 03.91	CS310	12 0.9	
		PS 10.86- 03.91 CA6121R	14 70				
	[F2N730]	10.86- 03.91 CA3721R	14 60	10.86- 03.91	CS310	12 0.9	
		PS 10.86- 03.91 CA6121R	14 70				
	[F2N798]	10.86- 03.91 CA3721R	14 60	10.86- 12.88	CS310	12 0.9	
		PS 10.86- 03.91 CA6121R	14 70				
	[F3N708]	06.87- 12.88 CA3721R	14 60	06.87- 12.88	CS310	12 0.9	
		PS 06.87- 12.88 CA6121R	14 70				
	[F3N718]	10.86- 03.91 CA3721R	14 60	10.86- 03.91	CS681	12 1.1	
		PS 10.86- 03.91 CA6121R	14 70				
	R9 1.7 TXE	[F2N700]	09.84- 06.87 CA3721R	14 60	09.84- 06.87	CS310	12 0.9
			PS 09.84- 06.87 CA6121R	14 70			
[F2N704]		09.84- 06.87 CA3721R	14 60	09.84- 06.87	CS310	12 0.9	
		PS 09.84- 06.87 CA6121R	14 70				
Rapid 1.0	[C1C706]	09.85- 08.91 CA3751R	14 60	09.85- 05.92	CS310	12 0.9	
Rapid 1.1	[C1E750]	09.85- 04.95 CA3751R	14 60	09.85- 04.95	CS310	12 0.9	
		03.86- 04.95 CA3171R	14 50				
	[C1E752]	03.86- 06.89 CA3171R	14 50	03.86- 06.89	CS310	12 0.9	
		03.86- 06.89 CA3751R	14 60				
	[C1E754]	03.86- 08.91 CA3171R	14 50	03.86- 08.91	CS310	12 0.9	
		03.86- 08.91 CA3751R	14 60				
	[C1E756]	06.87- 08.91 CA3171R	14 50	06.87- 08.91	CS310	12 0.9	
	[C1E760]	08.90- 08.91 CA3171R	14 50	08.90- 08.91	CS310	12 0.9	
	[C1E762]	09.91- 09.96 CA3171R	14 50	09.91- 09.96	CS310	12 0.9	
		09.91- 09.96 CA3751R	14 60				
[C1E792]	03.86- 08.91 CA3171R	14 50	03.86- 08.91	CS310	12 0.9		
Rapid 1.2	[C3G710]	09.91- 10.97 CA3171R	14 50	09.91- 10.97	CS681	12 1.1	
		09.91- 10.97 CA3751R	14 60				
	[C3G712]	09.91- 10.97 CA3171R	14 50	09.91- 10.97	CS681	12 1.1	
		09.91- 10.97 CA3751R	14 60				
	[E7F708]	05.95- 11.98 CA3171R	14 50	05.95- 11.98	CS310	12 0.9	
		05.95- 11.98 CA3751R	14 60				
Rapid 1.4	[C1J768]	07.85- 08.91 CA3171R	14 50	07.85- 08.91	CS310	12 0.9	
		07.85- 08.91 CA3751R	14 60				
	[C1J780]	07.85- 08.91 CA3171R	14 50	07.85- 08.91	CS310	12 0.9	
		07.85- 08.91 CA3751R	14 60				
	[C2J784]	06.87- 09.97 CA3171R	14 50	06.87- 09.97	CS310	12 0.9	
		06.87- 09.97 CA3751R	14 60				
	[C3J700]	03.86- 05.87 CA3171R	14 50	03.86- 05.87	CS310	12 0.9	
		03.86- 05.87 CA3751R	14 60				
	[C3J702]	06.87- 08.91 CA3171R	14 50	06.87- 08.91	CS310	12 0.9	
		06.87- 08.91 CA3751R	14 60				
	[C3J760]	06.87- 08.91 CA3171R	14 50	08.88- 08.91	CS681	12 1.1	
		06.87- 08.91 CA3751R	14 60				
	[C3J762]	09.91- 03.97 CA3171R	14 50	09.91- 03.97	CS681	12 1.1	
		09.91- 03.97 CA3751R	14 60				
	[E7J720]	09.91- 10.97 CA5491R	14 60	09.91- 10.97	CS681	12 1.1	
		09.91- 10.97 CA6491R	14 70				
	[E7J724]	ACPS 09.91- 10.97 CA6321R	14 90	A13 09.91- 10.97	CS784	12 1.4	
		09.91- 10.97 CA5491R	14 60				
	[E7J726]	09.91- 10.97 CA6491R	14 70	09.91- 10.97	CS681	12 1.1	
		ACPS 09.91- 10.97 CA6321R	14 90				
[E7J728]	01.94- 10.97 CA5491R	14 60	01.94- 10.97	CS681	12 1.1		
	01.94- 10.97 CA6491R	14 70					
[E7J773]	03.94- 10.97 CA5491R	14 60	03.94- 10.97	CS681	12 1.1		
	03.94- 10.97 CA6491R	14 70					
[E7J773]	ACPS 03.94- 10.97 CA6321R	14 90	A13 03.94- 10.97	CS784	12 1.4		
	03.94- 10.97 CA5571R	14 50					
Rapid 1.6 Diesel	[F8M720]	03.86- 03.97 CA5571R	14 50	03.86- 08.91	CS575	12 1.7	
		09.91- 03.97 CA5571R	14 50				
	[F8M730]	03.86- 08.98 CA5571R	14 50	03.86- 08.91	CS575	12 1.7	
		09.91- 03.97 CA5571R	14 50				
	[F8M736]	09.91- 03.97 CA5571R	14 50	09.91- 03.97	CS684	12 1.7	
	[F8M760]	09.91- 03.97 CA5571R	14 50	09.91- 03.97	CS684	12 1.7	
Rapid 1.9 Diesel	[F8Q640]	09.94- 03.97 CA8491R	14 70	09.94- 03.97	CS784	12 1.4	
		PS 09.94- 03.97 CA1331R	14 80				
	[F8Q682]	04.97- 09.97 CA8491R	14 70	04.97- 09.97	CS784	12 1.4	
		09.91- 09.92 CA6351R	14 60				
	[F8Q722]	09.91- 09.92 CA8491R	14 70	09.91- 09.92	CS784	12 1.4	
		09.91- 09.92 CA8491R	14 70				
	[F8Q724]	09.91- 10.97 CA6351R	14 60	09.91- 10.97	CS784	12 1.4	
		09.91- 10.97 CA8491R	14 70				
	[F8Q774]	10.92- 09.96 CA6351R	14 60	10.92- 09.96	CS784	12 1.4	
		10.92- 09.96 CA8491R	14 70				
[F8Q776]	09.91- 03.97 CA6351R	14 60	09.91- 03.97	CS784	12 1.4		
	09.91- 03.97 CA8491R	14 70					
Rodeo 0.8 4	[80001]			10.70- 11.81	CS94	12 0.6	
Safrane 1.9 16V	[N7Q710]	09.96- 12.00 CA10561R	14 120	07.96- 12.00	CS680	12 1.4	
	[N7Q711]	09.96- 12.00 CA10561R	14 120	07.96- 12.00	CS680	12 1.4	
Safrane 2.0	[J7R732]	AC 04.92- 09.96 CA8191R	14 110	04.92- 09.96	CS791	12 1.1	
	[J7R733]	AC 04.92- 09.96 CA8191R	14 110	04.92- 09.96	CS791	12 1.1	
Safrane 2.0 12V	[J7R734]	04.92- 09.96 CA8161R	14 80	04.92- 09.96	CS791	12 1.1	
	[J7R735]	AC 04.92- 09.96 CA8191R	14 110	04.92- 09.96	CS791	12 1.1	
		04.92- 09.96 CA8161R	14 80				
[J7R735]	AC 04.92- 09.96 CA8191R	14 110					





Safrane 2.1 TD	[J8S760]	04.92- 09.96	CA818IR	14 75	04.92- 09.96	CS353	12 3.1
		AC 04.92- 09.96	CA720IR	14 110			
Safrane 2.2	[J7T760]	04.92- 09.96	CA816IR	14 80	04.92- 09.96	CS791	12 1.1
		AC 04.92- 09.96	CA819IR	14 110			
		04.92- 09.96	CA816IR	14 80	04.92- 09.96	CS791	12 1.1
		AC 04.92- 09.96	CA819IR	14 110			
		04.92- 09.96	CA816IR	14 80	04.92- 09.96	CS791	12 1.1
Safrane 2.2 TD	[G8T740]	04.92- 09.96	CA819IR	14 110	04.92- 09.96	CS791	12 1.1
		AC 04.92- 09.96	CA816IR	14 80			
Safrane 2.2 TD	[G8T740]	Chas. -970512 07.96- 12.00	CA1036IR	14 110	07.96- 12.00	CS1055	12 2.2
		Chas. 970512- 07.96- 12.00	CA1309IR	14 110			
Safrane 2.5 20V	[N7U700]	07.96- 12.00	CA1056IR	14 120	07.96- 12.00	CS680	12 1.4
		07.96- 12.00	CA1056IR	14 120	07.96- 12.00	CS680	12 1.4
Safrane 2.5 TD	[S8U762]	AC 12.92- 09.96	CA895IR	14 110	12.92- 09.96	CS782	12 2.2
		AC 12.92- 09.96	CA895IR	14 110	12.92- 09.96	CS782	12 2.2
Safrane 2.9 24V	[L7X713]	03.99- 12.00	CA1388IR	14 150	03.99- 12.00	CS1108	12 1.5
Safrane 3.0	[Z7X753]						
Safrane 3.0 Biturbo 4x4	[Z7X726]						
Safrane 3.0 V6	[Z7X721]				02.93- 09.96	CS280	12 1.1
					02.93- 09.96	CS882	12 1.1
					12.92- 09.96	CS280	12 1.1
					05.92- 09.96	CS882	12 1.1
Safrane 3.0 V6 4x4	[Z7X721]				12.92- 09.96	CS280	12 1.1
					05.92- 09.96	CS882	12 1.1
					12.92- 09.96	CS280	12 1.1
					05.92- 09.96	CS882	12 1.1
Sanderio 1.0 Hi-Flex		11.07-	CA1976IR	14 95	11.07-	CS1385	12 0.85
		11.07-	CA1637IR	14 70			
Sanderio 1.6		11.10-	CA2098IR*	14 90			
Sanderio 1.6 Hi-Flex		11.07-	CA1762IR	14 110	11.07-	CS1276	12 0.85
Scénic 1.4	[K4J730]	05.03-	CA1762IR	14 110	05.03-	CS1276	12 0.85
		05.03-	CA1823IR	14 150			
		06.03-	CA1944IR	14 150			
		05.03-	CA1762IR	14 110	05.03-	CS1276	12 0.85
Scénic 1.4 16V	[K4J714]	02.00- 04.03	CA1484IR	14 75	02.00- 04.03	CS1174	12 0.8
		AC 02.00- 04.03	CA1470IR	14 98			
		A22 02.00- 04.03	CA1771IR	14 120			
		08.98- 04.03	CA1484IR	14 75	08.98- 04.03	CS1174	12 0.8
		08.98- 04.03	CA1628IR	14 98			
		09.98- 04.03	CA1771IR	14 120			
		AC 08.98- 04.03	CA1544IR	14 85			
		A22 08.98- 04.03	CA1470IR	14 98			
Scénic 1.4 i	[E7J764]	11.96- 04.03	CA1077IR	14 75	11.96- 04.03	CS681	12 1.1
		11.96- 04.03	CA1078IR	14 110			
Scénic 1.5 DCi	[K9K722]	05.03- 12.06	CA1762IR	14 110	05.03- 12.06	CS1273	12 1.1
		05.03- 12.06	CA1823IR	14 150	05.05-	CS1332	12 1.4
		05.05-	CA1876IR	14 150			
		05.05-	CA1876IR	14 150	05.05-	CS1332	12 1.4
		05.03-	CA1762IR	14 110	05.03-	CS1332	12 1.4
		05.03-	CA1823IR	14 150			
		01.07-	CA1876IR	14 150			
		01.07-	CA2086IR*	14 210			
		05.03-	CA1762IR	14 110	05.03-	CS1332	12 1.4
		05.03-	CA1823IR	14 150			
		05.05-	CA1823IR	14 150	05.05-	CS1332	12 1.4
		05.05-	CA1876IR	14 150			
		05.05-	CA2086IR*	14 210			
		04.09-	CA1974IR	14 150	04.09-	CS1332	12 1.4
02.09-	CA1652IR	14 110	02.09-	CS1332	12 1.4		
Scénic 1.6 16V	[K4M700]	01.99- 04.03	CA1484IR	14 75	01.99- 04.03	CS1174	12 0.8
		01.99- 04.03	CA1628IR	14 98			
		01.99- 04.03	CA1771IR	14 120			
		AC 01.99- 04.03	CA1544IR	14 85			
		A22 01.99- 04.03	CA1470IR	14 98			
		08.98- 04.03	CA1484IR	14 75	08.98- 04.03	CS1174	12 0.8
		AC 08.98- 04.03	CA1544IR	14 85			
		A22 08.98- 04.03	CA1771IR	14 120			
		08.98- 04.03	CA1484IR	14 75	08.98- 04.03	CS1174	12 0.8
		AC 08.98- 04.03	CA1470IR	14 98			
		A22 08.98- 04.03	CA1771IR	14 120			
		09.00- 04.03	CA1484IR	14 75	09.00- 04.03	CS1174	12 0.8
		AC 09.00- 04.03	CA1544IR	14 85			
		A22 09.00- 04.03	CA1771IR	14 120			
Scénic 1.6 i 16V	[K4M761]	01.07-	CA1823IR	14 150	01.07-	CS1276	12 0.85
		01.07-	CA1887IR	14 120			
		01.07-	CA2043IR	14 110			
		01.07-	CA1762IR	14 110	01.07-	CS1276	12 0.85
		01.07-	CA1823IR	14 150			
		01.07-	CA2043IR	14 110			
		02.09-	CA1887IR	14 120			
		05.03-	CA1762IR	14 110	05.03-	CS1276	12 0.85
		05.03-	CA1823IR	14 150			
		06.03-	CA1944IR	14 150			
		06.03-	CA2043IR	14 110			
		05.03-	CA1823IR	14 150	05.03-	CS1276	12 0.85
		06.03-	CA1944IR	14 150			
		06.03-	CA2043IR	14 110			



RENAULT Continued

Scénic 1.6 i	[K7M702]	01.96- 04.03	CA1077IR	14 75		01.96- 04.03	CS1186	12 1.0	
		01.96- 04.03	CA1078IR	14 110		01.96- 04.03	CS681	12 1.1	
		01.96- 04.03	CA1319IR	14 110					
		01.96- 04.03	CA1333IR	14 80					
Scénic 1.6	[K4M866]	02.09-	CA1887IR	14 120					
Scénic 1.8 4x4	[F4P722]	07.00- 04.01	CA1628IR	14 98		07.00- 04.01	CS1255	12 0.9	
		07.00- 04.01	CA1771IR	14 120		07.00- 04.01	CS1179	12 0.9	
Scénic 1.8 16V	[F4P720]	11.00- 04.03	CA1771IR	14 120		11.00- 04.03	CS1179	12 0.9	
	[F4P722]	09.00- 04.03	CA1771IR	14 120		09.00- 04.03	CS1179	12 0.9	
Scénic 1.9 DCi	[F9Q732]	03.99- 04.03	CA1304IR	14 75		03.99- 04.03	CS1252	12 1.4	
		AC 03.99- 04.03	CA1572IR	14 120					
		[F9Q733]	AC 10.99- 04.03	CA1572IR	14 120		10.99- 04.03	CS1252	12 1.4
		[F9Q803]	05.05-	CA1823IR	14 150				
			05.05-	CA1918IR	14 150				
		[F9Q804]	06.03-	CA1628IR	14 98		06.03-	CS1193	12 1.8
			06.03-	CA1767IR	14 155 A35				
			06.03-	CA1768IR	14 110				
			06.03-	CA1814IR	14 125				
			05.05-	CA1827IR	14 150				
		05.05-	CA2025IR	14 155 A35					
	[F9Q812]	06.03-	CA1768IR	14 110		06.03-	CS1193	12 1.8	
		06.03-	CA1814IR	14 125					
	[F9Q870]	02.09-	CA1918IR	14 150		02.09-	CS1509*	12 1.4	
		02.09-	CA2101IR*	14 120					
Scénic 1.9 DCi RX4	[F9Q740]	06.00- 04.03	CA1304IR	14 75		06.00- 04.03	CS1252	12 1.4	
		AC 06.00- 04.03	CA1572IR	14 120					
Scénic 1.9 Diesel	[F8Q790]	09.99- 03.01	CA1304IR	14 75		09.99- 03.01	CS684	12 1.7	
		09.99- 03.01	CA1572IR	14 120					
		09.99- 03.01	CA1622IR	14 120					
Scénic 1.9 DTi	[F9Q731]	03.99- 04.03	CA1304IR	14 75		03.99- 04.03	CS784	12 1.4	
		AC 03.99- 04.03	CA1572IR	14 120		03.99- 04.03	CS684	12 1.7	
		A22 03.99- 04.03	CA1622IR	14 120					
		[F9Q734]	06.97- 02.99	CA1306IR	14 75		06.97- 02.99	CS784	12 1.4
			AC 06.97- 02.99	CA1303IR	14 120		06.97- 02.99	CS684	12 1.7
			A22 06.97- 02.99	CA1322IR	14 120				
		[F9Q736]	03.99- 04.03	CA1304IR	14 75		03.99- 04.03	CS684	12 1.7
			AC 03.99- 04.03	CA1572IR	14 120		03.99- 04.03	CS784	12 1.4
			A22 03.99- 04.03	CA1622IR	14 120				
		[F9Q744]	11.00- 04.03	CA1304IR	14 75		11.00- 04.03	CS1252	12 1.4
	AC 11.00- 04.03	CA1572IR	14 120		11.00- 04.03	CS1344	12 1.2		
	A22 11.00- 04.03	CA1622IR	14 120						
Scénic 2.0	[F4R770]	05.03-	CA1768IR	14 110		05.03-	CS1255	12 0.9	
		05.03-	CA1814IR	14 125					
		06.03-	CA2058IR*	14 120					
		[F4R771]	05.03-	CA1768IR	14 110		05.03-	CS1255	12 0.9
		05.03-	CA1814IR	14 125					
		06.03-	CA2058IR*	14 120					
Scénic 2.0 16V	[F4R740]	03.99-	CA1628IR	14 98		03.99-	CS1179	12 0.9	
		AC 03.99-	CA1470IR	14 98					
		AC 03.99-	CA1771IR	14 120					
		[F4R741]	03.99- 04.03	CA1628IR	14 98		03.99- 04.03	CS1179	12 0.9
			AC 03.99- 04.03	CA1470IR	14 98				
	AC 03.99- 04.03	CA1771IR	14 120						
	[M4R711]					02.09-	CS1418*	12 1.0	
Scénic 2.0 16V RX4	[F4R744]	06.99- 04.03	CA1628IR	14 98		06.99- 04.03	CS1179	12 0.9	
		AC 06.99- 04.03	CA1470IR	14 98					
		AC 06.99- 04.03	CA1771IR	14 120					
Scénic 2.0 i	[F3R...]	11.96- 04.03	CA1079IR	14 75		11.96- 04.03	CS681	12 1.1	
		11.96- 04.03	CA848IR	14 110					
		AC 11.96- 04.03	CA1036IR	14 110					
		AC 11.96- 04.03	CA1309IR	14 110					
Scénic 2.0 iDE 16V	[F4R740]	03.00- 08.03	CA1628IR	14 98		03.00- 08.03	CS1179	12 0.9	
		03.00- 08.03	CA1768IR	14 110					
		AC 03.00- 08.03	CA1771IR	14 120					
		[F4R741]	03.00- 08.03	CA1628IR	14 98		03.00- 08.03	CS1179	12 0.9
			03.00- 08.03	CA1768IR	14 110				
			AC 03.00- 08.03	CA1771IR	14 120				
[F4R744]	03.00- 08.03	CA1628IR	14 98		03.00- 08.03	CS1179	12 0.9		
		03.00- 08.03	CA1768IR	14 110					
		AC 03.00- 08.03	CA1771IR	14 120					
Scénic 2.0 Turbo 16V	[F4R776]	05.04-	CA1768IR	14 110		05.04-	CS1255	12 0.9	
		05.04-	CA1814IR	14 125					
		05.04-	CA2058IR*	14 120					
Scénic 2.0 DCi	[M9R610]	04.09-	CA1971IR	14 210		04.09-	CS1415	12 2.2	
	[M9R615]	02.09-	CA1971IR	14 210		02.09-	CS1415	12 2.2	
	[M9R700]	09.05-	CA1936IR	14 150		09.05-	CS1415	12 2.2	
		09.05-	CA1945IR	14 120					
Sport Spider 2.0 16V	[F7R710]	02.99- 10.99	CA1307IR#	14 110		03.95- 10.99	CS681	12 1.1	
	[F7R712]	03.95- 10.99	CA1307IR#	14 110		03.95- 10.99	CS681	12 1.1	
	[F7R720]	02.99- 10.99	CA1307IR#	14 110		03.95- 10.99	CS681	12 1.1	
Super 5 1.0	[C1C700]	10.84- 12.96	CA317IR	14 50		10.84- 12.96	CS310	12 0.9	
		10.84- 12.96	CA375IR	14 60					
Super 5 1.1	[C1E750]	10.84- 12.96	CA317IR	14 50		10.84- 12.96	CS310	12 0.9	
		10.84- 12.96	CA375IR	14 60					
		[C1E752]	10.84- 12.96	CA317IR	14 50		10.84- 12.96	CS310	12 0.9
			10.84- 12.96	CA375IR	14 60				
		[C1E754]	10.84- 12.96	CA317IR	14 50		10.84- 12.96	CS310	12 0.9
			10.84- 12.96	CA375IR	14 60				
		10.89- 12.90	CA375IR	14 60		10.89- 12.90	CS681	12 1.1	
		10.89- 12.90	CA317IR	14 50		10.89- 12.90	CS310	12 0.9	
Super 5 1.2	[C1G702]	10.84- 12.96	CA375IR	14 60		10.84- 12.96	CS310	12 0.9	
	[C1G720]	10.86- 12.96	CA375IR	14 60		10.86- 12.96	CS310	12 0.9	
	[C1G722]	03.90- 12.96	CA375IR	14 60		03.90- 12.96	CS310	12 0.9	
Super 5 1.6 Diesel	[F8M720]	10.84- 12.96	CA557IR	14 50		10.87- 12.96	CS684	12 1.7	
						10.84- 12.96	CS354	12 1.7	
		[F8M730]	04.85- 12.90	CA557IR	14 50		04.85- 12.90	CS354	12 1.7
Super 5 1.7	[F3N702]	09.88- 09.90	CA580IR	14 50		09.88- 09.90	CS681	12 1.1	
		PS 09.88- 09.90	CA607IR	14 70					
Thalia 1.2 16V	[D4F712]	04.02-	CA1637IR	14 70		04.02-	CS1057	12 0.7	
		04.02-	CA1976IR	14 95					
Thalia 1.4	[K7J700]	AC 05.01-	CA1544IR	14 85		05.01-	CS1186	12 1.0	
Thalia 1.4 16V	[K4J712]	06.01-	CA1484IR	14 75		08.00-	CS1174	12 0.8	
		AC 06.01-	CA1470IR	14 98					



Thalia 1.5 DCi	[K9K700]	09.01-	CA1652IR	14 110	09.01-	CS1273	12 1.1
		09.01-	CA1881IR	14 120			
		AC 02.03-	CA1627IR	14 125			
		AC 02.03-	CA1881IR	14 120			
Thalia 1.6 16V	[K4M734]	09.08-	CA1470IR	14 98	09.08-	CS1174	12 0.8
	[K4M740]	09.08-	CA1484IR	14 75			
Thalia 1.9 Diesel	[F8Q630]	04.02-	CA1484IR	14 75	04.02-	CS1174	12 0.8
		02.98- 05.01	CA1304IR	14 75			
Trafic 1.4	[847700]	02.98- 05.01	CA1444IR	14 110	02.98- 05.01	CS784	12 1.4
	[847701]						
Trafic 1.4	[C1J700]				03.80- 04.89	CS315	12 0.9
					03.80- 04.89	CS95	12 0.6
					03.80- 04.89	CS315	12 0.9
Trafic 1.6	[841705]	03.80- 02.89	CA170IR	14 55	03.80- 02.89	CS316	12 1.05
	[A1M705]	03.80- 06.86	CA170IR	14 55	03.80- 06.86	CS316	12 1.05
	[A1M707]	09.80- 02.89	CA170IR	14 55	09.80- 05.87	CS316	12 1.05
					05.87- 02.89	CS310	12 0.9
	[A1M708]	09.80- 02.89	CA170IR	14 55	05.87- 02.89	CS310	12 0.9
Trafic 1.6 4x4	[A1M707]	09.80- 05.87	CA170IR	14 55	09.80- 05.87	CS316	12 1.05
Trafic 1.7	[F1N720]	08.92- 10.97	CA372IR	14 60	08.92- 10.97	CS681	12 1.1
	[F1N722]	08.92- 10.97	CA524IR	14 70			
	[F1N724]	06.86- 10.97	CA372IR	14 60	06.86- 04.89	CS310	12 0.9
Trafic 1.9 DCi	[F9Q760]	06.86- 10.97	CA524IR	14 70	A13 06.86- 04.89	CS354	12 1.7
	[F9Q762]	06.86- 10.97	CA524IR	14 70	05.89- 10.97	CS681	12 1.1
Trafic 1.9 DCi 100	[F9Q760]	06.86- 10.97	CA372IR	14 60	A13 06.86- 04.89	CS354	12 1.7
	[F9Q762]	06.86- 10.97	CA524IR	14 70	06.86- 04.89	CS310	12 0.9
Trafic 1.9 DCi 80	[F9Q760]	03.80- 10.97	CA372IR	14 60	03.89- 10.97	CS681	12 1.1
	[F9Q762]	03.80- 10.97	CA524IR	14 70			
Trafic 1.9 Diesel	[F8Q606]	06.97- 05.01	CA1304IR	14 75	06.97- 05.01	CS784	12 1.4
					06.97- 05.01	CS684	12 1.7
Trafic 2.0	[829720]				03.80- 12.86	CS317	12 1.05
	[829721]				A13 09.80- 12.86	CS523	12 2.2
	[F4R720]	03.01-	CA1829IR	14 100	03.01-	CS317	12 1.05
	[F4R722]	AC 03.01-	CA1661IR	14 125			
		03.01-	CA1824IR	14 150	03.01-	CS1255	12 0.9
		03.01-	CA1829IR	14 100			
		AC 03.01-	CA1661IR	14 125			
	[J5R716]	06.86- 10.97	CA378IR	14 60	A13 06.86- 10.97	CS523	12 2.2
	[J5R722]	06.86- 04.89	CA378IR	14 60	06.86- 10.97	CS317	12 1.05
	[J5R726]	03.80- 10.97	CA378IR	14 60	A13 06.86- 04.89	CS523	12 2.2
Trafic 2.0 4x4	[J5R716]	06.86- 10.97	CA378IR	14 60	06.86- 04.89	CS317	12 1.05
	[J5R722]	03.80- 10.97	CA378IR	14 60	A13 03.80- 10.97	CS523	12 2.2
	[J5R726]	03.80- 10.97	CA378IR	14 60	A13 03.80- 10.97	CS523	12 2.2
Trafic 2.0 16V	[F4R820]	03.89- 12.91	CA378IR	14 60	03.89- 12.91	CS523	12 2.2
Trafic 2.0 DCi	[M9R780]	06.86- 10.97	CA378IR	14 60	A13 06.86- 10.97	CS523	12 2.2
	[M9R782]	06.86- 04.89	CA378IR	14 60	06.86- 10.97	CS317	12 1.05
Trafic 2.1 Diesel	[852720]	08.06-	CA1824IR	14 150	08.06-	CS1255	12 0.9
	[852750]	08.06-	CA1829IR	14 100			
Trafic 2.1 Diesel 4x4	[852750]	08.06-	CA1959IR	14 150	08.06-	CS1415	12 2.2
		08.06-	CA1959IR	14 150	08.06-	CS1415	12 2.2
Trafic 2.2	[J7T600]	03.80- 10.97	CA224IR	14 50	03.80- 10.97	CS353	12 3.1
	[J7T780]	03.80- 10.97	CA229IR	14 70	03.80- 10.97	CS338	12 2.5
		03.89- 10.97	CA378IR	14 60			
		03.89- 10.97	CA640IR	14 70			
		09.80- 10.97	CA224IR	14 50	09.80- 10.97	CS338	12 2.5
		09.80- 10.97	CA229IR	14 70	09.80- 10.97	CS353	12 3.1
		09.80- 10.97	CA378IR	14 60			
		09.80- 10.97	CA640IR	14 70			
		06.94- 04.98	CA640IR	14 70	06.94- 04.98	CS338	12 2.5
		06.94- 04.98	CA640IR	14 70	06.94- 04.98	CS353	12 3.1
		06.94- 10.97	CA640IR	14 70	06.94- 10.97	CS353	12 3.1
		06.94- 10.97	CA640IR	14 70	06.94- 10.97	CS338	12 2.5
Trafic 2.2 4x4	[J7T600]	05.86- 02.89	CA229IR	14 70	05.86- 02.89	CS353	12 3.1
	[J7T780]	05.86- 02.89	CA378IR	14 60	05.86- 02.89	CS338	12 2.5
Trafic 2.5 DCi	[G9U630]	11.86- 04.89	CA224IR	14 50	11.86- 04.89	CS338	12 2.5
	[G9U730]	11.86- 04.89	CA640IR	14 70	11.86- 04.89	CS353	12 3.1
Trafic 2.5 Diesel	[8140.61.240]	06.94- 04.98	CA640IR	14 70	06.94- 04.98	CS791	12 1.1
	[8140.67.2500]	03.89- 10.97	CA378IR	14 60	03.89- 10.97	CS317	12 1.05
	[8140.67.2550]	03.89- 10.97	CA378IR	14 60	A13 03.89- 10.97	CS523	12 2.2
	[8140.67.2580]	03.89- 10.97	CA378IR	14 60	05.89- 06.94	CS523	12 2.2
	[S8U720]	06.94- 04.98	CA640IR	14 70	06.94- 04.98	CS791	12 1.1
	[S8U722]	05.89- 09.94	CA378IR	14 60	A13 05.89- 06.94	CS523	12 2.2
		05.89- 06.94	CA378IR	14 60	05.89- 06.94	CS317	12 1.05
		05.89- 06.94	CA378IR	14 60	05.89- 06.94	CS317	12 1.05
Trafic 2.5 Diesel	[8140.61.240]	08.06-	CA1827IR	14 150	08.06-	CS1207	12 2.0
	[8140.67.2500]	08.06-	CA1877IR	14 150			
Trafic 2.5 Diesel	[8140.67.2550]	03.01- 12.06	CA1627IR	14 125	03.01- 12.06	CS1207	12 2.0
	[8140.67.2580]	03.01-	CA1661IR	14 125			
Trafic 2.5 Diesel	[8140.61.240]	AC 06.02- 12.06	CA1661IR	14 125			
	[8140.67.2500]	10.81- 04.89	CA314IR	14 75	03.80- 04.89	CS333	12 3.5
	[8140.67.2550]	03.89- 03.01	CA1339IR	14 90	03.89- 03.01	CS370	12 2.2
	[8140.67.2580]	03.89- 03.01	CA314IR	14 75			
	[S8U720]	03.89- 03.01	CA1339IR	14 90	03.89- 03.01	CS370	12 2.2
	[S8U722]	03.89- 03.01	CA314IR	14 75			
		03.89- 03.01	CA1339IR	14 90	03.89- 03.01	CS370	12 2.2
		03.89- 03.01	CA314IR	14 75			
	09.80- 02.89	CA314IR	14 75	03.80- 02.89	CS333	12 3.5	
	10.81- 04.89	CA314IR	14 75	10.81- 04.89	CS333	12 3.5	



**RENAULT** *Continued*

	[S8U750]	03.89- 03.01	CA1339IR	14 90		03.89- 03.01	CS370	12 2.2
		03.89- 03.01	CA314IR	14 75				
	[S8U752]	03.89- 03.01	CA1339IR	14 90		03.89- 03.01	CS370	12 2.2
		03.89- 03.01	CA314IR	14 75				
	[S8U758]	05.89- 05.01	CA1339IR	14 90		05.89- 05.01	CS370	12 2.2
		05.89- 05.01	CA314IR	14 75				
Trafic 2.5 Diesel 4x4	[8140.67.2500]	05.89- 03.01	CA1339IR	14 90		05.89- 03.01	CS370	12 2.2
		05.89- 03.01	CA314IR	14 75				
	[8140.67.2580]	05.89- 03.01	CA1339IR	14 90		05.89- 03.01	CS370	12 2.2
		05.89- 03.01	CA314IR	14 75				
	[814067.2500]	03.89- 10.97	CA314IR	14 75		03.89- 10.97	CS370	12 2.2
	[814067.2550]	03.89- 10.97	CA314IR	14 75		03.89- 10.97	CS370	12 2.2
	[814067.2580]	08.89- 10.97	CA314IR	14 75		03.89- 10.97	CS370	12 2.2
	[S8U750]	03.89- 03.01	CA1339IR	14 90		03.89- 03.01	CS370	12 2.2
		03.89- 03.01	CA314IR	14 75				
	[S8U752]	03.89- 03.01	CA1339IR	14 90		03.89- 03.01	CS370	12 2.2
		03.89- 03.01	CA314IR	14 75				
	[S8U758]	09.94- 05.01	CA1339IR	14 90		09.94- 05.01	CS370	12 2.2
		09.94- 05.01	CA314IR	14 75				
Twingo 1.1 100	[D4F78..]	02.11-	CA1866IR	14 90		02.11-	CS1385	12 0.85
Twingo 1.2	[C3G700]	03.93- 08.96	CA889IR	14 60		03.93- 08.96	CS980	12 0.9
		AC 03.93- 08.96	CA1059IR	14 75				
	[C3G702]	03.93- 08.97	CA889IR	14 60		03.93- 08.97	CS980	12 0.9
		AC 03.93- 08.97	CA1059IR	14 75				
	[D7F700]	09.96- 02.98	CA1253IR	14 75	DR	02.04-	CS1385	12 0.85
		02.98- 04.00	CA1298IR	14 75	VA	09.96- 02.04	CS1057	12 0.7
		07.99-	CA1637IR	14 70				
		AC 09.96- 01.98	CA1253IR	14 75	DR			
	[D7F701]	09.96- 02.98	CA1253IR	14 75	DR	02.04-	CS1385	12 0.85
		02.98- 04.00	CA1298IR	14 75	VA	09.96- 02.04	CS1057	12 0.7
		07.99-	CA1637IR	14 70				
		AC 09.96- 01.98	CA1253IR	14 75	DR			
	[D7F702]	09.98- 04.00	CA1298IR	14 75		09.98- 02.04	CS1057	12 0.7
		07.99-	CA1637IR	14 70		02.04-	CS1385	12 0.85
	[D7F703]	01.96-	CA1637IR	14 70		01.96- 02.04	CS1057	12 0.7
						02.04-	CS1385	12 0.85
	[D7F704]	05.96- 05.07	CA1637IR	14 70		05.96- 05.07	CS1057	12 0.7
		09.96- 02.98	CA1253IR	14 75	DR			
		03.98- 04.00	CA1298IR	14 75	VA			
		AC 09.96- 02.98	CA1253IR	14 75	DR			
	[D7F706]	05.00-	CA1637IR	14 70		09.98-	CS1057	12 0.7
		09.98- 04.00	CA1298IR	14 75				
	[D7F800]	03.07-	CA1866IR	14 90		03.07-	CS1385	12 0.85
		03.07-	CA2066IR*	14 85				
Twingo 1.2 16V	[D4F702]	09.00-	CA1637IR	14 70		02.04-	CS1385	12 0.85
						09.00- 02.04	CS1057	12 0.7
	[D4F704]	01.01-	CA1637IR	14 70		02.04-	CS1385	12 0.85
						09.00- 02.04	CS1057	12 0.7
	[D4F708]	08.04-	CA1637IR	14 70		08.04-	CS1385	12 0.85
	[D4F772]	03.07-	CA1866IR	14 90		03.07-	CS1385	12 0.85
		03.07-	CA2054IR	14 110				
		03.07-	CA2066IR*	14 85				
Twingo 1.2 Turbo	[D4F780]	03.07-	CA1866IR	14 90		03.07-	CS1385	12 0.85
Twingo 1.5 DCi	[K9K740]	03.07-	CA1762IR	14 110		03.07-	CS1332	12 1.4
		03.07-	CA1860IR	14 120				
		AC 03.07-	CA1948IR	14 110				
		04.08-	CA1860IR	14 120		04.08-	CS1332	12 1.4
		04.08-	CA1948IR	14 110				
Twingo 1.6 RS	[K4M754]	05.08-	CA2003IR	14 110		05.08-	CS1425	12 1.1
	[K4M854]	05.08-	CA2003IR	14 110		05.08-	CS1425	12 1.1
Vel Satis 2.0	[F4R867]	04.05-	CA1827IR	14 150		04.05-	CS1255	12 0.9
Vel Satis 2.0 Turbo 16V	[F4R762]	06.02- 12.06	CA1661IR	14 125		06.02- 12.06	CS1255	12 0.9
		06.02- 12.06	CA1824IR	14 150				
		06.02- 12.06	CA1829IR	14 100				
	[F4R763]	04.02- 12.06	CA1661IR	14 125		04.02- 12.06	CS1255	12 0.9
		04.02- 12.06	CA1824IR	14 150				
		04.02- 12.06	CA1829IR	14 100				
	[F4R766]	07.04- 12.06	CA1827IR	14 150		07.04- 12.06	CS1255	12 0.9
	[F4R767]	07.04- 12.06	CA1827IR	14 150		07.04- 12.06	CS1255	12 0.9
Vel Satis 2.0 Turbo	[F4R867]	07.05-	CA1827IR	14 150		07.05-	CS1255	12 0.9
Vel Satis 2.0 DCi	[M9R760]	08.05-	CA1959IR	14 150		08.05-	CS1415	12 2.2
Vel Satis 2.2 CDi	[G9T702]	06.02-	CA1661IR	14 125		06.02-	CS1207	12 2.0
Vel Satis 2.2 DCi	[G9T600]	04.04-	CA1824IR	14 150		04.04-	CS1288	12 2.4
						09.04- 03.05	CS1207	12 2.0
	[G9T606]	09.04-	CA1824IR	14 150		09.04- 03.05	CS1207	12 2.0
						09.04-	CS1288	12 2.4
						12.04-	CS1288	12 2.4
Wind 1.1 100	[D4F78..]	02.11-	CA1866IR	14 90		02.11-	CS1385	12 0.85
Wind 1.2	[D4F782]	07.10-	CA1866IR	14 90		07.10-	CS1385	12 0.85
Wind 1.6	[K4M854]					07.10-	CS1425	12 1.1
<b>PASSENGER CARS US</b>								
Alliance 1.4		01.83- 01.87	CA170IR	14 55		01.83- 01.87	CS310	12 0.9
Alliance 1.4 DL		01.83- 01.87	CA170IR	14 55		01.83- 01.87	CS310	12 0.9
Alliance 1.4 L		01.83- 01.87	CA170IR	14 55		01.83- 01.87	CS310	12 0.9
Alliance 1.4 Limited		01.83- 01.84	CA170IR	14 55		01.83- 01.84	CS310	12 0.9
Alliance 1.7		01.86- 01.87	CA229IR	14 70				
Alliance 1.7 DL		01.85- 01.87	CA229IR	14 70				
Alliance 1.7 GS		01.87- 01.87	CA229IR	14 70				
Alliance 1.7 L		01.85- 01.87	CA229IR	14 70				
Alliance 1.7 Limited		01.85- 01.85	CA229IR	14 70				
Encore 1.4		01.84- 01.86	CA170IR	14 55		01.84- 01.86	CS310	12 0.9
Encore 1.4 GS		01.84- 01.84	CA170IR	14 55		01.84- 01.84	CS310	12 0.9
Encore 1.4 LS		01.84- 01.86	CA170IR	14 55		01.84- 01.86	CS310	12 0.9
Encore 1.4 S		01.84- 01.86	CA170IR	14 55		01.84- 01.86	CS310	12 0.9
Encore 1.7 Electronic		01.86- 01.86	CA229IR	14 70				
Encore 1.7 GS		01.85- 01.86	CA229IR	14 70				
Encore 1.7 LS		01.85- 01.86	CA229IR	14 70				
Encore 1.7 S		01.85- 01.86	CA229IR	14 70				
Fuego 1.6		01.82- 01.83	CA170IR	14 55				
Fuego 1.6 Turbo		01.82- 01.84	CA170IR	14 55		01.82- 01.84	CS523	12 2.2
Fuego 2.2		01.84- 01.85	CA534IR	14 90		01.84- 01.85	CS523	12 2.2
						01.84- 01.85	CS317	12 1.05
Lecar 1.4		01.80- 01.83	CA169IR	14 50				
Lecar 1.4 Deluxe		01.81- 01.83	CA169IR	14 50				



R18 1.6		01.81- 01.81	CA170IR	14 55			
R18 1.6 i		01.81- 01.83	CA170IR	14 55			
R18 2.2 i Sport		01.84- 01.86	CA534IR	14 90		01.84- 01.86	CS523 12 2.2
<b>PASSENGER CARS AO</b>							
Clio 1.2		10.05-	CA2054IR	14 110			
Espace 1.9 DCi Expression [F9Q820]		04.03- 02.05	CA1767IR	14 155 A35		04.03- 02.05	CS1193 12 1.8
		04.03- 02.05	CA2025IR	14 155 A35			
Espace 2.1 Diesel RTDT Quadra [J8S772]		01.91- 05.92	CA526IR	14 70		01.91- 05.92	CS353 12 3.1
		AC 01.91- 05.92	CA535IR	14 105			
Kangoo 1.6 [K7M746]		09.99- 06.01	CA1544IR	14 85		09.99- 06.01	CS1186 12 1.0
Laguna 2.2 DCi Authentique [G9T600]		04.04- 10.05	CA1824IR	14 150		04.04- 10.05	CS1288 12 2.4
							CS1207 12 2.0
Logan 1.4 [K7J710]		09.04-	CA1470IR	14 98		09.04-	CS1442 12 0.8
		09.04-	CA1484IR	14 75		09.04-	CS1186 12 1.0
Logan 1.6 [K7M710]		09.04-	CA1470IR	14 98		09.04-	CS1442 12 0.8
		09.04-	CA1484IR	14 75		09.04-	CS1186 12 1.0
Megane 2.0 Scenic RXE 4x4 [F3R750]		05.97- 10.99	CA1079IR	14 75		05.97- 10.99	CS784 12 1.4 BO
		05.97- 10.99	CA1306IR	14 75		05.97- 10.99	CS1186 12 1.0 MI
						05.97- 10.99	CS681 12 1.1 VA
Megane 2.0 DCi Dynamic [M9R700]		09.05-	CA1945IR	14 120			
R19 1.2 [E7F730]		05.92- 09.94	CA549IR	14 60		05.92- 09.94	CS681 12 1.1
R19 1.4 [E6J700]		07.88- 08.90	CA549IR	14 60		07.88- 08.90	CS310 12 0.9
		07.88- 08.90	CA830IR	14 90		07.88- 08.90	CS681 12 1.1
	[E6J701]	07.88- 08.90	CA549IR	14 60		07.88- 08.90	CS681 12 1.1
		07.88- 08.90	CA830IR	14 90		07.88- 08.90	CS310 12 0.9
	[E7J700]	09.90- 04.92	CA549IR	14 60		09.90- 04.92	CS681 12 1.1
		09.90- 04.92	CA830IR	14 90			
R19 1.7 [F3N746]		06.89- 04.92	CA524IR	14 70		06.89- 04.92	CS681 12 1.1
		PS 06.89- 04.92	CA372IR	14 60			
R19 1.9 DT [F8Q740]		09.90- 04.92	CA602IR	14 70		09.90- 04.92	CS784 12 1.4
		AC 09.90- 04.92	CA716IR	14 110			
R19 1.9 DT [F8Q610]		09.90- 04.92	CA602IR	14 70		09.90- 04.92	CS684 12 1.7
		AC 09.90- 04.92	CA716IR	14 110			
	[F8Q740]	09.90- 04.92	CA602IR	14 70		09.90- 04.92	CS784 12 1.4
		AC 09.90- 04.92	CA716IR	14 110			
Scénic 1.6 [K4M708]		03.01- 08.03	CA1484IR	14 75		03.01- 08.03	CS1174 12 0.8
		03.01- 08.03	CA1544IR	14 85			
		03.01- 08.03	CA1628IR	14 98			
		03.01- 08.03	CA1771IR	14 120			
	[K4M709]	03.01- 08.03	CA1484IR	14 75		03.01- 08.03	CS1174 12 0.8
		03.01- 08.03	CA1544IR	14 85			
	03.01- 08.03	CA1628IR	14 98				
	03.01- 08.03	CA1771IR	14 120				
Super 5 1.4 Turbo [C1J788]		08.85- 06.89	CA317IR	14 50		08.85- 06.89	CS310 12 0.9
Thalia 1.5 DCi RT [K9K702]		06.01- 10.03	CA1762IR	14 110		06.01- 10.03	CS1273 12 1.1
		06.01- 10.03	CA1933IR	14 125			
<b>Renault V.I.</b>							
<b>PASSENGER CARS EU</b>							
110.35 2.8 (Mascott)[8140.43.B.3586]		01.99- 06.04	CA1684IR	14 90		01.99- 06.04	CS1203 12 2.3
		01.99- 06.04	CA1854IR	14 120			
	[8140.43.B.3588]	01.99- 06.04	CA1684IR	14 90		01.99- 06.04	CS1203 12 2.3
		01.99- 06.04	CA1854IR	14 120			
	[8140.43.C.2586]	01.99- 06.04	CA1684IR	14 90		01.99- 06.04	CS1203 12 2.3
	01.99- 06.04	CA1854IR	14 120				
110.50 2.8 (Mascott)[8140.43.B.3586]		01.99- 06.04	CA1684IR	14 90		01.99- 06.04	CS1203 12 2.3
		01.99- 06.04	CA1854IR	14 120			
	[8140.43.B.3588]	01.99- 06.04	CA1684IR	14 90		01.99- 06.04	CS1203 12 2.3
		01.99- 06.04	CA1854IR	14 120			
	[8140.43.C.2586]	01.99- 06.04	CA1684IR	14 90		01.99- 06.04	CS1203 12 2.3
	01.99- 06.04	CA1854IR	14 120				
110.55 2.8 (Mascott)[8140.43.B.3586]		01.99- 06.04	CA1684IR	14 90		01.99- 06.04	CS1203 12 2.3
		01.99- 06.04	CA1854IR	14 120			
	[8140.43.B.3588]	01.99- 06.04	CA1684IR	14 90		01.99- 06.04	CS1203 12 2.3
		01.99- 06.04	CA1854IR	14 120			
	[8140.43.C.2586]	01.99- 06.04	CA1684IR	14 90		01.99- 06.04	CS1203 12 2.3
	01.99- 06.04	CA1854IR	14 120				
110.60 2.8 (Mascott)[8140.43.B.3586]		01.99- 06.04	CA1684IR	14 90		01.99- 06.04	CS1203 12 2.3
		01.99- 06.04	CA1854IR	14 120			
	[8140.43.B.3588]	01.99- 06.04	CA1684IR	14 90		01.99- 06.04	CS1203 12 2.3
		01.99- 06.04	CA1854IR	14 120			
	[8140.43.C.2586]	01.99- 06.04	CA1684IR	14 90		01.99- 06.04	CS1203 12 2.3
	01.99- 06.04	CA1854IR	14 120				
120.35 3.0 (Mascott)[DXi3] [ZD3A600]		05.04-	CA2081IR*	14 120		05.04-	CS1491* 12 2.5
		05.04-	CA2082IR*	14 135		05.04-	CS1491* 12 2.5
120.55 3.0 (Mascott)[DXi3] [ZD3A600]		05.04-				05.04-	CS1491* 12 2.5
		05.04-				05.04-	CS1491* 12 2.5
120.65 3.0 (Mascott)[DXi3] [ZD3A600]		05.04-				05.04-	CS1491* 12 2.5
		05.04-				05.04-	CS1491* 12 2.5
130.35 2.8 (Mascott)[8140.43.S.2585]		01.99- 06.04	CA1684IR	14 90		01.99- 06.04	CS1203 12 2.3
		01.99- 06.04	CA1854IR	14 120			
	[8140.43.S.3585]	01.99- 06.04	CA1684IR	14 90		01.99- 06.04	CS1203 12 2.3
		01.99- 06.04	CA1854IR	14 120			
130.55 2.8 (Mascott)[8140.43.S.2585]		01.99- 06.04	CA1684IR	14 90		01.99- 06.04	CS1203 12 2.3
		01.99- 06.04	CA1854IR	14 120			
	[8140.43.S.3585]	01.99- 06.04	CA1684IR	14 90		01.99- 06.04	CS1203 12 2.3
	01.99- 06.04	CA1854IR	14 120				
130.65 2.8 (Mascott)[8140.43.S.2585]		01.99- 06.04	CA1684IR	14 90		01.99- 06.04	CS1203 12 2.3
		01.99- 06.04	CA1854IR	14 120			
	[8140.43.S.3585]	01.99- 06.04	CA1684IR	14 90		01.99- 06.04	CS1203 12 2.3
	01.99- 06.04	CA1854IR	14 120				
140.35 2.8 (Mascott)[8140.43k]		01.01- 06.04	CA1684IR	14 90		01.01- 06.04	CS1203 12 2.3
		01.01- 06.04	CA1854IR	14 120			
	[8140.43k]	01.01- 06.04	CA1684IR	14 90		01.01- 06.04	CS1203 12 2.3
	01.01- 06.04	CA1854IR	14 120				
140.55 2.8 (Mascott)[8140.43k]		01.01- 06.04	CA1684IR	14 90		01.01- 06.04	CS1203 12 2.3
		01.01- 06.04	CA1854IR	14 120			
140.65 2.8 (Mascott)[8140.43k]		01.01- 06.04	CA1684IR	14 90		01.01- 06.04	CS1203 12 2.3
		01.01- 06.04	CA1854IR	14 120			
150.35 2.8 (Mascott)[8140.43N.3585]		10.01- 06.04	CA1684IR	14 90		10.01- 06.04	CS1203 12 2.3
		10.01- 06.04	CA1854IR	14 120			



**RENAULT V.I. Continued**

150.55 2.8	(Mascott)[8140.43N.3585]	10.01- 06.04	CA1684IR	14 90		10.01- 06.04	CS1203	12 2.3
		10.01- 06.04	CA1854IR	14 120				
150.65 2.8	(Mascott)[8140.43N.3585]	10.01- 06.04	CA1684IR	14 90		10.01- 06.04	CS1203	12 2.3
		10.01- 06.04	CA1854IR	14 120				
160.35 3.0	(Mascott)[DXi3] [ZD3A604]					05.04- 05.04-	CS1491* CS1491*	12 2.5 12 2.5
160.55 3.0	(Mascott)[DXi3] [ZD3A604]					05.04- 05.04-	CS1491* CS1491*	12 2.5 12 2.5
160.65 3.0	(Mascott)[DXi3] [ZD3A604]					05.04- 05.04-	CS1491* CS1491*	12 2.5 12 2.5
90.35 2.8	(Mascott)[8140.63.2585]	01.99- 12.01	CA1684IR	14 90		01.99- 12.01	CS1203	12 2.3
		01.99- 12.01	CA1854IR	14 120				
B 110.45 2.8	(Messenger)[8140.23.2585]	06.96- 06.99	CA314IR	14 75		06.96- 06.99	CS370	12 2.2
B 120.35 2.5	(Messenger)[8140.47.2530IDR]	06.96- 06.99	CA535IR	14 105		06.96- 06.99	CS370	12 2.2
		07.94- 07.96	CA314IR	14 75		07.94- 07.96	CS370	12 2.2
	[8140.47.2590]	07.94- 07.96	CA535IR	14 105		07.94- 07.96	CS370	12 2.2
B 120.35 2.8	(Messenger)[8140.43.2585]	06.96- 06.99	CA314IR	14 75		06.96- 06.99	CS370	12 2.2
		06.96- 06.99	CA535IR	14 105		06.96- 06.99	CS370	12 2.2
B 120.55 2.5	(Messenger)[8140.47.2585]	07.94- 07.96	CA314IR	14 75		07.94- 07.96	CS370	12 2.2
		07.94- 07.96	CA535IR	14 105		07.94- 07.96	CS370	12 2.2
B 120.55 2.8	(Messenger)[8140.43.2585]	06.96- 06.99	CA314IR	14 75		06.96- 06.99	CS370	12 2.2
		06.96- 06.99	CA535IR	14 105		06.96- 06.99	CS370	12 2.2
B 120.55 2.8	(Messenger)[8140.43.2585]	06.96- 06.99	CA314IR	14 75		06.96- 06.99	CS370	12 2.2
		06.96- 06.99	CA535IR	14 105		06.96- 06.99	CS370	12 2.2
B 120.65 2.5	(Messenger)[8140.47.2585]	07.94- 07.96	CA314IR	14 75		07.94- 07.96	CS370	12 2.2
		07.94- 07.96	CA535IR	14 105		07.94- 07.96	CS370	12 2.2
B 120.65 2.8	(Messenger)[8140.43.2585]	06.96- 06.99	CA314IR	14 75		06.96- 06.99	CS370	12 2.2
		06.96- 06.99	CA535IR	14 105		06.96- 06.99	CS370	12 2.2
B 70 2.4 Diesel	[8140.61.235]	01.83- 12.90	CA314IR	14 75		11.85- 12.90	CS370	12 2.2
B 80.35 2.5	(Messenger)[8140.07.2530ID]	08.90- 06.94	CA314IR	14 75		08.90- 06.94	CS370	12 2.2
		08.90- 06.94	CA535IR	14 105		08.90- 06.94	CS370	12 2.2
	[8140.07.2585]	07.94- 07.96	CA314IR	14 75		07.94- 07.96	CS370	12 2.2
		07.94- 07.96	CA535IR	14 105		07.94- 07.96	CS370	12 2.2
	[8140.67.2585]	06.96- 06.99	CA314IR	14 75		06.96- 06.99	CS370	12 2.2
		06.96- 06.99	CA535IR	14 105		06.96- 06.99	CS370	12 2.2
B 80.45 2.5	(Messenger)[8140.07.2530ID]	08.90- 06.94	CA314IR	14 75		08.90- 06.94	CS370	12 2.2
		08.90- 06.94	CA535IR	14 105		08.90- 06.94	CS370	12 2.2
	[8140.07.2585]	07.94- 07.96	CA314IR	14 75		07.94- 07.96	CS370	12 2.2
		07.94- 07.96	CA535IR	14 105		07.94- 07.96	CS370	12 2.2
	[8140.67.2585]	06.96- 06.99	CA314IR	14 75		06.96- 06.99	CS370	12 2.2
		06.96- 06.99	CA535IR	14 105		06.96- 06.99	CS370	12 2.2
B 90 2.4 Diesel	[8140.21.235 IDS]	01.86- 06.94	CA314IR	14 75		04.86- 01.92	CS370	12 2.2
<b>TRUCKS EU</b>								
300 9.8	(Ares)[MIDR 06.20.45 R41]	04.98-	CA1456IR	28 80		04.98-	CS1128	24 6.6
		04.98-	CA1667IR	28 140		04.98-	CS688	24 6.6
340 9.8	(Ares)[MIDR 06.20.45 M41]	04.98-	CA1456IR	28 80		04.98-	CS1128	24 6.6
		04.98-	CA1667IR	28 140		04.98-	CS688	24 6.6
380 11.1	(Ares)[MIDR 06.23.56 A41]	06.00-	CA1456IR	28 80		06.00-	CS1128	24 6.6
		06.00-	CA1667IR	28 140		06.00-	CS688	24 6.6
110.28 2.5	(Mascott)[DXi2.5]	03.07-	CA2085IR*	14 130				
	(Maxity)[DXi2.5]	03.07-	CA2085IR*	14 130				
110.32 2.5	(Maxity)[DXi2.5]	03.07-	CA2085IR*	14 130				
110.35 2.5	(Maxity)[DXi2.5]	03.07-	CA2085IR*	14 130				
130.35 2.5	(Maxity)[DXi2.5]	03.07-	CA2085IR*	14 130				
130.45 2.5	(Maxity)[DXi2.5]	03.07-	CA2085IR*	14 130				
135.08 4.1	(Midlum)[MIDR04.02.26A/4]	02.00- 06.01	CA1456IR	28 80		01.00-	CS608	24 4.0 LM
		02.00- 06.01	CA1852IR	28 60		01.00-	CS1464	24 4.0 SM
135.09 4.1	(Midlum)[MIDR04.02.26A/4]	02.00- 06.01	CA1456IR	28 80		01.00-	CS608	24 4.0 LM
		02.00- 06.01	CA1852IR	28 60		01.00-	CS1464	24 4.0 SM
135.10 4.1	(Midlum)[MIDR04.02.26A/4]	02.00- 06.01	CA1456IR	28 80		01.00-	CS608	24 4.0 LM
		02.00- 06.01	CA1852IR	28 60		01.00-	CS1464	24 4.0 SM
150.08 4.1	(Midlum)[DCi4B]	10.01-	CA1456IR	28 80	BO	10.01-	CS608	24 4.0 LM
		10.01-	CA1852IR	28 60		10.01-	CS1464	24 4.0 SM
		10.01-	CA1947IR*	28 80	MI			
	[MIDR04.02.26B/4]	02.00- 06.01	CA1456IR	28 80		01.00-	CS608	24 4.0 LM
		02.00- 06.01	CA1852IR	28 60		01.00-	CS1464	24 4.0 SM
150.09 4.1	(Midlum)[MIDR04.02.26B/4]	02.00- 06.01	CA1456IR	28 80		01.00-	CS1464	24 4.0 SM
		02.00- 06.01	CA1852IR	28 60		01.00-	CS608	24 4.0 LM
150.10 4.1	(Midlum)[DCi4B]	10.01- 04.06	CA1456IR	28 80		10.01-	CS608	24 4.0 LM
		10.01- 04.06	CA1852IR	28 60		10.01-	CS1464	24 4.0 SM
	[MIDR04.02.26B/4]	02.00- 06.01	CA1456IR	28 80		01.00-	CS608	24 4.0 LM
		02.00- 06.01	CA1852IR	28 60		01.00-	CS1464	24 4.0 SM
150.12 4.1	(Midlum)[DCi4B]	07.01- 04.06	CA1456IR	28 80		01.00-	CS608	24 4.0 LM
		07.01- 04.06	CA1852IR	28 60		01.00-	CS1464	24 4.0 SM
	[MIDR04.02.26B/4]	02.00- 06.01	CA1456IR	28 80		01.00-	CS1464	24 4.0 SM
		02.00- 06.01	CA1852IR	28 60		01.00-	CS608	24 4.0 LM
160.08 4.8	(Midlum)[DXi5]					05.06-	CS1496*	24 5.5
160.10 4.8	(Midlum)[DXi5]					05.06-	CS1496*	24 5.5
160.12 4.8	(Midlum)[DXi5]					05.06-	CS1496*	24 5.5
180.08 4.1	(Midlum)[DCi4C]	07.01- 04.06	CA1456IR	28 80		10.01-	CS1464	24 4.0 SM
		07.01- 04.06	CA1852IR	28 60		10.01-	CS608	24 4.0 LM
180.08 6.2	(Midlum)[MIDR06.02.26V/4]	02.00- 06.01	CA1456IR	28 80		01.00-	CS1464	24 4.0 SM
		02.00- 06.01	CA1852IR	28 60		01.00-	CS608	24 4.0 LM
180.09 6.2	(Midlum)[MIDR06.02.26V/4]	02.00- 06.01	CA1456IR	28 80		01.00-	CS1464	24 4.0 SM
		02.00- 06.01	CA1852IR	28 60		01.00-	CS608	24 4.0 LM
180.10 4.1	(Midlum)[DCi4C]	07.01- 04.06	CA1456IR	28 80		10.01-	CS608	24 4.0 LM
		07.01- 04.06	CA1852IR	28 60		10.01-	CS1464	24 4.0 SM



180.10 6.2	(Midlum)[MIDR06.02.26V/4]	02.00- 06.01	CA1456IR	28	80		01.00-	CS608	24	4.0	LM
		02.00- 06.01	CA1852IR	28	60		01.00-	CS1464	24	4.0	SM
180.12 4.1	(Midlum)[DCi4C]	07.01- 04.06	CA1456IR	28	80		10.01-	CS1464	24	4.0	SM
		07.01- 04.06	CA1852IR	28	60		10.01-	CS608	24	4.0	LM
180.12 6.2	(Midlum)[MIDR06.02.26V/4]	02.00- 06.01	CA1456IR	28	80		01.00-	CS1464	24	4.0	SM
		02.00- 06.01	CA1852IR	28	60		01.00-	CS608	24	4.0	LM
190.08 4.8	(Midlum)[DXi5]						05.06-	CS1496*	24	5.5	
190.10 4.8	(Midlum)[DXi5]						05.06-	CS1496*	24	5.5	
190.12 4.8	(Midlum)[DXi5]						05.06-	CS1496*	24	5.5	
190.13 4.8	(Midlum)[DXi5]						05.06-	CS1496*	24	5.5	
190.14 4.8	(Midlum)[DXi5]						05.06-	CS1496*	24	5.5	
190.16 4.8	(Midlum)[DXi5]						05.06-	CS1496*	24	5.5	
210.08 6.2	(Midlum)[MIDR06.02.26W/4]	02.00- 06.01	CA1456IR	28	80		01.00-	CS1464	24	4.0	SM
		02.00- 06.01	CA1852IR	28	60		01.00-	CS608	24	4.0	LM
210.09 6.2	(Midlum)[MIDR06.02.26W/4]	02.00- 06.01	CA1456IR	28	80		01.00-	CS1464	24	4.0	SM
		02.00- 06.01	CA1852IR	28	60		01.00-	CS608	24	4.0	LM
210.10 6.2	(Midlum)[MIDR06.02.26W/4]	02.00- 06.01	CA1456IR	28	80		01.00-	CS608	24	4.0	LM
		02.00- 06.01	CA1852IR	28	60		01.00-	CS1464	24	4.0	SM
210.12 6.2	(Midlum)[MIDR06.02.26W/4]	02.00- 06.01	CA1456IR	28	80		01.00-	CS608	24	4.0	LM
		02.00- 06.01	CA1852IR	28	60		01.00-	CS1464	24	4.0	SM
210.13 6.2	(Midlum)[MIDR06.02.26W/4]	02.00- 06.01	CA1456IR	28	80		01.00-	CS608	24	4.0	LM
		02.00- 06.01	CA1852IR	28	60		01.00-	CS1464	24	4.0	SM
210.14 6.2	(Midlum)[MIDR06.02.26W/4]	02.00- 06.01	CA1456IR	28	80		01.00-	CS608	24	4.0	LM
		02.00- 06.01	CA1852IR	28	60		01.00-	CS1464	24	4.0	SM
210.15 6.2	(Midlum)[MIDR06.02.26W/4]	01.00- 06.01	CA1456IR	28	80		01.00-	CS608	24	4.0	LM
		01.00- 06.01	CA1852IR	28	60		01.00-	CS1464	24	4.0	SM
210.16 6.2	(Distribution)[MIDR06.02.26W/4]	04.96- 09.01	CA1456IR	28	80		04.96-	CS608	24	4.0	LM
		04.96- 09.98	CA898IR	28	60		04.96-	CS1464	24	4.0	SM
		10.98- 09.01	CA1852IR	28	60						
	(Midlum)[MIDR06.02.26W/4]	02.00- 06.01	CA1456IR	28	80		01.00-	CS1464	24	4.0	SM
		02.00- 06.01	CA1852IR	28	60		01.00-	CS608	24	4.0	LM
210.18 6.2	(Distribution)[MIDR06.02.26W/4]	04.96- 09.01	CA1456IR	28	80		04.96-	CS608	24	4.0	LM
		04.96- 09.98	CA898IR	28	60		04.96-	CS1464	24	4.0	SM
		10.98- 09.01	CA1852IR	28	60						
220.08 4.8	(Midlum)[DXi5]						05.06-	CS1496*	24	5.5	
220.08 6.2	(Midlum)[DCi6W]	07.01- 04.06	CA1456IR	28	80	BO	01.00-	CS1464	24	4.0	SM
		07.01- 04.06	CA1852IR	28	60		01.00-	CS608	24	4.0	LM
		07.01- 04.06	CA1947IR*	28	80	MI					
220.10 4.8	(Midlum)[DXi5]						05.06-	CS1496*	24	5.5	
220.10 6.2	(Midlum)[DCi6W]	07.01- 04.06	CA1456IR	28	80	BO	01.00-	CS1464	24	4.0	SM
		07.01- 04.06	CA1852IR	28	60		01.00-	CS608	24	4.0	LM
		07.01- 04.06	CA1947IR*	28	80	MI					
220.12 4.8	(Midlum)[DXi5]						05.06-	CS1496*	24	5.5	
220.12 6.2	(Midlum)[DCi6W]	07.01- 04.06	CA1456IR	28	80	BO	01.00-	CS1464	24	4.0	SM
		07.01- 04.06	CA1852IR	28	60		01.00-	CS608	24	4.0	LM
		07.01- 04.06	CA1947IR*	28	80	MI					
220.13 4.8	(Midlum)[DXi5]						05.06-	CS1496*	24	5.5	
220.13 6.2	(Midlum)[DCi6W]	07.01- 04.06	CA1456IR	28	80	BO	01.00-	CS608	24	4.0	LM
		07.01- 04.06	CA1852IR	28	60		01.00-	CS1464	24	4.0	SM
		07.01- 04.06	CA1947IR*	28	80	MI					
220.14 4.8	(Midlum)[DXi5]						05.06-	CS1496*	24	5.5	
220.14 6.2	(Midlum)[DCi6W]	07.01- 04.06	CA1456IR	28	80	BO	01.00-	CS608	24	4.0	LM
		07.01- 04.06	CA1852IR	28	60		01.00-	CS1464	24	4.0	SM
		07.01- 04.06	CA1947IR*	28	80	MI					
220.15 6.2	(Midlum)[DCi6W]	07.01- 04.06	CA1456IR	28	80	BO	10.01-	CS1464	24	4.0	SM
		07.01- 04.06	CA1852IR	28	60		10.01-	CS608	24	4.0	LM
		07.01- 04.06	CA1947IR*	28	80	MI					
220.16 4.8	(Midlum)[DXi5]						05.06-	CS1496*	24	5.5	
220.16 6.2	(Midlum)[DCi6W]	07.01- 04.06	CA1456IR	28	80	BO	01.00-	CS1464	24	4.0	SM
		07.01- 04.06	CA1852IR	28	60		01.00-	CS608	24	4.0	LM
		07.01- 04.06	CA1947IR*	28	80	MI					
220.18 6.2	(Distribution)[DCi6W]	04.01- 04.06	CA1456IR	28	80	BO	04.96-	CS1464	24	4.0	SM
		04.01- 04.06	CA1852IR	28	60		04.96-	CS608	24	4.0	LM
		04.01- 04.06	CA1947IR*	28	80	MI					
	(Midlum)[DCi6W]	07.01- 04.06	CA1456IR	28	80	BO	10.01-	CS608	24	4.0	LM
		07.01- 04.06	CA1852IR	28	60		10.01-	CS1464	24	4.0	SM
		07.01- 04.06	CA1947IR*	28	80	MI					
240.12 7.2	(Midlum)[DXi7]						05.06-	CS1496*	24	5.5	
240.13 7.2	(Midlum)[DXi7]						05.06-	CS1496*	24	5.5	
240.14 7.2	(Midlum)[DXi7]						05.06-	CS1496*	24	5.5	
240.15 7.2	(Midlum)[DXi7]						05.06-	CS1496*	24	5.5	
240.16 7.2	(Midlum)[DXi7]						05.06-	CS1496*	24	5.5	
240.18 7.2	(Distribution)[DXi7]						05.06-	CS1496*	24	5.5	
	(Midlum)[DXi7]						05.06-	CS1496*	24	5.5	
250.12 6.2	(Midlum)[MIDR06.02.26Y/41]	02.00- 06.01	CA1456IR	28	80	BO	01.00-	CS1464	24	4.0	SM
		02.00- 06.01	CA1852IR	28	60		01.00-	CS608	24	4.0	LM
		02.00- 06.01	CA1947IR*	28	80	MI					
250.13 6.2	(Midlum)[MIDR06.02.26Y/41]	02.00- 06.01	CA1456IR	28	80	BO	01.00-	CS1464	24	4.0	SM
		02.00- 06.01	CA1852IR	28	60		01.00-	CS608	24	4.0	LM
		02.00- 06.01	CA1947IR*	28	80	MI					
250.14 6.2	(Midlum)[MIDR06.02.26Y/41]	02.00- 06.01	CA1456IR	28	80	BO	01.00-	CS1464	24	4.0	SM
		02.00- 06.01	CA1852IR	28	60		01.00-	CS608	24	4.0	LM
		02.00- 06.01	CA1947IR*	28	80	MI					
250.15 6.2	(Midlum)[MIDR06.02.26Y/41]	02.00- 06.01	CA1456IR	28	80	BO	01.00-	CS1464	24	4.0	SM
		02.00- 06.01	CA1852IR	28	60		01.00-	CS608	24	4.0	LM
		02.00- 06.01	CA1947IR*	28	80	MI					
250.16 6.2	(Distribution)[MIDR06.02.26Y/41]	04.96- 09.01	CA1456IR	28	80		04.96-	CS608	24	4.0	LM
		04.96- 09.98	CA898IR	28	60		04.96-	CS1464	24	4.0	SM
		10.98- 09.01	CA1852IR	28	60						
	(Midlum)[MIDR06.02.26Y/41]	02.00- 06.01	CA1456IR	28	80	BO	01.00-	CS1464	24	4.0	SM
		02.00- 06.01	CA1852IR	28	60		01.00-	CS608	24	4.0	LM
		02.00- 06.01	CA1947IR*	28	80	MI					



RENAULT V.I. Continued

250.18 6.2	(Distribution)[MIDR06.02.26Y/41]	04.96- 09.01	CA1456IR	28 80		04.96-	CS1464	24 4.0	SM
		04.96- 09.98	CA898IR	28 60		04.96-	CS608	24 4.0	LM
250.19 6.2	(Distribution)[MIDR06.02.26Y/41]	10.98- 09.01	CA1852IR	28 60					
		04.96- 09.01	CA1456IR	28 80		04.96-	CS1464	24 4.0	SM
		04.96- 09.98	CA898IR	28 60		04.96-	CS608	24 4.0	LM
		10.98- 09.01	CA1852IR	28 60					
260.16 9.8	(Distribution)[MIDR06.20.45C/4]	04.96- 09.01	CA1456IR	28 80		04.96- 09.01	CS1128	24 6.6	
		04.96- 09.01	CA898IR	28 60					
260.18 9.8	(Distribution)[MIDR06.20.45C/4]	04.96- 12.99	CA1456IR	28 80		10.98- 06.99	CS1325	24 6.0	
		04.96- 12.99	CA898IR	28 60		04.96- 09.98	CS1128	24 6.6	
	(Kerax)[MIDR06.20.45C/4]	06.97- 12.02	CA1456IR	28 80		12.99- 12.02	CS1348	24 6.0	
						06.97- 12.99	CS1128	24 6.6	
260.19 9.8	(Distribution)[MIDR06.20.45C/4]	04.96- 09.01	CA1456IR	28 80		10.98- 12.99	CS1325	24 6.0	
		04.96- 09.01	CA898IR	28 60		04.96- 09.01	CS1128	24 6.6	
270.12 6.2	(Midlum)[DCi6A]	07.01- 04.06	CA1456IR	28 80	BO	10.01-	CS1464	24 4.0	SM
		07.01- 04.06	CA1852IR	28 60		10.01-	CS608	24 4.0	LM
		07.01- 04.06	CA1947IR*	28 80	MI				
		07.01- 04.06	CA1456IR	28 80	BO	10.01-	CS608	24 4.0	LM
270.13 6.2	(Midlum)[DCi6A]	07.01- 04.06	CA1852IR	28 60		10.01-	CS1464	24 4.0	SM
		07.01- 04.06	CA1947IR*	28 80	MI				
270.14 6.2	(Midlum)[DCi6A]	07.01- 04.06	CA1456IR	28 80	BO	10.01-	CS1464	24 4.0	SM
		07.01- 04.06	CA1852IR	28 60		10.01-	CS608	24 4.0	LM
		07.01- 04.06	CA1947IR*	28 80	MI				
		07.01- 04.06	CA1456IR	28 80	BO	10.01-	CS1464	24 4.0	SM
270.16 6.2	(Midlum)[DCi6A]	07.01- 04.06	CA1852IR	28 60		10.01-	CS608	24 4.0	LM
		07.01- 04.06	CA1947IR*	28 80	MI				
270.18 11.1	(Kerax)[DCi11-270]	01.01-	CA2019IR*	28 90		01.01-	CS1386	24 5.5	
270.18 6.2	(Distribution)[DCi6A]	04.01- 04.06	CA1852IR	28 60		08.00-	CS608	24 4.0	LM
						08.00-	CS1464	24 4.0	SM
	(Midlum)[DCi6A]	07.01- 04.06	CA1456IR	28 80	BO	10.01-	CS1464	24 4.0	SM
		07.01- 04.06	CA1852IR	28 60		10.01-	CS608	24 4.0	LM
		07.01- 04.06	CA1947IR*	28 80	MI				
270.18 7.2	(Lander)[DXi7]					10.06-	CS1496*	24 5.5	
270.19 7.2	(Distribution)[DXi7]					10.06-	CS1496*	24 5.5	
	(Lander)[DXi7]					10.06-	CS1496*	24 5.5	
280.12 7.2	(Midlum)[DXi7]					05.06-	CS1496*	24 5.5	
280.13 7.2	(Midlum)[DXi7]					05.06-	CS1496*	24 5.5	
280.14 7.2	(Midlum)[DXi7]					05.06-	CS1496*	24 5.5	
280.16 7.2	(Midlum)[DXi7]					05.06-	CS1496*	24 5.5	
280.18 7.2	(Distribution)[DXi7]					10.05-	CS1496*	24 5.5	
	(Midlum)[DXi7]					05.06-	CS1496*	24 5.5	
280.26 7.2	(Distribution)[DXi7]					10.05-	CS1496*	24 5.5	
300.16 9.8	(Distribution)[MIDR06.20.45D/41]	02.96- 09.01	CA1456IR	28 80		02.96- 09.01	CS1128	24 6.6	
		02.96- 05.99	CA898IR	28 60		04.96-	CS1348	24 6.0	
	(Route)[MIDR06.20.45D/41]	06.99- 09.01	CA1738IR	28 60					
		02.96- 09.01	CA1456IR	28 80		02.96- 09.01	CS1348	24 6.0	
		02.96- 09.01	CA898IR	28 60		09.96-	CS1128	24 6.6	
		06.99- 09.01	CA1738IR	28 60					
300.18 9.8	(Distribution)[MIDR06.20.45D/41]	04.96- 09.01	CA1456IR	28 80		10.98- 09.01	CS1348	24 6.0	
						04.96- 09.98	CS1128	24 6.6	
	(Kerax)[MIDR06.20.45D/41]	06.97- 12.02	CA1456IR	28 80		10.98- 09.01	CS1325	24 6.0	
		06.97- 12.02	CA898IR	28 60		06.97- 12.02	CS688	24 6.6	
		06.97- 12.02	CA898IR	28 60		06.97- 12.02	CS1128	24 6.6	
						06.97- 12.02	CS1325	24 6.0	
	(Route)[MIDR06.20.45D/41]	02.96- 12.99	CA1456IR	28 80		06.97- 12.02	CS1348	24 6.0	
		02.96- 12.99	CA1456IR	28 80		09.96- 09.98	CS1128	24 6.6	
		02.96- 05.99	CA898IR	28 60		12.99- 12.99	CS1348	24 6.0	
		06.99- 12.99	CA1738IR	28 60		10.98- 12.99	CS1325	24 6.0	
300.19 9.8	(Distribution)[MIDR06.20.45D/41]	02.96- 12.99	CA1456IR	28 80		04.96- 09.98	CS1128	24 6.6	
		02.96- 05.99	CA898IR	28 60		10.98- 09.01	CS1348	24 6.0	
	(Route)[MIDR06.20.45D/41]	06.99- 12.99	CA1738IR	28 60					
		02.96- 12.99	CA1456IR	28 80		09.96- 09.98	CS1128	24 6.6	
		02.96- 05.99	CA898IR	28 60		09.96- 09.01	CS1348	24 6.0	
		06.99- 12.99	CA1738IR	28 60					
300.26 9.8	(Distribution)[MIDR06.20.45D/41]	04.96-	CA1456IR	28 80		10.98- 12.99	CS1325	24 6.0	
						04.96- 09.98	CS1128	24 6.6	
	(Kerax)[MIDR06.20.45D/41]	06.97- 12.02	CA1456IR	28 80		12.99-	CS1348	24 6.0	
						06.97- 12.02	CS1325	24 6.0	
		06.97- 12.02	CA1738IR	28 60		06.97- 12.02	CS1348	24 6.0	
		06.97- 12.02	CA898IR	28 60		06.97- 12.02	CS1128	24 6.6	
	[MIDR06.20.45E/41]	01.00-	CA1456IR	28 80		06.97- 12.99	CS1128	24 6.6	
		01.00- 05.00	CA1738IR	28 60		10.98- 12.99	CS1325	24 6.0	
		06.00-	CA898IR	28 60		12.99-	CS1348	24 6.0	
310.18 7.2	(Distribution)[DXi7]					10.06-	CS1496*	24 5.5	
310.19 7.2	(Lander)[DXi7]					10.06-	CS1496*	24 5.5	
310.26 7.2	(Distribution)[DXi7]					10.06-	CS1496*	24 5.5	
	(Lander)[DXi7]					10.06-	CS1496*	24 5.5	
	(Premium 2)[DXi7]					10.06-	CS1496*	24 5.5	
320.18 11.1	(Distribution)[DCi11G]	01.01- 04.06	CA1456IR	28 80		08.00- 04.06	CS1386	24 5.5	
		01.01-	CA2019IR*	28 90					
	(Kerax)[DCi11G]	01.01-	CA2019IR*	28 90		01.01-	CS1386	24 5.5	
		01.00- 04.06	CA1456IR	28 80		01.00- 04.06	CS1386	24 5.5	
	(Route)[DCi11G]	08.00-	CA2019IR*	28 90					
320.18 7.2	(Distribution)[DXi7]					10.05-	CS1496*	24 5.5	
320.24 11.1	(Distribution)[DCi11G]	01.00- 04.06	CA1456IR	28 80		01.00- 04.06	CS1386	24 5.5	
		01.00- 04.06	CA2019IR*	28 90					
320.26 11.1	(Distribution)[DCi11G]	08.00-	CA1456IR	28 80		08.00-	CS1386	24 5.5	
		08.00-	CA2019IR*	28 90					
	(Kerax)[DCi11G]	01.01-	CA1456IR	28 80		01.01-	CS1386	24 5.5	
		01.01-	CA2019IR*	28 90					
320.26 7.2	(Distribution)[DXi7]					10.05-	CS1496*	24 5.5	
340.18 7.2	(Distribution)[DXi7]					10.06-	CS1496*	24 5.5	
						10.06-	CS1496*	24 5.5	
	(Lander)[DXi7]					10.06-	CS1496*	24 5.5	





340.18 9.8	(Distribution)[MIDR06.20.45E/41]	04.96- 03.01	CA1456IR	28 80		04.96- 12.99	CS1128	24 6.6
						10.98- 12.99	CS1325	24 6.0
						12.99- 03.01	CS1348	24 6.0
	(Kerax)[MIDR06.20.45C/4]	06.97-	CA1456IR	28 80		12.99-	CS1348	24 6.0
						06.97- 12.99	CS1128	24 6.6
						10.98- 12.99	CS1325	24 6.0
340.19 7.2	(Distribution)[DXi7]					06.97- 12.99	CS1325	24 6.0
	(Lander)[DXi7]					12.99- 12.02	CS1348	24 6.0
						06.97- 12.99	CS1128	24 6.6
	[MIDR06.20.45E/41]	06.97- 12.02	CA1456IR	28 80		04.96- 12.99	CS1128	24 6.6
		06.97- 12.02	CA898IR	28 60		12.99- 12.02	CS1348	24 6.0
						06.97- 12.99	CS1128	24 6.6
340.19 9.8	(Route)[MIDR06.20.45E/41]	01.00- 03.01	CA1456IR	28 80		04.96- 12.99	CS1128	24 6.6
						01.00- 05.00	CA1738IR	28 60
						06.00- 03.01	CA898IR	28 60
						04.96- 03.01	CA1456IR	28 80
						12.99- 03.01	CS1348	24 6.0
						10.98- 12.99	CS1325	24 6.0
340.24 9.8	(Route)[MIDR06.20.45E/41]	01.00- 03.01	CA1456IR	28 80		04.96- 09.98	CS1128	24 6.6
						01.00- 05.00	CA1738IR	28 60
						06.00- 03.01	CA898IR	28 60
						10.98- 03.01	CS1325	24 6.0
						10.98- 03.01	CS1348	24 6.0
						10.06-	CS1496*	24 5.5
340.26 7.2	(Distribution)[DXi7]					10.06-	CS1496*	24 5.5
	(Lander)[DXi7]					10.06-	CS1496*	24 5.5
	(Premium 2)[DXi7]					10.06-	CS1496*	24 5.5
						10.06-	CS1496*	24 5.5
						10.06-	CS1496*	24 5.5
						10.06-	CS1496*	24 5.5
340.26 9.8	(Distribution)[MIDR06.20.45E/41]	04.96- 03.01	CA1456IR	28 80		10.98- 03.01	CS1348	24 6.0
						02.97- 05.99	CA898IR	28 60
						01.00- 05.00	CA1738IR	28 60
	(Kerax)[MIDR06.20.45E/41]	01.00- 05.00	CA1738IR	28 60		06.97- 12.99	CS1325	24 6.0
						06.97- 12.02	CA1456IR	28 80
						06.97- 12.02	CA898IR	28 60
340.32 9.8	(Route)[MIDR06.20.45E/41]	01.00- 03.01	CA1456IR	28 80		04.96- 12.99	CS1128	24 6.6
						01.00- 05.00	CA1738IR	28 60
						06.00- 03.01	CA898IR	28 60
						10.98- 03.01	CS1348	24 6.0
						10.98- 12.99	CS1325	24 6.0
						06.97- 12.99	CS1128	24 6.6
350.34 11.1	(Kerax)[MIDR06.23.56A/3]	01.03-	CA898IR	28 60		01.03-	CS1348	24 6.0
						06.97-	CA1738IR	28 60
						06.97-	CA898IR	28 60
						12.99-	CS1348	24 6.0
						10.05-	CS1495*	24 5.5
						10.05-	CS1495*	24 5.5
370.18 10.8	(Distribution)[DXi11]					10.05-	CS1495*	24 5.5
	(Kerax)[DXi11]					10.05-	CS1495*	24 5.5
	(Distribution)[DCi11E]	04.01-	CA1456IR	28 80		08.00-	CS1386	24 5.5
		04.01-	CA2019IR*	28 90		01.01-	CS1386	24 5.5
	(Kerax)[DCi11E]	01.01-	CA1456IR	28 80		01.01-	CS1386	24 5.5
		01.01-	CA2019IR*	28 90		08.00-	CS1386	24 5.5
370.24 11.1	(Route)[DCi11E]	08.00-	CA2019IR*	28 90		08.00-	CS1386	24 5.5
		04.01-	CA1456IR	28 80		08.00-	CS1386	24 5.5
						08.00-	CA1456IR	28 80
	(Distribution)[DCi11E]	08.00-	CA1456IR	28 80		08.00-	CS1386	24 5.5
		08.00-	CA2019IR*	28 90		08.00-	CS1386	24 5.5
		04.01-	CA1456IR	28 80		08.00-	CS1386	24 5.5
370.26 10.8	(Distribution)[DXi11]					10.05-	CS1495*	24 5.5
	(Kerax)[DXi11]					10.05-	CS1495*	24 5.5
	(Distribution)[DCi11E]	04.01-	CA1456IR	28 80		08.00-	CS1386	24 5.5
		04.01-	CA2019IR*	28 90		01.01-	CS1386	24 5.5
	(Kerax)[DCi11E]	01.01-	CA1456IR	28 80		01.01-	CS1386	24 5.5
		01.01-	CA2019IR*	28 90		08.00-	CS1386	24 5.5
370.26 11.1	(Route)[DCi11E]	08.00-	CA2019IR*	28 90		08.00-	CS1386	24 5.5
		04.01-	CA1456IR	28 80		08.00-	CS1386	24 5.5
						04.01-	CA1456IR	28 80
						04.01-	CA2019IR*	28 90
						01.01-	CA1456IR	28 80
						01.01-	CA2019IR*	28 90
370.32 10.8	(Kerax)[DXi11]					10.05-	CS1495*	24 5.5
	(Kerax)[DCi11E]	01.01-	CA1456IR	28 80		01.01-	CS1386	24 5.5
		01.01-	CA2019IR*	28 90		01.01-	CS1386	24 5.5
						01.01-	CA1456IR	28 80
						01.01-	CA2019IR*	28 90
						04.01-	CA1456IR	28 80
385.18 11.1	(Kerax)[MIDR06.23.56A/41]	01.00- 05.00	CA1738IR	28 60		06.97- 12.99	CS1128	24 6.6
						01.00- 12.02	CA898IR	28 60
						06.97- 12.02	CA1456IR	28 80
	(Route)[MIDR06.23.56A/41]	02.96- 03.01	CA1456IR	28 80		12.99- 12.02	CS1348	24 6.0
						10.98- 12.99	CS1325	24 6.0
						02.96- 03.01	CA1456IR	28 80
385.19 11.1	(Route)[MIDR06.23.56A/41]	02.96- 03.01	CA898IR	28 60		10.98- 03.01	CS1325	24 6.0
		04.96- 05.99	CA898IR	28 60		04.96- 09.98	CS1128	24 6.6
						10.98- 03.01	CS1348	24 6.0
	[MIDR06.23.56B/41]	04.96- 03.01	CA1456IR	28 80		04.96- 09.98	CS1128	24 6.6
		04.96- 05.99	CA898IR	28 60		04.96- 03.01	CS1348	24 6.0
						10.98- 03.01	CS1325	24 6.0
385.24 11.1	(Route)[MIDR06.23.56A/41]	01.00- 03.01	CA1574IR	28 80	BO	10.98- 03.01	CS1325	24 6.0
						02.96- 03.01	CA1456IR	28 80
						04.96- 05.99	CA898IR	28 60
						10.98- 03.01	CS1348	24 6.0
	[MIDR06.23.56B/41]	04.96- 03.01	CA1456IR	28 80	BO	04.96- 09.98	CS1128	24 6.6
		04.96- 05.99	CA898IR	28 60		04.96- 03.01	CS1348	24 6.0
385.26 11.1	(Kerax)[MIDR06.23.56A/41]	01.00- 12.02	CA1438IR	28 80		04.96- 12.99	CS1128	24 6.6
						12.99- 12.02	CS1348	24 6.0
						01.00- 05.00	CA1738IR	28 60
						02.98- 12.99	CS1325	24 6.0
						06.97- 12.99	CS1128	24 6.6
						02.98- 12.02	CA898IR	28 60
	(Route)[MIDR06.23.56A/41]	01.00- 03.01	CA1574IR	28 80		10.98- 12.99	CS1325	24 6.0
						02.96- 12.99	CS1128	24 6.6
						12.99- 03.01	CS1348	24 6.0
	[MIDR06.23.56B/41]	04.96-	CA1456IR	28 80		04.96- 12.99	CS1128	24 6.6
		04.96-	CA898IR	28 60		12.99- 03.01	CS1348	24 6.0
						10.98- 12.99	CS1325	24 6.0



**RENAULT V.I. Continued**

385.32 11.1	(Kerax)[MIDR06.23.56A/41]	02.98- 12.02	CA1456IR	28 80	02.98- 12.99	CS1325	24 6.0
		02.98- 05.00	CA1738IR	28 60	12.99- 12.02	CS1348	24 6.0
		02.98- 12.02	CA898IR	28 60	06.97- 12.99	CS1128	24 6.6
400.18 11.1	(Distribution)[MIDR06.23.56B/41]	01.00- 03.01	CA1574IR	28 80	12.99- 03.01	CS1348	24 6.0
		04.96- 03.01	CA1456IR	28 80	10.98- 12.99	CS1325	24 6.0
		02.97- 05.99	CA898IR	28 60	04.96- 09.98	CS1128	24 6.6
	(Kerax)[MIDR06.23.56B/41]	01.00-	CA1456IR	28 80	01.00-	CS1128	24 6.6
		01.00-	CA898IR	28 60	01.00-	CS1348	24 6.0
	(Route)[MIDR06.23.56A/41]	02.96- 03.01	CA1456IR	28 80	10.98- 03.01	CS1348	24 6.0
		02.97- 05.99	CA898IR	28 60	10.98- 03.01	CS1325	24 6.0
					02.96- 09.98	CS1128	24 6.6
	[MIDR06.23.56B/41]	04.96- 03.01	CA1456IR	28 80	10.98- 03.01	CS1325	24 6.0
		04.96- 05.99	CA898IR	28 60	12.99- 03.01	CS1348	24 6.0
		04.98- 03.01	CA1738IR	28 60	04.96- 12.99	CS1128	24 6.6
400.18 12.0	(E.tech)[MACKE.TECHA/46]	03.01-	CA1456IR	28 80	05.00-	CS1497*	24 7.2
		03.01-	CA898IR	28 60			
400.19 11.1	(Route)[MIDR06.23.56A/41]	01.00- 03.01	CA1574IR	28 80	04.96- 03.01	CS1348	24 6.0
		02.96- 03.01	CA1456IR	28 80	02.96- 09.98	CS1128	24 6.6
		04.96- 05.99	CA898IR	28 60			
	[MIDR06.23.56B/41]	01.00- 03.01	CA1574IR	28 80	04.96- 10.98	CS1128	24 6.6
		04.96- 03.01	CA1456IR	28 80	04.96- 03.01	CS1348	24 6.0
		04.96- 05.99	CA898IR	28 60			
400.24 11.1	(Route)[MIDR06.23.56A/41]	04.96-	CA1456IR	28 80	10.98- 12.99	CS1325	24 6.0
		04.96-	CA898IR	28 60	12.99- 03.01	CS1348	24 6.0
		09.96-	CA1738IR	28 60	04.96- 12.99	CS1128	24 6.6
	[MIDR06.23.56B/41]	04.98- 03.01	CA1456IR	28 80	10.98- 12.99	CS1325	24 6.0
		04.98- 03.01	CA1574IR	28 80	04.98- 09.98	CS1128	24 6.6
		04.98- 03.01	CA1738IR	28 60	12.99- 03.01	CS1348	24 6.0
		04.98- 05.99	CA898IR	28 60			
400.24 12.0	(E.tech)[MACKE.TECHA/46]	03.01-	CA1456IR	28 80	05.00-	CS1497*	24 7.2
		03.01-	CA898IR	28 60			
400.26 11.1	(Kerax)[MIDR06.23.56B/41]	01.00- 03.01	CA1456IR	28 80	12.99- 03.01	CS1348	24 6.0
		01.00- 03.01	CA898IR	28 60	09.98- 12.99	CS1325	24 6.0
					09.98- 12.99	CS1128	24 6.6
	(Route)[MIDR06.23.56A/41]	04.96-	CA1456IR	28 80	12.99- 03.01	CS1348	24 6.0
		04.96-	CA898IR	28 60	10.98- 12.99	CS1325	24 6.0
					04.96- 12.99	CS1128	24 6.6
	[MIDR06.23.56B/41]	01.00- 03.01	CA1574IR	28 80	12.99- 03.01	CS1348	24 6.0
					04.96- 12.99	CS1128	24 6.6
					10.98- 12.99	CS1325	24 6.0
400.26 12.0	(E.tech)[MACKE.TECHA/46]	03.01-	CA1456IR	28 80	05.00-	CS1497*	24 7.2
		03.01-	CA898IR	28 60			
400.32 11.1	(Kerax)[MIDR06.23.56B/41]	01.00-	CA1456IR	28 80	01.00-	CS1128	24 6.6
		01.00-	CA898IR	28 60	01.00-	CS1348	24 6.0
410.18 10.8	(Distribution)[DXi11]				10.05-	CS1495*	24 5.5
	(Kerax)[DXi11]				10.05-	CS1495*	24 5.5
	(Route)[DXi11]				10.05-	CS1495*	24 5.5
410.24 10.8	(Route)[DXi11]				10.05-	CS1495*	24 5.5
410.25 10.8	(Route)[DXi11]				10.05-	CS1495*	24 5.5
410.26 10.8	(Distribution)[DXi11]				10.05-	CS1495*	24 5.5
	(Kerax)[DXi11]				10.05-	CS1495*	24 5.5
	(Route)[DXi11]				10.05-	CS1495*	24 5.5
410.32 10.8	(Kerax)[DXi11]				10.05-	CS1495*	24 5.5
420.18 11.1	(Distribution)[DCi11C]	08.00- 04.06	CA2019IR*	28 90	08.00- 04.06	CS1386	24 5.5
		11.00- 04.06	CA1456IR	28 80			
	(Kerax)[DCi11C]	01.01-	CA1456IR	28 80	01.01-	CS1386	24 5.5
		01.01-	CA1738IR	28 60			
		01.01-	CA2019IR*	28 90			
		01.01-	CA898IR	28 60			
	(Route)[DCi11C]	08.00- 09.05	CA1456IR	28 80	04.01- 09.05	CS1386	24 5.5
		08.00-	CA2019IR*	28 90			
420.24 11.1	(Route)[DCi11C]	08.00-	CA2019IR*	28 90	08.00-	CS1386	24 5.5
		04.01-	CA1456IR	28 80			
420.25 11.1	(Route)[DCi11C]	08.00-	CA2019IR*	28 90	08.00-	CS1386	24 5.5
		04.01-	CA1456IR	28 80			
420.26 11.1	(Kerax)[DCi11C]	01.01-	CA1456IR	28 80	01.01-	CS1386	24 5.5
		01.01-	CA2019IR*	28 90			
	(Route)[DCi11C]	08.00-	CA2019IR*	28 90	08.00-	CS1386	24 5.5
		04.01-	CA1456IR	28 80			
420.32 11.1	(Kerax)[DCi11C]	10.01-	CA1456IR	28 80	01.01-	CS1386	24 5.5
		10.01-	CA1738IR	28 60			
		10.01-	CA2019IR*	28 90			
		10.01-	CA898IR	28 60			
420.34 11.1	(Kerax)[DCi11C]	01.01-	CA1456IR	28 80	01.01-	CS1386	24 5.5
		01.01-	CA2019IR*	28 90			
440.18 12.0	(E.tech)[MACKE.TECHB/46]	03.01-	CA1456IR	28 80	05.00-	CS1497*	24 7.2
		03.01-	CA898IR	28 60			
440.18 12.1	(Magnum)[DXi12]	10.04- 04.06	CA1853IR	28 80			
440.19 12.8	(Magnum)[DXi13]	03.09-	CA1883IR	28 110			
440.24 12.0	(E.tech)[MACKE.TECHB/46]	03.01-	CA1456IR	28 80	05.00-	CS1497*	24 7.2
		03.01-	CA898IR	28 60			
440.24 12.1	(Magnum)[DXi12]	10.04- 04.06	CA1853IR	28 80			
440.26 12.0	(E.tech)[MACKE.TECHB/46]	03.01-	CA1456IR	28 80	05.00-	CS1497*	24 7.2
		03.01-	CA898IR	28 60			
440.26 12.1	(Magnum)[DXi12]	10.04- 04.06	CA1853IR	28 80			
450.18 10.8	(Distribution)[DXi11]				10.05-	CS1495*	24 5.5
	(Kerax)[DXi11]				10.05-	CS1495*	24 5.5
	(Route)[DXi11]				10.05-	CS1495*	24 5.5
450.24 10.8	(Route)[DXi11]				10.05-	CS1495*	24 5.5
450.25 10.8	(Route)[DXi11]				10.05-	CS1495*	24 5.5
450.26 10.8	(Kerax)[DXi11]				10.05-	CS1495*	24 5.5
	(Route)[DXi11]				10.05-	CS1495*	24 5.5
450.32 10.8	(Kerax)[DXi11]				10.05-	CS1495*	24 5.5
460.18 12.8	(Magnum)[DXi13]	05.06-	CA1883IR	28 110			
460.24 12.8	(Magnum)[DXi13]	05.06-	CA1883IR	28 110			
460.25 12.8	(Magnum)[DXi13]	05.06-	CA1883IR	28 110			
460.26 12.8	(Magnum)[DXi13]	05.06-	CA1883IR	28 110			



460.32 12.8	(Kerax) DXi13	05.06-	CA1883IR	28 110				
480.18 12.0	(E.tech) MACKE.TECHC/46	03.01-	CA1456IR	28 80	05.00-	CS1497*	24 7.2	
		03.01-	CA898IR	28 60				
480.18 12.1	(Magnum) DXi12	10.04- 04.06	CA1853IR	28 80				
480.19 12.8	(Magnum) DXi13	03.09-	CA1883IR	28 110				
480.24 12.0	(E.tech) MACKE.TECHC/46	03.01-	CA1456IR	28 80	05.00-	CS1497*	24 7.2	
		03.01-	CA898IR	28 60				
480.24 12.1	(Magnum) DXi12	10.04- 04.06	CA1853IR	28 80				
480.26 12.0	(E.tech) MACKE.TECHC/46	03.01-	CA1456IR	28 80	05.00-	CS1497*	24 7.2	
		03.01-	CA898IR	28 60				
480.26 12.1	(Magnum) DXi12	10.04- 04.06	CA1853IR	28 80				
480.26 12.8	(Magnum) DXi13	03.09-	CA1883IR	28 110				
500.18 12.8	(Magnum) DXi13	05.06-	CA1883IR	28 110				
500.24 12.8	(Magnum) DXi13	05.06-	CA1883IR	28 110				
500.25 12.8	(Magnum) DXi13	05.06-	CA1883IR	28 110				
500.26 12.8	(Magnum) DXi13	05.06-	CA1883IR	28 110				
500.32 12.8	(Kerax) DXi13	05.06-	CA1883IR	28 110				
520.19 12.8	(Magnum) DXi13	08.09-	CA1883IR	28 110				
520.24 12.8	(Magnum) DXi13	08.09-	CA1883IR	28 110				
520.25 12.8	(Magnum) DXi13	08.09-	CA1883IR	28 110				
520.26 12.8	(Magnum) DXi13	08.09-	CA1883IR	28 110				
AE 385 12.0	(Magnum) MIDR06.35.40N/3	02.92- 10.96	CA1035IR	28 80				
		02.92- 10.96	CA898IR	28 60				
AE 390 12.0	(Magnum) MIDR06.24.65A/42	09.96- 05.00	CA1456IR	28 80	BO			
		09.96- 05.00	CA898IR	28 60				
		09.99- 05.00	CA1574IR	28 80	PR			
AE 420 12.0	(Magnum) MIDR06.35.40J/3	10.92- 10.96	CA1035IR	28 80				
		10.92- 10.96	CA898IR	28 60				
	[MIDR06.35.40P/41]	10.92- 12.96	CA1456IR	28 80				
		04.96- 01.97	CA1035IR	28 80				
		04.96- 01.97	CA898IR	28 60				
AE 430 12.0	(Magnum) MIDR06.24.65B/42	09.96- 09.99	CA1456IR	28 80	BO			
		09.96- 05.00	CA898IR	28 60				
		09.99- 05.00	CA1574IR	28 80	PR			
AE 470 12.0	(Magnum) MIDR06.24.65C/42	11.96- 08.99	CA1456IR	28 80	BO			
		11.96- 05.00	CA898IR	28 60				
		09.99- 05.00	CA1574IR	28 80	PR			
AE 520 16.5	(Magnum) Mack-EE9-530	10.92- 05.96	CA1035IR	28 80				
		10.92- 05.96	CA898IR	28 60				
AE 560 16.4	(Magnum) Mack-EE9-560	04.96- 05.00	CA1456IR	28 80				
		04.96- 05.00	CA898IR	28 60				
Agora 9.8	(Agora) MIDR06.20.45I/41	01.96-	CA1456IR	28 80	01.96-	CS688	24 6.6	
Ares 9.8	(Ares) MIDR06.20.45M/41	04.98-	CA1456IR	28 80	04.98-	CS688	24 6.6	
		04.98-	CA1456IR	28 80	04.98-	CS688	24 6.6	
	[MIDR06.20.45R/41]	04.98-	CA1456IR	28 80	04.98-	CS688	24 6.6	
B 110 2.5 Diesel	[8140.27.25..]	08.90- 06.96	CA314IR	14 75				
B 110 2.8 Diesel	[8140.23.25..]	06.96- 06.99	CA314IR	14 75				
B 120 2.5 Diesel	[8140.47.25..]	10.91- 07.96	CA314IR	14 75				
B 120 2.8 Diesel	[8140.43.25..]	06.96- 06.99	CA314IR	14 75				
C 210.19 8.8	[MIDS06.20.30N]				12.83- 05.91	CS688	24 6.6	
C 260.26 9.8	[MIDS06.20.45B]				10.82- 05.91	CS688	24 6.6	
C 290.19/T 9.8	[MIDR06.20.45D]				05.86- 05.91	CS688	24 6.6	
C 300.19 9.8	[MIDR06.20.45D3]	09.92- 10.98	CA898IR	28 60	09.92- 05.95	CS983	24 8.0	
					06.95- 10.98	CS1128	24 6.6	
					09.92- 10.98	CS688	24 6.6	
C 300.24 9.8	[MIDR06.20.45D]	09.92- 03.93	CA898IR	28 60	09.92- 03.93	CS983	24 8.0	
	[MIDR06.20.45D3]	03.93- 10.98	CA898IR	28 60	09.92- 03.93	CS688	24 6.6	
					06.95- 10.98	CS1128	24 6.6	
					03.93- 10.98	CS688	24 6.6	
					03.93- 05.95	CS983	24 8.0	
C 300.26 9.8	[MIDR06.20.45D]	09.92- 03.93	CA898IR	28 60	09.92- 03.93	CS688	24 6.6	
	[MIDR06.20.45D3]	03.93- 10.98	CA898IR	28 60	09.92- 03.93	CS983	24 8.0	
					03.93- 05.95	CS983	24 8.0	
					06.95- 10.98	CS1128	24 6.6	
					03.93- 10.98	CS688	24 6.6	
C 340.19 9.8	[MIDR06.20.45E]	01.93- 10.98	CA898IR	28 60	07.90- 09.92	CS688	24 6.6	
					09.92- 03.93	CS983	24 8.0	
	[MIDR06.20.45E2]				10.91- 09.92	CS688	24 6.6	
					09.92- 10.92	CS983	24 8.0	
	[MIDR06.20.45E3]	01.93- 10.98	CA898IR	28 60	02.92- 09.92	CS688	24 6.6	
					06.95- 10.98	CS1128	24 6.6	
					09.92- 05.95	CS983	24 8.0	
C 340ti.17 9.8	[MIDR06.20.45E]	01.93- 10.98	CA898IR	28 60	07.90- 09.92	CS688	24 6.6	
					09.92- 03.93	CS983	24 8.0	
	[MIDR06.20.45E2]				10.91- 09.92	CS688	24 6.6	
					09.92- 10.92	CS983	24 8.0	
	[MIDR06.20.45E3]	01.93- 10.98	CA898IR	28 60	09.92- 05.95	CS983	24 8.0	
					06.95- 10.98	CS1128	24 6.6	
					02.92- 09.92	CS688	24 6.6	
C 340ti.19 9.8	[MIDR06.20.45E]	01.93- 10.98	CA898IR	28 60	09.92- 03.93	CS983	24 8.0	
					07.90- 09.92	CS688	24 6.6	
	[MIDR06.20.45E2]				10.91- 09.92	CS688	24 6.6	
					09.92- 10.92	CS983	24 8.0	
	[MIDR06.20.45E3]	01.93- 10.98	CA898IR	28 60	02.92- 09.92	CS688	24 6.6	
					05.95- 10.98	CS1128	24 6.6	
					09.92- 05.95	CS983	24 8.0	
CBH 280 12.0	[MIDS06.35.40D]	04.86- 10.92	CA898IR	28 60				
CBH 320.24 12.0	[MIDR06.35.40M3]	10.92- 10.98	CA1035IR	28 80				
		10.92- 10.98	CA898IR	28 60				
CBH 320.26 12.0	[MIDR06.35.40M3]	10.92- 10.98	CA1035IR	28 80				
		10.92- 10.98	CA898IR	28 60				
CBH 320.34 12.0	[MIDR06.35.40M3]	10.92- 10.98	CA1035IR	28 80				
		10.92- 08.95	CA898IR	28 60				
CBH 385.24 12.0	[MIDR06.35.40N/3]	10.92- 10.98	CA1035IR	28 80				
		10.92- 08.95	CA898IR	28 60				
CBH 385.26 12.0	[MIDR06.35.40N/3]	10.92- 10.98	CA1035IR	28 80				
		10.92- 10.98	CA898IR	28 60				
CBH 385.34 12.0	[MIDR06.35.40N/3]	10.92- 10.98	CA1035IR	28 80				
		10.92- 10.98	CA898IR	28 60				



**RENAULT V.I. Continued**

Citybus GX 317 9.9	(Agora)[MGDR 06.20.45 D491]	06.95-	CA1667IR	28	140	06.95-	CS1128	24	6.6
	[MIDR 06.20.45 A491]	06.95-	CA1667IR	28	140	06.95- 06.95-	CS688 CS1128	24	6.6 6.6
CLM 320.19 12.0	[MIDR06.35.40M3]	10.92- 10.98	CA898IR	28	60				
CLM 320.25 12.0	[MIDR06.35.40M3]	10.92- 10.98	CA898IR	28	60				
CLM 385.19 12.0	[MIDR06.35.40N/3]	10.92- 10.98	CA898IR	28	60				
CLM 385.22 12.0	[MIDR06.35.40N/3]	10.92- 10.98	CA898IR	28	60				
CLM 385.25 12.0	[MIDR06.35.40N/3]	10.92- 10.98	CA898IR	28	60				
CLR 230.19 6.2	[MIDR06.02.26D]	01.93- 10.98	CA898IR	28	60	09.90- 10.98 09.90- 10.98	CS1464 CS608	24	4.0 4.0
FR1 9.8	[MIDR06.20.45D]					01.83-	CS688	24	6.6
	[MIDR06.20.45D3]					01.83-	CS688	24	6.6
	[MIDR06.20.45M3]					01.83-	CS688	24	6.6
FRH 11.1	(Iliade)[MIDR06.23.56A/41]	01.97-	CA1456IR	28	80	01.97-	CS983	24	8.0
		01.97-	CA1667IR	28	140	01.97- 01.97-	CS688 CS1128	24	6.6 6.6
G 170.11 5.5	[MIDR06.02.12D]	04.83- 02.90	CA130IR	28	35	05.83- 02.90	CS1464	24	4.0
G 170.13 5.5	[MIDR06.02.12D]	04.83- 02.90	CA721	28	60	05.83- 02.90	CS608	24	4.0
		04.83- 02.90	CA130IR	28	35	05.83- 02.90	CS1464	24	4.0
G 170.15 5.5	[MIDR06.02.12D]	04.83- 02.90	CA721	28	60	05.83- 02.90	CS608	24	4.0
		04.83- 02.90	CA130IR	28	35	05.83- 02.90	CS1464	24	4.0
G 170.16 5.5	[MIDR06.02.12D]	04.83- 02.90	CA721	28	60	05.83- 02.90	CS608	24	4.0
		04.83- 02.90	CA130IR	28	35	05.83- 02.90	CS1464	24	4.0
G 170.17 5.5	[MIDR06.02.12D]	04.83- 02.90	CA721	28	60	05.83- 02.90	CS608	24	4.0
		04.83- 02.90	CA130IR	28	35	05.83- 02.90	CS1464	24	4.0
G 200.13 6.2	(Manager)[MIDR06.02.26H]	05.90- 08.92	CA705IR	28	40	09.91- 03.93	CS608	24	4.0
		05.90- 03.91	CA721	28	60	09.91- 03.93	CS1464	24	4.0
		04.91- 08.92	CA898IR	28	60				
	[MIDR06.02.26Q]	09.92- 04.93	CA898IR	28	60	09.91- 03.93	CS1464	24	4.0
	[MIDR06.02.26H]	05.90- 08.92	CA705IR	28	40	05.90- 09.91	CS1464	24	4.0
	[MIDR06.02.26H]	05.90- 03.91	CA721	28	60	05.90- 09.91	CS608	24	4.0
G 200.15 6.2	(Manager)[MIDR06.02.26H]	05.90- 08.92	CA705IR	28	40	09.91- 03.93	CS608	24	4.0
		05.90- 03.91	CA721	28	60	09.91- 03.93	CS1464	24	4.0
		04.91- 08.92	CA898IR	28	60				
	[MIDR06.02.26Q]	06.91- 04.93	CA898IR	28	60	09.91- 03.93	CS608	24	4.0
	[MIDR06.02.26H]	05.90- 08.92	CA705IR	28	40	09.91- 03.93	CS1464	24	4.0
	[MIDR06.02.26H]	05.90- 03.91	CA721	28	60	05.90- 09.91	CS1464	24	4.0
G 200.16 6.2	(Manager)[MIDR06.02.26H]	05.90- 08.92	CA705IR	28	40	09.91- 03.93	CS608	24	4.0
		05.90- 03.91	CA721	28	60	09.91- 03.93	CS1464	24	4.0
		04.91- 08.92	CA898IR	28	60				
	[MIDR06.02.26Q]	09.92- 04.93	CA898IR	28	60	09.91- 03.93	CS608	24	4.0
	[MIDR06.02.26H]	05.90- 08.92	CA705IR	28	40	05.90- 09.91	CS1464	24	4.0
	[MIDR06.02.26H]	05.90- 03.91	CA721	28	60	05.90- 09.91	CS608	24	4.0
G 200.17 6.2	(Manager)[MIDR06.02.26H]	05.90- 08.92	CA705IR	28	40	09.91- 03.93	CS608	24	4.0
		05.90- 03.91	CA721	28	60	09.91- 03.93	CS1464	24	4.0
		04.91- 08.92	CA898IR	28	60				
	[MIDR06.02.26Q]	06.91- 04.93	CA898IR	28	60	09.91- 03.93	CS1464	24	4.0
	[MIDR06.02.26H]	05.90- 08.92	CA705IR	28	40	09.91- 03.93	CS608	24	4.0
	[MIDR06.02.26H]	05.90- 03.91	CA721	28	60	05.90- 09.91	CS1464	24	4.0
G 200.18 6.2	(Manager)[MIDR06.02.26H]	05.90- 08.92	CA705IR	28	40	09.91- 03.93	CS608	24	4.0
		05.90- 03.91	CA721	28	60	09.91- 03.93	CS1464	24	4.0
		04.91- 08.92	CA898IR	28	60				
	[MIDR06.02.26Q]	09.92- 04.93	CA898IR	28	60	09.91- 03.93	CS1464	24	4.0
	[MIDR06.02.26H]	05.90- 08.92	CA705IR	28	40	05.90- 09.91	CS608	24	4.0
	[MIDR06.02.26H]	05.90- 03.91	CA721	28	60	05.90- 09.91	CS1464	24	4.0
G 210.16 6.2	(Manager)[MIDR06.02.26W]	01.90- 08.92	CA705IR	28	40	05.92- 10.96	CS608	24	4.0
		01.90- 03.91	CA721	28	60	05.92- 10.96	CS1464	24	4.0
		04.91- 08.92	CA898IR	28	60				
	[MIDS06.20.30N]	11.83- 09.86	CA130IR	28	35	11.83- 02.90	CS688	24	6.6
	[MIDS06.20.30N1]	11.83- 02.90	CA705IR	28	40				
	[MIDS06.20.30N1]	11.83- 02.90	CA721	28	60				
G 210.17 8.8	[MIDS06.20.30N]	11.83- 09.86	CA130IR	28	35	11.83- 02.90	CS688	24	6.6
		11.83- 02.90	CA705IR	28	40				
		11.83- 02.90	CA721	28	60				
	[MIDS06.20.30N1]	11.83- 09.86	CA130IR	28	35	11.83- 02.90	CS688	24	6.6
	[MIDS06.20.30N1]	11.83- 02.90	CA705IR	28	40				
	[MIDS06.20.30N1]	11.83- 02.90	CA721	28	60				
G 210.18 6.2	(Manager)[MIDR06.02.26W]	01.90- 08.92	CA705IR	28	40	05.92- 10.96	CS1464	24	4.0
		01.90- 03.91	CA721	28	60	05.92- 10.96	CS608	24	4.0
		04.91- 08.92	CA898IR	28	60				
	[MIDS06.20.30N]	11.83- 09.86	CA130IR	28	35	11.83- 02.90	CS688	24	6.6
	[MIDS06.20.30N1]	11.83- 02.90	CA705IR	28	40				
	[MIDS06.20.30N1]	11.83- 02.90	CA721	28	60				
G 210.19 8.8	[MIDS06.20.30N]	11.83- 09.86	CA130IR	28	35	11.83- 02.90	CS688	24	6.6
		11.83- 02.90	CA705IR	28	40				
		11.83- 02.90	CA721	28	60				
	[MIDS06.20.30N1]	11.83- 09.86	CA130IR	28	35	11.83- 02.90	CS688	24	6.6
	[MIDS06.20.30N1]	11.83- 02.90	CA705IR	28	40				
	[MIDS06.20.30N1]	11.83- 02.90	CA721	28	60				
G 220.17 9.8	(Manager)[MIDS06.20.45J]	09.91- 10.96	CA898IR	28	60	09.91- 10.96	CS983	24	8.0
		09.91- 04.93	CS688	24	6.6				
	[MIDS06.20.45J3]	09.91- 10.96	CA705IR	28	40	09.91- 10.96	CS983	24	8.0
	[MIDS06.20.45J3]	09.91- 10.96	CA898IR	28	60	09.91- 04.93 09.91- 10.96	CS688 CS1128	24	6.6 6.6



	[MIDS06.20.45J]	03.91- 09.91	CA898IR	28 60		03.91- 04.93	CS688	24 6.6
						03.91- 09.91	CS983	24 8.0
G 220.19 9.8	(Manager)[MIDS06.20.45J]	09.91- 10.96	CA898IR	28 60		09.91- 10.96	CS983	24 8.0
						03.91- 04.93	CS688	24 6.6
	[MIDS06.20.45J3]	09.91- 10.96	CA898IR	28 60		03.91- 04.93	CS688	24 6.6
						09.91- 10.96	CS983	24 8.0
G 230.11 8.8	[MIDS06.20.30P]	03.84- 09.86	CA130IR	28 35		03.84- 06.93	CS688	24 6.6
		03.84- 06.93	CA705IR	28 40				
		03.84- 06.93	CA721	28 60				
G 230.13 8.8	(Manager)[MIDS06.20.30]	03.84- 09.86	CA130IR	28 35		03.84- 03.93	CS688	24 6.6
	[MIDS06.20.30P]	03.84- 06.93	CA705IR	28 40		03.84- 03.93	CS688	24 6.6
		03.84- 06.93	CA721	28 60				
	[MIDS06.20.30P]	03.84- 09.86	CA130IR	28 35		03.84- 06.93	CS688	24 6.6
		03.84- 06.93	CA705IR	28 40				
		03.84- 06.93	CA721	28 60				
G 230.15 8.8	[MIDS06.20.30P]	03.84- 09.86	CA130IR	28 35		03.84- 06.93	CS688	24 6.6
		03.84- 06.93	CA705IR	28 40				
		03.84- 06.93	CA721	28 60				
G 230.16 8.8	[MIDS06.20.30P]	03.84- 09.86	CA130IR	28 35		03.84- 06.93	CS688	24 6.6
		03.84- 06.93	CA705IR	28 40				
		03.84- 06.93	CA721	28 60				
G 230.17 8.8	[MIDS06.20.30P]	03.84- 09.86	CA130IR	28 35		03.84- 06.93	CS688	24 6.6
		03.84- 06.93	CA705IR	28 40				
		03.84- 06.93	CA721	28 60				
G 230.19 8.8	[MIDS06.20.30P]	03.84- 09.86	CA130IR	28 35		03.84- 06.93	CS688	24 6.6
		03.84- 06.93	CA705IR	28 40				
		03.84- 06.93	CA721	28 60				
G 230TI.13 6.2	(Manager)[MIDR06.02.26 X]	09.91- 03.93	CA705IR	28 40		09.91- 03.93	CS1464	24 4.0 SM
		05.92- 10.96	CA898IR	28 60		09.91- 03.93	CS608	24 4.0 LM
	[MIDR06.02.26D]	01.90- 03.93	CA705IR	28 40		09.91- 03.93	CS1464	24 4.0 SM
		01.91- 03.91	CA721	28 60		09.91- 03.93	CS608	24 4.0 LM
		04.91- 06.93	CA898IR	28 60				
	[MIDR06.02.26D]	01.90- 08.92	CA705IR	28 40		02.90- 08.91	CS1464	24 4.0 SM
		01.90- 03.91	CA721	28 60		02.90- 08.91	CS608	24 4.0 LM
		04.91- 06.93	CA898IR	28 60				
G 230TI.15 6.2	(Manager)[MIDR06.02.26 X]	09.91- 03.93	CA705IR	28 40		09.91- 03.93	CS1464	24 4.0 SM
		05.92- 10.96	CA898IR	28 60		09.91- 03.93	CS608	24 4.0 LM
	[MIDR06.02.26D]	01.90- 03.93	CA705IR	28 40		09.91- 03.93	CS1464	24 4.0 SM
		01.90- 03.91	CA721	28 60		09.91- 03.93	CS608	24 4.0 LM
		04.91- 06.93	CA898IR	28 60				
	[MIDR06.02.26D]	01.90- 08.92	CA705IR	28 40		02.90- 08.91	CS608	24 4.0 LM
		01.90- 03.91	CA721	28 60		02.90- 08.91	CS1464	24 4.0 SM
		04.91- 06.93	CA898IR	28 60				
G 230TI.16 6.2	(GAF,AWF,ABFT)[MIDR06.02.26D]	01.90- 03.91	CA705IR	28 40		09.91- 10.96	CS608	24 4.0 LM
		01.90- 03.91	CA721	28 60		09.91- 10.96	CS1464	24 4.0 SM
		04.91- 06.93	CA898IR	28 60				
	(Manager)[MIDR06.02.26 X]	09.91- 10.96	CA705IR	28 40		09.91- 10.96	CS608	24 4.0 LM
		05.92- 10.96	CA898IR	28 60		09.91- 10.96	CS1464	24 4.0 SM
	[MIDR06.02.26D]	01.90- 10.96	CA705IR	28 40		09.91- 10.96	CS1464	24 4.0 SM
		01.90- 03.91	CA721	28 60		09.91- 10.96	CS608	24 4.0 LM
		04.91- 06.93	CA898IR	28 60				
	[MIDR06.02.26D]	01.90- 08.92	CA705IR	28 40		02.90- 08.91	CS1464	24 4.0 SM
		01.90- 03.91	CA721	28 60		02.90- 08.91	CS608	24 4.0 LM
		04.91- 06.93	CA898IR	28 60				
G 230TI.17 6.2	(Manager)[MIDR06.02.26 X]	09.91- 10.96	CA705IR	28 40		09.91- 10.96	CS1464	24 4.0 SM
		05.92- 10.96	CA898IR	28 60		09.91- 10.96	CS608	24 4.0 LM
	[MIDR06.02.26D]	01.90- 10.96	CA705IR	28 40		09.91- 10.96	CS608	24 4.0 LM
		01.90- 03.91	CA721	28 60		09.91- 10.96	CS1464	24 4.0 SM
		04.91- 06.93	CA898IR	28 60				
	[MIDR06.02.26D]	01.90- 08.92	CA705IR	28 40		02.90- 08.91	CS608	24 4.0 LM
		01.90- 03.91	CA721	28 60		02.90- 08.91	CS1464	24 4.0 SM
		04.91- 06.93	CA898IR	28 60				
G 230TI.18 6.2	(Manager)[MIDR06.02.26 X]	05.92- 10.96	CA705IR	28 40		05.92- 10.96	CS1464	24 4.0 SM
		05.92- 10.96	CA898IR	28 60		05.92- 10.96	CS608	24 4.0 LM
	[MIDR06.02.26D]	01.90- 10.96	CA705IR	28 40		05.92- 10.96	CS1464	24 4.0 SM
		01.90- 03.91	CA721	28 60		05.92- 10.96	CS608	24 4.0 LM
		04.91- 06.93	CA898IR	28 60				
	[MIDR06.02.26D]	01.90- 08.92	CA705IR	28 40		02.90- 08.91	CS608	24 4.0 LM
		01.90- 03.91	CA721	28 60		02.90- 08.91	CS1464	24 4.0 SM
		04.91- 06.93	CA898IR	28 60				
G 230TI.19 6.2	(Manager)[MIDR06.02.26 X]	09.91- 10.96	CA705IR	28 40		09.91- 10.96	CS1464	24 4.0 SM
		05.92- 10.96	CA898IR	28 60		09.91- 10.96	CS608	24 4.0 LM
	[MIDR06.02.26D]	01.90- 10.96	CA705IR	28 40		09.91- 10.96	CS1464	24 4.0 SM
		01.90- 03.91	CA721	28 60		09.91- 10.96	CS608	24 4.0 LM
		04.91- 06.93	CA898IR	28 60				
	(Maxter)[MIDR06.02.26 X]	05.92- 08.92	CA898IR	28 60		10.92- 05.95	CS1464	24 4.0 SM
						10.92- 05.95	CS608	24 4.0 LM
	[MIDR06.02.26D]	01.90- 05.95	CA705IR	28 40		10.92- 05.95	CS1464	24 4.0 SM
		01.90- 05.95	CA721	28 60		10.92- 05.95	CS608	24 4.0 LM
		04.91- 06.93	CA898IR	28 60				
	[MIDR06.02.26D]	01.90- 08.92	CA705IR	28 40		02.90- 08.91	CS1464	24 4.0 SM
		01.90- 03.91	CA721	28 60		02.90- 08.91	CS608	24 4.0 LM
		04.91- 06.93	CA898IR	28 60				
G 260.15 9.8	[MIDS06.20.45]	10.82- 05.90	CA130IR	28 35		10.82- 05.90	CS688	24 6.6
G 260.16 9.8	[MIDS06.20.45]	10.82- 05.90	CA130IR	28 35		10.82- 05.90	CS688	24 6.6
		10.82- 05.90	CA705IR	28 40		10.82- 05.90	CS983	24 8.0
		10.82- 05.90	CA721	28 60				
G 260.17 9.8	[MIDS06.20.45]	10.82- 05.90	CA130IR	28 35		10.82- 05.90	CS688	24 6.6
	[MIDS06.20.45B]	10.82- 09.86	CA130IR	28 35		01.90- 06.93	CS688	24 6.6
		10.82- 05.90	CA705IR	28 40		05.87- 12.89	CS983	24 8.0
		10.82- 05.90	CA721	28 60				
G 260.19 9.8	(Maxter)[MIDR06.20.45C/4]	02.96- 06.97	CA1456IR	28 80	BO	02.96- 06.97	CS1128	24 6.6
		02.96- 06.97	CA1574IR	28 80	PR			
		02.96- 06.97	CA898IR	28 60				
	[MIDS06.20.45]	10.82- 05.90	CA130IR	28 35		10.82- 05.90	CS688	24 6.6
G 260.22 9.8	[MIDS06.20.45]	10.82- 05.90	CA130IR	28 35		10.82- 05.90	CS688	24 6.6
G 260.24 9.8	[MIDS06.20.45]	10.82- 05.90	CA130IR	28 35		10.82- 05.90	CS688	24 6.6
G 270.13 9.8	(Manager)[MIDR06.20.45B3]	03.93- 10.96	CA705IR	28 40		03.93- 10.96	CS1128	24 6.6
		03.93- 10.96	CA898IR	28 60		11.92- 10.96	CS688	24 6.6
						03.93- 10.96	CS983	24 8.0



**RENAULT V.I. Continued**

	[MIDS06.20.45B]	09.91- 10.96 09.91- 10.96	CA705IR CA898IR	28 40 28 60		09.91- 10.96 09.91- 10.96 09.91- 10.96	CS983 CS1128 CS688	24 8.0 24 6.6 24 6.6
G 270.14 9.8	(Manager)[MIDR06.20.45B3]	03.93- 10.96	CA705IR	28 40		03.93- 10.96	CS983	24 8.0
		03.93- 10.96	CA898IR	28 60		03.93- 10.96 03.93- 10.96	CS688 CS1128	24 6.6 24 6.6
G 270.15 9.8	(Manager)[MIDR06.20.45B3]	09.91- 10.96	CA705IR	28 40		09.91- 10.96	CS983	24 8.0
		09.91- 10.96	CA898IR	28 60		09.91- 10.96 09.91- 10.96	CS688 CS1128	24 6.6 24 6.6
	[MIDS06.20.45B]	09.91- 10.96 09.91- 10.96	CA705IR CA898IR	28 40 28 60		09.91- 10.96 09.91- 10.96	CS1128 CS983	24 6.6 24 8.0
G 270.16 9.8	(Manager)[MIDR06.20.45B3]	09.91- 10.96	CA705IR	28 40		09.91- 10.96	CS688	24 6.6
		09.91- 10.96	CA898IR	28 60		09.91- 10.96 06.95- 10.96 07.93- 05.95	CS1128 CS983	24 6.6 24 8.0
	[MIDS06.20.45B]	09.91- 10.96	CA898IR	28 60		09.91- 10.96 09.91- 10.96 09.91- 10.96	CS688 CS1128 CS983	24 6.6 24 6.6 24 8.0
G 270.17 9.8	(Manager)[MIDR06.20.45B3]	09.91- 10.96	CA705IR	28 40		09.91- 10.96	CS983	24 8.0
		09.91- 10.96	CA898IR	28 60		11.92- 10.96 06.95- 10.96	CS688 CS1128	24 6.6 24 6.6
G 270.18 9.8	(Manager)[MIDR06.20.45B3]	09.91- 10.96	CA705IR	28 40		11.92- 10.96	CS1128	24 6.6
		09.91- 10.96	CA898IR	28 60		11.92- 10.96 11.92- 10.96	CS983 CS688	24 8.0 24 6.6
G 270.19 9.8	(Manager)[MIDR06.20.45B3]	09.91- 10.96	CA705IR	28 40		07.93- 05.95	CS983	24 8.0
		09.91- 10.96	CA898IR	28 60		11.92- 10.96 06.95- 10.96	CS688 CS1128	24 6.6 24 6.6
	(Maxter)[MIDR06.20.45B3]	01.93- 10.96	CA1456IR	28 80	BO	01.95- 10.96	CS1128	24 6.6
		01.93- 10.96 01.93- 10.96	CA1574IR CA898IR	28 80 28 60	PR			
G 270.26 9.8	(Manager)[MIDR06.20.45B]	09.91- 10.96	CA705IR	28 40		07.93- 05.95	CS983	24 8.0
		09.91- 10.96	CA898IR	28 60		11.92- 10.96 06.95- 10.96	CS688 CS1128	24 6.6 24 6.6
G 280.13 9.8	(Manager)[MIDR06.20.45B3]	09.91- 10.96	CA705IR	28 40		09.91- 10.96	CS688	24 6.6
		09.91- 10.96	CA898IR	28 60				
	[MIDS06.20.45B]	01.90- 12.92 01.90- 08.91	CA705IR CA721	28 40 28 60		01.90- 06.93 01.90-	CS688 CS983	24 6.6 24 8.0
	[MIDS06.20.45B]	09.91- 06.93	CA898IR	28 60				
	[MIDS06.20.45B]	01.90- 12.92 01.90- 08.91	CA705IR CA721	28 40 28 60		01.90- 06.93 01.90- 06.93	CS688 CS983	24 6.6 24 8.0
	[MIDS06.20.45B]	09.91- 06.93	CA898IR	28 60				
G 280.15 9.8	(Manager)[MIDR06.20.45B3]	09.91- 10.96	CA705IR	28 40		09.91- 10.96	CS688	24 6.6
		09.91- 10.96	CA898IR	28 60		09.91- 10.96 09.91- 10.96	CS983 CS1128	24 8.0 24 6.6
	[MIDS06.20.45B]	01.90- 12.92 01.90- 08.91	CA705IR CA721	28 40 28 60		01.90- 06.93 01.90- 06.93	CS983 CS688	24 8.0 24 6.6
	[MIDS06.20.45B]	09.91- 06.93	CA898IR	28 60				
	[MIDS06.20.45B]	01.90- 12.92 01.90- 08.91	CA705IR CA721	28 40 28 60		01.90- 06.93 01.90- 06.93	CS983 CS688	24 8.0 24 6.6
	[MIDS06.20.45B]	09.91- 06.93	CA898IR	28 60				
G 280.16 9.8	(Manager)[MIDR06.20.45B3]	09.91- 10.96	CA705IR	28 40		09.91- 10.96	CS688	24 6.6
		09.91- 10.96	CA898IR	28 60		09.91- 10.96 09.91- 10.96	CS983 CS1128	24 8.0 24 6.6
	[MIDS06.20.45B]	01.90- 12.92 01.90- 08.91	CA705IR CA721	28 40 28 60		01.90- 06.93 01.90- 06.93	CS983 CS688	24 8.0 24 6.6
	[MIDS06.20.45B]	09.91- 06.93	CA898IR	28 60				
	[MIDS06.20.45B]	01.90- 12.92 01.90- 08.91	CA705IR CA721	28 40 28 60		01.90- 06.93 01.90- 06.93	CS983 CS688	24 8.0 24 6.6
	[MIDS06.20.45B]	09.91- 06.93	CA898IR	28 60				
G 280.17 9.8	(Manager)[MIDR06.20.45B]	01.90- 12.92	CA705IR	28 40		01.90- 10.96	CS688	24 6.6
		01.90- 08.91 09.91- 10.96	CA721 CA898IR	28 60 28 60		01.90- 06.93	CS983	24 8.0
G 280.18 9.8	(Manager)[MIDR06.20.45B]	01.90- 12.92	CA705IR	28 40		01.90- 06.93	CS688	24 6.6
		01.90- 08.91 09.91- 06.93	CA721 CA898IR	28 60 28 60		01.90- 06.93	CS983	24 8.0
	(Maxter)[MIDR06.20.45B]	10.92- 03.93	CA898IR	28 60		10.92- 03.93	CS688	24 6.6
	[MIDS06.20.45B]	01.90- 12.92	CA705IR	28 40		01.90- 06.93	CS688	24 6.6
	[MIDS06.20.45B]	01.90- 08.91 09.91- 06.93	CA721 CA898IR	28 60 28 60		01.90- 06.93	CS983	24 8.0
G 280.19 9.8	(Manager)[MIDR06.20.45B]	01.90- 12.92	CA705IR	28 40		01.90- 06.93	CS983	24 8.0
		01.90- 08.91 09.91- 06.93	CA721 CA898IR	28 60 28 60		01.90- 06.93	CS688	24 6.6
	[MIDS06.20.45B]	01.90- 12.92 01.90- 08.91	CA705IR CA721	28 40 28 60		01.90- 06.93 01.90-	CS688 CS983	24 6.6 24 8.0
	[MIDS06.20.45B]	09.91- 06.93	CA898IR	28 60				
G 280.24 9.8	(Manager)[MIDR06.20.45B]	01.90- 12.92	CA705IR	28 40		01.90- 06.93	CS688	24 6.6
		01.90- 08.91 09.91- 06.93	CA721 CA898IR	28 60 28 60		01.90- 06.93	CS983	24 8.0
	[MIDS06.20.45B]	01.90- 12.92 01.90- 08.91	CA705IR CA721	28 40 28 60		01.90- 06.93 01.90- 06.93	CS688 CS983	24 6.6 24 8.0
	[MIDS06.20.45B]	09.91- 06.93	CA898IR	28 60				
G 280.26 9.8	(Manager)[MIDR06.20.45B]	01.90- 12.92	CA705IR	28 40		01.90- 06.93	CS688	24 6.6
		01.90- 08.91 09.91- 06.93	CA721 CA898IR	28 60 28 60		01.90- 06.93	CS983	24 8.0
	[MIDS06.20.45B]	01.90- 12.92 01.90- 08.91	CA705IR CA721	28 40 28 60		01.90- 06.93 01.90- 06.93	CS688 CS983	24 6.6 24 8.0
	[MIDS06.20.45B]	09.91- 06.93	CA898IR	28 60				
G 290.17 9.8	[MIDR06.20.45]	11.85- 12.89	CA130IR	28 35		11.85- 12.89	CS688	24 6.6
G 290.19 9.8	[MIDR06.20.45]	11.85- 12.89	CA130IR	28 35		11.85- 12.89	CS688	24 6.6
G 290.22 9.8	[MIDR06.20.45]	11.85- 12.89	CA130IR	28 35		11.85- 12.89	CS688	24 6.6
G 290.24 9.8	[MIDR06.20.45]	11.85- 12.89	CA130IR	28 35		11.85- 12.89	CS688	24 6.6
G 290.26 9.8	[MIDR06.20.45]	11.85- 12.89	CA130IR	28 35		05.87- 12.89 11.85- 12.89	CS983 CS688	24 8.0 24 6.6



G 300.13 9.8	(Manager)[MIDR06.20.45D3]	01.90- 12.92	CA705IR	28	40	06.95- 10.96	CS1128	24	6.6
		01.90- 08.91	CA721	28	60	01.90- 03.93	CS983	24	8.0
	10.91- 10.96	CA898IR	28	60	01.90- 10.96	CS688	24	6.6	
	[MIDR06.20.45D]	01.90- 12.92	CA705IR	28	40	01.90- 03.93	CS688	24	6.6
G 300.15 9.8	(Manager)[MIDR06.20.45D]	09.92- 12.92	CA705IR	28	40	09.92- 10.96	CS983	24	8.0
		09.92- 10.96	CA898IR	28	60	09.92- 10.96	CS688	24	6.6
	06.95- 10.96	CS1128	24	6.6	01.90- 10.96	CS983	24	8.0	
	[MIDR06.20.45D3]	01.90- 12.92	CA705IR	28	40	06.95- 10.96	CS1128	24	6.6
G 300.16 9.8	(Manager)[MIDR06.20.45D]	01.90- 08.91	CA721	28	60	01.90- 10.96	CS688	24	6.6
		10.91- 10.96	CA898IR	28	60	01.90- 03.93	CS983	24	8.0
	[MIDR06.20.45D]	01.90- 12.92	CA705IR	28	40	01.90- 03.93	CS688	24	6.6
	[MIDR06.20.45D]	01.90- 08.91	CA721	28	60	01.90- 09.93	CS983	24	8.0
G 300.17 9.8	(Manager)[MIDR06.20.45D]	09.92- 12.92	CA705IR	28	40	06.95- 10.96	CS1128	24	6.6
		09.92- 10.96	CA898IR	28	60	09.92- 10.96	CS983	24	8.0
	09.92- 10.96	CS688	24	6.6	01.90- 10.96	CS688	24	6.6	
	[MIDR06.20.45D3]	01.90- 12.92	CA705IR	28	40	06.95- 10.96	CS1128	24	6.6
G 300.18 9.8	(Manager)[MIDR06.20.45D]	01.90- 08.91	CA721	28	60	01.90- 10.96	CS688	24	6.6
		10.91- 10.96	CA898IR	28	60	01.90- 10.96	CS688	24	6.6
	[MIDR06.20.45D]	01.90- 12.92	CA705IR	28	40	01.90- 03.93	CS688	24	6.6
	[MIDR06.20.45D]	01.90- 08.91	CA721	28	60	01.90- 03.93	CS983	24	8.0
G 300.19 9.8	(Manager)[MIDR06.20.45D]	09.92- 12.92	CA705IR	28	40	09.92- 10.96	CS688	24	6.6
		09.92- 10.96	CA898IR	28	60	06.95- 10.96	CS1128	24	6.6
	06.95- 10.96	CS983	24	8.0	09.92- 10.96	CS983	24	8.0	
	[MIDR06.20.45D3]	01.90- 12.92	CA705IR	28	40	01.90- 03.93	CS983	24	8.0
G 300.24 9.8	(Manager)[MIDR06.20.45D]	01.90- 08.91	CA721	28	60	06.95- 10.96	CS688	24	6.6
		10.91- 03.93	CA898IR	28	60	01.90- 03.93	CS688	24	6.6
	[MIDR06.20.45D3]	01.90- 12.92	CA705IR	28	40	01.90- 10.96	CS688	24	6.6
	[MIDR06.20.45D]	01.90- 08.91	CA721	28	60	06.95- 10.96	CS983	24	8.0
G 300.25 9.8	(Manager)[MIDR06.20.45D]	09.92- 12.92	CA705IR	28	40	09.92- 10.96	CS688	24	6.6
		09.92- 10.96	CA898IR	28	60	06.95- 10.96	CS1128	24	6.6
	06.95- 10.96	CS983	24	8.0	09.92- 10.96	CS983	24	8.0	
	[MIDR06.20.45D3]	01.90- 12.92	CA705IR	28	40	01.90- 03.93	CS983	24	8.0
G 300.26 9.8	(Manager)[MIDR06.20.45D]	01.90- 08.91	CA721	28	60	06.95- 10.96	CS688	24	6.6
		10.91- 10.96	CA898IR	28	60	01.90- 03.93	CS688	24	6.6
	[MIDR06.20.45D]	01.90- 12.92	CA705IR	28	40	01.90- 03.93	CS688	24	6.6
	[MIDR06.20.45D]	01.90- 08.91	CA721	28	60	01.90- 03.93	CS983	24	8.0
G 320.19 9.8	[MIDR06.20.45H]	05.88- 05.90	CA705IR	28	40	05.88- 05.90	CS688	24	6.6
		05.88- 05.90	CA721	28	60				
	[MIDR06.20.45H]	05.88- 05.90	CA705IR	28	40	05.88- 05.90	CS688	24	6.6
	[MIDR06.20.45H]	05.88- 05.90	CA721	28	60				
G 330.13 9.8	(Manager)[MIDR06.20.45H]	02.90- 12.92	CA705IR	28	40	02.90- 03.93	CS688	24	6.6
		02.90- 03.93	CA898IR	28	60	02.90- 03.93	CS983	24	8.0



RENAULT V.I. Continued

	[MIDR06.20.45H]	02.90-12.92	CA705IR	28 40	02.90-03.93	CS688	24 6.6
		02.90-01.91	CA721	28 60	02.90-03.93	CS983	24 8.0
		02.90-03.93	CA898IR	28 60			
G 330.15 9.8	(Manager)[MIDR06.20.45H]	02.90-12.92	CA705IR	28 40	02.90-03.93	CS983	24 8.0
		02.90-03.93	CA898IR	28 60	02.90-03.93	CS688	24 6.6
	[MIDR06.20.45H]	02.90-12.92	CA705IR	28 40	02.90-03.93	CS983	24 8.0
		02.90-01.91	CA721	28 60	02.90-03.93	CS688	24 6.6
		02.90-03.93	CA898IR	28 60			
G 330.16 9.8	(Manager)[MIDR06.20.45E]	09.91-10.96	CA898IR	28 60	09.91-10.96	CS983	24 8.0
					09.91-10.96	CS1128	24 6.6
					09.91-10.96	CS688	24 6.6
	[MIDR06.20.45E2]	09.91-10.92	CA898IR	28 60	09.91-10.92	CS688	24 6.6
	[MIDR06.20.45E3]	09.91-10.96	CA898IR	28 60	09.91-10.96	CS688	24 6.6
					09.91-10.96	CS1128	24 6.6
					09.91-10.96	CS983	24 8.0
	[MIDR06.20.45H]	02.90-12.92	CA705IR	28 40	02.90-03.93	CS688	24 6.6
		02.90-01.91	CA721	28 60			
		02.90-10.96	CA898IR	28 60			
	[MIDR06.20.45H]	02.90-12.92	CA705IR	28 40	02.90-03.93	CS688	24 6.6
		02.90-01.91	CA721	28 60	02.90-03.93	CS983	24 8.0
		02.90-03.93	CA898IR	28 60			
G 330.17 9.8	(Manager)[MIDR06.20.45H]	02.90-12.92	CA705IR	28 40	02.90-03.93	CS688	24 6.6
		02.90-01.91	CA721	28 60	02.90-03.93	CS983	24 8.0
		02.90-03.93	CA898IR	28 60			
	[MIDR06.20.45H]	02.90-12.92	CA705IR	28 40	02.90-03.93	CS688	24 6.6
		02.90-01.91	CA721	28 60	02.90-03.93	CS983	24 8.0
		02.90-03.93	CA898IR	28 60			
G 330.17/T 9.8	(Manager)[MIDR06.20.45E]				09.91-10.96	CS688	24 6.6
	[MIDR06.20.45E2]				09.91-10.96	CS688	24 6.6
	[MIDR06.20.45E3]				09.91-10.96	CS688	24 6.6
	[MIDR06.20.45H]				09.91-10.96	CS688	24 6.6
G 330.18 9.8	(Manager)[MIDR06.20.45E]	09.91-10.96	CA898IR	28 60	09.91-10.96	CS688	24 6.6
	[MIDR06.20.45E2]	09.91-10.92	CA898IR	28 60	09.91-10.92	CS688	24 6.6
	[MIDR06.20.45H]	02.90-12.92	CA705IR	28 40	02.90-10.96	CS688	24 6.6
		02.90-01.91	CA721	28 60			
		09.91-03.93	CA898IR	28 60			
	(Messenger)[MIDR06.20.45H]	02.90-12.92	CA705IR	28 40	02.90-03.93	CS688	24 6.6
		02.90-01.91	CA721	28 60	02.90-03.93	CS983	24 8.0
		10.91-03.93	CA898IR	28 60			
G 330.19 9.8	(Manager)[MIDR06.20.45E]	09.91-10.96	CA898IR	28 60	09.91-10.96	CS688	24 6.6
					09.91-10.96	CS1128	24 6.6
					09.91-10.96	CS983	24 8.0
	[MIDR06.20.45E2]	09.91-10.92	CA898IR	28 60	09.91-10.92	CS688	24 6.6
	[MIDR06.20.45E3]	09.91-10.96	CA898IR	28 60	09.91-10.96	CS688	24 6.6
					09.91-10.96	CS1128	24 6.6
					09.91-10.96	CS983	24 8.0
	[MIDR06.20.45H]	02.90-03.93	CA705IR	28 40	02.90-03.93	CS983	24 8.0
		02.90-01.91	CA721	28 60	02.90-03.93	CS688	24 6.6
		02.90-03.93	CA898IR	28 60			
	[MIDR06.20.45H]	02.90-12.92	CA705IR	28 40	02.90-03.93	CS688	24 6.6
		02.90-01.91	CA721	28 60	02.90-03.93	CS983	24 8.0
		02.90-03.93	CA898IR	28 60			
G 330.19/T 9.8	(Manager)[MIDR06.20.45E]				09.91-10.96	CS688	24 6.6
	[MIDR06.20.45E2]				09.91-10.96	CS688	24 6.6
	[MIDR06.20.45E3]				09.91-10.96	CS688	24 6.6
	[MIDR06.20.45H]				09.91-10.96	CS688	24 6.6
G 330.24 9.8	(Manager)[MIDR06.20.45H]	02.90-12.92	CA705IR	28 40	02.90-03.93	CS688	24 6.6
		02.90-01.91	CA721	28 60	02.92-	CS983	24 8.0
		10.91-03.93	CA898IR	28 60			
	[MIDR06.20.45H]	02.90-12.92	CA705IR	28 40	02.90-03.93	CS688	24 6.6
		02.90-01.91	CA721	28 60	02.90-03.93	CS983	24 8.0
		02.90-03.93	CA898IR	28 60			
G 330.26 9.8	(Manager)[MIDR06.20.45E2]	10.91-10.92	CA898IR	28 60	10.91-10.92	CS688	24 6.6
	[MIDR06.20.45E3]	10.91-10.96	CA898IR	28 60	10.91-10.96	CS688	24 6.6
					10.91-10.96	CS1128	24 6.6
					10.91-10.96	CS983	24 8.0
	[MIDR06.20.45H]	02.90-12.92	CA705IR	28 40	02.90-03.93	CS983	24 8.0
		02.90-01.91	CA721	28 60	02.90-03.93	CS688	24 6.6
		02.90-03.93	CA898IR	28 60			
	[MIDR06.20.45H]	02.90-12.92	CA705IR	28 40	02.90-03.93	CS688	24 6.6
		02.90-01.91	CA721	28 60	02.90-03.93	CS983	24 8.0
		02.90-03.93	CA898IR	28 60			
G 340 9.8	(Manager)[MIDR06.20.45E]	01.90-03.93	CA721	28 60	01.90-03.93	CS688	24 6.6
		09.91-03.93	CA898IR	28 60			
	[MIDR06.20.45E2]	10.91-10.92	CA898IR	28 60	01.90-10.92	CS688	24 6.6
					10.91-10.92	CS983	24 8.0
	[MIDR06.20.45E3]	02.92-10.96	CA898IR	28 60	02.92-10.96	CS688	24 6.6
					06.95-10.96	CS1128	24 6.6
	[MIDR06.20.45H]	09.91-10.96	CA898IR	28 60	10.91-03.93	CS983	24 8.0
					09.91-10.96	CS1128	24 6.6
					01.90-03.93	CS688	24 6.6
G 340TI 9.8	(Manager)[MIDR06.20.45E]	01.90-01.91	CA721	28 60	01.90-03.93	CS983	24 8.0
		09.91-03.93	CA898IR	28 60	01.90-03.93	CS688	24 6.6
	[MIDR06.20.45E3]	02.92-10.96	CA898IR	28 60	02.92-10.96	CS983	24 8.0
					02.92-10.96	CS688	24 6.6
G 340TI.16 9.8	(Manager)[MIDR06.20.45E]	01.90-01.91	CA721	28 60	01.90-03.93	CS688	24 6.6
		09.91-03.93	CA898IR	28 60			
	[MIDR06.20.45E2]	10.91-10.92	CA898IR	28 60	10.91-10.92	CS688	24 6.6
	[MIDR06.20.45E3]	02.92-10.96	CA898IR	28 60	06.95-10.96	CS1128	24 6.6
					02.92-10.96	CS688	24 6.6
	[MIDR06.20.45H]	09.91-10.96	CA898IR	28 60	09.91-10.96	CS983	24 8.0
					09.91-10.96	CS1128	24 6.6
					09.91-10.96	CS688	24 6.6
G 340TI.17 9.8	(Manager)[MIDR06.20.45E]	01.90-01.91	CA721	28 60	01.90-03.93	CS688	24 6.6
		09.91-03.93	CA898IR	28 60			
	[MIDR06.20.45E2]	10.91-10.92	CA898IR	28 60	10.91-10.92	CS688	24 6.6
	[MIDR06.20.45E3]	02.92-10.96	CA898IR	28 60	06.95-10.96	CS1128	24 6.6
					02.92-10.96	CS688	24 6.6
	[MIDR06.20.45H]	09.91-10.96	CA898IR	28 60	09.91-10.96	CS983	24 8.0
					09.91-10.96	CS688	24 6.6





G 340ti.18 9.8	(Manager)[MIDR06.20.45E]	01.90- 01.91	CA721	28	60	01.90- 03.93	CS688	24	6.6
		09.91- 03.93	CA898IR	28	60	01.90- 03.93	CS983	24	8.0
	[MIDR06.20.45E2]	01.90- 10.92	CA898IR	28	60	01.90- 10.92	CS688	24	6.6
						01.90- 10.92	CS983	24	8.0
	[MIDR06.20.45E3]	02.92- 10.96	CA898IR	28	60	10.91- 10.96	CS983	24	8.0
						06.95- 10.96	CS1128	24	6.6
						01.90- 10.96	CS688	24	6.6
G 340Ti.19 9.8	(Maxter)[MIDR06.20.45E/41]	02.96- 06.97	CA898IR	28	60	02.96- 06.97	CS1128	24	6.6
						10.92- 10.96	CS688	24	6.6
	[MIDR06.20.45E3]	10.92- 10.96	CA898IR	28	60	05.93- 10.96	CS1128	24	6.6
						10.92- 10.96	CS688	24	6.6
	[MIDR06.20.45E3]	02.92- 10.96	CA898IR	28	60	05.93- 10.96	CS1128	24	6.6
	[MIDR06.20.45H]	01.90- 08.91	CA705IR	28	40	01.90- 08.91	CS688	24	6.6
		01.90- 08.91	CA898IR	28	60	01.90- 08.91	CS983	24	8.0
G 340ti.19.G 330.19 9.8	(Manager)[MIDR06.20.45E]					09.91- 10.96	CS688	24	6.6
	[MIDR06.20.45E2]					09.91- 10.96	CS688	24	6.6
	[MIDR06.20.45E3]					09.91- 10.96	CS688	24	6.6
	[MIDR06.20.45H]					09.91- 10.96	CS688	24	6.6
G 340ti.19/T 9.8	(Manager)[MIDR06.20.45E]					09.91- 10.96	CS688	24	6.6
	[MIDR06.20.45E2]					09.91- 10.96	CS688	24	6.6
	[MIDR06.20.45E3]					09.91- 10.96	CS688	24	6.6
	[MIDR06.20.45H]					09.91- 10.96	CS688	24	6.6
G 340Ti.25 9.8	(Maxter)[MIDR06.20.45E/41]	02.96- 06.97	CA898IR	28	60	02.96- 06.97	CS1128	24	6.6
						10.92- 10.96	CS688	24	6.6
	[MIDR06.20.45E3]	10.92- 10.96	CA898IR	28	60	05.93- 10.96	CS1128	24	6.6
G 340Ti.25 9.8	(Maxter)[MIDR06.20.45E/41]	02.96- 06.97	CA898IR	28	60	02.96- 06.97	CS1128	24	6.6
						10.92- 10.96	CS688	24	6.6
	[MIDR06.20.45E3]	10.92- 10.96	CA898IR	28	60	05.93- 10.96	CS1128	24	6.6
G 340Ti.26 9.8	(Manager)[MIDR06.20.45E2]	10.91- 10.92	CA898IR	28	60	10.91- 03.93	CS983	24	8.0
						10.91- 03.93	CS688	24	6.6
	[MIDR06.20.45E3]	02.92- 10.96	CA898IR	28	60	06.95- 10.96	CS1128	24	6.6
						02.92- 10.96	CS688	24	6.6
	[MIDR06.20.45H]	10.91- 10.96	CA898IR	28	60	05.93- 10.96	CS1128	24	6.6
						10.91- 10.96	CS688	24	6.6
						10.91- 10.96	CS983	24	8.0
G 340Ti.32 9.8	(Maxter)[MIDR06.20.45E/41]	10.92- 06.97	CA898IR	28	60	10.92- 10.96	CS688	24	6.6
						02.96- 06.97	CA1456IR	28	80
						02.96- 06.97	CA1574IR	28	80
									PR
	[MIDR06.20.45E3]	10.92- 10.96	CA898IR	28	60	05.93- 10.96	CS1128	24	6.6
						02.96- 06.97	CA1456IR	28	80
						02.96- 06.97	CA1574IR	28	80
G 340Ti.32 9.8	(Maxter)[MIDR06.20.45E/41]	10.92- 06.97	CA898IR	28	60	10.92- 10.96	CS688	24	6.6
						02.96- 06.97	CA1456IR	28	80
						02.96- 06.97	CA1574IR	28	80
									PR
	[MIDR06.20.45E3]	10.92- 10.96	CA898IR	28	60	05.93- 10.96	CS1128	24	6.6
						02.96- 06.97	CA1456IR	28	80
						02.96- 06.97	CA1574IR	28	80
G 340Ti.34 9.8	(Maxter)[MIDR06.20.45D/41]	10.92- 06.97	CA898IR	28	60	02.96- 06.97	CS1128	24	6.6
						06.95- 06.97	CS1128	24	6.6
	[MIDR06.20.45D3]	10.92- 06.97	CA898IR	28	60	10.92- 06.97	CS688	24	6.6
	[MIDR06.20.45E/41]	10.92- 06.97	CA898IR	28	60	10.92- 10.96	CS688	24	6.6
	[MIDR06.20.45E3]	10.92- 10.96	CA898IR	28	60	02.96- 06.97	CS1128	24	6.6
G 340Ti.40 9.8	(Maxter)[MIDR06.20.45E/41]	10.92- 06.97	CA898IR	28	60	10.92- 10.96	CS688	24	6.6
						05.93- 10.96	CS1128	24	6.6
						02.96- 06.97	CA1456IR	28	80
						02.96- 06.97	CA1574IR	28	80
									PR
G 340Ti.40 9.8	(Maxter)[MIDR06.20.45E/41]	10.92- 06.97	CA898IR	28	60	02.96- 06.97	CS1128	24	6.6
						10.92- 10.96	CA898IR	28	60
						02.96- 10.96	CA1456IR	28	80
						02.96- 10.96	CA1574IR	28	80
									PR
GLM 280 12.0	[MIDAS 06.35.40 D]	06.80- 06.91	CA721	28	60				
GT 9.8	(Iliade)[MIDR06.20.45M41]	04.98-	CA1456IR	28	80	04.98-	CS1128	24	6.6
						04.98-	CA1667IR	28	140
GTC 9.8	(Iliade)[MIDR06.20.45M41]	04.98-	CA1456IR	28	80	04.98-	CS688	24	6.6
						04.98-	CA1667IR	28	140
GTE 9.8	(Iliade)[MIDR06.20.45M41]	04.98-	CA1456IR	28	80	04.98-	CS688	24	6.6
						04.98-	CA1667IR	28	140
GTX 11.1	(Iliade)[MIDR06.23.56A/41]	01.97-	CA1456IR	28	80	01.97-	CS688	24	6.6
						01.97-	CA1667IR	28	140
GTXE 11.1	(Iliade)[MIDR06.23.56A/41]	01.97-	CA1456IR	28	80	01.97-	CS983	24	8.0
						01.97-	CA1667IR	28	140
Iliade 11.1	(Iliade)[MIDR 06.23.56.]					10.96- 09.01	CS688	24	6.6
						10.96- 09.01	CA1456IR	28	80
Iliade 9.9	(Iliade)[MIDR 06.20.45 M41]	10.96- 09.01	CA1456IR	28	80	10.96- 09.01	CS983	24	8.0
						10.96- 09.01	CA1667IR	28	140
Line 9.9	(Agora)[MIR 06.20.45 B41]	05.98-	CA1456IR	28	80	05.98-	CS688	24	6.6
						10.96- 09.01	CA1456IR	28	80
						10.96- 09.01	CA1667IR	28	140
		05.98-	CA1667IR	28	140	05.98-	CS688	24	6.6



**RENAULT V.I. Continued**

	[M17R 06.20.45 C41]	05.98- 05.98-	CA1456IR CA1667IR	28 80 28 140		05.98- 05.98-	CS1128 CS688	24 6.6 24 6.6
M 140.12 5.5	(Midliner)[MIDS06.02.12C]	06.89- 03.93	CA705IR	28 40		05.89- 03.93	CS1464	24 4.0 SM
		06.89- 12.90 01.91- 03.93	CA721 CA898IR	28 60 28 60		05.89- 03.93	CS608	24 4.0 LM
M 140.13 5.5	(Midliner)[MIDS06.02.12C]	06.89- 03.93	CA705IR	28 40		04.89- 03.93	CS608	24 4.0 LM
		06.89- 12.90 01.91- 03.93	CA721 CA898IR	28 60 28 60		04.89- 03.93	CS1464	24 4.0 SM
M 150.09 6.2	(Midliner)[MIDR06.02.26U]	11.92- 10.96	CA898IR	28 60		11.92- 10.96	CS608	24 4.0 LM
						11.92- 10.96	CS1464	24 4.0 SM
M 150.11 6.2	(Midliner)[MIDR06.02.26U]	11.92- 10.96	CA898IR	28 60		11.92- 10.96	CS608	24 4.0 LM
						11.92- 10.96	CS1464	24 4.0 SM
M 150.12 6.2	(Midliner)[MIDR06.02.26U]	11.92- 10.96	CA898IR	28 60		11.92- 10.96	CS1464	24 4.0 SM
						11.92- 10.96	CS608	24 4.0 LM
	[MIDR06.02.26U/4]	05.96- 09.98 10.98- 12.00	CA898IR CA1852IR	28 60 28 60		11.92- 01.00 11.92- 01.00	CS608 CS1464	24 4.0 LM 24 4.0 SM
M 150.13 6.2	(Midliner)[MIDR06.02.26U]	11.92- 10.96	CA898IR	28 60		11.92- 10.96	CS608	24 4.0 LM
						11.92- 10.96	CS1464	24 4.0 SM
	[MIDR06.02.26U/4]	05.96- 09.98 10.98- 12.00	CA898IR CA1852IR	28 60 28 60		05.96- 01.00 05.96- 01.00	CS1464 CS608	24 4.0 SM 24 4.0 LM
M 150.14 6.2	(Midliner)[MIDR06.02.26U]	11.92- 10.96	CA898IR	28 60		11.92- 10.96	CS1464	24 4.0 SM
						11.92- 10.96	CS608	24 4.0 LM
M 160.12 5.5	(Midliner)[MIDS06.02.12B]	06.89- 03.93	CA705IR	28 40		05.89- 03.93	CS608	24 4.0 LM
		06.89- 12.90 01.91- 03.93	CA721 CA898IR	28 60 28 60		05.89- 03.93	CS1464	24 4.0 SM
M 160.13 5.5	(Midliner)[MIDS06.02.12B]	06.89- 03.93	CA705IR	28 40		05.89- 03.93	CS1464	24 4.0 SM
		06.89- 12.90 01.91- 03.93	CA721 CA898IR	28 60 28 60		05.89- 03.93	CS608	24 4.0 LM
M 160.14 5.5	(Midliner)[MIDS06.02.12B]	06.89- 03.93	CA705IR	28 40		05.89- 03.93	CS1464	24 4.0 SM
		06.89- 12.90 01.91- 03.93	CA721 CA898IR	28 60 28 60		05.89- 03.93	CS608	24 4.0 LM
M 160.15 5.5	(Midliner)[MIDS06.02.12B]	06.89- 03.93	CA705IR	28 40		05.89- 03.93	CS608	24 4.0 LM
		06.89- 12.90 01.91- 03.93	CA721 CA898IR	28 60 28 60		05.89- 03.93	CS1464	24 4.0 SM
M 180.10 6.2	(Midliner)[MIDR06.02.26V]	11.92- 10.96	CA898IR	28 60		11.92- 10.96	CS1464	24 4.0 SM
						11.92- 10.96	CS608	24 4.0 LM
M 180.11 6.2	(Midliner)[MIDR06.02.26V]	11.92- 10.96	CA898IR	28 60		11.92- 10.96	CS1464	24 4.0 SM
						11.92- 10.96	CS608	24 4.0 LM
M 180.12 6.2	(Midliner)[MIDR06.02.26V]	11.92- 10.96	CA898IR	28 60		11.92- 10.96	CS1464	24 4.0 SM
						11.92- 10.96	CS608	24 4.0 LM
	[MIDR06.02.26V/41]	05.96- 09.98 10.98- 01.00	CA898IR CA1852IR	28 60 28 60		05.96- 01.00 05.96- 01.00	CS1464 CS608	24 4.0 SM 24 4.0 LM
M 180.13 6.2	(Midliner)[MIDR06.02.26V]	11.92- 10.96	CA898IR	28 60		11.92- 10.96	CS608	24 4.0 LM
						11.92- 10.96	CS1464	24 4.0 SM
	[MIDR06.02.26V/41]	05.96- 09.98 10.98- 01.00	CA898IR CA1852IR	28 60 28 60		05.96- 01.00 05.96- 01.00	CS608 CS1464	24 4.0 LM 24 4.0 SM
M 180.15 6.2	(Midliner)[MIDR06.02.26V]	11.92- 10.96	CA898IR	28 60		11.92- 10.96	CS608	24 4.0 LM
						11.92- 10.96	CS1464	24 4.0 SM
	[MIDR06.02.26V/41]	10.96- 09.98 10.98- 01.00	CA898IR CA1852IR	28 60 28 60		10.96- 01.00 10.96- 01.00	CS1464 CS608	24 4.0 SM 24 4.0 LM
M 180.16 6.2	(Midliner)[MIDR06.02.26V]	11.92- 10.96	CA898IR	28 60		11.92- 10.96	CS608	24 4.0 LM
						11.92- 10.96	CS1464	24 4.0 SM
	[MIDR06.02.26V/41]	05.96- 09.98 10.98- 01.00	CA898IR CA1852IR	28 60 28 60		05.96- 01.00 05.96- 01.00	CS1464 CS608	24 4.0 SM 24 4.0 LM
M 200.10 6.2	(Midliner)[MIDR06.02.26H]	05.88- 03.93	CA721	28 60		05.88- 03.93	CS1464	24 4.0 SM
		06.89- 03.93	CA705IR	28 40		05.88- 03.93	CS608	24 4.0 LM
M 200.12 6.2	(Midliner)[MIDR06.02.26H]	05.88- 03.93	CA721	28 60		05.88- 03.93	CS608	24 4.0 LM
		06.89- 03.93	CA705IR	28 40		05.88- 03.93	CS1464	24 4.0 SM
M 200.13 6.2	(Midliner)[MIDR06.02.26H]	05.88- 03.93	CA721	28 60		05.88- 03.93	CS1464	24 4.0 SM
		06.89- 03.93	CA705IR	28 40		05.88- 03.93	CS608	24 4.0 LM
M 200.14 6.2	(Midliner)[MIDR06.02.26H]	05.88- 03.93	CA721	28 60		05.88- 03.93	CS1464	24 4.0 SM
		06.89- 03.93	CA705IR	28 40		05.88- 03.93	CS608	24 4.0 LM
M 200.15 6.2	(Midliner)[MIDR06.02.26H]	05.88- 03.93	CA721	28 60		05.88- 03.93	CS608	24 4.0 LM
		06.89- 03.93	CA705IR	28 40		05.88- 03.93	CS1464	24 4.0 SM
M 200.16 6.2	(Midliner)[MIDR06.02.26H]	05.88- 03.93	CA705IR	28 40		05.88- 03.93	CS1464	24 4.0 SM
		05.88- 03.93	CA721	28 60		05.88- 03.93	CS608	24 4.0 LM
M 210.12 6.2	(Midliner)[MIDR06.02.26W]	05.92- 01.93	CA705IR	28 40		05.92- 01.00	CS1464	24 4.0 SM
		05.92- 01.93 02.93- 09.96	CA721 CA898IR	28 60 28 60		05.92- 01.00	CS608	24 4.0 LM
	[MIDR06.02.26W/41]	05.96- 09.98 10.98- 01.00	CA898IR CA1852IR	28 60 28 60		05.92- 01.00 05.92- 01.00	CS608 CS1464	24 4.0 LM 24 4.0 SM
M 210.13 6.2	(Midliner)[MIDR06.02.26W]	05.92- 01.93	CA705IR	28 40		05.92- 01.00	CS608	24 4.0 LM
		05.92- 01.93 01.93- 09.96	CA721 CA898IR	28 60 28 60		05.92- 01.00	CS1464	24 4.0 SM
	[MIDR06.02.26W/41]	05.96- 01.00 05.96- 09.98 10.98- 01.00	CA1456IR CA898IR CA1852IR	28 80 28 60 28 60		05.92- 01.00 05.92- 01.00	CS1464 CS608	24 4.0 SM 24 4.0 LM
M 210.14 6.2	(Midliner)[MIDR06.02.26W]	05.92- 01.93	CA705IR	28 40		05.92- 10.96	CS1464	24 4.0 SM
		05.92- 01.93 02.93- 09.96	CA721 CA898IR	28 60 28 60		05.92- 10.96	CS608	24 4.0 LM
	[MIDR06.02.26W/41]	05.96- 01.00 05.96- 09.98 10.98- 01.00	CA1456IR CA898IR CA1852IR	28 80 28 60 28 60		05.96- 01.00 05.96- 01.00	CS608 CS1464	24 4.0 LM 24 4.0 SM
M 210.15 6.2	(Midliner)[MIDR06.02.26W]	05.92- 01.93	CA705IR	28 40		05.92- 01.00	CS608	24 4.0 LM
		05.92- 01.93 01.93- 09.96	CA721 CA898IR	28 60 28 60		05.92- 01.00	CS1464	24 4.0 SM



	[MIDR06.02.26W/41]	05.96- 01.00 05.96- 09.98 10.98- 01.00	CA1456IR 28 80 CA898IR 28 60 CA1852IR 28 60		05.92- 01.00 05.92- 01.00	CS608 24 4.0 LM CS1464 24 4.0 SM
M 210.16 6.2	(Midliner)[MIDR06.02.26W]	05.92- 01.93	CA705IR 28 40		05.92- 01.00	CS608 24 4.0 LM
		05.92- 01.93 02.93- 09.96	CA721 28 60 CA898IR 28 60		05.92- 01.00	CS1464 24 4.0 SM
	[MIDR06.02.26W/41]	05.96- 01.00 05.96- 09.98 10.98- 01.00	CA1456IR 28 80 CA898IR 28 60 CA1852IR 28 60		05.92- 01.00 05.92- 01.00	CS1464 24 4.0 SM CS608 24 4.0 LM
M 230.10 6.2	(Midliner)[MIDR06.02.26D]	05.89- 07.92	CA721 28 60		05.89- 07.92	CS608 24 4.0 LM
		06.89- 03.93	CA705IR 28 40		05.89- 07.92	CS1464 24 4.0 SM
	[MIDR06.02.26S]	05.89- 07.92 06.89- 03.93	CA721 28 60 CA705IR 28 40		05.89- 07.92 05.89- 07.92	CS1464 24 4.0 SM CS608 24 4.0 LM
M 230.12 6.2	(Midliner)[MIDR06.02.26 X]	05.92- 10.96	CA898IR 28 60		05.92- 10.96	CS608 24 4.0 LM
					05.92- 10.96	CS1464 24 4.0 SM
	[MIDR06.02.26D]	05.89- 07.92 06.89- 03.93	CA721 28 60 CA705IR 28 40		05.89- 07.92 05.89- 07.92	CS1464 24 4.0 SM CS608 24 4.0 LM
	[MIDR06.02.26S]	05.89- 07.92 06.89- 03.93	CA721 28 60 CA705IR 28 40		05.89- 07.92 05.89- 07.92	CS608 24 4.0 LM CS1464 24 4.0 SM
M 230.13 6.2	(Midliner)[MIDR06.02.26 X]	05.92- 10.96	CA898IR 28 60		05.89- 10.96	CS1464 24 4.0 SM
					05.89- 10.96	CS608 24 4.0 LM
	[MIDR06.02.26D]	05.89- 07.92 06.89- 03.93	CA721 28 60 CA705IR 28 40		05.89- 07.92 05.89- 07.92	CS608 24 4.0 LM CS1464 24 4.0 SM
	[MIDR06.02.26S]	05.89- 07.92 06.89- 03.93	CA721 28 60 CA705IR 28 40		05.89- 07.92 05.89- 07.92	CS608 24 4.0 LM CS1464 24 4.0 SM
M 230.15 6.2	(Midliner)[MIDR06.02.26 X]	05.89- 10.96	CA898IR 28 60		05.89- 10.96	CS608 24 4.0 LM
					05.89- 10.96	CS1464 24 4.0 SM
	[MIDR06.02.26D]	05.89- 03.93 05.89- 03.93	CA705IR 28 40 CA721 28 60		05.89- 10.96 05.89- 10.96	CS608 24 4.0 LM CS1464 24 4.0 SM
	[MIDR06.02.26S]	05.89- 03.93 06.89- 03.93	CA721 28 60 CA705IR 28 40		05.89- 10.96 05.89- 10.96	CS1464 24 4.0 SM CS608 24 4.0 LM
M 230.16 6.2	(Midliner)[MIDR06.02.26 X]	05.89- 10.96	CA898IR 28 60		05.89- 10.96	CS1464 24 4.0 SM
					05.89- 10.96	CS608 24 4.0 LM
	[MIDR06.02.26D]	05.89- 03.93 05.89- 03.93	CA705IR 28 40 CA721 28 60		05.89- 10.96 05.89- 10.96	CS1464 24 4.0 SM CS608 24 4.0 LM
	[MIDR06.02.26S]	05.89- 03.93 06.89- 03.93	CA721 28 60 CA705IR 28 40		05.89- 10.96 05.89- 10.96	CS608 24 4.0 LM CS1464 24 4.0 SM
M 250.13 6.2	(Midliner)[MIDR06.02.26Y/41]	05.96- 01.00	CA1456IR 28 80		05.96- 01.00	CS608 24 4.0 LM
		05.96- 01.00	CA898IR 28 60		05.96- 01.00	CS1464 24 4.0 SM
M 250.15 6.2	(Midliner)[MIDR06.02.26Y/41]	05.96- 01.00	CA1456IR 28 80		05.96- 01.00	CS1464 24 4.0 SM
		05.96- 01.00	CA898IR 28 60		05.96- 01.00	CS608 24 4.0 LM
M 250.16 6.2	(Midliner)[MIDR06.02.26Y/41]	05.96- 01.00	CA1456IR 28 80		05.96- 01.00	CS608 24 4.0 LM
		05.96- 01.00	CA898IR 28 60		05.96- 01.00	CS608 24 4.0 LM
ME 160.13 5.5	(Midliner)[MIDS06.02.12B]	01.90- 03.93	CA898IR 28 60 CA705IR 28 40		05.96- 01.00	CS608 24 4.0 LM
		06.90- 03.93	CA721 28 60		05.89- 03.93	CS1464 24 4.0 SM
ME 160.15 5.5	(Midliner)[MIDS06.02.12B]	01.90- 01.93	CA705IR 28 40		05.89- 03.93	CS608 24 4.0 LM
		06.90- 03.93	CA721 28 60		05.89- 03.93	CS1464 24 4.0 SM
ME 180.15 5.5	(Midliner)[MIDR06.02.12D]	01.90- 01.93	CA705IR 28 40		05.89- 03.93	CS1464 24 4.0 SM
		01.90- 01.93	CA721 28 60		05.89- 03.93	CS608 24 4.0 LM
R 310.16 12.0	[MIDR06.35.40C]	10.80- 03.89 10.80- 03.89	CA705IR 28 40 CA898IR 28 60			
R 310.17 12.0	[MIDR06.35.40C]	10.80- 03.89 10.80- 03.89	CA705IR 28 40 CA898IR 28 60			
R 310.19 12.0	[MIDR06.35.40C]	10.80- 03.89 10.80- 03.89	CA705IR 28 40 CA898IR 28 60			
R 310.22 12.0	[MIDR06.35.40C]	10.80- 03.89 10.80- 03.89	CA705IR 28 40 CA898IR 28 60			
R 330.17 9.8	[MIDR06.20.45E]	05.88- 05.91	CA721 28 60		05.88- 05.91	CS688 24 6.6
R 330.19 9.8	[MIDR06.20.45E]	05.88- 05.91	CA721 28 60		05.88- 05.91	CS688 24 6.6
R 330.24 9.8	[MIDR06.20.45E]	05.88- 05.91	CA721 28 60		05.88- 05.91	CS688 24 6.6
R 332 9.8	[MIHR06.20.45A41]	07.96- 12.03	CA1667IR 28 140			
R 340.17 12.0	[MIDR06.35.40G]	03.86- 01.90 03.86- 01.90	CA721 28 60 CA898IR 28 60			
R 340.19 12.0	[MIDR06.35.40G]	03.86- 01.90 03.86- 01.90	CA721 28 60 CA898IR 28 60			
R 340.24 12.0	[MIDR06.35.40G]	03.86- 01.90 03.86- 01.90	CA721 28 60 CA898IR 28 60			
R 340TI.16 9.8	(Major)[MIDR06.20.45E3]	02.92- 01.96	CA721 28 60		05.91- 10.96	CS1128 24 6.6
		02.92- 01.96	CA898IR 28 60		05.91- 10.96	CS983 24 8.0
	[MIDR06.20.45E]	01.90- 12.92 01.90- 12.92	CA721 28 60 CA898IR 28 60		01.90- 12.92	CS688 24 6.6
R 340TI.17 11.1	[MIDR06.20.45E]	01.90- 12.92 01.90- 12.92	CA721 28 60 CA898IR 28 60		01.90- 12.92	CS688 24 6.6
R 340TI.17 9.8	(Major)[MIDR06.20.45E3]	02.92- 01.96	CA721 28 60		05.91- 10.96	CS1128 24 6.6
		02.92- 01.96	CA898IR 28 60		05.91- 10.96	CS983 24 8.0
R 340TI.18 9.8	(Major)[MIDR06.20.45E3]	02.92- 10.96	CA721 28 60		05.91- 10.96	CS983 24 8.0
		02.92- 10.96	CA898IR 28 60		05.91- 10.96	CS1128 24 6.6
	[MIDR06.20.45E]	01.90- 12.92 01.90- 12.92	CA721 28 60 CA898IR 28 60		01.90- 12.92	CS688 24 6.6
R 340TI.19 11.1	[MIDR06.20.45E]	01.90- 12.92 01.90- 12.92	CA721 28 60 CA898IR 28 60		01.90- 12.92	CS688 24 6.6
R 340TI.19 9.8	(Major)[MIDR06.20.45E3]	02.92- 01.96	CA721 28 60		05.91- 10.96	CS1128 24 6.6
		02.92- 01.96	CA898IR 28 60		05.91- 10.96	CS983 24 8.0
	[MIDR06.20.45E]	01.90- 12.92 01.90- 12.92	CA721 28 60 CA898IR 28 60		01.90- 12.92	CS688 24 6.6
R 340TI.24 9.8	(Major)[MIDR06.20.45E]	01.90- 09.90	CA721 28 60		05.91- 10.96	CS983 24 8.0
		10.90- 12.96	CA898IR 28 60			
	[MIDR06.20.45E]	01.90- 12.92 01.90- 12.92	CA721 28 60 CA898IR 28 60		01.90- 12.92	CS688 24 6.6
R 340TI.26 9.8	(Major)[MIDR06.20.45E3]	02.92- 01.96	CA721 28 60		05.91- 10.96	CS1128 24 6.6
		02.92- 01.96	CA898IR 28 60		05.91- 10.96	CS983 24 8.0

**RENAULT V.I. Continued**

	[MIDR06.20.45E]	01.90- 12.92	CA721	28 60				
		01.90- 12.92	CA898IR	28 60		01.90- 12.92	CS688	24 6.6
R 350.17 12.0	(Major)[MIDR06.35.40G]	05.90- 09.90	CA721	28 60				
		10.90- 12.92	CA898IR	28 60				
	[MIDR06.35.40G]	01.90- 09.90	CA721	28 60				
		01.90- 05.96	CA898IR	28 60				
R 350.18 12.0	(Major)[MIDR06.35.40G]	05.90- 09.90	CA721	28 60				
		10.90- 12.92	CA898IR	28 60				
	[MIDR06.35.40G]	01.90- 09.90	CA721	28 60				
		01.90- 05.96	CA898IR	28 60				
R 350.19 12.0	(Major)[MIDR06.35.40G]	05.90- 09.90	CA721	28 60				
		09.90- 12.92	CA898IR	28 60				
	[MIDR06.35.40G]	01.90- 09.90	CA721	28 60				
		01.90- 05.96	CA898IR	28 60				
R 350.24 12.0	[MIDR06.35.40G]	01.90- 09.90	CA721	28 60				
		01.90- 05.96	CA898IR	28 60				
	[MIDR06.35.40H]	05.91- 10.92	CA721	28 60				
		05.91- 10.92	CA898IR	28 60				
R 350.26 12.0	(Major)[MIDR06.35.40G]	05.90- 09.90	CA721	28 60				
		10.90- 12.92	CA898IR	28 60				
	[MIDR06.35.40G]	01.90- 09.90	CA721	28 60				
		01.90- 05.96	CA898IR	28 60				
R 365.17 12.0	[MIDR06.35.40H]	10.87- 05.90	CA898IR	28 60				
R 365.19 12.0	[MIDR06.35.40H]	10.87- 05.90	CA898IR	28 60				
R 365.24 12.0	[MIDR06.35.40H]	10.87- 05.90	CA898IR	28 60				
R 370.16 14.9	[MIVS08.35.30F]	09.84- 12.85	CA721	28 60		10.84- 12.85	CS688	24 6.6
R 370.22 14.9	[MIVS08.35.30F]	09.84- 12.85	CA721	28 60		10.84- 12.85	CS688	24 6.6
R 380.17 12.0	[MIDR06.35.40H]	01.90- 09.90	CA721	28 60				
		01.90- 10.96	CA898IR	28 60				
R 380.18 12.0	(Major)[MIDR06.35.40L1]	05.91- 10.96	CA898IR	28 60				
	[MIDR06.35.40H]	01.90- 09.90	CA721	28 60				
		01.90- 10.96	CA898IR	28 60				
R 380.19 12.0	[MIDR06.35.40H]	01.90- 09.90	CA721	28 60				
		01.90- 10.96	CA898IR	28 60				
R 380.22 12.0	(Major)[MIDR06.35.40H]	01.90- 09.90	CA721	28 60				
		10.90- 01.92	CA898IR	28 60				
	[MIDR06.35.40H]	01.90- 09.90	CA721	28 60				
		01.90- 10.96	CA898IR	28 60				
R 380.24 12.0	(Major)[MIDR06.35.40L1]	05.91- 10.96	CA898IR	28 60				
	[MIDR06.35.40H]	01.90- 09.90	CA721	28 60				
		01.90- 10.96	CA898IR	28 60				
R 380.25 12.0	(Major)[MIDR06.35.40H]	01.90- 09.90	CA721	28 60				
		10.90- 01.92	CA898IR	28 60				
	[MIDR06.35.40L1]	05.91- 10.96	CA898IR	28 60				
	[MIDR06.35.40H]	01.90- 09.90	CA721	28 60				
		01.90- 10.96	CA898IR	28 60				
R 380.26 12.0	(Major)[MIDR06.35.40L1]	05.91- 10.96	CA721	28 60				
		05.91- 10.96	CA898IR	28 60				
	[MIDR06.35.40H]	01.90- 09.90	CA721	28 60				
		01.90- 10.96	CA898IR	28 60				
R 385TI.17 12.0	(Major)[MIDR06.35.40N/3]	05.91- 10.96	CA898IR	28 60				
R 385TI.18 12.0	(Major)[MIDR06.35.40N/3]	05.91- 10.96	CA898IR	28 60				
R 385TI.19 12.0	(Major)[MIDR06.35.40N/3]	05.91- 10.96	CA898IR	28 60				
R 385TI.22 12.0	(Major)[MIDR06.35.40N/3]	05.91- 10.96	CA898IR	28 60				
R 385TI.24 12.0	(Major)[MIDR06.35.40N/3]	05.91- 10.96	CA898IR	28 60				
R 385TI.25 12.0	(Major)[MIDR06.35.40N/3]	05.91- 10.96	CA898IR	28 60				
R 385TI.26 12.0	(Major)[MIDR06.35.40N/3]	05.91- 10.96	CA898IR	28 60				
R 390.16 14.9	[MIVR08.35.30C]	07.85- 03.89	CA721	28 60		07.85- 03.89	CS688	24 6.6
R 390.17 14.9	[MIVR08.35.30C]	07.85- 03.89	CA721	28 60		07.85- 03.89	CS688	24 6.6
R 390.22 14.9	[MIVR08.35.30C]	07.85- 03.89	CA721	28 60		07.85- 03.89	CS688	24 6.6
R 390.24 14.9	[MIVR08.35.30C]	07.85- 03.89	CA721	28 60		07.85- 03.89	CS688	24 6.6
R 420.17 14.9	[MIVR08.35.30G]	10.88- 10.91	CA721	28 60		10.88- 10.91	CS983	24 8.0
	[MIVR08.35.30H]	10.88- 10.91	CA721	28 60		07.89- 10.91	CS983	24 8.0
R 420.19 14.9	[MIVR08.35.30G]	10.88- 10.91	CA721	28 60		10.88- 10.91	CS983	24 8.0
	[MIVR08.35.30H]	10.88- 10.91	CA721	28 60		07.89- 10.91	CS983	24 8.0
R 420.24 14.9	[MIVR08.35.30G]	10.88- 10.91	CA721	28 60		10.88- 10.91	CS983	24 8.0
	[MIVR08.35.30H]	07.89- 10.91	CA721	28 60		07.89- 10.91	CS983	24 8.0
R 420.35 14.9	[MIVR08.35.30G]	10.88- 10.91	CA721	28 60		10.88- 10.91	CS983	24 8.0
	[MIVR08.35.30H]	10.88- 10.91	CA721	28 60		07.89- 10.91	CS983	24 8.0
R 420TI.18 12.0	(Major)[MIDR06.35.40J/3]	10.92- 10.96	CA898IR	28 60				
R 420TI.19 12.0	(Major)[MIDR06.35.40J/3]	10.92- 10.96	CA898IR	28 60				
R 420TI.22 12.0	(Major)[MIDR06.35.40J/3]	10.92- 10.96	CA898IR	28 60				
R 420TI.24 12.0	(Major)[MIDR06.35.40J/3]	04.92- 10.96	CA898IR	28 60				
R 420TI.26 12.0	(Major)[MIDR06.35.40J/3]	10.92- 10.96	CA898IR	28 60				
R 420TI.35 12.0	(Major)[MIDR06.35.40J/3]	10.92- 10.96	CA898IR	28 60				
RTX 11.1	(Iliade)[MIDR06.23.56A/41]	01.97-	CA1456IR	28 80		01.97-	CS983	24 8.0
		01.97-	CA1667IR	28 140		01.97-	CS1128	24 6.6
						01.97-	CS688	24 6.6
S 100.08 3.9	(Midliner)		CA705IR	28 40				
S 110.06 5.5	(Midliner)[797-21]	06.85- 09.90	CA130IR	28 35		06.85- 09.90	CS1464	24 4.0 SM
		06.85- 09.90	CA705IR	28 40		06.85- 09.90	CS608	24 4.0 LM
		06.85- 09.90	CA721	28 60				
S 110.07 5.5	(Midliner)[797-21]	06.85- 09.90	CA130IR	28 35		06.85- 09.90	CS1464	24 4.0 SM
		06.85- 09.90	CA705IR	28 40		06.85- 09.90	CS608	24 4.0 LM
		06.85- 09.90	CA721	28 60				
S 110.08 5.5	(Midliner)[797-21]	06.85- 09.90	CA130IR	28 35		06.85- 09.90	CS1464	24 4.0 SM
		06.85- 09.90	CA705IR	28 40		06.85- 09.90	CS608	24 4.0 LM
		06.85- 09.90	CA721	28 60				
S 120.06 3.9	(Midliner)[T4.40]	09.90- 11.92	CA705IR	28 40				



S 120.06 4.0	(Midliner)[T4.40 A/3]	09.90- 11.92	CA898IR	28 60			
		11.92- 10.94	CA705IR	28 40			
		11.92- 10.94	CA898IR	28 60			
		11.92- 10.94	CA705IR	28 40			
	[T4.40 CC]	11.92- 10.94	CA898IR	28 60			
S 120.07 3.9	(Midliner)[T4.40]	09.90- 11.92	CA705IR	28 40			
		09.90- 11.92	CA898IR	28 60			
S 120.07 4.0	(Midliner)[T4.40 A/3]	11.92- 10.94	CA705IR	28 40			
		11.92- 10.94	CA898IR	28 60			
	[T4.40 CC]	11.92- 10.94	CA705IR	28 40			
		11.92- 10.94	CA898IR	28 60			
S 120.08 3.9	(Midliner)[T4.40]	09.90- 11.92	CA705IR	28 40			
		09.90- 11.92	CA898IR	28 60			
S 120.08 4.0	(Midliner)[T4.40 A/3]	11.92- 10.94	CA705IR	28 40			
		11.92- 10.94	CA898IR	28 60			
	[T4.40 CC]	11.92- 10.94	CA705IR	28 40			
		11.92- 10.94	CA898IR	28 60			
S 120.09 3.9	(Midliner)[T4.40]	09.90- 11.92	CA705IR	28 40			
		09.90- 11.92	CA898IR	28 60			
S 120.09 4.0	(Midliner)[T4.40 A/3]	11.92- 10.94	CA705IR	28 40			
		11.92- 10.94	CA898IR	28 60			
	[T4.40 CC]	11.92- 10.94	CA705IR	28 40			
		11.92- 10.94	CA898IR	28 60			
S 130.06 5.5	(Midliner)[797]	05.83- 03.90	CA130IR	28 35	09.83- 01.90	CS1464	24 4.0 SM
					09.83- 01.90	CS608	24 4.0 LM
S 130.07 5.5	(Midliner)[797]	05.83- 03.90	CA130IR	28 35	09.83- 01.90	CS608	24 4.0 LM
					09.83- 01.90	CS1464	24 4.0 SM
S 130.08 5.5	(Midliner)[797]	05.83- 03.90	CA130IR	28 35	09.83- 01.90	CS1464	24 4.0 SM
					09.83- 01.90	CS608	24 4.0 LM
S 130.08 5.5	(Midliner)[797]	05.83- 03.90	CA130IR	28 35	09.83- 01.90	CS608	24 4.0 LM
					09.83- 01.90	CS1464	24 4.0 SM
S 130.09 5.5	(Midliner)[797]	05.83- 03.90	CA130IR	28 35	09.83- 01.90	CS1464	24 4.0 SM
					09.83- 01.90	CS608	24 4.0 LM
S 130.11 5.5	(Midliner)[797]	05.83- 03.90	CA130IR	28 35	09.83- 01.90	CS608	24 4.0 LM
					09.83- 01.90	CS1464	24 4.0 SM
S 130.13 5.5	(Midliner)[797]	05.83- 03.90	CA130IR	28 35	09.83- 01.90	CS1464	24 4.0 SM
					09.83- 01.90	CS608	24 4.0 LM
S 135.08 4.0	(Midliner)[T4.40 B/3]	02.94- 05.96	CA705IR	28 40	02.94- 05.96	CS1464	24 4.0 SM
		02.94- 05.96	CA898IR	28 60	02.94- 05.96	CS608	24 4.0 LM
S 135.08 4.1	(Midliner)[MIDR04.02.26A/41]	05.96- 09.98	CA705IR	28 40	05.96- 01.00	CS1464	24 4.0 SM
		05.96- 09.98	CA898IR	28 60	05.96- 01.00	CS608	24 4.0 LM
		10.98- 01.00	CA1852IR	28 60			
S 135.09 4.1	(Midliner)[MIDR04.02.26A/41]	05.96- 09.98	CA705IR	28 40	05.96- 01.00	CS608	24 4.0 LM
		05.96- 09.98	CA898IR	28 60	05.96- 01.00	CS1464	24 4.0 SM
		09.98- 01.00	CA1852IR	28 60			
S 140.07 5.5	(Midliner)[MIDS06.02.12C]	02.90- 09.93	CA705IR	28 40	01.90- 09.93	CS608	24 4.0 LM
		02.90- 01.91	CA721	28 60	01.90- 09.93	CS1464	24 4.0 SM
		02.91- 09.93	CA898IR	28 60			
S 140.08 5.5	(Midliner)[MIDS06.02.12C]	02.90- 09.93	CA705IR	28 40	01.90- 09.93	CS1464	24 4.0 SM
		02.90- 12.90	CA721	28 60	01.90- 09.93	CS608	24 4.0 LM
		02.91- 09.93	CA898IR	28 60			
S 140.09 5.5	(Midliner)[MIDS06.02.12C]	02.90- 09.93	CA705IR	28 40	01.90- 09.93	CS608	24 4.0 LM
		02.90- 12.90	CA721	28 60	01.90- 09.93	CS1464	24 4.0 SM
		02.91- 09.93	CA898IR	28 60			
S 150.08 4.1	(Midliner)[MIDR04.02.26B/41]	05.96- 09.98	CA705IR	28 40	05.96- 01.00	CS1464	24 4.0
		05.96- 09.98	CA898IR	28 60			
		10.98- 01.00	CA1852IR	28 60			
S 150.08 5.5	(Midliner)[798-10]	05.83- 07.86	CA130IR	28 35	05.83- 07.86	CS1464	24 4.0 SM
		05.83- 07.86	CA705IR	28 40	05.83- 07.86	CS608	24 4.0 LM
		05.83- 07.86	CA721	28 60			
	[MIDS06.02.12B]	05.86- 09.90	CA130IR	28 35	05.86- 09.90	CS608	24 4.0 LM
		05.86- 09.90	CA705IR	28 40	05.86- 09.90	CS1464	24 4.0 SM
		05.86- 09.90	CA721	28 60			
	[MIDS06.02.12D/3]	01.94- 05.96	CA705IR	28 40	01.94- 05.96	CS1464	24 4.0
		01.94- 05.96	CA898IR	28 60			
S 150.08 6.2	(Midliner)[MIDR06.02.26U]	11.92- 01.94	CA898IR	28 60	11.92- 01.94	CS608	24 4.0 LM
		11.92- 01.94	CA898IR	28 60	11.92- 01.94	CS1464	24 4.0 SM
	[MIDR06.02.26U/4]	05.96- 09.98	CA898IR	28 60	05.96- 01.00	CS608	24 4.0 LM
		10.98- 01.00	CA1852IR	28 60	05.96- 01.00	CS1464	24 4.0 SM
	[MIDS06.02.12B]	05.86- 09.90	CA130IR	28 35	05.86- 09.90	CS1464	24 4.0 SM
		05.86- 09.90	CA705IR	28 40	05.86- 09.90	CS608	24 4.0 LM
		05.86- 09.90	CA721	28 60			
S 150.09 4.1	(Midliner)[MIDR04.02.26B/41]	05.96- 01.00	CA705IR	28 40	05.96- 01.00	CS1464	24 4.0
		05.96- 09.98	CA898IR	28 60			
		10.98- 01.00	CA1852IR	28 60			
S 150.09 5.5	(Midliner)[798-10]	05.83- 07.86	CA130IR	28 35	05.83- 07.86	CS1464	24 4.0 SM
		05.83- 07.86	CA705IR	28 40	05.83- 07.86	CS608	24 4.0 LM
		05.83- 07.86	CA721	28 60			
	[MIDS06.02.12B]	05.86- 09.90	CA130IR	28 35	05.86- 09.90	CS1464	24 4.0 SM
		05.86- 09.90	CA705IR	28 40	05.86- 09.90	CS608	24 4.0 LM
		05.86- 09.90	CA721	28 60			
	[MIDS06.02.12D/3]	01.94- 05.96	CA705IR	28 40	01.94- 05.96	CS1464	24 4.0
		01.94- 05.96	CA898IR	28 60			
S 150.09 6.2	(Midliner)[MIDR06.02.26U]	11.92- 01.94	CA898IR	28 60	11.92- 01.94	CS1464	24 4.0 SM
		11.92- 01.94	CA898IR	28 60	11.92- 01.94	CS608	24 4.0 LM
	[MIDR06.02.26U/4]	05.96- 09.98	CA898IR	28 60	05.96- 01.00	CS1464	24 4.0 SM
		10.98- 01.00	CA1852IR	28 60	05.96- 01.00	CS608	24 4.0 LM
S 150.11 5.5	(Midliner)[MIDS06.02.12B]	05.86- 09.90	CA130IR	28 35	05.86- 09.90	CS608	24 4.0 LM
		05.86- 09.90	CA705IR	28 40	05.86- 09.90	CS1464	24 4.0 SM
		05.86- 09.90	CA721	28 60			
S 150.13 5.5	(Midliner)[MIDS06.02.12B]	05.86- 09.90	CA130IR	28 35	04.86- 09.90	CS1464	24 4.0 SM
		05.86- 09.90	CA705IR	28 40	04.86- 09.90	CS608	24 4.0 LM
		05.86- 09.90	CA721	28 60			
S 150.14 5.5	(Midliner)[MIDS06.02.12B]	05.86- 09.90	CA130IR	28 35	05.86- 09.90	CS608	24 4.0 LM
		05.86- 09.90	CA705IR	28 40	05.86- 09.90	CS1464	24 4.0 SM
		05.86- 09.90	CA721	28 60			
S 160.08 5.5	(Midliner)[MIDS06.02.12B]	01.90- 04.93	CA705IR	28 40	01.90- 09.93	CS608	24 4.0 LM
		01.90- 12.90	CA721	28 60	01.90- 09.93	CS1464	24 4.0 SM
		02.91- 04.93	CA898IR	28 60			



RENAULT V.I. Continued

S 160.09 5.5	(Midliner)[MIDS06.02.12B]	01.90- 04.93	CA705IR	28 40	01.90- 09.93	CS1464	24 4.0	SM	
		01.90- 02.90- 04.93	CA721 CA898IR	28 60 28 60	01.90- 09.93	CS608	24 4.0	LM	
S 170.11 5.5	(Midliner)[MIDR06.02.12D]	10.82- 03.93	CA130IR	28 35	10.87- 05.89	CS1464	24 4.0	SM	
		10.82- 03.93	CA705IR CA721	28 40 28 60	10.87- 05.89	CS608	24 4.0	LM	
S 170.13 5.5	(Midliner)[MIDR06.02.12D]	10.82- 03.93	CA130IR	28 35	BO	10.83- 03.93	CS608	24 4.0	LM
		10.82- 03.93	CA705IR CA721	28 40 28 60	10.83- 03.93	CS1464	24 4.0	SM	
S 170.14 5.5	(Midliner)[MIDR06.02.12D]	10.82- 03.93	CA130IR	28 35	BO	10.83- 05.89	CS608	24 4.0	LM
		10.82- 03.93	CA705IR CA721	28 40 28 60	10.83- 05.89	CS1464	24 4.0	SM	
S 170.15 5.5	(Midliner)[MIDR06.02.12D]	10.82- 03.93	CA130IR	28 35		10.82- 09.93	CS608	24 4.0	LM
		10.82- 03.93	CA705IR CA898IR	28 40 28 60	11.92- 10.96	CS1464	24 4.0	SM	
S 180.08 6.2	(Midliner)[MIDR06.02.26V]	11.92- 10.96	CA898IR	28 60		11.92- 10.96	CS608	24 4.0	LM
					05.96- 09.98	CA898IR	28 60	05.96- 01.00	CS1464
S 180.09 6.2	(Messenger)[MIDR06.02.26V]	10.98- 01.00	CA1852IR	28 60		05.96- 01.00	CS608	24 4.0	LM
		11.92- 10.96	CA898IR	28 60		11.92- 10.96	CS608	24 4.0	LM
	(Midliner)[MIDR06.02.26V]	11.92- 10.96	CA898IR	28 60		11.92- 10.96	CS1464	24 4.0	SM
					11.92- 10.96	CS608	24 4.0	LM	
	[MIDR06.02.26V/41]	05.96- 09.98	CA898IR	28 60		05.96- 01.00	CS1464	24 4.0	SM
		10.98- 01.00	CA1852IR	28 60		05.96- 01.00	CS608	24 4.0	LM
S 210.08 6.2	(Midliner)[MIDR06.02.26W]	04.95- 01.00	CA1852IR	28 60		04.95- 01.00	CS608	24 4.0	LM
		04.95- 01.00	CA705IR CA898IR	28 40 28 60		04.95- 01.00	CS1464	24 4.0	SM
	[MIDR06.02.26W/41]	05.96- 09.98	CA898IR	28 60		04.95- 01.00	CS1464	24 4.0	SM
		10.98- 01.00	CA1852IR	28 60		04.95- 01.00	CS608	24 4.0	LM
S 210.09 6.2	(Midliner)[MIDR06.02.26W]	04.95- 01.00	CA1852IR	28 60		04.95- 01.00	CS608	24 4.0	LM
		04.95- 01.00	CA705IR CA898IR	28 40 28 60		04.95- 01.00	CS1464	24 4.0	SM
	[MIDR06.02.26W/41]	05.96- 09.98	CA898IR	28 60		04.95- 01.00	CS608	24 4.0	LM
		10.98- 01.00	CA1852IR	28 60		04.95- 01.00	CS1464	24 4.0	SM
S 220.11 6.2	(Midliner)[MIDR06.02.26]	09.87- 09.90	CA705IR	28 40		09.87- 09.90	CS1464	24 4.0	
		09.87- 09.90	CA721	28 60		09.87- 09.90	CS1464	24 4.0	SM
	[MIDR06.02.26D]	09.87- 09.90	CA705IR CA721	28 40 28 60		09.87- 09.90	CS608	24 4.0	LM
		09.87- 09.90	CA705IR	28 40		09.87- 09.90	CS1464	24 4.0	
S 220.13 6.2	(Midliner)[MIDR06.02.26]	09.87- 09.90	CA705IR	28 40		09.87- 09.90	CS1464	24 4.0	
		09.87- 09.90	CA721	28 60		09.87- 09.90	CS1464	24 4.0	SM
	[MIDR06.02.26D]	09.87- 09.90	CA705IR CA721	28 40 28 60		09.87- 09.90	CS608	24 4.0	LM
		09.87- 09.90	CA705IR	28 40		09.87- 09.90	CS608	24 4.0	
S 220.14 6.2	(Midliner)[MIDR06.02.26]	09.87- 09.90	CA705IR	28 40		09.87- 09.90	CS608	24 4.0	
		09.87- 09.90	CA721	28 60		09.87- 09.90	CS1464	24 4.0	
	[MIDR06.02.26D]	09.87- 09.90	CA705IR CA721	28 40 28 60		09.87- 09.90	CS608	24 4.0	LM
		09.87- 09.90	CA721	28 60		09.87- 09.90	CS1464	24 4.0	SM
Tracer 9.8	(Tracer)[MIHR 06.20.45 A41]	07.96-	CA1667IR	28 140					
		01.91-	CA1667IR	28 140					
TX 11.1	(Iliade)[MIDR06.23.56A/41]	01.97-	CA1456IR	28 80		01.97-	CS688	24 6.6	
		01.97-	CA1667IR	28 140		01.97-	CS983	24 8.0	
					01.97-	CS1128	24 6.6		
<b>Rover</b>									
<b>PASSENGER CARS EU</b>									
25 1.1		09.99- 05.04	CA1576IR	14 85		09.99- 05.04	CS610	12 0.8	
		09.99- 05.04	CA1575IR	14 75					
		09.99- 05.04	CA1318IR	14 65					
25 1.1 16V	[11K4F]	Chas. YD471565- 02.03- 05.05	CA1576IR	14 85		02.03- 05.05	CS610	12 0.8	
		Chas. -YD471564 02.03- 05.05	CA1318IR	14 65					
		Chas. TD471565-, YD524392 02.03- 05.05	CA1575IR	14 75					
25 1.4 16V	[14K4F]	10.99- 05.05	CA1575IR	14 75		10.99- 05.05	CS610	12 0.8	
		AC 10.99- 05.05	CA1576IR	14 85					
		10.99- 05.05	CA1575IR	14 75		10.99- 05.05	CS610	12 0.8	
	[14K4M]	AC 10.99- 05.05	CA1576IR	14 85					
		10.99- 05.05	CA1575IR	14 75		10.99- 05.05	CS610	12 0.8	
25 1.6 16V	[16K4F]	10.99- 05.05	CA1575IR	14 75		10.99- 05.05	CS610	12 0.8	
		AC 10.99- 05.05	CA1576IR	14 85					
25 1.8 16V	[18K4F]	10.99- 10.04	CA1575IR	14 75		10.99- 10.04	CS1253	12 1.1	
					AT 10.99- 10.04	CS1503*	12 1.2		
					02.00- 10.04	CS1270	12 1.4		
	[18K4K (VVC)]	02.00- 10.04	CA1575IR	14 75		AT 02.00-	CS1503*	12 1.2	
					02.00- 10.04	CS1253	12 1.1		
25 2.0 iDT	[20T2N]	01.02- 06.04	JA1424IR	14 90		02.00- 05.05	JS1314	12 1.7	
		01.02- 06.04	JA1425IR	14 80		01.02- 06.04	JS1149	12 1.8	
		Chas. -YD 471565 02.00- 05.05	JA1425IR	14 80					
		Chas. YD 471565- 02.00- 05.05	JA1424IR	14 90					
45 1.4	[14K4F]	02.00- 05.05	CA1575IR	14 75		02.00- 05.05	CS610	12 0.8	
		AC 02.00- 05.05	CA1576IR	14 85					
45 1.6	[16K4F]	02.00- 05.05	CA1575IR	14 75		02.00- 05.05	CS610	12 0.8	
		AC 02.00- 05.05	CA1576IR	14 85					
45 1.8	[18K4F]	02.00- 05.05	CA1575IR	14 75		02.00- 05.05	CS1253	12 1.1	
					AT 02.00-	CS1503*	12 1.2		
		AC 02.00- 05.05	CA1576IR	14 85		02.00- 05.05	CS1270	12 1.4	
45 2.0 V6	[20K4F]	02.00- 05.05	JA1596IR	14 90					
		02.00- 05.05	JA1596IR	14 90					
45 2.0 iDT	[20T2N]	02.00- 05.05	JA1424IR	14 90		01.04-	JS1149	12 1.8	
		01.04-	JA1425IR	14 80		02.00- 05.05	JS1314	12 1.7	
		Chas. YD 471064- 02.00- 05.05	JA1424IR	14 90					
		Chas. -YD 471063 02.00- 05.05	JA1425IR	14 80					
75 1.8	[K1.8]	02.99- 05.05	JA1608IR	14 90		02.99- 05.05	JS1229	12 1.2	
		AC 02.99- 05.05	JA1723IR	14 90					
75 1.8 Turbo		AC 05.03- 05.05	JA1723IR	14 90		05.03- 05.05	JS1229	12 1.2	
75 2.0 V6	[20K4F]	02.99- 05.05	JA1596IR	14 90		AT 02.99- 05.05	JS1320	12 2.0	
75 2.0 CDT	[M47R]	02.99- 12.02	CA1631IR	14 110		02.99- 12.02	JS1321	12 2.0	
75 2.0 CDTi	[204D2]	02.03- 05.05	CA1631IR	14 110		02.03- 05.05	JS1321	12 2.0	



75 2.5 V6	[25K4F]	10.99- 05.05	JA1596IR	14 90		01.99- 05.05	JS1320	12 2.0
	[KV6]	02.99- 05.05	JA1596IR	14 90		AT 02.99- 05.05	JS1320	12 2.0
111 1.1 Metro	[11K2A]	03.90- 03.98	CA293IR	14 55		03.90- 03.98	CS610	12 0.8
		03.90- 03.98	CA306IR	14 55				
	[11K2D]	03.90- 03.98	CA293IR	14 55	A34	03.90- 03.98	CS610	12 0.8
		03.90- 03.98	CA306IR	14 55				
114 1.4	[14K2D]	03.90- 03.98	CA306IR	14 55		03.90- 03.98	CS610	12 0.8
		03.90- 03.98	CA627IR	14 65				
	[14K4F]	03.97- 10.98	CA306IR	14 55		03.97- 10.98	CS610	12 0.8
		03.90- 03.98	CA306IR	14 55	A34	03.90- 03.98	CS610	12 0.8
114 1.4 Metro	[14K2A]	03.90- 03.98	CA306IR	14 55				
		03.90- 03.98	CA627IR	14 65				
	[14K2D]	09.90- 03.98	CA1318IR	14 65				
		04.94-	CA306IR	14 55	A34	09.90- 03.98	CS610	12 0.8
114 1.4 16V Metro	[14K4C]	03.90- 12.92	CA306IR	14 55		03.90- 12.92	CS610	12 0.8
		03.90- 12.92	CA627IR	14 65				
	[14K4D]	03.90- 12.92	CA306IR	14 55		03.90- 12.92	CS610	12 0.8
		03.90- 12.92	CA627IR	14 65				
114 1.4 GSi	[14K4F]	10.94- 10.95	CA306IR	14 55		10.94- 10.95	CS610	12 0.8
		10.94- 10.95	CA627IR	14 65				
114 1.4 GTi 16V	[14K4F]	08.91- 12.98	CA627IR	14 65		08.91- 12.98	CS610	12 0.8
114 1.4 GTi 16V Metro	[14K4C]	03.90- 08.91	CA627IR	14 65		03.90- 08.91	CS610	12 0.8
		03.90- 08.91	CA627IR	14 65		03.90- 08.91	CS610	12 0.8
115 1.5 Diesel Metro	[TUD5]	12.94- 12.98	CA1038IR	14 70		12.94- 12.98	CS542	12 1.4
200 2.0 Diesel SD	[20T2R]	Chas. -YD471564 11.95- 03.00	JA1424IR	14 90		11.95- 03.00	JS1149	12 1.8
211 1.1	[11K2D]	01.98- 03.00	CA1318IR	14 65		01.98- 03.00	CS610	12 0.8
213 1.3	[EV2]					09.85- 09.89	JS311#	12 0.8
214 1.4	[14K2A]	01.93- 02.96	CA1346IR	14 65		01.93- 02.96	CS610	12 0.8
		01.93- 02.96	CA305IR	14 55				
	[14K2D]	01.93- 02.96	CA305IR	14 55		01.93- 02.96	CS610	12 0.8
		AC 01.93- 02.96	CA1346IR	14 65				
	[14K4C]	10.89- 09.93	CA306IR	14 55	▲	Chas. 605482- 10.89- 02.96	CS610	12 0.8
		10.89- 09.93	CA627IR	14 65				
		Chas. A679673- 10.92- 02.96	CA627IR	14 65				
		AC 10.89- 09.93	CA1346IR	14 65				
	[14K4D]	10.89- 09.93	CA306IR	14 55	▲	10.89- 09.93	CS610	12 0.8
		10.89- 09.93	CA627IR	14 65				
		AC 10.89- 09.93	CA1346IR	14 65				
	[14K4F]	12.92- 02.96	CA306IR	14 55	▲	12.92- 02.96	CS610	12 0.8
		12.92- 02.96	CA627IR	14 65				
		AC 12.92- 02.96	CA1346IR	14 65				
214 1.4 i	[14K2F]	11.95- 03.00	CA1318IR	14 65		11.95- 03.00	CS610	12 0.8
	[14K4C]	01.92- 02.96	CA305IR	14 55		01.92- 02.96	CS610	12 0.8
		AC 01.92- 02.96	CA1346IR	14 65				
	[14K4D]	01.92- 02.96	CA305IR	14 55		01.92- 02.96	CS610	12 0.8
		AC 01.92- 02.96	CA1346IR	14 65				
	[14K4F]	01.93- 03.96	CA627IR	14 65		01.93- 03.96	CS610	12 0.8
214 1.4 Si	[14K4F]	11.95- 03.00	CA1318IR	14 65		11.95- 03.00	CS610	12 0.8
216 1.6	[16H]	03.85- 09.89	CA1318IR	14 65		05.86- 09.89	CS579	12 0.9
216 1.6 Vitesse	[16H]	03.85- 09.89	CA293IR	14 55		05.86- 09.89	CS579	12 0.9
216 1.6 GSi	[D16 Z2]	10.89- 02.96	JA753IR	14 60		10.89- 02.96	JS319	12 1.0
216 1.6 GTi	[D16 A8]	09.90- 02.96	JA753IR	14 60		09.90- 02.96	JS319	12 1.0
	[D16A9]	09.90- 10.95	JA753IR	14 60		09.90- 10.95	CS306	12 1.05
216 1.6 i	[16K4F]	01.96- 03.00	CA1318IR	14 65		01.96- 03.00	CS610	12 0.8
	[D16 A8]	01.92- 02.96	JA753IR	14 60		01.92- 11.99	CS306	12 1.05
216 1.6 Si	[16K4F]	11.95- 03.00	CA1318IR	14 65		11.95- 03.00	CS610	12 0.8
216 1.6 Turbo	[D16 A8]	10.89- 02.96	JA753IR	14 60		10.89- 02.96	JS319	12 1.0
218 1.8 i	[18K4K]	11.95- 03.00	CA1318IR	14 65		Chas. -YD471564 11.95- 03.00	CS1253	12 1.1
		11.95- 03.00	CA1487IR	14 85		AT 11.95- 03.00	CS1503*	12 1.2
						Chas. YD471565- 11.95- 03.00	CS1270	12 1.4
218 1.8 Diesel	[XUD7TE]	09.91- 10.95	CA1101IR	14 70		09.91- 10.95	JS664	12 2.0
						09.91- 10.95	JS1314	12 1.7
220 2.0 GSi	[20T4H]	05.94- 06.96	CA1191IR	14 100		05.94- 06.96	CS579	12 0.9
220 2.0 GTi	[20M4F]	09.91- 06.96	CA1100IR	14 85		09.91- 06.96	CS579	12 0.9
		09.91- 06.96	CA564IR	14 65				
		AC 09.91- 06.96	CA1651IR	14 85				
	[20T4H]	01.93- 06.96	CA1100IR	14 85		01.93- 06.96	CS579	12 0.9
		AC 01.93- 06.96	CA1651IR	14 85				
220 2.0 Turbo	[20T4G]	10.92- 06.96	CA1100IR	14 85		10.92- 06.96	CS579	12 0.9
		10.92- 06.96	CA564IR	14 65	▲			
		AC 10.92- 06.96	CA1651IR	14 85				
220 2.0 SDi	[20T2N]	Chas. -YD471564 11.95- 03.00	JA1424IR	14 90		11.95- 03.00	JS1149	12 1.8
400 1.4		03.96- 12.97	CA1318IR	14 65		03.96- 12.97	CS610	12 0.8
400 1.8 i	[18K4K]	06.96- 11.98	CA1318IR	14 65		06.96- 11.98	CS1270	12 1.4
						06.96- 11.98	CS1253	12 1.1
414 1.4	[14K4C]	04.90- 02.96	CA306IR	14 55	▲	04.90- 02.96	CS610	12 0.8
		AC 04.90- 02.96	CA1346IR	14 65				
	[14K4D]	04.90- 02.96	CA306IR	14 55	▲	04.90- 02.96	CS610	12 0.8
		AC 04.90- 02.96	CA1346IR	14 65				
	[14K4F]	01.93- 02.96	CA627IR	14 65		01.93- 02.96	CS610	12 0.8
414 1.4 Si	[14K4F]	01.93- 02.96	CA1318IR	14 65		01.93- 02.96	CS610	12 0.8
416 1.6	[D16 Z2]	04.90- 02.96	JA753IR	14 60		04.90- 02.96	JS319	12 1.0
416 1.6 16V	[16K4F]	03.96- 11.99	CA1318IR	14 65		03.96- 11.99	CS610	12 0.8
416 1.6 GTi	[D16 A8]	04.90- 02.96	JA753IR	14 60		04.90- 02.96	JS319	12 1.0
416 1.6 i	[D16A8]	05.94- 11.98	JA1405IR	14 75		05.94- 11.98	CS306	12 1.05
		05.94- 11.98	JA753IR	14 60				
	[D16Z2]	05.94- 11.98	JA1405IR	14 75		05.94- 11.98	CS306	12 1.05
		05.94- 11.98	JA753IR	14 60				
416 1.6 Si	[16K4F]	05.95- 03.00	CA1318IR	14 65		05.95- 03.00	CS610	12 0.8
		05.95- 03.00	CA1487IR	14 85		AT, Chas. AD250029- 05.95- 03.00	JS1147	12 1.0
						AT, Chas. -AD250028 05.95- 03.00	JS1152	12 1.0
	[D16Y2]	05.95- 03.00	CA1318IR	14 65		05.95- 03.00	CS610	12 0.8
		05.95- 03.00	CA1487IR	14 85		AT, Chas. -AD250028 05.95- 03.00	JS1152	12 1.0
						AT, Chas. AD250029- 05.95- 03.00	JS1147	12 1.0
418 1.8 16V	[18 K4K(VVC)]	01.97- 12.98	CA1318IR	14 65		01.97- 12.98	CS1270	12 1.4
418 1.8 Diesel	[XUD7TE]	09.91- 02.96	CA1101IR	14 70		09.91- 02.96	JS664	12 2.0
420 2.0	[20M4F]	02.92- 02.96	CA1100IR	14 85		02.92- 02.96	CS579	12 0.9
		AC 02.92- 02.96	CA1651IR	14 85				
	[20T4H]	01.93- 02.96	CA1100IR	14 85		01.93- 02.96	CS579	12 0.9
		AC 01.93- 02.96	CA1651IR	14 85				
420 2.0 GSi	[20T4H]	12.95- 03.00	CA1100IR	14 85		12.95- 03.00	CS1270	12 1.4
		AC 12.95- 03.00	CA1651IR	14 85				
420 2.0 Si	[20T4H]	12.95- 03.00	CA1100IR	14 85		12.95- 03.00	CS1270	12 1.4
		AC 12.95- 03.00	CA1651IR	14 85		12.95- 03.00	CS579	12 0.9



**ROVER Continued**

420 2.0 Turbo	[20T4G]	01.93- 02.96 CA1100IR 14 85	01.93- 02.96 CS579 12 0.9
		AC 01.93- 02.96 CA1651IR 14 85	
420 2.0 Diesel Di	[20T2N]	05.95- 03.00 JA1424IR 14 90	05.95- 03.00 JS1149 12 1.8
420 2.0 Diesel	[20T2N]	05.95- 03.00 JA1424IR 14 90	05.95- 03.00 JS1149 12 1.8
	[20T2R]	11.95- 03.00 JA1424IR 14 90	11.95- 03.00 JS1149 12 1.8
618 1.9 i Si	[F18A3]		AT 03.96- 02.99 JS645 12 1.4
			03.96- 02.99 JS1150 12 1.6 ND
			03.96- 02.99 JS648 12 1.0 MS
620 2.0 i	[F20Z2]	08.93- 06.96 JA1129IR 14 70	08.93- 06.96 JS1150 12 1.6
		05.95- 06.96 JA1426IR 14 70	
620 2.0 Si	[F20Z1]	08.93- 02.99 JA1129IR 14 70	08.93- 02.99 JS648 12 1.0 MS
		05.95- 02.99 JA1426IR 14 70	08.93- 02.99 JS1150 12 1.6 ND
			AT 08.93- 02.99 JS645 12 1.4
620 2.0 Ti Vitesse	[20T4G]	04.93- 02.99 CA1100IR 14 85	04.93- 02.99 CS579 12 0.9
		AC 04.93- 02.99 CA1651IR 14 85	04.93- 02.99 CS1129 12 1.4
620 2.0 SDi	[20T2N]	12.94- 12.98 JA1424IR 14 90	Chas. BM 246797- 12.94- 12.98 JS1149 12 1.8
		12.94- 12.98 JA1425IR 14 80	
623 2.3 Si	[H23A3]	08.93- 02.99 JA1129IR 14 70	08.93- 02.99 JS1150 12 1.6
		08.93- 02.99 JA1426IR 14 70	AT 08.93- 02.99 JS645 12 1.4
800 2.5	[25K4F]	02.96- 10.98 JA1426IR 14 70	02.96- 10.98 CS1270 12 1.4
800 2.5 Si	[25K4F]	02.96- 10.98 JA1426IR 14 70	02.96- 10.98 CS1270 12 1.4
820 2.0			10.88- 10.91 CS579 12 0.9
820 2.0 i 16V	[20HD]	10.86- 10.88 CA582IR 14 65	10.86- 10.88 CS579 12 0.9
		10.88- 01.91 CA564IR 14 65	
820 2.0 i	[20HD]	10.88- 12.91 CA1100IR 14 85	10.88- 12.91 CS579 12 0.9
	[20T4H]	01.92- 01.96 CA1100IR 14 85	01.92- 01.96 CS579 12 0.9
820 2.0 Si	[20HDM16]	10.88- 12.91 CA1100IR 14 85	10.88- 12.91 CS579 12 0.9
		10.88- 12.91 CA564IR 14 65	
820 2.0 Turbo 16V	[T16]	01.92- 02.99 CA1100IR 14 85	
825 2.5 Si	[25K4F]	04.96- 02.99 JA1426IR 14 70	04.96- 02.99 CS1270 12 1.4
	[C25A1]	10.86- 12.91 JA555IR# 14 70	
	[C25A2]	10.86- 12.91 JA555IR# 14 70	
825 2.5 Diesel	[425SL1RR]		01.92- 12.98 CS611 12 2.2
	[4924SHIRG]		01.92- 02.99 CS611 12 2.2
825 2.5 TD	[425SL1RR]		10.91- 02.99 CS611 12 2.2
	[4924SHIRG]		10.91- 02.99 CS611 12 2.2
825 2.7 SLi Vitesse	[C27A2]	10.88- 12.91 CA564IR 14 65	
		AT 10.88- 12.91 JA555IR# 14 70	
827 2.7	[C27A1]	10.88- 12.91 CA564IR 14 65	
		AT 10.88- 12.91 JA555IR# 14 70	
827 2.7 24V	[C27A1]	08.92- 01.96 CA564IR 14 65	
		AT 08.92- 01.96 JA555IR# 14 70	
827 2.7 Si	[C27A1]	01.92- 01.96 CA564IR 14 65	
		AT 01.92- 01.96 JA555IR# 14 70	
	[C27A2]	02.88- 12.91 CA564IR 14 65	
		AT 02.88- 12.91 JA555IR# 14 70	
827 2.7 Si Sterling	[C27A1]	02.88- 01.96 CA564IR 14 65	
		AT 02.88- 01.96 JA555IR# 14 70	
1300 1.3		06.91- 05.01 CA1488IR 14 65	06.91- 05.01 CS691 12 0.8
2200 2.2		01.72- 05.76 CA18h 14 43	
3500 3.5		04.68- 05.76 CA18v 14 43	
820 E 2.0	[20HS]	10.86- 10.88 CA582IR 14 65	10.86- 10.91 CS579 12 0.9
		10.88- 10.91 CA564IR 14 65	
Maestro 1.3		09.90- 01.95 CA600IR 14 55	09.90- 01.95 CS116 12 0.8
Maestro 1.6		09.90- 01.95 CA293IR 14 55	09.90- 01.95 CS116 12 0.8
Maestro 2.0 Diesel		09.90- 10.92 CA600IR 14 55	09.90- 10.92 JS664 12 2.0
Maestro 2.0 TD		09.90- 01.95 CA600IR 14 55	09.90- 01.95 JS664 12 2.0
Mini 1.3	[12 A2B]	10.92- 07.96 CA126IR 14 45	10.92- 07.96 CS691 12 0.8
	[12A2E]	02.91- 01.96 CA126IR 14 45	02.91- 09.00 CS691 12 0.8
		01.96- 09.00 CA1488IR 14 65	
Montego 1.3	[12HL]	10.84- 10.88 CA305IR 14 55	10.84- 10.88 CS116 12 0.8
Montego 1.6		AC 10.90- 09.92 CA627IR 14 65	10.90- 09.92 CS579 12 0.9
		10.90- 09.92 CA293IR 14 55	10.90- 09.92 CS116 12 0.8
Montego 2.0 GTi		10.88- 10.91 CA305IR 14 55	10.88- 10.91 CS579 12 0.9
		AC 10.88- 10.91 CA564IR 14 65	
Montego 2.0 TD	[BB]	09.88- 10.95 CA600IR 14 55	09.88- 10.95 JS664 12 2.0
Streetwise 1.4	[14K4F]		08.03- 05.05 CS610 12 0.8
Streetwise 2.0 TD	[20T2N]	08.03- 05.05 JA1424IR 14 90	08.03- 05.05 JS1149 12 1.8
		08.03- 05.05 JA1425IR 14 80	
<b>PASSENGER CARS AO</b>			
Mini MK I 1.3 S			02.98- 05.01 CS691 12 0.8
<b>Sabb</b>			
<b>MARINE</b>			
9 1.6	[2G]		01.59- 06.83 CS995# 12 1.9
16 1.9	[2J]		01.72- CS995# 12 1.9
<b>Same</b>			
<b>AGRICULTURE</b>			
Centauro 70 Diesel		12.81- 10.87 CA77IR 14 33	12.81- 10.87 CS335 12 3.0
		06.85- 10.87 CA316IR 14 55	
		12.81- 10.87 CA255IR 14 45	
Centurion 75 Diesel		11.78- 05.88 CA77IR 14 33	11.78- 05.88 CS335 12 3.0
		11.78- 05.88 CA255IR 14 45	
		11.78- 05.88 CA316IR 14 55	
Explorer 60 3.0 Diesel	[100.3A]	06.86- CA255IR 14 45	
		06.86- CA316IR 14 55	
Explorer 70 4.0 Diesel		07.86- CA255IR 14 45	07.86- CS718 12 3.0
		07.86- CA316IR 14 55	
Explorer 80 4.0 Diesel		07.86- CA316IR 14 55	07.86- CS718 12 3.0
Explorer 90 4.0 Diesel		06.86- CA255IR 14 45	06.86- CS718 12 3.0
		06.86- CA316IR 14 55	
Frutteto 75 3.0 Diesel		05.91- CA316IR 14 55	05.91- CS718 12 3.0
			05.91- CS335 12 3.0
Galaxy 170 6.2 Diesel		06.83- CA316IR 14 55	06.83- CS335 12 3.0
Laser 100 5.2 Diesel		03.84- 05.85 CA255IR 14 45	03.84- CS335 12 3.0
		05.85- CA316IR 14 55	
Laser 110 5.7 Diesel		03.83- CA316IR 14 55	03.83- 12.87 CS335 12 3.0
			01.88- CS718 12 3.0
Laser 130 6.2 Diesel		04.83- CA316IR 14 55	01.88- CS718 12 3.0
		04.83- CA355IR 14 65	04.83- 12.87 CS335 12 3.0
Laser 150 6.2 Diesel		03.83- CA255IR 14 45	03.83- 12.87 CS335 12 3.0
		03.83- CA316IR 14 55	01.88- CS718 12 3.0
Ranger 45 2.7 Diesel		02.82- 08.85 CA77IR 14 33	02.82- CS335 12 3.0
		09.85- 04.88 CA255IR 14 45	
		05.88- CA316IR 14 55	





Solar 50 2.7 Diesel		06.86-	CA2551R	14	45				
		06.86-	CA3161R	14	55				
Solar 55 2.8 Diesel		06.87-	CA2551R	14	45				
		06.87-	CA3161R	14	55				
Solar 60 3.1 Diesel		06.86-	CA3161R	14	55			06.86-	CS718 12 3.0
								06.86-	CS335 12 3.0
Titan 160 6.0 Diesel		05.91-	CA16291R	14	90			05.91-	CS335 12 3.0
Titan 190 6.0 Diesel		01.92-	CA16291R	14	90			01.92-	CS335 12 3.0
Transporter								01.91-	CS335 12 3.0
<b>Scania</b>									
<b>TRUCKS EU</b>									
230 11.7	(P/G/R/T Series)[DC12.13]	09.05-	CA18511R	28	80			09.05-	CS1399 24 5.5
		09.05-	CA18801R	28	100				
230 8.9	(P/G/R/T Series)[DC9.13]	09.04- 09.06	CA18511R	28	80			09.04- 09.06	CS1399 24 5.5
	[DC9.16]	09.04- 09.06	CA18801R	28	100				
		09.04-	CA18511R	28	80			09.04-	CS1399 24 5.5
	[DC9.18]	09.04-	CA18801R	28	100				
		09.04-	CA18511R	28	80			09.04-	CS1399 24 5.5
230 9.0	(P/G/R/T Series)[DC9.01]	09.04-	CA11481R	28	65			09.04-	CS1169 24 6.7
		09.04-	CA18421R	28	100			09.04-	CS121 24 6.0
								09.04-	CS97 24 4.0
230 9.3	(P/G/R/T Series)[DC9.30]	09.07-	CA18511R	28	80			09.07-	CS1399 24 5.5
		09.07-	CA18801R	28	100				
	[DC9.35]	09.07-	CA18511R	28	80			09.07-	CS1399 24 5.5
		09.07-	CA18801R	28	100				
260 11.0	(P/G/R/T Series)[OSC11.03]	09.04-	CA11481R	28	65			09.04-	CS1199 24 6.7
		09.04-	CA17441R	28	65			09.04-	CS97 24 4.0
260 9.0	(P/G/R/T Series)[DC9.02]	09.04-	CA11481R	28	65			09.04-	CS97 24 4.0
		09.04-	CA18421R	28	100			09.04-	CS121 24 6.0
								09.04-	CS1169 24 6.7
270 11.7	(P/G/R/T Series)[DC12.17]	09.05-	CA18511R	28	80			09.05-	CS1399 24 5.5
		09.05-	CA18801R	28	100				
270 8.9	(P/G/R/T Series)[DC9.12]	09.04-	CA18511R	28	80			09.04-	CS1399 24 5.5
		09.04-	CA18801R	28	100				
	[DC9.17]	09.04-	CA18511R	28	80			09.04-	CS1399 24 5.5
		09.04-	CA18801R	28	100				
270 9.0	(P/G/R/T Series)[DC9.12]	09.04- 09.06	CA18511R	28	80			09.04- 09.06	CS1399 24 5.5
		09.04- 09.06	CA18801R	28	100				
280 9.3	(P/G/R/T Series)[DC9.29]	09.07-	CA18511R	28	80			09.07-	CS1399 24 5.5
		09.07-	CA18801R	28	100				
300 9.0	(P/G/R/T Series)[DC9.03]	09.04-	CA11481R	28	65			09.04-	CS97 24 4.0
		09.04-	CA18421R	28	100			09.04-	CS121 24 6.0
								09.04-	CS1169 24 6.7
310 8.9	(P/G/R/T Series)[DC9.11]	09.04- 09.06	CA18511R	28	80			09.04- 09.06	CS1399 24 5.5
		09.04- 09.06	CA18801R	28	100				
	[DC9.17]	09.05-	CA18511R	28	80			09.05-	CS1399 24 5.5
		09.05-	CA18801R	28	100				
	[DC9.18]	09.04-	CA18511R	28	80			09.04-	CS1399 24 5.5
		09.04-	CA18801R	28	100				
340 10.6	(P/G/R/T Series)[DC11.08]	03.04- 09.06	CA18511R	28	80			03.04- 09.06	CS1399 24 5.5
		03.04- 09.06	CA18801R	28	100				
340 11.7	(P/G/R/T Series)[DC12.10]		CA18511R	28	80			08.04-	CS1399 24 5.5
			CA18801R	28	100				
	[DC12.13]	09.05-	CA18511R	28	80			09.05-	CS1399 24 5.5
		09.05-	CA18801R	28	100				
380 10.6	(P/G/R/T Series)[DC11.09]	03.04- 09.06	CA18511R	28	80			03.04- 09.06	CS1399 24 5.5
		03.04- 09.06	CA18801R	28	100				
380 11.7	(P/G/R/T Series)[DC12.13]	08.04-	CA18511R	28	80			08.04-	CS1399 24 5.5
		08.04-	CA18801R	28	100				
	[DC12.17]	09.04-	CA18511R	28	80			09.04-	CS1399 24 5.5
		09.04-	CA18801R	28	100				
	[DC12.18]	09.04-	CA18511R	28	80			09.04-	CS1399 24 5.5
		09.04-	CA18801R	28	100				
420 11.7	(P/G/R/T Series)[DC12.06]	09.07-	CA18511R	28	80			09.07-	CS1399 24 5.5
		09.07-	CA18801R	28	100				
	[DC12.14]	03.04- 09.06	CA18511R	28	80			03.04- 09.06	CS1399 24 5.5
		03.04- 09.06	CA18801R	28	100				
	[DC12.15]	04.04-	CA18511R	28	80			04.04-	CS1399 24 5.5
		04.04-	CA18801R	28	100				
	[DT12.11]	03.04-	CA18511R	28	80			03.04-	CS1399 24 5.5
		03.04-	CA18801R	28	100				
	[DT12.12]	02.04-	CA18511R	28	80			02.04-	CS1399 24 5.5
		02.04-	CA18801R	28	100				
440 12.7	(P/G/R/T Series)[DC13.10]	03.08-	CA18511R	28	80			03.08-	CS1399 24 5.5
		03.08-	CA18801R	28	100				
470 11.7	(P/G/R/T Series)[DT12.03]	04.04-	CA18511R	28	80			04.04-	CS1399 24 5.5
		04.04-	CA18801R	28	100				
	[DT12.06]	03.04- 10.05	CA18511R	28	80			03.04- 10.05	CS1399 24 5.5
		03.04- 10.05	CA18801R	28	100			09.05-	CS1399 24 5.5
		09.05-	CA18801R	28	100				
		09.05-	CA18511R	28	80				
480 11.7	(P/G/R/T Series)[DT12.06]	04.04-	CA18511R	28	80			04.04-	CS1399 24 5.5
		04.04-	CA18801R	28	100				
	[DT12.17]	09.04-	CA18511R	28	80			09.04-	CS1399 24 5.5
		09.04-	CA18801R	28	100				
480 12.7	(P/G/R/T Series)[DC13.07]	03.08-	CA18511R	28	80			03.08-	CS1399 24 5.5
		03.08-	CA18801R	28	100				
500 15.6	(P/G/R/T Series)[DC16.04]	03.04- 09.06	CA18511R	28	80			03.04- 09.06	CS1400# 24 6.0
		03.04- 09.06	CA18801R	28	100				



SCANIA Continued

	[DC16.06]	04.04-04.04-	CA1851IR	28 80		04.04-	CS1400#	24 6.0
			CA1880IR	28 100				
	[DC16.09]	04.04-04.04-	CA1851IR	28 80		04.04-	CS1400#	24 6.0
			CA1880IR	28 100				
560 15.6	(P/G/R/T Series)[DC16.05]	04.04-	CA1851IR	28 80		04.04-	CS1400#	24 6.0
			CA1880IR	28 100				
	[DC16.18]	03.08-03.08-	CA1851IR	28 80		03.08-	CS1400#	24 6.0
			CA1880IR	28 100				
580 15.6	(P/G/R/T Series)[DC16.03]	03.04-09.06	CA1851IR	28 80		03.04-09.06	CS1400#	24 6.0
			CA1880IR	28 100				
620 15.6	(P/G/R/T Series)[DC16.08]	09.04-	CA1851IR	28 80		09.04-	CS1400#	24 6.0
			CA1880IR	28 100				
	[DC16.17]	03.08-03.08-	CA1851IR	28 80		03.08-	CS1400#	24 6.0
			CA1880IR	28 100				
	[DT16.08]	02.06-02.06-	CA1851IR	28 80		02.06-	CS1400#	24 6.0
			CA1880IR	28 100				
112 H/280 11.0	[DS11.14]	01.81-05.88	CA130IR	28 35 BO		01.81-05.88	CS98	24 5.5
		01.81-05.88	CA227IR	28 55 BO		01.84-05.88	CS881	24 6.6
		01.81-05.88	CA749IR	28 55 PR				
112 H/305 11.0	[DS11.15]	01.81-08.89	CA130IR	28 35 BO		01.84-08.91	CS881	24 6.6
		01.81-08.89	CA227IR	28 55 BO		01.81-12.93	CS98	24 5.5
		01.81-08.89	CA749IR	28 55 PR				
		08.89-08.91	CA550IR	28 55 BO				
		08.89-08.91	CA558IR	28 73 PR				
		08.89-08.91	CA748IR	28 55 PR				
112 M/305 11.0	[DS11.15]	01.81-08.89	CA130IR	28 35 BO		01.81-12.83	CS98	24 5.5
		01.81-08.89	CA227IR	28 55 BO		01.84-08.91	CS881	24 6.6
		01.81-08.89	CA749IR	28 55 PR				
		08.89-08.91	CA550IR	28 55 BO				
		08.89-08.91	CA558IR	28 73 PR				
		08.89-08.91	CA748IR	28 55 PR				
113 E/320 11.0	[DSC11.16]	11.91-05.00	CA1438IR	28 80 BO		11.91-05.00	CS881	24 6.6
		11.91-05.00	CA550IR	28 55 BO				
		11.91-05.00	CA558IR	28 73 PR				
		11.91-05.00	CA748IR	28 55 PR				
		01.94-05.00	CA1148IR	28 65				
	[DSC11.17]	11.91-02.95	CA1438IR	28 80 BO		11.91-02.95	CS881	24 6.6
		11.91-02.95	CA550IR	28 55 BO				
		11.91-02.95	CA558IR	28 73 PR				
		11.91-02.95	CA748IR	28 55 PR				
	[DSC11.21]	11.91-05.00	CA1438IR	28 80 BO		11.91-05.00	CS881	24 6.6
		11.91-05.00	CA550IR	28 55 BO				
		11.91-05.00	CA558IR	28 73 PR				
		11.91-05.00	CA748IR	28 55 PR				
113 E/360 11.0	[DSC11.13]	01.90-05.00	CA1438IR	28 80 BO		01.90-05.00	CS881	24 6.6
		01.90-05.00	CA550IR	28 55 BO		01.90-05.00	CS97	24 4.0
		01.90-05.00	CA558IR	28 73 PR		01.90-05.00	CS121	24 6.0
		01.90-05.00	CA748IR	28 55 PR				
		01.94-05.00	CA1148IR	28 65				
	[DSC11.18]	01.90-05.00	CA1438IR	28 80 BO		01.90-05.00	CS121	24 6.0
		01.90-05.00	CA550IR	28 55 BO		01.90-05.00	CS881	24 6.6
		01.90-05.00	CA558IR	28 73 PR		01.90-05.00	CS97	24 4.0
		01.90-05.00	CA748IR	28 55 PR				
	[DSC11.23]	01.90-05.00	CA1438IR	28 80 BO		01.90-05.00	CS881	24 6.6
		01.90-05.00	CA550IR	28 55 BO		01.90-05.00	CS97	24 4.0
		01.90-05.00	CA558IR	28 73 PR		01.90-05.00	CS121	24 6.0
		01.90-05.00	CA748IR	28 55 PR				
	[DSC11.30]	01.90-02.95	CA1438IR	28 80 BO		01.90-02.95	CS881	24 6.6
		01.90-02.95	CA550IR	28 55 BO				
		01.90-02.95	CA558IR	28 73 PR				
		01.90-02.95	CA748IR	28 55 PR				
		01.94-02.95	CA1148IR	28 65				
113 E/380 11.0	[DSC11.22]	01.91-05.97	CA550IR	28 55 BO		01.91-05.97	CS881	24 6.6
		01.91-05.97	CA748IR	28 55 PR				
	[DSC11.70]	01.91-05.97	CA550IR	28 55 BO		01.91-05.97	CS881	24 6.6
		01.91-05.97	CA748IR	28 55 PR				
113 H/310 11.0	[DS11.34]	05.88-05.97	CA1438IR	28 80 BO		05.88-05.97	CS881	24 6.6
		05.88-08.89	CA227IR	28 55 BO				
		05.88-05.97	CA550IR	28 55 BO				
		05.88-05.97	CA558IR	28 73 PR				
		05.88-05.97	CA748IR	28 55 PR				
		05.88-08.89	CA749IR	28 55 PR				
	[DS11.73]	05.88-02.95	CA1438IR	28 80 BO		05.88-02.95	CS881	24 6.6
		05.88-08.89	CA227IR	28 55 BO				
		05.88-02.95	CA550IR	28 55 BO				
		05.88-02.95	CA558IR	28 73 PR				
		05.88-02.95	CA748IR	28 55 PR				
		05.88-08.89	CA749IR	28 55 PR				
	[DS11.75]	01.90-12.98	CA1438IR	28 80 BO		01.90-12.98	CS881	24 6.6
		01.90-12.98	CA550IR	28 55 BO				
		01.90-12.98	CA558IR	28 73 PR				
		01.90-12.98	CA748IR	28 55 PR				
	[DSC11.08]	01.90-05.00	CA1438IR	28 80 BO		01.90-05.00	CS881	24 6.6
		01.90-05.00	CA550IR	28 55 BO				
		01.90-05.00	CA558IR	28 73 PR				
		01.90-05.00	CA748IR	28 55 PR				
113 H/320 11.0	[DSC11.16]	05.88-05.00	CA1438IR	28 80 BO		05.88-05.00	CS881	24 6.6
		05.88-08.89	CA227IR	28 55 BO				
		05.88-05.00	CA550IR	28 55 BO				
		05.88-05.00	CA558IR	28 73 PR				
		05.88-05.00	CA748IR	28 55 PR				
		05.88-08.89	CA749IR	28 55 PR				
		01.94-05.00	CA1148IR	28 65				
	[DSC11.17]	01.90-02.95	CA1438IR	28 80 BO		01.90-02.95	CS881	24 6.6
		01.90-02.95	CA550IR	28 55 BO				
		01.90-02.95	CA558IR	28 73 PR				
		01.90-02.95	CA748IR	28 55 PR				
	[DSC11.21]	01.90-05.00	CA1148IR	28 65		01.90-05.00	CS881	24 6.6
		01.90-05.00	CA1438IR	28 80 BO				
		01.90-05.00	CA550IR	28 55 BO				
		01.90-05.00	CA558IR	28 73 PR				
		01.90-05.00	CA748IR	28 55 PR				
113 H/360 11.0	[DSC11.13]	05.88-05.00	CA1438IR	28 80 BO		05.88-05.00	CS881	24 6.6
		05.88-08.89	CA227IR	28 55 BO		05.88-05.00	CS97	24 4.0
		05.88-05.00	CA550IR	28 55 BO		05.88-05.00	CS121	24 6.0



		05.88- 05.00	CA558IR	28 73	PR			
		05.88- 05.00	CA748IR	28 55	PR			
		05.88- 08.89	CA749IR	28 55	PR			
		01.94- 05.00	CA1148IR	28 65				
	[DSC11.18]	01.90- 05.00	CA1438IR	28 80	BO	01.90- 05.00	CS881	24 6.6
		01.90- 05.00	CA550IR	28 55	BO	01.90- 05.00	CS97	24 4.0
		01.90- 05.00	CA558IR	28 73	PR	01.90- 05.00	CS121	24 6.0
		01.90- 05.00	CA748IR	28 55	PR			
	[DSC11.23]	01.90- 05.00	CA1438IR	28 80	BO	01.90- 05.00	CS881	24 6.6
		01.90- 05.00	CA550IR	28 55	BO	01.90- 05.00	CS97	24 4.0
		01.90- 05.00	CA558IR	28 73	PR	01.90- 05.00	CS121	24 6.0
		01.90- 05.00	CA748IR	28 55	PR			
	[DSC11.30]	01.90- 02.95	CA1438IR	28 80	BO	01.90- 02.95	CS881	24 6.6
		01.90- 02.95	CA550IR	28 55	BO			
		01.90- 02.95	CA558IR	28 73	PR			
		01.90- 02.95	CA748IR	28 55	PR			
		01.94- 02.95	CA1148IR	28 65				
113 H/380 11.0	[DSC11.22]	01.91- 05.97	CA550IR	28 55	BO	01.91- 05.97	CS881	24 6.6
		01.91- 05.97	CA748IR	28 55	PR			
	[DSC11.70]	01.91- 05.97	CA550IR	28 55	BO	01.91- 05.97	CS881	24 6.6
		01.91- 05.97	CA748IR	28 55	PR			
113 M/320 11.0	[DSC11.16]	05.88- 08.89	CA227IR	28 55	BO	05.88- 05.00	CS881	24 6.6
		05.88- 08.89	CA749IR	28 55	PR			
		08.89- 05.00	CA1438IR	28 80	BO			
		08.89- 05.00	CA550IR	28 55	BO			
		08.89- 05.00	CA558IR	28 73	PR			
		08.89- 05.00	CA748IR	28 55	PR			
		01.94- 05.00	CA1148IR	28 65				
	[DSC11.17]	01.90- 02.95	CA1438IR	28 80	BO	01.90- 02.95	CS881	24 6.6
		01.90- 02.95	CA550IR	28 55	BO			
		01.90- 02.95	CA558IR	28 73	PR			
		01.90- 02.95	CA748IR	28 55	PR			
	[DSC11.21]	01.90- 05.00	CA1438IR	28 80	BO	01.90- 05.00	CS881	24 6.6
		01.90- 05.00	CA550IR	28 55	BO			
		01.90- 05.00	CA558IR	28 73	PR			
		01.90- 05.00	CA748IR	28 55	PR			
113 M/360 11.0	[DSC11.13]	05.88- 08.89	CA227IR	28 55	BO	05.88- 05.00	CS881	24 6.6
		05.88- 08.89	CA749IR	28 55	PR	05.88- 05.00	CS121	24 6.0
		08.89- 05.00	CA1438IR	28 80	BO	05.88- 05.00	CS97	24 4.0
		08.89- 05.00	CA550IR	28 55	BO			
		08.89- 05.00	CA558IR	28 73	PR			
		08.89- 05.00	CA748IR	28 55	PR			
		01.94- 05.00	CA1148IR	28 65				
	[DSC11.18]	01.90- 05.00	CA1438IR	28 80	BO	01.90- 05.00	CS881	24 6.6
		01.90- 05.00	CA550IR	28 55	BO	01.90- 05.00	CS121	24 6.0
		01.90- 05.00	CA558IR	28 73	PR	01.90- 05.00	CS97	24 4.0
		01.90- 05.00	CA748IR	28 55	PR			
	[DSC11.23]	01.90- 05.00	CA1438IR	28 80	BO	01.90- 05.00	CS881	24 6.6
		01.90- 05.00	CA550IR	28 55	BO	01.90- 05.00	CS97	24 4.0
		01.90- 05.00	CA558IR	28 73	PR	01.90- 05.00	CS121	24 6.0
		01.90- 05.00	CA748IR	28 55	PR			
	[DSC11.30]	01.90- 02.95	CA1438IR	28 80	BO	01.90- 02.95	CS881	24 6.6
		01.90- 02.95	CA550IR	28 55	BO			
		01.90- 02.95	CA558IR	28 73	PR			
		01.90- 02.95	CA748IR	28 55	PR			
		01.94- 02.95	CA1148IR	28 65				
113 M/380 11.0	[DSC11.22]	01.91- 05.97	CA550IR	28 55	BO	01.91- 05.97	CS881	24 6.6
		01.91- 05.97	CA748IR	28 55	PR			
	[DSC11.70]	01.91- 05.97	CA550IR	28 55	BO	01.91- 05.97	CS881	24 6.6
		01.91- 05.97	CA748IR	28 55	PR			
113 M/400 11.0	[DTC11.01]	01.92- 05.97	CA550IR	28 55	BO	01.92- 05.97	CS1284	24 6.6
		01.92- 05.97	CA748IR	28 55	PR	01.92- 05.97	CS121	24 6.0
	[DTC11.02]	01.94- 05.97	CA550IR	28 55	BO	01.94- 05.97	CS1284	24 6.6
		01.94- 05.97	CA748IR	28 55	PR	01.94- 05.97	CS121	24 6.0
114 C/340 10.6	[DC11.01]		CA1148IR	28 65				
			CA1744IR	28 65				
	[DC11.03]		CA1148IR	28 65			CS97	24 4.0
		09.04	CA1744IR	28 65				
114 C/340 11.0	[DC11.01]	03.96- 09.04	CA1148IR	28 65		03.93- 09.04	CS121	24 6.0
		03.96- 09.04	CA1310IR	28 90		03.93- 09.04	CS97	24 4.0
		03.96- 09.04	CA1744IR	28 65		03.96- 09.04	CS1061	24 6.7
		03.96- 09.04	CA1842IR	28 100		03.96- 09.04	CS1169	24 6.7
	[DC11.03]	02.96- 09.04	CA1148IR	28 65		02.96- 09.04	CS1061	24 6.7
		02.96- 09.04	CA1744IR	28 65		02.96- 09.04	CS1169	24 6.7
		05.96- 09.04	CA1310IR	28 90		02.96- 09.04	CS121	24 6.0
		03.98- 09.04	CA1842IR	28 100		02.96- 09.04	CS97	24 4.0
	[DSC11.79]	05.96- 05.99	CA1148IR	28 65		05.96- 05.99	CS121	24 6.0
		05.96- 05.99	CA1744IR	28 65		05.96- 05.99	CS97	24 4.0
						05.96- 05.99	CS1199	24 6.7
		05.96- 05.99	CA1148IR	28 65				
114 C/380 10.6	[DC11.02]	03.96- 02.02	CA1148IR	28 65		03.96- 02.02	CS1061	24 6.7
		03.96- 02.02	CA1310IR	28 90		03.96- 02.02	CS121	24 6.0
		03.96- 02.02	CA1842IR	28 100		03.96- 02.02	CS1169	24 6.7
		02.02	CA1744IR	28 65		03.96- 02.02	CS97	24 4.0
						03.96- 02.02	CS1199	24 6.7
	[DC11.04]		CA1148IR	28 65				
		09.04	CA1744IR	28 65				
114 G/340 10.6	[DC11.01]	09.04	CA1148IR	28 65		03.96- 09.04	CS97	24 4.0
		09.04	CA1744IR	28 65		03.96- 09.04	CS1169	24 6.7
						03.96- 09.04	CS1061	24 6.7
						03.96- 09.04	CS121	24 6.0
	[DC11.03]	03.98- 09.04	CA1744IR	28 65		03.98- 09.04	CS97	24 4.0
		09.04	CA1148IR	28 65		03.98- 09.04	CS1169	24 6.7
						03.98- 09.04	CS1061	24 6.7
						03.98- 09.04	CS121	24 6.0
114 G/340 11.0	[DC11.01]	03.96- 02.02	CA1148IR	28 65		03.96- 02.02	CS1061	24 6.7
		03.96- 02.02	CA1310IR	28 90		03.96- 02.02	CS1169	24 6.7
		03.96- 02.02	CA1744IR	28 65		03.96- 02.02	CS97	24 4.0
		03.96- 02.02	CA1842IR	28 100		03.96- 02.02	CS121	24 6.0
	[DSC11.79]	05.96- 05.99	CA1148IR	28 65		05.96- 05.99	CS1199	24 6.7
		05.96- 05.99	CA1310IR	28 90		05.96- 05.99	CS97	24 4.0
		05.96- 05.99	CA1744IR	28 65		05.96- 05.99	CS121	24 6.0
		05.96- 05.99	CA1842IR	28 100				
114 G/380 10.6	[DC11.02]	03.96- 02.02	CA1310IR	28 90		03.96- 02.02	CS1061	24 6.7
		03.96- 02.02	CA1842IR	28 100		03.96- 02.02	CS121	24 6.0
		02.02	CA1148IR	28 65		03.96- 02.02	CS97	24 4.0
		02.02	CA1744IR	28 65		03.96- 02.02	CS1169	24 6.7
	[DC11.04]		CA1744IR	28 65				



**SCANIA Continued**

114 L/340 10.6	[DC11.01]	03.96- 02.02 CA1310IR 28 90	03.96- 02.02 CS121 24 6.0
		03.96- 02.02 CA1744IR 28 65	03.96- 02.02 CS97 24 4.0
		03.96- 02.02 CA1842IR 28 100	03.96- 02.02 CS1169 24 6.7
		03.96- 02.02 CA1148IR 28 65	03.96- 02.02 CS1061 24 6.7
[DC11.02]	03.96- 02.02 CA1148IR 28 65	03.96- 02.02 CS1169 24 6.7	
	03.96- 02.02 CA1310IR 28 90	03.96- 02.02 CS97 24 4.0	
	03.96- 02.02 CA1744IR 28 65	03.96- 02.02 CS121 24 6.0	
	03.96- 02.02 CA1842IR 28 100	03.96- 02.02 CS1061 24 6.7	
[DC11.03]	05.96- 09.04 CA1310IR 28 90	05.96- 09.04 CS1169 24 6.7	
	05.96- 09.04 CA1744IR 28 65	05.96- 09.04 CS1061 24 6.7	
	03.98- 09.04 CA1842IR 28 100	05.96- 09.04 CS97 24 4.0	
	09.04 CA1148IR 28 65	05.96- 09.04 CS121 24 6.0	
114 L/340 11.0	[DSC11.79]	05.96- 05.99 CA1148IR 28 65	05.96- 05.99 CS121 24 6.0
		05.96- 05.99 CA1744IR 28 65	05.96- 05.99 CS97 24 4.0
			05.96- 05.99 CS1199 24 6.7
114 L/380 10.6	[DC11.02]	03.96- 02.02 CA1148IR 28 65	03.96- 02.02 CS121 24 6.0
		03.96- 02.02 CA1310IR 28 90	03.96- 02.02 CS97 24 4.0
		03.96- 02.02 CA1842IR 28 100	03.96- 02.02 CS1061 24 6.7
		03.96- 02.02 CA1744IR 28 65	03.96- 02.02 CS1169 24 6.7
[DC11.04]	02.96- 09.04 CA1148IR 28 65		
		CA1744IR 28 65	
114 L/530 14.2	[DSC14.13]	01.96- 08.01 CA1744IR 28 65	
124 G/420 11.7	[DSC12.05]	CA1744IR 28 65	CS97 24 4.0
124 C/360 11.7	[DC12.02]	09.95- 09.04 CA1744IR 28 65	
		09.96- 02.02 CA1310IR 28 90	09.96- 02.02 CS121 24 6.0
		09.96- 02.02 CA1842IR 28 100	09.96- 02.02 CS1061 24 6.7
		02.02 CA1148IR 28 65	09.96- 02.02 CS97 24 4.0
		09.04 CA1744IR 28 65	
124 C/400 11.7	[DSC12.01]	09.96- 01.00 CA1148IR 28 65	09.96- 01.00 CS1061 24 6.7
		09.96- 01.00 CA1310IR 28 90	09.96- 01.00 CS121 24 6.0
		09.96- 01.00 CA1744IR 28 65	09.96- 01.00 CS97 24 4.0
		09.96- 01.00 CA1842IR 28 100	
124 C/420 11.7	[DC12.01]	09.95- 08.02 CA1148IR 28 65	
		08.02 CA1744IR 28 65	
	[DSC12.05]	09.95- 02.02 CA1842IR 28 100	09.95- 02.02 CS121 24 6.0
		02.02 CA1148IR 28 65	09.95- 02.02 CS1061 24 6.7
		02.02 CA1744IR 28 65	09.95- 02.02 CS97 24 4.0
124 C/470 11.7	[DT12.02]	CA1148IR 28 65	
124 G/ 420 11.7	[DSC12.05]	CA1148IR 28 65	
124 G/360 11.7	[DSC12.02]	05.96- 02.02 CA1148IR 28 65	05.96- 02.02 CS97 24 4.0
		05.96- 02.02 CA1310IR 28 90	05.96- 02.02 CS1061 24 6.7
		05.96- 02.02 CA1744IR 28 65	05.96- 02.02 CS121 24 6.0
		05.96- 02.02 CA1842IR 28 100	
124 G/400 11.7	[DSC12.01]	05.96- 01.00 CA1148IR 28 65	05.96- 01.00 CS1061 24 6.7
		05.96- 01.00 CA1310IR 28 90	05.96- 01.00 CS121 24 6.0
		05.96- 01.00 CA1744IR 28 65	05.96- 01.00 CS97 24 4.0
		05.96- 01.00 CA1842IR 28 100	
124 G/420 11.7	[DC12.01]	09.95- 08.02 CA1148IR 28 65	
		CA1744IR 28 65	
	[DSC12.05]	CA1148IR 28 65	
		CA1744IR 28 65	
124 G/470 11.7	[DT12.02]	09.00- 09.04 CA1148IR 28 65	
		CA1744IR 28 65	
124 L/360 11.7	[DSC12.02]	09.96- 02.02 CA1148IR 28 65	09.96- 02.02 CS97 24 4.0
		09.96- 02.02 CA1310IR 28 90	09.96- 02.02 CS121 24 6.0
		09.96- 02.02 CA1744IR 28 65	09.96- 02.02 CS1061 24 6.7
		09.96- 02.02 CA1842IR 28 100	
124 L/400 11.7	[DSC12.01]	09.96- 01.00 CA1148IR 28 65	09.96- 01.00 CS121 24 6.0
		09.96- 01.00 CA1310IR 28 90	09.96- 01.00 CS97 24 4.0
		09.96- 01.00 CA1744IR 28 65	09.96- 01.00 CS1061 24 6.7
		09.96- 01.00 CA1842IR 28 100	
124 L/420 11.7	[DC12.01]	08.02 CA1744IR 28 65	
		CA1744IR 28 65	
	[DC12.03]	09.97- 02.02 CA1148IR 28 65	09.97- 02.02 CS97 24 4.0
		09.97- 02.02 CA1310IR 28 90	09.97- 02.02 CS121 24 6.0
		09.97- 02.02 CA1842IR 28 100	09.97- 02.02 CS1061 24 6.7
		02.02 CA1744IR 28 65	
124 L/440 11.7	[DT12.08]	09.00- 09.04 CA1148IR 28 65	09.00- 09.04 CS121 24 6.0
		09.00- 09.04 CA1744IR 28 65	09.00- 09.04 CS97 24 4.0
			09.00- 09.04 CS1061 24 6.7
124 L/470 11.7	[DT12.02]	09.00- 09.04 CA1744IR 28 65	01.01- 09.04 CS121 24 6.0
		09.04 CA1148IR 28 65	01.01- 09.04 CS1061 24 6.7
			01.01- 09.04 CS97 24 4.0
143 E/420 14.2	[DSC14.08]	01.91- 12.96 CA1438IR 28 80 BO	01.91- 12.96 CS121 24 6.0
		01.91- 12.96 CA550IR 28 55 BO	01.91- 12.96 CS1284 24 6.6
		01.91- 12.96 CA558IR 28 73 PR	01.91- 12.96 CS97 24 4.0
		01.91- 12.96 CA748IR 28 55 PR	01.91- 12.96 CS881 24 6.6
		01.94- 12.96 CA1148IR 28 65	
143 E/450 14.2	[DSC14.03]	01.90- 12.96 CA1438IR 28 80 BO	01.90- 12.96 CS1284 24 6.6
		01.90- 12.96 CA550IR 28 55 BO	01.90- 12.96 CS121 24 6.0
		01.90- 12.96 CA558IR 28 73 PR	01.90- 12.96 CS97 24 4.0
		01.90- 12.96 CA748IR 28 55 PR	01.90- 12.96 CS881 24 6.6
		01.94- 12.96 CA1148IR 28 65	
[DSC14.10]	01.90- 12.96 CA1438IR 28 80 BO	01.90- 12.96 CS1284 24 6.6	
	01.90- 12.96 CA550IR 28 55 BO	01.90- 12.96 CS97 24 4.0	
	01.90- 12.96 CA558IR 28 73 PR	01.90- 12.96 CS881 24 6.6	
	01.90- 12.96 CA748IR 28 55 PR	01.90- 12.96 CS121 24 6.0	
	01.94- 12.96 CA1148IR 28 65		
143 E/500 14.2	[DSC14.09]	01.91- 12.96 CA1438IR 28 80 BO	01.91- 12.96 CS881 24 6.6
		01.91- 12.96 CA550IR 28 55 BO	01.91- 12.96 CS1284 24 6.6
		01.91- 12.96 CA558IR 28 73 PR	01.91- 12.96 CS121 24 6.0
		01.91- 12.96 CA748IR 28 55 PR	01.91- 12.96 CS97 24 4.0
		01.94- 12.96 CA1148IR 28 65	
[DSC14.16]	12.94- 12.96 CA1148IR 28 65	12.94- 12.96 CS97 24 4.0	
	12.94- 12.96 CA1438IR 28 80 BO	12.94- 12.96 CS881 24 6.6	
	12.94- 12.96 CA550IR 28 55 BO	12.94- 12.96 CS121 24 6.0	
	12.94- 12.96 CA558IR 28 73 PR	12.94- 12.96 CS1284 24 6.6	
	12.94- 12.96 CA748IR 28 55 PR		
143 H/400 14.2	[DSC14.06]	05.88- 08.89 CA227IR 28 55 BO	05.88- 12.96 CS121 24 6.0
		05.88- 08.89 CA749IR 28 55 PR	05.88- 12.96 CS881 24 6.6
		08.89- 12.96 CA1438IR 28 80 BO	05.88- 12.96 CS1284 24 6.6
		08.89- 12.96 CA550IR 28 55 BO	05.88- 12.96 CS97 24 4.0
		08.89- 12.96 CA558IR 28 73 PR	
		08.89- 12.96 CA748IR 28 55 PR	
143 H/420 14.2	[DSC14.08]	01.91- 12.96 CA1438IR 28 80 BO	01.91- 12.96 CS881 24 6.6
		01.91- 12.96 CA550IR 28 55 BO	01.91- 12.96 CS121 24 6.0
		01.91- 12.96 CA558IR 28 73 PR	01.91- 12.96 CS97 24 4.0
		01.91- 12.96 CA748IR 28 55 PR	01.91- 12.96 CS1284 24 6.6
		01.94- 12.96 CA1148IR 28 65	



143 H/450 14.2	[DSC14.03]	05.88- 08.89	CA2271R	28 55	BO	05.88- 12.96	CS97	24 4.0	
		05.88- 08.89	CA7491R	28 55	PR	05.88- 12.96	CS881	24 6.6	
		08.89- 12.96	CA14381R	28 80	BO	05.88- 12.96	CS1284	24 6.6	
		08.89- 12.96	CA5501R	28 55	BO	05.88- 12.96	CS121	24 6.0	
		08.89- 12.96	CA5581R	28 73	PR				
		08.89- 12.96	CA7481R	28 55	PR				
	01.94- 12.96	CA11481R	28 65						
	[DSC14.06]	05.88- 12.89	CA2271R	28 55	BO	05.88- 12.96	CS97	24 4.0	
		05.88- 12.96	CA5501R	28 55	BO	05.88- 12.96	CS881	24 6.6	
		05.88- 12.96	CA7481R	28 55	PR	05.88- 12.96	CS1284	24 6.6	
		05.88- 12.89	CA7491R	28 55	PR	05.88- 12.96	CS121	24 6.0	
		01.90- 12.96	CA14381R	28 80	BO	01.90- 12.96	CS1284	24 6.6	
	[DSC14.10]	01.90- 12.96	CA5501R	28 55	BO	01.90- 12.96	CS121	24 6.0	
		01.90- 12.96	CA5581R	28 73	PR	01.90- 12.96	CS97	24 4.0	
		01.90- 12.96	CA7481R	28 55	PR	01.90- 12.96	CS881	24 6.6	
01.94- 12.96		CA11481R	28 65						
143 H/470 14.2	[DSC14.04]	03.88- 08.89	CA2271R	28 55	BO	03.88- 12.96	CS97	24 4.0	
		03.88- 08.89	CA7491R	28 55	PR	03.88- 12.96	CS121	24 6.0	
		08.89- 12.96	CA14381R	28 80	BO	03.88- 12.96	CS881	24 6.6	
		08.89- 12.96	CA5501R	28 55	BO	03.88- 12.96	CS1284	24 6.6	
		08.89- 12.96	CA5581R	28 73	PR				
		08.89- 12.96	CA7481R	28 55	PR				
143 H/500 14.2	[DSC14.09]	01.91- 12.96	CA14381R	28 80	BO	01.91- 12.96	CS97	24 4.0	
		01.91- 12.96	CA5501R	28 55	BO	01.91- 12.96	CS121	24 6.0	
		01.91- 12.96	CA5581R	28 73	PR	01.91- 12.96	CS881	24 6.6	
		01.91- 12.96	CA7481R	28 55	PR	01.91- 12.96	CS1284	24 6.6	
	01.94- 12.96	CA11481R	28 65						
	[DSC14.16]	12.94- 12.96	CA11481R	28 65		12.94- 12.96	CS97	24 4.0	
12.94- 12.96		CA14381R	28 80	BO	12.94- 12.96	CS881	24 6.6		
12.94- 12.96		CA5501R	28 55	BO	12.94- 12.96	CS1284	24 6.6		
12.94- 12.96		CA5581R	28 73	PR	12.94- 12.96	CS121	24 6.0		
12.94- 12.96		CA7481R	28 55	PR					
143 M/420 14.2	[DSC14.08]	01.91- 12.96	CA14381R	28 80	BO	01.91- 12.96	CS121	24 6.0	
		01.91- 12.96	CA5501R	28 55	BO	01.91- 12.96	CS97	24 4.0	
		01.91- 12.96	CA5581R	28 73	PR	01.91- 12.96	CS881	24 6.6	
		01.91- 12.96	CA7481R	28 55	PR	01.91- 12.96	CS1284	24 6.6	
		01.94- 12.96	CA11481R	28 65					
143 M/450 14.2	[DSC14.03]	05.88- 12.96	CA14381R	28 80	BO	05.88- 12.96	CS881	24 6.6	
		05.88- 08.89	CA2271R	28 55	BO	05.88- 12.96	CS121	24 6.0	
		05.88- 12.96	CA5501R	28 55	BO	05.88- 12.96	CS1284	24 6.6	
		05.88- 12.96	CA5581R	28 73	PR	05.88- 12.96	CS97	24 4.0	
		05.88- 12.96	CA7481R	28 55	PR				
		05.88- 08.89	CA7491R	28 55	PR				
		01.94- 12.96	CA11481R	28 65					
		[DSC14.10]	01.90- 12.96	CA14381R	28 80	BO	01.90- 12.96	CS97	24 4.0
			01.90- 12.96	CA5501R	28 55	BO	01.90- 12.96	CS881	24 6.6
			01.90- 12.96	CA5581R	28 73	PR	01.90- 12.96	CS121	24 6.0
	01.90- 12.96		CA7481R	28 55	PR	01.90- 12.96	CS1284	24 6.6	
	01.94- 12.96		CA11481R	28 65					
	143 M/470 14.2	[DSC14.04]	03.88- 08.89	CA2271R	28 55	BO	03.88- 12.96	CS97	24 4.0
			03.88- 08.89	CA7491R	28 55	PR	03.88- 12.96	CS881	24 6.6
			08.89- 12.96	CA14381R	28 80	BO	03.88- 12.96	CS1284	24 6.6
08.89- 12.96			CA5501R	28 55	BO	03.88- 12.96	CS121	24 6.0	
08.89- 12.96			CA5581R	28 73	PR				
08.89- 12.96			CA7481R	28 55	PR				
143 M/500 14.2	[DSC14.09]	01.91- 12.96	CA11481R	28 65		01.91- 12.96	CS881	24 6.6	
		01.91- 12.96	CA14381R	28 80	BO	01.91- 12.96	CS97	24 4.0	
		01.91- 12.96	CA5501R	28 55	BO	01.91- 12.96	CS121	24 6.0	
		01.91- 12.96	CA5581R	28 73	PR	01.91- 12.96	CS1284	24 6.6	
		01.91- 12.96	CA7481R	28 55	PR				
		01.94- 12.96	CA11481R	28 65					
	[DSC14.16]	12.94- 12.96	CA11481R	28 65		12.94- 12.96	CS121	24 6.0	
		12.94- 12.96	CA14381R	28 80	BO	12.94- 12.96	CS1284	24 6.6	
		12.94- 12.96	CA5501R	28 55	BO	12.94- 12.96	CS97	24 4.0	
		12.94- 12.96	CA5581R	28 73	PR	12.94- 12.96	CS881	24 6.6	
		12.94- 12.96	CA7481R	28 55	PR				
144 C/460 14.2	[DSC14.15]	09.96- 08.01	CA11481R	28 65		09.96- 08.01	CS97	24 4.0	
		09.96- 08.01	CA13101R	28 90		09.96- 08.01	CS121	24 6.0	
		09.96- 08.01	CA17441R	28 65		09.96- 08.01	CS1169	24 6.7	
		09.96- 08.01	CA18421R	28 100					
144 C/530 14.2	[DSC14.13]	09.96- 08.01	CA11481R	28 65		09.96- 08.01	CS97	24 4.0	
		09.96- 08.01	CA13101R	28 90		09.96- 08.01	CS121	24 6.0	
		09.96- 08.01	CA17441R	28 65		09.96- 08.01	CS1169	24 6.7	
		09.96- 08.01	CA18421R	28 100					
144 G/460 14.2	[DSC14.15]	04.96- 08.01	CA11481R	28 65		04.96- 08.01	CS121	24 6.0	
		04.96- 08.01	CA13101R	28 90		04.96- 08.01	CS1169	24 6.7	
		04.96- 08.01	CA17441R	28 65		04.96- 08.01	CS97	24 4.0	
		04.96- 08.01	CA18421R	28 100					
144 G/530 14.2	[DSC14.13]	04.96- 08.01	CA11481R	28 65		04.96- 08.01	CS121	24 6.0	
		04.96- 08.01	CA13101R	28 90		04.96- 08.01	CS1169	24 6.7	
		04.96- 08.01	CA17441R	28 65		04.96- 08.01	CS97	24 4.0	
		04.96- 08.01	CA18421R	28 100					
144 L/460 14.2	[DSC14.15]	11.95- 08.01	CA11481R	28 65		11.95- 08.01	CS97	24 4.0	
		11.95- 08.01	CA13101R	28 90		11.95- 08.01	CS121	24 6.0	
		11.95- 08.01	CA18421R	28 100		11.95- 08.01	CS1169	24 6.7	
		11.95- 08.01	CA17441R	28 65					
144 L/530 14.2	[DSC14.13]	11.95- 08.01	CA11481R	28 65		11.95- 08.01	CS97	24 4.0	
		11.95- 08.01	CA13101R	28 90		11.95- 08.01	CS121	24 6.0	
		11.95- 08.01	CA17441R	28 65		11.95- 08.01	CS1169	24 6.7	
		11.95- 08.01	CA18421R	28 100					
164 C/480 15.6	[DC16.02]	05.00-	CA20391R	28 100		05.00-	CS1061	24 6.7	
		Chas. 1286382-, 05.00- 4486866-, 9076848-, 3538386	CA16501R	28 90					
		Chas. -1286381, - 05.00- 4486865, -9076948, - 3538385	CA11481R	28 65					
		Chas. -1286381, - 05.00- 4486865, -9076948, - 3538385	CA17441R	28 65					
		Chas. -1286381, - 05.00- 4486865, -9076948, - 3538385							
164 C/580 15.6	[DC16.01]	05.00-	CA20391R	28 100		05.00-	CS1061	24 6.7	
		Chas. 1286382-, 05.00- 4486866-, 9076848-, 3538386	CA16501R	28 90					
		Chas. -1286381, - 05.00- 4486865, -9076948, - 3538385	CA11481R	28 65					
		Chas. -1286381, - 05.00- 4486865, -9076948, - 3538385	CA17441R	28 65					
		Chas. -1286381, - 05.00- 4486865, -9076948, - 3538385							



SCANIA Continued

164 G/480 15.6	[DC16.02]	05.00-	CA2039IR	28 100	05.00-	CS1061	24 6.7
		05.04	CA1148IR	28 65			
		Chas. 1286382-, 05.00- 4486866-, 9076848-, 3538386	CA1650IR	28 90			
		Chas. -1286381, - 05.00- 4486865, -9076948, - 3538385	CA1148IR	28 65			
		Chas. -1286381, - 05.00- 4486865, -9076948, - 3538385	CA1744IR	28 65			
164 G/580 15.6	[DC16.01]	04.00- 05.04	CA1744IR	28 65	05.00-	CS1061	24 6.7
		05.00-	CA2039IR	28 100			
		Chas. 1286382-, 05.00- 4486866-, 9076848-, 3538386	CA1650IR	28 90			
		Chas. -1286381, - 05.00- 4486865, -9076948, - 3538385	CA1148IR	28 65			
		Chas. -1286381, - 05.00- 4486865, -9076948, - 3538385	CA1744IR	28 65			
164 L/480 15.6	[DC16.02]	04.00- 09.04	CA1148IR	28 65	05.00-	CS1061	24 6.7
		05.00-	CA2039IR	28 100			
		Chas. 1286382-, 05.00- 4486866-, 9076848-, 3538386	CA1650IR	28 90			
		Chas. -1286381, - 05.00- 4486865, -9076948, - 3538385	CA1148IR	28 65			
		Chas. -1286381, - 05.00- 4486865, -9076948, - 3538385	CA1744IR	28 65			
164 L/580 15.6	[DC16.01]	04.00- 05.04	CA1148IR	28 65	05.00-	CS1061	24 6.7
		04.00- 05.04	CA1744IR	28 65			
		05.00-	CA2039IR	28 100			
		Chas. 1286382-, 05.00- 4486866-, 9076848-, 3538386	CA1650IR	28 90			
		Chas. -1286381, - 05.00- 4486865, -9076948, - 3538385	CA1148IR	28 65			
82 H/210 7.8	[DS8.05]	01.81- 08.89	CA130IR	28 35 BO	01.81- 03.88	CS97	24 4.0
		01.81- 08.89	CA227IR	28 55 BO			
		01.81- 08.89	CA749IR	28 55 PR			
		01.81- 08.89	CA130IR	28 35 BO			
		01.81- 08.89	CA227IR	28 55 BO			
82 M/190 7.8	[DS8.06]	10.82- 03.88	CA130IR	28 35 BO	10.82- 03.88	CS97	24 4.0
		10.82- 03.88	CA227IR	28 55 BO			
		10.82- 03.88	CA749IR	28 55 PR			
		01.81- 08.89	CA130IR	28 35 BO			
		01.81- 08.89	CA227IR	28 55 BO			
82 M/210 7.8	[DS8.05]	01.81- 08.89	CA130IR	28 35 BO	01.81- 03.88	CS97	24 4.0
		01.81- 08.89	CA227IR	28 55 BO			
		01.81- 08.89	CA749IR	28 55 PR			
		01.87- 03.88	CA130IR	28 35 BO			
		01.87- 03.88	CA227IR	28 55 BO			
92 H/245 8.5	[DS9.01]	01.87- 03.88	CA130IR	28 35 BO	01.87- 03.88	CS97	24 4.0
		01.87- 03.88	CA227IR	28 55 BO			
		01.87- 03.88	CA749IR	28 55 PR			
		01.87- 03.88	CA130IR	28 35 BO			
		01.87- 03.88	CA227IR	28 55 BO			
92 H/275 8.5	[DSC9.01]	01.87- 03.88	CA130IR	28 35 BO	01.87- 03.88	CS97	24 4.0
		01.87- 03.88	CA227IR	28 55 BO			
		01.87- 03.88	CA749IR	28 55 PR			
		01.85- 03.88	CA130IR	28 35 BO			
		01.85- 03.88	CA227IR	28 55 BO			
92 M/245 8.5	[DS9.01]	01.85- 03.88	CA130IR	28 35 BO	01.85- 03.88	CS97	24 4.0
		01.85- 03.88	CA227IR	28 55 BO			
		01.85- 03.88	CA749IR	28 55 PR			
		01.85- 03.88	CA130IR	28 35 BO			
		01.85- 03.88	CA227IR	28 55 BO			
92 M/275 8.5	[DS9.01]	01.85- 03.88	CA130IR	28 35 BO	01.85- 03.88	CS97	24 4.0
		01.85- 03.88	CA227IR	28 55 BO			
		01.85- 03.88	CA749IR	28 55 PR			
		01.85- 03.88	CA130IR	28 35 BO			
		01.85- 03.88	CA227IR	28 55 BO			
93 H/220 8.5	[DSC9.10]	12.91- 08.97	CA1438IR	28 80 BO	12.91- 08.97	CS97	24 4.0
		12.91- 08.97	CA550IR	28 55 BO			
		12.91- 08.97	CA558IR	28 73 PR			
		12.91- 08.97	CA748IR	28 55 PR			
		12.91- 08.97	CA1148IR	28 65			
93 H/250 8.5	[DS9.05]	03.88- 08.89	CA227IR	28 55 BO	03.88- 01.91	CS97	24 4.0
		03.88- 01.91	CA550IR	28 55 BO			
		03.88- 01.91	CA558IR	28 73 PR			
		03.88- 01.91	CA748IR	28 55 PR			
		03.88- 08.89	CA749IR	28 55 PR			
93 H/250 8.5	[DSC9.07]	01.89- 08.89	CA130IR	28 35 BO	12.91- 08.97	CS97	24 4.0
		08.89- 01.91	CA1438IR	28 80 BO			
		12.91- 08.97	CA1438IR	28 80 BO			
		12.91- 08.97	CA550IR	28 55 BO			
		12.91- 08.97	CA558IR	28 73 PR			
93 H/280 8.5	[DSC9.02]	12.91- 12.96	CA1438IR	28 80 BO	12.91- 12.96	CS97	24 4.0
		12.91- 12.96	CA550IR	28 55 BO			
		12.91- 12.96	CA558IR	28 73 PR			
		12.91- 12.96	CA748IR	28 55 PR			
		12.91- 12.96	CA1148IR	28 65			
93 H/280 8.5	[DSC9.08]	12.91- 08.97	CA1438IR	28 80 BO	12.91- 08.97	CS121	24 6.0
		12.91- 08.97	CA550IR	28 55 BO			
		12.91- 08.97	CA558IR	28 73 PR			
		12.91- 08.97	CA748IR	28 55 PR			
		12.91- 08.97	CA1148IR	28 65			
93 M/210 8.5	[DS9.08]	03.88- 08.89	CA227IR	28 55 BO	03.88- 01.93	CS121	24 6.0
		03.88- 08.89	CA749IR	28 55 PR			
		08.89- 01.93	CA1438IR	28 80 BO			
		08.89- 01.93	CA550IR	28 55 BO			
		08.89- 01.93	CA558IR	28 73 PR			
93 M/220 8.5	[DSC9.10]	08.89- 01.93	CA748IR	28 55 PR	12.91- 08.97	CS97	24 4.0
		12.91- 08.97	CA1438IR	28 80 BO			
		12.91- 08.97	CA550IR	28 55 BO			
		12.91- 08.97	CA558IR	28 73 PR			
		12.91- 08.97	CA748IR	28 55 PR			
93 M/230 8.5	[DS9.06]	03.88- 08.89	CA227IR	28 55 BO	03.88- 01.93	CS881	24 6.6
		03.88- 08.89	CA749IR	28 55 PR			
		08.89- 01.93	CA1438IR	28 80 BO			
		08.89- 01.93	CA550IR	28 55 BO			
		08.89- 01.93	CA558IR	28 73 PR			



			08.89- 01.93	CA558IR	28 73	PR			
			08.89- 01.93	CA748IR	28 55	PR			
93 M/250 8.5	[DS9.05]		03.88- 08.89	CA227IR	28 55	BO	03.88- 01.91	CS121	24 6.0
			03.88- 01.91	CA550IR	28 55	BO	03.88- 01.91	CS97	24 4.0
			03.88- 01.91	CA558IR	28 73	PR	03.88- 01.91	CS881	24 6.6
			03.88- 01.91	CA748IR	28 55	PR			
			03.88- 08.89	CA749IR	28 55	PR			
			08.89- 01.91	CA1438IR	28 80	BO			
	[DSC9.07]		12.91- 08.97	CA1438IR	28 80	BO	12.91- 08.97	CS121	24 6.0
			12.91- 08.97	CA550IR	28 55	BO	12.91- 08.97	CS97	24 4.0
			12.91- 08.97	CA558IR	28 73	PR	12.91- 08.97	CS881	24 6.6
			12.91- 08.97	CA748IR	28 55	PR			
			01.94- 08.97	CA1148IR	28 65				
93 M/280 8.5	[DSC9.02]		03.88- 08.89	CA227IR	28 55	BO	03.88- 12.96	CS881	24 6.6
			03.88- 08.89	CA749IR	28 55	PR	03.88- 12.96	CS97	24 4.0
			08.89- 12.96	CA1438IR	28 80	BO	03.88- 12.96	CS121	24 6.0
			08.89- 12.96	CA550IR	28 55	BO			
			08.89- 12.96	CA558IR	28 73	PR			
			08.89- 12.96	CA748IR	28 55	PR			
	[DSC9.08]		01.94- 12.96	CA1148IR	28 65				
			01.90- 08.97	CA1438IR	28 80	BO	01.90- 08.97	CS881	24 6.6
			01.90- 08.97	CA550IR	28 55	BO	01.90- 08.97	CS97	24 4.0
			01.90- 08.97	CA558IR	28 73	PR	01.90- 08.97	CS121	24 6.0
			01.90- 08.97	CA748IR	28 55	PR			
			01.94- 08.97	CA1148IR	28 65				
94 /D260 9.0	[DC9.02]		02.00- 09.04	CA1148IR	28 65		02.00- 09.04	CS97	24 4.0
			02.00- 09.04	CA1842IR	28 100		02.00- 09.04	CS121	24 6.0
							02.00- 09.04	CS1169	24 6.7
94 /G260 9.0	[DSC9.12]			CA1148IR	28 65				
94 C/260 9.0	[DSC9.12]		12.96- 10.01	CA1148IR	28 65		12.96- 10.01	CS97	24 4.0
			12.96- 10.01	CA1310IR	28 90		12.96- 10.01	CS1169	24 6.7
			12.96- 10.01	CA1842IR	28 100		12.96- 10.01	CS121	24 6.0
94 C/300 9.0	[DC9.03]		02.00- 09.04	CA1148IR	28 65		02.00- 09.04	CS1169	24 6.7
			02.00- 09.04	CA1842IR	28 100		02.00- 09.04	CS121	24 6.0
							02.00- 09.04	CS97	24 4.0
94 C/310 9.0	[DSC9.13]		08.96- 08.02	CA1148IR	28 65		08.96- 08.02	CS97	24 4.0
			08.96- 08.02	CA1310IR	28 90		08.96- 08.02	CS121	24 6.0
			08.96- 08.02	CA1842IR	28 100		08.96- 08.02	CS1169	24 6.7
	[DSC9.15]		08.96- 08.02	CA1148IR	28 65		08.96- 08.02	CS121	24 6.0
			08.96- 08.02	CA1310IR	28 90		08.96- 08.02	CS1169	24 6.7
			08.96- 08.02	CA1842IR	28 100		08.96- 08.02	CS97	24 4.0
94 D/220 9.0	[DSC9.11]		08.96- 08.02	CA1310IR	28 90		08.96- 08.02	CS97	24 4.0
			08.96- 08.02	CA1842IR	28 100		08.96- 08.02	CS121	24 6.0
			08.02	CA1148IR	28 65		08.96- 08.02	CS1169	24 6.7
94 D/230 9.0	[DC9.01]		04.99- 09.04	CA1148IR	28 65		08.99- 09.04	CS1169	24 6.7
							08.99- 09.04	CS121	24 6.0
							04.99- 09.04	CS97	24 4.0
	[DC9.04]		08.99- 09.04	CA1148IR	28 65		08.99- 09.04	CS1169	24 6.7
							08.99- 09.04	CS121	24 6.0
							08.99- 09.04	CS97	24 4.0
94 D/260 9.0	[DC9.02]		02.00- 09.04	CA1148IR	28 65		02.00- 09.04	CS121	24 6.0
			02.00- 09.04	CA1842IR	28 100		02.00- 09.04	CS1169	24 6.7
							02.00- 09.04	CS97	24 4.0
	[DSC9.12]		08.96- 10.01	CA1310IR	28 90		08.96- 10.01	CS1169	24 6.7
			08.96- 10.01	CA1842IR	28 100		08.96- 10.01	CS97	24 4.0
			10.01	CA1148IR	28 65		08.96- 10.01	CS121	24 6.0
94 D/300 9.0	[DC9.03]		02.00- 09.04	CA1148IR	28 65		02.00- 09.04	CS121	24 6.0
			02.00- 09.04	CA1842IR	28 100		02.00- 09.04	CS1169	24 6.7
							02.00- 09.04	CS97	24 4.0
94 D/310 9.0	[DSC9.13]		12.96- 08.02	CA1310IR	28 90		12.96- 08.02	CS97	24 4.0
			12.96- 08.02	CA1842IR	28 100		12.96- 08.02	CS121	24 6.0
			08.02	CA1148IR	28 65		12.96- 08.02	CS1169	24 6.7
	[DSC9.15]		12.96- 08.02	CA1148IR	28 65		12.96- 08.02	CS121	24 6.0
			12.96- 08.02	CA1310IR	28 90		12.96- 08.02	CS1169	24 6.7
			12.96- 08.02	CA1842IR	28 100		12.96- 08.02	CS97	24 4.0
94 G/220 9.0	[DSC9.11]		08.96- 08.02	CA1148IR	28 65		08.96- 08.02	CS97	24 4.0
			08.96- 08.02	CA1310IR	28 90		08.96- 08.02	CS121	24 6.0
			08.96- 08.02	CA1842IR	28 100		08.96- 08.02	CS1169	24 6.7
94 G/260 9.0	[DSC9.12]		08.96- 10.01	CA1310IR	28 90		08.96- 10.01	CS121	24 6.0
			08.96- 10.01	CA1842IR	28 100		08.96- 10.01	CS1169	24 6.7
			10.01	CA1148IR	28 65		08.96- 10.01	CS97	24 4.0
94 G/310 9.0	[DSC9.13]		08.96- 08.02	CA1310IR	28 90		08.96- 08.02	CS121	24 6.0
			08.96- 08.02	CA1842IR	28 100		08.96- 08.02	CS1169	24 6.7
			08.02	CA1148IR	28 65		08.96- 08.02	CS97	24 4.0
	[DSC9.15]		08.96- 08.02	CA1148IR	28 65		08.96- 08.02	CS121	24 6.0
			08.96- 08.02	CA1310IR	28 90		08.96- 08.02	CS1169	24 6.7
			08.96- 08.02	CA1842IR	28 100		08.96- 08.02	CS97	24 4.0
94 L/310 9.0	[DSC9.13]		08.96- 08.02	CA1148IR	28 65		08.96- 08.02	CS97	24 4.0
			08.96- 08.02	CA1310IR	28 90		08.96- 08.02	CS121	24 6.0
			08.96- 08.02	CA1842IR	28 100		08.96- 08.02	CS1169	24 6.7
	[DSC9.15]		08.96- 08.02	CA1148IR	28 65		08.96- 08.02	CS1169	24 6.7
			08.96- 08.02	CA1310IR	28 90		08.96- 08.02	CS121	24 6.0
			08.96- 08.02	CA1842IR	28 100		08.96- 08.02	CS97	24 4.0
K 113 11.0	[DS11.34]		11.90- 08.98	CA1224IR#	28 120		11.90- 08.98	CS97	24 4.0
			11.90- 08.98	CA550IR	28 55		11.90- 08.98	CS881	24 6.6
	[DS11.73]		07.90- 08.98	CA1224IR#	28 120		07.90- 08.98	CS97	24 4.0
			07.90- 08.98	CA550IR	28 55		07.90- 08.98	CS881	24 6.6
	[DSC11.08]		11.90- 08.98	CA1224IR#	28 120		11.90- 08.98	CS97	24 4.0
			11.90- 08.98	CA550IR	28 55		11.90- 08.98	CS881	24 6.6
K 113 CLB 11.0	[DSC11.22]		07.90- 08.98	CA1224IR#	28 120		07.90- 08.98	CS881	24 6.6
			07.90- 08.98	CA550IR	28 55		07.90- 08.98	CS97	24 4.0
	[DSC11.81]		01.91- 12.97	CA1224IR#	28 120		05.82- 08.98	CS97	24 4.0
K 93 CL 8.5	[DSC9.08]		01.91- 12.97	CA550IR	28 55		05.82- 08.98	CS881	24 6.6
			01.91- 12.01	CA1224IR#	28 120		01.91- 12.01	CS97	24 4.0
			01.91- 12.01	CA1438IR	28 80		01.91- 12.01	CS881	24 6.6
K114 10.6	[DC.]		08.97-	CA1148IR	28 65		08.97-	CS1061	24 6.7
			08.97-	CA1624IR	28 140		08.97-	CS97	24 4.0
			08.97-	CA1851IR	28 80				
			08.97-	CA1880IR	28 100				
K124 12.0	[DC12.]		08.97-	CA1148IR	28 65		08.97-	CS97	24 4.0
			08.97-	CA1624IR	28 140		08.97-	CS1061	24 6.7
	[DSC.]		09.97-	CA1148IR	28 65		09.97-	CS97	24 4.0
			09.97-	CA1624IR	28 140		09.97-	CS1061	24 6.7
L 113 CLB 11.0	[DS11.34]		01.90- 08.98	CA1224IR#	28 120		01.90- 12.96	CS881	24 6.6
			01.90- 08.98	CA550IR	28 55		01.90- 12.96	CS97	24 4.0
	[DSC11.08]		01.90- 08.98	CA1224IR#	28 120		01.90- 12.96	CS881	24 6.6
			01.90- 08.98	CA550IR	28 55		01.90- 12.96	CS97	24 4.0
	[DSC11.24]		11.93- 08.98	CA1224IR#	28 120		11.93- 12.96	CS881	24 6.6
			11.93- 08.98	CA550IR	28 55		11.93- 12.96	CS97	24 4.0



SCANIA Continued

L94 9.0	[DC..]	04.99- 04.99-	CA1148IR CA1624IR	28 65 28 140		04.99-	CS97	24 4.0
P 400 12.7	(P/G/R/T Series)[DC13.05]	04.10-	CA1851IR	28 80		04.10-	CS1399	24 5.5
P 440 12.7	(P/G/R/T Series)[DC13.10]	04.10-	CA1880IR CA1851IR	28 100 28 80		04.10-	CS1399	24 5.5
R 142 E 14.2	[DS14.06]	04.10- 05.80- 03.88	CA1880IR CA130IR CA227IR	28 100 28 35 28 55		05.80- 03.88	CS121 CS1284	24 6.0 24 6.6
R 142 H 14.2	[DS14.06]	05.80- 03.88	CA130IR CA227IR	28 35 28 55		05.80- 03.88	CS1284 CS121	24 6.6 24 6.0
	[DSC14.01]	05.80- 03.88	CA130IR	28 35		05.80- 03.88	CS1284	24 6.6
	[DSC14.02]	05.80- 03.88	CA227IR	28 55		05.80- 03.88	CS121	24 6.0
R 142 M 14.2	[DS14.06]	05.80- 03.88	CA130IR CA227IR	28 35 28 55		05.80- 03.88	CS1284 CS121	24 6.6 24 6.0
R 360 12.7	(P/G/R/T Series)[DC13.06]	05.80- 03.88	CA130IR CA227IR	28 35 28 55		05.80- 03.88	CS1284 CS121	24 6.6 24 6.0
R 380 10.6	(P/G/R/T Series)[DC11.09]	04.10- 03.04-	CA1851IR CA1880IR	28 80 28 100		03.04-	CS1399	24 5.5
R 380 11.7	(P/G/R/T Series)[DC12.18]	04.10-	CA1851IR	28 80		04.10-	CS1399	24 5.5
R 400 12.7	(P/G/R/T Series)[DC13.05]	04.10- 03.08-	CA1880IR CA1851IR	28 100 28 80		03.08-	CS1399	24 5.5
R 440 12.7	(P/G/R/T Series)[DC13.10]	03.08- 04.10-	CA1880IR CA1851IR	28 100 28 80		04.10-	CS1399	24 5.5
R 480 12.7	(P/G/R/T Series)[DC13.07]	04.10-	CA1880IR CA1851IR CA1880IR	28 100 28 80 28 100		04.10-	CS1399	24 5.5
T 113 E/320 11.0	[DSC11.16]	01.90- 05.00	CA1438IR CA550IR CA558IR CA748IR	28 80 BO 28 55 BO 28 73 PR 28 55 PR		01.90- 05.00	CS881	24 6.6
	[DSC11.17]	01.94- 05.00	CA1148IR	28 65				
	[DSC11.21]	01.90- 02.95	CA1438IR CA550IR CA558IR CA748IR	28 80 BO 28 55 BO 28 73 PR 28 55 PR		01.90- 02.95	CS881	24 6.6
T 113 E/360 11.0	[DSC11.13]	01.90- 05.00	CA1438IR CA550IR CA558IR CA748IR	28 80 BO 28 55 BO 28 73 PR 28 55 PR		01.90- 05.00	CS121 CS881 CS97	24 6.0 24 6.6 24 4.0
	[DSC11.18]	01.94- 05.00	CA1148IR	28 65				
	[DSC11.23]	01.90- 05.00	CA1438IR CA550IR CA558IR CA748IR	28 80 BO 28 55 BO 28 73 PR 28 55 PR		01.90- 05.00	CS97 CS121 CS881	24 4.0 24 6.0 24 6.6
T 113 H/320 11.0	[DSC11.16]	01.90- 05.00	CA1438IR CA550IR CA558IR CA748IR	28 80 BO 28 55 BO 28 73 PR 28 55 PR		01.90- 05.00	CS881	24 6.6
	[DSC11.17]	01.94- 05.00	CA1148IR	28 65				
	[DSC11.21]	01.90- 02.95	CA1438IR CA550IR CA558IR CA748IR	28 80 BO 28 55 BO 28 73 PR 28 55 PR		01.90- 02.95	CS881	24 6.6
T 113 H/360 11.0	[DSC11.13]	01.90- 05.00	CA1438IR CA550IR CA558IR CA748IR	28 80 BO 28 55 BO 28 73 PR 28 55 PR		01.90- 05.00	CS121 CS881 CS97	24 6.0 24 6.6 24 4.0
	[DSC11.18]	01.94- 05.00	CA1148IR	28 65				
	[DSC11.23]	01.90- 05.00	CA1438IR CA550IR CA558IR CA748IR	28 80 BO 28 55 BO 28 73 PR 28 55 PR		01.90- 05.00	CS97 CS121 CS881	24 4.0 24 6.0 24 6.6
T 114 C/340 10.6	[DC11.01]	03.96- 02.02	CA1148IR CA1744IR	28 65 28 65		03.96- 02.02	CS1061 CS121 CS1169	24 6.7 24 6.0 24 6.7
	[DC11.03]	02.96- 09.04	CA1148IR CA1744IR	28 65 28 65		02.96- 09.04	CS97 CS121 CS1169 CS1061 CS97	24 4.0 24 6.0 24 6.7 24 6.7 24 4.0
T 114 C/380 10.6	[DC11.02]	03.96- 02.02	CA1148IR CA1744IR	28 65 28 65		03.96- 02.02	CS121 CS1169 CS1061	24 6.0 24 6.7 24 6.7
	[DC11.03]	02.96- 09.04	CA1148IR CA1744IR	28 65 28 65		02.96- 09.04	CS97 CS121 CS1169 CS1061 CS97	24 4.0 24 6.0 24 6.7 24 6.7 24 4.0
T 114 G/340 10.6	[DC11.01]	03.96- 09.04	CA1148IR CA1744IR	28 65 28 65		03.96- 09.04	CS1169 CS1061 CS121	24 6.7 24 6.7 24 6.0
	[DC11.03]	02.96- 09.04	CA1148IR CA1744IR	28 65 28 65		02.96- 09.04	CS97 CS121 CS1169 CS1061 CS97	24 4.0 24 6.0 24 6.7 24 6.7 24 4.0
T 114 G/340 11.0	[DSC11.79]	05.96- 05.99	CA1148IR CA1310IR CA1744IR CA1842IR	28 65 28 90 28 65 28 100		05.96- 05.99	CS121 CS1199 CS97	24 6.0 24 6.7 24 4.0





T 114 G/380 10.6	[DC11.02]	03.96- 02.02	CA1744IR	28 65	03.96- 02.02	CS121	24 6.0
		02.02	CA1148IR	28 65	03.96- 02.02	CS1061	24 6.7
T 114 L/340 10.6	[DC11.01]	03.96- 02.02	CA1744IR	28 65	03.96- 02.02	CS97	24 4.0
		02.02	CA1148IR	28 65	03.96- 02.02	CS121	24 6.0
	[DC11.03]	03.96- 09.04	CA1148IR	28 65	03.96- 02.02	CS1061	24 6.7
		03.98- 09.04	CA1744IR	28 65	03.96- 02.02	CS1169	24 6.7
T 114 L/340 11.0	[DSC11.79]	05.96- 05.99	CA1148IR	28 65	03.98- 09.04	CS121	24 6.0
		05.96- 05.99	CA1310IR	28 90	03.98- 09.04	CS97	24 4.0
T 114 L/380 10.6	[DC11.02]	05.96- 05.99	CA1744IR	28 65	03.98- 09.04	CS1061	24 6.7
		05.96- 05.99	CA1842IR	28 100	03.98- 09.04	CS1169	24 6.7
	[DC11.04]	03.96- 02.02	CA1148IR	28 65	03.98- 09.04	CS121	24 6.0
		03.96- 02.02	CA1744IR	28 65	03.98- 09.04	CS1061	24 6.7
T 124 C/360 11.7	[DSC12.02]	02.96- 09.04	CA1148IR	28 65	03.98- 09.04	CS1169	24 6.7
		09.95- 02.02	CA1148IR	28 65	03.98- 09.04	CS121	24 6.0
T 124 C/400 11.7	[DSC12.01]	09.95- 02.02	CA1744IR	28 65	09.95- 02.02	CS1061	24 4.0
		03.95- 01.00	CA1148IR	28 65	09.95- 02.02	CS97	24 4.0
T 124 C/420 11.7	[DC12.01]	03.95- 01.00	CA1744IR	28 65	03.95- 01.00	CS121	24 6.0
		03.95- 01.00	CA1148IR	28 65	03.95- 01.00	CS97	24 4.0
	[DSC12.05]	03.95- 01.00	CA1148IR	28 65	03.95- 01.00	CS1061	24 6.7
		09.95- 08.02	CA1148IR	28 65	09.95- 08.02	CS97	24 4.0
T 124 G/360 11.7	[DSC12.02]	09.95- 08.02	CA1744IR	28 65	09.95- 08.02	CS121	24 6.0
		09.95- 08.02	CA1148IR	28 65	09.95- 08.02	CS1061	24 6.7
	[DSC12.05]	03.97- 02.02	CA1148IR	28 65	09.95- 08.02	CS97	24 4.0
		03.97- 02.02	CA1310IR	28 90	09.95- 08.02	CS121	24 6.0
T 124 G/400 11.7	[DSC12.01]	03.97- 02.02	CA1744IR	28 65	03.97- 02.02	CS97	24 4.0
		03.97- 02.02	CA1842IR	28 100	03.97- 02.02	CS1061	24 6.7
	[DSC12.05]	03.97- 01.00	CA1148IR	28 65	03.97- 01.00	CS121	24 6.0
		03.97- 01.00	CA1310IR	28 90	03.97- 01.00	CS97	24 4.0
T 124 G/420 11.7	[DC12.01]	03.97- 01.00	CA1744IR	28 65	03.97- 01.00	CS1061	24 6.7
		03.97- 01.00	CA1842IR	28 100	03.97- 01.00	CS121	24 6.0
	[DSC12.05]	09.95- 08.02	CA1148IR	28 65	09.95- 08.02	CS97	24 4.0
		09.95- 08.02	CA1744IR	28 65	09.95- 08.02	CS121	24 6.0
T 124 L/360 11.7	[DSC12.02]	09.95- 08.02	CA1842IR	28 100	09.95- 08.02	CS1061	24 6.7
		09.95- 08.02	CA1148IR	28 65	09.95- 08.02	CS97	24 4.0
	[DSC12.05]	02.97- 02.02	CA1148IR	28 65	09.95- 08.02	CS121	24 6.0
		02.97- 02.02	CA1310IR	28 90	09.95- 08.02	CS1061	24 6.7
T 124 L/400 11.7	[DSC12.01]	05.96- 01.02	CA1744IR	28 65	05.95- 02.02	CS97	24 4.0
		05.96- 01.02	CA1148IR	28 65	05.95- 02.02	CS121	24 6.0
	[DSC12.05]	02.97- 01.00	CA1310IR	28 90	05.95- 02.02	CS1061	24 6.7
		02.97- 01.00	CA1842IR	28 100	05.95- 02.02	CS97	24 4.0
T 124 L/420 11.7	[DC12.01]	01.90- 12.96	CA1148IR	28 65	01.90- 12.96	CS1284	24 6.6
		01.90- 12.96	CA1310IR	28 90	01.90- 12.96	CS97	24 4.0
	[DSC12.05]	01.90- 12.96	CA1744IR	28 65	01.90- 12.96	CS881	24 6.6
		01.90- 12.96	CA1842IR	28 100	01.90- 12.96	CS121	24 6.0
T 124 L/470 11.7	[DT12.02]	09.95- 08.02	CA1148IR	28 65	09.95- 08.02	CS1284	24 6.6
		09.95- 08.02	CA1310IR	28 90	09.95- 08.02	CS97	24 4.0
	[DSC14.10]	09.95- 02.02	CA1744IR	28 65	09.95- 08.02	CS881	24 6.6
		09.95- 02.02	CA1842IR	28 100	09.95- 08.02	CS121	24 6.0
T 142 E 14.2	[DS14.06]	05.80- 03.88	CA1744IR	28 65	09.95- 02.02	CS1061	24 6.7
		05.80- 03.88	CA227IR	28 55	09.95- 02.02	CS121	24 6.0
T 143 E/450 14.2	[DSC14.03]	05.80- 03.88	CA130IR	28 35	09.95- 02.02	CS1284	24 6.6
		05.80- 03.88	CA227IR	28 55	05.80- 03.88	CS1284	24 6.6
	[DSC14.10]	01.90- 12.96	CA1438IR	28 80 BO	01.90- 12.96	CS97	24 4.0
		01.90- 12.96	CA550IR	28 55 BO	01.90- 12.96	CS881	24 6.6
T 143 E/500 14.2	[DSC14.09]	01.90- 12.96	CA558IR	28 73 PR	01.90- 12.96	CS1284	24 6.6
		01.90- 12.96	CA748IR	28 55 PR	01.90- 12.96	CS121	24 6.0
	[DSC14.16]	01.94- 12.96	CA1148IR	28 65	01.90- 12.96	CS121	24 6.0
		01.94- 12.96	CA1438IR	28 80 BO	01.91- 12.96	CS1284	24 6.6
T 143 H/420 14.2	[DSC14.08]	01.91- 12.96	CA550IR	28 55 BO	01.91- 12.96	CS97	24 4.0
		01.91- 12.96	CA558IR	28 73 PR	01.91- 12.96	CS881	24 6.6
	[DSC14.16]	01.91- 12.96	CA748IR	28 55 PR	01.91- 12.96	CS121	24 6.0
		01.94- 12.96	CA1148IR	28 65	01.91- 12.96	CS1284	24 6.6
T 143 H/450 14.2	[DSC14.03]	12.94- 12.96	CA1438IR	28 80 BO	12.94- 12.96	CS881	24 6.6
		12.94- 12.96	CA1438IR	28 80 BO	12.94- 12.96	CS121	24 6.0
	[DSC14.10]	12.94- 12.96	CA550IR	28 55 BO	12.94- 12.96	CS97	24 4.0
		12.94- 12.96	CA558IR	28 73 PR	12.94- 12.96	CS881	24 6.6
T 143 H/500 14.2	[DSC14.09]	12.94- 12.96	CA748IR	28 55 PR	12.94- 12.96	CS97	24 4.0
		12.94- 12.96	CA1148IR	28 65	12.94- 12.96	CS121	24 6.0
	[DSC14.16]	01.91- 12.96	CA1438IR	28 80 BO	01.91- 12.96	CS1284	24 6.6
		01.91- 12.96	CA550IR	28 55 BO	01.91- 12.96	CS97	24 4.0



**SCANIA Continued**

T 144 C/460 14.2	[DSC14.15]	12.94- 12.96 CA748IR 28 55 PR 02.97- 08.01 CA1148IR 28 65 02.97- 08.01 CA1744IR 28 65	02.97- 08.01 CS121 24 6.0 02.97- 08.01 CS1169 24 6.7 02.97- 08.01 CS97 24 4.0
T 144 G/530 14.2	[DSC14.13]	02.97- 08.01 CA1148IR 28 65 02.97- 08.01 CA1744IR 28 65	02.97- 08.01 CS97 24 4.0 02.97- 08.01 CS121 24 6.0 02.97- 08.01 CS1169 24 6.7
T 144 G/460 14.2	[DSC14.15]	03.97- 08.01 CA1148IR 28 65 03.97- 08.01 CA1310IR 28 90 03.97- 08.01 CA1744IR 28 65 03.97- 08.01 CA1842IR 28 100	03.97- 08.01 CS97 24 4.0 03.97- 08.01 CS121 24 6.0 03.97- 08.01 CS1169 24 6.7
T 144 G/530 14.2	[DSC14.13]	03.97- 08.01 CA1148IR 28 65 03.97- 08.01 CA1310IR 28 90 03.97- 08.01 CA1744IR 28 65 03.97- 08.01 CA1842IR 28 100	03.97- 08.01 CS1169 24 6.7 03.97- 08.01 CS97 24 4.0 03.97- 08.01 CS121 24 6.0
T 144 L/460 14.2	[DSC14.15]	02.97- 08.01 CA1148IR 28 65 02.97- 08.01 CA1744IR 28 65 03.97- 08.01 CA1310IR 28 90 03.97- 08.01 CA1842IR 28 100	02.97- 08.01 CS121 24 6.0 02.97- 08.01 CS1169 24 6.7 02.97- 08.01 CS97 24 4.0
T 144 I/530 14.2	[DSC14.13]	02.97- 08.01 CA1148IR 28 65 02.97- 08.01 CA1744IR 28 65 03.97- 08.01 CA1310IR 28 90 03.97- 08.01 CA1842IR 28 100	02.97- 08.01 CS97 24 4.0 02.97- 08.01 CS1169 24 6.7 02.97- 08.01 CS121 24 6.0
T 93 H/250 8.5	[DS9.05]	03.88- 01.91 CA550IR 28 55 BO 03.88- 01.91 CA558IR 28 73 PR 03.88- 01.91 CA748IR 28 55 PR 01.90- 01.91 CA1438IR 28 80 BO	03.88- 01.91 CS121 24 6.0 03.88- 01.91 CS881 24 6.6 03.88- 01.91 CS97 24 4.0
	[DSC9.07]	12.91- 08.97 CA1438IR 28 80 BO 12.91- 08.97 CA550IR 28 55 BO 12.91- 08.97 CA558IR 28 73 PR 12.91- 08.97 CA748IR 28 55 PR 01.94- 08.97 CA1148IR 28 65	12.91- 08.97 CS121 24 6.0 12.91- 08.97 CS881 24 6.6 12.91- 08.97 CS97 24 4.0
T 93 H/280 8.5	[DSC9.02]	12.91- 12.96 CA1438IR 28 80 BO 12.91- 12.96 CA550IR 28 55 BO 12.91- 12.96 CA558IR 28 73 PR 12.91- 12.96 CA748IR 28 55 PR 01.94- 12.96 CA1148IR 28 65	12.91- 12.96 CS121 24 6.0 12.91- 12.96 CS881 24 6.6 12.91- 12.96 CS97 24 4.0
	[DSC9.08]	12.91- 08.97 CA1438IR 28 80 BO 12.91- 08.97 CA550IR 28 55 BO 12.91- 08.97 CA558IR 28 73 PR 12.91- 08.97 CA748IR 28 55 PR 01.94- 08.97 CA1148IR 28 65	12.91- 08.97 CS881 24 6.6 12.91- 08.97 CS97 24 4.0 12.91- 08.97 CS121 24 6.0
T 94 C/260 9.0	[DSC9.12]	08.96- 10.01 CA1148IR 28 65	08.96- 10.01 CS121 24 6.0 08.96- 10.01 CS1169 24 6.7 08.96- 10.01 CS97 24 4.0
T 94 C/310 9.0	[DSC9.13]	08.96- 08.02 CA1148IR 28 65	08.96- 08.02 CS121 24 6.0 08.96- 08.02 CS1169 24 6.7 08.96- 08.02 CS97 24 4.0
T 94 G/220 9.0	[DSC9.11]	08.96- 08.02 CA1148IR 28 65	08.96- 08.02 CS1169 24 6.7 08.96- 08.02 CS121 24 6.0 08.96- 08.02 CS97 24 4.0
T 94 G/230 9.0	[DC9.01]	04.99- 09.04 CA1148IR 28 65	04.99- 09.04 CS1169 24 6.7 04.99- 09.04 CS121 24 6.0 04.99- 09.04 CS97 24 4.0
T 94 G/260 9.0	[DSC9.12]	08.96- 10.01 CA1148IR 28 65	08.96- 10.01 CS121 24 6.0 08.96- 10.01 CS1169 24 6.7 08.96- 10.01 CS97 24 4.0
T 94 G/310 9.0	[DSC9.13]	08.96- 08.02 CA1148IR 28 65	08.96- 08.02 CS121 24 6.0 08.96- 08.02 CS1169 24 6.7 08.96- 08.02 CS97 24 4.0
	[DSC9.15]	08.96- 08.02 CA1148IR 28 65	08.96- 08.02 CS121 24 6.0 08.96- 08.02 CS1169 24 6.7 08.96- 08.02 CS97 24 4.0
T 94 L/310 9.0	[DSC9.13]	09.96- 08.02 CA1148IR 28 65	09.96- 08.02 CS1169 24 6.7 09.96- 08.02 CS121 24 6.0 09.96- 08.02 CS97 24 4.0
	[DSC9.15]	09.96- 08.02 CA1148IR 28 65	09.96- 08.02 CS1169 24 6.7 09.96- 08.02 CS121 24 6.0 09.96- 08.02 CS97 24 4.0
<b>Seat</b>			
<b>PASSENGER CARS EU</b>			
124 1.2			01.68- 12.76 CS141 12 0.8
124 1.2 LS	[FA]		01.68- 10.80 CS141 12 0.8 01.70- 12.76 CS141 12 0.8
124 1.4			01.70- 12.76 CS141 12 0.8
127 0.9			04.72- 12.82 CS90 12 0.8
132 1.6		AC 03.73- 02.75 CA129IR 14 55	
132 1.8		01.75- 05.79 CA119IR 14 45	
		AC 03.73- 05.79 CA129IR 14 55	
132 2.2 Diesel	[OM615.912]		05.79- 12.82 CS555 12 2.2
Alhambra 1.8 Turbo 20V	[AJH]	Chas. -X 055000 10.97- 03.99 CA1144IR 14 120 Chas. -X 025001 09.98- 02.00 CA1394IR 14 120 Chas. -X 025001 09.98- 02.00 CA1446IR 14 90 Chas. -X 025000 10.97- 09.98 CA1570IR 14 90	AT, Chas. X005001-06.98- CS1062 12 1.1 AT, Chas. -X005000 10.97- 05.98 CS618 12 1.1 Chas. -X005000 10.97- 05.98 CS619 12 1.1 Chas. X005001-06.98- CS1119 12 1.1
	[AWC]	06.00- CA1394IR 14 120	06.00- CS1337 12 1.1
Alhambra 1.9 TDi	[1Z]	03.96- 07.96 CA1089IR 14 120 03.96- 07.96 CA736IR 14 90	03.96- 07.96 CS974 12 1.8
	[AFN]	05.97- 02.99 CA1260IR 14 120 05.97- 02.99 CA1297IR 14 90 03.99- 02.00 CA1394IR 14 120 03.99- 02.00 CA1446IR 14 90	05.97- 02.00 CS789 12 1.8 05.97- 01.98 CS974 12 1.8 AT 05.97- 02.00 CS1287 12 2.0
	[AHU]	07.96- 02.00 CA1089IR 14 120 07.96- 02.00 CA736IR 14 90	07.96- 02.00 CS974 12 1.8
	[ANU]	06.00- CA1394IR 14 120 06.00- CA1446IR 14 90	06.00- CS1181 12 2.0
	[ARL]	05.05- CA1394IR 14 120 05.05- CA1763IR 14 150 05.05- CA1782IR 14 140	05.05- CS1181 12 2.0
	[ASZ]	11.02- CA1394IR 14 120 11.02- CA1446IR 14 90	11.02- CS1181 12 2.0
	[AUY]	06.00- CA1394IR 14 120 06.00- CA1446IR 14 90	6SP 06.00- CS1181 12 2.0 AT 06.00- CS1390 12 2.3
	[BTB]	05.05- CA1394IR 14 120 05.05- CA1763IR 14 150 05.05- CA1782IR 14 140	05.05- CS1181 12 2.0
	[BVK]	11.05- CA1394IR 14 120 11.05- CA1446IR 14 90 11.05- CA1782IR 14 140	6SP 11.05- CS1181 12 2.0 AT 11.05- CS1390 12 2.3
Alhambra 1.9 TDi 4 Motion	[AUY]	02.01- CA1394IR 14 120	02.01- CS1181 12 2.0



Alhambra 2.0 i	[ADY]	02.01-	CA1446IR	14 90				
		04.96- 02.00	CA740IR	14 90	AT 04.96- 02.00	CS618	12 1.1	
		04.96- 02.00	CA828IR	14 120	04.96- 02.00	CS619	12 1.1	
		AC 04.96- 02.00	CA736IR	14 90				
	[ATM]	06.00-	CA1394IR	14 120	06.00-	CS1337	12 1.1	
					AT 06.00-	CS1062	12 1.1	
Alhambra 2.0 TSi	[CCZA]	11.10-	CA1811IR	14 140				
Alhambra 2.0 TDi	[BRT]	11.05-	CA1394IR	14 120	11.05-	CS1181	12 2.0	
		11.05-	CA1782IR	14 140				
		[CFFA]	06.10- 05.11	CA2011IR	14 140	A25 06.10- 05.11	CS1508*	12 1.7
		[CFFB]	06.10-	CA2011IR	14 140	06.10-	CS1508*	12 1.7
		[CFFE]	05.11-	CA2011IR	14 140	05.11-	CS1508*	12 1.7
		[CFGB]	06.10-	CA2011IR	14 140	06.10-	CS1508*	12 1.7
Alhambra 2.0 TDi 4x4	[CFFB]	05.11-	CA2011IR	14 140	05.11-	CS1508*	12 1.7	
Alhambra 2.8 V6	[AYL]	06.00- 07.00	CA1143IR	14 150	06.00-	CS1181	12 2.0	
		06.00-	CA1394IR	14 120				
		07.00-	CA1763IR	14 150				
Alhambra 2.8 V6 4 Motion	[AYL]	06.00-	CA1394IR	14 120	06.00-	CS1181	12 2.0	
		06.00-	CA1763IR	14 150				
Altea 1.2 TSi	[CBZB]				04.10-	CS1322	12 1.1	
					04.10-	CS1347	12 1.1	
Altea 1.4	[BXW]	10.06-	CA1560IR	14 90	10.06-	CS1330	12 1.0	
		10.06-	CA1815IR#	14 110				
		AC 10.06-	CA1729IR	14 110				
Altea 1.4 16V	[BXW]	05.06-	CA1560IR	14 90	05.06-	CS1330	12 1.0	
		05.06-	CA1815IR#	14 110				
		AC 05.06-	CA1729IR	14 110				
Altea 1.4 TSi	[CAXA]	11.07-	CA1985IR	14 140	11.07-	CS1294	12 1.1	
		AC 11.07-	CA2056IR*	14 110				
		[CAXC]	11.07-	CA1985IR	14 140	11.07-	CS1294	12 1.1
		AC 11.07-	CA2056IR*	14 110				
Altea 1.6	[BGU]	03.04-	CA1782IR	14 140	5SP 03.04-	CS1324	12 1.0	
		03.04-	CA1818IR	14 110				
		[BSE]	03.04-	CA1782IR	14 140	5SP 03.04-	CS1324	12 1.0
		03.04-	CA1818IR	14 110				
	[BSF]	03.04-	CA1782IR	14 140	5SP 03.04-	CS1324	12 1.0	
		03.04-	CA1818IR	14 110				
Altea 1.6 LPG	[CHGA]	09.09-	CA1782IR	14 140	09.09-	CS1324	12 1.0	
		09.09-	CA1818IR	14 110	AT 09.09-	CS1470	12 1.1	
Altea 1.6 Multifuel	[BSE]	10.06-	CA1782IR	14 140	10.06-	CS1324	12 1.0	
		10.06-	CA1818IR	14 110	AT 10.06-	CS1347	12 1.1	
		[BSF]	10.06-	CA1782IR	14 140	10.06-	CS1324	12 1.0
		10.06-	CA1818IR	14 110	AT 10.06-	CS1347	12 1.1	
Altea 1.6 TDi	[CAYB]	11.10-	CA1782IR	14 140				
		A25 11.10-	CA2011IR	14 140				
		[CAYC]	10.09-	CA1782IR	14 140	A25 10.09-	CS1505*	12 2.0
		A25 10.09-	CA2011IR	14 140	10.09-	CS1480*	12 1.8	
Altea 1.8 TFSi	[BYT]	01.07-	CA1811IR	14 140	01.07-	CS1294	12 1.1	
Altea 1.9 TDi	[BJS]	04.04- 09.05	CA1782IR	14 140	04.04- 09.05	CS1293	12 2.0	
		04.04- 09.05	CA1810IR	14 110				
		[BKC]	04.04- 05.06	CA1782IR	14 140	04.04- 05.06	CS1293	12 2.0
		04.04- 05.06	CA1810IR	14 110				
		[BLS]	04.04- 10.05	CA1782IR	14 140	04.04- 10.05	CS1293	12 2.0
		04.04-	CA1810IR	14 110	AT, 7SP 04.04-	CS1480*	12 1.8	
		[BXE]	04.04- 02.06	CA1782IR	14 140	04.04- 02.06	CS1293	12 2.0
		04.04- 02.06	CA1810IR	14 110				
[BXF]	08.09-	CA1782IR	14 140	08.09-	CS1293	12 2.0		
		08.09-	CA1810IR	14 110				
Altea 2.0 FSi	[BLR]	05.04- 11.05	CA1782IR	14 140	6SP 05.04- 11.05	CS1294	12 1.1	
		05.04- 11.05	CA1818IR	14 110	AT, 6SP 05.04- 11.05	CS1347	12 1.1	
		[BLY]	05.04- 11.05	CA1782IR	14 140	6SP 05.04- 11.05	CS1294	12 1.1
		05.04- 11.05	CA1818IR	14 110	AT, 6SP 05.04- 11.05	CS1347	12 1.1	
		[BVY]	05.04- 11.05	CA1782IR	14 140	6SP 05.04- 11.05	CS1294	12 1.1
		05.04- 11.05	CA1818IR	14 110	AT, 6SP 05.04- 11.05	CS1347	12 1.1	
[BVZ]	05.04- 11.05	CA1782IR	14 140	6SP 05.04- 11.05	CS1294	12 1.1		
		05.04- 11.05	CA1818IR	14 110	AT, 6SP 05.04- 11.05	CS1347	12 1.1	
Altea 2.0 TFSi	[BWA]	04.06-	CA1782IR	14 140	AT 04.06-	CS1409	12 1.0	
		04.06-	CA1818IR	14 110	04.06-	CS1347	12 1.1	
Altea 2.0 TDi 16V	[AZV]	11.06-	CA1782IR	14 140	11.06-	CS1323	12 2.0	
		11.06-	CA1810IR	14 110	AT 11.06-	CS1286	12 2.0	
Altea 2.0 TDi	[AZV]	04.04-	CA1782IR	14 140	AT 04.04-	CS1286	12 2.0	
		04.04-	CA1810IR	14 110	04.04-	CS1323	12 2.0	
		[BKD]	03.04-	CA1782IR	14 140	AT, 6SP 03.04-	CS1286	12 2.0
					6SP 03.04-	CS1323	12 2.0	
		[BMM]	11.05-	CA1782IR	14 140	AT 11.05-	CS1286	12 2.0
		11.05-	CA1810IR	14 110	11.05-	CS1323	12 2.0	
[BMN]	03.06-	CA1782IR	14 140	03.06-	CS1323	12 2.0		
		03.06-	CA1810IR	14 110				
Altea 2.0 TDi 4x4	[BMM]	06.07-	CA1782IR	14 140	AT 06.07-	CS1286	12 2.0	
		06.07-	CA1810IR	14 110	06.07-	CS1323	12 2.0	
Altea XL 1.2 TSi	[CBZB]				04.10-	CS1322	12 1.1	
					04.10-	CS1347	12 1.1	
Altea XL 1.6	[BSE]	10.06-	CA1378IR	14 90	10.06-	CS1324	12 1.0	
		10.06-	CA1782IR	14 140	AT 10.06-	CS1347	12 1.1	
		10.06-	CA1818IR	14 110				
		[BSF]	10.06-	CA1378IR	14 90	AT 10.06-	CS1347	12 1.1
		10.06-	CA1782IR	14 140	10.06-	CS1324	12 1.0	
		10.06-	CA1818IR	14 110				
Altea XL 1.6 LPG	[CHGA]	09.09-	CA1782IR	14 140	09.09-	CS1324	12 1.0	
		09.09-	CA1818IR	14 110	09.09-	CS1470	12 1.1	
Altea XL 1.6 TDi	[CAYB]	11.10-	CA1782IR	14 140				
		A25 11.10-	CA2011IR	14 140				
Altea XL 1.8 TFSi	[BYT]	01.07-	CA1811IR	14 140	01.07-	CS1294	12 1.1	
Altea XL 1.9 TDi	[BLS]	10.06-	CA1782IR	14 140	AT 10.06-	CS1286	12 2.0	
		10.06-	CA1810IR	14 110	10.06-	CS1293	12 2.0	
					AT, 7SP 10.06-	CS1480*	12 1.8	
		[BXE]	10.06-	CA1782IR	14 140	AT 10.06-	CS1286	12 2.0
		10.06-	CA1810IR	14 110	10.06-	CS1293	12 2.0	
		[BXF]	08.09-	CA1782IR	14 140			
		08.09-	CA1810IR	14 110				
Altea XL 2.0 FSi	[BVY]	10.06-	CA1782IR	14 140	10.06-	CS1294	12 1.1	
		10.06-	CA1818IR	14 110	AT 10.06-	CS1347	12 1.1	



SEAT Continued

	[BVZ]	10.06- 10.06-	CA1782IR CA1818IR	14 140 14 110		10.06- AT 10.06-	CS1294 CS1347	12 1.1 12 1.1
Altea XL 2.0 TFSi 4WD	[BWA]	06.07- 06.07-	CA1782IR CA1818IR	14 140 14 110		AT 06.07- 06.07-	CS1409 CS1347	12 1.0 12 1.1
Altea XL 2.0 TFSi 4x4	[CCZB]	05.09-	CA1811IR	14 140				
Altea XL 2.0 TDi 16V	[BKD]	10.06- 10.06-	CA1782IR CA1810IR	14 140 14 110		AT 10.06- 10.06-	CS1286 CS1323	12 2.0 12 2.0
Altea XL 2.0 TDi	[BMM]	10.06- 10.06-	CA1782IR CA1810IR	14 140 14 110		10.06- AT 10.06-	CS1323 CS1286	12 2.0 12 2.0
	[BMN]	06.07- 06.07-	CA1782IR CA1810IR	14 140 14 110		06.07-	CS1323	12 2.0
Altea XL 2.0 TDi 4WD	[BMN]	06.07- 06.07-	CA1782IR CA1810IR	14 140 14 110		06.07-	CS1323	12 2.0
Arosa 1.0	[AER]	05.97- 09.99 05.97- 09.99 05.97- 09.99 05.97- 09.99 PS 05.97- 09.99 PS 05.97- 09.99 ACPS 05.97- 09.99	CA1560IR CA1568IR CA733IR CA740IR CA736IR CA827IR CA1542IR	14 90 14 70 14 70 14 90 14 90 14 70 14 90		02.97- 09.99	CS788	12 0.9
	[AHT]	01.98- 12.03 10.98- 02.00 ACPS 01.98- 12.03 ACPS 01.98- 12.03 AC 10.98- 02.00	CA1586IR CA1542IR CA1504IR CA1542IR CA1504IR	14 70 14 90 14 70 14 90 14 70		10.98- 02.00 01.98- 12.03	CS788 CS1211	12 0.9 12 0.9
	[ALD]	01.99- 07.00 01.99- 07.00 PS 01.99- 07.00 AC 01.99- 07.00	CA1560IR CA1568IR CA1504IR CA1542IR	14 90 14 70 14 70 14 90		01.99- 07.00	CS788	12 0.9
	[ALL]	10.97- 05.99 10.97- 05.99 10.97- 05.99 10.97- 05.99 10.97- 05.99 PS 10.97- 05.99 PS 10.97- 05.99	CA1542IR CA1560IR CA1568IR CA733IR CA740IR CA736IR CA827IR	14 90 14 90 14 70 14 70 14 90 14 90 14 70		10.97- 05.99	CS788	12 0.9
	[ANV]	01.99- 07.00 01.99- 07.00 PS 01.99- 07.00 AC 01.99- 07.00	CA1560IR CA1568IR CA1504IR CA1542IR	14 90 14 70 14 70 14 90		01.99- 07.00	CS788	12 0.9
	[AUC]	05.00- 06.04 05.00- 06.04 PS 05.00- 06.04 AC 05.00- 06.04	CA1560IR CA1568IR CA1504IR CA1542IR	14 90 14 70 14 70 14 90		05.00- 06.04	CS788	12 0.9
Arosa 1.4	[AEX]	02.97- 11.97 02.97- 11.97 PS 02.97- 11.97 PS 02.97- 11.97	CA733IR CA740IR CA736IR CA827IR	14 70 14 90 14 90 14 70		02.97- 11.97 02.97- 11.97 02.97- 11.97	CS880 CS788 CS1063	12 1.1 12 0.9 12 1.1
	[AKK]	01.99- 10.00 01.99- 10.00 PS 01.99- 10.00	CA1542IR CA1568IR CA1504IR	14 90 14 70 14 70		01.99- 10.00 01.99- 10.00	CS880 CS788 CS1063	12 1.1 12 0.9 12 1.1
	[AKV]	05.97- 09.99 05.97- 09.99 PS 05.97- 09.99 PS 05.97- 09.99	CA733IR CA740IR CA736IR CA827IR	14 70 14 90 14 90 14 70		05.97- 09.99 05.97- 09.99 05.97- 09.99	CS880 CS1063 CS788	12 1.1 12 1.1 12 0.9
	[ANW]	01.99- 10.00 01.99- 10.00 PS 01.99- 10.00	CA1542IR CA1568IR CA1504IR	14 90 14 70 14 70		01.99- 10.00 01.99- 10.00	CS1063 CS880 CS788	12 1.1 12 1.1 12 0.9
	[APQ]	12.97- 08.98 12.97- 08.98 PS 12.97- 08.98 PS 12.97- 08.98	CA733IR CA740IR CA736IR CA827IR	14 70 14 90 14 90 14 70		12.97- 08.98 12.97- 08.98 12.97- 08.98	CS1063 CS880 CS788	12 1.1 12 1.1 12 0.9
	[AUD]	09.00- 06.04 09.00- 06.04 PS 09.00- 06.04	CA1542IR CA1568IR CA1504IR	14 90 14 70 14 70		09.00- 06.04 09.00- 06.04	CS880 CS788 CS1063	12 1.1 12 0.9 12 1.1
Arosa 1.4 16V	[AFK]	01.99- 09.00 01.99- 09.00	CA1504IR CA1542IR	14 70 14 90		01.99- 09.00	CS880	12 1.1
	[ANW]	01.99- 10.00	CA1504IR	14 70		01.99- 10.00	CS880	12 1.1
	[AQQ]	05.99- 09.00	CA1504IR CA1542IR	14 70 14 90		05.99- 09.00	CS880	12 1.1
	[AUB]	09.00- 06.04 09.00- 06.04	CA1504IR CA1542IR	14 70 14 90		09.00- 06.04	CS880	12 1.1
Arosa 1.4 TDi	[AMF]	01.98- 06.04 01.98- 06.04 01.98- 06.04	CA1441IR CA1644IR CA1682IR	14 90 14 120 14 70		01.98- 06.04	CS974	12 1.8
Arosa 1.7 SDi	[AKU]	08.97- 10.03 08.97- 10.03	CA1239IR CA1255IR	14 90 14 70		08.97- 10.03	CS988	12 1.8
Cordoba 1.0	[ALD]	06.99- 10.02 06.99- 10.02 PS 06.99- 10.02 PS 06.99- 10.02	CA1560IR CA1568IR CA1504IR CA1542IR	14 90 14 70 14 70 14 90		06.99- 10.02 06.99- 10.02	CS788 CS880	12 0.9 12 1.1
	[ANV]	06.99- 10.02 06.99- 10.02 PS 06.99- 10.02 PS 06.99- 10.02	CA1560IR CA1568IR CA1504IR CA1542IR	14 90 14 70 14 70 14 90		06.99- 10.02 06.99- 10.02	CS788 CS880	12 0.9 12 1.1
	[AUC]	06.99- 10.02 06.99- 10.02 PS 06.99- 10.02 PS 06.99- 10.02	CA1560IR CA1568IR CA1504IR CA1542IR	14 90 14 70 14 70 14 90		06.99- 10.02 06.99- 10.02	CS788 CS880	12 0.9 12 1.1
Cordoba 1.0 16V	[AST]	05.00- 10.02 05.00- 10.02 PS 05.00- 10.02	CA1560IR CA1568IR CA1504IR	14 90 14 70 14 70		05.00- 10.02 05.00- 10.02	CS788 CS880	12 0.9 12 1.1
	[AVZ]	05.00- 10.02 05.00- 10.02 PS 05.00- 10.02	CA1560IR CA1568IR CA1504IR	14 90 14 70 14 70		05.00- 10.02 05.00- 10.02	CS788 CS880	12 0.9 12 1.1
Cordoba 1.0 i	[AER]	09.96- 06.99 PS 09.96- 06.99 PS 09.96- 06.99	CA733IR CA736IR CA827IR	14 70 14 90 14 70		09.96- 06.99	CS880	12 1.1
Cordoba 1.2	[AZQ]	10.02- 10.02-	CA1675IR CA1755IR	14 90 14 70		10.02-	CS1282	12 0.9
	[BME]	10.02- 10.02-	CA1675IR CA1755IR	14 90 14 70		10.02-	CS1282	12 0.9
Cordoba 1.2 12V	[BXV]	05.06- 05.06-	CA1675IR CA1755IR	14 90 14 70		05.06-	CS1330	12 1.0



Cordoba 1.4	[AKK]	06.99- 12.02	CA1504IR	14 70	05.99- 12.02	CS880	12 1.1
		06.99- 12.02	CA1542IR	14 90	05.99- 12.02	CS788	12 0.9
	[ANW]	05.99- 08.00	CA1504IR	14 70	05.99- 08.00	CS788	12 0.9
		05.99- 08.00	CA1542IR	14 90	05.99- 08.00	CS880	12 1.1
Cordoba 1.4 16V	[AUD]	06.99- 12.02	CA1504IR	14 70	05.99- 12.02	CS788	12 0.9
		06.99- 12.02	CA1542IR	14 90	05.99- 12.02	CS880	12 1.1
	[APE]	06.99- 06.00	CA1504IR	14 70	06.99- 06.00	CS880	12 1.1
		06.99- 06.00	CA1542IR	14 90	09.99- 06.00	CS788	12 0.9
Cordoba 1.4 i 16V	[AQQ]	02.00- 10.02	CA1504IR	14 70	02.00- 10.02	CS788	12 0.9
					02.00- 10.02	CS880	12 1.1
	[AUA]	09.99- 06.00	CA1504IR	14 70	09.99- 06.00	CS788	12 0.9
		09.99- 06.00	CA1542IR	14 90	09.99- 06.00	CS880	12 1.1
	[AUB]	02.00- 10.02	CA1504IR	14 70	02.00- 10.02	CS880	12 1.1
					02.00- 10.02	CS788	12 0.9
	[BBY]	10.02- 10.02	CA1560IR	14 90	AT 10.02- 10.02	CS1063	12 1.1
			CA1568IR	14 70		CS1282	12 0.9
		AC 10.02- 10.02	CA1542IR	14 90			
			CA1729IR	14 110			
	[BBZ]	10.02- 10.02	CA1542IR	14 90	10.02-	CS1282	12 0.9
			CA1568IR	14 70			
	AC 10.02- 10.02	CA1542IR	14 90				
		CA1560IR	14 90				
[BXW]	05.06- 05.06	CA1560IR	14 90	05.06-	CS1330	12 1.0	
		CA1568IR	14 70				
		CA1729IR	14 110				
		CA1542IR	14 90				
Cordoba 1.4 i 16V	[AFH]	09.96- 06.99	CA827IR	14 70	09.96- 06.99	CS788	12 0.9
		AC 09.96- 06.99	CA736IR	14 90	09.96- 06.99	CS880	12 1.1
Cordoba 1.4 i	[ABD]	09.93- 12.95	CA733IR	14 70	09.93- 12.95	CS880	12 1.1
		PS 09.93- 12.95	CA827IR	14 70	09.93- 12.95	CS788	12 0.9
[AEX]	12.95- 12.97	CA733IR	14 70	12.95- 12.97	CS788	12 0.9	
		CA740IR	14 90	12.95- 12.97	CS880	12 1.1	
	PS 12.95- 12.97	CA736IR	14 90				
		CA827IR	14 70				
[AKV]	09.97- 12.02	CA733IR	14 70	12.97- 06.99	CS788	12 0.9	
		CA740IR	14 90	09.97- 12.02	CS880	12 1.1	
	PS 09.97- 12.02	CA736IR	14 90				
		CA827IR	14 70				
[ANX]	01.98- 05.98	CA733IR	14 70	01.98- 05.98	CS788	12 0.9	
		CA736IR	14 90	01.96- 05.98	CS880	12 1.1	
		CA740IR	14 90				
		CA827IR	14 70				
	PS 01.98- 05.98	CA736IR	14 90				
		CA827IR	14 70				
[APQ]	12.97- 12.02	CA733IR	14 70	12.97- 05.98	CS788	12 0.9	
		CA736IR	14 90	12.97- 05.98	CS880	12 1.1	
		CA740IR	14 90				
		CA827IR	14 70				
	PS 12.97- 05.98	CA736IR	14 90				
		CA827IR	14 70				
Cordoba 1.4 TDi	[AMF]	10.02- 10.02	CA1441IR	14 90	12.04- 10.02	CS1293	12 2.0
			CA1644IR	14 120		CS974	12 1.8
			CA1682IR	14 70			
[BMS]	06.05- 06.05	CA1441IR	14 90	06.05-	CS1293	12 2.0	
		CA1644IR	14 120				
		CA2065IR	14 110				
[BNM]	05.05- 05.05	CA1441IR	14 90	05.05-	CS1393	12 1.7	
		CA1644IR	14 120				
		CA2064IR*	14 90				
		CA2065IR	14 110				
[BNV]	06.05- 06.05	CA1441IR	14 90	06.05-	CS1293	12 2.0	
		CA2064IR*	14 90				
		CA2065IR	14 110				
Cordoba 1.6	[AEH]	05.99- 12.02	CA1378IR	14 90	05.99- 12.02	CS1062	12 1.1
		05.99- 12.02	CA1436IR	14 70			
[AKL]	06.99- 12.02	CA1378IR	14 90	06.99- 12.02	CS1062	12 1.1	
		CA1436IR	14 70				
[ALM]	09.97- 12.02	CA736IR	14 90	09.97- 12.02	CS788	12 0.9	
		CA827IR	14 70	09.97- 12.02	CS880	12 1.1	
	04.99- 12.02	CA1504IR	14 70				
		CA1542IR	14 90				
[APF]	09.99- 10.00	CA1378IR	14 90	09.99- 10.00	CS1062	12 1.1	
		CA1436IR	14 70				
[AUR]	06.99- 12.02	CA1378IR	14 90	06.99- 12.02	CS294	12 0.9	
		CA1436IR	14 70	06.99- 12.02	CS1062	12 1.1	
[BAH]	02.03- 02.03	CA1560IR	14 90	Chas. 6L-5-090179- 02.03-	CS1330	12 1.0	
		CA1568IR	14 70	Chas. -6L-5-090178 02.03-	CS1282	12 0.9	
		CA1542IR	14 90	Chas. -6L-5-090178 02.03-	CS1197	12 1.1	
Cordoba 1.6 16V	[BTS]	11.06-	CA1817IR	14 110	11.06-	CS1330	12 1.0
Cordoba 1.6 i	[1F]	05.94- 12.02	CA733IR	14 70	05.97- 12.02	CS1062	12 1.1
		05.97- 12.02	CA740IR	14 90	05.94- 12.02	CS618	12 1.1
		AC 05.94- 12.02	CA736IR	14 90			
[ABU]	09.93- 07.94	CA736IR	14 90	09.93- 07.94	CS880	12 1.1	
		CA827IR	14 70				
[AEE]	03.97- 12.98	CA827IR	14 70	03.97- 12.98	CS880	12 1.1	
		CA736IR	14 90	03.97- 12.98	CS788	12 0.9	
		CA736IR	14 90				
[AFT]	12.95- 11.02	CA733IR	14 70	07.96- 06.99	CS1062	12 1.1	
		CA740IR	14 90	07.96- 11.02	CS618	12 1.1	
		CA827IR	14 70				
	PS 12.95- 11.02	CA1240IR	14 90				
		CA736IR	14 90				
[ALM]	09.97- 03.99	CA736IR	14 90	09.97- 12.02	CS880	12 1.1	
		CA827IR	14 70	09.97- 12.02	CS788	12 0.9	
	03.99- 12.02	CA1504IR	14 70				
		CA1542IR	14 90				
	AC 09.97- 12.02	CA736IR	14 90				
Cordoba 1.7 SDi	[AKW]	07.97- 06.99	CA1394IR	14 120	07.97- 06.99	CS988	12 1.8
		07.97- 06.99	CA1446IR	14 90			
		07.97- 06.99	CA1502IR	14 70			
Cordoba 1.8 i 16V	[ADL]	10.93- 08.96	CA736IR	14 90	10.93- 08.96	CS618	12 1.1
Cordoba 1.8 i	[ABS]	09.93- 07.94	CA733IR	14 70	09.93- 07.94	CS618	12 1.1
		09.93- 07.94	CA740IR	14 90			
		AC 09.93- 07.94	CA736IR	14 90			



**SEAT** *Continued*

	[ADZ]	07.94- 12.02 CA733IR 14 70	11.95- 12.02 CS1062 12 1.1
		07.94- 12.02 CA740IR 14 90	07.94- 12.02 CS618 12 1.1
		AC 07.94- 12.02 CA736IR 14 90	
Cordoba 1.8 Turbo 20V Cupra	[AQX]	05.99- 10.00 CA1378IR 14 90	05.99- 10.00 CS1119 12 1.1
		05.99- 10.00 CA1436IR 14 70	
Cordoba 1.9 Diesel	[1Y]	02.93- 08.96 CA733IR 14 70	Chas. ZR775808- 05.95- 08.96 CS789 12 1.8
		02.93- 08.96 CA736IR 14 90	Chas. -ZR775807 02.93- 05.95 CS713 12 1.8
Cordoba 1.9 SDi	[AEY]	08.96- 12.02 CA1260IR 14 120	08.96- 12.02 CS789 12 1.8
		08.96- 12.02 CA736IR 14 90	
		08.96- 12.02 CA827IR 14 70	
		06.97- 03.99 CA1089IR 14 120	
		06.97- 05.99 CA1297IR 14 90	
		05.98- 03.99 CA1510IR 14 70	
		03.99- 06.99 CA1394IR 14 120	
		03.99- 06.99 CA1446IR 14 90	
		03.99- 06.99 CA1502IR 14 70	
		Chas. 6K.X.026680- 06.98- 12.02 CA1510IR 14 70	
		Chas. -6K.X.026679 08.96- 05.98 CA1297IR 14 90	
		AC 08.96- 12.02 CA736IR 14 90	
	[AGP]	06.99- 08.02 CA1394IR 14 120	06.99- 01.02 CS789 12 1.8
		06.99- 08.02 CA1446IR 14 90	06.99- 08.02 CS1287 12 2.0
		06.99- 08.02 CA1502IR 14 70	
	[AQM]	06.99- 09.00 CA1394IR 14 120	06.99- 09.00 CS789 12 1.8
		06.99- 09.00 CA1446IR 14 90	06.99- 09.00 CS1287 12 2.0
		06.99- 09.00 CA1502IR 14 70	
	[ASY]	09.02- CA1394IR 14 120	Chas. 6L-5-090179- 12.04- CS1393 12 1.7
		09.02- CA1446IR 14 90	Chas. -6L-5-090178 09.02- 12.04 CS1200 12 2.0
		09.02- CA1502IR 14 70	
Cordoba 1.9 TD	[AAZ]	02.93- 08.96 CA1260IR 14 120	02.93- 08.96 CS713 12 1.8
		02.93- 08.96 CA732IR 14 60	
		02.93- 08.96 CA733IR 14 70	
		02.93- 08.96 CA740IR 14 90	
		AC 02.93- 08.96 CA736IR 14 90	
Cordoba 1.9 TDi	[1Z]	08.96- 12.96 CA1089IR 14 120	08.96- 12.96 CS974 12 1.8
		08.96- 12.96 CA1260IR 14 120	
		08.96- 12.96 CA1297IR 14 90	
	[AFN]	03.97- 12.02 CA1089IR 14 120	03.97- 12.02 CS974 12 1.8
		03.97- 12.02 CA1260IR 14 120	
		02.98- 05.98 CA1297IR 14 90	
		05.98- 03.99 CA1510IR 14 70	
		Chas. 6K.X.026680- 05.98- 12.02 CA1510IR 14 70	
		Chas. -6K.X.026679 03.97- 12.02 CA1297IR 14 90	
		AC 02.98- 03.99 CA1089IR 14 120	
		AC 02.98- 03.99 CA1260IR 14 120	
		AC 03.99- 06.99 CA1394IR 14 120	
		AC 03.99- 06.99 CA1446IR 14 90	
		AC 03.99- 06.99 CA1502IR 14 70	
	[AGR]	06.99- 12.02 CA1394IR 14 120	06.99- 12.02 CS974 12 1.8
		06.99- 12.02 CA1446IR 14 90	
		06.99- 12.02 CA1502IR 14 70	
		06.99- 08.02 CA1510IR 14 70	
	[AHU]	08.96- 12.02 CA1089IR 14 120	08.96- 12.02 CS1266 12 1.8
		08.96- 12.02 CA1260IR 14 120	08.96- 12.02 CS974 12 1.8
		08.96- 05.98 CA1297IR 14 90	
		05.98- 12.02 CA1510IR 14 70	
		03.99- 06.99 CA1394IR 14 120	
		03.99- 06.99 CA1446IR 14 90	
		03.99- 06.99 CA1502IR 14 70	
	[ALH]	06.99- 05.01 CA1394IR 14 120	06.99- 05.01 CS974 12 1.8
		06.99- 05.01 CA1446IR 14 90	
		06.99- 05.01 CA1502IR 14 70	
		06.99- 05.01 CA1510IR 14 70	
	[ASK]	06.99- 10.02 CA1394IR 14 120	06.99- 10.02 CS974 12 1.8
		06.99- 10.02 CA1446IR 14 90	
		06.99- 10.02 CA1502IR 14 70	
	[ASV]	06.99- 10.02 CA1394IR 14 120	06.99- 10.02 CS974 12 1.8
		06.99- 10.02 CA1446IR 14 90	
		06.99- 10.02 CA1502IR 14 70	
	[ASZ]	02.02- CA1394IR 14 120	02.02- CS1181 12 2.0
		02.02- CA1446IR 14 90	
		02.02- CA1502IR 14 70	
	[ATD]	09.02- CA1394IR 14 120	12.04- CS1293 12 2.0
		09.02- CA1446IR 14 90	10.02- 12.04 CS974 12 1.8
		09.02- CA1502IR 14 70	
	[AXR]	09.02- CA1394IR 14 120	09.02- CS1293 12 2.0
		09.02- CA1446IR 14 90	
		09.02- CA1502IR 14 70	
	[BLT]	05.05- CA1394IR 14 120	05.05- CS1181 12 2.0
		05.05- CA1446IR 14 90	
		05.05- CA1502IR 14 70	
	[BMT]	09.02- CA1394IR 14 120	09.02- CS1293 12 2.0
		09.02- CA1446IR 14 90	
		09.02- CA1502IR 14 70	
Cordoba 2.0	[AGG]	11.95- 04.99 CA733IR 14 70	11.95- 04.99 CS618 12 1.1
		11.95- 04.99 CA740IR 14 90	11.95- 04.99 CS1062 12 1.1
		AC 11.95- 04.99 CA736IR 14 90	
	[AZL]	09.02- 04.05 CA1378IR 14 90	09.02- 10.04 CS1475 12 1.1
		09.02- 04.05 CA1436IR 14 70	10.04- 04.05 CS1324 12 1.0
	[BBX]	04.03- CA1378IR 14 90	04.03- 11.04 CS1475 12 1.1
			11.04- CS1324 12 1.0
Cordoba 2.0 i 16V	[ABF]	08.96- 12.02 CA740IR 14 90	08.96- 12.02 CS619 12 1.1
		08.96- 12.02 CA827IR 14 70	
		AC 08.96- 12.02 CA736IR 14 90	
Cordoba 2.0 i	[2E]	09.93- 04.96 CA733IR 14 70	09.93- 04.96 CS618 12 1.1
		09.93- 04.96 CA740IR 14 90	
		AC 09.93- 04.96 CA736IR 14 90	
	[AGG]	04.96- 12.02 CA733IR 14 70	04.96- 09.96 CS618 12 1.1
		04.96- 12.02 CA740IR 14 90	10.96- 12.02 CS1062 12 1.1
		AC 04.96- 12.02 CA736IR 14 90	
Exeo 1.6	[ALZ]	03.09- CA1754IR 14 120	03.09- CS1394 12 1.2
		03.09- CA1811IR 14 140	
Exeo 1.6 ST	[ALZ]	06.09- CA1754IR 14 120	06.09- CS1394 12 1.2
		06.09- CA1811IR 14 140	



Exeo 1.8	[CFMA]	03.09-	CA1754IR	14 120	03.09-	CS1394	12 1.2	
		03.09-	CA1811IR	14 140				
Exeo 1.8 ST	[CFMA]	06.09-	CA1754IR	14 120	06.09-	CS1394	12 1.2	
		06.09-	CA1811IR	14 140				
Exeo 2.0 TFSi	[BWE]	03.09-	CA1811IR	14 140	03.09-	CS1401	12 1.1	
Exeo 2.0 TFSi ST	[BWE]	06.09-	CA1811IR	14 140	06.09-	CS1401	12 1.1	
Exeo 2.0 TDi	[CAGA]	03.09-	CA1782IR	14 140	03.09-	CS1392	12 2.0	
		03.09-	CA1912IR	14 180				
	[CAGC]	08.09-	CA1782IR	14 140	08.09-	CS1392	12 2.0	
		08.09-	CA1912IR	14 180				
	[CAHA]	01.08-	CA1782IR	14 140	01.08-	CS1392	12 2.0	
		01.08-	CA1912IR	14 180				
Exeo 2.0 TDi ST	[CAGA]	06.09-	CA1782IR	14 140	06.09-	CS1392	12 2.0	
		06.09-	CA1912IR	14 180				
	[CAGC]	06.09-	CA1782IR	14 140	06.09-	CS1392	12 2.0	
		06.09-	CA1912IR	14 180				
	[CAHA]	06.09-	CA1782IR	14 140	06.09-	CS1392	12 2.0	
		06.09-	CA1912IR	14 180				
Fura 0.9	[09NCA]	03.84- 12.86	CA3071R	14 45	03.84- 12.86	CS90	12 0.8	
		03.84- 12.86	CA3071R	14 45				
	[100GL7000]	01.82- 06.86	CA3071R	14 45	01.82- 06.86	CS90	12 0.8	
		01.82- 06.86	CA3071R	14 45				
Ibiza 0.9	[09NCA]	08.90- 05.93	CA3071R	14 45	08.90- 05.93	CS90	12 0.8	
		08.90- 05.93	CA3071R	14 45				
Ibiza 1.0	[ALD]	05.99- 05.02	CA1560IR	14 90	05.99- 05.02	CS788	12 0.9	
		05.99- 05.02	CA1568IR	14 70				
		PS 05.99- 05.02	CA1504IR	14 70				
		PS 05.99- 05.02	CA1542IR	14 90				
	[ANV]	05.99- 07.00	CA1560IR	14 90	05.99- 07.00	CS880	12 1.1	
		05.99- 07.00	CA1568IR	14 70				
		PS 05.99- 07.00	CA1504IR	14 70				
		PS 05.99- 07.00	CA1542IR	14 90				
	[AUC]	07.00- 05.02	CA1560IR	14 90	07.00- 05.02	CS880	12 1.1	
		07.00- 05.02	CA1568IR	14 70				
		PS 07.00- 05.02	CA1504IR	14 70				
		PS 07.00- 05.02	CA1542IR	14 90				
	[AAU]	03.93- 09.96	CA376IR	14 65	03.93- 04.95	CS293	12 0.8	
		03.93- 09.96	CA588IR	14 55				
	Ibiza 1.0 16V	[AST]	05.00- 02.02	CA1560IR	14 90	05.00- 02.02	CS788	12 0.9
			05.00- 02.02	CA1568IR	14 70			
PS 05.00- 02.02			CA1504IR	14 70				
PS 05.00- 02.02			CA1542IR	14 90				
[AVZ]		05.00- 02.02	CA1560IR	14 90	05.00- 02.02	CS788	12 0.9	
		05.00- 02.02	CA1568IR	14 70				
		PS 05.00- 02.02	CA1504IR	14 70				
		PS 05.00- 02.02	CA1542IR	14 90				
Ibiza 1.0 i		[AER]	09.96- 10.99	CA733IR	14 70	09.96- 10.99	CS788	12 0.9
			PS 09.96- 10.99	CA736IR	14 90			
			PS 09.96- 10.99	CA827IR	14 70			
			PS 09.96- 10.99	CA827IR	14 70			
Ibiza 1.2		[021A1000]	06.84- 09.85	CA871R	14 55	06.84- 12.93	CS344	12 0.8
			09.85- 12.93	CA313IR	14 55			
			09.85- 12.93	CA586IR	14 65			
			11.01- 04.04	CA1675IR	14 90 ▲			
	[AZQ]	11.01- 04.04	CA1755IR	14 70 ▲	07.02- 04.04	CS1282	12 0.9	
		02.02- 06.02	CA1755IR	14 70 ▲				
	[BBM]	06.07- 05.08	CA1675IR	14 90	06.07- 05.08	CS1330	12 1.0	
		06.07- 05.08	CA1755IR	14 70				
	[BZG]	03.08-	CA1675IR	14 90	03.08-	CS1330	12 1.0	
		03.08-	CA1755IR	14 70				
	[CGPA]	05.10-	CA1675IR	14 90	05.10-	CS1330	12 1.0	
		05.10-	CA1755IR	14 70				
	[CGPB]	07.09-	CA1675IR	14 90	07.09-	CS1330	12 1.0	
		07.09-	CA1755IR	14 70				
[CHFA]	07.09-	CA1675IR	14 90	07.09-	CS1330	12 1.0		
	07.09-	CA1755IR	14 70					
Ibiza 1.2 12V	[BXV]	05.06-	CA1675IR	14 90	05.06-	CS1330	12 1.0	
		05.06-	CA1755IR	14 70				
Ibiza 1.2 i	[021C.1000]	01.89- 05.93	CA313IR	14 55	01.89- 05.93	CS344	12 0.8	
		01.89- 05.93	CA586IR	14 65				
Ibiza 1.2 TSi	[CBZB]				09.10-	CS1330	12 1.0	
Ibiza 1.2 TDi	[CFWA]				A25 04.10-	CS1505*	12 2.0	
Ibiza 1.2 TDi Sportscoupe	[CFWA]				A25 05.10-	CS1505*	12 2.0	
Ibiza 1.3 i	[AAV]	03.93- 07.94	CA376IR	14 65	03.93- 07.94	CS293	12 0.8	
		03.93- 07.94	CA588IR	14 55				
Ibiza 1.4	[AKK]	05.99- 05.02	CA1504IR	14 70	05.99- 05.02	CS880	12 1.1	
		05.99- 05.02	CA1542IR	14 90				
	[ANW]	05.99- 08.00	CA1504IR	14 70	08.99- 08.00	CS880	12 1.1	
		05.99- 08.00	CA1542IR	14 90				
	[AUD]	06.00- 05.02	CA1504IR	14 70	06.00- 05.02	CS788	12 0.9	
		06.00- 05.02	CA1542IR	14 90				
	[BXW]	03.08-	CA1560IR	14 90	03.08-	CS1470	12 1.1	
		03.08-	CA1568IR	14 70				
		AC 03.08-	CA1542IR	14 90				
		AC 03.08-	CA1729IR	14 110				
	[CGGB]	03.10-	CA1560IR	14 90	03.10-	CS1330	12 1.0	
		03.10-	CA1568IR	14 70				
		03.10-	CA1815IR#	14 110				
		AC 03.10-	CA1542IR	14 90				
AC 03.10-		CA1729IR	14 110					
AC 03.10-		CA1729IR	14 110					
Ibiza 1.4 16V	[APE]	05.99- 06.00	CA1504IR	14 70	05.99- 06.00	CS880	12 1.1	
		05.99- 06.00	CA1542IR	14 90				
	[AQQ]	08.99- 07.00	CA1504IR	14 70	08.99- 07.00	CS880	12 1.1	
		08.99- 07.00	CA1542IR	14 90				
	[AUA]	05.00- 05.02	CA1504IR	14 70	05.00- 05.02	CS788	12 0.9	
		05.00- 05.02	CA1542IR	14 90				
	[AUB]	07.00- 05.02	CA1504IR	14 70	07.00- 05.02	CS788	12 0.9	
		07.00- 05.02	CA1542IR	14 90				
	[BKY]	Chas. 6L-2-012770- 02.02- Chas. 6L-2-012770- 02.02- Chas. -6L-2-012769 02.02- Chas. -6L-2-012769 02.02- AC, Chas. 6L-2-012770- 02.02- AC, Chas. -6L-2-012769 02.02-	07.00- 05.02	CA1560IR	14 90	07.00- 05.02	CS1197	12 1.1
			07.00- 05.02	CA1568IR	14 70			
			07.00- 05.02	CA1566IR	14 70			
			07.00- 05.02	CA1567IR	14 90			
			07.00- 05.02	CA1542IR	14 90			
			07.00- 05.02	CA1512IR	14 90			
			07.00- 05.02	CA1560IR	14 90			
			07.00- 05.02	CA1568IR	14 70			
07.00- 05.02			CA1566IR	14 70				
07.00- 05.02			CA1567IR	14 90				
[BZY]	Chas. 6L-2-012770- 02.02- Chas. 6L-2-012770- 02.02- Chas. -6L-2-012769 02.02- Chas. -6L-2-012769 02.02-	5SP 02.02-	CA1560IR	14 90	5SP 02.02- AT 02.02-	CS1197	12 1.1	
		AT 02.02-	CA1568IR	14 70				



SEAT Continued

		AC, Chas. 6L-2-012770- 02.02-	CA1542IR	14 90				
		AC, Chas. -6L-2-012769 02.02-	CA1512IR	14 90				
	[BBZ]	Chas. 6L-2-012770- 02.02-	CA1560IR	14 90	02.02-	CS1197	12 1.1	
		Chas. 6L-2-012770- 02.02-	CA1568IR	14 70				
		Chas. -6L-2-012769 02.02-	CA1566IR	14 70				
		Chas. -6L-2-012769 02.02-	CA1567IR	14 90				
		AC, Chas. 6L-2-012770- 02.02-	CA1542IR	14 90				
		AC, Chas. -6L-2-012769 02.02-	CA1512IR	14 90				
	[BXW]	05.06-	CA1560IR	14 90	05.06-	CS1330	12 1.0	
		05.06-	CA1568IR	14 70				
		AC 05.06-	CA1542IR	14 90				
		AC 05.06-	CA1729IR	14 110				
Ibiza 1.4 i 16V	[AFH]	09.96- 08.99	CA827IR	14 70	09.96- 08.99	CS788	12 0.9	
		AC 09.96- 08.99	CA736IR	14 90	09.96- 08.99	CS880	12 1.1	
Ibiza 1.4 i	[ABD]	09.93- 12.95	CA732IR	14 60	09.93- 12.95	CS788	12 0.9	
		09.93- 12.95	CA733IR	14 70	09.93- 12.95	CS880	12 1.1	
		PS 09.93- 12.95	CA827IR	14 70				
	[AEX]	12.95- 12.97	CA732IR	14 60	12.95- 12.97	CS788	12 0.9	
		12.95- 12.97	CA733IR	14 70	12.95- 12.97	CS880	12 1.1	
		PS 12.95- 12.97	CA736IR	14 90				
		PS 12.95- 12.97	CA827IR	14 70				
	[AKV]	12.97- 10.99	CA732IR	14 60	12.97- 10.99	CS788	12 0.9	
		12.97- 10.99	CA733IR	14 70	12.97- 10.99	CS880	12 1.1	
		PS 12.97- 10.99	CA736IR	14 90				
		PS 12.97- 10.99	CA827IR	14 70				
	[APQ]	12.97- 10.99	CA732IR	14 60	12.97- 10.99	CS880	12 1.1	
		12.97- 10.99	CA733IR	14 70	12.97- 10.99	CS788	12 0.9	
		PS 12.97- 10.99	CA736IR	14 90				
		PS 12.97- 10.99	CA827IR	14 70				
Ibiza 1.4 TSi	[CAVE]	06.09-	CA1921IR	14 110	06.09-	CS1470	12 1.1	
		AT 06.09-	CA1985IR	14 140				
	[CAVF]	06.09-	CA1921IR	14 110	06.09-	CS1470	12 1.1	
		AT 06.09-	CA1985IR	14 140				
Ibiza 1.4 TDi	[AMF]	05.02-	CA1441IR	14 90	11.04-	CS1293	12 2.0	
		05.02-	CA1644IR	14 120	5SP 05.02- 10.04	CS974	12 1.8	
		05.02-	CA1682IR	14 70				
	[BMS]	06.05-	CA1441IR	14 90	06.05-	CS1293	12 2.0	
		06.05-	CA1644IR	14 120				
		06.05-	CA2064IR*	14 90				
		06.05-	CA2065IR	14 110				
	[BNM]	05.05-	CA1441IR	14 90	05.05-	CS1393	12 1.7	
		05.05-	CA1644IR	14 120				
		05.05-	CA2064IR*	14 90				
		05.05-	CA2065IR	14 110				
	[BNV]	06.05-	CA1441IR	14 90	06.05-	CS1293	12 2.0	
		06.05-	CA1644IR	14 120				
		06.05-	CA2065IR	14 110				
Ibiza 1.5	[021A2000]	11.84- 08.85	CA87IR	14 55	11.84- 05.93	CS344	12 0.8	
		09.85- 05.93	CA313IR	14 55				
		09.85- 05.93	CA586IR	14 65				
Ibiza 1.5 i	[021B.2000]	10.86- 05.93	CA313IR	14 55	10.86- 05.93	CS344	12 0.8	
		10.86- 05.93	CA586IR	14 65				
	[021C.2000]	10.86- 05.93	CA313IR	14 55	10.86- 05.93	CS344	12 0.8	
		10.86- 05.93	CA586IR	14 65				
	[021D.2000]	10.86- 05.93	CA313IR	14 55	10.86- 05.93	CS344	12 0.8	
		10.86- 05.93	CA586IR	14 65				
Ibiza 1.6	[AEH]	05.99- 05.02	CA1378IR	14 90	05.99- 05.02	CS1062	12 1.1	
		05.99- 05.02	CA1436IR	14 70				
	[AKL]	05.99- 05.02	CA1378IR	14 90	05.99- 05.02	CS1062	12 1.1	
		05.99- 05.02	CA1436IR	14 70				
	[ALM]	09.97- 02.02	CA1504IR	14 70	09.97- 02.02	CS788	12 0.9	
		09.97- 02.02	CA1542IR	14 90	09.97- 02.02	CS880	12 1.1	
	[APF]	08.99- 10.00	CA1378IR	14 90	08.99- 10.00	CS1062	12 1.1	
		08.99- 10.00	CA1436IR	14 70				
	[AUR]	07.00- 05.02	CA1378IR	14 90	07.00- 05.02	CS1062	12 1.1	
		07.00- 05.02	CA1436IR	14 70				
	[BAH]	02.03-	CA1560IR	14 90	02.03-	CS1330	12 1.0	
		02.03-	CA1568IR	14 70				
		AC 02.03-	CA1542IR	14 90				
	[BTS]	05.08-	CA1817IR	14 110	05.08-	CS1330	12 1.0	
Ibiza 1.6 Sportscoupe	[BTS]	07.08-	CA1817IR	14 110	07.08-	CS1330	12 1.0	
Ibiza 1.6 16V	[BTS]	11.06-	CA1817IR	14 110	11.06-	CS1330	12 1.0	
Ibiza 1.6 i	[1F]	05.94- 08.99	CA733IR	14 70	05.94- 08.99	CS618	12 1.1	
		05.94- 08.99	CA740IR	14 90				
		AC 05.94- 08.99	CA736IR	14 90				
	[ABU]	03.93- 07.94	CA736IR	14 90	03.93- 07.94	CS880	12 1.1	
		03.93- 07.94	CA827IR	14 70				
	[AEE]	03.97- 12.98	CA827IR	14 70	03.97- 12.98	CS880	12 1.1	
		AC 03.97- 12.98	CA736IR	14 90	03.97- 12.98	CS788	12 0.9	
	[AFT]	12.95- 10.99	CA732IR	14 60	12.95- 10.99	CS618	12 1.1	
		12.95- 10.99	CA733IR	14 70	12.95- 10.99	CS1062	12 1.1	
		12.95- 10.99	CA740IR	14 90				
		AC 12.95- 10.99	CA736IR	14 90				
	[ALM]	Chas. 6K-X-400000- 09.97- 05.02	CA1504IR	14 70	09.97- 05.02	CS880	12 1.1	
		Chas. 6K-X-400000- 09.97- 05.02	CA1542IR	14 90	09.97- 05.02	CS788	12 0.9	
		Chas. -6K-X-399999 09.97- 05.02	CA736IR	14 90				
		Chas. -6K-X-399999 09.97- 05.02	CA827IR	14 70				
Ibiza 1.6 LPG	[CNKA]	05.11-	CA1817IR	14 110	05.11-	CS1330	12 1.0	
Ibiza 1.6 TDi	[CAYB]	05.09-	CA1782IR	14 140	A25 05.09-	CS1505*	12 2.0	
		03.10-	CA1810IR	14 110				
	[CAYC]	05.09-	CA1782IR	14 140	A25 05.09-	CS1505*	12 2.0	
	[CLNA]	03.10-	CA1782IR	14 140	A25 03.10-	CS1505*	12 2.0	
		03.10-	CA1810IR	14 110				
Ibiza 1.7 Diesel	[022A.5000]	06.84- 05.93	CA119IR	14 45	06.84- 05.93	CS286	12 1.6	
		06.84- 05.93	CA129IR	14 55				
Ibiza 1.8 i 16V	[ADL]	11.93- 08.96	CA736IR	14 90	11.93- 08.96	CS618	12 1.1	
		11.93- 08.96	CA827IR	14 70				
Ibiza 1.8 i	[ABS]	03.93- 07.94	CA732IR	14 60	03.93- 07.94	CS618	12 1.1	
		03.93- 07.94	CA733IR	14 70				
		03.93- 07.94	CA740IR	14 90				
		AC 03.93- 07.94	CA736IR	14 90				
	[ADZ]	07.94- 10.99	CA732IR	14 60	07.94- 11.95	CS618	12 1.1	
		07.94- 10.99	CA733IR	14 70	11.95- 10.99	CS1062	12 1.1	
		07.94- 10.99	CA740IR	14 90				





		AC 07.94- 10.99	CA736IR	14 90				
		AC 07.94- 10.99	CA827IR	14 70				
Ibiza 1.8 Turbo 20V Cupra	[AQX]	10.99- 10.00	CA1378IR	14 90	10.99- 10.00	CS1119	12 1.1	
	[AYP]	10.99- 10.00	CA1446IR	14 90				
		09.00- 05.02	CA1378IR	14 90	09.00- 05.02	CS1119	12 1.1	
		09.00- 05.02	CA1436IR	14 70				
Ibiza 1.8 Turbo Cupra R	[BBU]	01.04- 04.05	CA1378IR	14 90	01.04- 04.05	CS1294	12 1.1	
		01.04- 04.05	CA1394IR	14 120				
		01.04- 04.05	CA1436IR	14 70				
Ibiza 1.8 Turbo FR	[BJX]	12.03- 12.03	CA1378IR	14 90	12.03-	CS1119	12 1.1	
		12.03-	CA1436IR	14 70				
		12.03-	CA1818IR	14 110				
	[BKV]	12.03-	CA1378IR	14 90	12.03-	CS1119	12 1.1	
		12.03-	CA1436IR	14 70				
		12.03-	CA1818IR	14 110				
Ibiza 1.9 Diesel	[1Y]	04.93- 08.96	CA732IR	14 60	Chas. ZR135501- 04.93- 08.96	CS789	12 1.8	
		04.93- 08.96	CA733IR	14 70	Chas. -ZR199604 04.93- 08.96	CS713	12 1.8	
		04.93- 08.96	CA740IR	14 90				
		AC 04.93- 08.96	CA736IR	14 90				
Ibiza 1.9 SDi	[AEF]	08.96- 08.99	CA1260IR	14 120	12.95- 10.99	CS789	12 1.8	
		08.96- 05.98	CA1297IR	14 90				
		08.96- 08.99	CA736IR	14 90				
		08.96- 08.99	CA827IR	14 70				
		06.98- 08.99	CA1510IR	14 70				
	[AEY]	12.95- 10.99	CA1297IR	14 90	12.95- 10.99	CS789	12 1.8	
		12.95- 10.99	CA736IR	14 90				
		12.95- 10.99	CA827IR	14 70				
		AC 12.95- 10.99	CA736IR	14 90				
	[AGP]	05.99- 05.02	CA1394IR	14 120	05.99- 01.02	CS789	12 1.8	
		05.99- 05.02	CA1446IR	14 90	02.02- 05.02	CS1287	12 2.0	
		05.99- 05.02	CA1502IR	14 70				
	[AQM]	05.99- 05.02	CA1394IR	14 120	05.99- 01.02	CS789	12 1.8	
		05.99- 05.02	CA1446IR	14 90	02.02- 05.02	CS1287	12 2.0	
		05.99- 05.02	CA1502IR	14 70				
	[ASY]	02.02-	CA1394IR	14 120	Chas. 6L-5D090016-, 6L- 11.04- 5R090179-	CS1393	12 1.7	
		02.02-	CA1446IR	14 90	Chas. -6L-5D090015, -6L 02.02- 5R090178	CS1200	12 2.0	
	02.02-	CA1502IR	14 70					
Ibiza 1.9 TD	[AAZ]	03.93- 08.96	CA732IR	14 60	Chas. -ZR135500 03.93- 08.96	CS713	12 1.8	
		03.93- 08.96	CA733IR	14 70	Chas. ZR135501 03.93- 08.96	CS789	12 1.8	
		03.93- 08.96	CA740IR	14 90				
		AC 03.93- 08.96	CA736IR	14 90				
Ibiza 1.9 TDi	[1Z]	08.96- 12.96	CA1089IR	14 120	08.96- 12.96	CS974	12 1.8	
		08.96- 12.96	CA1260IR	14 120				
		08.96- 12.96	CA1297IR	14 90				
	[AFN]	02.97- 08.99	CA1089IR	14 120	02.97- 08.99	CS974	12 1.8	
		02.97- 08.99	CA1260IR	14 120				
		02.97- 05.98	CA1297IR	14 90				
		06.98- 08.99	CA1510IR	14 70				
	[AGR]	05.99- 05.02	CA1394IR	14 120	05.99- 05.02	CS974	12 1.8	
		05.99- 05.02	CA1446IR	14 90				
		05.99- 05.02	CA1502IR	14 70				
	[AHU]	12.96- 08.99	CA1089IR	14 120	12.96- 08.99	CS974	12 1.8	
		12.96- 08.99	CA1260IR	14 120	12.96- 08.99	CS1266	12 1.8	
		12.96- 05.98	CA1297IR	14 90				
		05.98- 08.99	CA1510IR	14 70				
	[ALH]	05.99- 05.02	CA1394IR	14 120	05.99- 05.02	CS974	12 1.8	
		05.99- 05.02	CA1446IR	14 90				
		05.99- 05.02	CA1502IR	14 70				
	[ASK]	08.99- 02.02	CA1394IR	14 120	08.99- 02.02	CS974	12 1.8	
	[ASV]	05.99- 05.02	CA1394IR	14 120	05.99- 05.02	CS974	12 1.8	
		05.99- 05.02	CA1446IR	14 90				
		05.99- 05.02	CA1502IR	14 70				
	[ASZ]	02.02-	CA1394IR	14 120	02.02-	CS1181	12 2.0	
		02.02-	CA1446IR	14 90				
		02.02-	CA1502IR	14 70				
	[ATD]	02.02-	CA1394IR	14 120	12.04-	CS1293	12 2.0	
		02.02-	CA1446IR	14 90	02.02- 12.04	CS974	12 1.8	
		02.02-	CA1502IR	14 70				
	[AXR]	05.05-	CA1394IR	14 120	05.05-	CS1293	12 2.0	
		05.05-	CA1446IR	14 90	05.05-	CS974	12 1.8	
		05.05-	CA1502IR	14 70				
	[BLS]	03.08-	CA1394IR	14 120	03.08-	CS1293	12 2.0	
		03.08-	CA1502IR	14 70				
		03.08-	CA2064IR*	14 90				
		AC 03.08-	CA1446IR	14 90				
	[BLT]	05.05-	CA1394IR	14 120	05.05-	CS1181	12 2.0	
		05.05-	CA1446IR	14 90				
		05.05-	CA1502IR	14 70				
	[BMT]	05.05-	CA1394IR	14 120	05.05-	CS1293	12 2.0	
		05.05-	CA1446IR	14 90	05.05-	CS974	12 1.8	
	05.05-	CA1502IR	14 70					
[BXJ]	07.08-	CA1394IR	14 120	07.08-	CS1293	12 2.0		
	07.08-	CA2064IR*	14 90					
	AC 07.08-	CA1446IR	14 90					
Ibiza 1.9 TDi Cupra R	[BPX]	03.04-	CA1394IR	14 120	03.04- 10.04	CS1181	12 2.0	
		03.04-	CA1446IR	14 90	11.04-	CS1323	12 2.0	
		03.04-	CA1502IR	14 70				
Ibiza 1.9 TDi Spotscoupe	[BLS]	07.08-	CA1394IR	14 120	07.08-	CS1293	12 2.0	
		07.08-	CA1502IR	14 70				
		07.08-	CA2064IR*	14 90				
		AC 07.08-	CA1446IR	14 90				
Ibiza 2.0 i 16V	[ABF]	08.96- 08.99	CA740IR	14 90	08.96- 08.99	CS619	12 1.1	
		08.96- 08.99	CA827IR	14 70				
		AC 08.96- 08.99	CA736IR	14 90				
Ibiza 2.0 i	[2E]	03.93- 04.96	CA733IR	14 70	03.93- 04.96	CS618	12 1.1	
		03.93- 04.96	CA740IR	14 90				
		AC 03.93- 04.96	CA736IR	14 90				
	[AGG]	04.96- 10.99	CA733IR	14 70	04.96- 10.99	CS1062	12 1.1	
		04.96- 10.99	CA740IR	14 90				
		AC 04.96- 10.99	CA736IR	14 90				



**SEAT** Continued

Ibiza 2.0 TDi	[CFHD]	01.10-	CA1782IR	14 140		01.10-	CS1323	12 2.0
		01.10-	CA1810IR	14 110	A25 01.10-	CS1508*	12 1.7	
		A25 01.10-	CA2011IR	14 140				
Ibiza 2.0 TDi Sportcoupe	[CFHD]	01.10-	CA1782IR	14 140		01.10-	CS1323	12 2.0
		01.10-	CA1810IR	14 110	A25 01.10-	CS1508*	12 1.7	
		A25 01.10-	CA2011IR	14 140				
Inca 1.4 16V	[AUA]	04.00- 06.03	CA1504IR	14 70		04.00- 06.03	CS788	12 0.9
		04.00- 06.03	CA1542IR	14 90		04.00- 06.03	CS880	12 1.1
Inca 1.4 i	[AEX]	11.95- 12.97	CA733IR	14 70		11.95- 12.97	CS788	12 0.9
		11.95- 12.97	CA740IR	14 90				
		PS 11.95- 12.97	CA736IR	14 90				
		PS 11.95- 12.97	CA827IR	14 70				
	[AKV]	09.97- 09.00	CA733IR	14 70		09.97- 09.00	CS788	12 0.9
		09.97- 09.00	CA740IR	14 90				
		PS 09.97- 09.00	CA736IR	14 90				
	[APOQ]							
		12.97- 06.03	CA733IR	14 70		12.97- 06.03	CS788	12 0.9
12.97- 06.03		CA740IR	14 90		12.97- 06.03	CS880	12 1.1	
PS 12.97- 06.03		CA736IR	14 90					
[AUD]								
	09.00- 06.03	CA1504IR	14 70		09.00- 06.03	CS788	12 0.9	
Inca 1.6 i	[1F]	09.00- 06.03	CA1542IR	14 90		09.00- 06.03	CS880	12 1.1
		11.95- 05.97	CA733IR	14 70		11.95- 05.97	CS618	12 1.1
Inca 1.6 i	[AEE]	11.95- 05.97	CA740IR	14 90				
		AC 11.95- 05.97	CA736IR	14 90				
	06.97- 09.00	CA733IR	14 70		06.97- 09.00	CS880	12 1.1	
	06.97- 09.00	CA740IR	14 90		06.97- 09.00	CS788	12 0.9	
Inca 1.7 Diesel	[AHB]	06.97- 09.00	CA827IR	14 70				
		PS 06.97- 09.00	CA827IR	14 70				
		AC 06.97- 09.00	CA736IR	14 90				
Inca 1.9 Diesel	[1Y]	09.96- 09.00	CA1260IR	14 120		09.96- 09.00	CS789	12 1.8
		09.96- 09.00	CA1297IR	14 90				
		09.96- 09.00	CA1510IR	14 70				
Inca 1.9 SDi	[AEY]	09.96- 09.00	CA1510IR	14 70				
		11.95- 06.03	CA733IR	14 70		11.95- 06.03	CS789	12 1.8
Inca 1.9 SDi	[AYQ]	11.95- 06.03	CA736IR	14 90				
		AC 11.95- 09.00	CA736IR	14 90				
	09.00- 06.03	CA1394IR	14 120		09.00- 01.02	CS789	12 1.8	
	09.00- 06.03	CA1446IR	14 90		02.02- 06.03	CS1287	12 2.0	
Inca 1.9 TDi	[ALH]	09.00- 06.03	CA1502IR	14 70				
		09.00- 06.03	CA1502IR	14 70				
		09.96-	CA1446IR	14 90		09.96-	CS974	12 1.8
09.96-	CA1502IR	14 70						
09.96-	CA1510IR	14 70						
Leon 1.2 TSi	[CBZB]					02.10-	CS1322	12 1.1
Leon 1.4 16V	[AHW]	12.99- 05.02	CA1436IR	14 70		12.99- 05.02	CS1343	12 0.9
		12.99- 05.02	CA1512IR	14 90		11.99-	CS1062	12 1.1
		AC 12.99- 05.02	CA1378IR	14 90				
	[APE]	11.99-	CA1378IR	14 90		11.99-	CS1062	12 1.1
		11.99-	CA1436IR	14 70				
		AC 11.99-	CA1512IR	14 90				
	[AXP]	11.99-	CA1512IR	14 90		11.99-	CS1062	12 1.1
		AC 06.00- 02.02	CA1378IR	14 90				
	[BCA]	02.02- 04.04	CA1378IR	14 90		11.99- 02.04	CS1062	12 1.1
		AC 02.02- 04.04	CA1512IR	14 90				
	[BXW]	06.06-	CA1560IR	14 90		06.06-	CS1330	12 1.0
		06.06-	CA1815IR#	14 110				
		AC 06.06-	CA1729IR	14 110				
	Leon 1.4 TSi	[CAXC]	11.07-	CA1985IR	14 140			
		AC 11.07-	CA2056IR*	14 110				
Leon 1.6	[AEH]	10.99-	CA1378IR	14 90		10.99-	CS1062	12 1.1
		10.99-	CA1436IR	14 70				
	[AKL]	10.99-	CA1378IR	14 90		10.99-	CS1062	12 1.1
		10.99-	CA1436IR	14 70				
	[BFQ]	10.05- 06.06	CA1378IR	14 90		10.05- 06.06	CS1062	12 1.1
		10.05- 06.06	CA1394IR	14 120				
	[BSE]	09.05-	CA1378IR	14 90		09.05-	CS1324	12 1.0
		09.05-	CA1782IR	14 140				
	[BSF]	09.05-	CA1818IR	14 110				
		09.05-	CA1782IR	14 140		09.05-	CS1324	12 1.0
		09.05-	CA1818IR	14 110				
Leon 1.6 16V	[AUS]	06.00- 04.01	CA1436IR	14 70		06.00- 04.01	CS1062	12 1.1
		06.00- 04.01	CA1512IR	14 90				
		AC 06.00- 04.01	CA1378IR	14 90				
	[AZD]	09.00- 04.02	CA1436IR	14 70		09.00- 04.02	CS1062	12 1.1
		09.00- 04.02	CA1512IR	14 90				
	[BCB]	AC 09.00- 04.02	CA1378IR	14 90				
04.02- 07.04		CA1436IR	14 70		04.02- 07.04	CS1062	12 1.1	
04.02- 07.04		CA1446IR	14 90					
04.02- 07.04	CA1512IR	14 90						
AC 04.02- 07.04	CA1378IR	14 90						
Leon 1.6 LPG	[CHGA]	12.09-	CA1782IR	14 140		12.09-	CS1324	12 1.0
		AT 12.09-			AT 12.09-	CS1347	12 1.1	
Leon 1.6 TDi	[CAYB]	11.10-	CA1782IR	14 140				
	[CAYC]	02.10-	CA2011IR	14 140		A25 02.10-	CS1505*	12 2.0
					AT 02.10-	CS1480*	12 1.8	
Leon 1.8 20V	[AGN]	10.99-	CA1378IR	14 90		AT 10.99-	CS1062	12 1.1
		10.99-	CA1436IR	14 70		10.99-	CS1119	12 1.1
		11.99-	CA1394IR	14 120				
	[APG]	10.99-	CA1436IR	14 70		10.99-	CS1119	12 1.1
		12.99- 07.04	CA1378IR	14 90		AT 12.99- 07.04	CS1062	12 1.1
		12.99- 07.04	CA1394IR	14 120				
Leon 1.8 TSi	[BZB]	06.07-	CA1811IR	14 140		06.07-	CS1294	12 1.1
Leon 1.8 Turbo 20V	[AUQ]	09.00-	CA1394IR	14 120		AT 09.00- 04.04	CS1062	12 1.1
		10.99-	CA1378IR	14 90		Chas. 1M..2..020 001- 08.01- 04.04	CS1337	12 1.1
					Chas. -1M..2..020 000 09.00- 07.01	CS1181	12 2.0	
					10.99-	CS1119	12 1.1	
Leon 1.8 Turbo 20V 4 Syncro	[AJQ]	03.00- 01.01	CA1378IR	14 90		03.00- 01.01	CS1181	12 2.0
		03.00- 01.01	CA1436IR	14 70		AT 03.00- 01.01	CS1119	12 1.1
					03.00- 01.01	CS1062	12 1.1	
	[ARY]	09.00- 04.04	CA1378IR	14 90		Chas. -1M..2..020 000 09.00- 07.01	CS1181	12 2.0
		09.00- 04.04	CA1394IR	14 120		09.00- 04.04	CS1119	12 1.1
		09.00- 04.04	CA1436IR	14 70		Chas. 1M..2..020 001- 08.01- 04.04	CS1337	12 1.1
					AT, 4SP 09.00- 04.04	CS1062	12 1.1	



Leon 1.8 Turbo	[APP]	10.99-10.99-12.99-	CA1378IR CA1436IR CA1394IR	14 90 14 70 14 120	AT 10.99-10.99-	CS1062 CS1119	12 1.1 12 1.1
Leon 1.8 Turbo Cupra R	[AMK]	05.02-05.03 05.02-05.03	CA1378IR CA1394IR	14 90 14 120	05.02-05.03	CS1337	12 1.1
	[BAM]	05.03-05.03-	CA1378IR CA1394IR	14 90 14 120	05.03-	CS1337	12 1.1
Leon 1.9 SDI	[AQM]	11.99-11.99-10.03	CA1394IR CA1446IR	14 120 14 90	Chas. -1M..2..020 000 11.99-07.01 Chas. 1M..2..020 001-08.01-10.03	CS789 CS1287	12 1.8 12 2.0
Leon 1.9 TDi	[AGR]	12.99-12.99-09.02 12.99-09.02	CA1394IR CA1446IR CA1502IR	14 120 14 90 14 70	12.99-09.02 AT 12.99-09.02	CS974 CS789	12 1.8 12 1.8
	[AHF]	10.99-	CA1394IR	14 120	10.99-	CS974	12 1.8
	[ALH]	10.99-10.99-10.99-	CA1394IR CA1446IR CA1502IR	14 120 14 90 14 70	10.99-AT 10.99-	CS974 CS789	12 1.8 12 1.8
	[ARL]	09.00-09.00-07.04	CA1394IR CA1446IR	14 120 14 90	09.00-07.04	CS1181	12 2.0
	[ASV]	10.99-11.99-	CA1394IR CA1446IR	14 120 14 90	10.99-	CS974	12 1.8
	[ASZ]	05.03-05.03-07.04	CA1394IR CA1446IR	14 120 14 90	05.03-07.04	CS1181	12 2.0
	[AXR]	10.05-10.05-	CA1394IR CA1446IR	14 120 14 90	10.05-	CS974	12 1.8
	[BKC]	09.05-09.05-	CA1782IR CA1810IR	14 140 14 110	AT 09.05-09.05-	CS1286 CS1293	12 2.0 12 2.0
	[BLS]	09.05-09.05-	CA1782IR CA1810IR	14 140 14 110	09.05-AT, 7SP 09.05-AT, 6SP 09.05-	CS1293 CS1480* CS1286	12 2.0 12 1.8 12 2.0
	[BXE]	09.05-09.05-	CA1782IR CA1810IR	14 140 14 110	09.05-AT 09.05-	CS1293 CS1286	12 2.0 12 2.0
	[BXF]	06.07-06.07-	CA1782IR CA1810IR	14 140 14 110	06.07-	CS1293	12 2.0
Leon 1.9 TDi Syncro	[ARL]	05.02-05.02-07.04	CA1394IR CA1446IR	14 120 14 90	05.02-07.04	CS1181	12 2.0
Leon 2.0 FSI	[BLR]	09.05-09.05-	CA1782IR CA1818IR	14 140 14 110	AT 09.05-09.05-	CS1347 CS1294	12 1.1 12 1.1
	[BLY]	09.05-09.05-	CA1782IR CA1818IR	14 140 14 110	AT 09.05-09.05-	CS1347 CS1294	12 1.1 12 1.1
	[BVY]	09.05-11.05-	CA1782IR CA1818IR	14 140 14 110	11.05-AT 09.05-	CS1294 CS1347	12 1.1 12 1.1
	[BVZ]	09.05-09.05-	CA1782IR CA1818IR	14 140 14 110	09.05-AT 09.05-	CS1294 CS1347	12 1.1 12 1.1
Leon 2.0 TFSI	[BWA]	09.05-09.05-	CA1782IR CA1818IR	14 140 14 110	09.05-AT 09.05-	CS1347 CS1409	12 1.1 12 1.0
	[BWJ]	11.06-06.09-	CA1782IR CA1811IR	14 140 14 140	11.06-06.09-	CS1347 CS1347	12 1.1 12 1.1
	[CCZB]	06.09-09.09-	CA1782IR	14 140	06.09-09.09-	CS1347	12 1.1
	[CDLA]	09.09-	CA1782IR	14 140	09.09-	CS1347	12 1.1
Leon 2.0 TDi 16V	[BKD]	09.05-09.05-	CA1782IR CA1810IR	14 140 14 110	AT 09.05-6SP 09.05-	CS1286 CS1323	12 2.0 12 2.0
Leon 2.0 TDi	[AZV]	10.05-10.05-	CA1782IR CA1810IR	14 140 14 110	AT 10.05-10.05-	CS1286 CS1323	12 2.0 12 2.0
	[BMM]	10.05-10.05-	CA1782IR CA1810IR	14 140 14 110	AT 10.05-10.05-	CS1286 CS1323	12 2.0 12 2.0
	[BMN]	02.06-02.06-	CA1782IR CA1810IR	14 140 14 110	02.06-	CS1323	12 2.0
Leon 2.8 Cupra 4	[AUE]	02.01-02.01-	CA1394IR CA1446IR	14 120 14 90	02.01-	CS1181	12 2.0
Malaga 1.2	[021A1000]	05.85-09.85-08.85 09.85-12.93 09.85-12.93	CA87IR CA313IR CA586IR	14 55 14 55 14 65	05.85-12.93	CS344	12 0.8
Malaga 1.2 i	[021C.1000]	12.89-12.89-12.93 12.89-12.93	CA313IR CA586IR	14 55 14 65	12.89-12.93	CS344	12 0.8
Malaga 1.5	[021A2000]	05.85-09.85-08.85 09.85-12.93 09.85-12.93	CA87IR CA313IR CA586IR	14 55 14 55 14 65	05.85-12.93	CS344	12 0.8
Malaga 1.5 i	[021A2000]	10.86-10.86-12.93 10.86-12.93	CA313IR CA586IR	14 55 14 65	10.86-12.93	CS344	12 0.8
	[021B.2000]	01.87-01.87-12.93 01.87-12.93	CA313IR CA586IR	14 55 14 65	01.87-12.93	CS344	12 0.8
	[021C.2000]	10.86-10.86-12.93 10.86-12.93	CA313IR CA586IR	14 55 14 65	10.86-12.93	CS344	12 0.8
	[021D.2000]	10.86-10.86-12.93 10.86-12.93	CA313IR CA586IR	14 55 14 65	10.86-12.93	CS344	12 0.8
Malaga 1.7 Diesel	[022A.5000]	05.85-05.85-12.93 05.85-12.93	CA119IR CA129IR	14 45 14 55	05.85-12.93	CS286	12 1.6
Marbella 0.8	[08NCA]	08.86-12.93	CA307IR	14 45	08.86-12.93	CS90	12 0.8
Marbella 0.9	[08NCB]	11.96-11.96-10.98	CA119IR	14 45	11.96-10.98	CS90	12 0.8
	[09NCA]	01.87-12.93	CA307IR	14 45	01.87-12.93	CS90	12 0.8
	[09NCB]	01.87-01.87-02.97	CA307IR	14 45	01.87-02.97	CS90	12 0.8
Panda 0.9	[100GL7000]	10.80-12.86	CA307IR	14 45	09.82-12.86	CS90	12 0.8
Ritmo 1.2		07.78-09.83	CA129IR	14 55			
Ritmo 1.7 Diesel	[022A.5000]	10.79-09.83	CA129IR	14 55	10.79-09.83	CS286	12 1.6
Ronda 1.2	[021A1000]	05.84-09.85-12.86 09.85-12.86	CA87IR CA313IR CA586IR	14 55 14 55 14 65	05.84-12.86	CS344	12 0.8
	[124B6.000]	11.82-01.84-04.84 01.84-04.84	CA119IR CA87IR	14 45 14 55			
Ronda 1.4	[124B7000]	11.82-12.83	CA119IR	14 45			
Ronda 1.5	[021A2000]	09.84-09.85-12.86 09.85-12.86	CA87IR CA313IR CA586IR	14 55 14 55 14 65	09.84-12.86	CS344	12 0.8
Ronda 1.6	[138AR6000]				06.82-10.82	CS275	12 1.0
Ronda 1.7 Diesel	[022A.5000]	06.82-12.86	CA129IR	14 55	06.82-12.86	CS286	12 1.6
Terra 0.9	[09NCA]	01.87-12.96	CA307IR	14 45	01.87-12.96	CS90	12 0.8
	[09NCB]	01.90-12.95	CA307IR	14 45	01.90-12.95	CS90	12 0.8
Terra 1.3 Diesel	[MN]	03.90-12.94	CA588IR	14 55	03.90-12.94	CS500	12 1.4
Terra 1.4 Diesel	[1W]	10.90-12.95	CA588IR	14 55	10.90-12.95	CS500	12 1.4
Toledo 1.4 16V	[AHW]	07.99-07.99-05.02 07.99-05.02 AC 07.99-05.02 AC 07.99-05.02	CA1511IR CA1512IR CA1378IR CA1436IR	14 70 14 90 14 90 14 70	07.99-05.02	CS1062	12 1.1
	[AXP]	06.00-AC 06.00-02.02 AC 06.00-02.02	CA1512IR CA1378IR	14 90 14 90	06.00-02.02 06.00-02.02	CS1343 CS1062	12 0.9 12 1.1



**SEAT** *Continued*

Toledo 1.6	[AEH]	10.98- 05.02	CA1378IR	14 90		10.98- 05.02	CS1062	12 1.1	
		10.98- 05.02	CA1436IR	14 70					
	[AKL]	10.98- 05.02	CA1378IR	14 90		10.98- 05.02	CS1062	12 1.1	
		10.98- 05.02	CA1436IR	14 70					
	[BGU]	10.04-	CA1782IR	14 140		10.04-	CS1324	12 1.0	
		10.04-	CA1818IR	14 110					
	[BSE]	10.04-	CA1378IR	14 90		10.04-	CS1324	12 1.0	
		10.04-	CA1782IR	14 140					
[BSF]		10.04-	CA1818IR	14 110					
		10.04-	CA1378IR	14 90		10.04-	CS1324	12 1.0	
		10.04-	CA1782IR	14 140					
[CCSA]		10.04-	CA1818IR	14 110					
		10.04-	CA1782IR	14 140		10.04-	CS1324	12 1.0	
Toledo 1.6 16V	[AUS]	09.00- 05.06	CA1512IR	14 90		09.00- 05.06	CS1062	12 1.1	
		AC 09.00- 05.06	CA1378IR	14 90					
	[AZD]	09.00-	CA1512IR	14 90		09.00-	CS1062	12 1.1	
		AC 09.00-	CA1378IR	14 90					
Toledo 1.6 i	[1F]	10.93- 10.98	CA733IR	14 70		05.91- 10.98	CS618	12 1.1	
		10.93- 10.98	CA740IR	14 90		05.91- 10.98	CS294	12 0.9	
		Chas. -ZD304850	05.91- 12.93	CA298IR	14 65				
		Chas. -ZD304850	05.91- 12.93	CA320IR	14 90				
		AC 10.93- 10.98	CA736IR	14 90					
	[ABN]	10.93- 07.94	CA733IR	14 70		05.91- 07.94	CS294	12 0.9	
		10.93- 07.94	CA740IR	14 90		05.91- 07.94	CS618	12 1.1	
		Chas. -ZD304850	05.91- 10.93	CA298IR	14 65				
		Chas. -ZD304850	05.91- 10.93	CA320IR	14 90				
		AC 10.93- 07.94	CA736IR	14 90					
	[AFT]	11.96- 03.99	CA736IR	14 90		11.96- 03.99	CS618	12 1.1	
		11.96- 03.99	CA827IR	14 70					
	[EZ]	Chas. -ZD304850	05.91- 09.91	CA298IR	14 65		05.91- 09.91	CS294	12 0.9
		Chas. -ZD304850	05.91- 09.91	CA320IR	14 90				
Toledo 1.8 16V	[KR]	05.91- 11.92	CA342IR	14 65		05.91- 11.92	CS618	12 1.1	
		05.91- 11.92	CA521IR	14 90					
	[PL]	05.91- 03.94	CA342IR	14 65		05.91- 03.94	CS618	12 1.1	
	05.91- 03.94	CA521IR	14 90						
Toledo 1.8 20V	[AGN]	04.99- 05.06	CA1378IR	14 90		AT 04.99- 05.06	CS1062	12 1.1	
		04.99- 05.06	CA1436IR	14 70		04.99- 05.06	CS1119	12 1.1	
	[APG]	05.99- 05.06	CA1378IR	14 90		AT 05.99- 05.06	CS1062	12 1.1	
		05.99- 05.06	CA1394IR	14 120		05.99- 05.06	CS1119	12 1.1	
	05.99- 05.06	CA1436IR	14 70						
Toledo 1.8 i	[ABS]	11.93- 07.94	CA733IR	14 70		11.93- 07.94	CS618	12 1.1	
		11.93- 07.94	CA736IR	14 90					
		11.93- 07.94	CA740IR	14 90					
	[ADZ]	07.94- 12.96	CA733IR	14 70		07.94- 12.96	CS618	12 1.1	
		07.94- 12.96	CA736IR	14 90					
		07.94- 12.96	CA740IR	14 90					
	[RP]	Chas. ZD304851- 10.93- 12.96	CA733IR	14 70		05.91- 12.96	CS618	12 1.1	
	Chas. ZD304851- 10.93- 12.96	CA740IR	14 90						
	Chas. -ZD304850	05.91- 10.93	CA298IR	14 65					
	Chas. -ZD304850	05.91- 10.93	CA320IR	14 90					
	AC, Chas. ZD304851- 10.93- 12.96	CA736IR	14 90						
Toledo 1.8 TFSi	[BYT]	01.07- 06.07	CA1811IR	14 140		01.07- 06.07	CS1294	12 1.1	
Toledo 1.8 Turbo 20V	[AUG]	05.01- 05.06	CA1378IR	14 90		Chas. 1M-2-020001- 05.01- 05.06	CS1337	12 1.1	
		05.01- 05.06	CA1394IR	14 120		Chas. -1M-2-020000 05.01- 05.06	CS1181	12 2.0	
Toledo 1.9 Diesel	[1Y]	05.91- 10.93	CA302IR	14 65		07.94- 03.99	CS789	12 1.8	
		10.93- 03.99	CA733IR	14 70		05.91- 04.95	CS713	12 1.8	
		10.93- 03.99	CA740IR	14 90					
		AC 05.91- 10.93	CA1058IR	14 90					
		AC 10.93- 03.99	CA736IR	14 90					
Toledo 1.9 SDi	[AQM]	11.99- 06.04	CA1394IR	14 120		11.99- 06.04	CS789	12 1.8	
		11.99- 06.04	CA1446IR	14 90					
		11.99- 06.04	CA1502IR	14 70					
Toledo 1.9 TD	[AAZ]	05.91- 10.93	CA302IR	14 65		05.91- 07.94	CS713	12 1.8	
		10.93- 04.97	CA733IR	14 70		07.94- 04.97	CS789	12 1.8	
		10.93- 04.97	CA740IR	14 90					
		AC 05.91- 10.93	CA1058IR	14 90					
	AC 10.93- 04.97	CA736IR	14 90						
Toledo 1.9 TDi	[1Z]	04.95- 10.98	CA1260IR	14 120		11.94- 10.98	CS616	12 1.8	
						11.94- 10.98	CS974	12 1.8	
	[AFN]	11.96- 03.99	CA1089IR	14 120		11.96- 03.99	CS974	12 1.8	
		11.96- 03.99	CA1260IR	14 120					
		11.96- 06.98	CA1297IR	14 90					
		06.98- 03.99	CA1510IR	14 70					
	[AGR]	04.99- 05.06	CA1394IR	14 120		04.99- 05.06	CS974	12 1.8	
		04.99- 05.06	CA1446IR	14 90		AT 04.99- 05.06	CS789	12 1.8	
		04.99- 05.06	CA1502IR	14 70					
	[AHF]	04.99- 09.02	CA1394IR	14 120		AT 04.99- 09.02	CS789	12 1.8	
		04.99- 09.02	CA1446IR	14 90		04.99- 09.02	CS974	12 1.8	
		04.99- 09.02	CA1502IR	14 70					
	[AHU]	06.96- 10.98	CA1089IR	14 120		08.96- 10.98	CS616	12 1.8	
		06.96- 10.98	CA1260IR	14 120		08.96- 10.98	CS974	12 1.8	
		06.96- 10.98	CA1297IR	14 90					
		06.96- 10.98	CA1510IR	14 70					
	[ALH]	04.99- 05.06	CA1394IR	14 120		04.99- 05.06	CS974	12 1.8	
		04.99- 05.06	CA1446IR	14 90		AT 04.99- 05.06	CS789	12 1.8	
		04.99- 05.06	CA1502IR	14 70					
[ARL]	10.00- 05.06	CA1394IR	14 120		10.00- 05.06	CS1181	12 2.0		
	10.00- 05.06	CA1446IR	14 90						
[ASV]	05.99- 12.03	CA1394IR	14 120		05.99- 12.03	CS974	12 1.8		
	05.99- 12.03	CA1446IR	14 90		AT 05.99- 12.03	CS789	12 1.8		
	05.99- 12.03	CA1502IR	14 70						
[ASZ]	05.03- 05.06	CA1394IR	14 120		05.03- 05.06	CS1181	12 2.0		
	05.03- 05.06	CA1446IR	14 90						
[BJB]	10.04-	CA1782IR	14 140		10.04-	CS1293	12 2.0		
	10.04-	CA1810IR	14 110						
[BKC]	10.04-	CA1782IR	14 140		10.04-	CS1293	12 2.0		
	10.04-	CA1810IR	14 110						
[BLS]	10.05-	CA1782IR	14 140		10.05-	CS1293	12 2.0		
	10.05-	CA1810IR	14 110						
[BXE]	02.06-	CA1782IR	14 140		02.06-	CS1293	12 2.0		
	02.06-	CA1810IR	14 110		AT 02.06-	CS1286	12 2.0		
Toledo 2.0 FSi	[BLR]	10.04-	CA1782IR	14 140		10.04-	CS1294	12 1.1	
		10.04-	CA1818IR	14 110		AT 10.04-	CS1347	12 1.1	



	[BLV]	10.04-10.04-	CA1782IR	14 140		AT 10.04-10.04-	CS1347	12 1.1
			CA1818IR	14 110			CS1294	12 1.1
	[BVV]	11.05-11.05-	CA1782IR	14 140		AT 11.05-11.05-	CS1347	12 1.1
			CA1818IR	14 110			CS1294	12 1.1
	[BVZ]	11.05-05.06	CA1782IR	14 140		AT 11.05-05.06	CS1347	12 1.1
		11.05-05.06	CA1818IR	14 110		11.05-05.06	CS1294	12 1.1
Toledo 2.0 116V	[ABF]	03.94-03.94-	CA736IR	14 90		03.94-03.94-	CS619	12 1.1
		10.98-10.98-	CA827IR	14 70				
Toledo 2.0 i	[2E]	05.91-05.91-	CA298IR	14 65		05.91-06.96	CS618	12 1.1
		10.93-10.93-	CA320IR	14 90				
		06.96-10.93-	CA733IR	14 70				
		06.96-10.93-	CA740IR	14 90				
		AC 06.96-	CA736IR	14 90				
	[AGG]	03.96-03.96-	CA733IR	14 70		03.96-03.99	CS618	12 1.1
		10.98-10.98-	CA740IR	14 90				
		AC 03.96-	CA736IR	14 90				
Toledo 2.0 TFSi	[BWA]	11.05-11.05-	CA1782IR	14 140		11.05-02.06	CS1409	12 1.0
		02.06-11.05-	CA1818IR	14 110		02.06-6SP	CS1347	12 1.1
Toledo 2.0 TDi	[AZV]	09.04-09.04-	CA1782IR	14 140		09.04-AT	CS1323	12 2.0
			CA1810IR	14 110			CS1286	12 2.0
	[BKD]	10.04-10.04-	CA1782IR	14 140		10.04-AT	CS1323	12 2.0
			CA1810IR	14 110			CS1286	12 2.0
	[BMM]	01.06-01.06-	CA1782IR	14 140		01.06-AT	CS1286	12 2.0
			CA1810IR	14 110		01.06-6SP	CS1323	12 2.0
	[BMN]	01.06-01.06-	CA1782IR	14 140		01.06-	CS1323	12 2.0
			CA1810IR	14 110				
Toledo 2.3 V5	[AGZ]	10.98-10.98-	CA1394IR	14 120		10.98-11.00	CS789	12 1.8
		11.00-10.98-	CA1446IR	14 90		11.00-10.98-	CS1266	12 1.8
		11.00-10.98-	CA1502IR	14 70				
	[AQN]	05.01-05.01-	CA1394IR	14 120		05.01-05.06	CS1266	12 1.8
			CA1446IR	14 90		05.01-05.06	CS789	12 1.8
		05.01-05.06	CA1502IR	14 70				
<b>PASSENGER CARS AO</b>								
Cordoba 1.4		PS 12.97-	CA736IR	14 90		12.97-04.99	CS788	12 0.9
		04.99-PS	CA827IR	14 70		12.97-04.99	CS880	12 1.1
		12.97-	CA733IR	14 70				
		04.99-12.97-	CA740IR	14 90				
Ibiza 2.0	[AZL]	04.02-04.02-	CA1378IR	14 90		04.02-04.04	CS1119	12 1.1 BO
			CA1436IR	14 70		04.02-04.04	CS1324	12 1.0 VA
Toledo 1.8 GT	[KR]	05.91-05.91-	CA342IR	14 65		05.91-11.92	CS294	12 0.9
		11.92-05.91-	CA343IR	14 90				
<b>Seddon</b>								
<b>TRUCKS EU</b>								
Strato						01.93-01.95	US1245#	24 4.5
<b>Setra</b>								
<b>TRUCKS EU</b>								
S 200 16.0		01.73-	CA824IR	28 120				
S 208 5.7		01.79-	CA824IR	28 120				
S 210 11.0		01.83-	CA824IR	28 120				
S 215 HD 12.8	[OM402.925]	01.77-	CA824IR	28 120				
S 300 12.0	[D2866OH]	01.89-	CA1235IR	28 120				
S 313 12.0		09.91-02.02	CA1236IR	28 140				
S 315 12.0		09.91-02.02	CA1236IR	28 140				
S 315 14.6		09.91-02.02	CA1236IR	28 140		09.91-02.02	CS191	24 5.4
S 317 14.6		09.91-02.02	CA1236IR	28 140				
S 321 12.0		09.91-02.02	CA1236IR	28 140				
S 328 14.6		09.91-02.02	CA1236IR	28 140				
<b>Skoda</b>								
<b>PASSENGER CARS EU</b>								
Fabia 1.0	[AQV]	09.99-09.99-	CA1394IR	14 120	▲	09.99-08.02	CS1204	12 1.0
		08.02-09.99-	CA1542IR	14 90				
		08.02-09.99-	CA1586IR	14 70				
	[ARV]	12.99-12.99-	CA1394IR	14 120	▲	12.99-12.04	CS1204	12 1.0
			CA1542IR	14 90				
		12.99-12.04	CA1586IR	14 70				
	[ATY]	12.99-12.99-	CA1394IR	14 120	▲	12.99-08.02	CS1204	12 1.0
		08.02-12.99-	CA1542IR	14 90				
Fabia 1.2	[AWY]	08.02-08.02-	CA1675IR	14 90		07.01-05.04	CS1282	12 0.9
		05.04-08.02-	CA1755IR	14 70				
		Chas. 6Y-3-765553-07.01-	CA1675IR	14 90				
		05.04-07.01-	CA1755IR	14 70				
		Chas. 6Y-3-765552-07.01-	CA1675IR	14 90	▲			
		05.04-07.01-	CA1755IR	14 70	▲			
	[AZQ]	Chas. 6Y-3-765553-01.03-	CA1675IR	14 90		01.03-11.04	CS1282	12 0.9
		11.04-01.03-	CA1755IR	14 70				
		Chas. 6Y-3-765552-01.03-	CA1675IR	14 90	▲			
		11.04-01.03-	CA1755IR	14 70	▲			
	[BBM]	03.07-03.07-	CA1675IR	14 90		03.07-	CS1330	12 1.0
			CA1755IR	14 70				
	[BMD]	08.02-08.02-	CA1675IR	14 90		Chas. 6Y..5..240000-08.02-	CS1282	12 0.9
		04.07-08.02-	CA1755IR	14 70		04.07-11.04-	CS1330	12 1.0
		Chas. 6Y-3-765553-05.04-	CA1675IR	14 90		04.07-05.04-		
		04.07-05.04-	CA1755IR	14 70				
		Chas. 6Y-3-765552-05.04-	CA1675IR	14 90	▲			
		04.07-05.04-	CA1755IR	14 70	▲			
	[BME]	11.04-11.04-	CA1675IR	14 90		03.03-04.07	CS1282	12 0.9
		04.07-11.04-	CA1755IR	14 70				
		Chas. 6Y-3-765553-03.03-	CA1675IR	14 90				
		03.03-03.03-	CA1755IR	14 70				
		Chas. 6Y-3-765552-03.03-	CA1675IR	14 90	▲			
		03.03-03.03-	CA1755IR	14 70	▲			
	[BZG]	03.07-03.07-	CA1675IR	14 90		03.07-	CS1330	12 1.0
			CA1755IR	14 70				
	[CEVA]	03.07-03.07-	CA1675IR	14 90		03.07-	CS1330	12 1.0
			CA1755IR	14 70				
Fabia 1.2 Praktik	[AWY]	08.02-08.02-	CA1675IR	14 90		08.02-05.04	CS1282	12 0.9
		05.04-08.02-	CA1755IR	14 70				
	[BMD]	05.04-05.04-	CA1675IR	14 90		Chas. 6Y..5..240001-11.04-	CS1330	12 1.0
			CA1755IR	14 70		05.04-10.04	CS1282	12 0.9
Fabia 1.2 16V	[CGPB]	11.11-11.11-	CA1675IR	14 90		11.11-	CS1330	12 1.0
			CA1755IR	14 70				
Fabia 1.2 TSi	[CBZA]					03.10-	CS1330	12 1.0
	[CBZB]					AT 03.10-	CS1470	12 1.1
						03.10-	CS1330	12 1.0



**SKODA Continued**

Fabia 1.2 TDi	[CFWA]				A25 05.10-	CS1505*	12 2.0
Fabia 1.4	[AME]	09.99- 05.03 CA1394IR	14 120 ▲		09.99- 05.03	CS1204	12 1.0
		09.99- 05.03 CA1542IR	14 90				
		09.99- 05.03 CA1586IR	14 70				
	[AQW]	12.99- 05.03 CA1394IR	14 120 ▲		12.99- 05.03	CS1204	12 1.0
		12.99- 05.03 CA1542IR	14 90				
		12.99- 05.03 CA1586IR	14 70				
	[ATZ]	09.99- 01.01 CA1394IR	14 120 ▲		09.99- 01.01	CS1204	12 1.0
		09.99- 01.01 CA1542IR	14 90				
		12.99- 01.01 CA1586IR	14 70				
	[AZE]	09.99- 03.03 CA1394IR	14 120		09.99- 03.03	CS1204	12 1.0
		09.99- 03.03 CA1542IR	14 90				
		09.99- 03.03 CA1586IR	14 70				
	[AZF]	12.99- 03.03 CA1394IR	14 120		12.99- 03.03	CS1204	12 1.0
		12.99- 03.03 CA1542IR	14 90				
		12.99- 03.03 CA1586IR	14 70				
	[BUD]	02.06- 10.06 CA1560IR	14 90		02.06- 10.06	CS1330	12 1.0
		02.06- 10.06 CA1568IR	14 70				
		AC 02.06- 10.06 CA1542IR	14 90				
		AC 02.06- 10.06 CA1729IR	14 110				
	[BXW]	03.07- CA1560IR	14 90		03.07-	CS1330	12 1.0
03.07- CA1568IR		14 70					
AC 03.07- CA1542IR		14 90					
Fabia 1.4 Praktik	[AME]	09.99- 05.03 CA1394IR	14 120		09.99- 05.03	CS1204	12 1.0
		09.99- 05.03 CA1542IR	14 90				
		09.99- 05.03 CA1586IR	14 70				
	[AQW]	12.99- 05.03 CA1394IR	14 120		12.99- 05.03	CS1204	12 1.0
		12.99- 05.03 CA1542IR	14 90				
		12.99- 05.03 CA1586IR	14 70				
	[ATZ]	09.99- 01.01 CA1394IR	14 120		09.99- 01.01	CS1204	12 1.0
		09.99- 01.01 CA1542IR	14 90				
		09.99- 01.01 CA1586IR	14 70				
	Fabia 1.4 16V	[AUA]	10.01- 08.03 CA1568IR	14 70	Chas. -6Y..2..555 575 09.99- 05.02	CS1197	12 1.1
10.01- 08.03 CA1729IR			14 110	Chas. 6Y..2..555 576- 06.02- 08.03	CS1282	12 0.9	
09.99- 09.01 CA1512IR			14 90	AT 09.99- 08.03	CS1063	12 1.1	
09.99- 09.01 CA1566IR			14 70				
09.99- 09.01 CA1567IR			14 90				
Chas. 6Y-2-389396- 09.00- 08.03 CA1560IR			14 90				
Chas. 6Y-2-389396- 09.00- 08.03 CA1568IR			14 70				
Chas. 6Y-2-389396- 10.01- 08.03 CA1815IR#			14 110				
Chas. -6Y-2-389395 09.99- 08.03 CA1566IR			14 70				
Chas. -6Y-2-389395 09.99- 08.03 CA1567IR			14 90				
AC 09.00- 08.03 CA1729IR			14 110				
AC 10.01- 08.03 CA1542IR			14 90				
AC 09.99- 10.01 CA1512IR		14 90					
[AUB]		10.01- 09.03 CA1560IR	14 90		AT 09.99- 08.03	CS1063	12 1.1
		10.01- 09.03 CA1568IR	14 70		06.02- 08.03	CS1282	12 0.9
		09.99- 08.03 CA1566IR	14 70		09.99- 05.02	CS1197	12 1.1
		09.99- 08.03 CA1567IR	14 90				
		AC 10.01- 08.03 CA1542IR	14 90				
		AC 09.99- 08.03 CA1512IR	14 90				
[BBY]		09.00- 09.01 CA1512IR	14 90		09.00- 05.02	CS1197	12 1.1
		09.00- 09.01 CA1567IR	14 90		06.02- 05.04	CS1282	12 0.9
		09.00- 05.04 CA1729IR	14 110		AT 09.00- 05.04	CS1063	12 1.1
		10.01- 05.04 CA1542IR	14 90				
		10.01- 05.04 CA1560IR	14 90				
		10.01- 05.04 CA1568IR	14 70				
		Chas. 6Y-2-389396- 09.00- 05.04 CA1560IR	14 90				
		Chas. 6Y-2-389396- 09.00- 05.04 CA1568IR	14 70				
		Chas. -6Y-2-389395 09.00- 05.04 CA1566IR	14 70				
		Chas. -6Y-2-389395 09.00- 05.04 CA1567IR	14 90				
		AC 09.00- 10.01 CA1512IR	14 90				
		AC 10.01- 05.04 CA1542IR	14 90				
[BBZ]		03.00- 09.01 CA1566IR	14 70		06.02- 10.04	CS1282	12 0.9
		03.00- 09.01 CA1567IR	14 90		10.04- 04.07	CS1330	12 1.0
		10.01- 04.07 CA1560IR	14 90		09.99- 05.02	CS1197	12 1.1
		10.01- 04.07 CA1568IR	14 70				
		Chas. 6Y-2-389396- 10.01- CA1560IR	14 90				
		Chas. 6Y-2-389396- 10.01- CA1568IR	14 70				
		Chas. -6Y-2-389395 09.00- 09.01 CA1566IR	14 70				
	Chas. -6Y-2-389395 09.00- 09.01 CA1567IR	14 90					
	AC 03.00- 09.01 CA1512IR	14 90					
	AC 10.01- 04.07 CA1542IR	14 90					
[BKY]	09.00- 09.01 CA1512IR	14 90		09.00- 05.02	CS1197	12 1.1	
	09.00- 09.01 CA1567IR	14 90		AT 05.00- 10.04	CS1063	12 1.1	
	09.00- 04.07 CA1729IR	14 110		06.02- 10.04	CS1282	12 0.9	
	10.01- 05.04 CA1542IR	14 90		10.04- 04.07	CS1330	12 1.0	
	10.01- 04.07 CA1560IR	14 90					
	10.01- 04.07 CA1568IR	14 70					
	AC 05.04- 04.07 CA1542IR	14 90					
[BUD]	04.06- 12.07 CA1560IR	14 90		04.06- 12.07	CS1330	12 1.0	
	04.06- 12.07 CA1568IR	14 70					
	AC 04.06- 12.07 CA1542IR	14 90					
	AC 04.06- 12.07 CA1729IR	14 110					
Fabia 1.4 TSi	[CAVE]	05.10- CA1921IR	14 110				
		05.10- CA1985IR	14 140				
Fabia 1.4 TDi	[AMF]	05.03- CA1441IR	14 90	11.04-	CS1293	12 2.0	
		05.03- CA1644IR	14 120	05.03- 11.04	CS974	12 1.8	
		05.03- CA1682IR	14 70				
	[BMS]	03.07- CA1441IR	14 90		03.07-	CS1293	12 2.0
		03.07- CA1644IR	14 120				
		03.07- CA2064IR*	14 90				
		03.07- CA2065IR	14 110				
	[BNM]	10.05- 04.07 CA1441IR	14 90		10.05- 04.07	CS1393	12 1.7
		10.05- 04.07 CA1644IR	14 120				
		10.05- CA2064IR*	14 90				
		03.07- CA2065IR	14 110				
		10.07- CA1446IR	14 90				
	[BNV]	10.05- 04.07 CA1441IR	14 90		10.05- 04.07	CS1293	12 2.0
		10.05- 04.07 CA1644IR	14 120				
		10.05- CA2064IR*	14 90				
		03.07- CA2065IR	14 110				



Fabia 1.4 TDi Praktik	[BNM]	10.05-	CA1441IR	14 90	10.05-	CS1393	12 1.7	
		10.05-	CA1644IR	14 120				
		10.05-	CA2064IR*	14 90				
Fabia 1.6	[BTS]	03.07-	CA1817IR	14 110	03.07-	CS1330	12 1.0	
Fabia 1.6 TDi	[CAYA]	04.10-	CA1810IR	14 110	AT 04.10-	CS1480*	12 1.8	
					A25 04.10-	CS1505*	12 2.0	
					AT 03.10-	CS1480*	12 1.8	
	[CAYB]	03.10-	CA1782IR	14 140	AT 03.10-	CS1480*	12 1.8	
		03.10-	CA1810IR	14 110	A25 03.10-	CS1505*	12 2.0	
		A25 03.10-	CA2011IR	14 140				
	[CAYC]	03.10-	CA1782IR	14 140	A25 03.10-	CS1505*	12 2.0	
		03.10-	CA1810IR	14 110	AT 03.10-	CS1480*	12 1.8	
		A25 03.10-	CA2011IR	14 140				
Fabia 1.9 SDi	[ASY]	09.99- 04.07	CA1394IR	14 120	Chas. -6Y-5-240000 09.99- 11.04	CS1200	12 2.0	
		09.99-	CA1446IR	14 90	Chas. 6Y-5-240001- 11.04- 04.07	CS1393	12 1.7	
		09.99- 04.07	CA1502IR	14 70				
		AC 09.99- 04.07	CA1446IR	14 90				
Fabia 1.9 TDi	[ATD]	09.99- 04.07	CA1394IR	14 120	09.99- 10.05	CS974	12 1.8	
		09.99- 04.07	CA1502IR	14 70	11.04- 04.07	CS1293	12 2.0	
		AC 09.99- 04.07	CA1446IR	14 90				
	[AXR]	08.00- 12.07	CA1394IR	14 120	10.05- 12.07	CS1293	12 2.0	
		08.00- 12.07	CA1502IR	14 70	08.00- 12.07	CS974	12 1.8	
		AC 08.00- 12.07	CA1446IR	14 90				
	[BLS]	03.07-	CA1502IR	14 70	03.07-	CS1293	12 2.0	
		03.07-	CA2065IR	14 110				
		10.07-	CA1394IR	14 120				
		10.07-	CA1446IR	14 90				
		AC 03.07-	CA1394IR	14 120				
	[BSW]	10.07-	CA1394IR	14 120	10.07-	CS1293	12 2.0	
		10.07-	CA1446IR	14 90				
10.07-		CA1502IR	14 70					
AC 10.07-		CA1394IR	14 120					
Fabia 1.9 TDi RS	[ASZ]	06.03- 10.05	CA1394IR	14 120	06.03- 10.05	CS1181	12 2.0	
		06.03- 10.05	CA1446IR	14 90				
		06.03- 10.05	CA1502IR	14 70				
	[BLT]	10.05- 04.07	CA1394IR	14 120	10.05- 04.07	CS1181	12 2.0	
		10.05- 04.07	CA1446IR	14 90				
		10.05- 04.07	CA1502IR	14 70				
Fabia 2.0	[AQY]	06.99- 03.02	CA1378IR	14 90	AT 06.99- 03.02	CS1062	12 1.1	
		06.99- 03.02	CA1394IR	14 120	06.99- 03.02	CS1119	12 1.1	
		06.99- 03.02	CA1436IR	14 70				
	[AZL]	07.00- 04.07	CA1378IR	14 90	10.04-	CS1324	12 1.0	
		07.00- 04.07	CA1436IR	14 70	07.00- 10.04	CS1475	12 1.1	
Favorit 1.3	[135B]	12.92- 12.98	CA1455IR	14 70 ▲	12.92- 12.98	CS798	12 1.0	
		12.92- 12.98	CA589IR	14 55	12.92- 12.98	CS561	12 0.8	
	[136B]	12.92- 12.98	CA1455IR	14 70 ▲	12.92- 12.98	CS798	12 1.0	
		12.92- 12.98	CA589IR	14 55	12.92- 12.98	CS561	12 0.8	
	[136L]	09.88- 09.94	CA589IR	14 55	09.88- 09.94	CS561	12 0.8	
		10.90- 09.94	CA850IR	14 55	10.90- 09.94	CS798	12 1.0	
	[781.135]	09.88- 12.97	CA589IR	14 55	09.88- 12.97	CS561	12 0.8	
		10.90- 12.97	CA1455IR	14 70 ▲	09.88- 12.97	CS798	12 1.0	
		12.91- 09.94	CA850IR	14 55				
	[781.135E]	09.88- 09.94	CA589IR	14 55	09.88- 09.94	CS561	12 0.8	
		01.90- 09.94	CA1455IR	14 70 ▲	01.90- 09.94	CS798	12 1.0	
	[OHV]	09.88- 09.94	CA1455IR	14 70 ▲	09.88- 09.94	CS561	12 0.8	
09.88- 09.94		CA589IR	14 55	09.88- 09.94	CS798	12 1.0		
		06.92- 09.93	CA1455IR	14 70	06.92- 09.93	CS561	12 0.8	
		06.92- 09.93	CA589IR	14 55	06.92- 09.93	CS798	12 1.0	
Felicia 1.3	[AMJ]	08.95- 03.98	CA1455IR	14 70	10.94- 06.01	CS798	12 1.0	
		08.95- 03.98	CA850IR	14 55				
		03.98- 06.01	CA1093IR	14 70				
		ACPS 10.94- 03.98	CA1626IR	14 90				
	[135B]	10.94- 12.98	CA1455IR	14 70 ▲	10.94- 12.98	CS798	12 1.0	
		10.94- 12.98	CA850IR	14 55				
		ACPS 10.94- 12.98	CA1626IR	14 90				
	[135L]	10.94- 03.98	CA1455IR	14 70	10.94- 03.98	CS798	12 1.0	
		10.94- 03.98	CA850IR	14 55				
		ACPS 10.94- 03.98	CA1626IR	14 90				
	[136B]	10.94- 12.98	CA1455IR	14 70 ▲	10.94- 12.98	CS798	12 1.0	
		10.94- 12.98	CA850IR	14 55				
		ACPS 10.94- 12.98	CA1626IR	14 90				
	[AMG]	08.96- 03.01	CA1093IR	14 70	08.96- 03.01	CS798	12 1.0	
PS 08.96- 12.98		CA1626IR	14 90					
ACPS 03.98- 03.01		CA1626IR	14 90					
[AMH]	08.96- 06.01	CA1093IR	14 70	08.96- 03.01	CS561	12 0.8		
	ACPS 08.96- 06.01	CA1626IR	14 90	08.96- 06.01	CS798	12 1.0		
Felicia 1.3 Fun	[135B]	06.97-	CA1455IR	14 70	06.97-	CS798	12 1.0	
		06.97-	CA850IR	14 55				
		ACPS 06.97-	CA1626IR	14 90				
	[135M]	06.97-	CA1455IR	14 70	06.97-	CS798	12 1.0	
		06.97-	CA850IR	14 55				
		ACPS 06.97-	CA1626IR	14 90				
	[136B]	06.97- 03.01	CA1455IR	14 70	06.97- 03.01	CS798	12 1.0	
		06.97- 03.01	CA850IR	14 55				
		ACPS 06.97- 03.01	CA1626IR	14 90				
	[136M]	06.97- 03.01	CA1455IR	14 70	06.97- 03.01	CS798	12 1.0	
		06.97- 03.01	CA1626IR	14 90				
		06.97- 03.01	CA850IR	14 55				
	Felicia 1.3 LX	[135B]	11.94- 12.98	CA1455IR	14 70 ▲	11.94- 12.98	CS798	12 1.0
			11.94- 12.98	CA850IR	14 55			
			ACPS 11.94- 12.98	CA1626IR	14 90			
[AMG]		08.96- 12.98	CA1455IR	14 70 ▲	08.96- 12.98	CS798	12 1.0	
		08.96- 12.98	CA850IR	14 55				
ACPS 08.96- 12.98	CA1626IR	14 90						
Felicia 1.3 LXi	[136B]	11.94- 12.98	CA1455IR	14 70 ▲	11.94- 12.98	CS798	12 1.0	
		11.94- 12.98	CA850IR	14 55				
		ACPS 11.94- 12.98	CA1626IR	14 90				
	[AMH]	08.96- 12.98	CA1093IR	14 70	08.96- 12.98	CS798	12 1.0	
		ACPS 08.96- 12.98	CA1626IR	14 90				
Felicia 1.6	[AEE]	05.95- 08.01	CA733IR	14 70	06.95- 08.01	CS798	12 1.0	
		01.98- 08.01	CA1240IR	14 90				
		PS 05.95- 08.01	CA827IR	14 70				
		PS 06.97- 08.01	CA1240IR	14 90				
		PS 06.97- 08.01	CA1267IR	14 70				
		AC 05.95- 08.01	CA736IR	14 90				



**SKODA Continued**

Felicia 1.6 GLX	[AEE]	05.95- 08.01	CA733IR	14 70	06.95- 08.01	CS798	12 1.0	
		PS 05.95- 08.01	CA1240IR	14 90				
		PS 05.95- 08.01	CA1267IR	14 70				
		AC 05.95- 08.01	CA736IR	14 90				
Felicia 1.6 LX	[AEE]	08.95- 08.01	CA733IR	14 70	08.95- 08.01	CS798	12 1.0	
		PS 08.95- 08.01	CA1240IR	14 90				
		PS 08.95- 08.01	CA1267IR	14 70				
		AC 08.95- 08.01	CA736IR	14 90				
Felicia 1.9 Diesel	[AEF]	05.96- 08.01	CA1226IR	14 90	05.96- 08.01	CS1047	12 1.8	
		05.96- 08.01	CA1255IR	14 70				
		05.96- 08.01	CA829IR	14 90				
Forman 1.3	[781.135]	12.91- 12.95	CA589IR	14 55	12.91- 12.95	CS561	12 0.8	
		03.93- 12.95	CA850IR	14 55				
	[781.135E]	12.92- 12.95	CA589IR	14 55	12.92- 12.95	CS561	12 0.8	
		03.93- 12.95	CA850IR	14 55				
	[OHC]	08.91- 12.95	CA589IR	14 55	08.91- 12.95	CS561	12 0.8	
		03.93- 12.95	CA850IR	14 55				
Octavia 1.2 TSi	[CBZB]				02.10-	CS1322	12 1.1	
Octavia 1.4	[AMD]	04.99- 03.01	CA1560IR	14 90	04.99- 03.01	CS1204	12 1.0	
		04.99- 03.01	CA1568IR	14 70				
		AC 04.99- 03.01	CA1504IR	14 70				
	[AXP]	08.00- 01.02	CA1511IR	14 70	Chas. 1U-2-530145-, 1U-28530071- 08.00- 01.02	CS1343	12 0.9	
		08.00- 01.02	CA1512IR	14 90				Chas. -1U-2-530144-, -1U-28530070 08.00- 01.02
		AC 08.00- 01.02	CA1378IR	14 90				
	[BCA]	01.02- 01.04	CA1511IR	14 70	01.02- 05.06	CS1343	12 0.9	
		01.02- 01.04	CA1512IR	14 90				
		02.04-	CA1567IR	14 90				
		05.04- 05.06	CA1560IR	14 90				
		05.04- 05.06	CA1815IR#	14 110				
		AC 06.04-	CA1729IR	14 110				
	[BUD]	05.06-	CA1560IR	14 90	05.06-	CS1330	12 1.0	
	05.06-	CA1815IR#	14 110					
	AC 05.06-	CA1729IR	14 110					
Octavia 1.4 16V	[AXP]	09.00-	CA1511IR	14 70	Chas. 1U-2-530145-, 1U-28530071- 09.00-	CS1343	12 0.9	
		09.00-	CA1512IR	14 90				Chas. -1U-2-530144-, -1U-28530070 09.00-
		AC 09.00-	CA1378IR	14 90				
[BCA]	01.02- 01.04	CA1511IR	14 70	09.00- 01.02-	CS1062	12 1.1		
	01.02- 01.04	CA1512IR	14 90					
	02.04-	CA1567IR	14 90					
Octavia 1.4 TSi	[CAXA]	11.08-	CA1985IR	14 140	AT 11.08- 11.08-	CS1470	12 1.1	
		11.08-	CA2056IR*	14 110				
		AC 11.08-	CA1921IR	14 110				
Octavia 1.6	[AEE]	Chas. 1U-W-113661- 07.98-	CA1511IR	14 70	Chas. 1U-3-704907-, 1U-3A006980-, 1U-38677465- 09.02- 09.06-	CS1343	12 0.9	
		Chas. 1U-W-113661- 07.98-	CA1512IR	14 90				09.96- 09.00-
		Chas. -1U-W-113660 07.98-	CA1240IR	14 90				Chas. -1U-3-704906-, -1U-3A006980-, -1U-38677465 09.96- 08.02
		Chas. -1U-W-113660 07.98-	CA1241IR	14 120				
		Chas. -1U-W-113660 07.98-	CA1267IR	14 70				
		Chas. -1U-42908054, 09.96- 01.04	CA1511IR	14 70				
		-1U-4A020052, -1U-48748256						
		Chas. -1U-42908054, 09.96- 01.04	CA1512IR	14 90				
		-1U-4A020052, -1U-48748256						
	[AEH]	02.97- 09.04	CA1378IR	14 90	Chas. -1U-3-704906-, 1U-3A006980-, -1U-38677465 02.97- 08.02	CS618	12 1.1	
		02.97- 09.04	CA1394IR	14 120				
		06.98-	CA1436IR	14 70				Chas. 1U-3-704907-, 1U-3A006980-, 1U-38677465- 09.02- 09.04
			Chas. -1U-4208 054, 02.97- 01.04	CA1436IR	14 70			
			1U-4A020 052, -1U-48748 256					
	[AKL]	04.97-	CA1378IR	14 90	Chas. -1U-3-704906-, 1U-3A006980-, -1U-38677465 04.97- 08.02	CS1062	12 1.1	
		04.97-	CA1394IR	14 120	Chas. 1U-3-704907-, 1U-3A006980-, 1U-38677465- 09.02-	CS1343	12 0.9	
	04.97- 01.04	CA1436IR	14 70					
[AVU]	08.00- 04.02	CA1549IR	14 120	Chas. -1U-3-704906-, 1U-3A006980-, -1U-38677465- 08.00- 04.02	CS1062	12 1.1		
	08.00- 04.02	CA1587IR	14 90	Chas. 1U-3-704907-, 1U-3A006980-, 1U-38677465- 08.00- 04.02	CS1343	12 0.9		
	09.00- 04.02	CA1378IR	14 90					
	09.00- 04.02	CA1394IR	14 120					
	09.00- 04.02	CA1436IR	14 70					
[BFQ]	08.00-	CA1378IR	14 90	Chas. -1U-3-704906-, 1U-3A006980-, -1U-38677465- 08.00- 08.02	CS1062	12 1.1		
	08.00-	CA1394IR	14 120	Chas. 1U-3-704907-, 1U-3A006980-, 1U-38677465- 09.02-	CS1343	12 0.9		
	08.00- 01.04	CA1436IR	14 70					
	08.00-	CA1549IR	14 120					
	08.00-	CA1587IR	14 90					
[BGU]	06.04-	CA1378IR	14 90	AT 06.04- 5SP 06.04-	CS1347	12 1.1		
06.04-	CA1782IR	14 140						
06.04-	CA1818IR	14 110						
[BSE]	06.04-	CA1378IR	14 90	5SP 06.04-	CS1324	12 1.0		
	06.04-	CA1782IR	14 140	AT 06.04-	CS1347	12 1.1		
	06.04-	CA1818IR	14 110					
[BSF]	06.04-	CA1378IR	14 90	5SP 06.04- AT 06.04-	CS1324	12 1.0		
06.04-	CA1782IR	14 140						
06.04-	CA1818IR	14 110						





	[CCSA]	06.04-06.04-06.04	CA1378IR CA1782IR CA1818IR	14 90 14 140 14 110		AT 06.04-5SP 06.04	CS1347 CS1324	12 1.1 12 1.0	
Octavia 1.6 FSi	[BLF]	06.04	CA1817IR	14 110		06.04-4x4, 6SP 06.04-AT 06.04	CS1330 CS1294 CS1347	12 1.0 12 1.1 12 1.1	
Octavia 1.6	[CCSA]	01.08-	CA1782IR	14 140		01.08-	CS1324	12 1.0	
Octavia 1.6 LPG	[CHGA]	08.09-08.09	CA1378IR CA1818IR	14 90 14 110		08.09-	CS1324	12 1.0	
Octavia 1.6 TDi	[CAYC]	06.09-11.09	CA1782IR CA1810IR	14 140 14 110		AT 06.09-A25 06.09-	CS1480* CS1505*	12 1.8 12 2.0	
Octavia 1.6 TDi 4x4	[CAYC]	06.09-06.09	CA1782IR CA1810IR	14 140 14 110		AT 06.09-	CS1480*	12 1.8	
Octavia 1.8	[AGN]	09.96-06.98 09.96-06.98 06.98-04.99 06.98-04.99	CA1240IR CA1267IR CA1378IR CA1436IR	14 90 14 70 14 90 14 70		09.96-04.98-AT 09.96-04.99 05.98-04.99	CS619 CS1062 CS1119	12 1.1 12 1.1 12 1.1	
Octavia 1.8 20V	[AGN]	10.96-06.98 10.96-06.98 07.98-04.99 07.98-04.99	CA1240IR CA1267IR CA1378IR CA1436IR	14 90 14 70 14 90 14 70		AT 05.98-04.99 10.96-04.98 05.98-04.99	CS1062 CS619 CS1119	12 1.1 12 1.1 12 1.1	
Octavia 1.8 TSi	[BZB] [CDAB] [CDA]	06.07-03.09-11.08	CA1811IR CA1811IR CA1811IR	14 140 14 140 14 140		06.07-03.09-11.08-AT 11.08-06.10	CS1294 CS1294 CS1347 CS1470	12 1.1 12 1.1 12 1.1 12 1.1	
Octavia 1.8 TSi 4x4	[CDAB]	03.09-	CA1811IR	14 140		03.09-	CS1347	12 1.1	
Octavia 1.8 Turbo 20V RS	[AUQ]	08.00-09.04 08.00-09.04 08.00-01.04	CA1378IR CA1394IR CA1436IR	14 90 14 120 14 70		5SP 08.00-09.04-AT 08.00-09.04	CS1181 CS1119	12 2.0 12 1.1	
Octavia 1.8 Turbo	[AGU]	08.97-08.97-08.97	CA1378IR CA1394IR CA1436IR	14 90 14 120 14 70		AT 08.97-08.97-08.97-03.98-05.01-08.00-01.06	CS1062 CS1119 CS618 CS619 CS1181	12 1.1 12 1.1 12 1.1 12 1.1 12 2.0	
	[ARX]	08.00-01.06 08.00-01.06 08.00-01.06	CA1378IR CA1394IR CA1436IR	14 90 14 120 14 70		08.00-01.06	CS1337 CS1119	12 1.1 12 1.1	
	[ARZ]	01.00-07.00 01.00-07.00	CA1378IR CA1436IR	14 90 14 70		01.00-07.00	CS1119	12 1.1	
	[AUM]	08.00-08.00-08.00-01.04	CA1378IR CA1394IR CA1436IR	14 90 14 120 14 70		08.00-05.01-08.00-AT 08.00-	CS1337 CS1181 CS1119 CS1062	12 1.1 12 2.0 12 1.1 12 1.1	
Octavia 1.8 Turbo 4x4	[AGU]	08.00-09.04 08.00-09.04 08.00-09.04	CA1378IR CA1394IR CA1436IR	14 90 14 120 14 70		08.00-09.04-AT 08.00-09.04	CS1119 CS1062	12 1.1 12 1.1	
	[ARX]	08.00-09.04 08.00-09.04 08.00-09.04	CA1378IR CA1394IR CA1436IR	14 90 14 120 14 70		08.00-09.04	CS1119	12 1.1	
	[AUM]	08.00-09.04 08.00-09.04 08.00-09.04	CA1378IR CA1394IR CA1436IR	14 90 14 120 14 70		08.00-09.04-AT 08.00-09.04	CS1119 CS1062	12 1.1 12 1.1	
Octavia 1.8 Turbo RS	[AUQ]	01.03-09.04 01.03-09.04 01.03-09.04	CA1378IR CA1394IR CA1436IR	14 90 14 120 14 70		01.03-09.04	CS1119	12 1.1	
Octavia 1.9 SDi	[AGP]	05.97-06.98 05.97-06.98 07.98-07.00 07.98-07.00 07.98-07.00 Chas. 1UW113661-06.98-07.00 Chas. 1UW113661-06.98-07.00 Chas. 1UW113661-06.98-07.00 Chas. -1UW113660 06.97-06.98 Chas. -1UW113660 06.97-06.98	CA1144IR CA1570IR CA1394IR CA1446IR CA1502IR CA1394IR CA1446IR CA1502IR CA1144IR CA1570IR	14 120 14 90 14 120 14 90 14 70 14 120 14 90 14 70 14 120 14 90			05.97-07.00	CS789	12 1.8
	[AQM]	08.00-12.03 08.00-12.03 08.00-12.03	CA1394IR CA1446IR CA1502IR	14 120 HI 14 90 14 70		11.01-12.03 08.00-10.01	CS618 CS789	12 1.1 12 1.8	
Octavia 1.9 TDi	[AGR]	08.00-08.00-09.96-09.99 10.99-	CA1446IR CA1502IR CA1144IR CA1394IR	14 90 14 70 14 120 14 120		AT 09.96-10.01 09.96-AT 11.01-	CS789 CS974 CS618	12 1.8 12 1.8 12 1.1	
	[AHF]	08.97-01.06 08.97-01.06 08.97-01.06	CA1394IR CA1446IR CA1502IR	14 120 14 90 14 70		AT 11.01-01.06 08.97-01.06 AT 08.97-10.01	CS618 CS974 CS789	12 1.1 12 1.8 12 1.8	
	[ALH]	08.00-08.00-08.00-	CA1394IR CA1446IR CA1502IR	14 120 14 90 14 70		AT 08.00-10.01 08.00-AT 11.01-	CS789 CS974 CS618	12 1.8 12 1.8 12 1.1	
	[ASV]	08.00-01.06 08.00-01.06 08.00-01.06	CA1394IR CA1446IR CA1502IR	14 120 14 90 14 70		AT 11.01-01.06 08.00-01.06 AT 08.00-10.01	CS618 CS974 CS789	12 1.1 12 1.8 12 1.8	
	[ASZ]	01.03-09.04 01.03-09.04 01.03-09.04	CA1394IR CA1446IR CA1502IR	14 120 14 90 14 70		01.03-09.04	CS1181	12 2.0	
	[ATD]	08.00-01.06 08.00-01.06 08.00-01.06	CA1394IR CA1446IR CA1502IR	14 120 14 90 14 70		08.00-01.06 08.00-01.06	CS1181 CS974	12 2.0 12 1.8	
	[AXR]	08.00-08.00-08.00-	CA1394IR CA1446IR CA1502IR	14 120 14 90 14 70		08.00-	CS974	12 1.8	
	[BJB]	05.04-05.04-	CA1782IR CA1810IR	14 140 14 110		05.04-6SP 06.04-AT 05.04-	CS1293 CS1323 CS1286	12 2.0 12 2.0 12 2.0	
	[BKC]	06.04-02.06 06.04-02.06	CA1782IR CA1810IR	14 140 14 110		AT 06.04-02.06 06.04-02.06-6SP 06.04-	CS1286 CS1293 CS1323	12 2.0 12 2.0 12 2.0	
	[BLS]	06.04-06.04-	CA1782IR CA1810IR	14 140 14 110		06.04-6SP 06.04-AT 06.04-04.07-	CS1293 CS1323 CS1286 CS1286	12 2.0 12 2.0 12 2.0 12 2.0	
	[BXE]	03.06-03.06-	CA1782IR CA1810IR	14 140 14 110		03.06-6SP 03.06-AT 03.06-03.06-	CS1293 CS1323 CS1286 CS1286	12 2.0 12 2.0 12 2.0 12 2.0	

**SKODA Continued**

Octavia 1.9 TDi 4x4	[AGR]	08.00-	CA1394IR	14 120	AT 08.00-	10.01	CS789	12 1.8	
		08.00-	CA1446IR	14 90	AT 11.01-		CS713	12 1.8	
		08.00-	CA1502IR	14 70	08.00-		CS974	12 1.8	
	[ATD]	09.00- 01.06	CA1394IR	14 120	6SP 09.00- 01.06		CS1119	12 1.1	
		09.00- 01.06	CA1446IR	14 90	09.00- 01.06		CS974	12 1.8	
		09.00- 01.06	CA1502IR	14 70	09.00- 01.06		CS1181	12 2.0	
	[BKC]	11.04-	CA1782IR	14 140	AT 11.04-		CS1286	12 2.0	
		11.04-	CA1810IR	14 110	11.04-		CS1293	12 2.0	
	[BLS]	05.06-	CA1782IR	14 140	6SP 11.04-		CS1323	12 2.0	
		05.06-	CA1810IR	14 110	05.06-		CS1293	12 2.0	
					05.06-		CS1323	12 2.0	
	[BXE]	03.06-	CA1782IR	14 140	05.06-		CS1286	12 2.0	
03.06-		CA1810IR	14 110	AT 03.06-		CS1286	12 2.0		
Octavia 2.0	[AEG]	08.00- 01.05	CA1378IR	14 90	08.00- 01.05		CS1119	12 1.1	
		08.00- 01.05	CA1394IR	14 120	AT 08.00- 01.05		CS1062	12 1.1	
		08.00- 01.04	CA1436IR	14 70					
		AC 08.00- 01.05	CA1378IR	14 90					
	[APK]	04.99-	CA1378IR	14 90	04.99-		CS1119	12 1.1	
		04.99-	CA1394IR	14 120	AT 04.99-		CS1062	12 1.1	
		04.99-	CA1436IR	14 70					
	[AQY]	04.99- 03.02	CA1378IR	14 90	AT 04.99- 03.02		CS1062	12 1.1	
		04.99- 03.02	CA1394IR	14 120	04.99- 03.02		CS1119	12 1.1	
		04.99- 03.02	CA1436IR	14 70					
	[ATF]	01.00-	CA1378IR	14 90	01.00-		CS1119	12 1.1	
		01.00-	CA1394IR	14 120					
		01.00-	CA1436IR	14 70					
	[AZH]	04.99-	CA1378IR	14 90	04.99- 09.04		CS1119	12 1.1	
		04.99-	CA1394IR	14 120					
04.99- 12.04		CA1436IR	14 70						
[AZJ]	04.99-	CA1378IR	14 90	04.99-		CS1119	12 1.1		
	04.99-	CA1394IR	14 120	AT 04.99-		CS1062	12 1.1		
	04.99-	CA1436IR	14 70						
Octavia 2.0 4x4	[AEG]	08.00- 01.05	CA1378IR	14 90	08.00- 01.05		CS1119	12 1.1	
		08.00- 01.05	CA1394IR	14 120	AT 08.00- 01.05		CS1062	12 1.1	
		08.00- 01.05	CA1436IR	14 70					
	[AQY]	08.00- 03.02	CA1378IR	14 90	08.00- 03.02		CS1119	12 1.1	
		08.00- 03.02	CA1394IR	14 120	AT 08.00- 03.02		CS1062	12 1.1	
		08.00- 03.02	CA1436IR	14 70					
	[AZH]	08.00- 09.04	CA1378IR	14 90	08.00- 09.04		CS1119	12 1.1	
		08.00- 09.04	CA1394IR	14 120					
		08.00- 09.04	CA1436IR	14 70					
	[AZJ]	03.02- 09.04	CA1378IR	14 90	AT 03.02- 09.04		CS1062	12 1.1	
		03.02- 09.04	CA1394IR	14 120	03.02- 09.04		CS1119	12 1.1	
		03.02- 09.04	CA1436IR	14 70					
Octavia 2.0 RS	[BWA]	10.05-	CA1782IR	14 140	10.05-		CS1347	12 1.1	
		10.05-	CA1818IR	14 110					
[CCZA]	01.06-	CA1782IR	14 140	01.06-		CS1347	12 1.1		
	01.06-	CA1818IR	14 110						
Octavia 2.0 FSi	[BLR]	11.04- 11.05	CA1782IR	14 140	AT 11.04- 11.05		CS1347	12 1.1	
		11.04- 11.05	CA1818IR	14 110	11.04- 11.05		CS1294	12 1.1	
	[BLY]	11.04- 11.05	CA1782IR	14 140	AT 11.04- 11.05		CS1347	12 1.1	
		11.04- 11.05	CA1818IR	14 110	11.04- 11.05		CS1294	12 1.1	
	[BVX]	11.05-	CA1782IR	14 140	11.05-		CS1294	12 1.1	
		11.05-	CA1818IR	14 110	AT 11.05-		CS1347	12 1.1	
	[BVY]	11.04-	CA1782IR	14 140	AT 11.04-		CS1347	12 1.1	
11.04-		CA1818IR	14 110	11.04-		CS1294	12 1.1		
[BVZ]	11.04-	CA1782IR	14 140	11.04-		CS1294	12 1.1		
	11.04-	CA1818IR	14 110	AT 11.04-		CS1347	12 1.1		
Octavia 2.0 FSi 4x4	[BLX]	11.04- 11.05	CA1782IR	14 140	AT 11.04- 11.05		CS1347	12 1.1	
		11.04- 11.05	CA1818IR	14 110	11.04- 11.05		CS1294	12 1.1	
	[BLY]	11.04- 11.05	CA1782IR	14 140	AT 11.04- 11.05		CS1294	12 1.1	
		11.04- 11.05	CA1818IR	14 110	AT 11.04- 11.05		CS1347	12 1.1	
	[BVX]	11.05-	CA1782IR	14 140	11.05-		CS1294	12 1.1	
Octavia 2.0 TDi 16V	[AZV]	02.04-	CA1782IR	14 140	02.04-		CS1323	12 2.0	
		02.04-	CA1810IR	14 110					
	[BKD]	06.04-	CA1782IR	14 140	AT 06.04-		CS1286	12 2.0	
		06.04-	CA1810IR	14 110	08.04-		CS1293	12 2.0	
Octavia 2.0 TDi 16V 4x4	[BMM]	05.04-	CA1782IR	14 140	5SP 05.04-		CS1286	12 2.0	
		05.04-	CA1810IR	14 110	6SP 05.04-		CS1323	12 2.0	
	Octavia 2.0 TDi	[BMM]	11.05-	CA1782IR	14 140	5SP 11.05-		CS1286	12 2.0
			11.05-	CA1810IR	14 110	6SP 11.05-		CS1323	12 2.0
		[BMN]	04.06-	CA1782IR	14 140	6SP 04.06-		CS1323	12 2.0
			04.06-	CA1810IR	14 110	5SP 04.06-		CS1286	12 2.0
		[CEGA]	04.06-	CA1782IR	14 140	5SP 04.06-		CS1286	12 2.0
			04.06-	CA1810IR	14 110	6SP 04.06-		CS1323	12 2.0
		[CFHF]	03.10-	CA1782IR	14 140	03.10-		CS1323	12 2.0
		[CLCA]	03.10-	CA1782IR	14 140	03.10-		CS1323	12 2.0
		Octavia 2.0 TDi 4x4	[CFHC]	05.10-	CA1782IR	14 140	05.10-		CS1323
[CFHF]			05.11-	CA1782IR	14 140	05.11-		CS1323	12 2.0 02M911024P
Praktik 1.2 TSi	[CBZA]				03.10-		CS1330	12 1.0	
					03.10-		CS1470	12 1.1	
Praktik 1.2 TDi	[CFWA]				A25 03.10-		CS1505*	12 2.0	
Roadster 1.2 TDi	[CFWA]				A25 03.10-		CS1505*	12 2.0	
Roomster 1.2	[BME]	09.06-	CA1675IR	14 90	09.06-		CS1330	12 1.0	
	[BZG]	01.07-	CA1675IR	14 90					
Roomster 1.2 TSi	[CBZA]				AT 03.10-		CS1470	12 1.1	
					03.10-		CS1330	12 1.0	
[CBZB]					AT 03.10-		CS1470	12 1.1	
					03.10-		CS1330	12 1.0	
Roomster 1.4	[BXW]	09.06-	CA1568IR	14 70	09.06-		CS1330	12 1.0	
		AC 09.06-	CA1542IR	14 90					
Roomster 1.4 TDi	[BMS]	09.06-	CA1441IR	14 90	09.06-		CS1293	12 2.0	
		09.06-	CA1644IR	14 120					
		09.06-	CA2064IR*	14 90					
		09.06-	CA2065IR	14 110					
	[BNM]	09.06-	CA1441IR	14 90	09.06-		CS1393	12 1.7	
		09.06-	CA1644IR	14 120					
		09.06-	CA2064IR*	14 90					
		09.06-	CA2065IR	14 110					



	[BNV]	09.06- 09.06- 09.06- 09.06-	CA1441IR CA1644IR CA2064IR* CA2065IR	14 90 14 120 14 90 14 110		09.06-	CS1293	12 2.0	
Roomster 1.6	[BTS]	09.06-	CA1817IR	14 110		09.06-	CS1330	12 1.0	
Roomster 1.6 TDi	[CAYB]	03.10-	CA1782IR	14 140		AT 03.10-	CS1480*	12 1.8	
		03.10- A25 03.10-	CA1810IR CA2011IR	14 110 14 140		A25 03.10-	CS1505*	12 2.0	
	[CAYC]	03.10-	CA1782IR	14 140		AT 03.10-	CS1480*	12 1.8	
		03.10- A25 03.10-	CA1810IR CA2011IR	14 110 14 140		A25 03.10-	CS1505*	12 2.0	
Roomster 1.9 TDi	[AXR]	03.06- 05.06	CA1446IR	14 90		03.06- 05.06	CS1200	12 2.0	
		03.06- 05.06	CA1502IR	14 70		03.06- 05.06	CS1293	12 2.0	
	[BLS]	09.06-	CA1394IR	14 120		09.06-	CS1293	12 2.0	
		09.06-	CA1446IR	14 90					
		09.06-	CA1502IR	14 70					
		09.06- 09.06-	CA2064IR* CA2065IR	14 90 14 110					
	[BSW]	09.06-	CA1394IR	14 120		09.06-	CS1293	12 2.0	
		09.06-	CA1446IR	14 90					
		09.06-	CA1502IR	14 70					
		09.06- 09.06-	CA2064IR* CA2065IR	14 90 14 110					
Superb 1.4 TSi	[CAXC]	07.08-	CA1985IR	14 140		07.08-	CS1294	12 1.1	
Superb 1.6 TDi	[CAYC]	09.10-	CA1912IR	14 180		A25 09.10-	CS1505*	12 2.0	
		A25 09.10-	CA2011IR	14 140					
Superb 1.8 TSi	[BZB]	07.08-	CA1811IR	14 140		07.08-	CS1294	12 1.1	
	[CDAB]	03.09-	CA1811IR	14 140		03.09-	CS1470	12 1.1	
						03.09-	CS1294	12 1.1	
	[CDA]	07.08-	CA1811IR	14 140		07.08-	CS1294	12 1.1	
Superb 1.8 TSi 4x4	[CDAB]	03.09-	CA1811IR	14 140		03.09-	CS1294	12 1.1	
					03.09-	CS1470	12 1.1		
	[CDA]	11.08-	CA1811IR	14 140		11.08-	CS1294	12 1.1	
Superb 1.8 Turbo 20V	[AWT]	12.01-	CA1545IR	14 70	Chas. -3U-4-066205	12.01- 03.04	CS612	12 1.1	
		12.01-	CA1546IR	14 90		Chas. 3U-4-066206-	03.04-	CS1394	12 1.2
		12.01-	CA1664IR	14 120					
Superb 1.9 TDi	[AVB]	02.02- 10.05	CA1541IR	14 120		02.02- 10.05	CS624	12 1.8	
		02.02- 10.05	CA1678IR	14 140					
	[AVF]	02.02-	CA1541IR	14 120		02.02-	CS624	12 1.8	
		01.04-	CA1678IR	14 140					
	[AWX]	12.01-	CA1541IR	14 120		12.01-	CS624	12 1.8	
		12.01-	CA1678IR	14 140					
	[BLS]	07.08-	CA1782IR	14 140		07.08-	CS1293	12 2.0	
	[BLS,BXE]	10.09- 11.10	CA1782IR	14 140		10.09- 11.10	CS1293	12 2.0	
	[BPZ]	01.07- 03.08	CA1541IR	14 120		01.07- 03.08	CS624	12 1.8	
		01.07- 03.08	CA1678IR	14 140		01.07- 03.08	CS1392	12 2.0	
[BSV]	10.05-	CA1541IR	14 120		10.05-	CS624	12 1.8		
	10.05-	CA1678IR	14 140						
Superb 2.0	[BXE]	07.08-	CA1782IR	14 140		07.08-	CS1293	12 2.0	
		12.01-	CA1545IR	14 70	Chas. 3U-4-066206-	03.04-	CS1394	12 1.2	
		12.01-	CA1546IR	14 90	Chas. -3U-4-066205	12.01- 03.04	CS612	12 1.1	
		12.01- 12.01-	CA1664IR CA1759IR	14 120 14 120					
	[BWW]	02.06- 04.08	CA1541IR	14 120		02.06- 04.08	CS1392	12 2.0	
		02.06- 04.08	CA1678IR	14 140					
Superb 2.0 TSi	[CCZA]	05.10-	CA1811IR	14 140					
Superb 2.0 TDi 16V 4x4	[CFFB]	11.10-	CA1912IR	14 180		11.10-	CS1286	12 2.0	
Superb 2.0 TDi	[BKD]					01.09-	CS1286	12 2.0	
						AT 03.08-	CS1286	12 2.0	
	[BMP]	03.08-	CA1782IR	14 140		AT 03.08-	CS1286	12 1.1	
						03.08-	CS1323	12 2.0	
	[BSS]	10.05-	CA1541IR	14 120		10.05-	CS1392	12 2.0	
		10.05-	CA1678IR	14 140					
	[CBBB]	07.08-	CA1782IR	14 140		07.08-	CS1323	12 2.0	
						AT 07.08-	CS1286	12 2.0	
	[CFFB]	03.10-	CA1912IR	14 180		AT 03.10-	CS1286	12 2.0	
	[CFGB]	10.09-	CA1912IR	14 180		10.09-	CS1323	12 2.0	
						A25 10.09-	CS1286	12 2.0	
						AT 02.10-	CS1286	12 2.0	
	Superb 2.0 TDi 4x4	[CBBB]	09.08-	CA1782IR	14 140		09.08-	CS1323	12 2.0
							AT 09.08-	CS1286	12 2.0
					10.09-	CS1323	12 2.0		
					AT 10.09-	CS1286	12 2.0		
Superb 2.5 TDi	[AYM]	12.01- 08.03	CA1588IR	14 120		12.01- 08.03	CS1114	12 2.0	
		06.03-	CA1141IR	14 120		06.03-	CS1114	12 2.0	
	[BDG]	06.03- 06.03-	CA1546IR CA1746IR	14 90 14 140					
Superb 2.8 V6	[AMX]	12.01-	CA1546IR	14 90		12.01-	CS1074	12 1.4	
		12.01-	CA1588IR	14 120					
		12.01-	CA1813IR	14 150					
Superb 3.6 4x4	[CDVA]				AT 11.08-	CS1286	12 2.0		
Superb 3.6 V6 4x4	[CDVA]				10.09-	CS1286	12 2.0		
Yeti 1.2 TSi	[CBZB]				AT 09.09-	CS1470	12 1.1		
					09.09-	CS1322	12 1.1		
Yeti 1.4 TSi	[CAXA]	06.10-	CA1985IR	14 140		06.10-	CS1294	12 1.1	
Yeti 1.6 TDi	[CAYC]				11.10-	CS1505*	12 2.0		
Yeti 1.8 TSi	[CDAB]	05.09-	CA1811IR	14 140					
Yeti 1.8 TSi 4x4	[CDAB]	11.09-	CA1811IR	14 140		11.09-	CS1347	12 1.1	
	[CDA]	05.09-	CA1811IR	14 140					
Yeti 2.0 TDi	[CFHA]	11.09-	CA1782IR	14 140		11.09-	CS1323	12 2.0	
		11.09-	CA1811IR	14 140					
	[CFHC]	11.11-	CA1782IR	14 140					
		11.11-	CA1810IR	14 110					
Yeti 2.0 TDi 4x4	[CBDB]	05.09-	CA1782IR	14 140		05.09-	CS1323	12 2.0	
		05.09-	CA1811IR	14 140					
		11.09- 05.10	CA1782IR	14 140		11.09- 05.10	CS1323	12 2.0	
		11.09- 05.10	CA1811IR	14 140					
	[CFHA]	11.09-	CA1782IR	14 140		11.09-	CS1323	12 2.0	
		11.09-	CA1811IR	14 140					
	[CFHC]	05.09-	CA1782IR	14 140		05.09-	CS1323	12 2.0	
		05.09-	CA1810IR	14 110					
			11.09-	CA1782IR	14 140		11.09-	CS1323	12 2.0
			11.09-	CA1810IR	14 110		11.09-	CS1323	12 2.0



**SKODA Continued**

PASSENGER CARS AO											
Fabia 1.0	[AQV]	11.00- 08.02	CA1394IR	14	120			11.00- 08.02	CS1204	12	1.0
		11.00- 08.02	CA1542IR	14	90						
		11.00- 08.02	CA1586IR	14	70						
	[ARV]	11.00- 08.02	CA1394IR	14	120			11.00- 08.02	CS1204	12	1.0
		11.00- 08.02	CA1542IR	14	90						
		11.00- 08.02	CA1586IR	14	70						
Smart (MCC)											
PASSENGER CARS EU											
Cabrio 0.6		06.02- 01.04	CA1734IR	14	75	w/B+, D+, PHIN connection		06.02- 01.04	CS1206	12	0.8
Cabrio 0.7		01.03- 01.04	CA1734IR	14	75	w/B+, D+, PHIN connection		01.03- 01.04	CS1206	12	0.8
City 0.6	(MCO1)	06.02- 01.04	CA1734IR	14	75	w/B+, D+, PHIN connection		06.02- 01.04	CS1206	12	0.8
City 0.7		01.03- 01.04	CA1734IR	14	75	w/B+, D+, PHIN connection		01.03- 01.04	CS1206	12	0.8
City 0.8 CDI	(450..)[OM660.940]	11.99- 01.04	CA2024IR	14	85			11.99- 01.04	CS1241	12	1.0
Crossblade 0.6		10.02-	CA1734IR	14	75	w/B+, D+, PHIN connection		10.02-	CS1206	12	0.8
Forfour 1.1	(454)[M134.911]	02.05-	JA1895IR	14	85			02.05-	JS1359	12	0.9
		01.04-	JA1895IR	14	85			01.04-	JS1359	12	0.9
		01.04-	JA1895IR	14	85			01.04-	JS1359	12	0.9
Forfour 1.3		01.04-	JA1895IR	14	85			01.04-	JS1359	12	0.9
Forfour 1.5		05.05-	JA1895IR	14	85			05.05-	JS1359	12	0.9
Forfour 1.5 Brabus	(454)[M122.950]	01.04-	JA1895IR	14	85			01.04-	JS1359	12	0.9
Forfour 1.5 Sportsstyle	(454)	01.04-	JA1895IR	14	85			01.04-	JS1359	12	0.9
Fortwo 0.7	[160.920]	01.04-	CA1734IR	14	75	w/B+, D+, PHIN connection		01.04-	CS1206	12	0.8
		01.04-	CA1734IR	14	75	w/B+, D+, PHIN connection		01.04-	CS1206	12	0.8
Fortwo 0.8 CDI	(450..)[OM660.940]	01.04- 03.07	CA2024IR	14	85			01.04- 03.07	CS1241	12	1.0
	(451)[OM660.950]							01.07-	CS1241	12	1.0
	[OM660.951]							08.09-	CS1241	12	1.0
Fortwo 1.0	(451)[M132.910]	01.07-	CA2012IR	14	90			01.07-	CS1452*	12	
Fortwo 1.0 Brabus	(451)[M132.930]	01.08-	CA2012IR	14	90			01.08-	CS1452*	12	
Fortwo 1.0 Turbo	(451)[M132.930]	01.07-	CA2012IR	14	90			01.07-	CS1452*	12	
Roadster 0.7	(452, 332)[M160.921]	06.03-	CA1734IR	14	75	w/B+, D+, PHIN connection		06.03-	CS1206	12	0.8
		04.03-	CA1734IR	14	75	w/B+, D+, PHIN connection		04.03-	CS1206	12	0.8
Roadster 0.7 Brabus	[160.923]	12.03-	CA1734IR	14	75	w/B+, D+, PHIN connection		12.03-	CS1206	12	0.8
		12.03-	CA1734IR	14	75	w/B+, D+, PHIN connection		12.03-	CS1206	12	0.8
Smart 0.6	(MCO1)[M160E6ALB05]	Chas. H182875- 01.01-	CA1734IR	14	75	w/B+, D+, PHIN connection		01.01-	CS1206	12	0.8
		Chas. -H182874 01.01-	CA1625IR	14	75	w/B+, D+ connection					
	[M160E6ALB03]	Chas. H182875- 07.98-	CA1734IR	14	75	w/B+, D+, PHIN connection		07.98-	CS1206	12	0.8
		Chas. -H182874 07.98-	CA1625IR	14	75	w/B+, D+ connection					
	[M160E6ALB04]	Chas. H182875- 07.98-	CA1734IR	14	75	w/B+, D+, PHIN connection		07.98-	CS1206	12	0.8
		Chas. -H182874 07.98-	CA1625IR	14	75	w/B+, D+ connection					
	[M160E6ALB05]	Chas. H182875- 01.01-	CA1734IR	14	75	w/B+, D+, PHIN connection		01.01-	CS1206	12	0.8
		Chas. -H182874 01.01-	CA1625IR	14	75	w/B+, D+ connection					
	[M160E6ALB03]	Chas. H182875- 03.00-	CA1734IR	14	75	w/B+, D+, PHIN connection		03.00- 01.04	CS1206	12	0.8
		Chas. -H182874 03.00-	CA1625IR	14	75	w/B+, D+ connection					
Smart 0.8 CDI	(450..)[OM660.940]	03.01- 01.04	CA2024IR	14	85			03.01- 01.04	CS1241	12	1.0
Solaris											
TRUCKS EU											
Vacanza 12 12.6	[XE250C]	06.02- 12.06	CA1693IR	28	110			06.02- 12.06	CS1274	24	6.2
		06.02- 12.06	CA1694IR	28	80			06.02- 12.06	CS1380	24	5.5
Vacanza 12 12.9	[MX300]	10.05-	CA1917IR	28	80			10.05-	CS1420	24	5.5
		10.05-	CA1939IR	28	110						
Vacanza 13 12.9	[MX300]	10.05-	CA1917IR	28	80			10.05-	CS1420	24	5.5
		10.05-	CA1939IR	28	110						
Ssangyong											
PASSENGER CARS EU											
Actyon 2.0 XDi	[D20DT]							11.05-	CS1162	12	2.2
Actyon 2.0 XDi 4WD								10.06-	CS1162	12	2.2
Actyon 2.0 XDi Sports pick-up	[D20DT]							04.07-	CS1162	12	2.2
Korando 2.0 4WD	[M161E20]	07.96- 06.02	CA1057IR	14	120			07.96- 12.05	CS1075	12	1.2
Korando 2.2 Diesel 4WD	[DC23]	12.88- 12.96	CA1685IR	14	75			12.88- 12.96	CS331	12	2.2
Korando 2.3	[M161E23]	07.96- 06.02	CA1057IR	14	120			07.96- 12.05	CS1075	12	1.2
		01.99- 02.02	CA1057IR	14	120			01.99-	CS1075	12	1.2
Korando 2.3 4WD	[M161E23]	07.96- 06.02	CA1057IR	14	120			07.96- 12.05	CS1075	12	1.2
Korando 2.3 Diesel 4WD	[OM601.940]	12.96-	CA1062IR	14	90			12.96-	CS331	12	2.2
		12.96-	CA1685IR	14	75						
Korando 2.9 Diesel	[OM662]	07.96-	CA1062IR	14	90			07.96-	CS331	12	2.2
		07.96-	CA1685IR	14	75						
Korando 2.9 Diesel 4WD	[OM662]	12.96-	CA1062IR	14	90			12.96-	CS331	12	2.2
		12.96-	CA1685IR	14	75						
Korando 2.9 TD	[OM662]	04.98-	CA1685IR	14	75			04.98-	CS331	12	2.2
		04.98-	CA1685IR	14	75			04.98-	CS331	12	2.2
Korando 3.2	[M104.995]	01.99-	CA1685IR	14	75			01.99-	CS360	12	1.7
								01.99-	CS327	12	1.4
		06.97-	CA1685IR	14	75			07.96-	CS360	12	1.7
Korando 3.2 4WD	[M104.995]	07.96- 12.00	CA1477IR	14	120			07.96- 12.00	CS360	12	1.7
Kyron 2.0 XDi	[D20DT]							05.05-	CS1162	12	2.2
Kyron 2.0 XDi 4WD	[D20DT]							05.05-	CS1162	12	2.2
Kyron 2.7 XDi	[D27DT]							05.05-	CS1162	12	2.2
Musso 2.0 4WD	[E20]	10.96-	CA1057IR	14	120			10.96-	CS1075	12	1.2
Musso 2.3		04.03-	CA1685IR	14	75			04.03-	CS1075	12	1.2
Musso 2.3 4WD	[M111.970]	10.96-	CA1057IR	14	120			10.96-	CS1075	12	1.2
Musso 2.3 Diesel 4WD	[OM601.940]	10.95-	CA1062IR	14	90			10.95-	CS331	12	2.2
		10.95-	CA1685IR	14	75						
	[OM661]	10.95-	CA1062IR	14	90			10.95-	CS331	12	2.2
		10.95-	CA1685IR	14	75						
Musso 2.3 TDiC 4x4		05.97- 10.03	CA1685IR	14	75			05.97- 10.03	CS331	12	2.2
Musso 2.9 Diesel 4WD	[OM662]	03.96-	CA1062IR	14	90			03.96-	CS331	12	2.2
		03.96-	CA1685IR	14	75						
Musso 2.9 Diesel Sports								08.04-	CS1162	12	2.2
Musso 2.9 TD		05.97- 09.99	CA1685IR	14	75			05.97-	CS331	12	2.2
Musso 3.2 4WD	[M104.992]	06.96-	CA1477IR	14	120			06.96-	CS360	12	1.7
Rexton 2.7 Diesel 4x4								05.06-	CS1162	12	2.2
Rexton 2.7 XDi	[D27DT (OM665.925)]							08.04-	CS1162	12	2.2
	[OM665.925]							03.05- 08.06	CS1162	12	2.2
Rexton 2.9 TD	[OM602.962]							10.02-	CS1162	12	2.2
								02.02- 11.02	CS331	12	2.2
Rodius 2.7 XDi	[D27DT]							05.05- 07.06	CS1162	12	2.2
Rodius 2.7 XDi 4WD	[D27DT]							05.05-	CS1162	12	2.2
PASSENGER CARS AO											
Korando 2.3 TDiC 4WD		07.98-	CA1685IR	14	75			07.98-	CS331	12	2.2
		07.98-	CA1057IR	14	120						
TRUCKS EU											
Cargo 14.6	[OM442.]	01.93-	CA333IR	28	55			01.93-	CS198	24	6.0
Mixer 69T 14.6	[OM442.]	01.93-	CA333IR	28	55			01.93-	CS198	24	6.0
Sterling											



PASSENGER CARS US									
825 2.5 S		01.87- 01.88	JA555IR#	14	70				
825 2.5 SL		01.87- 01.88	JA555IR#	14	70				
827 2.7 S		01.89- 01.91	JA555IR#	14	70				
827 2.7 SL		01.89- 01.91	JA555IR#	14	70				
827 2.7 SLI		01.89- 01.91	JA555IR#	14	70				
<b>Steyr</b>									
TRUCKS EU									
590.110 6.0	[WD610.00]								
	[WD610.01]								
	[WD610.19]								
690.110 6.0	[WD610.01]								
790.132 6.0	[WD610.00]								
	[WD610.19]								
790.150 6.0	[WD610.60]								
	[WD610.69]								
	[WD610.70]								
890.132 6.0	[WD610.00]								
	[WD610.19]								
890.150 6.0	[WD610.60]	01.68- 12.79	CA341IR	28	27				
	[WD610.69]	01.68- 12.79	CA341IR	28	27				
	[WD610.70]	01.68- 12.79	CA341IR	28	27				
990.180 8.1	[WD614.01]	01.68- 12.78	CA341IR	28	27				
	[WD614.20]	01.68- 12.78	CA341IR	28	27				
1290.320 12.0	[WD815.60]	01.71- 12.78	CA341IR	28	27	01.71- 12.78	CS506	24	5.4
	[WD815.70]	01.71- 12.78	CA341IR	28	27	01.71- 12.78	CS506	24	5.4
1490.320 12.0	[WD815.60]	01.71- 12.78	CA341IR	28	27	01.71- 12.78	CS506	24	5.4
	[WD815.70]	01.71- 12.78	CA341IR	28	27	01.72- 12.78	CS506	24	5.4
1890.320 12.0		01.75- 12.79	CA341IR	28	27				
10 S 14 6.6	[WD 612.]					06.86-	CS97	24	4.0
10 S 18 6.6	[WD 612.]					04.86-	CS97	24	4.0
11 S 14 6.6	[WD 612.]					07.89-	CS97	24	4.0
11 S 18 6.6	[WD 612.]					07.89-	CS97	24	4.0
12 S 14 6.6	[WD 612.]					06.86-	CS97	24	4.0
12 S 18 6.6	[WD 612.]					04.86-	CS97	24	4.0
12 S 21 6.6	[WD 612.]					04.86-	CS97	24	4.0
1290.230 1290.240 8.1	[WD614.60]	01.68- 12.78	CA341IR	28	27				
	[WD614.69]	01.68- 12.78	CA341IR	28	27				
	[WD614.79]	01.68- 12.78	CA341IR	28	27				
13 S 14 6.6	[WD 612.]	09.88-	CA595IR	28	55	09.88-	CS97	24	4.0
13 S 18 6.6	[WD 612.]	09.88-	CA595IR	28	55	09.88-	CS97	24	4.0
13 S 21 6.6	[WD 612.]	07.89-	CA595IR	28	55	07.89-	CS97	24	4.0
13 S 23 6.6	[WD 612.]	07.89-	CA595IR	28	55	07.89-	CS97	24	4.0
14 S 14 6.6	[WD 612.]	06.86-	CA595IR	28	55	06.86-	CS97	24	4.0
14 S 18 6.6	[WD 612.]	04.86-	CA595IR	28	55	04.86-	CS97	24	4.0
14 S 21 6.6	[WD 612.]	04.86-	CA595IR	28	55	04.86-	CS97	24	4.0
15 S 14 6.6	[WD 612.]	04.86-	CA595IR	28	55	04.86-	CS97	24	4.0
15 S 18 6.6	[WD 612.]	04.86-	CA595IR	28	55	04.86-	CS97	24	4.0
15 S 21 6.6	[WD 612.]	04.86-	CA595IR	28	55	04.86-	CS97	24	4.0
15 S 23 6.6	[WD 612.]	04.86-	CA595IR	28	55	04.86-	CS97	24	4.0
16 S 18 6.6	[WD 612.]					04.86-	CS97	24	4.0
16 S 21 6.6	[WD 612.]					04.86-	CS97	24	4.0
16 S 23 6.6	[WD 612.]	04.86-	CA595IR	28	55				
17 S 18 6.6	[WD 612.]	09.88-	CA595IR	28	55	09.88-	CS97	24	4.0
17 S 21 6.6	[WD 612.]	09.88-	CA595IR	28	55	09.88-	CS97	24	4.0
17 S 23 6.6	[WD 612.]	09.88-	CA595IR	28	55	09.88-	CS97	24	4.0
19 S 24 9.7	[WD 615.]	01.88-	CA595IR	28	55				
19 S 28 9.7	[WD 615.]	01.88-	CA595IR	28	55				
19 S 31 9.7	[WD 615.]	10.87-	CA595IR	28	55				
19 S 34 12.0	[WD 815.]	10.87- 06.96	CA595IR	28	55	10.87- 06.96	CS506	24	5.4
19 S 37 12.0	[WD 815.]	10.87- 06.96	CA595IR	28	55	10.87- 06.96	CS506	24	5.4
19 S 39 12.0	[WD 815.]	05.90- 06.96	CA595IR	28	55	05.90- 06.96	CS506	24	5.4
22 S 28 9.7	[WD 615.]	01.88-	CA595IR	28	55				
22 S 31 9.7	[WD 615.]	10.87-	CA595IR	28	55				
22 S 34 12.0	[WD 815.]	10.87- 06.96	CA595IR	28	55	10.87- 06.96	CS506	24	5.4
22 S 37 12.0	[WD 815.]	10.87- 06.96	CA595IR	28	55	10.87- 06.96	CS506	24	5.4
26 S 28 9.7	[WD 615.]	01.88-	CA595IR	28	55				
26 S 31 9.7	[WD 615.]	10.87-	CA595IR	28	55				
26 S 34 12.0	[WD 815.]	10.87- 06.96	CA595IR	28	55	10.87- 06.96	CS506	24	5.4
26 S 37 12.0	[WD 815.]	10.87- 06.96	CA595IR	28	55	10.87- 06.96	CS506	24	5.4
32 S 28 9.7	[WD 615.]	01.88-	CA595IR	28	55				
32 S 31 9.7	[WD 615.]	10.87-	CA595IR	28	55				
32 S 34 12.0	[WD 815.]	10.87- 06.96	CA595IR	28	55	10.87- 06.96	CS506	24	5.4
32 S 37 12.0	[WD 815.]	10.87- 06.96	CA595IR	28	55	10.87- 06.96	CS506	24	5.4
33 S 31 9.7	[WD 615.]	10.87-	CA595IR	28	55				
33 S 34 12.0	[WD 815.]	10.87- 06.96	CA595IR	28	55	10.87- 06.96	CS506	24	5.4
40 S 31 9.7	[WD 615.]	01.88-	CA595IR	28	55				
40 S 34 12.0	[WD 815.]	01.88- 06.96	CA595IR	28	55	01.88- 06.96	CS506	24	5.4
40 S 37 12.0	[WD 815.]	01.88- 06.96	CA595IR	28	55	01.88- 06.96	CS506	24	5.4
8 S 14 6.6	[WD 612.]					05.89-	CS97	24	4.0
8 S 18 6.6	[WD 612.]					05.89-	CS97	24	4.0
9 S 14 6.6	[WD 612.]					06.86-	CS97	24	4.0
9 S 18 6.6	[WD 612.]					04.86-	CS97	24	4.0
AGRICULTURE									
8050 2.6	[WD 311.]	09.86-	CA603IR	14	28				
8060 2.6	[WD 311.]	09.80- 02.87	CA603IR	14	28				
		02.87-	CA238IR	14	55				
8065 2.6	[WD 311.]	09.86-	CA238IR	14	55				
		09.86- 09.94	CA603IR	14	28				
8070 3.5	[WD 411.]	01.80- 09.94	CA603IR	14	28				
		10.84-	CA238IR	14	55				
8075 3.5	[WD 411.]	01.84- 09.94	CA603IR	14	28				
		10.92-	CA238IR	14	55				
8080 3.5	[WD 411.]	01.80- 09.94	CA603IR	14	28				
		06.84-	CA238IR	14	55				
8085 3.5	[WD 411.]	02.90-	CA238IR	14	55				
8090 3.5	[WD 411.]	01.84-	CA238IR	14	55				
		01.84- 04.94	CA603IR	14	28				
8110 5.2	[WD 611.]	07.84-	CA238IR	14	55	07.84-	CS718	12	3.0
		07.84- 09.94	CA603IR	14	28				
8130 5.2	[WD 611.]	07.84- 09.94	CA603IR	14	28	07.84-	CS718	12	3.0
		10.92-	CA238IR	14	55				



**STEYR Continued**

8150 6.6	[WD 612.]	12.82- 09.94	CA603IR	14 28	12.82-	CS605	12 3.0
		10.92-	CA238IR	14 55			
8165 6.6	[WD 612.]	06.86-	CA238IR	14 55	06.86-	CS605	12 3.0
<b>Subaru</b>							
<b>PASSENGER CARS EU</b>							
1800 XT 1.8 Turbo 4WD	[EA82]				11.84- 12.90	JS373	12 1.0
Forester 2.0	[EJ20]	06.98- 09.02	CA2083IR*	14 80	06.98- 09.02	JS1366	12 1.0
		06.98-	JA1704IR	14 80	06.98- 09.02	JS671	12 1.0 A36
	[FB 20]				AT 06.98- 09.02	JS670	12 1.4
					01.10-	JS1366	12 1.0
		01.08-	CA2083IR*	14 80	01.08-	JS1366	12 1.0
		01.08-	CA2084IR*	14 110			
Forester 2.0 4WD	[EJ20]	08.97- 06.98	JA1407IR	14 75	08.97- 06.98	JS1366	12 1.0 A37
					AT 08.97- 06.98	JS670	12 1.4
					08.97- 06.98	JS671	12 1.0 A36
Forester 2.0 X	[EJ204]	09.05-	CA2084IR*	14 110	09.05-	JS1366	12 1.0
Forester 2.0 Turbo S	[EJ20]	09.02-	CA2083IR*	14 80	06.98- 04.01	JS671	12 1.0 A36
		06.98-	JA1704IR	14 80	AT 06.98- 04.01	JS670	12 1.4
					06.98- 04.01	JS1366	12 1.0 A37
	[EJ205]	07.98- 09.02	JA1704IR	14 80	07.98- 09.02	JS671	12 1.0 A36
					AT 07.98- 09.02	JS670	12 1.4
					07.98- 09.02	JS1366	12 1.0 A37
Forester 2.5	[EJ25]	12.03- 05.05	CA2083IR*	14 80	12.03-	JS1366	12 1.0
		06.05- 11.07	CA2084IR*	14 110			
	[EJ255]	06.08-	CA2084IR*	14 110	06.08-	JS1366	12 1.0
Forester 2.5 4x4		07.97- 05.02	CA2083IR*	14 80	07.97- 05.02	JS670	12 1.4
Forester 2.5 XT		09.05-	CA2084IR*	14 110	09.05-	JS1366	12 1.0
Forester 2.5 Turbo 4x4		09.98- 05.02	CA2083IR*	14 80	09.98- 05.02	JS670	12 1.4
Impreza 1.5	[EJ154]	02.08-	CA2083IR*	14 80	02.08-	JS1366	12 1.0
		05.06-	CA2083IR*	14 80	05.06-	JS1366	12 1.0
Impreza 1.5 4x4	[EJ154]	02.08-	CA2083IR*	14 80	02.08-	JS1366	12 1.0
Impreza 1.6	[EJ16]	12.00- 06.01	JA1704IR	14 80	12.00- 06.01	JS671	12 1.0 A36
					12.00- 06.01	JS1366	12 1.0 A37
	[EJ16E]	12.96- 08.98	JA1407IR	14 75	12.96- 12.00	JS1366	12 1.0 A37
		08.98- 12.00	JA1704IR	14 80	AT 12.96- 12.00	JS373	12 1.0
					12.96- 12.00	JS671	12 1.0 A36
		06.01- 09.06	JA1704IR	14 80	06.01- 09.06	JS1366	12 1.0
Impreza 1.6 4WD	[EJ16E]	12.96- 08.98	JA1407IR	14 75	12.96- 12.00	JS1366	12 1.0 A37
		08.98- 12.00	JA1704IR	14 80	12.96- 12.00	JS671	12 1.0 A36
					AT 12.96- 12.00	JS373	12 1.0
Impreza 1.6 i	[EJ16]	08.92- 12.00	JA1407IR	14 75	08.92- 12.00	JS1366	12 1.0 A37
		06.98- 12.00	JA1704IR	14 80	08.92- 12.00	JS671	12 1.0 A36
					AT 08.92- 12.00	JS373	12 1.0
Impreza 1.6 i 4WD	[EJ16]	08.92- 07.96	JA1407IR	14 75	AT 08.92- 07.96	JS373	12 1.0
		06.98- 12.00	JA1704IR	14 80	08.92- 12.00	JS671	12 1.0 A36
					08.92- 12.00	JS1366	12 1.0 A37
Impreza 1.8	[EJ18E]	11.95- 06.96	JA1407IR	14 75	AT 11.95- 06.96	JS670	12 1.4
		11.95- 06.96	JA1713IR	14 85	11.95- 06.96	JS671	12 1.0 A36
					11.95- 06.96	JS1366	12 1.0 A37
Impreza 1.8 i 4WD	[EJ18]	08.92- 07.96	JA1407IR	14 75	08.92- 07.96	JS671	12 1.0 A36
		08.92- 07.96	JA1713IR	14 85	08.92- 07.96	JS1366	12 1.0 A37
	[EJ18E]	08.92- 07.96	JA1407IR	14 75	AT 08.92- 07.96	JS670	12 1.4
		08.92- 07.96	JA1713IR	14 85	08.92- 07.96	JS671	12 1.0 A36
					08.92- 07.96	JS1366	12 1.0 A37
Impreza 2.0	[EJ20]	12.00-	CA2083IR*	14 80	12.00-	JS671	12 1.0 A36
		12.00-	JA1704IR	14 80	AT 12.00-	JS670	12 1.4
	[EJ204]	02.08-	CA2084IR*	14 110	12.00-	JS1366	12 1.0 A37
Impreza 2.0 4WD	[EJ20]	12.95- 07.98	JA1407IR	14 75	12.95- 12.00	JS671	12 1.0 A36
		07.98- 12.00	JA1704IR	14 80	12.95- 12.00	JS1366	12 1.0 A37
					AT 12.95- 12.00	JS670	12 1.4
Impreza 2.0 R	[EJ204]	09.05-	CA2084IR*	14 110	09.05-	JS1366	12 1.0
Impreza 2.0 16V AWD	[EJ20]	06.98- 12.00	JA1704IR	14 80	06.98- 12.00	JS671	12 1.0 A36
					AT 06.98- 12.00	JS670	12 1.4
					06.98- 12.00	JS1366	12 1.0 A37
Impreza 2.0 i Turbo GT 4WD	[EJ20]	12.93- 07.98	JA1407IR	14 75	AT 12.93- 12.00	JS670	12 1.4
		08.98- 12.00	JA1704IR	14 80	12.93- 12.00	JS671	12 1.0 A36
					12.93- 12.00	JS1366	12 1.0 A37
Impreza 2.0 i Turbo 4WD	[EJ20]	12.93- 07.98	JA1407IR	14 75	AT 12.93- 12.00	JS670	12 1.4
		08.98- 12.00	JA1704IR	14 80	12.93- 12.00	JS671	12 1.0 A36
					12.93- 12.00	JS1366	12 1.0 A37
	[EJ207]	11.01-	JA1704IR	14 80	11.01-	JS1366	12 1.0
Impreza 2.0 i 4WD	[EJ20]	10.95- 07.98	JA1407IR	14 75	AT 10.95- 12.00	JS670	12 1.4
		06.98- 12.00	JA1704IR	14 80	10.95- 12.00	JS1366	12 1.0 A37
					10.95- 12.00	JS671	12 1.0 A36
Impreza 2.0 Turbo	[EJ205]	12.00-	JA1704IR	14 80	AT 12.00-	JS670	12 1.4
					12.00-	JS1366	12 1.0
Impreza 2.0 Turbo 4WD	[EJ20G]	12.93- 07.98	JA1407IR	14 75	12.93- 07.98	JS671	12 1.0 A36
					12.93- 07.98	JS1366	12 1.0 A37
Impreza 2.0 Turbo GT 4WD	[EJ205]	06.98- 12.00	JA1704IR	14 80	06.98- 12.00	JS671	12 1.0 A36
					06.98- 12.00	JS1366	12 1.0 A37
	[EJ20T]	06.98- 12.00	JA1704IR	14 80	AT 06.98- 12.00	JS670	12 1.4
Impreza 2.0 Turbo WRX	[EJ205]	12.00-	JA1704IR	14 80	12.00-	JS1366	12 1.0
					AT 12.00-	JS670	12 1.4
Impreza 2.0 Turbo WRX 4WD					12.02-	JS1366	12 1.0
Impreza 2.5	[EJ257]	02.08-	CA2084IR*	14 110	02.08-	JS1366	12 1.0
Impreza 2.5 WRX	[EJ255]				09.05-	JS1366	12 1.0
Impreza 2.5 WRX STi	[EJ257]				09.05-	JS1366	12 1.0
Justy 1.0 1000	[EF10]	11.84- 06.89	JA652IR	14 45	11.84- 10.95	JS557	12 0.8
		05.89- 10.95	JA774IR	14 55			
Justy 1.0 1000 4WD	[EF10]	11.84- 05.89	JA652IR	14 45	11.84- 11.94	JS557	12 0.8
		05.89- 11.94	JA774IR	14 55			
Justy 1.2 1200	[EF12]	10.86- 05.89	JA652IR	14 45	10.86- 10.95	JS557	12 0.8
		01.89- 10.95	JA774IR	14 55	05.91- 12.94	JS558#	12 0.8
Justy 1.2 1200 4WD	[EF12]	05.87- 05.89	JA652IR	14 45	05.87- 05.91	JS557	12 0.8
		05.89- 05.91	JA774IR	14 55			
Justy 1.3		09.03-	JA798IR	14 50			
		09.03-	CA2077IR*	14 70			
Justy 1.3 4WD	[G13BB]	04.01-	JA682IR	14 50			
Justy 1.3 4WD GX	[EF13]				10.96- 11.03	JS512	12 0.8
Justy 1.3 AWD					03.08-	CS1498*	12 0.8
Justy 1.5	[M15A]	09.03-	CA2077IR*	14 70			
		09.03-	JA798IR	14 50			



Legacy 2.0	[EJ20]	12.98- 08.03	JA1704IR	14 80	AT 12.98- 08.03	JS670	12 1.4
Legacy 2.5	[EJ25]	12.98- 08.03	JA1704IR	14 80	AT 12.98- 08.03	JS670	12 1.4
Legacy 1.8 1800	[EJ18SPI]	01.89- 07.94	JA698IR	14 70	01.89- 07.94	JS1366	12 1.0 A37
					AT 01.89- 01.90	JS670	12 1.4
					02.90- 07.94	JS757	12 1.4
					01.89- 07.94	JS671	12 1.0 A36
Legacy 1.8 1800 4WD	[EJ18]	01.89- 07.94	JA698IR	14 70	01.89- 07.94	JS1366	12 1.0 A37
					AT 01.89- 01.90	JS670	12 1.4
					02.90- 07.94	JS757	12 1.4
					01.89- 07.94	JS671	12 1.0 A36
Legacy 2.0	[EJ20]	04.99- 08.03	JA1704IR	14 80	AT 04.99- 08.03	JS670	12 1.4
	[EJ204]	09.07-	CA2084IR*	14 110	09.03-	JS1366	12 1.0
					09.07-	JS1366	12 1.0
Legacy 2.0 2000	[EJ20EMPI]	09.91- 12.93	JA698IR	14 70	05.92- 12.93	JS671	12 1.0 A36
					AT 05.92- 12.93	JS670	12 1.4
					05.92- 12.93	JS1366	12 1.0 A37
Legacy 2.0 2000 4WD	[EJ20]	05.92- 12.93	JA698IR	14 70	AT 05.92- 12.93	JS757	12 1.4
					09.91- 07.94	JS1366	12 1.0 A37
					09.91- 07.94	JS671	12 1.0 A36
Legacy 2.0 i	[EJ20E]	01.94- 05.98	JA1407IR	14 75	AT 01.94- 05.98	JS757	12 1.4
		01.94- 05.98	JA1713IR	14 85	01.94- 05.98	JS671	12 1.0 A36
					01.94- 05.98	JS1366	12 1.0 A37
	[EJ20EMPI]	01.94- 08.98	JA1407IR	14 75	01.94- 08.98	JS671	12 1.0 A36
		01.94- 08.98	JA1713IR	14 85	AT 01.94- 08.98	JS757	12 1.4
					01.94- 08.98	JS1366	12 1.0 A37
Legacy 2.0 i 4WD	[EJ20]	01.94- 08.98	JA1407IR	14 75	AT 01.94- 08.98	JS757	12 1.4
		01.94- 08.98	JA1713IR	14 85	01.94- 08.98	JS1366	12 1.0 A37
					AT 01.94- 08.98	JS670	12 1.4
					01.94- 08.98	JS671	12 1.0 A36
Legacy 2.0 Turbo 2000 4WD	[EJ20-GN]	05.92- 12.93	JA698IR	14 70	05.92- 12.93	JS671	12 1.0 A36
					05.92- 12.93	JS1366	12 1.0 A37
					09.03-	JS1366	12 1.0
Legacy 2.0 Diesel					AT 02.90- 12.93	JS757	12 1.4
Legacy 2.2 2200 4WD	[EJ22]	01.89- 12.93	JA698IR	14 70	AT 01.89- 01.90	JS670	12 1.4
					01.89- 12.93	JS1366	12 1.0 A37
					01.89- 12.93	JS671	12 1.0 A36
Legacy 2.2 i	[EJ22]	01.94- 05.97	JA1407IR	14 75	AT 01.94- 05.97	JS671	12 1.0 A36
		01.94- 05.97	JA1713IR	14 85	AT 01.94- 05.97	JS757	12 1.4
					AT 01.94- 05.97	JS670	12 1.4
					01.94- 05.97	JS1366	12 1.0 A37
Legacy 2.2 i 4WD	[EJ22]	01.94- 05.97	JA1713IR	14 85	AT 01.94- 05.97	JS670	12 1.4
					01.94- 05.96	JS1366	12 1.0 A37
					01.94- 05.96	JS671	12 1.0 A36
Legacy 2.5	[EJ25]	09.07-	CA2084IR*	14 110	AT 10.98- 08.03	JS670	12 1.4
		10.98- 08.03	JA1704IR	14 80	09.03-	JS1366	12 1.0
	[EJ25D]	06.96- 08.98	JA1713IR	14 85	06.96- 08.98	JS670	12 1.4
Legacy 2.5 OUTBACK		01.96- 12.99	JA1713IR	14 85	AT 01.96- 12.99	JS670	12 1.4
Legacy 2.5 i 4WD	[EJ25D]	06.96- 11.98	JA1713IR	14 85	06.96- 11.98	JS670	12 1.4
Legacy 2.5 Turbo	[EJ25]	01.08-	CA2084IR*	14 110	01.08-	JS1366	12 1.0
Legacy 3.0 H6					10.00- 08.03	JS670	12 1.4
Leone 1.3 1300	[EA65]	11.84- 09.91	JA197IR	14 50			
		PS 11.84- 09.91	JA109IR	14 60			
Leone 1.6 1600	[EA71]	11.84- 09.91	JA197IR	14 50			
		PS 11.84- 09.91	JA109IR	14 60			
Leone 1.8		06.85- 07.86	JA109IR	14 60	AT 06.85- 07.86	JS670	12 1.4
					06.85- 07.86	JS373	12 1.0
Leone 1.8 1800 4WD	[EA81]	09.80- 10.84	JA197IR	14 50	09.80- 10.84	JS373	12 1.0
	[EA82]	11.84- 12.90	JA197IR	14 50	11.84- 07.91	JS373	12 1.0
		12.86- 07.91	JA109IR	14 60	AT 11.84- 07.91	JS670	12 1.4
		PS 11.84- 12.90	JA109IR	14 60			
Leone 1.8 1800 Super 4WD	[EA81]	09.80- 10.84	JA197IR	14 50	09.80- 10.84	JS373	12 1.0
Leone 1.8 1800 Turismo 4WD	[EA81]	09.80- 10.84	JA197IR	14 50	09.80- 10.84	JS373	12 1.0
Leone 1.8 Turbo 1800 4WD	[EA82]	11.84- 12.90	JA109IR	14 60	AT 11.84- 12.90	JS670	12 1.4
		03.89- 12.90	JA197IR	14 50	11.84- 12.90	JS373	12 1.0
		PS 03.89- 12.90	JA109IR	14 60			
Leone 1.8 Turbo 1800 Super 4WD	[EA82]	11.84- 12.90	JA197IR	14 50	AT 11.84- 12.90	JS670	12 1.4
		PS 11.84- 12.90	JA109IR	14 60	11.84- 12.90	JS373	12 1.0
Libero 1.0 4WD	[EF10]	01.83- 12.87	JA652IR	14 45	01.83- 12.87	JS558#	12 0.8
Libero 1.2 4WD	[EF12]	10.86- 04.93	JA652IR	14 45	08.86- 04.93	JS558#	12 0.8
Libero 1.2 i 4WD	[EF12]				05.93- 02.00	JS558#	12 0.8
Outback 2.5	[EJ25]	10.00- 08.03	JA1704IR	14 80	AT 10.00- 08.03	JS670	12 1.4
					10.00- 08.03	JS1366	12 1.0
	[EJ25D]	11.03-	CA2084IR*	14 110	11.03-	JS1366	12 1.0
		09.08-	CA2084IR*	14 110	09.08-	JS1366	12 1.0
Rex 0.5 550	[EK23]	08.81- 06.87	JA171IR	14 40	08.81- 09.85	JS558#	12 0.8
					10.85- 06.87	JS557	12 0.8
Rex 0.5 550 4WD	[EK23]	08.83- 06.87	JA171IR	14 40	08.83- 09.85	JS558#	12 0.8
					10.85- 06.87	JS557	12 0.8
Rex 0.5 Turbo 550		07.84- 06.87	JA171IR	14 40	10.85- 06.87	JS557	12 0.8
					07.84- 09.85	JS558#	12 0.8
Rex 0.7 700	[EK42]	08.82- 06.89	JA171IR	14 40	08.82- 09.85	JS558#	12 0.8
					10.85- 06.89	JS557	12 0.8
SVX 3.3 i 24V	[EG33]				09.92- 12.96	JS670	12 1.4
Vivio 0.65 660 4WD	[EN07E]				03.92- 10.95	JS670	12 1.4
<b>PASSENGER CARS US</b>							
Baja 2.5	[EJ253]				01.03- 01.03	JS1366	12 1.0 A37
					01.03- 01.03	JS671	12 1.0 A36
					01.03- 01.03	JS757	12 1.4
Brat 1.8 DL					01.81- 01.83	JS670	12 1.4
					01.81- 01.83	JS373	12 1.0
Brat 1.8 GL					01.81- 01.87	JS373	12 1.0
					01.81- 01.87	JS670	12 1.4
Brat 1.8 Turbo GL					01.84-	JS373	12 1.0
					01.84-	JS670	12 1.4
Deluxe 1.3		01.72- 01.72	JA100	14 35			
Deluxe 1.4		01.73- 01.73	JA100	14 35			
DL 1.4		01.74- 01.74	JA100	14 35			
DL 1.6					01.82- 01.84	JS373	12 1.0
DL 1.8					01.80- 01.89	JS670	12 1.4
					01.80- 01.89	JS373	12 1.0
Forester 2.5	[EJ253]				01.99- 01.99	JS1366	12 1.0 A37
					01.99- 01.99	JS670	12 1.4
					01.99- 01.99	JS671	12 1.0 A36



**SUBARU** Continued

	[EJ25D]	01.98- 01.98	JA1407IR	14 75	01.98- 01.98	JS670	12 1.4
					01.98- 01.98	JS1366	12 1.0 A37
					01.98- 01.98	JS671	12 1.0 A36
Forester 2.5 L	[EJ25D]	01.98- 01.98	JA1407IR	14 75	01.98- 01.98	JS1366	12 1.0 A37
					01.98- 01.98	JS670	12 1.4
					01.98- 01.98	JS671	12 1.0 A36
Forester 2.5 S	[EJ25D]	01.98- 01.98	JA1407IR	14 75	01.98- 01.98	JS670	12 1.4
					01.98- 01.98	JS1366	12 1.0 A37
					01.98- 01.98	JS671	12 1.0 A36
GL 1.3		01.72- 01.72	JA100	14 35			
GL 1.4		01.73- 01.74	JA100	14 35			
GL 1.6					01.86- 01.87	JS373	12 1.0
GL 1.8					01.80- 01.89	JS373	12 1.0
					01.80- 01.89	JS670	12 1.4
GL 1.8 Turbo					01.83- 01.84	JS373	12 1.0
					01.83- 01.89	JS670	12 1.4
GL-10 1.8					01.85- 01.88	JS670	12 1.4
					01.85- 01.88	JS373	12 1.0
GL-10 1.8 Turbo					01.86- 01.89	JS670	12 1.4
GLF 1.8					01.80- 01.82	JS373	12 1.0
					01.80- 01.82	JS670	12 1.4
Impreza 1.8		01.93- 01.95	JA1713IR	14 85	01.93- 01.95	JS1366	12 1.0 A37
		01.93- 01.95	JA1407IR	14 75	01.93- 01.95	JS670	12 1.4
					01.93- 01.95	JS671	12 1.0 A36
Impreza 1.8 4WD		01.93- 01.93	JA1713IR	14 85	01.93- 01.93	JS1366	12 1.0 A37
		01.93- 01.93	JA1407IR	14 75	01.93- 01.93	JS670	12 1.4
					01.93- 01.93	JS671	12 1.0 A36
Impreza 1.8 Brighton		01.96- 01.97	JA1407IR	14 75	01.96- 01.97	JS1366	12 1.0 A37
					01.96- 01.97	JS671	12 1.0 A36
					01.96- 01.96	JS670	12 1.4
Impreza 1.8 L		01.93- 01.96	JA1407IR	14 75	01.93- 01.96	JS1366	12 1.0 A37
		01.93- 01.96	JA1713IR	14 85	01.93- 01.96	JS670	12 1.4
					01.93- 01.96	JS671	12 1.0 A36
Impreza 1.8 L 4X4		01.95-	JA1713IR	14 85	01.95-	JS1366	12 1.0 A37
		01.95-	JA1407IR	14 75	01.95-	JS670	12 1.4
					01.95-	JS671	12 1.0 A36
Impreza 1.8 LS		01.93- 01.94	JA1407IR	14 75	01.93- 01.94	JS671	12 1.0 A36
		01.93- 01.94	JA1713IR	14 85	01.93- 01.94	JS1366	12 1.0 A37
					01.93- 01.94	JS670	12 1.4
Impreza 1.8 Outback		01.95-	JA1407IR	14 75	01.95-	JS1366	12 1.0 A37
					01.95-	JS670	12 1.4
					01.95-	JS671	12 1.0 A36
Impreza 2.2	[EJ22Z]				01.00- 01.01	JS1366	12 1.0 A37
					01.00- 01.01	JS670	12 1.4
					01.00- 01.01	JS671	12 1.0 A36
	[EJ22EZ]	01.98- 01.99	JA1407IR	14 75	01.98- 01.99	JS1366	12 1.0 A37
					01.98- 01.99	JS670	12 1.4
					01.98- 01.99	JS671	12 1.0 A36
Impreza 2.2 Brighton		01.97- 01.97	JA1407IR	14 75	01.97- 01.97	JS1366	12 1.0 A37
					01.97- 01.97	JS670	12 1.4
					01.97- 01.97	JS671	12 1.0 A36
Impreza 2.2 L		01.96- 01.97	JA1407IR	14 75	01.96- 01.97	JS1366	12 1.0 A37
					01.96- 01.97	JS671	12 1.0 A36
					01.96- 01.96	JS670	12 1.4
Impreza 2.2 LX		01.95- 01.96	JA1407IR	14 75	01.96- 01.96	JS1366	12 1.0 A37
		01.95- 01.95	JA1713IR	14 85	01.95- 01.96	JS670	12 1.4
					01.96- 01.96	JS671	12 1.0 A36
Impreza 2.2 Outback	[EJ22Z]				01.00- 01.01	JS1366	12 1.0 A37
					01.00- 01.01	JS670	12 1.4
					01.00- 01.01	JS671	12 1.0 A36
	[EJ22EZ]	01.98- 01.99	JA1407IR	14 75	01.98- 01.99	JS1366	12 1.0 A37
					01.98- 01.99	JS670	12 1.4
					01.98- 01.99	JS671	12 1.0 A36
		01.96- 01.97	JA1407IR	14 75	01.96- 01.97	JS1366	12 1.0 A37
					01.96- 01.97	JS671	12 1.0 A36
					01.96- 01.96	JS670	12 1.4
Impreza 2.5 Outback	[251]				01.02- 01.03	JS1366	12 1.0 A37
					01.02- 01.03	JS670	12 1.4
					01.02- 01.03	JS671	12 1.0 A36
Impreza 2.5 RS	[251]				01.02- 01.03	JS1366	12 1.0 A37
					01.02- 01.03	JS670	12 1.4
					01.02- 01.03	JS671	12 1.0 A36
	[EJ251]				01.00- 01.00	JS1366	12 1.0 A37
					01.00- 01.01	JS670	12 1.4
					01.00- 01.00	JS671	12 1.0 A36
	[EJ253]				01.99- 01.99	JS1366	12 1.0 A37
					01.99- 01.99	JS670	12 1.4
					01.99- 01.99	JS671	12 1.0 A36
	[EJ25D]	01.98- 01.98	JA1407IR	14 75	01.98- 01.98	JS671	12 1.0 A36
					01.98- 01.98	JS1366	12 1.0 A37
					01.98- 01.98	JS670	12 1.4
Impreza 2.5 TS	[251]				01.02- 01.03	JS1366	12 1.0 A37
					01.02- 01.03	JS670	12 1.4
					01.02- 01.03	JS671	12 1.0 A36
Justy 1.2 DL		01.89- 01.92	JA774IR	14 55	01.87- 01.92	JS557	12 0.8
Justy 1.2 GL		01.89- 01.94	JA774IR	14 55	01.87- 01.94	JS557	12 0.8
Justy 1.2 RS		01.89- 01.89	JA774IR	14 55	01.89- 01.89	JS557	12 0.8
Legacy 2.2	[EJ22E]				01.99- 01.99	JS1366	12 1.0 A37
					01.99- 01.99	JS671	12 1.0 A36
					01.99- 01.99	JS757	12 1.4
		01.90- 01.90	JA698IR	14 70	01.90- 01.95	JS1366	12 1.0 A37
					01.90- 01.90	JS670	12 1.4
					01.90- 01.95	JS757	12 1.4
					01.90- 01.95	JS671	12 1.0 A36
Legacy 2.2 4WD		01.93- 01.94	JA698IR	14 70	01.93- 01.94	JS1366	12 1.0 A37
					01.93- 01.94	JS757	12 1.4
					01.93- 01.94	JS671	12 1.0 A36
Legacy 2.2 Brighton					01.95- 01.98	JS757	12 1.4
					01.95- 01.98	JS1366	12 1.0 A37
					01.95- 01.98	JS671	12 1.0 A36
Legacy 2.2 GT		01.94- 01.94	JA698IR	14 70	01.94- 01.94	JS1366	12 1.0 A37
					01.94- 01.94	JS757	12 1.4
					01.94- 01.94	JS671	12 1.0 A36





Legacy 2.2 L	01.90- 01.94	JA698IR	14	70	01.90- 01.98	JS671	12	1.0	A36
					01.90- 01.98	JS1366	12	1.0	A37
					01.90- 01.98	JS757	12	1.4	
Legacy 2.2 L 4X4	01.92- 01.93	JA698IR	14	70	01.90- 01.94	JS670	12	1.4	
					01.92- 01.93	JS1366	12	1.0	A37
					01.92- 01.93	JS757	12	1.4	
Legacy 2.2 L Alpine	01.94- 01.94	JA698IR	14	70	01.92- 01.93	JS671	12	1.0	A36
					01.94- 01.94	JS1366	12	1.0	A37
					01.94- 01.94	JS757	12	1.4	
Legacy 2.2 L Outdoor	01.94- 01.94	JA698IR	14	70	01.94- 01.94	JS671	12	1.0	A36
					01.94- 01.94	JS1366	12	1.0	A37
					01.94- 01.94	JS757	12	1.4	
Legacy 2.2 L Sunsport	01.94- 01.94	JA698IR	14	70	01.94- 01.94	JS1366	12	1.0	A37
					01.94- 01.94	JS757	12	1.4	
					01.94- 01.94	JS671	12	1.0	A36
Legacy 2.2 LS	01.90- 01.94	JA698IR	14	70	01.94- 01.94	JS671	12	1.0	A36
					01.90- 01.96	JS1366	12	1.0	A37
					01.90- 01.96	JS757	12	1.4	
Legacy 2.2 LS 4X4	01.92- 01.93	JA698IR	14	70	01.90- 01.96	JS671	12	1.0	A36
					01.90- 01.94	JS670	12	1.4	
					01.92- 01.93	JS1366	12	1.0	A37
Legacy 2.2 LS SP	01.91- 01.93	JA698IR	14	70	01.92- 01.93	JS757	12	1.4	
					01.92- 01.93	JS671	12	1.0	A36
					01.91- 01.93	JS1366	12	1.0	A37
Legacy 2.2 LSI	01.91- 01.95	JA698IR	14	70	01.91- 01.93	JS757	12	1.4	
					01.91- 01.93	JS671	12	1.0	A36
					01.91- 01.95	JS1366	12	1.0	A37
Legacy 2.2 Outback					01.91- 01.95	JS757	12	1.4	
					01.91- 01.95	JS671	12	1.0	A36
					01.95- 01.96	JS1366	12	1.0	A37
Legacy 2.2 Postal					01.95- 01.96	JS671	12	1.0	A36
					01.95- 01.96	JS757	12	1.4	
					01.95- 01.98	JS1366	12	1.0	A37
Legacy 2.2 Turbo 4WD	01.92- 01.92	JA698IR	14	70	01.95- 01.98	JS671	12	1.0	A36
					01.92- 01.92	JS1366	12	1.0	A37
					01.92- 01.92	JS757	12	1.4	
Legacy 2.2 Turbo Sport	01.91- 01.94	JA698IR	14	70	01.91- 01.94	JS1366	12	1.0	A37
					01.91- 01.94	JS757	12	1.4	
					01.91- 01.94	JS671	12	1.0	A36
Legacy 2.5	[EJ251]				01.00- 01.00	JS1366	12	1.0	A37
					01.00- 01.00	JS671	12	1.0	A36
					01.00- 01.00	JS757	12	1.4	
	[EJ252]				01.00- 01.00	JS1366	12	1.0	A37
					01.00- 01.00	JS671	12	1.0	A36
					01.00- 01.00	JS757	12	1.4	
	[EJ253]				01.01- 01.03	JS1366	12	1.0	A37
					01.01- 01.03	JS671	12	1.0	A36
					01.01- 01.03	JS757	12	1.4	
	[EJ25D]				01.99- 01.99	JS1366	12	1.0	A37
					01.99- 01.99	JS671	12	1.0	A36
					01.99- 01.99	JS757	12	1.4	
Legacy 2.5 GT					01.96- 01.98	JS1366	12	1.0	A37
					01.96- 01.98	JS757	12	1.4	
					01.96- 01.98	JS671	12	1.0	A36
Legacy 2.5 Limited					01.97- 01.98	JS1366	12	1.0	A37
					01.97- 01.98	JS757	12	1.4	
					01.97- 01.98	JS671	12	1.0	A36
Legacy 2.5 LSI					01.96- 01.97	JS671	12	1.0	A36
					01.96- 01.97	JS757	12	1.4	
					01.96- 01.97	JS1366	12	1.0	A37
Legacy 2.5 OUTBACK	[EJ25D]				01.99- 01.99	JS1366	12	1.0	A37
					01.99- 01.99	JS671	12	1.0	A36
					01.99- 01.99	JS757	12	1.4	
					01.96- 01.98	JS1366	12	1.0	A37
					01.96- 01.98	JS757	12	1.4	
Loyale 1.8					01.96- 01.98	JS671	12	1.0	A36
					01.90- 01.94	JS670	12	1.4	
					01.90- 01.94	JS373	12	1.0	
Loyale 1.8 RS					01.90- 01.90	JS670	12	1.4	
					01.90- 01.90	JS373	12	1.0	
Loyale 1.8 Turbo					01.90- 01.90	JS373	12	1.0	
					01.90- 01.90	JS670	12	1.4	
Loyale 1.8 Turbo RS					01.90- 01.90	JS670	12	1.4	
					01.90- 01.90	JS373	12	1.0	
					01.90- 01.90	JS670	12	1.4	
Outback 2.5	[EJ253]				01.01- 01.03	JS1366	12	1.0	A37
					01.01- 01.03	JS671	12	1.0	A36
					01.01- 01.03	JS757	12	1.4	
Outback 3.0	[EZ30D]				01.01- 01.03	JS757	12	1.4	
					01.86- 01.89	JS670	12	1.4	
RX 1.8 Turbo				01.82- 01.87	JS373	12	1.0		
Standard 1.6				01.81- 01.87	JS670	12	1.4		
Standard 1.8				01.81- 01.87	JS373	12	1.0		
Star 1.3	01.72- 01.72	JA100	14	35					
SVX 3.3 4WD					01.94- 01.94	JS670	12	1.4	
SVX 3.3 L					01.94- 01.97	JS670	12	1.4	
SVX 3.3 LS					01.92- 01.95	JS670	12	1.4	
SVX 3.3 LSI					01.94- 01.97	JS670	12	1.4	
SVX 3.3 LSL					01.92- 01.94	JS670	12	1.4	
XT 1.8 DL					01.85- 01.88	JS670	12	1.4	
					01.85- 01.88	JS373	12	1.0	
XT 1.8 GL					01.85- 01.91	JS670	12	1.4	
					01.85- 01.91	JS373	12	1.0	
XT 1.8 GL-10					01.87- 01.87	JS670	12	1.4	
					01.87- 01.87	JS373	12	1.0	
XT 1.8 Turbo GL					01.87- 01.87	JS373	12	1.0	
					01.87- 01.87	JS670	12	1.4	
XT 1.8 Turbo GL-10					01.85- 01.87	JS373	12	1.0	
					01.85- 01.87	JS670	12	1.4	
XT 6 2.7					01.89- 01.91	JS373	12	1.0	
					01.89- 01.91	JS670	12	1.4	

**SUBARU Continued**

<b>PASSENGER CARS AO</b>							
1800 1.8 Turbo	[EA82]	11.85- 07.90	JA109IR	14 60	11.85- 07.90	JS373	12 1.0
					11.85- 07.90	JS670	12 1.4
Forester 2.5 RX Nato 4WD		11.02- 08.05	CA2083IR*	14 80			
		11.02- 08.05	CA2084IR*	14 110			
Impreza 1.5 4x4		02.08-	CA2083IR*	14 80			
Impreza 1.5 L		11.95- 09.00	JA1407IR	14 75			
Impreza 1.6		01.93- 08.98	JA1407IR	14 75			
					01.93- 08.98	JS1366	12 1.0 A37
					01.93- 08.98	JS671	12 1.0 A36
					AT 01.93- 08.98	JS373	12 1.0
Impreza 2.0		09.98- 09.00	JA1704IR	14 80			
					AT 09.98- 09.00	JS670	12 1.4
					09.98- 09.00	JS1366	12 1.0 A37
					09.98- 09.00	JS671	12 1.0 A36
Impreza 2.0 4WD	[EJ205P]	09.98- 09.00	JA1704IR	14 80			
					09.98- 09.00	JS1366	12 1.0 A37
					AT 09.98- 09.00	JS670	12 1.4
					09.98- 09.00	JS671	12 1.0 A36
Impreza 2.0 AWD					10.05-	JS1366	12 1.0
Impreza 2.0 WRX STi 4WD					10.05-	JS1366	12 1.0
Impreza 2.0 WRX STi 4WD		10.05-	CA2083IR*	14 80	10.05-	JS1366	12 1.0
Impreza 2.2 GX 4WD		11.95- 09.00	JA1704IR	14 80			
		09.98- 09.00	JA1407IR	14 75			
					AT 11.95- 09.00	JS670	12 1.4
					11.95- 09.00	JS671	12 1.0 A36
					11.95- 09.00	JS1366	12 1.0 A37
Legacy 1.6	[EJ16]	05.89- 12.93	JA698IR	14 70			
					05.89- 12.93	JS671	12 1.0
Legacy 1.6 GL	[EJ16]	05.89- 12.93	JA698IR	14 70			
					05.89- 12.93	JS671	12 1.0
Legacy 1.8 4WD	[EJ18E]	05.96- 09.98	JA1407IR	14 75			
		05.96- 09.98	JA1713IR	14 85			
					AT 05.96- 09.98	JS670	12 1.4
					05.96- 09.98	JS1366	12 1.0 A37
					05.96- 09.98	JS671	12 1.0 A36
Legacy 2.0 GL	[EJ20E]	08.91- 12.93	JA698IR	14 70			
					08.91- 12.93	JS671	12 1.0 A36
					08.91- 12.93	JS1366	12 1.0 A37
Legacy 2.0 Turbo R 4WD		06.05-	CA2084IR*	14 110	06.05-	JS1366	12 1.0
Legacy 2.2 GX		05.89- 10.91	JA698IR	14 70			
					AT 05.89- 10.91	JS373	12 1.0
					05.89- 10.91	JS671	12 1.0
Leone 1.6	[EA71]				06.85- 07.90	JS373	12 1.0
Leone 1.8 GL	[EA81]	08.86- 07.89	JA109IR	14 60			
					08.86- 07.89	JS670	12 1.4
					08.86- 07.89	JS373	12 1.0
Leone 1.8 Turbo 4WD	[EA82]	06.85- 07.86	JA109IR	14 60			
					06.85- 07.86	JS373	12 1.0
					06.85- 07.86	JS670	12 1.4
SVX 3.3 4WD					02.94- 12.97	JS670	12 1.4
<b>Suzuki</b>							
<b>PASSENGER CARS EU</b>							
Alto 0.8	[SB308,CA][F8B]	01.86- 11.93	JA1711R	14 40	01.86- 11.93	JS630	12 0.6
Alto 1.0	[EF][G10B]	09.94- 06.02	JA682IR	14 50	09.94- 06.02	JS512	12 0.8
		09.94- 06.02	JA798IR	14 50	09.94- 06.02	JS1092	12 1.2
Alto 1.1		06.02-	JA1293IR	14 70	06.02-	JS512	12 0.8
Baleno 1.3	[EG][G13BA]	09.96- 05.02	JA1293IR	14 70	09.96- 05.02	JS512	12 0.8
		09.96- 05.02	JA1356IR	14 85			
Baleno 1.3 16V	[G13BB]				03.97- 05.02	CS1504*	12 1.7
					03.97- 05.02	JS512	12 0.8
Baleno 1.3 i 16V	[G13B]	04.95- 05.02	JA1293IR	14 70			
					07.95- 05.02	JS512	12 0.8
					07.95- 05.02	CS1504*	12 1.7
Baleno 1.6 i 16V	[EG][G16B]	08.96- 05.02	JA1293IR	14 70			
					08.96- 05.02	JS1092	12 1.2
					08.96- 05.02	CS1504*	12 1.7
					08.96- 05.02	JS512	12 0.8
	[G16B]	07.95- 05.02	JA1293IR	14 70			
		07.95- 05.02	JA1356IR	14 85			
					07.95- 05.02	JS1092	12 1.2
					07.95- 05.02	JS512	12 0.8
					07.95- 05.02	CS1504*	12 1.7
Baleno 1.6 i 16V 4WD	[G16B]	04.95- 05.02	JA1293IR	14 70			
					07.95- 05.02	JS1092	12 1.2
					07.95- 05.02	CS1504*	12 1.7
					07.95- 05.02	JS512	12 0.8
Baleno 1.6 i 16V 4x4	[EG][G16B]	08.96- 05.02	JA1293IR	14 70			
					08.96- 05.02	CS1504*	12 1.7
					08.96- 05.02	JS1092	12 1.2
					08.96- 05.02	JS512	12 0.8
Baleno 1.8 GT	[EG][J18A]	03.96- 05.02	JA1293IR	14 70 ▲			
					03.96- 05.02	CS1504*	12 1.7
	[J18A]	03.96- 05.02	JA1293IR	14 70 ▲			
					03.96- 05.02	CS1504*	12 1.7
					03.96- 05.02	JS1092	12 1.2
Baleno 1.8 i 16V	[J18A]	08.96- 05.02	JA1293IR	14 70 ▲			
					08.96- 05.02	JS1092	12 1.2
					08.96- 05.02	CS1504*	12 1.7
Baleno 1.9 TD	[EG][XUD9]	04.98- 05.02	CA1043IR	14 80			
					04.98- 05.02	CS1504*	12 1.7
	[XUD9]	04.98- 05.02	CA1043IR	14 80			
					04.98- 05.02	JS1092	12 1.2
					04.98- 05.02	CS1504*	12 1.7
					04.98- 05.02	JS1092	12 1.2
Carry 0.8	[ST90V][F8A]	11.80- 10.85	JA118	14 35			
Carry 1.0	[ED][F10A]	10.85- 09.94	JA1711R	14 40			
	[SK410][F10A]	07.85- 12.90	JA1711R	14 40			
Grand Vitara 1.6	[G16B]	03.98-	JA1293IR	14 70			
		03.98-	JA1612IR	14 60			
	[M16A]	10.05-	CA2004IR	14 80			
					10.05-	JS1310	12 1.0
Grand Vitara 1.9 DDiS	[F9Q]	10.05-	CA1991IR*	14 140	10.05-	CS1193	12 1.8
Grand Vitara 2.0	[J20A]	10.05-	CA2004IR	14 80	10.05-	CS1487*	12 1.4
		10.05-	JA1293IR	14 70			
		03.98-	JA1612IR	14 60			
					AT 03.98-	JS380	12 1.0
Grand Vitara 2.0 4x4	[FT, GT][J20A]	04.98- 08.05	JA1293IR	14 70			
					AT 04.98- 08.05	JS1153	12 1.4
					AT 04.98- 08.05	JS380	12 1.0
Grand Vitara 2.0 HDi	[FT, GT][RHZ]	07.01-	CA1553IR	14 150			
	[RHW]	11.00- 12.05	CA1553IR	14 150			
	[RHZ]	11.00- 12.05	CA1553IR	14 150			
					11.00- 12.05	CS1444	12 2.0
Grand Vitara 2.0 TD Intercooler	[RF]	03.98-	JA1430IR	14 70			
Grand Vitara 2.5 V6 24V	[FT, GT][H25A]	08.04-	JA1356IR	14 85			
					08.04-	JS1153	12 1.4
Grand Vitara 2.7	[FT, GT]				06.01- 08.06	JS1153	12 1.4
Grand Vitara 2.7 XL-7	[FT, GT][H27A]				04.03-	JS1153	12 1.4
Grand Vitara 2.7 V6	[H27A]				09.01-	JS1153	12 1.4
Ignis 1.3	[FH][M13A]	10.00- 09.03	JA1293IR	14 70			
	[M13A]	10.00-	CA2077IR*	14 70			
		09.03-	JA1293IR	14 70			
					10.00-	JS1310	12 1.0
					10.00-	JS1310	12 1.0
Ignis 1.3 4WD	[FH][M13A]	10.00- 09.03	JA1293IR	14 70			
Ignis 1.3 4x4	[M13A]	09.03-	CA2077IR*	14 70			
		09.03-	JA1293IR	14 70			
					09.03-	JS1310	12 1.0 ND
					09.03-	JS1319	12 1.2 MI
Ignis 1.3 DDiS	[Z13DT]	09.03-	CA1855IR	14 75			
		09.03-	CA1862IR	14 90			
					09.03-	CS1334	12 1.1
Ignis 1.5	[FH][M15A]	08.03- 12.05	JA1803IR	14 75			
	[M15A]	09.03-	CA2077IR*	14 70			
		09.03-	JA1803IR	14 75			
					10.03-	JS1319	12 1.2
					10.03-	JS1310	12 1.0
Ignis 1.5 4WD	[M15A]	09.03-	CA2077IR*	14 70			
		09.03-	JA1803IR	14 75			
					10.03-	JS1319	12 1.2
					10.03-	JS1310	12 1.0
Ignis 1.5 Sport	[FH][M15A]	12.03-	JA1803IR	14 75			
	[FJ][M13A]	02.01-	JA1612IR	14 60			
	[G13BB]	09.98-	JA1612IR	14 60			
					02.01-	JS380	12 1.0
					09.98-	JS380	12 1.0



Jimny 1.3 16V 4WD	(FJ)[M13A]	02.01-08.05-	JA1612IR	14 60	02.01-08.05-	JS380	12 1.0
			JA1803IR	14 75	08.05-09.98-	JS1319	12 1.2
	[G13BB]	09.98-09.98-	JA1293IR	14 70	09.98-	JS380	12 1.0
			JA1612IR	14 60			
Jimny 1.5 DDiS 4WD	(FJ)[K9K700]				12.03-	CS1273	12 1.1
	Liana 1.3 (ER)[M13A]	03.01-	JA1803IR	14 75	03.01-03.01-	JS1310	12 1.0
	[M13A]	03.02-	CA2077IR*	14 70	03.02-03.02-	JS1310	12 1.0
Liana 1.4 DDiS	(ER)[8HY]	03.05-	CA1674IR	14 150	03.02-	JS1319	12 1.2
Liana 1.6	(ER)[M16A]	03.01-	JA1803IR	14 75	03.01-03.01-	JS1310	12 1.0
		01.05-	JA1803IR	14 75	01.05-	JS1319	12 1.2
	[M16A]	03.01-	JA1803IR	14 75	03.01-03.01-	JS1310	12 1.0
Liana 1.6 4WD	(ER)[M16A]	03.01-	JA1803IR	14 75	03.01-03.01-	JS1310	12 1.0
		01.05-	JA1803IR	14 75	01.05-	JS1319	12 1.2
	[M16A]	03.01-	JA1803IR	14 75	03.01-	JS1319	12 1.2
LJ 80 0.8 4WD	[F8A]	01.80-01.84	JA118	14 35	01.80-01.84	JS330#	12 0.6
Samurai 1.0	(SJ410)[F10A]				11.88-	JS394	12 0.8
Samurai 1.3	(SJ413)[G13A]	11.88-	JA188IR	14 45	11.88-	JS380	12 1.0
	[G13BA]	11.88-	JA188IR	14 45	11.88-	JS380	12 1.0
Samurai 1.9 TD	(SJ)[XUD9]	11.98-	CA637IR	14 70	11.98-	CS373	12 1.7
		11.98-	CA637IR	14 70	11.98-	CS373	12 1.7
SJ 410 1.0 4WD	(SJ410)[F10A]	09.81-09.87-	JA130	14 30	01.87-09.87-	JS394	12 0.8
		12.88-	JA1711R	14 40	03.87-	JS330#	12 0.6
SJ 413 1.3	(SJ413)[G13A]	09.84-09.87-	JA188IR	14 45	09.84-09.87-	JS380	12 1.0
Splash 1.0		01.08-	CA2026IR*	14 75			
Splash 1.2	[K12B]	01.08-	CA2026IR*	14 75			
Splash 1.2 VVT	[K12B]	06.11-	CA2026IR*	14 75			
Splash 1.3 CDTi	[Z13DTJ]	01.08-	CA1862IR	14 90			
Swift 1.0	(SA310,AA41,43)[G10]	10.83-03.89	JA188IR	14 45	10.83-03.89	JS512	12 0.8
					AT 10.83-03.89	JS1092	12 1.2
	[G10A]	10.84-03.89	JA188IR	14 45	AT 10.84-03.89	JS1092	12 1.2
					10.84-03.89	JS512	12 0.8
	(SF310,AA44)[G10A]	03.89-12.04	JA798IR	14 50	03.89-12.04	JS512	12 0.8
					AT 03.89-12.04	JS1092	12 1.2
Swift 1.0 i	(SF310,AA44)[G10A]	03.89-12.04	JA798IR	14 50	03.89-12.04	JS512	12 0.8
Swift 1.0 Turbo	(SA310)	02.85-12.89	JA188IR	14 45	02.85-12.89	JS512	12 0.8
Swift 1.3	(SA413,AA51)[G13A]	10.84-03.89	JA188IR	14 45	10.84-03.89	JS512	12 0.8
					AT 10.84-03.89	JS1092	12 1.2
	(SA413,AA51,AA53)[G13A]	10.84-03.89	JA188IR	14 45	AT 10.84-03.89	JS1092	12 1.2
					10.84-03.89	JS512	12 0.8
	(SA413,AA53)[G13A]	08.86-03.89	JA188IR	14 45	08.86-03.89	JS512	12 0.8
	(SF413)[G13A]	03.89-12.91	JA798IR	14 50	03.89-12.91	JS1092	12 1.2
					03.89-12.91	JS512	12 0.8
	(SF413,AB35)[G13A]	03.89-08.96	JA682IR	14 50	03.89-08.96	JS1092	12 1.2
		03.89-08.96	JA798IR	14 50	03.89-08.96	JS512	12 0.8
	(SF413,AH35)[G13A]	03.89-08.96	JA682IR	14 50	03.89-08.96	JS512	12 0.8
	03.89-08.96	JA798IR	14 50	03.89-08.96	JS1092	12 1.2	
(SF413,AK35)[G13B]	09.91-12.95	JA798IR	14 50	09.91-12.95	JS512	12 0.8	
				09.91-12.95	JS1092	12 1.2	
	(SG)[M13A]	Chas. 00500001-02.05-	CA2026IR*	14 75	02.05-	JS1310	12 1.0
		Chas. -00500000 02.05-	CA1943IR*	14 75			
Swift 1.3 4WD	(SF413, AA35)[G13A]	03.89-05.01	JA798IR	14 50	03.89-05.01	JS512	12 0.8
	(SF413,AF35)[G13A]	10.89-12.91	JA798IR	14 50	10.89-12.91	JS512	12 0.8
	(SG)[M13A]	Chas. -00400000 01.06-	JA1803IR	14 75	01.06-	JS1310	12 1.0
Swift 1.3 GTi	(SA413,AA33)[G13B]	08.86-03.89	JA682IR	14 50	08.86-03.89	JS1092	12 1.2
					08.86-03.89	JS512	12 0.8
	(SF413,AA34)[G13B]	03.89-05.01	JA798IR	14 50	03.89-05.01	JS1092	12 1.2
					03.89-05.01	JS512	12 0.8
Swift 1.3 GXi	(SA413,AA33)[G13B]	08.86-03.89	JA682IR	14 50	A13 08.86-03.89	JS1092	12 1.2
Swift 1.3 DDiS	(SG)[Z13DT]	08.05-	CA1862IR	14 90	08.05-	CS1334	12 1.1
Swift 1.5	(SG)[M15A]	02.05-	CA1943IR*	14 75	02.05-	JS1310	12 1.0
Swift 1.6	(SF416,AH14)[G16B]	11.89-12.91	JA682IR	14 50	A32 11.89-12.91	JS1092	12 1.2
					11.89-12.91	JS512	12 0.8
	(SG)[M16A]	05.06-	CA2004IR	14 80	05.06-	JS1310	12 1.0
Swift 1.6 4WD	[G16B]	11.89-12.91	JA682IR	14 50	A32 11.89-12.91	JS1092	12 1.2
					11.89-12.91	JS512	12 0.8
Swift 1.6 i	(SF416,AH14)[G16B]	01.91-09.95	JA682IR	14 50	09.91-09.95	JS512	12 0.8
					A32 09.91-09.95	JS1092	12 1.2
Swift 1.6 i 4WD	(SF416,AJ14)[G16B]	01.91-09.95	JA682IR	14 50	A32 09.91-09.95	JS1092	12 1.2
					09.91-09.95	JS512	12 0.8
SX4 1.5		06.06-	CA2026IR*	14 75	06.06-	JS1310	12 1.0
SX4 1.6	[M16A]				10.07-	JS1310	12 1.0
SX4 1.6 WT	[M16A]	06.06-	CA2026IR*	14 75	06.06-	JS1310	12 1.0
SX4 1.6 WT 4WD	[M16A]	06.06-	CA2026IR*	14 75	06.06-	JS1310	12 1.0
SX4 1.6 VVT	(RW416)[M16A]				07.09-	JS1310	12 1.0
SX4 1.6 VVT 4x4	(RW416)[M16A]				07.09-	JS1310	12 1.0
SX4 1.9 DDiS	(RW419)[D19AA]	06.06-	CA1995IR	14 140	06.06-	CS1335	12 2.2
SX4 1.9 DDiS 4WD		06.06-	CA1995IR	14 140	06.06-	CS1335	12 2.2
Vitara 1.6	(ET)[G16A]	09.88-03.98	JA682IR	14 50	09.88-03.98	JS380	12 1.0
	(TA)[G16A]	07.90-03.98	JA682IR	14 50	07.90-03.98	JS380	12 1.0
Vitara 1.6 16V	(ET)[G16B]	09.91-03.98	JA682IR	14 50	09.91-03.98	JS380	12 1.0
Vitara 1.6 i 4WD	(ET)[G16B]	07.90-02.97	JA682IR	14 50	07.90-03.99	JS380	12 1.0
		07.95-03.99	JA1293IR	14 70			
Vitara 1.9 Diesel	(ET)[XUD9A]	01.95-03.98	CA637IR	14 70	01.95-03.98	CS373	12 1.7
	[XUD9A]				08.96-03.99	CS373	12 1.7
Vitara 1.9 Diesel 4WD	[XUD9A]	01.95-03.98	CA637IR	14 70	01.95-03.98	CS373	12 1.7
Vitara 2.0 16V	[J20A]	12.96-03.98	JA1293IR	14 70	12.96-03.98	JS1153	12 1.4
		12.96-03.98	JA1356IR	14 85			
Vitara 2.0 16V 4WD	[J20A]	12.96-03.99	JA1293IR	14 70	12.96-03.99	JS1153	12 1.4
Vitara 2.0 i Lang	[H20A]	12.94-03.98	JA1293IR	14 70	12.94-03.98	JS1153	12 1.4
		03.95-03.98	JA1356IR	14 85			
Vitara 2.0 Diesel 4WD	[RF]	03.95-03.98	JA1430IR	14 70	03.95-03.98	JS365	12 2.0
Vitara 2.0 TD Intercooler 4WD	[RF]	12.95-12.98	JA1430IR	14 70	12.95-03.98	JS365	12 2.0
Vitara 2.5 i 24V	(ET)[H25A]	03.95-03.98	JA1356IR	14 85	03.95-03.98	JS1153	12 1.4
Vitara 2.5 V6 24V	[H25A]	04.98-	JA1356IR	14 85	04.98-	JS1153	12 1.4
Wagon R 1.0	[K10A]	09.97-05.00	JA1612IR	14 60	09.97-05.00	CS1210	12 1.0
Wagon R+ 1.2 4WD	[K12A]	02.98-05.00	JA1293IR	14 70	02.98-05.00	CS1210	12 1.0
Wagon R+ 1.2 i	[K12A]	02.98-05.00	JA1293IR	14 70	02.98-05.00	CS1210	12 1.0
Wagon R+ 1.25 DDiS	(MM)[Z13DT]	09.03-	CA1855IR	14 75	09.03-	CS1334	12 1.1
		09.03-	CA1862IR	14 80			
Wagon R+ 1.3	(MM)[G13BB]	05.00-	JA1356IR	14 85	05.00-	JS512	12 0.8
		AC 05.00-	JA1293IR	14 70			
	[M13A]	09.03-	CA1943IR*	14 75	09.03-	JS1310	12 1.0
Wagon R+ 1.3 4WD	(MM)[G13BB]	10.01-	JA1356IR	14 85	10.01-	JS1092	12 1.2
		AC 10.01-	JA1293IR	14 70	10.01-	JS512	12 0.8
Wagon R+ 1.3 VVT 4WD	(MM)[M13A]	09.03-	CA1943IR*	14 75	09.03-	JS1310	12 1.0
X-90 1.6 i 16V	[G16B]	09.95-	JA682IR	14 50	09.95-	JS380	12 1.0



SUZUKI Continued

X-90 1.6 16V 4WD	[G16B]	09.95-	JA682IR	14 50	09.95-	JS380	12 1.0
<b>PASSENGER CARS US</b>							
Aerio 2.0					01.02- 01.03	JS1092	12 1.2
Aerio 2.0 SX					01.02- 01.03	JS1092	12 1.2
Esteem 1.6	[G16S]	01.99- 01.99	JA1293IR	14 70	01.99- 01.99	JS1092	12 1.2
		01.00- 01.00	JA1293IR	14 70	01.00- 01.00	JS1092	12 1.2
Esteem 1.6 GL		01.95- 01.98	JA1293IR	14 70	01.95- 01.98	JS1092	12 1.2
Esteem 1.6 GLX		01.95- 01.98	JA1293IR	14 70	01.95- 01.98	JS1092	12 1.2
Esteem 1.8					01.99- 01.02	JS1092	12 1.2
Grand Vitara 2.5					01.99- 01.03	JS1153	12 1.4
Grand Vitara 2.7 XL-7					01.01- 01.02	JS1153	12 1.4
Samurai 1.3		01.86- 01.90	JA188IR	14 45	01.86- 01.90	JS380	12 1.0
Samurai 1.3 JA		01.91- 01.93	JA188IR	14 45	01.91- 01.93	JS380	12 1.0
Samurai 1.3 JL		01.91- 01.95	JA188IR	14 45	01.91- 01.95	JS380	12 1.0
Samurai 1.3 JS		01.91- 01.91	JA188IR	14 45	01.91- 01.91	JS380	12 1.0
Sidekick 1.3		01.89- 01.89	JA188IR	14 45	01.89- 01.89	JS380	12 1.0
Sidekick 1.6		01.89- 01.93	JA682IR	14 50	01.89- 01.93	JS380	12 1.0
Sidekick 1.6 JA		01.96- 01.98	JA682IR	14 50	01.96- 01.98	JS380	12 1.0
Sidekick 1.6 JL		01.91- 01.91	JA682IR	14 50			
Sidekick 1.6 JLX		01.90- 01.95	JA682IR	14 50	01.90- 01.95	JS380	12 1.0
Sidekick 1.6 JS		01.90- 01.98	JA682IR	14 50	01.90- 01.98	JS380	12 1.0
Sidekick 1.6 JX		01.90- 01.98	JA682IR	14 50	01.90- 01.98	JS380	12 1.0
Sidekick 1.8 Sport					01.96- 01.98	JS380	12 1.0
Swift 1.3		01.89- 01.01	JA682IR	14 50	01.89- 01.01	JS512	12 0.8
		01.89- 01.91	JA798IR	14 50	01.89- 01.01	JS1092	12 1.2
Swift 1.3 DLX		01.95- 01.98	JA682IR	14 50	01.95- 01.98	JS512	12 0.8
					01.95- 01.98	JS1092	12 1.2
Swift 1.3 GA		01.90- 01.98	JA682IR	14 50	01.90- 01.98	JS1092	12 1.2
		01.90- 01.94	JA798IR	14 50	01.90- 01.98	JS512	12 0.8
Swift 1.3 GL		01.90- 01.91	JA682IR	14 50	01.90- 01.91	JS1092	12 1.2
		01.90- 01.91	JA798IR	14 50	01.90- 01.91	JS512	12 0.8
Swift 1.3 GLX		01.91- 01.91	JA682IR	14 50	01.91- 01.91	JS1092	12 1.2
		01.91- 01.91	JA798IR	14 50	01.91- 01.91	JS512	12 0.8
Swift 1.3 GS		01.92- 01.94	JA682IR	14 50	01.92- 01.94	JS512	12 0.8
		01.92- 01.94	JA798IR	14 50	01.92- 01.94	JS1092	12 1.2
Swift 1.3 GT		01.89- 01.94	JA798IR	14 50	01.89- 01.94	JS512	12 0.8
		01.89- 01.94	JA682IR	14 50	01.89- 01.94	JS1092	12 1.2
Swift 1.3 L		01.90- 01.94	JA682IR	14 50	01.90- 01.94	JS512	12 0.8
		01.90- 01.94	JA798IR	14 50	01.90- 01.94	JS1092	12 1.2
Swift 1.3 S		01.90- 01.90	JA798IR	14 50	01.90- 01.90	JS1092	12 1.2
		01.90- 01.90	JA682IR	14 50	01.90- 01.90	JS512	12 0.8
Vitara 1.6					01.99- 01.01	JS380	12 1.0
					01.99- 01.01	JS1153	12 1.4
Vitara 2.0					01.99- 01.00	JS380	12 1.0
					01.99- 01.00	JS1153	12 1.4
X-90 1.6 JLX		01.96- 01.98	JA682IR	14 50	01.96- 01.98	JS380	12 1.0
<b>PASSENGER CARS AO</b>							
Samurai 1.9 Diesel	(SJ)	09.00-	CA637IR	14 70	09.00-	CS373	12 1.7
<b>Saab</b>							
<b>PASSENGER CARS EU</b>							
90 2.0	[B20I]	08.84- 08.87	CA207IR	14 70	08.84- 08.87	CS346	12 1.4
95 1.5 V4	[V4]				08.68- 12.78	CS72	12 1.1
96 1.5 V4	[V4]				08.68- 08.80	CS72	12 1.1
99 2.0	[BT20]				03.76- 05.78	CS89	12 1.1
99 2.0 EMS	[BI20]				09.74- 12.78	CS89	12 1.1
99 2.0 GL	[B20C]	09.80- 12.84	CA207IR	14 70	09.74- 12.84	CS89	12 1.1
	[B20I]	09.80- 12.84	CA207IR	14 70	09.74- 12.84	CS89	12 1.1
99 2.0 Turbo	[BSI20]	10.77- 06.80	CA207IR	14 70	10.77- 06.80	CS89	12 1.1
600 1.5		01.80- 12.86	CA129IR	14 55	01.80- 12.86	CS285	12 0.8
900 2.0	[B20]	09.79- 08.83	CA207IR	14 70	09.79- 08.83	CS89	12 1.1
	[B201XC]	09.84- 08.90	CA310IR	14 70	09.83- 08.84	CS89	12 1.1
		09.84- 08.90	CA566IR	14 80	09.84- 08.90	CS346	12 1.4
	[B202XI]	01.86- 12.88	CA566IR	14 80	01.86- 12.88	CS346	12 1.4
	[B202XL]	01.86- 12.88	CA566IR	14 80	01.86- 12.88	CS346	12 1.4
	[B20T]	09.80- 08.83	CA207IR	14 70	09.78- 08.84	CS89	12 1.1
	[BT20]	09.80- 08.83	CA207IR	14 70	09.78- 08.83	CS89	12 1.1
900 2.0 EMS	[BI20]	09.80- 12.80	CA207IR	14 70	01.79- 12.80	CS89	12 1.1
900 2.0 -16 Turbo	[B202L]	01.93- 08.93	CA310IR	14 70	01.93- 08.93	CS346	12 1.4
		01.93- 08.93	CA566IR	14 80			
	[B202S]	07.91- 08.93	CA310IR	14 70	07.91- 08.93	CS346	12 1.4
		07.91- 08.93	CA566IR	14 80			
	[B202XL]	09.84- 08.93	CA310IR	14 70	01.84- 08.84	CS89	12 1.1
		09.84- 08.93	CA566IR	14 80	09.84- 08.93	CS346	12 1.4
	[B204L]	07.93- 08.98	CA1138IR	14 90	07.93- 08.98	CS372	12 1.4
900 2.0 -16	[B202I]	01.89- 08.93	CA310IR	14 70	01.89- 08.93	CS346	12 1.4
		01.89- 08.93	CA566IR	14 80			
900 2.0 16V	[B202]	04.90- 12.90	CA310IR	14 70	04.90- 12.90	CS346	12 1.4
		04.90- 12.90	CA566IR	14 80			
900 2.0 EMS	[BI20]	09.78- 08.79	CA207IR	14 70	09.78- 08.79	CS89	12 1.1
900 2.0 i	[B201]	09.85- 08.90	CA310IR	14 70	09.85- 08.90	CS346	12 1.4
		09.85- 08.90	CA566IR	14 80			
	[B201XI]	09.84- 08.90	CA310IR	14 70	09.83- 08.84	CS89	12 1.1
		09.84- 08.90	CA566IR	14 80	09.84- 08.90	CS346	12 1.4
	[B204I]	12.93- 08.98	CA1138IR	14 90	12.93- 08.98	CS372	12 1.4
	[B206I]	07.93- 08.98	CA1138IR	14 90	07.93- 08.98	CS372	12 1.4
	[BI20]	11.80- 08.83	CA207IR	14 70	11.80- 08.83	CS89	12 1.1
900 2.0 Turbo	[B201S]	09.78- 08.80	CA125IR#	14 65	09.78- 08.84	CS89	12 1.1
		09.78- 08.83	CA207IR	14 70	09.84- 07.85	CS346	12 1.4
		09.84- 07.85	CA310IR	14 70			
		09.84- 07.85	CA566IR	14 80			
	[B201XL]	01.86- 12.91	CA310IR	14 70	01.86- 12.91	CS346	12 1.4
		01.86- 12.91	CA566IR	14 80			
	[B202XL]	11.86- 08.93	CA310IR	14 70	11.86- 08.93	CS346	12 1.4
		11.86- 08.93	CA566IR	14 80			
	[BSI20]	09.78- 08.80	CA125IR#	14 65	09.78- 08.84	CS89	12 1.1
		09.78- 08.83	CA207IR	14 70	09.84- 07.85	CS346	12 1.4
		09.84- 07.85	CA310IR	14 70			
		09.84- 07.85	CA566IR	14 80			
900 2.0 Turbo S	[B202S]	09.91- 06.94	CA310IR	14 70	09.91- 06.94	CS346	12 1.4
		09.91- 06.94	CA566IR	14 80			
	[B202XL]	09.84- 08.93	CA310IR	14 70	02.84- 08.84	CS89	12 1.1
		09.84- 08.93	CA566IR	14 80	09.84- 08.93	CS346	12 1.4
900 2.1 -16	[B212I]	08.90- 12.93	CA566IR	14 80	08.90- 12.93	CS878	12 1.4
900 2.3 -16	[B234I]	07.93- 08.98	CA1138IR	14 90	07.93- 08.98	CS372	12 1.4
900 2.5 i V6	[B258I]	07.93- 10.98	CA1070IR	14 120	07.93- 10.98	CS802	12 1.4
		07.93- 10.98	CA1103IR	14 100			
		12.93- 10.98	CA1138IR	14 90			



9000 2.0		10.88- 08.90	CA5671R	14 80		10.88- 08.90	CS346	12 1.4
9000 2.0 -16 Turbo	[B202L]	06.89- 12.92	CA5671R	14 80		06.89- 12.92	CS346	12 1.4
	[B202S]	05.88- 08.92	CA5671R	14 80		05.88- 08.92	CS346	12 1.4
		09.91- 12.98	CA3101R	14 70		09.91- 12.98	CS346	12 1.4
		09.91- 12.98	CA5661R	14 80				
	[B202XL]	09.84- 08.85	CA3101R	14 70		09.84- 08.93	CS346	12 1.4
	[B204E]	09.84- 08.93	CA5671R	14 80				
		09.94- 12.98	CA10701R	14 120		09.94- 12.98	CS372	12 1.4
		09.94- 12.98	CA12461R	14 90				
9000 2.0 -16 Turbo CS	[B202L]	05.88- 08.92	CA5671R	14 80		05.88- 08.92	CS346	12 1.4
9000 2.0 -16 Turbo ND	[B202S]	09.92- 08.93	CA5671R	14 80		09.93- 12.98	CS372	12 1.4
		09.93- 12.98	CA12461R	14 90		09.92- 08.93	CS346	12 1.4
	[B204E]	09.94- 12.98	CA10701R	14 120		09.94- 12.98	CS372	12 1.4
		09.94- 12.98	CA12461R	14 90				
9000 2.0 -16	[B202I]	01.89- 08.93	CA5671R	14 80		01.89- 08.93	CS346	12 1.4
	[B202XI]	12.85- 12.88	CA5671R	14 80		12.85- 12.88	CS346	12 1.4
	[B204E]	09.94- 12.98	CA12461R	14 90		09.94- 12.98	CS372	12 1.4
	[B204I]	09.93- 08.94	CA5661R	14 80		09.93- 12.98	CS372	12 1.4
		09.94- 12.98	CA12461R	14 90				
9000 2.0 16V		09.89- 01.90	CA5671R	14 80		09.89- 01.90	CS346	12 1.4
		09.89- 01.90	CA3101R	14 70				
9000 2.3	[B234I]	10.89- 01.92	CA12461R	14 90		10.89- 12.93	CS878	12 1.4
		10.89- 12.93	CA5661R	14 80		10.89- 01.92	CS372	12 1.4
9000 2.3 -16 Ecopower	[B234E]	09.93- 08.94	CA5661R	14 80		09.93- 12.98	CS372	12 1.4
		08.94- 12.98	CA12461R	14 90				
9000 2.3 -16 Ecopower CSE	[B234E]	09.93- 12.98	CA12461R	14 90		09.93- 12.98	CS372	12 1.4
9000 2.3 -16 Turbo	[B234L]	09.90- 08.94	CA5661R	14 80		09.90- 08.93	CS878	12 1.4
		08.94- 12.98	CA12461R	14 90		09.93- 12.98	CS372	12 1.4
9000 2.3 -16 Turbo CS	[B234L]	09.90- 08.93	CA5661R	14 80		09.93- 12.98	CS372	12 1.4
		09.93- 12.98	CA12461R	14 90		09.90- 08.93	CS878	12 1.4
9000 2.3 -16 Turbo CSE	[B234L]	09.93- 12.98	CA12461R	14 90		09.93- 12.98	CS372	12 1.4
		09.93- 12.98	CA5661R	14 80				
9000 2.3 -16	[B234I]	08.89- 08.94	CA5661R	14 80		09.93- 12.98	CS372	12 1.4
		08.94- 12.98	CA12461R	14 90		08.89- 08.93	CS878	12 1.4
9000 2.3 -16 Aero CS	[B234R]	02.93- 12.98	CA12461R	14 90		09.93- 12.98	CS372	12 1.4
		02.93- 12.98	CA5661R	14 80		02.93- 08.93	CS878	12 1.4
9000 2.3 -16 CS	[B234I]	09.89- 08.93	CA5661R	14 80		09.93- 12.98	CS372	12 1.4
		09.93- 12.98	CA12461R	14 90		09.89- 08.93	CS878	12 1.4
9000 2.3 -16 CSE	[B234I]	09.93- 12.98	CA12461R	14 90		09.93- 12.98	CS372	12 1.4
9000 3.0	[B308I]	07.94- 12.98	CA12461R	14 90		07.94- 12.98	CS802	12 1.4
9-3 1.8 i	[Z18XE]	09.04-	CA17651R	14 120		09.04-	CS1257	12 1.1
9-3 1.8 Turbo BioPower	[B207E]	01.07-	CA19161R	14 120		01.07-	CS1291	12 1.8
		01.07-	CA19161R	14 120		01.07-	CS1291	12 1.8
9-3 1.8 Turbo	[B207E]	09.02-	CA19161R	14 120		09.02-	CS1291	12 1.8
9-3 1.9 TiD	[Z19DT]	Chas. 51024444- 09.04-	CA19521R	14 130		09.04-	CS1428	12 1.7
		Chas. -51024443 09.04-	CA18901R	14 130		AT 03.05-	CS1264	12 1.7
	[Z19DTH]	Chas. 51024444- 09.04-	CA19521R	14 130		AT 09.04-	CS1264	12 1.7
		Chas. -51024443 09.04-	CA18901R	14 130		09.04-	CS1428	12 1.7
9-3 1.9 TTiD	[A19DTR]	12.07-	CA19521R	14 130		A18 12.07-	CS1264	12 1.7
						12.07-	CS1428	12 1.7
	[Z19DTH]	12.07-	CA19521R	14 130		AT 12.07-	CS1264	12 1.7
						12.07-	CS1428	12 1.7
	[Z19DTR]	12.07-	CA19521R	14 130		12.07-	CS1264	12 1.7
					AT 12.07-	CS1264	12 1.7	
9-3 2.0	[B207E]	03.05-	CA19161R	14 120		03.05-	CS1291	12 1.8
		09.02- 09.07	CA19161R	14 120		04.06- 09.07	CS1395	12 1.4
						09.02-	CS1291	12 1.8
9-3 2.0 i	[B204I]	02.98- 08.00	CA11381R	14 90		02.98- 08.00	CS372	12 1.4
		02.98- 08.00	CA15551R	14 130				
		02.98- 08.00	CA16831R	14 140				
9-3 2.0 Turbo BioPower	[B207L]	01.07-	CA19161R	14 120		01.07-	CS1395	12 1.4
9-3 2.0 Turbo	[B204E]	10.98- 08.00	CA11381R	14 90		10.98- 08.00	CS372	12 1.4
		10.98- 08.00	CA15551R	14 130		10.98- 08.00	CS727	12 1.1
		10.98- 08.00	CA16831R	14 140				
	[B204L]	02.98- 08.00	CA11381R	14 90		02.98- 08.00	CS372	12 1.4
		02.98- 08.00	CA15551R	14 130				
	[B205E]	10.98- 08.03	CA11381R	14 90		10.98- 09.02	CS372	12 1.4
		10.98- 08.03	CA16831R	14 140		01.02- 08.03	CS727	12 1.1
		09.99- 09.02	CA15551R	14 130				
	[B205L]	02.98- 08.00	CA11381R	14 90		02.98- 08.00	CS372	12 1.4
		02.98- 08.00	CA15551R	14 130				
	[B205R]	09.99- 08.03	CA11381R	14 90		10.99- 08.03	CS727	12 1.1
		09.99- 08.03	CA15551R	14 130		09.99- 09.02	CS372	12 1.4
		09.99- 08.03	CA16831R	14 140				
	[B207E]	03.05-	CA19161R	14 120		03.05-	CS1291	12 1.8
[B207L]	08.03-	CA19161R	14 120		Chas. -41038536 09.02-	CS1291	12 1.8	
	AT 09.02-	CA20681R*	14 140					
	[B207R]	09.02-	CA19161R	14 120		09.02-	CS1291	12 1.8
		08.03-	CA17401R	14 120				
9-3 2.0 Turbo SE	[B204R]	09.98- 08.00	CA11381R	14 90		09.98- 08.00	CS372	12 1.4
		09.98- 08.00	CA15551R	14 130				
		09.98- 08.00	CA16831R	14 140				
9-3 2.0 Biopower XWD	[B207R]	09.02-	CA19161R	14 120				
		A18 09.02-	CA17401R	14 120				
9-3 2.0 Biopower		09.02-	CA19161R	14 120		09.02-	CS1291	12 1.8
		05.09-	CA17401R	14 120				
9-3 2.0 Turbo Biopower	[B207L]	01.07-	CA19161R	14 120				
		A18 01.07-	CA17401R	14 120				
		02.09-	CA19161R	14 120				
		A18 02.09-	CA17401R	14 120				
9-3 2.0 Turbo Biopower XWD	[B207R]	06.08-	CA17401R	14 120				
		06.08-	CA19161R	14 120				
9-3 2.0 Turbo BioPower		06.07-	CA19161R	14 120		06.07-	CS1395	12 1.4
9-3 2.2 TD	[D223L]					02.98- 11.00	CS976	12 2.0
	[X22DTH]					02.98- 11.00	CS976	12 2.0
9-3 2.2 TiD	[D223L]					11.00- 09.02	CS976	12 2.0
9-3 2.3 i	[B234I]	02.98- 08.00	CA11381R	14 90		02.98- 08.00	CS372	12 1.4
		02.98- 08.00	CA15551R	14 130				
9-3 2.3 Turbo	[B235R]	09.99- 08.00	CA11381R	14 90		Chas. W3084484-, X3003578- 09.99- 08.03	CS372	12 1.4
		09.99- 08.00	CA15551R	14 130				
		09.99- 08.00	CA16831R	14 140				
		Chas. 3043797-, -13054631 10.99- 08.03	CA15551R	14 130				
		Chas. 13054632- 10.99- 08.03	CA16831R	14 140				



SAAB Continued

9-3 2.8	[B284L]					04.08-	CS1488*	12
						05.08-	CS1488*	12
9-3 2.8 Turbo 16V	[B284]					03.05-	CS1488*	12
9-3 2.8 Turbo V6	[B284]					03.05-	CS1488*	12
9-5 1.9 TiD	[Z19DTH]	01.06-	CA1952IR	14 130		01.06-	CS1428	12 1.7
						AT 01.06-	CS1264	12 1.7
9-5 2.0 Turbo BioPower	[B205E]	01.05-	CA1138IR	14 90		01.06-	CS1291	12 1.8
		01.05-	CA1555IR	14 130		01.05-	CS372	12 1.4
		01.05-	CA1683IR	14 140				
		01.05-	CA1961IR	14 140				
		01.06-	CA1916IR	14 120				
9-5 2.0 Turbo	[B205E]	09.06-	CA1961IR	14 140		09.97- 09.00	CS372	12 1.4
		Chas. 13054632- 09.97- 09.00	CA1683IR	14 140		10.98-	CS727	12 1.1
		Chas. -13054631 09.97- 09.00	CA1555IR	14 130				
9-5 2.0 TiD	[A20DTH]	05.10-	CA2005IR	14 100		05.10-	CS1428	12 1.7
						AT 05.10-	CS1264	12 1.7
9-5 2.0 TTiD	[A20DTR]	05.10-	CA2005IR	14 100		05.10-	CS1428	12 1.7
9-5 2.2 TiD	[D223L]	03.02-	CA1828IR	14 140		03.02-	CS976	12 2.0
9-5 2.2 TiD	[D223L]	03.02-	CA1828IR	14 140		03.02-	CS976	12 2.0
9-5 2.3 16V BioPower	[B235E]	01.07-	CA1555IR	14 130		01.07-	CS372	12 1.4
		01.07-	CA1683IR	14 140				
9-5 2.3 Turbo 16V	[B235E]	09.06-	CA1961IR	14 140		09.97- 08.00	CS372	12 1.4
		Chas. 13054632- 09.97- 08.00	CA1683IR	14 140				
		Chas. -13054631 09.97- 08.00	CA1555IR	14 130				
9-5 2.3 Turbo BioPower	[B235E]	01.07-	CA1555IR	14 130		01.07-	CS372	12 1.4
		01.07-	CA1683IR	14 140				
9-5 2.3 Turbo	[B235E]	09.06-	CA1961IR	14 140		06.99- 08.00	CS372	12 1.4
		Chas. 13054632- 06.99- 08.00	CA1683IR	14 140		01.01-	CS727	12 1.1
		Chas. -13054631 06.99- 08.00	CA1555IR	14 130				
	[B235L]	07.03-	CA1683IR	14 140		07.03-	CS727	12 1.1
	[B235R]	09.01- 09.06	CA1683IR	14 140		05.99- 09.01	CS372	12 1.4
		01.06-	CA1961IR	14 140		09.01-	CS727	12 1.1
		Chas. 13054632- 05.99- 09.01	CA1683IR	14 140				
		Chas. -13054631 05.99- 09.01	CA1555IR	14 130				
		04.08-	CA1961IR	14 140		04.08-	CS727	12 1.1
		04.08-	CA1555IR	14 130		04.08-	CS372	12 1.4
9-5 2.3 Turbo BioPower		11.06-	CA1683IR	14 140		11.06-	CS727	12 1.1
		11.06-	CA1961IR	14 140		11.06-	CS372	12 1.4
		11.06-	CA1555IR	14 130				
9-5 2.8 V6 XWD	[A28NER]					05.10-	CS1488*	12
<b>PASSENGER CARS US</b>								
95 1.7		01.71- 01.73	CA48IR	14 45		01.71- 01.73	CS72	12 1.1
96 1.7		01.71- 01.73	CA48IR	14 45		01.71- 01.73	CS72	12 1.1
99 2.0						01.78- 01.80	CS89	12 1.1
99 2.0 Turbo						01.78- 01.78	CS89	12 1.1
900 2.0	[B201I]					01.85- 01.88	CS346	12 1.4
	[B202I]	01.89- 01.90	CA566IR	14 80		01.89- 01.90	CS346	12 1.4
		01.79- 01.80	CA125IR#	14 65		01.79- 01.84	CS89	12 1.1
900 2.0 S	[B201I]					01.85- 01.88	CS346	12 1.4
	[B202I]	01.86- 01.90	CA566IR	14 80		01.86- 01.90	CS346	12 1.4
						01.81- 01.84	CS89	12 1.1
900 2.0 Turbo	[B202L]	01.85- 01.93	CA566IR	14 80		01.85- 01.93	CS346	12 1.4
		01.94- 01.94	CA1070IR	14 120		01.94- 01.94	CS372	12 1.4
		01.94- 01.94	CA1138IR	14 90				
		01.84- 01.84	CA566IR	14 80		01.79- 01.84	CS89	12 1.1
		01.79- 01.80	CA125IR#	14 65				
900 2.0 Turbo Commemorative	[B202R]	01.93- 01.93	CA566IR	14 80		01.94- 01.94	CS372	12 1.4
		01.94- 01.94	CA1070IR	14 120		01.93- 01.93	CS346	12 1.4
		01.94- 01.94	CA1138IR	14 90				
900 2.0 Turbo S	[B204L]	01.98- 01.98	CA1070IR	14 120		01.98- 01.98	CS372	12 1.4
		01.98- 01.98	CA1138IR	14 90				
900 2.0 Turbo SE	[B202L]	01.91- 01.91	CA566IR	14 80		01.91- 01.91	CS346	12 1.4
	[B204L]	01.94- 01.98	CA1070IR	14 120		01.94- 01.98	CS372	12 1.4
		01.94- 01.98	CA1138IR	14 90				
900 2.0 Turbo SPG		01.91- 01.91	CA566IR	14 80		01.91- 01.91	CS346	12 1.4
900 2.1	[B212I]	01.91- 01.92	CA566IR	14 80		01.91- 01.92	CS346	12 1.4
900 2.1 S	[B212I]	01.91- 01.94	CA566IR	14 80		01.91- 01.94	CS346	12 1.4
900 2.3 S	[B234I]	01.94- 01.98	CA1070IR	14 120		01.94- 01.98	CS372	12 1.4
		01.94- 01.98	CA1138IR	14 90				
900 2.5 SE	[B258I]	01.94- 01.97	CA1070IR	14 120		01.94- 01.97	CS802	12 1.4
		01.94- 01.97	CA1138IR	14 90				
9000 2.0 S	[B202I]	01.89- 01.90	CA566IR	14 80		01.89- 01.90	CS346	12 1.4
9000 2.0 Turbo	[B202L]	01.86- 01.90	CA566IR	14 80		01.86- 01.90	CS346	12 1.4
9000 2.0 Turbo CD	[B202L]	01.89- 01.90	CA566IR	14 80		01.89- 01.90	CS346	12 1.4
9000 2.0 Turbo D		01.89- 01.90	CA566IR	14 80		01.89- 01.90	CS346	12 1.4
9000 2.3 CD	[B234I]	01.91- 01.94	CA566IR	14 80		01.91- 01.94	CS878	12 1.4
9000 2.3 CDE	[B234I]	01.93- 01.94	CA566IR	14 80		01.93- 01.94	CS878	12 1.4
9000 2.3 CS	[B234I]	01.93- 01.94	CA566IR	14 80		01.93- 01.94	CS878	12 1.4
9000 2.3 CSE	[B234I]	01.93- 01.94	CA566IR	14 80		01.93- 01.94	CS878	12 1.4
9000 2.3 S	[B234I]	01.90- 01.92	CA566IR	14 80		01.90- 01.92	CS878	12 1.4
9000 2.3 Turbo	[B234L]	01.91- 01.92	CA566IR	14 80		01.91- 01.92	CS878	12 1.4
9000 2.3 Turbo AERO	[B234L]	01.93- 01.95	CA566IR	14 80		01.96- 01.97	CS372	12 1.4
		01.96- 01.97	CA1070IR	14 120		01.93- 01.95	CS878	12 1.4
		01.96- 01.97	CA1138IR	14 90				
	[B234R]	01.93- 01.95	CA566IR	14 80		01.96- 01.97	CS372	12 1.4
		01.96- 01.97	CA1070IR	14 120		01.93- 01.95	CS878	12 1.4
		01.96- 01.97	CA1138IR	14 90				
9000 2.3 Turbo CD	[B234L]	01.91- 01.94	CA566IR	14 80		01.91- 01.94	CS878	12 1.4
9000 2.3 Turbo CDE	[B234L]	01.93- 01.94	CA566IR	14 80		01.93- 01.94	CS878	12 1.4
9000 2.3 Turbo CS	[B234E]	01.95- 01.97	CA1070IR	14 120		01.95- 01.97	CS372	12 1.4
		01.95- 01.97	CA566IR	14 80				
	[B234L]	01.93- 01.94	CA566IR	14 80		01.93- 01.94	CS878	12 1.4
9000 2.3 Turbo CSE	[B234L]	01.93- 01.97	CA566IR	14 80		01.95- 01.98	CS372	12 1.4
		01.95- 01.98	CA1070IR	14 120		01.93- 01.94	CS878	12 1.4
		01.98- 01.98	CA1138IR	14 90				
	[B234R]	01.98- 01.98	CA1070IR	14 120		01.98- 01.98	CS372	12 1.4
		01.98- 01.98	CA1138IR	14 90				
9000 2.3 Turbo Griffin Edition	[B234L]	01.92- 01.92	CA566IR	14 80		01.92- 01.92	CS878	12 1.4
9000 2.3 Turbo SPG		01.91- 01.91	CA566IR	14 80		01.91- 01.91	CS878	12 1.4
9000 3.0 CDE	[B308I]	01.95- 01.95	CA1070IR	14 120		01.95- 01.95	CS802	12 1.4
		01.95- 01.95	CA566IR	14 80				
9000 3.0 CSE	[B308I]	01.95- 01.97	CA1070IR	14 120		01.95- 01.97	CS802	12 1.4
		01.95- 01.97	CA566IR	14 80				
Sonett 1.7		01.71- 01.74	CA48IR	14 45		01.71- 01.74	CS72	12 1.1



9-3 2.0 Turbo	[B204L]	01.99- 01.99	CA1138IR	14 90	01.99- 01.99	CS372	12 1.4
		01.99- 01.99	CA1555IR	14 130			
	[B205L]	01.00- 01.01	CA1138IR	14 90	01.00- 01.01	CS372	12 1.4
		01.00- 01.01	CA1555IR	14 130			
	[B205R]				01.02- 01.02	CS372	12 1.4
9-3 2.0 Turbo SE	[B204R]	01.99- 01.99	CA1138IR	14 90	01.99- 01.99	CS372	12 1.4
		01.99- 01.99	CA1555IR	14 130			
	[B205R]	01.00- 01.01	CA1138IR	14 90	01.00- 01.01	CS372	12 1.4
		01.00- 01.01	CA1555IR	14 130			
9-3 2.3 Turbo Viggen	[B235R]	01.99- 01.99	CA1138IR	14 90	01.99- 01.02	CS372	12 1.4
		01.99- 01.02	CA1555IR	14 130			
9-5 2.3 Turbo	[B235E]	01.99- 01.01	CA1555IR	14 130	01.99- 01.01	CS372	12 1.4
9-5 2.3 Turbo Aero	[B235R]	01.00- 01.01	CA1555IR	14 130	01.00- 01.01	CS372	12 1.4
<b>PASSENGER CARS AO</b>							
9000 2.3	[B234R]	09.90- 10.98	CA1246IR	14 90	09.93- 10.98	CS372	12 1.4
		09.90- 10.98	CA566IR	14 80	09.90- 08.93	CS878	12 1.4
9-3 2.3	[B235R]	09.99- 01.02	CA1138IR	14 90	09.99- 01.02	CS727	12 1.1
		09.99- 01.02	CA1683IR	14 140			
9-5 2.0	[B205L]	07.00- 07.01	CA1138IR	14 90	07.00- 07.01	CS372	12 1.4
		07.00- 07.01	CA1683IR	14 140			
9-5 2.0 BioPower	[B205E]	09.05- 09.06	CA1683IR	14 140	A13 09.05-	CS372	12 1.4
		09.06-	CA1961IR	14 140	09.05-	CS727	12 1.1
		09.06-	CA1961IR	14 140	09.05-	CS727	12 1.1
		09.05- 09.06	CA1683IR	14 140	A13 09.05-	CS372	12 1.4
9-5 2.0 Turbo SE		10.98- 07.00	CA1683IR	14 140	10.98- 07.00	CS372	12 1.4
9-5 2.3		06.03- 08.05	CA1683IR	14 140	06.03- 08.05	CS727	12 1.1
					06.03- 08.05	CS372	12 1.4
<b>Talbot</b>							
<b>PASSENGER CARS EU</b>							
1510 1.4 Simca	[6G1]				10.80- 06.82	CS306	12 1.05
	[6Y2D]				10.80- 06.82	CS306	12 1.05
1510 1.6	[6J2A]				07.81- 06.82	CS306	12 1.05
1510 1.6 Simca	[6J1]				10.80- 06.82	CS306	12 1.05
	[6J2]				10.80- 06.82	CS306	12 1.05
Express 1.8	[XM7T]				09.81- 12.93	CS352	12 0.85
Express 1.9 Diesel	[XUD9A]	11.87- 12.93	CA294IR	14 50	11.87- 12.93	CS373	12 1.7
Express 2.0	[XN1TA]				09.81- 12.93	CS352	12 0.85
Express 2.5 Diesel	[CRD93]	09.81- 12.93	CA735IR	14 75	09.81- 12.93	CS361	12 2.2
Express 2.5 Diesel 4x4	[CRD93]	09.81- 12.93	CA735IR	14 75	09.81- 12.93	CS361	12 2.2
Express 2.5 TD	[CRD93LS]	06.87- 12.93	CA735IR	14 75	09.81- 12.93	CS352	12 0.85
					06.87- 12.93	CS361	12 2.2
Express 2.5 TD 4x4	[CRD93LS]	11.88- 12.93	CA735IR	14 75	11.88- 12.93	CS361	12 2.2
					09.81- 12.93	CS352	12 0.85
Horizon 1.1	[E1B]				10.83- 09.84	CS306	12 1.05
Horizon 1.3	[2G1]				5SP 07.79- 06.82	CS306	12 1.05
	[2G1-BTC]				10.83- 06.86	CS306	12 1.05
Horizon 1.4	[2Y1]				10.83- 06.86	CS306	12 1.05
	[2Y1B]				10.83- 09.84	CS306	12 1.05
	[2Y2]				10.83- 06.86	CS306	12 1.05
	[Y2]				10.83- 06.86	CS306	12 1.05
Horizon 1.6	[6J2A]				10.83- 06.86	CS306	12 1.05
	[J2A]				10.83- 06.86	CS306	12 1.05
Horizon 1.9 Diesel	[XUD9]	07.82- 06.86	CA294IR	14 50	10.85- 06.86	CS373	12 1.7
		07.82- 06.86	CA532IR	14 80	07.82- 06.86	CS342#	12 1.5
Murena 1.6	[X5J2A]				5SP 08.81- 01.85	CS306	12 1.05
Samba 1.0	[5C1 (XV5)]	01.81- 12.85	CA291IR	14 50	01.81- 12.85	CS142	12 0.85
					01.81- 12.85	CS355	12 0.85
	[5C1 (XV8)]	06.83- 12.87	CA291IR	14 50	06.83- 12.87	CS142	12 0.85
					06.83- 12.87	CS355	12 0.85
Samba 1.1	[XW7]	01.81- 06.86	CA291IR	14 50	01.81- 06.86	CS142	12 0.85
					01.81- 06.86	CS355	12 0.85
Samba 1.2 Rallye	[129D]	06.83- 12.87	CA291IR	14 50	06.82- 12.87	CS355	12 0.85
Samba 1.4	[XY7]	06.83- 12.87	CA291IR	14 50	06.83- 12.87	CS355	12 0.85
	[XY8]	01.81- 12.87	CA291IR	14 50	01.81- 12.87	CS355	12 0.85
					01.81- 06.86	CS142	12 0.85
Samba 1.4 Rallye	[XY8]	01.83- 10.86	CA291IR	14 50	01.83- 10.86	CS142	12 0.85
					01.83- 10.86	CS355	12 0.85
Solara 1.3	[6G1D/VP]				10.83- 07.86	CS306	12 1.05
Solara 1.6	[6J1]				10.83- 10.84	CS306	12 1.05
	[J1B]				10.83- 07.86	CS306	12 1.05
Sunbeam 1.3 Simca	[JB]	07.77- 04.81	CA17h	14 34			
Sunbeam 1.6 Simca	[TB]	10.78- 04.81	CA17h	14 34			
Tagora 2.3 TD	[XD2S]	08.81- 12.87	CA308IR	14 50	08.81- 12.87	CS524	12 2.2
		08.81- 12.87	CA315IR	14 70	08.81- 12.87	CS314	12 2.0
Tagora 2.6	[9L6]	08.81- 10.83	CA229IR	14 70			
<b>TCM</b>							
<b>FORK LIFTS</b>							
FC 3024						JS552	12 2.0
FG 10						JS340	12 0.8
FG 15	[A15]					JS751	12 0.8
FG 20						JS343	12 0.8
FHG 35						JS302#	12 0.8
FHG 40						JS302#	12 0.8
FT 25						JS679	12 2.2
<b>Temsa</b>							
<b>TRUCKS EU</b>							
14 10.5	[D2066LOH04]	01.06-	CA1997IR	28 120			
<b>Thermo King</b>							
<b>MISC</b>							
30 DI TC							
30 MAX					01.79-	JS776#	12 2.0
					Yanmar eng. 01.79-	JS1239	12 1.4
HK 100	[TK2.44]						
HK 30	[TK2.44]						
HK 60	[TK2.44]						
KD 30	[TK3.66]						
KD 50	[TK3.66]						
SB II 30 DI TC							
SB III		01.90-	CA1082IR	14 35			
Super		01.93-	CA1082IR	14 35	01.93-	JS776#	12 2.0
TD II 30	[TK3.88]						
TD II 50 MAX	[TK3.88]						
Various Models						JS776#	12 2.0 HI



Timberjack									
INDUSTRY									
608		01.95-	UA1620IR	28	70				
618		01.95-	UA1620IR	28	70				
628		01.95-	UA1620IR	28	70				
850		01.98-	UA1620IR	28	70				
950		01.98-	UA1620IR	28	70				
2618		01.95-	UA1620IR	28	70				
2628		01.95-	UA1620IR	28	70				
Toyota									
PASSENGER CARS EU									
4 Runner 2.4	( N130 )	[22REC]	08.87-	03.96	JA1123IR	14	60		
4 Runner 2.7	( N130)	[3RZ-FE]	11.95-	07.02	JA1535IR	14	70	11.95-	07.02 JS1101 12 1.4
			11.95-	07.02	JA1535IR	14	70	11.95-	07.02 JS1101 12 1.4
4 Runner 2.7 i	(RZN18 )	[3RZ-FE]	11.95-	03.96	JA1535IR	14	70	11.95-	03.96 JS1101 12 1.4
4 Runner 3.0 V6 4WD		[3VZ-FE]						08.93-	11.95 JS1099# 12 1.4
4 Runner 3.0 TD		[1KZ-T]						11.95-	08.01 JS1154 12 2.2
4 Runner 3.0 TD 4WD	(N130)	[1KZ-T]	10.93-	03.96	JA1410IR	14	70	10.93-	03.96 JS1154 12 2.2
4 Runner 3.0 TDi 4x4	( N130)		09.00-	07.02	JA1410IR	14	70	09.00-	07.02 JS1154 12 2.2
4 Runner 3.4	( N130)	[5VZ-FE]						11.95-	07.02 JS1231 12 1.4
								11.95-	07.02 JS1231 12 1.4
4 Runner 3.4 i		[5VZ-FE]						11.95-	08.02 JS1231 12 1.4
Auris 1.4 VVTi		[4ZZ-FE]						A13 03.07-	JS1236 12 1.1
								03.07-	JS1230 12 0.8
Auris 1.4 D-4D	(NDE150)	[1ND-TV]	03.07-	01.09	CA1964IR	14	100	A13 03.07-	JS1358 12 2.0
			01.09-		CA2097IR*	14	100	03.07-	CS1453 12 1.1
Auris 1.6	(ZRE151)	[1ZR-FAE]						05.09-	CS1450 12 1.2
Auris 1.6 VVTi	(ZRE51)	[1ZR-FE]	03.07-		CA2027IR	14	100	03.07-	CS1450 12 1.2
Auris 1.8	(ZRE152)	[2ZR-FAE]						02.09-	CS1450 12 1.2
Auris 2.0 D-4D	(ADE150)	[1AD-FTV]	03.07-		CA2036IR*	14	100	03.07-	JS1369 12 2.0
Auris 2.2 Diesel	(ADE157)	[2AD-FHV]	03.07-		CA2036IR*	14	100	03.07-	JS1369 12 2.0
Avensis 1.6		[4A-FE]	09.97-	07.00	JA987IR	14	80	09.97-	07.00 JS1105 12 1.1
Avensis 1.6 i 16V	(T22)	[3ZZ-FE]	10.00-	02.03	JA1605IR	14	80	10.00-	02.03 JS1236 12 1.1
			10.00-	02.03	JA1605IR	14	80	10.00-	02.03 JS1236 12 1.1
Avensis 1.6 VVTi	(T25)	[3ZZ-FE]	01.03-	02.04	JA1605IR	14	80	01.03-	JS1362 12 1.3
			01.03-	04.06	JA1894IR	14	90		
Avensis 1.8	(T25)	[1ZZ-FE]	01.03-		JA1605IR	14	80	01.03-	JS1362 12 1.3
			01.03-		JA1894IR	14	90		
		[7A-FE]	09.97-	07.00	JA987IR	14	80	09.97-	07.00 JS1105 12 1.1
Avensis 1.8 i 16V	( T22 )	[1ZZ-FE]	07.00-	01.03	JA1605IR	14	80	07.00-	01.03 JS1236 12 1.1
		[ST220]	07.00-	01.03	JA1605IR	14	80	07.00-	01.03 JS1236 12 1.1
Avensis 2.0	(T25)	[1AZ-FSE]	AC 01.03-		CA1907IR	14	100	01.03-	JS1363 12 1.6
			09.97-	01.03	JA1599IR	14	80	09.97-	01.03 JS912 12 1.0
Avensis 2.0 i 16V	(ST220)	[1AZ-FSE]	07.00-	01.03	JA1797IR	14	100	07.00-	01.03 JS1302 12 1.2
Avensis 2.0 VVTi	(T25)	[1AZ-FE]	03.03-		CA1907IR	14	100		
Avensis 2.0 VVTi Verso	(AC )	[1AZ-FE]	05.01-	07.05	JA1613IR	14	100	05.01-	01.03 JS1302 12 1.2
								01.03-	CS1476* 12 1.3
Avensis 2.0 D-4D	(T22)	[1CD-FTV]	10.99-	02.03	JA1783IR	14	120	10.99-	02.03 JS1135 12 2.0
			03.06-		CA1965IR*	14	100	03.06-	JS1369 12 2.0
Avensis 2.0 D-4D Verso	(T25)	[1AD-FTV]	01.03-	06.04	CA1950IR	14	100	01.03-	JS1135 12 2.0
		(AC )	05.01-	07.05	JA1721IR	14	130	08.01-	CS1500* 12 1.4
								05.01-	07.05 JS1088 12 2.2
Avensis 2.0 Diesel	( T22 )	[1CD-FTV]	09.02-	02.03	JA1783IR	14	120	09.02-	02.03 JS1135 12 2.0
		[2C-T]	10.97-	05.98	JA1377IR	14	90	10.97-	05.98 JS1135 12 2.0
		(T27)	02.09-		CA1965IR*	14	100		
Avensis 2.0 TD		[2C-TE]	09.97-	07.00	JA1377IR	14	90	09.97-	07.00 JS1135 12 2.0
Avensis 2.2 D-4D	(T25)	[2AD-FTV]	04.05-		CA1965IR*	14	100	04.05-	JS1369 12 2.0
Avensis 2.2 D-4D CAT	(T25)	[2AD-FHV]	04.05-		CA1965IR*	14	100	04.05-	JS1369 12 2.0
Avensis 2.2 Diesel	(T27)	[2AD-FHV]	02.09-		CA1965IR*	14	100		
		[2AD-FTV]	02.09-		CA1965IR*	14	100		
Avensis 2.4	(T25)	[2AZ-FSE]	09.03-		CA1907IR	14	100	09.03-	JS1363 12 1.6
Aygo 1.0 i		[1KR-FE]	02.05-		CA1949IR	14	80	02.05-	CS1407 12 1.1
			02.05-		CA1978IR	14	70		
Aygo 1.0	(KGB10)	[1KR-FE]	07.05-		CA1949IR	14	80	07.05-	CS1407 12 1.1
			07.05-		CA1978IR	14	70		
Aygo 1.4 HDi		[2WZTV]	02.05-		CA1589IR	14	90	02.05-	CS1260 12 1.1
			A13 02.05-		CA1674IR	14	150	02.05-	CS1329 12 1.5
Camry 1.8	(SV10)	[1S-L]	10.82-	10.86	JA1611R	14	70		
			10.82-	10.86	JA1891R	14	55		
		[1S]	11.86-	08.88	JA1611R	14	70		
Camry 1.8 i		[1S-L]	10.86-	08.88	JA1611R	14	70	10.86-	08.88 JS632 12 1.4
			10.86-	08.88	JA1891R	14	55	10.86-	08.88 JS652 12 1.0
Camry 1.8 TD		[1C-TL]	08.83-	10.86	JA1941R	14	60		
Camry 2.0	(SV11)	[2S-EL]	03.83-	10.86	JA1611R	14	70		
		(SV21)	11.86-	05.91	JA1611R	14	70	11.86-	05.91 JS652 12 1.0
								11.86-	05.91 JS632 12 1.4
		[2S-E]	01.84-	05.91	JA1611R	14	70	01.84-	05.91 JS632 12 1.4
			01.84-	10.86	JA1891R	14	55	01.84-	05.91 JS652 12 1.0
		[2S-ELC]	01.84-	05.91	JA1611R	14	70	01.84-	05.91 JS652 12 1.0
			01.84-	10.86	JA1891R	14	55	01.84-	05.91 JS632 12 1.4
			04.86-	07.86	JA1421R	14	60	04.86-	07.86 JS652 12 1.0
Camry 2.0 GLi 4x4	( V2 )		08.88-	05.91	JA1611R	14	70	08.88-	05.91 JS632 12 1.4
Camry 2.0 16V GLi	(SV21)	[3S-FE]	11.86-	05.91	JA1611R	14	70	11.86-	05.91 JS632 12 1.4
								11.86-	05.91 JS652 12 1.0
Camry 2.0 TD	(CV20)	[2C-T]	11.86-	05.91	JA1941R	14	60	A13 08.88-	06.91 JS774 12 2.2
		(CV21)	11.86-	05.91	JA1941R	14	60	A13 08.88-	05.91 JS774 12 2.2
		[2C-T]						A13 08.88-	06.91 JS774 12 2.2
Camry 2.2	( V20 )	[5S-FE]	08.96-	09.01	JA1134IR	14	80	08.96-	09.01 JS1302 12 1.2
			08.96-	09.01	JA9811R	14	70		
		(SXV10)	06.91-	07.92	JA1611R	14	70	A13 08.94-	08.96 JS913 12 1.4
			08.92-	08.96	JA1134IR	14	80	06.91-	07.94 JS632 12 1.4
			08.92-	08.96	JA9811R	14	70	06.91-	07.94 JS652 12 1.0
								08.94-	08.96 JS912 12 1.0
		(SXV20)	08.96-	08.99	JA9811R	14	70	08.96-	11.01 JS1302 12 1.2
			08.99-	11.01	JA1134IR	14	80		
Camry 2.5	(VZV21)	[2VZ-FE]	02.88-	05.91	JA1164IR#	14	70	02.88-	05.91 JS652 12 1.0
								02.88-	05.91 JS632 12 1.4
Camry 2.5 V6 GXi	(VZV21)	[2VZ-FE]	02.88-	05.91	JA1164IR#	14	70	02.88-	05.91 JS632 12 1.4
								02.88-	05.91 JS652 12 1.0
Camry 3.0	( V1 )	[3VZ-FE]						09.93-	07.96 JS632 12 1.4
								09.93-	07.96 JS913 12 1.4
		(VCV10)						06.91-	07.94 JS632 12 1.4
								06.91-	07.94 JS652 12 1.0
								08.94-	08.96 JS912 12 1.0
								08.94-	08.96 JS913 12 1.4
Carina 1.6	(AT151)	[4A-L]	10.83-	11.87	JA140	14	50	10.83-	11.87 JS339 12 1.0
		[4A-LC]	10.83-	11.87	JA140	14	50	10.83-	11.87 JS339 12 1.0
		(AT171)	12.87-	08.90	JA552IR	14	70	12.87-	08.90 JS560 12 1.0
								12.87-	08.90 JS760 12 0.8





	[4A-FE]	12.87- 03.92	JA552IR	14 70	12.87- 03.92	JS760	12 0.8
	(ST150)[1S-EL]	10.83- 11.87	JA161IR	14 70	12.87- 03.92	JS560	12 1.0
		10.83- 11.87	JA189IR	14 55			
	(TA1)[2T]	02.76- 03.78	JA131	14 40			
		02.76- 03.78	JA137	14 50			
	(TA12)[2TB]	05.73- 03.78	JA131	14 40			
		02.75- 03.78	JA137	14 50			
	(TA4K)[2T]	03.81- 01.82	JA131	14 40			
		03.81- 01.82	JA137	14 50			
	(TA4K,TA60L)[2T]	04.78- 02.82	JA131	14 40			
		04.78- 02.82	JA137	14 50			
	(TA4L,TA60L)[2T]	01.78- 01.82	JA131	14 40			
		01.78- 01.82	JA137	14 50			
	[2TB]	10.75- 03.78	JA131	14 40			
		10.75- 03.78	JA137	14 50			
Carina 1.8	(ST150)[1S-L]	10.83- 11.87	JA161IR	14 70			
		10.83- 11.87	JA189IR	14 55			
	[3T]	01.82- 09.83	JA131	14 40			
		01.82- 09.83	JA137	14 50			
Carina 2.0	(ST171)[3S-FE]	12.87- 11.89	JA161IR	14 70	12.87- 03.92	JS632	12 1.4
		11.89- 03.92	JA783IR	14 70	12.87- 03.92	JS652	12 1.0
	[3S-FE]	12.87- 11.89	JA161IR	14 70	12.87- 04.92	JS632	12 1.4
		11.89- 04.92	JA783IR	14 70	12.87- 04.92	JS652	12 1.0
Carina 2.0 Diesel	(CT150)[2C-L]	10.83- 11.87	JA194IR	14 60			
	(T15)[2C-L]	10.83- 12.87	JA194IR	14 60			
	(T17)[2C]	12.87- 05.89	JA194IR	14 60	A13 12.87- 11.92	JS774	12 2.2
		05.89- 06.91	JA571IR#	14 60			
	[2C-L]	12.87- 05.89	JA194IR	14 60	A13 12.87- 11.92	JS774	12 2.2
		05.89- 06.91	JA571IR#	14 60			
	[2C-L]	12.87- 05.89	JA194IR	14 60	A13 12.87- 11.92	JS774	12 2.2
		05.89- 06.91	JA571IR#	14 60			
Carina E 1.6	(AT190)[4A-FE]	02.92- 09.97	JA976IR	14 70	02.92- 09.97	JS1105	12 1.1
		02.92- 09.97	JA987IR	14 80	A13 02.92- 09.97	JS1018	12 1.2 ND
					02.92- 09.97	JS918	12 0.8
Carina E 1.6 GLi	(AT190)[4A-FE]	02.92- 09.97	JA976IR	14 70	02.92- 09.97	JS918	12 0.8
		02.92- 09.97	JA987IR	14 80	A13 02.92- 09.97	JS1018	12 1.2 ND
					02.92- 09.97	JS1105	12 1.1 BO
	(ST191)[4A-FE]	01.93- 09.97	JA976IR	14 70	01.93- 09.97	JS918	12 0.8
		01.93- 09.97	JA987IR	14 80	A13 01.93- 09.97	JS1018	12 1.2 ND
					01.93- 09.97	JS1105	12 1.1 BO
Carina E 1.6 16V	(AT190)[4A-FE]	12.92- 09.97	JA987IR	14 80	A13 12.92- 10.97	JS1018	12 1.2 ND
		08.93- 09.97	JA976IR	14 70	12.92- 10.97	JS918	12 0.8
					12.92- 10.97	JS1105	12 1.1 BO
	(CT190)[4A-FE]	12.92- 09.97	JA976IR	14 70	12.92- 09.97	JS918	12 0.8
		12.92- 09.97	JA987IR	14 80	A13 12.92- 09.97	JS1018	12 1.2 ND
Carina E 1.6 i	(AT190)[4A-FE]	02.95- 09.97	JA976IR	14 70	02.95- 09.97	JS1105	12 1.1
		02.95- 09.97	JA987IR	14 80	02.95- 09.97	JS918	12 0.8
Carina E 1.8	(AT191)[7A-FE]	01.95- 10.97	JA976IR	14 70	01.95- 10.97	JS1105	12 1.1 BO
		01.95- 10.97	JA987IR	14 80	01.95- 10.97	JS918	12 0.8
					A13 01.95- 10.97	JS1018	12 1.2 ND
Carina E 1.8 i	(AT191)[7A-FE]	02.95- 07.97	JA976IR	14 70	02.95- 09.97	JS1105	12 1.1
		02.95- 07.97	JA987IR	14 80	02.95- 09.97	JS918	12 0.8
Carina E 2.0	(ST191)[3S-FE]	02.92- 09.97	JA1134IR	14 80	02.92- 09.97	JS912	12 1.0
		02.92- 09.97	JA981IR	14 70	A13 02.92- 09.97	JS913	12 1.4
Carina E 2.0 GLi	(ST191)[3S-FE]	02.92- 09.97	JA1134IR	14 80	A13 02.92- 09.97	JS913	12 1.4
		02.92- 09.97	JA981IR	14 70	02.92- 09.97	JS912	12 1.0
Carina E 2.0 GTi	(ST191)[3S-GE]	02.92- 01.96	JA1134IR	14 80	A13 02.92- 01.96	JS1080	12 1.2
		02.92- 01.96	JA981IR	14 70	02.92- 01.96	JS913	12 1.4
Carina E 2.0 i 16V	(ST191)[3S-FE]	02.92- 09.97	JA1134IR	14 80	02.92- 09.97	JS912	12 1.0
		02.92- 09.97	JA981IR	14 70	A13 02.92- 09.97	JS913	12 1.4
	[3S-GE]	02.92- 01.96	JA981IR	14 70	02.92- 01.96	JS912	12 1.0
		03.94- 09.97	JA1377IR	14 90	02.92- 09.97	JS1080	12 1.2
		01.96- 09.96	JA1119IR	14 80	A13 02.92- 01.96	JS913	12 1.4
					01.96- 09.97	JS1088	12 2.2
					01.96- 09.97	JS1135	12 2.0
Carina E 2.0 i	(ST191)[3S-FE]	02.92- 09.97	JA1134IR	14 80	02.92- 09.97	JS1080	12 1.2
		02.92- 09.97	JA981IR	14 70	02.92- 09.97	JS912	12 1.0
					A13 02.92- 09.97	JS913	12 1.4
	[3S-GE]	04.92- 02.94	JA981IR	14 70	04.92- 02.94	JS913	12 1.4
					04.92- 02.94	JS912	12 1.0
Carina E 2.0 Diesel	(CT190)[2C]	02.94- 01.96	JA1119IR	14 80	02.94- 01.96	JS1088	12 2.2
		02.94- 01.96	JA1377IR	14 90	02.94- 01.96	JS902	12 1.4
Carina E 2.0 TD	(CT190)[2C-T]	01.96- 10.97	JA1377IR	14 90	01.96- 10.97	JS1088	12 2.2
Celica 1.6	(AT180)[4A-FE]	10.89- 10.93	JA552IR	14 70	10.89- 10.93	JS760	12 0.8
					A13 10.89- 10.93	JS560	12 1.0
	(T16)[4A-L]	08.85- 09.89	JA142IR	14 60	04.86- 09.89	JS317	12 1.0
	(TA2)[2T]	02.76- 03.78	JA131	14 40			
		02.76- 03.78	JA137	14 50			
	(TA22)[2TB]	05.73- 03.78	JA131	14 40			
		05.73- 03.78	JA137	14 50			
	(TA4C)[2TB]	02.79- 07.83	JA131	14 40			
		02.79- 07.83	JA137	14 50			
	(TA4C,TA60)[2TB]	08.77- 01.82	JA131	14 40			
		08.77- 08.85	JA137	14 50			
	[4A-L]	08.77- 08.79	JA131	14 40			
		08.77- 07.81	JA137	14 50			
		08.79- 07.81	JA140	14 50			
	(TA60)[2T]	02.79- 08.83	JA131	14 40			
		02.79- 08.83	JA137	14 50			
	[2TB]	08.77- 08.85	JA131	14 40			
		08.77- 08.85	JA137	14 50			
Celica 1.6 GT	(AT160)[4A-GELC]	08.87- 08.89	JA142IR	14 60	08.87- 08.89	JS317	12 1.0
	(RA6)[4A-GE]	08.83- 07.85	JA142IR	14 60	08.83- 07.85	JS317	12 1.0
	(TA22)[2T-G]	12.74- 03.78	JA131	14 40			
		12.74- 03.78	JA137	14 50			
	(TA4C)[2TG]	04.80- 02.82	JA131	14 40			
		04.80- 02.82	JA137	14 50			
	[2T-G]	04.78- 02.82	JA131	14 40			
		04.78- 02.82	JA137	14 50			
Celica 1.6 16V GT	(AT160)[4A-GEL]	09.85- 08.89	JA142IR	14 60	09.85- 08.89	JS317	12 1.0
	[4A-GEL]	04.86- 08.89	JA142IR	14 60	04.86- 08.89	JS317	12 1.0
Celica 1.8 16V TS	(ZZT231)[2ZZ-GE]				11.99- 08.00	JS1230	12 0.8
					08.00- 09.05	JS1236	12 1.1
Celica 1.8 i 16V	[7A-FE]	11.93- 11.99	JA976IR	14 70	11.93- 11.99	JS918	12 0.8
		11.93- 11.99	JA987IR	14 80			
Celica 1.8 VVTi 16V	(ZZT230)[1ZZ-FE]	08.99- 09.05	JA1703IR	14 80	08.99- 09.05	JS1236	12 1.1
					08.99- 09.05	JS1230	12 0.8
Celica 2.0	(RA40)[18R]	02.79- 07.85	JA131	14 40	08.81- 07.85	JS316	12 1.0
		02.79- 07.85	JA137	14 50	02.79- 07.81	JS335#	12 0.9
	(RA6)[18R-G]	01.82- 08.85	JA131	14 40	01.82- 08.85	JS316	12 1.0



TOYOTA Continued

	[21R-U]	01.82- 08.85	JA137	14 50				
		01.82- 08.85	JA131	14 40	01.82- 08.85	JS316	12 1.0	
	(RA61)[21R-C]	01.82- 08.85	JA137	14 50				
		02.82- 08.85	JA131	14 40	02.82- 08.85	JS316	12 1.0	
	(RA63)[18R-G]	02.82- 08.85	JA137	14 50				
		02.78- 08.83	JA131	14 40	08.77- 07.81	JS335#	12 0.9	
		02.78- 08.83	JA137	14 50	08.81- 08.83	JS316	12 1.0	
	[3S-GEL]	08.85- 08.89	JA1611R	14 70	08.85- 08.89	JS644	12 1.0	
		08.85- 08.89	JA1891R	14 55				
CELICA 2.0 GT	(ST162)[3S-GEL]	08.85- 08.89	JA1611R	14 70	08.85- 08.89	JS644	12 1.0	
		08.85- 08.89	JA1891R	14 55				
	[3S-GELC]	08.85- 08.87	JA1891R	14 55	10.86- 09.89	JS644	12 1.0	
		08.87- 08.89	JA1611R	14 70				
	[3S-GEL]	08.85- 08.89	JA1891R	14 55	09.86- 09.89	JS644	12 1.0	
		08.87- 08.89	JA1611R	14 70				
	[3S-GELC]	09.85- 08.89	JA1891R	14 55	09.86- 09.89	JS644	12 1.0	
		08.87- 08.89	JA1611R	14 70				
CELICA 2.0 16V	(T20)[3S-GE]				08.96- 11.99	JS913	12 1.4	
	[3S-GE]				11.93- 11.99	JS913	12 1.4	
CELICA 2.0 GTi	(ST182)[3S-GE]	03.90- 10.93	JA783IR	14 70	10.89- 10.93	JS632	12 1.4	
CELICA 2.0 i 16V	(ST202)[3S-GE]				11.93- 11.99	JS913	12 1.4	
CELICA 2.0 Turbo 4WD	(ST185)[3S-GTE]	10.89- 01.94	JA1611R	14 70	10.89- 01.94	JS652	12 1.0	
					10.89- 01.94	JS632	12 1.4	
CELICA 2.0 Turbo GT 4WD	(T16F)[3S-GTE]	03.88- 08.90	JA1611R	14 70	03.88- 08.90	JS632	12 1.4	
					03.88- 08.90	JS652	12 1.0	
COROLLA 1.2	(KE/TE)[3K-B]	09.76- 11.78	JA131	14 40				
		09.76- 01.80	JA137	14 50				
	[3K-C]	09.76- 11.78	JA131	14 40				
		09.76- 01.80	JA137	14 50				
	[3K-H]	09.76- 11.78	JA131	14 40				
		09.76- 01.80	JA137	14 50				
	(KE20)[3K-B]	10.72- 10.75	JA130	14 30	10.72- 03.74	JS330#	12 0.6	
		10.72- 06.77	JA131	14 40				
	[3K-C]	10.72- 10.75	JA130	14 30	10.72- 03.74	JS330#	12 0.6	
		10.72- 06.77	JA131	14 40				
	[3K-H]	08.74- 10.75	JA130	14 30				
		08.74- 08.79	JA131	14 40				
	(KE20,25,30)[3K-B]	06.74- 12.79	JA137	14 50				
		08.74- 10.75	JA130	14 30				
		08.74- 11.78	JA131	14 40				
	[3K-C]	06.74- 12.79	JA137	14 50				
		08.74- 10.75	JA130	14 30				
		08.74- 11.78	JA131	14 40				
	[3K-H]	06.74- 12.79	JA137	14 50				
		08.74- 10.75	JA130	14 30				
		08.74- 11.78	JA131	14 40				
	(KE35)[3K-B]	07.75- 11.78	JA131	14 40				
		07.75- 01.80	JA137	14 50				
	[3K-C]	07.75- 11.78	JA131	14 40				
		07.75- 01.80	JA137	14 50				
	[3K-H]	07.75- 11.78	JA131	14 40				
		07.75- 01.80	JA137	14 50				
	(KE36)[3K]	07.75- 11.78	JA131	14 40				
		07.75- 01.80	JA137	14 50				
	[3K-H]	07.75- 11.78	JA131	14 40				
		07.75- 01.80	JA137	14 50				
COROLLA 1.3	(AE,EE80)[2E-L]	10.84- 08.87	JA1411R	14 45	03.85- 08.87	JS525	12 1.0	
					10.84- 08.87	JS357	12 0.8	
	[2E-LC]	05.85- 08.87	JA1411R	14 45	05.85- 08.87	JS525	12 1.0	
					05.85- 08.87	JS357	12 0.8	
	(AE80)[2A-L]	06.83- 10.84	JA140	14 50	06.83- 10.84	JS339	12 1.0	
	(EE80)[2E-L]	10.84- 08.87	JA1411R	14 45	03.85- 08.87	JS525	12 1.0	
					10.84- 08.87	JS357	12 0.8	
	[2E-LC]	05.85- 08.87	JA1411R	14 45	05.85- 08.87	JS357	12 0.8	
					05.85- 08.87	JS525	12 1.0	
	(EE90)[2E]	08.87- 06.92	JA1411R	14 45	08.87- 06.92	JS357	12 0.8	
					08.87- 06.92	JS525	12 1.0	
	[2E-L]	10.84- 08.87	JA1411R	14 45	03.85- 08.87	JS525	12 1.0	
					10.84- 08.87	JS357	12 0.8	
COROLLA 1.3 XLI	(E10)[4E-FE]	05.95- 04.97	JA988IR	14 70	05.95- 04.97	JS1023	12 0.8	
					05.95- 04.97	JS1024	12 1.0	
	(EE101)[4E-FE]	07.92- 04.97	JA988IR	14 70	05.95- 04.97	JS1023	12 0.8	
					05.95- 04.97	JS1024	12 1.0	
					07.92- 05.95	JS357	12 0.8	
					07.92- 05.95	JS525	12 1.0	
COROLLA 1.3 12V	(EE100)[2E]				05.92- 05.95	JS357	12 0.8	
COROLLA 1.3 16V XLI	(EE101)[4E-FE]	07.92- 04.97	JA988IR	14 70	05.95- 04.97	JS1023	12 0.8	
					05.95- 04.97	JS1024	12 1.0	
					07.92- 05.95	JS357	12 0.8	
					07.92- 05.95	JS525	12 1.0	
COROLLA 1.3 i	(EE90)[2E]	08.87- 04.92	JA1411R	14 45	08.87- 04.92	JS357	12 0.8	
					08.87- 04.92	JS525	12 1.0	
	[2E-E]	08.87- 04.92	JA1411R	14 45	08.87- 04.92	JS357	12 0.8	
					08.89- 04.92	JS525	12 1.0	
COROLLA 1.4	[4E-FE]	04.97- 10.99	JA988IR	14 70	04.97- 10.99	JS1023	12 0.8	
					04.97- 10.99	JS1024	12 1.0	
	[4ZZ-FE]	02.00- 01.02	CA2047IR*	14 70	02.00- 01.02	JS1230	12 0.8	
		02.00- 01.02	JA1605IR	14 80	02.00- 01.02	JS1236	12 1.1	
COROLLA 1.4 16V	[4ZZ-FE]	02.00- 01.02	CA2047IR*	14 70	02.00- 01.02	JS1230	12 0.8	
		02.00- 01.02	JA1605IR	14 80	02.00- 01.02	JS1236	12 1.1	
COROLLA 1.4 16V GLI	(EE101)[4E-FE]	07.92- 04.97	JA988IR	14 70	07.92- 05.95	JS525	12 1.0	
					05.95- 04.97	JS1023	12 0.8	
					05.95- 04.97	JS1024	12 1.0	
					07.92- 05.95	JS357	12 0.8	
COROLLA 1.4 16V XLI	(EE101)[4E-FE]	07.92- 04.97	JA988IR	14 70	07.92- 05.95	JS525	12 1.0	
					05.95- 04.97	JS1023	12 0.8	
					05.95- 04.97	JS1024	12 1.0	
					07.92- 05.95	JS357	12 0.8	
COROLLA 1.4 VVTi	(E12)[4ZZ-FE]	01.02- 05.04	JA1703IR	14 80	01.02- 05.04	JS1236	12 1.1	
					01.02- 05.04	JS1230	12 0.8	
	(E12_ 12J_)[4ZZ-FE]	01.02-	CA2047IR*	14 70	01.02-	JS1236	12 1.1	
		01.02-	JA1605IR	14 80	01.02-	JS1230	12 0.8	
		01.02-	JA1703IR	14 80				
COROLLA 1.4 Diesel	( _E12_ )[1ND-TV]	07.04-	CA1964IR	14 100	07.04-	JS1358	12 2.0	
	( _E120_ _E12J_ )[1ND-TV]	07.04-	CA1964IR	14 100	07.04-	JS1358	12 2.0	
	(E12_ 12J_)[1ND-TV]	07.04-	CA1964IR	14 100	07.04-	JS1358	12 2.0	
	( _E10_ )[4A-FE]	05.92- 07.95	JA976IR	14 70	05.92- 07.95	JS1018	12 1.2	
					05.92- 07.95	JS560	12 1.0	
	( _E9_ )[4A-F]	02.88- 05.92	JA552IR	14 70	02.88- 05.92	JS560	12 1.0	
	(AE82)[4A-L]	06.83- 08.87	JA140	14 50	06.83- 08.87	JS339	12 1.0	
		06.83- 08.87	JA1891R	14 55				



	[4A-LC]	08.85- 04.87 08.85- 08.87	JA140 JA1891R	14 50 14 55		08.85- 08.87	JS339	12 1.0
	(AE9_)[4A-FE]	11.89- 04.92	JA5521R	14 70		11.89- 04.92 11.89- 04.92	JS560 JS760	12 1.0 12 0.8
	(AE92)[4A-F]	08.87- 04.92	JA5521R	14 70		08.87- 04.92 12.87- 04.92 08.87- 04.92	JS560 JS1105 JS760	12 1.0 12 1.1 12 0.8
	[4A-FE]	05.87- 04.92	JA5521R	14 70		08.89- 04.92 08.89- 04.92	JS760 JS560	12 0.8 12 1.0
	[4A-GE]	08.87- 08.89 08.89- 04.92	JA1421R JA9961R#	14 60 14 70		08.87- 04.92	JS317	12 1.0
	(AE95)[4A-FE]	08.88- 04.92	JA5521R	14 70		08.88- 04.92 08.88- 04.92	JS560 JS760	12 1.0 12 0.8
	(KE/TE)[2T]	09.76- 01.80 09.76- 01.80	JA131 JA137	14 40 14 50				
	[2TB]	09.76- 01.80 09.76- 01.80	JA131 JA137	14 40 14 50				
	(TE71)[2T]	09.79- 05.83 09.79- 05.83	JA131 JA137	14 40 14 50				
	[2TB]	09.79- 05.83 09.79- 05.83	JA131 JA137	14 40 14 50				
	[3ZZ-FE]	02.00- 01.02 02.00- 01.02	CA20471R* JA16051R	14 70 14 80		02.00- 01.02 02.00- 01.02	JS1230 JS1236	12 0.8 12 1.1
	[4A-F]	08.87- 04.92	JA5521R	14 70		08.87- 04.92	JS560	12 1.0
	[4A-FE]	04.97- 10.99 04.97- 10.99	JA9761R JA9871R	14 70 14 80		04.97- 10.99 04.97- 10.99 04.97- 10.99	JS1141 JS918 JS1105	12 1.1 ND 12 0.8 12 1.1 BO
	[4A-L]	06.83- 09.87 06.83- 08.87	JA140 JA1891R	14 50 14 55		06.83- 09.87	JS339	12 1.0
	[4A-LC]	08.85- 08.87 08.85- 08.87	JA140 JA1891R	14 50 14 55		08.85- 08.87	JS339	12 1.0
Corolla 1.6 FX	(E8B)[4A-C] [4A-LC]	08.84- 08.87 05.83- 04.87 05.83- 04.87	JA140 JA140 JA1891R	14 50 14 50 14 55		08.84- 08.87 05.83- 04.87	JS317 JS339	12 1.0 12 1.0
Corolla 1.6 GLi	(AE101)[4A-FE]	05.92- 04.97 05.92- 04.97	JA9761R JA9871R	14 70 14 80		05.92- 04.95 05.95- 04.97 05.95- 04.97 05.92- 04.95	JS760 JS918 JS1141 JS560	12 0.8 12 0.8 12 1.1 12 1.0
Corolla 1.6 GT	(TE71)[2T-G]	05.80- 05.83 05.80- 05.83	JA131 JA137	14 40 14 50				
Corolla 1.6 Verso	(ZER_ ZZE_)[3ZZ-FE]	02.04- 02.04-	JA16051R JA18941R	14 80 14 90		02.04-	JS1362	12 1.3
Corolla 1.6 XLi	[4A-FE]	11.89- 04.92	JA5521R	14 70		11.89- 04.92 11.89- 04.92	JS560 JS760	12 1.0 12 0.8
Corolla 1.6 16V	(AE86)[4A-GE] [3ZZ-FE] [4A-GEC]	08.83- 08.87 08.86- 08.87 02.00- 01.02 02.00- 01.02 04.85- 04.87 08.86- 04.87	JA1421R JA9961R# CA20471R* JA16051R JA1421R JA9961R#	14 60 14 70 14 70 14 80 14 60 14 70		08.83- 08.87 02.00- 01.02 04.85- 04.87	JS317 JS1230 JS1236 JS317	12 1.0 12 0.8 12 1.1 12 1.0
Corolla 1.6 Dual VVTi	(ZRE161R)[1ZR-FE]	01.07-	CA20271R	14 100		08.85- 08.87	JS317	12 1.0
Corolla 1.6 GTi	(.E9_)[4A-GE]	07.87- 08.89 08.89- 04.92	JA1421R JA9961R#	14 60 14 70		07.87- 04.92	JS317	12 1.0
Corolla 1.6 i	(AE92)[4A-FE]	08.89- 04.92	JA5521R	14 70		08.89- 04.92 08.89- 04.92	JS760 JS560	12 0.8 12 1.0
Corolla 1.6 i 4WD	(.E9_)[4A-FE]	10.87- 08.90	JA5521R	14 70		10.87- 08.90	JS560	12 1.0
Corolla 1.6 Si	(AE101)[4A-FE]	05.92- 04.97 05.92- 04.97	JA9761R JA9871R	14 70 14 80		05.95- 04.97 05.95- 04.97 05.95- 04.97 05.92- 04.95 05.92- 04.95	JS1141 JS918 JS1105 JS760 JS560	12 1.1 ND 12 0.8 ND 12 1.1 BO 12 0.8 12 1.0
	(E10)[4A-FE]	AT 05.95- 04.97	JA9761R	14 70		05.95- 04.97	JS918	12 0.8
Corolla 1.6 VVTi	(.E12U_ _E12J_)[1ZR-FE]	10.06-	JA17031R	14 80		10.06-	JS1236	12 1.1
	(E12_ _12J_)[3ZZ-FE]	01.02- 01.02- 01.02- AC 01.02-	CA20471R* JA16051R JA17031R JA16051R	14 70 14 80 14 80 14 80		10.06- 01.02-	JS1230 JS1236	12 0.8 12 1.1
Corolla 1.6 VVTi Verso	(E12)[3ZZ-FE]	01.02- 05.04 01.02- 05.04 01.02- 05.04 AC 01.02- 05.04	CA20471R* JA16051R JA17031R JA16051R	14 70 14 80 14 80 14 80		01.02- 05.04	JS1236	12 1.1
Corolla 1.8 4WD	[7A-FE]	04.97- 07.01	JA9761R	14 70		04.97- 07.01 04.97- 07.01	JS1141 JS1105	12 1.1 ND 12 1.1 BO
Corolla 1.8 Verso	(ZER_ ZZE_)[1ZZ-FE]	02.04- 02.04-	JA16051R JA18941R	14 80 14 90		02.04-	JS1362	12 1.3
Corolla 1.8 16V 4WD	(E10)[7A-FE]	09.95- 04.97	JA9881R	14 70		09.95- 04.97	JS1105	12 1.1
Corolla 1.8 GTi 4x4	(.E10_)	05.92- 07.95	JA9761R	14 70		05.92- 07.95	JS760	12 0.8
Corolla 1.8 i 16V Verso	(E12)[1ZZ-FE]	09.01- 05.04 01.02- 05.04	CA20471R* JA17031R	14 70 14 80		01.02- 05.04	JS1236	12 1.1
Corolla 1.8 i WTL-i TS	(E12_ _12J_)[2ZZ-GE]					09.01- 05.04 09.01- 05.04	JS1230 JS1236	12 0.8 12 1.1
Corolla 1.8 VVTi-i TS	(.E12U_ _E12J_)[2ZZ-GE]	02.05-	JA17221R	14 70		02.05-	JS1230	12 0.8
Corolla 1.8 Diesel	(.E9_)[1C] (AE9_)[1C] (CE90)[1C]	07.87- 05.89 06.89- 04.92 11.89- 04.92	JA1941R JA5711R# JA5711R#	14 60 14 60 14 60		A13 07.87- 04.92 A13 11.89- 06.92	JS774 JS774	12 2.2 12 2.2
	(CE90)[1C]	05.87- 05.92 08.87- 05.89	JA5711R# JA1941R	14 60 14 60		A13 05.87- 05.92	JS774	12 2.2
	[1C]					A13 05.87- 09.87	JS774	12 2.2
	[1C-L]	10.87- 05.88	JA1941R	14 60		A13 05.87- 05.88	JS774	12 2.2
Corolla 2.0 D-4D	(.E11_)[1CD-FTV]	09.00- 05.04	JA17831R	14 120		09.00- 05.04 09.00- 01.02	JS1088 CS1500*	12 2.2 12 1.4
	(.E12_ _E12T_)[1CD-FTV]	08.02-	CA19501R	14 100		08.02-	JS1135	12 2.0
	(.E12J_ _E12T_)[1CD-FTV]	04.04-	CA19501R	14 100		04.04-	JS1135	12 2.0
		04.04-	CA19511R*	14 90		04.04-	CS1500*	12 1.4
	(.E12U_ _E12J_)[1CD-FTV]	10.01-	CA19501R	14 100		05.03-	CS1500*	12 1.4
		10.01- 05.03-	CA19511R* JA17211R	14 90 14 130		10.01- 10.01-	JS1135 JS1088	12 2.0 12 2.2
	(ADE150R)[1AD-FTV]	01.07-	CA20361R*	14 100		01.07-	JS1369	12 2.0
	(E12_ _12J_)[1CD-FTV]	01.02- 05.04 01.02- 05.04	CA19511R* JA17211R	14 90 14 130		01.02- 05.04 01.02- 05.04	JS1135 CS1500*	12 2.0 12 1.4
						01.02- 05.04	JS1088	12 2.2



TOYOTA Continued

Corolla 2.0 D-4D Verso	(E12)[1CD-FTV]	01.02- 05.04	CA1951IR*	14 90	01.02- 05.04	JS1135	12 2.0
		01.02- 05.04	JA1721IR	14 130	01.02- 05.04	JS1088	12 2.2
	(ZER_ , ZZE_)[1CD-FTV]	04.04- 05.08	CA1950IR	14 100	01.02- 05.04	CS1500*	12 1.4
					04.04-	JS1135	12 2.0
Corolla 2.0 Diesel	(CE100)[2C]	05.92- 04.97	JA1166IR	14 80	05.92- 04.97	JS902	12 1.4
	[2C]	05.92- 04.97	JA1166IR	14 80	05.92- 04.97	JS902	12 1.4
	[2C-E]	04.97- 10.99	JA1166IR	14 80	04.97- 10.99	JS1138#	12 2.2
					04.97- 10.99	JS1157	12 1.4
Corolla 2.0 Diesel XL	(CE100)[2C]	05.92- 04.97	JA1166IR	14 80	05.92- 04.95	JS902	12 1.4
					A13 05.95- 04.97	JS1138#	12 2.2
					05.95- 04.97	JS1157	12 1.4
Corolla 2.2 D-4D	( E11_ )[2AD-FHV]	11.06-	CA1965IR*	14 100	11.06-	JS1369	12 2.0
Corolla 2.2 D-4D Verso	(ZER_ , ZZE_)[2AD-FHV]	08.05-	CA1965IR*	14 100	08.05-	JS1369	12 2.0
	[2AD-FTV]	10.05-	CA1965IR*	14 100	10.05-	JS1369	12 2.0
Corona 1.8	(TT1)[3T]	06.79- 01.81	JA131	14 40			
		06.79- 01.81	JA137	14 50			
	[3T]	06.79- 12.81	JA131	14 40			
		06.79- 12.81	JA137	14 50			
Corona 2.0	(RT104)[18R]	01.76- 09.79	JA131	14 40	01.76- 09.79	JS335#	12 0.9
		01.76- 09.79	JA137	14 50			
	[18R]	09.75- 09.79	JA131	14 40	09.75- 09.79	JS335#	12 0.9
		09.75- 09.79	JA137	14 50			
	[3S-FE]	10.93- 09.95	JA981IR	14 70	10.93- 09.95	JS913	12 1.4
		AT 10.93- 09.95	JA1134IR	14 80			
Corona 2.0 GTi	[3S-GE]				10.93- 09.95	JS913	12 1.4
Corona MK 2.0	(RX12)[18R]	12.75- 10.77	JA131	14 40	12.75- 10.77	JS335#	12 0.9
		12.75- 10.77	JA137	14 50			
Cressida 2.0	( _X6_ )[21R]	05.81- 07.82	JA131	14 40	05.81- 03.85	JS335#	12 0.9
		05.81- 03.85	JA137	14 50			
	[21R-C]	05.81- 07.82	JA131	14 40	05.81- 08.83	JS335#	12 0.9
		05.81- 08.83	JA137	14 50			
	(RX3_)[18R]	07.77- 07.81	JA131	14 40	07.77- 07.81	JS335#	12 0.9
		07.77- 07.81	JA137	14 50			
	(RX35)[18R]	12.77- 03.81	JA131	14 40	12.77- 03.81	JS335#	12 0.9
		12.77- 03.81	JA137	14 50			
	[21R]	09.80- 03.85	JA137	14 50	08.82- 03.85	JS316	12 1.0
		02.81- 07.82	JA131	14 40	09.80- 07.82	JS335#	12 0.9
Cressida 2.0 GLi	( _X6_ )[1G-E]	11.82- 12.84	JA137	14 50	11.82- 12.84	JS388	12 1.0
Cressida 2.2 Diesel	( _X6_ )[L]				01.83- 12.84	JS642	12 2.0
	[L]				06.81- 12.84	JS642	12 2.0
Crown 2.2 Diesel	( _S1_ )[L]				04.80- 07.83	JS392	12 2.5
					04.80- 07.83	JS642	12 2.0
Dyna 2.0	[3Y]				09.84- 08.87	JS385	12 1.0
Dyna 2.5 D-4D	(KD_ , LY_ )[2KD-FTV]				08.01-	CS1484*	12 2.0
Dyna 100 1.8	(YH81)[2Y]				08.85- 05.95	JS385	12 1.0
Dyna 100 2.4 Diesel	(LH80)[2L]	01.84- 07.88	JA193	14 50	08.87- 05.95	JS642	12 2.0
					AT 08.87- 05.95	JS392	12 2.5
					01.84- 08.88	JS392	12 2.5
					05.95- 08.01	JS1090	12 2.7
					05.95- 08.01	JS1089	12 2.0
Dyna 150 2.5 Diesel	(LY60)[2L]				08.87- 08.88	JS642	12 2.0
Dyna 150 2.8 Diesel	(LY61)[3L]	08.85- 05.95	JA193	14 50	09.93- 05.95	JS1090	12 2.7
		08.87- 01.92	JA777	14 55	09.93- 05.95	JS1089	12 2.0
					08.89- 09.93	JS642	12 2.0
Dyna 200 3.0 Diesel	(BU61)[11B]						
	(BU9_)[14B]	08.88- 05.95	JA553IR	14 40			
Hiace 1.6	(RH11,16,20,30,40)[12R]	01.79- 04.83	JA131	14 40	01.79- 04.83	JS336	12 0.8
		01.79- 04.83	JA137	14 50			
	[12R]	02.77- 03.83	JA131	14 40	02.77- 03.83	JS336	12 0.8
		02.77- 03.83	JA137	14 50			
Hiace 1.8	(H5G)[2Y]	03.83- 08.89	JA144	14 45	03.83- 08.89	JS385	12 1.0
	[2Y]	03.83- 08.89	JA144	14 45	03.83- 08.89	JS385	12 1.0
Hiace 2.0	( _H10_ )[1RZ]	02.90- 08.95	JA657IR	14 60	A13 08.93- 08.95	JS1101	12 1.4
					A13 02.90- 08.93	JS1019	12 1.4
					08.93- 08.95	JS1015	12 1.0
	(H5G)[3Y]	06.84- 08.89	JA144	14 45	06.84- 08.89	JS385	12 1.0
	(RZH102)[1RZ]	08.89- 08.93	JA657IR	14 60	08.93- 08.95	JS1015	12 1.0
					A13 08.89- 08.93	JS1019	12 1.4
					08.93- 08.95	JS1101	12 1.4
	[18R]	07.77- 03.83	JA131	14 40	07.77- 03.83	JS335#	12 0.9
		07.77- 03.83	JA137	14 50			
	[3Y]	06.84- 08.89	JA144	14 45	06.84- 08.89	JS385	12 1.0
Hiace 2.2 Diesel	(H5G)[L]	03.83- 05.84	JA193	14 50	03.83- 05.84	JS642	12 2.0
					07.79- 05.84	JS392	12 2.5
	[L]	01.83- 01.84	JA193	14 50	01.79- 01.84	JS642	12 2.0
					01.79- 05.84	JS392	12 2.5
Hiace 2.4	(RZH103)[2RZ-E]	08.89- 08.95	JA657IR	14 60	A13 08.89- 08.93	JS1019	12 1.4
					A13 08.93- 08.95	JS1101	12 1.4
					08.93- 08.95	JS1015	12 1.0
	[2RZ-E]	08.89- 08.95	JA657IR	14 60	A13 08.93- 08.01	JS1101	12 1.4
		08.95- 08.01	JA1535IR	14 70	08.93- 07.99	JS1015	12 1.0
					A13 08.89- 04.98	JS1019	12 1.4
Hiace 2.4 4WD	(H12, 22)[2RZ-E]	08.95- 04.98	JA1535IR	14 70	A13 08.95- 04.98	JS1101	12 1.4
		08.95- 04.98	JA1536IR	14 55	08.95- 04.98	JS1015	12 1.0
	(H18, 22)[2RZ-E]	08.95- 04.98	JA1535IR	14 70	08.95- 04.98	JS1015	12 1.0
		08.95- 04.98	JA1536IR	14 55	A13 08.95- 04.98	JS1101	12 1.4
	[2RZ-E]	08.89- 08.95	JA657IR	14 60	A13 08.89- 08.93	JS1019	12 1.4
					A13 08.93- 08.95	JS1101	12 1.4
					08.93- 08.95	JS1015	12 1.0
Hiace 2.4 Diesel	( _H10_ )[2L]	08.89- 08.93	JA750IR	14 55	08.93- 08.95	JS1089	12 2.0
		08.89- 08.93	JA881IR	14 70	A13 08.89- 08.93	JS392	12 2.5
		08.93- 08.95	JA989IR	14 70	08.89- 08.93	JS642	12 2.0
					A13 08.93- 08.95	JS1090	12 2.7
	(H12G)[2L]	07.99-	JA1367IR	14 70	07.99-	JS1090	12 2.7
	(H5G)[2L]	06.84- 08.89	JA193	14 50	06.84- 08.89	JS642	12 2.0
					06.84- 08.89	JS392	12 2.5
	(LH102)[2L]	08.89- 08.93	JA750IR	14 55	A13 08.93- 08.95	JS1090	12 2.7
		08.89- 08.93	JA881IR	14 70	A13 08.89- 08.93	JS392	12 2.5
		08.93- 08.95	JA989IR	14 70	08.89- 08.93	JS642	12 2.0
					08.93- 08.95	JS1089	12 2.0
	[2L]	01.84- 11.89	JA193	14 50	A13 08.93- 03.99	JS1090	12 2.7
		08.93- 08.95	JA989IR	14 70	08.93- 03.98	JS1089	12 2.0
		08.95- 07.99	JA1367IR	14 70	01.84- 11.89	JS642	12 2.0
		08.95-	JA1535IR	14 70	01.84- 11.89	JS392	12 2.5
Hiace 2.4 Diesel 4WD	( _H10_ )[2L]	08.89- 08.93	JA881IR	14 70	08.89- 08.95	JS392	12 2.5
		08.89- 08.95	JA989IR	14 70	08.89- 08.95	JS642	12 2.0
	(H5F)[2L]	01.87- 01.88	JA193	14 50	01.87- 01.88	JS642	12 2.0
					01.87- 01.88	JS392	12 2.5
Hiace 2.4 TD	(H18, 22)[2L-T]	08.95- 08.01	JA1367IR	14 70	08.95- 08.01	JS1089	12 2.0
					A13 08.95- 08.01	JS1090	12 2.7



	[2L-T]	08.95- 08.01	JA1367IR	14 70		08.95- 08.01	JS1090	12 2.7
						08.95- 08.01	JS1089	12 2.0
Hiace 2.4 TD 4WD	(H18, 22)[2L-T]	08.95-	JA1367IR	14 70		08.95- 08.95	JS1089	12 2.0
						A13 08.95-	JS1090	12 2.7
Hiace 2.5 D-4D	( H1 , H2 )[2KD-FTV]	08.06-	JA1796IR	14 80		08.06-	JS1155	12 2.7
	( H1 , H2 )[2KD-FTV]	08.06-	JA1796IR	14 80		08.06-	JS1155	12 2.7
	[2KD-FTV]	08.01-	CA2069IR*	14 100		08.01-	JS1155	12 2.7
		08.01-	JA1796IR	14 80		08.01-	JS1154	12 2.2
Hiace 2.5 D4-D 4WD	(H20 ) [2KD-FTV]	01.05-	CA2069IR*	14 100				
Hiace 2.5 D-4D 4WD	( H1 , H2 ) [2KD-FTV]	11.01-	JA1796IR	14 80		11.01-	JS1155	12 2.7
						11.01-	JS1154	12 2.2
						04.98-	JS1237	12 1.2
Hiace 2.7	(H12)[3RZ-FE]	04.98-	JA1535IR	14 70		04.98-	JS1237	12 1.2
	(H12G)[3RZ-FE]	04.98-	JA1535IR	14 70		04.98-	JS1237	12 1.2
	[3RZ-FE]	11.01- 05.06	JA1535IR	14 70		11.01- 05.06	JS1237	12 1.2
Hiace 2.7 4WD	(H19, 29)[3RZ-FE]	04.98-	JA1535IR	14 70		04.98-	JS1237	12 1.2
Hiace 2.8 Diesel	[3L]	08.89- 08.00	JA750IR	14 55		06.92- 08.00	JS642	12 2.0
						08.89- 08.00	JS392	12 2.5
Hilux 1.8	(YN51R)[2Y]	06.89- 07.94	JA144	14 45		06.89- 07.94	JS385	12 1.0
Hilux 2.0	[3Y]	01.84- 12.86	JA144	14 45		01.84- 12.86	JS385	12 1.0
Hilux 2.2 4WD	[4Y]	01.87- 12.89	JA144	14 45		01.87- 12.89	JS385	12 1.0
Hilux 2.4	( _ N ) [2RZ-FE]	08.94- 07.05	JA1536IR	14 55		08.94- 07.05	JS1101	12 1.4
						08.94- 07.05	JS1015	12 1.0
	[22RE]	06.89- 07.92	JA1123IR	14 60		06.89- 07.93	JS669	12 1.4
						06.89- 08.97	JS316	12 1.0
Hilux 2.4 4WD	[22R]	08.88- 07.92	JA1123IR	14 60		08.88- 08.97	JS316	12 1.0
						08.88- 07.93	JS669	12 1.4
Hilux 2.4 4x4	( _ N ) [2RZ-FE]	08.00- 07.05	JA1536IR	14 55		08.00- 07.05	JS1101	12 1.4
						08.00- 07.05	JS1015	12 1.0
Hilux 2.4 i 4WD	[2RZ-FE]	08.97- 08.01	JA1536IR	14 55		08.97- 08.01	JS1101	12 1.4
						08.97- 08.01	JS1015	12 1.0
Hilux 2.4 Diesel	(IN108)[2L]					08.93- 08.97	JS1089	12 2.0
						08.93- 08.97	JS1090	12 2.7
						08.91- 07.93	JS392	12 2.5
						08.91- 07.93	JS642	12 2.0
						08.88- 01.02	JS392	12 2.5
						08.88- 01.02	JS642	12 2.0
						03.95- 08.01	JS1089	12 2.0
						A13 03.95- 08.01	JS1090	12 2.7
Hilux 2.4 Diesel 4WD	( _ N ) [2L]					01.84- 08.88	JS392	12 2.5
						01.84- 08.88	JS642	12 2.0
						08.88- 08.97	JS392	12 2.5
						08.88- 09.97	JS642	12 2.0
Hilux 2.4 TD 4WD	[2L-T]	08.98- 08.01	JA989IR	14 70		08.97- 08.01	JS1090	12 2.7
						08.97- 08.01	JS1089	12 2.0
Hilux 2.5 D-4D	[2KD-FTV]	11.01-	JA1796IR	14 80		11.01-	CS1484*	12 2.0
						07.05-	CS1448*	12 2.7
						11.01- 07.05	JS1155	12 2.7
Hilux 2.5 D-4D 4WD	[2KD-FTV]	11.01-	JA1796IR	14 80		11.01-	CS1484*	12 2.0
						07.05-	CS1448*	12 2.7
						11.01- 07.05	JS1155	12 2.7
Hilux 2.5 D-4D 4x4	(N25)[2KD-FTV]	12.07-	JA1796IR	14 80		12.07-	CS1448*	12 2.7
Hilux 2.5 Diesel	[2KD-FTV]	12.07-	JA1796IR	14 80		12.07-	CS1448*	12 2.7
Hilux 2.5 Diesel 4x4	[2KD-FTV]	12.07-	JA1796IR	14 80		12.07-	CS1448*	12 2.7
Hilux 3.0 Diesel 4x4	[1KD-FTV]	12.07-	JA1796IR	14 80		12.07-	CS1448*	12 2.7
Hilux 3.4	( _ N ) [5VZ-FE]					08.00- 07.05	JS1231	12 1.4
Hilux 3.4 4x4	( _ N ) [5VZ-FE]					08.94- 07.05	JS1231	12 1.4
IQ 1.0	(KGJ10)[1KR-FE]					01.09-	JS336	12 0.8
Land Cruiser 2.4	(RJ70,73)[22R]	11.84- 12.89	JA131	14 40		11.84- 12.89	JS669	12 1.4
		11.84- 12.89	JA137	14 50		11.84- 12.89	JS316	12 1.0
	[22RE]	01.90- 11.90	JA140	14 50	▲	01.90- 05.93	JS669	12 1.4
						01.90- 05.93	JS316	12 1.0
Land Cruiser 2.4 Diesel	(LJ70)[2L]	11.84- 10.85	JA193	14 50		11.84- 10.85	JS642	12 2.0
						11.84- 10.85	JS392	12 2.5
Land Cruiser 2.4 TD	(LJ70)[2L-T]	01.90- 05.93	JA750IR	14 55		01.90- 09.92	JS642	12 2.0
						09.92- 01.95	JS1089	12 2.0
						09.92- 01.95	JS1090	12 2.7
						01.90- 09.92	JS392	12 2.5
	(LJ70,73)[2L-T]	10.85- 08.89	JA193	14 50		10.85- 12.89	JS642	12 2.0
						10.85- 12.89	JS392	12 2.5
	(LJ77)[2L-T]	01.90- 05.93	JA750IR	14 55		08.93- 01.95	JS1090	12 2.7
						08.93- 01.95	JS1089	12 2.0
						01.90- 08.93	JS392	12 2.5
						01.90- 08.93	JS642	12 2.0
Land Cruiser 3.0 D-4D	( _ J9 ) [1KD-FTV]	10.00-	JA1796IR	14 80		AT 10.00-	CS1447	12 3.0
						10.00-	JS1154	12 2.2
						10.00-	JS1155	12 2.7
	(J12)[1KD-FTV]	08.04- 08.04	CA2069IR*	14 100		A13 08.04-	JS1155	12 2.7
			JA1796IR	14 80		08.04-	JS1154	12 2.2
						AT 08.04-	CS1447	12 3.0
	(J15)[1KD-FTV]	03.10-	CA2069IR*	14 100		03.10-	CS1447	12 3.0
						03.10-	JS1154	12 2.2
						03.10-	JS1155	12 2.7
	[1KD-FTV]	01.03- 01.03-	CA2069IR*	14 100		01.03-	JS1155	12 2.7
			JA1796IR	14 80		AT 01.03-	CS1447	12 3.0
Land Cruiser 3.0 D-4D Prado	(J12)[1KZ-TE]					09.02-	JS1154	12 2.2
Land Cruiser 3.0 Diesel	(BJ40 V, BJ43 ) [B]					02.74- 10.84	JS655	24 4.5
Land Cruiser 3.0 TD	(KJ70)[1KZ-T]					05.93- 05.96	JS1154	12 2.2
	[1KZ-T]					05.93- 05.96	JS1154	12 2.2
Land Cruiser 3.0 TD 4WD	[1KZ-TE]	04.96-	JA1410IR	14 70		A13 04.96-	JS1155	12 2.7
						AT 04.96-	CS1447	12 3.0
						04.96-	JS1154	12 2.2
Land Cruiser 3.4 i 24V 4WD	[5VZ-FE]	04.96- 12.98	JA1410IR	14 70		04.96-	JS1231	12 1.4
Land Cruiser 3.4 Diesel	(BJ70LV-MRW)[3B]					11.84- 12.96	JS655	24 4.5
Land Cruiser 4.0 Diesel	(HJ47 _ V)[2F]					08.80- 10.84	JS666	24 4.5
	(HJ60)[2H]					08.80- 08.87	JS666	24 4.5
	[2H]					01.85- 08.87	JS666	24 4.5
Land Cruiser 4.0 TD	(HJ61)[12HT]					10.85- 12.89	JS666	24 4.5
Land Cruiser 4.2	(FJ60)[2F]	10.81- 11.84	JA131	14 40		01.90- 05.96	JS1217	24 4.5
Land Cruiser 4.2 Diesel	( _ J7 _ )	01.90- 05.96	JA1534IR	14 80		01.90- 05.96	JS1021	24 4.5
	(HZJ80 ) [1H-Z]	08.92- 12.97	JA1534IR	14 80		01.96- 12.97	JS1217	24 4.5
						01.90- 12.95	JS1021	24 4.5
Land Cruiser 4.2 TD	(HDJ80)[1HD-FT]	01.95- 12.97	JA1534IR	14 80		01.95- 05.96	JS1021	24 4.5
						05.96- 12.97	JS1217	24 4.5
	(HJD80)[1HD-T]	08.92- 12.97	JA1534IR	14 80		01.96- 12.97	JS1217	24 4.5
						01.90- 12.95	JS1021	24 4.5
	(HZJ7 _ V)[1H-Z]					01.90- 12.95	JS1021	24 4.5
						01.96-	JS1217	24 4.5
Land Cruiser 4.2 TD 100	(J10)[1HD-FTE]	01.98-	JA1534IR	14 80		01.98-	CS1483*	12 3.0
		01.98-	JA1724IR	14 120				



**TOYOTA** *Continued*

Liteace 1.3	(KM2)[4K]	10.79- 08.85	JA131	14	40			
		10.79- 08.85	JA137	14	50			
	[4K-C]	10.79- 08.85	JA131	14	40			
		10.79- 08.85	JA137	14	50			
Liteace 1.5	(M2_G)[4K]	10.79- 09.85	JA131	14	40			
	(KR21LG)[5K]	01.92- 01.95	JA131	14	40			
	(KR27_V)[5K]	01.92- 01.95	JA131	14	40			
	(M3)[5K]	05.86- 12.91	JA131	14	40			
		05.86- 12.91	JA137	14	50			
Liteace 1.8 Diesel	(CM30_V)[1C]	09.86- 08.88	JA578IR#	14	55	10.85- 08.88	JS774	12 2.2
	(M2_G)[1C]	11.83- 08.85	JA144	14	45	11.83- 08.85	JS385	12 1.0
Liteace 2.0 Diesel	(CM30LG)[2C]	08.88- 01.92	JA578IR#	14	55	08.88- 01.92	JS774	12 2.2
	(CM36)[2C]	08.88- 01.92	JA578IR#	14	55	08.88- 01.92	JS774	12 2.2
	(CR27_V)[2C]	01.92- 05.94	JA578IR#	14	55			
	[2C]	01.92- 05.94	JA578IR#	14	55			
Model F 1.8	(YR20)[2Y]	11.82- 08.84	JA144	14	45	11.82- 08.84	JS385	12 1.0
	[2Y-C]	11.82- 08.84	JA144	14	45	11.82- 08.84	JS385	12 1.0
Model F 2.0	(YR20)[3Y]	08.88- 01.90	JA657IR	14	60	08.88- 01.90	JS385	12 1.0
	(YR21)[3Y]	08.84- 08.85	JA144	14	45	08.84- 08.88	JS385	12 1.0
		09.85- 08.88	JA657IR	14	60			
MR2 1.6 16V	(AW11)[4A-GEL]	11.84- 12.89	JA142IR	14	60	11.84- 12.89	JS317	12 1.0
		11.84- 12.89	JA996IR#	14	70			
	[4A-GELC]	11.84- 12.89	JA142IR	14	60	11.84- 12.89	JS317	12 1.0
MR2 1.8 VVTi 16V	(ZZW30)[1ZZ-FE]	12.99-	JA1703IR	14	80	12.99-	JS1236	12 1.1
	(SV20)[3S-GE]	12.89- 11.92	JA1417IR	14	90	12.89- 08.99	JS632	12 1.4
MR2 2.0 16V		12.89- 11.92	JA882IR	14	80			
		11.92- 08.99	JA1418IR	14	80			
	(SW20)[3S-GE]	12.89- 11.92	JA1417IR	14	90	12.89- 08.99	JS632	12 1.4
		12.89- 11.92	JA882IR	14	80			
	[3S-GE]	12.89- 11.92	JA882IR	14	80	12.89- 08.99	JS632	12 1.4
Paseo 1.5 16V	(EL54)[5E-FE]	08.95- 07.99	JA1178IR	14	55	08.95- 07.99	JS1023	12 0.8
		08.95- 07.99	JA988IR	14	70	08.95- 07.99	JS1024	12 1.0
		AT 08.95- 07.99	JA988IR	14	70			
Picnic 2.0	(_XM10_) [3S-FE]	09.96- 05.01	JA1134IR	14	80	09.96- 05.01	JS912	12 1.0
Picnic 2.0 16V		09.96- 05.01	JA981IR	14	70	09.96- 05.01	JS1080	12 1.2
	(XM1)[3S-FE]	AT 05.96- 05.01	JA981IR	14	70	05.96- 05.01	JS1080	12 1.2
Picnic 2.2 Diesel		05.96- 05.01	JA1134IR	14	80	05.96- 05.01	JS912	12 1.0
	[3C-TE]	08.97- 05.01	JA1604IR	14	80	08.97- 05.01	JS1088	12 2.2
						12.01	CS1500*	12 1.4
Previa 2.0 D-4D	(ACR3_) [1CD-FTV]	03.01-	JA1721IR	14	130	03.01-	JS1088	12 2.2
Previa 2.4	[2TZ-FE]	05.90- 08.91	JA1351IR	14	70	A13 05.90- 12.99	JS894	12 1.6
		09.91- 08.93	JA1165IR	14	70	05.90- 12.99	JS1084	12 1.4
		08.93- 12.99	JA1369IR	14	70			
Previa 2.4 4WD		05.90- 08.91	JA1351IR	14	70	A13 08.90- 08.00	JS894	12 1.6
		09.91- 08.93	JA1165IR	14	70	08.90- 08.00	JS1084	12 1.4
		08.93-	JA1369IR	14	70			
Previa 2.4 16V	(ACR3)[2AZ-FE]	AC 08.00-	JA1613IR	14	100	08.00-	JS1302	12 1.2
RAV 4 1.8 i 16V	(XA2)[1ZZ-FE]	02.00-	JA1703IR	14	80	02.00-	JS1236	12 1.1
						02.00-	JS1230	12 0.8
RAV 4 2.0 16V	(4WD)[3S-FE]	04.94- 09.97	JA1134IR	14	80	04.94- 06.00	JS912	12 1.0
		04.94- 06.00	JA981IR	14	70	04.94- 06.00	JS1080	12 1.2
						A13 04.94- 06.00	JS913	12 1.4
	[3S-FE]	12.97- 08.00	JA1134IR	14	80	12.97- 06.00	JS912	12 1.0
		12.97- 08.00	JA981IR	14	70	A13 12.97- 06.00	JS913	12 1.4
					12.97- 06.00	JS1080	12 1.2	
RAV 4 2.0 i 16V 4WD	(XA2)[1AZ-FE]	06.00- 07.03	JA1792IR	14	90	11.05-	CS1476*	12 1.3
		06.00- 07.03	JA1797IR	14	100	06.00-	JS1302	12 1.2
		07.03-	JA1613IR	14	100			
RAV 4 2.0 VVTi	(ACA_, ACE_) [1AZ-FE]					11.05-	CS1476*	12 1.3
RAV 4 2.0 D-4D 4WD	(XA2)[1CD-FTV]	09.01-	JA1721IR	14	130	09.01-	JS1088	12 2.2
						09.01-	CS1500*	12 1.4
RAV 4 2.2 D-4D	(ACA_, ACE_)					12.08-	JS1369	12 2.0
	(ALA30)[2AD-FTV]	11.05-	CA2029IR	14	130	11.05-	JS1369	12 2.0
RAV 4 2.2 D-4D CAT	(ALA30)[2AD-FHV]	01.06-	CA2029IR	14	130	01.06-	JS1369	12 2.0
Starlet 1.0	(2K)[2K]	02.78- 07.82	JA130	14	30			
		02.78- 09.84	JA131	14	40			
		02.78- 09.84	JA137	14	50			
	(EP70L)[1E-L]	10.84- 12.89	JA1411IR	14	45	10.84- 12.89	JS357	12 0.8
	(EP80_) [1E]	12.89- 01.92	JA1421IR	14	60			
		02.78- 07.82	JA130	14	30			
		02.78- 09.84	JA131	14	40			
		02.78- 09.84	JA137	14	50			
Starlet 1.0 1000		02.78- 08.78	JA137	14	50			
		02.78- 08.78	JA131	14	40			
		02.78- 08.78	JA130	14	30			
Starlet 1.2	(KP6_) [3K-H]	10.78- 08.82	JA131	14	40			
Starlet 1.2 S	(KP62)[3K-H]	10.78- 08.82	JA130	14	30			
		10.78- 08.82	JA131	14	40			
		10.78- 08.82	JA137	14	50			
Starlet 1.3	(EP71L)[2E-LC]	10.84- 12.89	JA1411IR	14	45	10.84- 12.89	JS357	12 0.8
	[4E-FE]	01.96- 03.99	JA1178IR	14	55	01.96- 03.99	JS1023	12 0.8
		01.96- 03.99	JA988IR	14	70	01.96- 03.99	JS1024	12 1.0
		AT 01.96- 03.99	JA988IR	14	70			
Starlet 1.3 S	(KP61)[4K]	08.82- 09.84	JA131	14	40			
		08.82- 09.84	JA137	14	50			
Starlet 1.3 12V	(EP81)[2E-E]	12.89- 12.92	JA1289IR	14	55	A13 12.89- 05.94	JS525	12 1.0
		12.89- 06.91	JA1411IR	14	45	12.89- 05.94	JS357	12 0.8
		12.92- 01.96	JA1178IR	14	55			
		12.92- 01.96	JA988IR	14	70			
	(EP81_) [2E]	12.89- 06.91	JA1421IR	14	60	12.89- 12.92	JS357	12 0.8
	06.91- 12.92	JA1289IR	14	55				
	12.89- 06.91	JA1421IR	14	60	12.89- 12.92	JS357	12 0.8	
	06.91- 12.92	JA1289IR	14	55				
Starlet 1.5 Diesel	(_P8_) [1N]	01.92- 01.96	JA1178IR	14	55			
	(NP70L)[1N]	12.86- 01.92	JA1421IR	14	60			
Supra 2.8 i	(MA61)[5M-GE]	08.83- 10.86	JA657IR	14	60			
Supra 3.0 24V	(MA70)[7M-GE]	01.86- 08.88	JA1611IR	14	70			
Tercel 1.3	(AL20)[2A]	05.82- 04.85	JA138	14	45	05.82- 04.85	JS388	12 1.0
Tercel 1.5	(_L1_ _L2_) [3A-C]	10.82- 08.84	JA138	14	45			
	(AL25)[3A]	10.82- 05.86	JA138	14	45	10.82- 01.88	JS388	12 1.0
	[3A-C]					05.86- 01.88	JS388	12 1.0
Verso 2.0 D-4D	(AUR20)[1AD-FTV]	04.09-	CA1965IR*	14	100	04.09-	JS1369	12 2.0



Verso 2.2 D-4D	(AUR21)[2AD-FHV]	04.09-	CA1965IR*	14 100	04.09-	JS1369	12 2.0
Verso 2.2 D-CAT	(AUR21)[2AD-FHV]	04.09-	CA1965IR*	14 100	04.09-	JS1369	12 2.0
Yaris 1.0 16V	( _CP10_)[1SZ-FE]	01.03- 05.02-	JA1800IR JA1809IR	14 90 14 70	01.03- 01.03-	JS1299 JS1308	12 0.7 12 1.2
Yaris 1.0 i	(SCP10)[1SZ-FE]	04.99- 04.99- 04.99- 12.02- 12.02-	JA1517IR JA1714IR JA1722IR JA1800IR JA1809IR	14 90 14 80 14 70 14 90 14 70	04.99- 04.99- 04.99-	JS1308 JS1223 JS1299	12 1.2 12 1.0 12 0.7
Yaris 1.0 VVTi	(1KR-FE)	Produced in France 01.01- Produced in France 01.01- Produced in Japan 01.06- Produced in France 01.06- Produced in France 01.06-	CA2102IR* CA1889IR CA2102IR*	14 80 14 90 14 80	Produced in Japan 01.06-	CS1490*	12 0.85
Yaris 1.0	( _P9_)[1KR-FE]	01.06-	CA2102IR*	14 80	01.06-	CS1490*	12 0.85
Yaris 1.3	(2SZ-FE)	05.02- 01.06 05.02- 01.06	JA1800IR JA1809IR	14 90 14 70	05.02- 01.06 04.02-	JS1308 CS1506*	12 1.2 12 1.2
Yaris 1.3 16V	(NCP10)[2NZ-FE]	11.99- 11.99- 11.99-	JA1595IR JA1793IR JA1794IR	14 90 14 70 14 80	AT 11.99- 11.99- 11.99-	CS1499* JS1224 JS1233	12 1.6 12 1.0 12 0.8
Yaris 1.3 VVTi	(2SZ-FE)	Produced in Japan 01.06- Produced in France 01.06- Produced in France 01.06-	CA2027IR CA1929IR* CA1942IR*	14 100 14 80 14 90	Produced in France 01.06-	CS1506*	12 1.2
Yaris 1.4 D-4D	(NLP10)[1ND-TV]	12.01- 08.05 12.01- 08.05 12.01- 08.05 12.01-	JA1793IR JA1891IR JA1892IR JA1893IR	14 70 ▲ 14 90 14 90 14 70	12.01- 08.05 12.01- 08.05	JS1357 JS1358	12 1.4 12 2.0
	(NLP90)[1ND-TV]	01.06- 01.06-	CA1930IR* CA2097IR*	14 90 14 100	01.06- 10.08 A13 01.06- 10.08	CS1453 JS1358	12 1.1 12 2.0
Yaris 1.5	(1NZ-FE)	11.05- 11.05- 11.05-	JA1595IR JA1793IR JA1794IR	14 90 14 70 14 80	11.05- 11.05-	JS1233 JS1224	12 0.8 12 1.0
Yaris 1.5 i 16V	(NCP13)[1NZ-FE]	04.01- 04.01- 04.01-	JA1595IR JA1793IR JA1794IR	14 90 14 70 14 80	04.01- 04.01-	JS1224 JS1233	12 1.0 12 0.8
Yaris 1.5 TS	( _CP10_)[1NZ-FE]	01.01- 01.01- 01.01-	JA1595IR JA1793IR JA1794IR	14 90 14 70 14 80	01.01- 01.01-	JS1233 JS1224	12 0.8 12 1.0
Yaris 1.5 VVTi TS	( _CP10_)[1NZ-FE]	03.03- 07.05 03.03- 07.05 03.03- 07.05	JA1595IR JA1793IR JA1794IR	14 90 14 70 14 80	03.03- 07.05 03.03- 07.05	JS1224 JS1233	12 1.0 12 0.8
Yaris 1.8 VVTi	(2ZR-FE)	01.07-	CA2027IR	14 100			
Yaris Verso 1.3	(NCP2_)[2NZ-FE]	08.99- 08.99- 08.99-	JA1595IR JA1793IR JA1794IR	14 90 14 70 14 80	AT 11.99- 08.99- 08.99-	CS1499* JS1224 JS1233	12 1.6 12 1.0 12 0.8
Yaris Verso 1.4 D-4D	(NLP22)[1ND-TV]	12.01- 09.05 12.01- 09.05 12.01- 09.05 12.01-	JA1793IR JA1891IR JA1892IR JA1893IR	14 70 ▲ 14 90 14 90 14 70	12.01- 09.05 12.01- 09.05	JS1357 JS1358	12 1.4 12 2.0
Yaris Verso 1.5 16V	(NCP21)[1NZ-FE]	03.00- 03.00- 03.00-	JA1595IR JA1793IR JA1794IR	14 90 14 70 14 80	03.00- 03.00-	JS1233 JS1224	12 0.8 12 1.0
Yaris Verso 1.5 TS	(NCP2_)[1NZ-FE]	08.99- 08.99- 08.99-	JA1595IR JA1793IR JA1794IR	14 90 14 70 14 80	08.99- 08.99-	JS1224 JS1233	12 1.0 12 0.8
<b>PASSENGER CARS US</b>							
4 Runner 2.4	[22R]				01.84- 01.84	JS316	12 1.0
	[22REC]	01.85- 01.85	JA1123IR	14 60	01.84- 01.84	JS669	12 1.4
					01.85- 01.85	JS316	12 1.0
					01.85- 01.85	JS669	12 1.4
4 Runner 2.4 DLX	[22REC]	01.86- 01.89	JA1123IR	14 60	01.86- 01.89	JS316	12 1.0
					01.86- 01.89	JS669	12 1.4
4 Runner 2.4 SR5	[22RE]	01.90- 01.93	JA1123IR	14 60	01.90- 01.93	JS316	12 1.0
	[22REC]	01.86- 01.89	JA1123IR	14 60	01.90- 01.93	JS669	12 1.4
					01.86- 01.89	JS669	12 1.4
					01.86- 01.89	JS316	12 1.0
4 Runner 2.4 Turbo SR5	[22RTEC]	01.85- 01.88	JA1123IR	14 60	01.85- 01.88	JS669	12 1.4
					01.85- 01.88	JS316	12 1.0
4 Runner 3.0 DLX	[3VZ-E]	01.89- 01.89	JA783IR	14 70			
4 Runner 3.0 SR5	[3VZ-E]				01.94- 01.95	JS1099#	12 1.4
Camry 1.8 Turbo DLX	[1CTLG]	01.84- 01.85	JA194IR	14 60			
Camry 2.0	[3S-FE]	01.88- 01.91	JA161IR	14 70	01.88- 01.91	JS652	12 1.0
					01.88- 01.91	JS632	12 1.4
Camry 2.0 All Trac		01.89- 01.91	JA161IR	14 70	01.89- 01.91	JS652	12 1.0
					01.89- 01.91	JS632	12 1.4
Camry 2.0 DLX	[2S-ELC]	01.83- 01.86	JA161IR	14 70			
	[3S-FE]	01.87- 01.91	JA161IR	14 70	01.87- 01.91	JS652	12 1.0
					01.87- 01.91	JS632	12 1.4
Camry 2.0 DLX All Trac	[3S-FE]	01.88- 01.91	JA161IR	14 70	01.88- 01.91	JS652	12 1.0
					01.88- 01.91	JS632	12 1.4
Camry 2.0 LE	[2S-ELC]	01.83- 01.86	JA161IR	14 70			
	[3S-FE]	01.87- 01.91	JA161IR	14 70	01.87- 01.91	JS632	12 1.4
					01.87- 01.91	JS652	12 1.0
Camry 2.0 LE All Trac	[3S-FE]	01.88- 01.91	JA161IR	14 70	01.88- 01.91	JS652	12 1.0
					01.88- 01.91	JS632	12 1.4
Camry 2.0 Turbo DLX	[2C-TLC]	01.86- 01.86	JA194IR	14 60			
Camry 2.2	[5S-FE]	01.98- 01.01 01.93- 01.93	JA1134IR JA981IR	14 80 14 70	01.93- 01.93	JS632	12 1.4
Camry 2.2 CE	[5S-FE]	01.97- 01.97	JA1134IR	14 80			
Camry 2.2 DLX	[5S-FE]	01.92- 01.92	JA161IR	14 70	01.92- 01.92	JS632	12 1.4
Camry 2.2 DX	[5S-FE]	01.93- 01.96 01.95- 01.96	JA981IR JA1134IR	14 70 14 80	01.93- 01.94	JS632	12 1.4
Camry 2.2 LE	[5S-FE]	01.92- 01.94 01.95- 01.97 01.95- 01.96	JA161IR JA1134IR JA981IR	14 70 14 80 14 70	01.92- 01.94	JS632	12 1.4
Camry 2.2 XLE	[5S-FE]	01.92- 01.94 01.95- 01.97 01.95- 01.96	JA161IR JA1134IR JA981IR	14 70 14 80 14 70	01.92- 01.94	JS632	12 1.4
Camry 2.2	[5SN-FE]	01.00- 01.01	JA1134IR	14 80			
Camry 2.5 DLX	[2VZ-FE]	01.88- 01.91	JA1164IR#	14 70	01.88- 01.91	JS652	12 1.0
					01.88- 01.91	JS632	12 1.4
Camry 2.5 LE	[2VZ-FE]	01.88- 01.91	JA1164IR#	14 70	01.88- 01.91	JS652	12 1.0
					01.88- 01.91	JS632	12 1.4
Camry 3.0					01.93- 01.93	JS632	12 1.4
Camry 3.0 DLX	[3UZ-FE]				01.92- 01.92	JS632	12 1.4
Camry 3.0 DX	[3VZ-FE]				01.93- 01.93	JS632	12 1.4
Camry 3.0 LE	[1MZ-FE]				01.94- 01.94	JS632	12 1.4
	[3VZ-FE]				01.92- 01.93	JS632	12 1.4
Camry 3.0 SE	[1MZ-FE]				01.94- 01.94	JS632	12 1.4
	[3VZ-FE]				01.92- 01.93	JS632	12 1.4
Camry 3.0 XLE	[1MZ-FE]				01.94- 01.94	JS632	12 1.4
	[3VZ-FE]				01.92- 01.93	JS632	12 1.4



**TOYOTA** *Continued*

Celica 1.6 ST	[4A-FE]	01.90- 01.93	JA189IR	14	55	01.90- 01.93	JS560	12	1.0
		01.90- 01.93	JA552IR	14	70				
Celica 1.8		01.94- 01.95	JA976IR	14	70				
Celica 1.8 ST	[7A-FE]	01.94- 01.97	JA976IR	14	70				
Celica 1.9	[8R-C]					01.71- 01.71	JS335#	12	0.9
Celica 2.0	[18RC]					01.72- 01.74	JS335#	12	0.9
Celica 2.0 GT	[2S-ELC]	01.86- 01.86	JA161IR	14	70				
	[3S-FE]	01.87- 01.89	JA161IR	14	70	01.87- 01.89	JS652	12	1.0
						01.87- 01.89	JS632	12	1.4
Celica 2.0 GTS Sport	[3S-GELC]	01.86- 01.89	JA161IR	14	70	01.86- 01.89	JS644	12	1.0
Celica 2.0 ST	[3S-FE]	01.87- 01.89	JA161IR	14	70	01.87- 01.89	JS652	12	1.0
						01.87- 01.89	JS632	12	1.4
Celica 2.0 ST Sport	[2S-ELC]	01.86- 01.86	JA161IR	14	70				
Celica 2.0 Turbo All Trac	[3S-GTE]	01.88- 01.92	JA161IR	14	70	01.88- 01.92	JS652	12	1.0
						01.88- 01.92	JS632	12	1.4
Celica 2.0 Turbo GTS All Trac	[3S-GTE]					01.93- 01.93	JS632	12	1.4
						01.93- 01.93	JS652	12	1.0
Celica 2.2	[20R]	01.75- 01.80	JA137	14	50	01.75- 01.80	JS335#	12	0.9
						01.75- 01.80	JS669	12	1.4
	[5S-FE]	01.99- 01.99	JA981IR	14	70				
Celica 2.2 GT	[5S-FE]	01.90- 01.93	JA783IR	14	70	01.90- 01.93	JS632	12	1.4
		01.94- 01.98	JA981IR	14	70	01.90- 01.93	JS652	12	1.0
Celica 2.2 GTS		01.90- 01.92	JA783IR	14	70	01.90- 01.92	JS652	12	1.0
						01.90- 01.92	JS632	12	1.4
Celica 2.2 GTS Sport	[5S-FE]	01.90- 01.93	JA783IR	14	70	01.90- 01.93	JS632	12	1.4
						01.90- 01.93	JS652	12	1.0
Celica 2.4 GT	[22R]					01.81- 01.82	JS316	12	1.0
	[22REC]					01.81- 01.82	JS669	12	1.4
						01.83- 01.85	JS316	12	1.0
						01.83- 01.85	JS669	12	1.4
Celica 2.4 GTS	[22REC]					01.83- 01.85	JS316	12	1.0
						01.83- 01.85	JS669	12	1.4
Celica 2.4 ST	[22R]					01.81- 01.83	JS316	12	1.0
	[22REC]					01.81- 01.83	JS669	12	1.4
						01.84- 01.85	JS316	12	1.0
						01.84- 01.85	JS669	12	1.4
Corolla 1.1	[KC]	01.68- 01.69	JA130	14	30	01.68- 01.69	JS330#	12	0.6
Corolla 1.2	[3K-C]	01.70- 01.74	JA130	14	30	01.70- 01.74	JS330#	12	0.6
Corolla 1.6	[4A-C]					01.83- 01.83	JS388	12	1.0
	[4A-FE]	01.90- 01.92	JA189IR	14	55	01.90- 01.92	JS563	12	1.0
		01.93- 01.97	JA976IR	14	70	01.90- 01.94	JS560	12	1.0
		01.93- 01.94	JA987IR	14	80	01.95- 01.97	JS1141	12	1.1
		01.89- 01.89	JA189IR	14	55	01.89- 01.89	JS563	12	1.0
						01.89- 01.89	JS560	12	1.0
Corolla 1.6 DLX	[4A-C]					01.83- 01.83	JS388	12	1.0
	[4A-F]	01.88- 01.89	JA189IR	14	55	01.88- 01.89	JS560	12	1.0
	[4A-FE]	01.90- 01.92	JA189IR	14	55	01.90- 01.92	JS563	12	1.0
						01.90- 01.92	JS560	12	1.0
	[4A-LC]	01.84- 01.87	JA189IR	14	55				
Corolla 1.6 DLX All Trac	[4A-FE]	01.88- 01.92	JA189IR	14	55	01.88- 01.92	JS563	12	1.0
Corolla 1.6 DLX Sport	[4A-C]					01.84- 01.87	JS388	12	1.0
Corolla 1.6 DX	[4A-FE]	01.96- 01.96	JA976IR	14	70	01.96- 01.96	JS1141	12	1.1
Corolla 1.6 FX	[4A-LC]	01.87- 01.87	JA189IR	14	55				
Corolla 1.6 FX16	[4A-GELC]	01.87- 01.88	JA142IR	14	60	01.87- 01.88	JS317	12	1.0
Corolla 1.6 FX16 GTS	[4A-GELC]	01.87- 01.88	JA142IR	14	60	01.87- 01.88	JS317	12	1.0
Corolla 1.6 GTS	[4A-GE]	01.88- 01.91	JA142IR	14	60	01.88- 01.91	JS317	12	1.0
Corolla 1.6 GTS Sport	[4A-GEC]	01.85- 01.87	JA142IR	14	60	01.85- 01.87	JS317	12	1.0
Corolla 1.6 LE	[4A-F]	01.88- 01.89	JA189IR	14	55	01.88- 01.89	JS560	12	1.0
	[4A-FE]	01.90- 01.92	JA189IR	14	55	01.90- 01.92	JS560	12	1.0
						01.90- 01.92	JS563	12	1.0
	[4A-LC]	01.84- 01.87	JA189IR	14	55				
Corolla 1.6 LE LTD	[4A-LC]	01.85- 01.86	JA189IR	14	55	01.92- 01.92	JS563	12	1.0
Corolla 1.6 LSX		01.92- 01.92	JA189IR	14	55	01.92- 01.92	JS560	12	1.0
Corolla 1.6 SR5	[4A-C]					01.83- 01.83	JS388	12	1.0
	[4A-F]	01.88- 01.89	JA189IR	14	55	01.88- 01.89	JS560	12	1.0
	[4A-FE]	01.90- 01.91	JA189IR	14	55	01.90- 01.91	JS563	12	1.0
						01.90- 01.91	JS560	12	1.0
		01.92- 01.92	JA189IR	14	55	01.92- 01.92	JS563	12	1.0
						01.92- 01.92	JS560	12	1.0
Corolla 1.6 SR5 All Trac	[4A-FE]	01.88- 01.91	JA189IR	14	55	01.88- 01.91	JS563	12	1.0
		01.92- 01.92	JA189IR	14	55	01.92- 01.92	JS563	12	1.0
Corolla 1.6 SR5 Sport	[4A-C]					01.84- 01.87	JS388	12	1.0
Corolla 1.8	[7A-FE]	01.97- 01.97	JA976IR	14	70	01.97- 01.97	JS1141	12	1.1
		01.93- 01.93	JA976IR	14	70	01.93- 01.93	JS560	12	1.0
		01.93- 01.93	JA987IR	14	80	01.93- 01.93	JS560	12	1.0
Corolla 1.8 All Trac		01.93- 01.93	JA987IR	14	80				
		01.93- 01.93	JA976IR	14	70				
Corolla 1.8 DX	[7A-FE]	01.93- 01.97	JA976IR	14	70	01.95- 01.97	JS1141	12	1.1
		01.93- 01.94	JA987IR	14	80	01.93- 01.94	JS560	12	1.0
Corolla 1.8 LE	[7A-FE]	01.93- 01.95	JA976IR	14	70	01.95- 01.95	JS1141	12	1.1
		01.93- 01.94	JA987IR	14	80	01.93- 01.94	JS560	12	1.0
Corolla 1.8 DLX	[1CLC]	01.84- 01.85	JA194IR	14	60				
Corona 1.9	[3R-C]					01.67- 01.70	JS335#	12	0.9
Corona 2.0	[18RC]	01.74- 01.74	JA137	14	50	01.72- 01.74	JS335#	12	0.9
						01.72- 01.74	JS669	12	1.4
Corona 2.2	[20R]					01.79- 01.80	JS335#	12	0.9
						01.79- 01.80	JS669	12	1.4
Corona 2.2 Custom	[20R]	01.77- 01.78	JA137	14	50	01.77- 01.78	JS669	12	1.4
						01.77- 01.78	JS335#	12	0.9
Corona 2.2 DLX	[20R]	01.75- 01.78	JA137	14	50	01.75- 01.78	JS335#	12	0.9
						01.75- 01.78	JS669	12	1.4
Corona 2.2 SR5	[20R]	01.75- 01.76	JA137	14	50	01.75- 01.76	JS335#	12	0.9
						01.75- 01.76	JS669	12	1.4
Corona 2.4 DLX	[22R]					01.81- 01.82	JS316	12	1.0
						01.81- 01.82	JS669	12	1.4
Corona 2.4 Luxury Edition	[22R]					01.81- 01.82	JS316	12	1.0
						01.81- 01.82	JS669	12	1.4
Corona MK 1.9	[3R-C]					01.69- 01.70	JS335#	12	0.9
Corona MK 2.0	[18RC]					01.72- 01.72	JS335#	12	0.9
						01.72- 01.72	JS669	12	1.4
Cressida 3.0 Luxury	[7M-GE]	01.89- 01.92	JA161IR	14	70				
Crown 2.3	[2M]	01.68- 01.71	JA144	14	45				
Highlander 2.4	[2AZ-FE]	01.01- 01.03	JA1797IR	14	100				
Land Cruiser 3.9	[F]	01.73- 01.74	JA144	14	45				
	[FJ]	01.69- 01.72	JA144	14	45				
Land Cruiser 4.2	[2F]	01.75- 01.77	JA144	14	45				
Mark II 2.3	[2M]	01.72- 01.72	JA144	14	45				
Mark II 2.6	[4M]	01.73- 01.76	JA144	14	45				
MR2 1.6	[4A-GELC]	01.85- 01.89	JA142IR	14	60	01.85- 01.89	JS317	12	1.0
MR2 2.0 Turbo	[3S-GTE]	01.91- 01.95	JA1417IR	14	90	01.91- 01.95	JS632	12	1.4
MR2 2.2	[5S-FE]	01.91- 01.95	JA1417IR	14	90	01.91- 01.95	JS632	12	1.4





Paseo 1.5	[5E-FE]	01.92- 01.95	JA142IR	14 60	01.92- 01.97 JS357	12 0.8
					01.92- 01.95 JS525	12 1.0
Pick Up 1.9	[8R-C]	01.70- 01.71	JA130	14 30	01.70- 01.71 JS335#	12 0.9
Pick Up 2.0	[18RC]				01.72- 01.74 JS335#	12 0.9
Pick Up 2.2	[20R]				01.75- 01.80 JS335#	12 0.9
					01.75- 01.80 JS669	12 1.4
Pick Up 2.2	[L]				01.81- 01.81 JS392	12 2.5
Pick Up 2.2 DLX	[L]				01.82- 01.83 JS392	12 2.5
Pick Up 2.2 SR5	[L]				01.83- 01.83 JS392	12 2.5
Pick Up 2.4	[22R]				01.81- 01.90 JS316	12 1.0
					01.81- 01.90 JS669	12 1.4
	[22RE]	01.89- 01.93	JA1123IR	14 60	01.89- 01.93 JS669	12 1.4
					01.89- 01.93 JS316	12 1.0
	[22REC]				01.84- 01.88 JS316	12 1.0
					01.84- 01.88 JS669	12 1.4
Pick Up 2.4 DLX	[22R]				01.82- 01.90 JS316	12 1.0
					01.82- 01.90 JS669	12 1.4
	[22RE]	01.89- 01.93	JA1123IR	14 60	01.89- 01.93 JS316	12 1.0
					01.89- 01.93 JS669	12 1.4
	[22REC]	01.87- 01.88	JA1123IR	14 60	01.87- 01.88 JS669	12 1.4
					01.87- 01.88 JS316	12 1.0
Pick Up 2.4 RN01		01.91- 01.91	JA1123IR	14 60	01.91- 01.91 JS316	12 1.0
					01.91- 01.91 JS669	12 1.4
Pick Up 2.4 RN02					01.93- 01.93 JS316	12 1.0
					01.93- 01.93 JS669	12 1.4
Pick Up 2.4 RN60		01.85- 01.85	JA1123IR	14 60	01.85- 01.85 JS316	12 1.0
					01.85- 01.85 JS669	12 1.4
Pick Up 2.4 RN63		01.86- 01.87	JA1123IR	14 60	01.86- 01.87 JS316	12 1.0
					01.86- 01.87 JS669	12 1.4
Pick Up 2.4 SR5	[22R]				01.82- 01.83 JS316	12 1.0
					01.82- 01.83 JS669	12 1.4
	[22RE]	01.89- 01.90	JA1123IR	14 60	01.89- 01.90 JS316	12 1.0
					01.89- 01.90 JS669	12 1.4
	[22REC]				01.84- 01.88 JS316	12 1.0
					01.84- 01.88 JS669	12 1.4
Pick Up 2.4 Turbo	[22RTEC]	01.86- 01.87	JA1123IR	14 60	01.86- 01.87 JS316	12 1.0
					01.86- 01.87 JS669	12 1.4
Pick Up 2.4 Turbo SR5	[22RTEC]	01.85- 01.88	JA1123IR	14 60	01.85- 01.88 JS316	12 1.0
					01.85- 01.88 JS669	12 1.4
Pick Up 2.4 DLX	[2L]				01.84- 01.85 JS392	12 2.5
Pick Up 2.4 LN56					01.84- 01.84 JS392	12 2.5
Pick Up 2.4 S/B X/C DX	[2L]				01.85- 01.85 JS392	12 2.5
Pick Up 2.4 Turbo DLX	[2LT]				01.85- 01.85 JS392	12 2.5
Pick Up 2.4 Turbo S/B X/C DX	[2LT]				01.85- 01.85 JS392	12 2.5
Pick Up 3.0 DLX	[3VZ-E]				01.94- 01.95 JS1099#	12 1.4
Pick Up 3.0 SHT BD DLX EXC	[3VZ-E]	01.91-	JA783IR	14 70		
Pick Up 3.0 SR5	[3VZ-E]				01.94- 01.95 JS1099#	12 1.4
Previa 2.4 DLX	[2TZ-FE]	01.91- 01.93	JA1351IR	14 70	01.91- 01.93 JS1084	12 1.4
		01.94- 01.95	JA1369IR	14 70	01.91- 01.95 JS894	12 1.6
Previa 2.4 LE	[2TZ-FE]	01.91- 01.93	JA1351IR	14 70	01.91- 01.93 JS894	12 1.6
					01.91- 01.93 JS1084	12 1.4
Previa 2.4 Super DX	[2TZ-FZE]				01.97- 01.97 JS894	12 1.6
Previa 2.4 Super LE	[2TZ-FZE]				01.94- 01.97 JS894	12 1.6
RAV 4 2.0	[3S-FE]	01.96- 01.00	JA1134IR	14 80	01.96- 01.00 JS1080	12 1.2
Solara 2.2	[5S-FE]	01.99- 01.01	JA1134IR	14 80		
Supra 3.0	[7M-GE]	01.86- 01.92	JA1611R	14 70		
Supra 3.0 Turbo	[7M-GTE]	01.87- 01.92	JA1611R	14 70		
T100 2.7	[3RZ-FE]				01.98- 01.98 JS1101	12 1.4
Tacoma 2.4	[2RZ-FE]				01.95- 01.96 JS1015	12 1.0
					01.95- 01.03 JS1101	12 1.4
Tacoma 2.4 Regular Cab	[2RZ-FE]				01.95- 01.96 JS1015	12 1.0
					01.95- 01.97 JS1101	12 1.4
Tacoma 2.7	[3RZ-FE]				01.95- 01.03 JS1101	12 1.4
Tacoma 2.7 Regular Cab	[3RZ-FE]				01.95- 01.97 JS1101	12 1.4
Tercel 1.5	[1AC]				01.80- 01.80 JS357	12 0.8
					01.80- 01.80 JS388	12 1.0
	[3A]				01.81- 01.85 JS388	12 1.0
	[3A-C]				01.81- 01.85 JS388	12 1.0
	[3E]	01.87- 01.90	JA1411R	14 45	01.87- 01.90 JS525	12 1.0
		01.87- 01.90	JA142IR	14 60	01.87- 01.90 JS357	12 0.8
	[3EE]	01.91- 01.94	JA142IR	14 60	01.91- 01.94 JS357	12 0.8
					01.91- 01.94 JS525	12 1.0
	[5E-FE]				01.95- 01.96 JS357	12 0.8
Tercel 1.5 DLX	[3A-C]				01.81- 01.88 JS388	12 1.0
	[3E]	01.87- 01.88	JA1411R	14 45	01.87- 01.88 JS525	12 1.0
		01.87- 01.88	JA142IR	14 60	01.87- 01.88 JS357	12 0.8
	[3EE]	01.90- 01.94	JA142IR	14 60	01.90- 01.94 JS525	12 1.0
					01.90- 01.94 JS357	12 0.8
Tercel 1.5 DX	[5E-FE]				01.95- 01.96 JS357	12 0.8
Tercel 1.5 EZ	[3E]	01.88- 01.88	JA1411R	14 45	01.88- 01.88 JS525	12 1.0
		01.88- 01.88	JA142IR	14 60	01.88- 01.88 JS357	12 0.8
	[3EE]	01.90- 01.90	JA142IR	14 60	01.90- 01.90 JS357	12 0.8
					01.90- 01.90 JS525	12 1.0
Tercel 1.5 LE	[3EE]	01.91- 01.93	JA142IR	14 60	01.91- 01.93 JS357	12 0.8
					01.91- 01.93 JS525	12 1.0
Tercel 1.5 S		01.90- 01.90	JA1411R	14 45	01.90- 01.94 JS357	12 0.8
		01.90- 01.94	JA142IR	14 60	01.90- 01.94 JS525	12 1.0
Tercel 1.5 SR5	[3A-C]				01.81- 01.88 JS388	12 1.0
Van 2.0 CRG	[3YEC]	01.84- 01.85	JA657IR	14 60	01.84- 01.85 JS385	12 1.0
Van 2.0 DX	[3YEC]	01.84- 01.85	JA657IR	14 60	01.84- 01.85 JS385	12 1.0
Van 2.0 LE	[3YEC]	01.84- 01.85	JA657IR	14 60	01.84- 01.85 JS385	12 1.0
Van 2.2 CRG	[4Y-EC]	01.86- 01.89	JA657IR	14 60		
Van 2.2 DX	[4Y-EC]	01.86- 01.89	JA657IR	14 60		
Van 2.2 LE	[4Y-EC]	01.86- 01.89	JA657IR	14 60		
<b>PASSENGER CARS AO</b>						
4 Runner 2.4 TD RS5 4WD	(_N130_) [2L-T]				A13 08.89- 11.95 JS392	12 2.5
					08.89- 11.95 JS642	12 2.0
4 Runner 3.0 TDi 4x4					09.00- 07.02 JS1154	12 2.2
Allion 2.0 4x4					06.01- 06.07 CS1476*	12 1.3
Avensis 2.0 VVTi	(T25) [1AZ-FE]				03.03- CS1476*	12 1.3
Avensis 2.4 VVTi Verso GLS	(AC_) [2AZ-FE]	10.03-	JA1613IR	14 100	10.03- CS1476*	12 1.3
Camry 2.0 4WD	(_V2_) [3S-FE]	08.88- 05.91	JA1611R	14 70	08.88- 05.91 JS652	12 1.0
					08.88- 05.91 JS632	12 1.4
Carina 2.0 GLi	(_T17_) [3S-FE]	12.87- 03.92	JA1611R	14 70	12.87- 03.92 JS652	12 1.0
		12.87- 03.92	JA783IR	14 70	A13 12.87- 03.92 JS632	12 1.4
Celica 2.2 GT	(_T20_) [5S-FE]				11.93- 08.99 JS913	12 1.4
Corolla 1.5 Levin S		06.91- 08.97	JA976IR	14 70	06.91- 08.97 JS560	12 1.0
					06.91- 08.97 JS760	12 0.8
Corolla 1.5 RC	(_E12_) [1NZ-FE]				06.04- JS1233	12 0.8
Corolla 1.6 XL	(_E9_) [4A-F]	09.89- 04.92	JA552IR	14 70	09.89- 04.92 JS1105	12 1.1
Corolla 1.8	(_12U_) [1ZZ-FE]	06.04-	JA1605IR	14 80		



**TOYOTA** Continued

	( _E12_ )(1ZZ-FE)	06.04-	CA2047IR*	14 70				
		06.04-	JA1605IR	14 80				
	( _E12_ , _E12T_ )(1ZZ-FE)	06.04-	JA1605IR	14 80				
Corolla 1.8 Linea Terra	( _E11_ )(7A-FE)	10.97- 10.01	JA987IR	14 80		10.97- 10.01	JS1141	12 1.1
						10.97- 10.01	JS918	12 0.8
Corolla 1.8 Verso	( _E12J_ )	03.04-	JA1605IR	14 80		03.04-	JS1362	12 1.3
		03.04-	JA1894IR	14 90		03.04-	JS1362	12 1.3
	(ZER , _ZZE_ )	03.04-	JA1605IR	14 80				
		03.04-	JA1894IR	14 90				
Corolla 1.8 VVTi Altis	(1ZZ-FE)	11.01- 05.04	CA2047IR*	14 70				
Corolla 2.0 D-4D GS	( _E11_ )(1CD-FTV)	08.00- 10.01	JA1783IR	14 120		08.00- 10.01	JS1088	12 2.2
						08.00- 10.01	CS1500*	12 1.4
Corolla 2.2 D-4D	( _E12J_ , _E12T_ )(2AD-FHV)	11.06-	CA1965IR*	14 100		11.06-	JS1369	12 2.0
	( _E12U_ , _E12J_ )(2AD-FHV)	11.06-	CA1965IR*	14 100		11.06-	JS1369	12 2.0
Hiace 2.5 D-4D	( _H1_ , _H2_ )(2KD-FTV)	09.06-	JA1796IR	14 80		09.06-	JS1155	12 2.7
	(H200)(2KD-FTV)	09.06-	CA2069IR*	14 100				
Hiace 2.5 D-4D 4x4	( _H1_ , _H2_ )(2KD-FTV)	09.06-	JA1796IR	14 80		09.06-	JS1155	12 2.7
Hiace 3.0 Diesel	( _H1_ , _H2_ )(5L)					08.98-	JS1090	12 2.7
Hilux 1.8	( _N_ )(2Y)	08.83- 07.88	JA144	14 45		08.83- 07.88	JS385	12 1.0
Hilux 2.5 Diesel 4x4	(2KD-FTV)					08.05-	CS1448*	12 2.7
Land Cruiser 3.0 TD GX 90 Custom 4WD	( _J8_ )(1KZ-T)					01.90- 09.91	JS1154	12 2.2
Land Cruiser 3.5 80 FRT-Top 4WD	( _J8_ )(1PZ)					01.90- 08.92	JS1021	24 4.5
Land Cruiser 3.5 FRT-Top 4WD	( _J7_ )(1PZ)					01.90- 08.92	JS1021	24 4.5
MR 2 2.0	( _W2_ )(3S-FE)	11.89- 08.92	JA882IR	14 80		11.89- 08.92	JS632	12 1.4
Picnic 2.4 VVTi 4x4	(2AZ-FE)					11.03- 08.06	CS1476*	12 1.3
Previa 2.4 GX	(TCR1 , _2_ )(2TZ-FZE)	01.94- 07.97	JA1369IR	14 70		01.94- 07.97	JS894	12 1.6
Starlet 1.3 XL	( _P8_ )(2E)	12.89- 12.91	JA1411IR	14 45		12.89- 12.91	JS357	12 0.8
Vitz 1.0 VVTi	(1KR-FE)					11.05-	CS1490*	12 0.85
Wish 2.0 Zi						04.03-	CS1476*	12 1.3
Yaris 1.0	( _P13_ )(1KR-FE)					12.10-	CS1490*	12 0.85
<b>FORK LIFTS</b>								
5FD40		01.88- 01.93	JA1170IR	14 50		01.88- 01.93	JS733	24 4.5
5FD45						01.88- 01.94	JS733	24 4.5
5FD50						01.90-	JS733	24 4.5
5FD60						01.90-	JS733	24 4.5
5FD70						01.90-	JS733	24 4.5
5FG10						01.86- 01.94	JS669	12 1.4
5FG14						01.86- 01.94	JS669	12 1.4
5FG20		01.89-	JA1170IR	14 50				
5FG23		01.89- 01.93	JA1170IR	14 50				
5FG25		01.89- 01.93	JA1170IR	14 50				
5FG35		01.89-	JA1170IR	14 50				
5FG38		01.89-	JA1170IR	14 50				
5FG40		01.89-	JA1170IR	14 50				
5FG45		01.90-	JA1170IR	14 50				
5FG50						01.94-	JS669	12 1.4
5FG60		01.90-	JA1170IR	14 50				
5FGL10						01.86-	JS669	12 1.4
5FGL14						01.86-	JS669	12 1.4
5FGL15						01.86-	JS669	12 1.4
5FGL18						01.86-	JS669	12 1.4
5FGL20		01.89-	JA1170IR	14 50		01.89-	JS669	12 1.4
5FGL23		01.89-	JA1170IR	14 50				
7FD10		01.98-	JA1536IR	14 55				
7FD14		01.98-	JA1536IR	14 55				
7FD15		01.98-	JA1536IR	14 55				
7FD18		01.98-	JA1536IR	14 55				
7FD20		01.98-	JA1536IR	14 55				
7FD23		01.98-	JA1536IR	14 55				
FG20	(2R)		JA130	14 30			JS669	12 1.4
			JA131	14 40				
FG25	(5R)		JA130	14 30			JS669	12 1.4
			JA131	14 40				
<b>Triumph</b>								
<b>PASSENGER CARS EU</b>								
Spitfire 1.5 1500	(FM11)	01.75- 12.80	CA17h	14 34		01.75- 12.80	CS19	12 0.8
Spitfire MK 1.3	(FM3)	01.71- 12.72	CA17h	14 34		01.71- 12.72	CS19	12 0.8
TR 6 2.5	(CF1)	01.72- 12.76	CA15h#	14 28				
		01.72- 12.76	CA17v	14 34				
TR 7 2.0	(CG2)	01.73- 12.81	CA17v	14 34				
<b>PASSENGER CARS US</b>								
GT6 2.0						01.68- 01.73	CS18	12 0.8
Spitfire 1.2		01.63- 01.67	CG50	14 22		01.63- 01.67	CS18	12 0.8
Spitfire 1.3		01.68- 01.72	CG50	14 22		01.68- 01.72	CS18	12 0.8
Spitfire 1.5	(FP)	01.75- 01.79	CA17h	14 34		01.75- 01.79	CS18	12 0.8
	(W)	01.80- 01.80	CA17h	14 34		01.80- 01.80	CS18	12 0.8
		01.73- 01.74	CA17h	14 34		01.73- 01.74	CS18	12 0.8
Spitfire 3.0						01.71- 01.73	CS78	12 0.75
TR 250 2.5		01.68- 01.68	CA17h	14 34		01.68- 01.68	CS18	12 0.8
TR 3A 2.0		01.60- 01.61	CG50	14 22				
TR 3B 2.0		01.62- 01.62	CG50	14 22				
TR 4 2.1		01.62- 01.64	CG50	14 22				
TR 4A 2.1		01.65- 01.67	CG50	14 22				
TR 6 2.5	(CF)	01.75- 01.76	CA18v	14 43				
		01.69- 01.73	CA17h	14 34		01.69- 01.70	CS18	12 0.8
TR 7 2.0	(I)	01.81- 01.81	CA17v	14 34		01.81- 01.81	CS72	12 1.1
	(CL)	01.75- 01.79	CA17v	14 34		01.75- 01.79	CS72	12 1.1
	(J)	01.80- 01.80	CA17v	14 34		01.80- 01.80	CS72	12 1.1
TR 8 3.5		01.80- 01.81	CA18h	14 43				
<b>Ursus</b>								
<b>AGRICULTURE</b>								
912						09.88- 12.90	CS232	24 4.0
						09.88- 12.90	CS394	24 4.0
1614						07.81- 12.89	CS682	12 3.0
<b>Valtra</b>								
<b>AGRICULTURE</b>								
305		01.83-	CA312IR	14 60		01.85- 01.89	CS604	12 2.8
355		01.89- 01.94	CA305IR	14 55				
405		01.83-	CA312IR	14 60		01.85-	CS604	12 2.8
455		01.89- 01.94	CA305IR	14 55				
505 3.3		08.82-	CA312IR	14 60		01.85-	CS604	12 2.8
605 3.3		08.82-	CA312IR	14 60		01.85-	CS604	12 2.8
705 4.4		08.82-	CA312IR	14 60		01.85-	CS604	12 2.8
805 4.4		08.82-	CA312IR	14 60		01.85-	CS604	12 2.8



905		01.83-	CA312IR	14 60		01.85-	CS604	12 2.8
2005		01.85-	CA366IR	14 90				
2105		01.85-	CA366IR	14 90				
6000		01.90-	CA312IR	14 60		01.90-	CS604	12 2.8
6100		01.90-	CA312IR	14 60				
6300		01.91-	CA564IR	14 65				
6400		01.91-	CA564IR	14 65		01.91-	CS604	12 2.8
6600		01.91-	CA564IR	14 65		01.91-	CS604	12 2.8
8000		09.90-	CA564IR	14 65				
8050	[620DS]	01.96-	CA1629IR	14 90		01.96-	CS944	12 3.0
8100		09.90-	CA564IR	14 65		09.90-	CS604	12 2.8
8150	[620DS]	01.96-	CA1629IR	14 90		01.96-	CS944	12 3.0
8300	[612D]	01.90- 01.93	CA564IR	14 65				
8400	[620DS]	01.93- 01.95	CA564IR	14 65		01.93- 01.95	CS604	12 2.8
8450	[620DV]	01.96-	CA1629IR	14 90		01.96-	CS944	12 3.0
8550	[634DS]	01.98-	CA1629IR	14 90		01.96-	CS944	12 3.0
8600	[612DS]	01.90- 01.93	CA564IR	14 65				
8750	[634DA]	01.98-	CA1629IR	14 90		01.96- 01.98	CS944	12 3.0
	[634DS]	01.98-	CA1629IR	14 90		01.96- 01.98	CS944	12 3.0
8950	[634DS]	01.98-	CA1629IR	14 90		01.98-	CS944	12 3.0
X 100		01.99-	CA1629IR	14 90				
X 110		01.99-	CA1629IR	14 90				
X 120		01.99-	CA1629IR	14 90				
<b>Vauxhall</b>								
<b>PASSENGER CARS EU</b>								
Agila 1.0		Chas. -8M110445 01.08-	CA2026IR*	14 75				
Agila 1.0 12V	[Z10XE]	09.99- 08.03	CA1257IR	14 70	Chas. -19P00893 09.99- 08.03	CS519	12 1.0	
		Chas. 1G021260- 09.99- 08.03	CA1747IR	14 70	Chas. 19P00894- 09.99- 08.03	CS1257	12 1.1	
	[Z10XEP]	08.03-	CA1747IR	14 70	08.03-	CS1257	12 1.1	
Agila 1.0 LPG	[K10B]	01.08-	CA2026IR*	14 75				
Agila 1.2	[K12B]	Chas. -8M110445 05.09-	CA2026IR*	14 75				
		Chas. -8M110445 01.08-	CA2026IR*	14 75				
Agila 1.2 16V	[K12B]	01.08-	CA2026IR*	14 75				
	[Z12XE]	09.00- 06.04	CA1257IR	14 70	09.00- 06.04	CS1257	12 1.1	
		Chas. 1G021260- 09.00- 06.04	CA1747IR	14 70				
Agila 1.2 16V Twinport	[Z12XEP]	07.04-	CA1747IR	14 70	07.04-	CS519	12 1.0	
Agila 1.2 LPG	[K12B]	04.08-	CA2026IR*	14 75				
Antara 2.0 CDTi	[Z20DM]				06.07-	CS1431	12 1.8	
	[Z20DMH]				05.06-	CS1431	12 1.8	
Antara 2.4	[Z24XED]				05.06-	CS879	12 1.1	
Arena 1.9 Diesel	[F8Q600]	03.98- 08.01	CA1304IR	14 75	03.98- 08.01	CS784	12 1.4	
	[F8Q606]	03.98- 08.01	CA1304IR	14 75	03.98- 08.01	CS784	12 1.4	
Arena 2.5 Diesel	[S8U758]	03.98- 08.01	CA1343IR	14 75	03.98- 08.01	CS370	12 2.2	
		03.98- 08.01	CA1434IR	14 110				
	[S8U780]	03.98- 08.01	CA1343IR	14 75				
		03.98- 08.01	CA1434IR	14 110				
	[S8U782]	03.98- 08.01	CA1343IR	14 75				
		03.98- 08.01	CA1434IR	14 110				
Astra 1.3	[13S]	09.84- 08.91	CA128IR	14 45	09.84- 08.91	CS162	12 0.7	
		09.84- 08.91	CA99IR	14 55				
Astra 1.6	[Z16LET]	10.06-	CA1973IR	14 120	10.06-	CS519	12 1.0	
					10.06-	CS1438	12 1.1	
	[Z16XEP]	09.05-	CA1833IR	14 120	09.05-	CS1257	12 1.1	
		09.05-	CA1882IR	14 100				
	[Z16XER]	Chas. 72094719- 10.06-	CA1960IR	14 120	10.06-	CS1438	12 1.1	
		Chas. -72094718 10.06-	CA1833IR	14 120				
Astra 1.8	[Z18XER]	Chas. 71052537- 05.08-	CA1960IR	14 120	05.08-	CS1438	12 1.1	
		Chas. -71052536 05.08-	CA1833IR	14 120				
Astra 1.9 CDTi	[Z19DTH]	Chas. 72172469-, 01.06- 75189053-, 78104401-, 8B000001-	CA1994IR	14 140	01.06-	CS1428	12 1.7	
		Chas. 72172469-, 01.06- 75189053-, 78104401-, 8B000001-	CA2045IR	14 120				
		Chas. -72172468, - 01.06- 75189052, - 78104400	CA1884IR	14 105				
		Chas. -72172468, - 01.06- 75189052, - 78104400	CA1890IR	14 130				
Astra 1.9 CDTi LE	[Z19DTL]	Chas. 72172469-, 08.05- 75189053-, 78104401-, 8B000001-	CA1994IR	14 140	08.05-	CS1264	12 1.7	
		Chas. 72172469-, 08.05- 75189053-, 78104401-, 8B000001-	CA2045IR	14 120				
		Chas. -72172468, - 08.05- 75189052, - 78104400	CA1884IR	14 105				
		Chas. -72172468, - 08.05- 75189052, - 78104400	CA1885IR	14 120				
		Chas. -72172468, - 08.05- 75189052, - 78104400	CA1890IR	14 130				
Astra 2.0 16V Turbo	[Z20LER]	01.06-	CA1909IR	14 120	01.06-	CS879	12 1.1	
Astra 2.0 i	[Z20LEL]	02.06- 09.06	CA1909IR	14 120	02.06- 09.06	CS879	12 1.1	
Astra 2.0 Turbo	[Z20LET]	03.02-	CA1581IR	14 100	03.02-	CS879	12 1.1	
Astra 2.0 Turbo SRI	[Z20LET]	Chas. 32242323-, 07.02- 35216265-, 38100965-	CA1765IR	14 120	07.02-	CS879	12 1.1	
		Chas. -32240322, - 07.02- 35216264, - 38100964	CA1581IR	14 100				
Astra D 1.2 S	[12S]	02.82- 08.84	CA48IR	14 45	02.82- 08.84	CS66	12 0.65	
Astra D 1.3 S	[13S]	09.79- 08.84	CA128IR	14 45	09.79- 08.84	CS162	12 0.7	
		09.79- 08.84	CA99IR	14 55				
Astra D 1.6 S	[16SH]	02.82- 08.86	CA548IR#	14 55	02.82- 08.86	CS727	12 1.1	
Astra D 1.6 Diesel	[16D]	02.82- 08.86	CA264IR	14 55	03.82- 01.84	CS290	12 1.7	
					01.85- 01.89	CS322	12 1.7	



VAUXHALL Continued

Astra D 1.8 GTE	[18E]	03.83- 08.86 03.83- 08.86	CA1581R CA2641R	14 45 14 55		03.83- 08.86	CS263	12 0.8
Astra E 1.2	[12S]					09.84- 08.91 09.84- 08.91 09.84- 12.88	CS1183 CS162 CS66	12 0.9 12 0.7 12 0.65
Astra E 1.3	[13S]					09.84- 08.97 09.84- 08.87	CS1183 CS162	12 0.9 12 0.7
Astra E 1.4 i	[C14NZ]	01.90- 08.91 01.90- 08.91 PS 01.90- 08.91	CA5131R CA5141R CA5191R	14 55 14 70 14 65		01.90- 08.91 01.90- 08.91 01.90- 08.91	CS519 CS535	12 1.0 12 0.9
Astra E 1.4 S	[14NV]	01.90- 08.91 01.90- 08.91	CA5131R CA5141R	14 55 14 70		01.90- 08.91 01.90- 08.91	CS162 CS519	12 0.7 12 1.0
Astra E 1.6	[16SV]	09.84- 08.91	CA1581R	14 45		09.84- 12.91	CS162	12 0.7
Astra E 1.6 Diesel	[16DA]	09.88- 12.89	CA5161R	14 70		09.84- 12.89	CS322	12 1.7
Astra E 1.7 Diesel	[17DR]	01.89- 08.91	CA5161R	14 70		01.89- 08.91	CS290	12 1.7
Astra E 1.8 GTE	[18E]	09.84- 08.86 09.84- 08.86	CA2641R CA3521R	14 55 14 65		09.84- 08.86	CS263	12 0.8
	[18SE]	09.86- 08.91 09.86- 08.91	CA2641R CA3521R	14 55 14 65		09.86- 08.91	CS263	12 0.8
Astra E 2.0 GTE	[20SEH]	09.86- 12.88 01.88- 08.91	CA3521R CA5171R	14 65 14 70		09.86- 08.91 09.86- 08.91	CS518 CS372	12 1.0 DR 12 1.4 BO
Astra E 2.0 16V GTE	[20XE]	05.88- 08.91	CA5481R#	14 55		05.88- 08.91 05.88- 08.91	CS372 CS518	12 1.4 BO 12 1.0 DR
Astra F 1.4 i 16V	[X14XE]	02.96- 09.98	CA8611R	14 70		02.96- 09.98	CS519	12 1.0
Astra F 1.4 i	[C14NZ]	09.91- 08.95 09.91- 08.95 09.95- 09.98 09.95- 09.98 PS 09.91- 08.92 PS 09.92- 09.98	CA5131R CA5141R CA10661R CA11461R CA5191R CA8611R	14 55 14 70 14 55 14 70 14 65 14 70		09.91- 09.98 09.91- 09.93 09.91- 09.98 09.91- 09.98	CS519 CS162 CS535	12 1.0 12 0.7 12 0.9
	[C14SE]	03.91- 08.95 05.93- 03.01 09.95- 09.98 PS 03.91- 08.92 PS 09.92- 09.98	CA6471R CA8611R CA11461R CA5191R CA8611R	14 70 14 70 14 70 14 65 14 70		03.91- 03.01 03.92- 06.94 03.91- 03.01	CS519 CS162 CS535	12 1.0 12 0.7 12 0.9
	[X14XE]	01.96- 03.01 01.96- 03.01	CA13911R CA8611R	14 70 14 70		01.96- 03.01 01.96- 03.01	CS535 CS519	12 0.9 12 1.0
Astra F 1.4 S	[14NV]	09.91- 02.98 09.91- 09.93 09.91- 09.95 09.91- 09.93 09.95- 09.98 09.95- 09.98 Chas. S2500016- 09.91- 02.98 Chas. S2500016- 09.91- 02.98 Chas. -S2500015 09.91- 09.93	CA10451R CA3531R CA5141R CA991R CA10661R CA11461R CA10661R CA11461R CA991R	14 120 14 65 14 70 14 55 14 55 14 70 14 55 14 70 14 55		09.91- 02.98 09.91- 02.95 09.91- 02.98	CS535 CS162 CS519	12 0.9 12 0.7 12 1.0
Astra F 1.6 i 16V	[X16XEL]	01.94- 02.98 01.94- 02.98 01.94- 02.98	CA10451R CA10701R CA8611R	14 120 14 120 14 70		01.94- 02.98 01.94- 02.98	CS162 CS1183	12 0.7 12 0.9
Astra F 1.6 i	[C16NZ]	09.91- 08.95 09.95- 02.98 PS 09.91- 08.92 PS 09.92- 02.98	CA5141R CA11461R CA5191R CA8611R	14 70 14 70 14 65 14 70		09.91- 09.98 09.91- 02.98 03.92- 09.98	CS162 CS519 CS535	12 0.7 12 1.0 12 0.9
	[C16SE]	03.92- 02.98 03.92- 02.98 03.92- 08.92 03.92- 08.95 09.95- 02.98 09.95- 02.98 PS 03.92- 08.92 PS 09.92- 12.94	CA10451R CA10531R CA3531R CA5141R CA11461R CA8611R CA5191R CA8611R	14 120 14 100 14 65 14 70 14 70 14 70 14 65 14 70		03.92- 02.98 03.92- 02.98 03.92- 02.98	CS162 CS535 CS519	12 0.7 12 0.9 12 1.0
	[E16NZ]	09.91- 08.95 09.95- 02.98 PS 09.91- 08.92 PS 09.92- 02.98	CA5141R CA11461R CA5191R CA8611R	14 70 14 70 14 65 14 70		09.91- 04.94 09.91- 02.98	CS162 CS519	12 0.7 12 1.0
	[X16SZ]	03.93- 08.95 07.94- 02.98 07.94- 02.98 09.95- 02.98 PS 03.93- 02.98	CA6471R CA10451R CA10531R CA11461R CA8611R	14 70 14 120 14 100 14 70 14 70		07.94- 02.98 07.94- 02.98 07.94- 02.98	CS519 CS1183 CS162	12 1.0 12 0.9 12 0.7
	[X16SZR]	03.92- 08.95 09.95- 08.97 09.95- 08.97 PS 09.95- 08.97 PS 09.95- 08.97 Chas. S2500016-, 09.95- 09.97 S5000001-, S8000001-	CA5141R CA10451R CA10531R CA5191R CA8611R CA11461R	14 70 14 120 14 100 14 65 14 70 14 70		09.95- 08.97 03.92- 08.97 03.92- 08.97	CS1257 CS535 CS519	12 1.1 12 0.9 12 1.0
Astra F 1.6 i Eco	[X16SZ]	08.94- 08.95 09.95- 07.96 PS 08.94- 07.96	CA6471R CA11461R CA8611R	14 70 14 70 14 70		07.94- 02.98	CS162	12 0.7
Astra F 1.7 Diesel	[17D]	12.91- 02.98	CA5161R	14 70		Eng. -14292839 12.91- 02.98 Eng. 14292840- 12.91- 02.98	CS290 CS322 CS322	12 1.7 12 1.7 12 1.7
	[17DR]	07.92- 09.98	CA5161R	14 70		07.92- 09.98 07.92- 09.98	CS322 CS290	12 1.7 12 1.7
Astra F 1.7 TD	[17DT (TC4EE1)]	, T5., T6., T8000001 12.91- 02.98 Chas. -S2., S5., S6., S8999999 12.91- 02.98	JA11721R JA8631R	14 70 14 70		Chas. 997453- 12.91- 02.98 Chas. -750406 12.91- 02.98	JS1091 JS753	12 1.2 12 1.4
	[X17DTL]	11.94- 09.98	CA5161R	14 70		11.94- 09.98	CS322	12 1.7
Astra F 1.8 16V	[C18XEL]	11.94- 03.01 11.94- 03.01	CA10531R CA8611R	14 100 14 70		11.94- 03.01	CS879	12 1.1
	[X18XE]	03.96- 03.01 03.96- 03.01	CA10531R CA8611R	14 100 14 70		03.96- 03.01	CS879	12 1.1
Astra F 1.8 i 16V	[C18XE]	09.94- 02.98 09.94- 02.98 09.94- 02.98	CA10451R CA10531R CA8611R	14 120 14 100 14 70		09.94- 02.98	CS879	12 1.1
	[C18XEL]	09.94- 02.98 09.94- 02.98 09.94- 02.98	CA10451R CA10531R CA8611R	14 120 14 100 14 70		09.94- 02.98	CS879	12 1.1
Astra F 1.8 i	[C18NZ]	09.91- 09.98 09.91- 08.92 09.91- 09.98	CA10531R CA5171R CA8611R	14 100 14 70 14 70		09.91- 09.98	CS727	12 1.1



Astra F 2.0 i 16V	[C20XE]	09.91- 02.98	CA1045IR	14 120	Eng. 14154711- 09.91- 02.98	CS727	12 1.1	
		09.91- 02.98	CA1053IR	14 100	Eng. -14154710 09.91- 02.98	CS372	12 1.4	
		09.91- 02.98	CA8611R	14 70				
	[X20XE]	02.95- 09.98	CA1053IR	14 100		02.95- 09.98	CS879	12 1.1
		02.95- 09.98	CA8611R	14 70				
Astra F 2.0 i	[C20NE]	09.91- 02.98	CA1045IR	14 120	Eng. -14608701 09.91- 12.94	CS372	12 1.4	
		09.91- 08.92	CA5171R	14 70	Eng. 14608702- 09.91- 09.98	CS727	12 1.1	
		03.92- 09.98	CA1053IR	14 100				
		03.92- 09.98	CA8611R	14 70				
Astra G 1.2 16V	[X12XE]	09.97- 09.00	CA1257IR	14 70		09.97- 09.00	CS519	12 1.0
		09.98- 09.00	CA1561IR	14 100		09.97- 09.00	CS1257	12 1.1
Astra G 1.4 16V	[X14XE]	09.97- 08.00	CA1391IR	14 70		09.97- 08.00	CS519	12 1.0
		09.97- 08.00	CA1581IR	14 100				
		Chas. 12257453-, 15257664-, 18131575- 09.97- 08.00	CA1821IR	14 120				
	Chas. -12257452, -15257663, -18131574 09.97- 08.00	CA1765IR	14 120					
	[Z14XE]	09.00- 08.05	CA1391IR	14 70		09.00- 08.05	CS519	12 1.0
		09.00- 08.05	CA1581IR	14 100				
		Chas. 12257453-, 15257664-, 18131575- 09.00- 08.05	CA1821IR	14 120				
		Chas. -12257452, -15257663, -18131574 09.00- 08.05	CA1765IR	14 120				
Astra G 1.6	[X16SZR]	09.97- 08.05	CA1391IR	14 70		09.97- 08.05	CS519	12 1.0
		09.97- 08.05	CA1581IR	14 100		09.97- 08.05	CS1257	12 1.1
		Chas. 12257453-, 15257664-, 18131575- 09.97- 08.05	CA1821IR	14 120				
		Chas. -12257452, -15257663, -18131574 09.97- 08.05	CA1765IR	14 120				
Astra G 1.6 16V	[X16XEL]	09.97- 08.00	CA1391IR	14 70		09.97- 08.00	CS519	12 1.0
		09.97- 08.00	CA1581IR	14 100				
		Chas. 12257453-, 15257664-, 18131575- 09.97- 08.00	CA1821IR	14 120				
	Chas. -12257452, -15257663, -18131574 09.97- 08.00	CA1765IR	14 120					
	[Z16XE]	09.00- 08.05	CA1391IR	14 70		09.00- 08.05	CS519	12 1.0
		09.00- 08.05	CA1581IR	14 100				
		Chas. 12257453-, 15257664-, 18131575- 09.00- 08.05	CA1821IR	14 120				
		Chas. -12257452, -15257663, -18131574 09.00- 08.05	CA1765IR	14 120				
Astra G 1.7 TD	[X17DTL]	02.98- 08.00	CA1440IR	14 70		02.98- 08.00	CS322	12 1.7
		02.98- 08.00	CA1473IR	14 100				
Astra G 1.8 16V	[X18XE1]	09.97- 09.00	CA1391IR	14 70	Chas. 6G000001- 09.97- 10.00	CS1257	12 1.1	
		09.97- 09.00	CA1581IR	14 100		09.97- 09.00	CS1188	12 1.1
		Chas. 12257453-, 15257664-, 18131575- 09.97- 09.00	CA1821IR	14 120				
		Chas. -12257452, -15257663, -18131574 09.97- 09.00	CA1765IR	14 120				
Astra G 2.0 16V	[X20XE]	09.97- 08.05	CA1391IR	14 70		09.97- 08.05	CS879	12 1.1
		09.97- 08.05	CA1581IR	14 100				
		09.97- 08.05	CA1765IR	14 120				
		09.97- 08.05	CA1821IR	14 120				
Astra G 2.0 Diesel	[X20DTL]	02.98- 08.00	CA1490IR	14 70		02.98- 08.00	CS976	12 2.0
		02.98- 08.00	CA1501IR	14 100				
	[Y20DTL]	09.00- 08.05	CA1490IR	14 70		09.00- 08.05	CS976	12 2.0
			09.00- 08.05	CA1501IR	14 100			
		09.00- 08.05	CA1577IR	14 120				
		A19 09.00- 08.05	CA1582IR	14 120				
Astra Mk II 1.3	[13S]					09.84- 08.91	CS162	12 0.7
						09.84- 08.91	CS519	12 1.0
	[C13N]	09.85- 08.91	CA128IR	14 45		09.85- 08.91	CS162	12 0.7
		09.85- 08.91	CA353IR	14 65				
		09.85- 08.91	CA513IR	14 55				
		09.85- 08.91	CA514IR	14 70				
		09.85- 08.91	CA99IR	14 55				
Astra MK II 1.6 i	[16SV]					09.84- 12.91	CS162	12 0.7
	[C16LZ]	10.87- 02.93	CA353IR	14 65		10.87- 02.93	CS1183	12 0.9 DR
		10.87- 02.93	CA514IR	14 70		10.87- 02.93	CS162	12 0.7 BO
	[C16NZ]	10.87- 02.93	CA353IR	14 65		10.87- 02.93	CS1183	12 0.9 DR
		10.87- 02.93	CA514IR	14 70		10.87- 02.93	CS162	12 0.7 BO
	[E16NZ]	01.91- 08.93	CA514IR	14 70	Eng. 082382-, 085881	09.87- 12.91	CS535	12 0.9
		01.91- 08.93	CA647IR	14 70		09.87- 12.91	CS162	12 0.7
		PS 01.91- 08.92	CA519IR	14 65				
Astra MK II 1.6 S	[16SH]					09.84- 08.86	CS263	12 0.8
Astra MK II 1.7 Diesel	[17D]	02.89- 08.91	CA516IR	14 70		02.89- 08.91	CS322	12 1.7
						02.89- 08.91	CS290	12 1.7
Astra MK II 1.8	[C18NE]				AT 10.85- 08.86	CS263	12 0.8	
Astra MK II 1.8 i	[18E]	01.90- 08.91	CA158IR	14 45		09.84- 08.91	CS263	12 0.8
		01.90- 08.91	CA264IR	14 55				
		01.90- 08.91	CA548IR#	14 55				
Astra MK II 2.0 i	[20NE]	01.87- 12.91	CA264IR	14 55		01.87- 12.91	CS727	12 1.1
		01.87- 12.91	CA514IR	14 70		01.87- 12.91	CS372	12 1.4
		01.87- 12.91	CA515IR	14 90				
		01.87- 12.91	CA517IR	14 70				
	[C20NE]	01.91- 08.92	CA517IR	14 70		01.91- 08.93	CS372	12 1.4
		09.92- 08.93	CA1053IR	14 100		01.91- 08.93	CS727	12 1.1
		09.92- 08.93	CA8611R	14 70				
Astra MK III 1.4	[14NV]	09.91- 09.93	CA1045IR	14 120				
		09.91- 09.93	CA1053IR	14 100				
		09.91- 09.93	CA1066IR	14 55				
		09.91- 09.93	CA1146IR	14 70				
		09.91- 09.93	CA513IR	14 55				
		09.91- 09.93	CA514IR	14 70				
		09.91- 09.93	CA514IR	14 70				
	[C14NZ]	09.91- 02.98	CA1045IR	14 120		09.91- 02.98	CS162	12 0.7
			09.91- 02.98	CA1053IR	14 100			
			09.91- 02.98	CA1066IR	14 55			
			09.91- 02.98	CA1146IR	14 70			
			09.91- 02.98	CA513IR	14 55			
			09.91- 02.98	CA514IR	14 70			
			09.91- 02.98	CA519IR	14 65			
		09.91- 02.98	CA8611R	14 70				
Astra MK III 1.4 i 16V	[X14XE]	02.96- 02.98	CA8611R	14 70		02.96- 01.98	CS1257	12 1.1
						02.96- 01.98	CS162	12 0.7
						02.96- 02.98	CS519	12 1.0
Astra MK III 1.6	[C16SE]	03.94- 08.95	CA1045IR	14 120		03.94- 08.95	CS519	12 1.0
		03.94- 08.95	CA1053IR	14 100				
		03.94- 08.95	CA8611R	14 70				
	[X16XEL]	03.94- 08.95	CA1045IR	14 120		03.94- 08.95	CS519	12 1.0
		03.94- 08.95	CA1053IR	14 100				
		03.94- 08.95	CA8611R	14 70				
Astra MK III 1.6 i 16V	[X16XEL]	01.94- 02.98	CA8611R	14 70		01.94- 02.98	CS519	12 1.0



**VAUXHALL** *Continued*

Astra MK III 1.6 Si	[C16SE]	03.91- 08.95	<b>CA353IR</b>	14 65	03.91- 02.98	<b>CS162</b>	12 0.7
		09.95- 12.98	<b>CA1146IR</b>	14 70	03.91- 02.98	<b>CS535</b>	12 0.9
		PS 03.91- 08.92	<b>CA519IR</b>	14 65			
		PS 09.92- 12.98	<b>CA861IR</b>	14 70			
Astra MK III 1.7 Diesel	[17DR]	03.91- 12.94	<b>CA516IR</b>	14 70	03.91- 12.94	<b>CS290</b>	12 1.7
					03.91- 12.94	<b>CS322</b>	12 1.7
Astra MK III 1.7 TD	[17DT (TC4EE1)]	09.88- 02.98	<b>JA863IR</b>	14 70	09.88- 02.98	<b>JS753</b>	12 1.4
	[X17DTL]	01.94- 02.98	<b>CA516IR</b>	14 70	01.94- 02.98	<b>CS322</b>	12 1.7
Astra MK III 1.8	[C18NZ]	09.91- 02.98	<b>CA1045IR</b>	14 120	09.91- 02.98	<b>CS727</b>	12 1.1
		09.91- 02.98	<b>CA1053IR</b>	14 100			
		09.91- 02.98	<b>CA517IR</b>	14 70			
		09.91- 02.98	<b>CA861IR</b>	14 70			
	[C18XE]	09.94- 08.96	<b>CA1045IR</b>	14 120	09.94- 08.96	<b>CS879</b>	12 1.1
		09.94- 08.96	<b>CA1053IR</b>	14 100			
		09.94- 08.96	<b>CA861IR</b>	14 70			
Astra MK III 1.8 16V	[18SE]	09.95- 02.98	<b>CA1045IR</b>	14 120	09.95- 02.98	<b>CS879</b>	12 1.1
		09.95- 02.98	<b>CA1053IR</b>	14 100			
		09.95- 02.98	<b>CA861IR</b>	14 70			
Astra MK III 1.8 i 16V	[C18XEL]	09.94- 12.96	<b>CA1053IR</b>	14 100	09.94- 12.96	<b>CS879</b>	12 1.1
		09.94- 12.96	<b>CA861IR</b>	14 70			
Astra MK III 2.0 16V	[X20XEV]	01.94- 02.98	<b>CA1045IR</b>	14 120	01.94- 02.98	<b>CS879</b>	12 1.1
		01.94- 02.98	<b>CA1053IR</b>	14 100			
		01.94- 02.98	<b>CA861IR</b>	14 70			
Astra MK III 2.0 i 16V	[X20XEV]	01.94- 02.98	<b>CA1053IR</b>	14 100	01.94- 02.98	<b>CS879</b>	12 1.1
		01.94- 02.98	<b>CA861IR</b>	14 70			
Astra MK III 2.0 DTi 16V	[X20DTH]	08.99- 08.05	<b>CA1490IR</b>	14 70	08.99- 08.05	<b>CS976</b>	12 2.0
		08.99- 08.05	<b>CA1501IR</b>	14 100			
Astra MK IV 1.2 16V	[Z12XE]	09.00- 08.05	<b>CA1257IR</b>	14 70	Chas. -22999999, -09.00- 08.05	<b>CS519</b>	12 1.0
					25999999, -26999999, -28999999, -2B999999		
		09.00- 08.05	<b>CA1561IR</b>	14 100	Chas. -22999999, -09.00- 08.05	<b>CS1257</b>	12 1.1
					25999999, -26999999, -28999999, -2B999999		
		Chas. 12000001-, 09.00- 08.05	<b>CA1658IR</b>	14 120			
		15000001-, 16000001-, 18000001-					
		Chas. 12000001-, 09.00- 08.05	<b>CA1747IR</b>	14 70			
		15000001-, 16000001-, 18000001-					
		Chas. 12000001-, 09.00- 08.05	<b>CA1748IR</b>	14 100			
		15000001-, 16000001-, 18000001-					
Astra MK IV 1.6	[Z16SE]	09.00- 08.05	<b>CA1391IR</b>	14 70	Chas. -22999999, -09.00- 08.05	<b>CS1257</b>	12 1.1
					25999999, -26999999, -28999999, 2B999999		
		09.00- 08.05	<b>CA1581IR</b>	14 100	Chas. -22999999, -09.00- 08.05	<b>CS519</b>	12 1.0
					25999999, -26999999, -28999999, 2B999999		
		09.00- 08.05	<b>CA1765IR</b>	14 120			
		Chas. 12257453-, 15257664-, 18131575-09.00- 08.05	<b>CA1821IR</b>	14 120			
		Chas. -12257452, -15257663, -18131574	<b>CA1765IR</b>	14 120			
	[Z16XEP]	12.02- 07.09	<b>CA1833IR</b>	14 120	12.02- 07.09	<b>CS1257</b>	12 1.1
		12.02- 07.09	<b>CA1882IR</b>	14 100			
		12.02- 07.09	<b>CA1960IR</b>	14 120			
Astra MK IV 1.6 16V	[Z16XE]	09.00- 09.00-	<b>CA1391IR</b>	14 70	09.00-	<b>CS519</b>	12 1.0
		09.00-	<b>CA1581IR</b>	14 100			
		Chas. 12257453-, 15257664-, 18131575-09.00-	<b>CA1821IR</b>	14 120			
		Chas. -12257452, -15257663, -18131574	<b>CA1765IR</b>	14 120			
	[Z16XEP]	03.00- 10.05	<b>CA1833IR</b>	14 120	03.00- 08.05	<b>CS1257</b>	12 1.1
		03.03- 10.05	<b>CA1257IR</b>	14 70	03.00- 10.05	<b>CS519</b>	12 1.0
Astra MK IV 1.6 Dualfuel	[Z16XE]	09.02- 08.05	<b>CA1391IR</b>	14 70	09.02- 08.05	<b>CS1257</b>	12 1.1
		09.02- 08.05	<b>CA1821IR</b>	14 120			
		Chas. -32240322, -35216264, -38100964	<b>CA1581IR</b>	14 100			
Astra MK IV 1.7 CDTi 16V	[Z17DTL]	04.03- 08.05	<b>JA1521IR</b>	14 100	04.03- 08.05	<b>JS1158</b>	12 1.4
Astra MK IV 1.7 DTi 16V	[Y17DT]	02.00- 03.05	<b>JA1521IR</b>	14 100	02.00- 03.05	<b>JS1158</b>	12 1.4
		02.00- 03.05	<b>JA1526IR</b>	14 70			
		AC 02.00- 03.05	<b>JA1521IR</b>	14 100			
Astra MK IV 1.8 16V	[Z18XE]	09.00- 08.05	<b>CA1391IR</b>	14 70	Chas. 6G000001- 09.00- 08.05	<b>CS1257</b>	12 1.1
		09.00- 08.05	<b>CA1581IR</b>	14 100	Chas. -2B999999, -09.00- 08.05	<b>CS1188</b>	12 1.1
					2H999999, 12000001- 22999999, 15000001- 25999999, 16000001- 26999999		
Astra MK IV 1.8 Dualfuel 16V	[Z18XE]	09.02- 08.05	<b>CA1391IR</b>	14 70	09.02- 08.05	<b>CS1257</b>	12 1.1
		09.02- 08.05	<b>CA1581IR</b>	14 100			
		09.02- 08.05	<b>CA1765IR</b>	14 120			
		09.02- 08.05	<b>CA1581IR</b>	14 100			
		Chas. -32240322, -35216264, -38100964	<b>CA1581IR</b>	14 100			
		Chas. 12257453-, 15257664-, 18131575-09.02- 08.05	<b>CA1821IR</b>	14 120			
		Chas. -12257452, -15257663, -18131574	<b>CA1765IR</b>	14 120			
Astra Mk IV 2.0	[Z20LET]	08.02- 07.06	<b>CA1581IR</b>	14 100	08.02- 07.06	<b>CS879</b>	12 1.1
Astra MK IV 2.0 16V	[X20XER]	10.99- 05.05	<b>CA1391IR</b>	14 70	10.99- 05.05	<b>CS879</b>	12 1.1
		10.99- 05.05	<b>CA1581IR</b>	14 100			
		10.99- 05.05	<b>CA1765IR</b>	14 120			
		10.99- 05.05	<b>CA1821IR</b>	14 120			
		A42 10.99- 05.05	<b>CA1765IR</b>	14 120			
Astra MK IV 2.0 Turbo 16V	[Z20LET]	03.00- 08.05	<b>CA1581IR</b>	14 100	03.00- 08.05	<b>CS879</b>	12 1.1
		09.00- 08.05	<b>CA1821IR</b>	14 120			
Astra MK IV 2.0 DTi 16V	[X20DTH]	08.99- 08.05	<b>CA1490IR</b>	14 70	08.99- 08.05	<b>CS976</b>	12 2.0
		08.99- 08.05	<b>CA1501IR</b>	14 100			
	[Y20DTH]	09.00- 08.05	<b>CA1490IR</b>	14 70	09.00- 08.05	<b>CS976</b>	12 2.0
		09.00- 08.05	<b>CA1501IR</b>	14 100			
		09.00- 08.05	<b>CA1577IR</b>	14 120			
		A19 09.00- 08.05	<b>CA1582IR</b>	14 120			
Astra Mk IV 2.2	[Z22SE]	03.00- 03.00-	<b>CA1592IR</b>	14 100	Chas. 1B023572- 03.00-	<b>CS1395</b>	12 1.4
		03.00-	<b>CA1740IR</b>	14 120	Chas. -1B023571 03.00-	<b>CS1291</b>	12 1.8
Astra MK IV 2.2 16V	[Z22SE]	03.01-	<b>CA1740IR</b>	14 120	Chas. 1B007895- 03.01-	<b>CS1395</b>	12 1.4
					Chas. -1B007894 03.01-	<b>CS1291</b>	12 1.8
					Chas. -22012028, -03.01-	<b>CS1291</b>	12 1.8
					25005804, -28038498, -1H031120		
Astra MK IV 2.2 DTi	[Y22DTR]	09.02- 05.05	<b>CA1577IR</b>	14 120	09.02- 05.05	<b>CS976</b>	12 2.0



Astra MK V 1.3 CDTi	[Z13DTH]	08.05-	CA1862IR	14 90	08.05-	CS1334	12 1.1
		08.05-	CA1934IR	14 105			
		08.05-	CA1935IR	14 120			
		10.05-	CA1855IR	14 75			
Astra MK V 1.3 CDTi Sport	[Z13DTH]	04.05-	CA1855IR	14 75	04.05-	CS1334	12 1.1
		04.05-	CA1862IR	14 90			
		04.05-	CA1934IR	14 105			
		04.05-	CA1935IR	14 120			
Astra MK V 1.4	[Z14XEL]	04.04-12.05	CA1747IR	14 70	04.04-12.05	CS519	12 1.0
		04.04-12.05	CA1748IR	14 100			
		04.04-12.05	CA1940IR	14 100			
	[Z14XEP]	02.05-	CA1658IR	14 120	08.04-	CS519	12 1.0
		02.05-	CA1934IR	14 105			
		03.04-08.04	CA1747IR	14 70			
Astra MK V 1.4 16V	[Z14XEP]	03.05-	CA1658IR	14 120	03.05-	CS519	12 1.0
		03.05-	CA1747IR	14 70			
		03.05-	CA1748IR	14 100			
		03.05-	CA1934IR	14 105			
Astra MK V 1.6	[Z16XEP]	03.04-	CA1833IR	14 120	03.04-	CS1257	12 1.1
		03.04-	CA1882IR	14 100			
[Z16XER]	10.06-	CA1833IR	14 120	10.06-	CS1438	12 1.1	
	10.06-	CA1960IR	14 120				
Astra MK V 1.6 CC	[Z16XER]	10.06-	CA1833IR	14 120	10.06-	CS1438	12 1.1
		10.06-	CA1960IR	14 120			
Astra MK V 1.6 16V	[Z16XER]	12.06-	CA1833IR	14 120	12.06-	CS1438	12 1.1
		12.06-	CA1960IR	14 120			
Astra MK V 1.7 CDTi 16V Sport Hatc	[A17DTR]				02.07-	JS1158	12 1.4
Astra MK V 1.7 CDTi	[A17DTR]	02.07-	CA2010IR	14 100	02.07-	JS1158	12 1.4
		02.07-	CA2017IR	14 140			
		AC 02.07-	CA2017IR	14 140			
	[Z17DT]	02.07-	CA2010IR	14 100	02.07-	JS1158	12 1.4
		02.07-	CA2017IR	14 140			
	AC 02.07-	02.07-	CA2017IR	14 140			
		02.07-	CA2017IR	14 140			
	[Z17DTH]	03.04-03.07	JA1899IR	14 100	03.04-03.07	JS1158	12 1.4
		08.04-03.07	JA1900IR	14 110			
		AC 03.04-03.07	JA1900IR	14 110			
AC 08.04-03.07	03.04-03.07	JA1899IR	14 100				
	03.04-03.07	JA1900IR	14 110				
[Z17DTL]	03.04-03.07	JA1899IR	14 100	03.04-03.07	JS1158	12 1.4	
	03.04-03.07	JA1900IR	14 110				
[Z17DTR]	02.07-	CA2010IR	14 100	02.07-	JS1158	12 1.4	
	02.07-	CA2017IR	14 140				
	AC 02.07-	CA2017IR	14 140				
Astra MK V 1.7 TD		09.08-	CA2010IR	14 100	09.08-	JS1158	12 1.4
		AC 09.08-	CA2017IR	14 140			
Astra MK V 1.8	[Z18XE]	08.04-	CA1581IR	14 100	03.04-	CS1257	12 1.1
		08.04-	CA1765IR	14 120			
[Z18XER]	03.07-	CA1833IR	14 120	03.07-	CS1438	12 1.1	
	03.07-	CA1960IR	14 120				
Astra MK V 1.8 CC	[Z18XER]	04.06-	CA1833IR	14 120	04.06-	CS1438	12 1.1
		04.06-	CA1960IR	14 120			
Astra MK V 1.9 CDTi 16V	[Z19DTJ]	Chas. 72172469-, 04.04-75189053-, 78104401-, 8B000001-	CA1994IR	14 140	04.04-	CS1428	12 1.7
		Chas. 72172469-, 04.04-75189053-, 78104401-, 8B000001-	CA2045IR	14 120			
		Chas. -72172468, -75189052, -78104400 04.04-	CA1884IR	14 105			
		Chas. -72172468, -75189052, -78104400 04.04-	CA1885IR	14 120			
		Chas. -72172468, -75189052, -78104400 04.04-	CA1890IR	14 130			
		Chas. 72172469-, 02.05-75189053-, 78104401-, 8B000001-	CA1994IR	14 140			
		Chas. 72172469-, 02.05-75189053-, 78104401-, 8B000001-	CA2045IR	14 120			
		Chas. -72172468, -75189052, -78104400 02.05-	CA1884IR	14 105			
		Chas. -72172468, -75189052, -78104400 02.05-	CA1885IR	14 120			
		Chas. -72172468, -75189052, -78104400 02.05-	CA1890IR	14 130			
[Z19DTH]	Chas. 72172469-, 06.04-75189053-, 78104401-, 8B000001-	CA1994IR	14 140	AT 06.04-	CS1264	12 1.7	
	Chas. 72172469-, 06.04-75189053-, 78104401-, 8B000001-	CA2045IR	14 120				
	Chas. -72172468, -75189052, -78104400 06.04-	CA1884IR	14 105				
Chas. -72172468, -75189052, -78104400 06.04-	06.04-	CA1885IR	14 120	06.04-	CS1428	12 1.7	
	06.04-	CA1890IR	14 130				
	06.04-	CA1994IR	14 140				
[Z19DTL]	Chas. 72172469-, 08.05-75189053-, 78104401-, 8B000001-	CA1994IR	14 140	08.05-	CS1264	12 1.7	
	Chas. 72172469-, 08.05-75189053-, 78104401-, 8B000001-	CA2045IR	14 120				
	Chas. -72172468, -75189052, -78104400 08.05-	CA1884IR	14 105				
	Chas. -72172468, -75189052, -78104400 08.05-	CA1885IR	14 120				
Chas. -72172468, -75189052, -78104400 08.05-	CA1890IR	14 130					
Astra MK V 2.0 Turbo	[Z20LEH]	03.05-	CA1909IR	14 120	03.05-	CS879	12 1.1
		03.04-	CA1909IR	14 120			
		03.04-	CA1909IR	14 120			
[Z20LER]	03.04-	CA1909IR	14 120	03.04-	CS879	12 1.1	
	03.04-	CA1909IR	14 120				
	03.04-	CA1909IR	14 120				
Astra MK V 2.0 CDTi	[A20DTH]	08.11-	CA2005IR	14 100			
Astra MK V 2.0 CDTi Sports Tourer	[A20DTH]	08.11-	CA2005IR	14 100			
Astra MK VI 1.6 16V Turbo	[A16LET]				12.09-	CS1438	12 1.1
Astra MK VI 1.6 16V VVT	[A16XER]				12.09-	CS1438	12 1.1
Astra MK VI 1.6 16V	[A16XER]				10.10-	CS1438	12 1.1
Astra MK VI 1.7 CDTi 16V	[A17DTJ]				10.10-	JS1158	12 1.4
	[A17DTR]				10.10-	JS1158	12 1.4
Astra MK VI 1.7 CDTi	[A17DTJ]				12.09-	JS1158	12 1.4
					12.09-	JS1158	12 1.4

**VAUXHALL Continued**

Astra MK VI 2.0 CDTi 16V	[A20DTH]	10.10-	CA2005IR	14 100	10.10-	CS1428	12 1.7
Astra MK VI 2.0 CDTi	[A20DTH]	12.09-	CA2005IR	14 100	12.09-	CS1428	12 1.7
					AT 12.09-	CS1264	12 1.7
Astramax 1.3	[13NB,13N]	08.85- 12.89	CA353IR	14 65	08.85- 12.89	CS1183	12 0.9
		08.85- 12.89	CA513IR	14 55	08.85- 12.89	CS162	12 0.7
		08.85- 12.89	CA514IR	14 70			
		08.85- 12.89	CA570IR	14 70			
	[13S]				08.85- 12.89	CS162	12 0.7
Astramax 1.4	[14NV]	07.89- 08.91	CA513IR	14 55	07.89- 08.91	CS162	12 0.7
		07.89- 08.91	CA514IR	14 70			
	[C14NZ]	08.91- 07.94	CA513IR	14 55	08.91- 07.94	CS162	12 0.7
		08.91- 07.94	CA514IR	14 70	08.91- 07.94	CS535	12 0.9
Astramax 1.6	[16SV]	09.85- 12.91	CA353IR	14 65	09.85- 12.91	CS162	12 0.7
		09.85- 12.91	CA48IR	14 45	09.85- 12.91	CS519	12 1.0
		09.85- 12.91	CA517IR	14 70	09.85- 12.91	CS535	12 0.9
	[C16NZ]				08.91- 10.94	CS1183	12 0.9
Astramax 1.6 Diesel	[16DA]				05.86- 06.90	CS290	12 1.7
Astramax 1.7 Diesel	[17D]	01.89- 07.94	CA516IR	14 70	01.89- 07.94	CS290	12 1.7
Astravan 1.3 CDTi	[Z13DTH]	08.05-	CA1855IR	14 75	08.05-	CS1334	12 1.1
		08.05-	CA1862IR	14 90			
		08.05-	CA1934IR	14 105			
		08.05-	CA1935IR	14 120			
Astravan 1.4 16V	[Z14XEP]	03.05-	CA1658IR	14 120	03.05-	CS519	12 1.0
		03.05-	CA1747IR	14 70			
		03.05-	CA1748IR	14 100			
		03.05-	CA1940IR	14 100			
Astravan 1.9 CDTi	[Z19DTH]	Chas. 72172469-, 03.05- 75189053-, 78104401-, 8B000001-	CA1994IR	14 140	03.05-	CS1428	12 1.7
		Chas. 72172469-, 03.05- 75189053-, 78104401-, 8B000001-	CA2045IR	14 120			
		Chas. -72172468, -75189052, -78104400 03.05- Chas. -72172468, -75189052, -78104400 03.05-	CA1884IR	14 105			
			CA1890IR	14 130			
	[Z19DTJ]	Chas. 72172469-, 03.05- 75189053-, 78104401-, 8B000001-	CA1994IR	14 140	03.05-	CS1428	12 1.7
		Chas. 72172469-, 03.05- 75189053-, 78104401-, 8B000001-	CA2045IR	14 120			
		Chas. -72172468, -75189052, -78104400 03.05- Chas. -72172468, -75189052, -78104400 03.05-	CA1884IR	14 105			
			CA1890IR	14 130			
Astravan III 1.4 i	[C14NZ]	01.91- 10.94	CA513IR	14 55	09.90- 02.98	CS162	12 0.7
		01.91- 10.94	CA514IR	14 70	09.91- 02.98	CS535	12 0.9
		PS 01.91- 08.92	CA519IR	14 65			
		PS 01.91- 10.94	CA861IR	14 70			
Astravan III 1.6 i	[C16NZ]	01.91- 08.95	CA514IR	14 70	09.91- 02.98	CS162	12 0.7
		09.95- 08.98	CA1146IR	14 70	09.91- 02.98	CS535	12 0.9
		PS 01.91- 08.92	CA519IR	14 65			
		PS 09.95- 08.98	CA861IR	14 70			
	[X16SZ]	02.94- 08.95	CA647IR	14 70	07.94- 02.98	CS162	12 0.7
		09.95- 10.96	CA1146IR	14 70			
		PS 02.94- 10.96	CA861IR	14 70			
Astravan III 1.7 Diesel	[17DR]	01.91- 08.94	CA516IR	14 70	01.91- 08.94	CS322	12 1.7
Astravan III 1.7 TD	[X17DTL]	01.94- 08.98	CA516IR	14 70	01.94- 08.98	CS322	12 1.7
Astravan MK IV 1.6 i	[X16SZR]	08.98- 09.00	CA1391IR	14 70	08.98- 09.00	CS519	12 1.0
		08.98- 09.00	CA1581IR	14 100			
		Chas. 12257453-, 15257664-, 18131575- 08.98- 09.00	CA1821IR	14 120			
		Chas. -12257452, -15257663, -18131574 08.98- 09.00	CA1765IR	14 120			
	[Z16SE]	09.00-	CA1391IR	14 70	Chas. -229.., -259.., - 09.00- 269.., -289.., -2B9.., - 2H999999	CS519	12 1.0
		09.00-	CA1581IR	14 100			
		Chas. 12257453-, 15257664-, 18131575- 09.00-	CA1821IR	14 120			
		Chas. -12257452, -15257663, -18131574 09.00-	CA1765IR	14 120			
Astravan MK IV 1.7 CDTi	[Z17DTL]	04.04-	JA1899IR	14 100	04.04-	JS1158	12 1.4
		AC 04.04-	JA1900IR	14 110			
Astravan MK IV 1.7 DTi	[Y17DT]	04.01-	JA1526IR	14 70	04.01-	JS1158	12 1.4
		AC 04.01-	JA1521IR	14 100			
Astravan MK IV 1.7 TD	[X17DTL]	08.98- 08.00	CA1440IR	14 70	08.98- 08.00	CS322	12 1.7
		08.98- 08.00	CA1473IR	14 100			
Astravan MK IV 2.0 Diesel Di	[X20DTL]	08.98-	CA1490IR	14 70	08.98-	CS976	12 2.0
		08.98-	CA1501IR	14 100			
Astravan MK IV 2.0 DTi	[Y20DTH]	04.04-	CA1490IR	14 70	Eng. 17883781- 04.04-	CS976	12 2.0
		04.04-	CA1501IR	14 100			
		A19 04.04-	CA1582IR	14 120			
Astravan Mk V 1.6	[Z16XEP]	03.05-	CA1833IR	14 120	03.05-	CS1257	12 1.1
		03.05-	CA1882IR	14 100			
		03.05-	CA1960IR	14 120			
Astravan Mk V 1.7 CDTi 16V	[Z17DTH]	03.05-	JA1899IR	14 100	03.05-	JS1158	12 1.4
		03.05-	JA1900IR	14 110			
Astravan Mk V 1.7 CDTi	[Z17DTL]	03.05- 07.06	JA1899IR	14 100	03.05- 07.06	JS1158	12 1.4
		AC 03.05- 07.06	JA1900IR	14 110			
Belmont 1.3	[13S]	09.85- 08.88	CA128IR	14 45	09.85- 08.91	CS162	12 0.7
		09.85- 08.88	CA99IR	14 55			
		09.88- 08.91	CA513IR	14 55			
		09.88- 08.91	CA514IR	14 70			
Belmont 1.4 i	[C14NZ]				09.90- 12.91	CS162	12 0.7
Belmont 1.5 DT	[15DT]				01.87- 08.89	JS941	12 1.4
Belmont 1.6	[16SH]	09.85- 08.91	CA158IR	14 45	01.88- 09.93	CS535	12 0.9
		09.85- 08.91	CA264IR	14 55	09.85- 01.88	CS263	12 0.8
					01.88- 09.93	CS519	12 1.0
Belmont 1.6 Diesel	[16DA]				09.85-	CS322	12 1.7
Belmont 1.7 Diesel	[17D]				09.85- 09.91	CS322	12 1.7
Belmont 1.8	[18SE]	01.86- 12.90	CA158IR	14 45	AT 09.86- 09.93	CS263	12 0.8
		01.86- 12.90	CA548IR#	14 55	09.86- 09.93	CS727	12 1.1
Belmont 1.8 i	[18E]	09.85- 08.86	CA158IR	14 45	09.85- 08.86	CS263	12 0.8
		09.85- 08.86	CA264IR	14 55			
		09.85- 08.86	CA352IR	14 65			





	[18SE]	09.86- 08.91 09.86- 08.91 09.86- 08.91	CA158IR CA264IR CA352IR	14 45 14 55 14 65		09.86- 01.88 01.88- 08.91	CS263 CS518	12 0.8 12 1.0
Brava 2.2 Diesel	[4FD1] [C223]					07.90- 09.92 08.91- 09.96	JS552 JS552	12 2.0 12 2.0
Brava 2.2 Diesel 4x4	[C223]					08.91- 09.96	JS552	12 2.0
Brava 2.3	[23P] [4ZD1]	08.94- 09.96 08.91- 08.94	JA1120IR# JA1120IR#	14 45 14 45				
Brava 2.3 4x4	[23P] [4ZD1]	08.94- 09.96 06.90- 08.96	JA1120IR# JA1120IR#	14 45 14 45				
Brava 2.5 Diesel	[4JA1]	08.91- 06.94	JA761IR	14 50		08.91- 06.94	JS999	12 2.8
Brava 2.5 Diesel 4x4	[4JA1T]	06.90- 12.96 06.90- 12.96	JA1290IR JA761IR	14 80 14 50		06.90- 12.96	JS999	12 2.8
Brava 2.5 TD	[4JA1T]	07.94- 03.98 03.97- 08.02	JA761IR JA1290IR	14 50 14 80		07.94- 08.02	JS999	12 2.8
Brava 2.5 TD 4x4	[4JA1T]	12.96- 03.98 03.97- 08.02	JA761IR JA1290IR	14 50 14 80		07.94- 08.02	JS999	12 2.8
Brava 3.1 Diesel	[4JG2T]	07.91- 07.01	JA873IR	14 60		07.91- 07.01	JS999	12 2.8
Calibra A 2.0 i16V	[C20XE] [X20XEV]	06.90- 07.97 06.90- 07.97 06.90- 07.97	CA1045IR CA1053IR CA861IR	14 120 14 100 14 70		06.90- 07.97	CS372 CS879	12 1.4 12 1.1
Calibra A 2.0 i16V 4x4	[C20XE] [X20XEV]	02.94- 07.97 02.94- 07.97 02.94- 07.97	CA1045IR CA1053IR CA861IR	14 120 14 100 14 70		02.94- 07.97	CS372 CS879	12 1.4 12 1.1
Calibra A 2.0 i Turbo 4x4	[C20LET]	03.92- 07.97 03.92- 07.97 03.92- 07.97	CA1045IR CA1053IR CA861IR	14 120 14 100 14 70		03.92- 07.97	CS727	12 1.1
Calibra A 2.0 i	[C20NE]	03.90- 03.97	CA517IR	14 70	Eng. -14608700 Eng. 14608701-	10.95- 03.97 03.90- 03.97 03.90- 12.94	CS518 CS727 CS372	12 1.0 DR 12 1.1 12 1.4 BO
Calibra A 2.0 i 4x4	[C20NE]	06.90- 03.97	CA517IR	14 70		01.95- 03.97 06.90- 12.94	CS727 CS372	12 1.1 12 1.4
Calibra A 2.5 i V6	[C25XE] [X25XE]	02.93- 11.95 02.93- 11.95 02.93- 11.95 04.93- 07.97 04.93- 07.97 04.93- 07.97	CA1051IR CA1070IR CA1103IR CA1051IR CA1070IR CA1103IR	14 70 14 120 14 100 14 70 14 120 14 100		04.93- 07.97	CS802	12 1.4
Carlton 1.8	[18NV] [E18NVR]	09.86- 12.89 09.86- 12.89 09.86- 12.89 09.86- 12.89 09.86- 12.89 09.87- 08.95 09.87- 08.95 09.87- 03.94	CA264IR CA352IR CA515IR CA517IR CA548IR# CA515IR CA517IR CA548IR#	14 55 14 65 14 90 14 70 14 55 14 90 14 70 14 55	Chas. -K1000098 AT 09.86- 12.89 Chas. K1000099- 09.86- 12.89	09.86- 12.89 09.86- 12.89 09.86- 12.89 09.86- 12.89 09.86- 12.89 AT 09.87- 03.94	CS518 CS372 CS727 CS518 CS372 CS727	12 1.0 DR 12 1.4 BO 12 1.1 12 1.1 12 1.1 12 1.1
Carlton 1.8 i	[18SEH]	09.86- 03.94 09.86- 03.94 09.86- 03.94	CA515IR CA517IR CA548IR#	14 90 14 70 14 55		09.86- 03.94	CS727	12 1.1
Carlton 1.8 S	[18S] [18SV]	12.82- 08.86 12.82- 08.86 09.86- 10.94 09.86- 10.94 09.86- 08.95 09.86- 08.95 09.86- 10.94 09.86- 10.94	CA158IR CA264IR CA352IR CA515IR CA517IR CA548IR# CA264IR CA352IR CA515IR CA517IR CA548IR#	14 45 14 55 14 65 14 90 14 70 14 55 14 55 14 65 14 90 14 70 14 55	Chas. K1000099- 09.86- 08.95 Chas. -K1000098 09.86- 10.94 AT 09.86- 10.94 Chas. K1000099- 09.86- 10.94	12.82- 08.86 09.86- 10.94 09.86- 10.94 09.86- 10.94 09.86- 10.94 09.86- 10.94	CS263 CS727 CS518 CS372 CS727	12 0.8 12 1.1 12 1.0 DR 12 1.4 BO 12 1.1 12 1.1
Carlton 2.0	[C20NE] [C20NEF] [C20NEJ]	09.86- 10.94 09.86- 10.94 09.86- 10.94 09.86- 10.94 09.86- 10.94 06.89- 03.94 06.89- 03.94 06.89- 03.94 06.89- 03.94 06.89- 03.94 06.89- 03.94 06.89- 03.94 06.89- 03.94 06.89- 03.94 06.89- 03.94	CA264IR CA352IR CA515IR CA517IR CA548IR# CA264IR CA352IR CA515IR CA517IR CA548IR# CA264IR CA352IR CA515IR CA517IR CA548IR#	14 55 14 65 14 90 14 70 14 55 14 55 14 65 14 90 14 70 14 55 14 55 14 65 14 90 14 70 14 55	AT 09.86- 10.94 Chas. -K1000098 09.86- 10.94 Chas. K1000099- 09.86- 10.94 Chas. K1000099- 06.89- 03.94 Chas. -K1000098 06.89- 03.94 AT 06.89- 03.94 Chas. -K1000098 06.89- 03.94 AT 06.89- 03.94 Chas. K1000099- 06.89- 03.94	09.86- 10.94 09.86- 10.94 09.86- 10.94 09.86- 10.94 09.86- 10.94 06.89- 03.94 06.89- 03.94 06.89- 03.94 06.89- 03.94 06.89- 03.94 06.89- 03.94 06.89- 03.94 06.89- 03.94 06.89- 03.94 06.89- 03.94	CS372 CS518 CS727 CS727 CS727 CS727 CS518 CS372 CS727 CS727 CS70 CS727 CS372 CS518 CS727	12 1.4 BO 12 1.0 DR 12 1.1 12 1.4 BO 12 1.1 12 1.1 12 1.0 DR 12 1.4 BO 12 1.1 12 1.1 12 0.8 12 1.1 12 1.4 BO 12 1.0 DR 12 1.1
Carlton 2.0 i	[20E] [20SE] [C20NEJ]	01.83- 12.84 09.86- 03.94 09.86- 03.94 09.86- 03.94 06.89- 03.94 06.89- 03.94 06.89- 03.94 06.89- 03.94 06.89- 03.94	CA264IR CA515IR CA517IR CA548IR# CA264IR CA352IR CA515IR CA517IR CA548IR#	14 55 14 90 14 70 14 55 14 55 14 65 14 90 14 70 14 55	AT 01.83- 12.84 AT 09.86- 03.94 09.86- 03.94 09.86- 03.94 Chas. K1000099- 06.89- 03.94 Chas. -K1000098 06.89- 03.94 AT 06.89- 03.94 Chas. K1000099- 06.89- 03.94 Chas. -K1000098 06.89- 03.94	01.83- 12.84 09.86- 03.94 09.86- 03.94 09.86- 03.94 06.89- 03.94 06.89- 03.94 06.89- 03.94 06.89- 03.94 06.89- 03.94	CS70 CS727 CS372 CS518 CS727 CS727 CS70 CS727 CS518 CS727	12 0.8 12 1.1 12 1.4 BO 12 1.0 DR 12 1.4 BO 12 1.1 12 1.1 12 0.8 12 1.1 12 1.0 DR
Carlton 2.0 S	[C20NEJ]	10.78- 08.86 10.78- 08.86	CA221IR CA42IR	14 65 14 55		10.78- 08.86	CS70	12 0.8
Carlton 2.2 i	[22E]	11.84- 08.86	CA99IR	14 55				
Carlton 2.3 Diesel	[23D] [23YD]	05.83- 08.86 09.86- 03.94	CA99IR CA384IR	14 55 14 70		09.86- 03.94	CS356	12 2.2
Carlton 2.3 TD	[23YDT]	09.86- 08.88	CA384IR	14 70		09.86- 08.88	CS356	12 2.2
Carlton 2.3 TD Intercooler	[23DTR]					09.88- 10.94	CS356	12 2.2
Carlton 2.4 i	[C24NE]	09.86- 10.94 09.86- 10.94 Chas. K1000099-, L1019854 09.86- 10.94 Chas. K1000099- 09.86- 10.94	CA515IR CA570IR CA515IR CA570IR	14 90 14 70 14 90 14 70		09.86- 10.94	CS80	12 1.0
Carlton 2.6 i	[C26NE]	09.90- 10.94	CA846IR	14 90		09.90- 10.94	CS80	12 1.0
Carlton 3.0	[30NE] [C30LE] [C30NE]	03.87- 09.90 03.87- 12.87 03.87- 03.94	CA221IR CA221IR CA221IR	14 65 14 65 14 65		03.87- 09.90 03.87- 12.87 03.87- 03.94	CS80 CS80 CS80	12 1.0 12 1.0 12 1.0
Carlton 3.0 24V	[C30SE] [C30SEJ]	09.89- 03.94 09.89- 03.94	CA221IR CA221IR	14 65 14 65		09.89- 03.94 09.89- 03.94	CS80 CS80	12 1.0 12 1.0
Carlton 3.6 24V Lotus	[C36GET]	01.90- 03.94	CA846IR	14 90				
Carlton MK 1.8 S	[18S]	11.82- 08.86 11.82- 08.86	CA158IR CA264IR	14 45 14 55		12.82- 08.86	CS263	12 0.8
Cavalier 1.3	[13N]	09.81- 08.88 09.81- 08.88	CA128IR CA99IR	14 45 14 55		09.81- 08.88 08.77- 08.81	CS162 CS70	12 0.7 12 0.8



**VAUXHALL** *Continued*

Cavalier 1.3 S	[13S]	09.81- 08.88 09.81- 08.88	CA128IR CA99IR	14 45 14 55		09.81- 08.88	CS162	12 0.7
Cavalier 1.4 S	[14NV]	09.88- 11.95 09.88- 11.95	CA513IR CA514IR	14 55 14 70		09.88- 12.93 09.88- 11.95	CS162 CS519	12 0.7 12 1.0
Cavalier 1.6	[16SH]	10.83- 08.88 10.83- 08.88	CA158IR CA264IR	14 45 14 55		10.83- 08.88	CS263	12 0.8
	[16SV]	09.88- 05.93 09.88- 05.93 PS 09.88- 05.93	CA513IR CA514IR CA519IR	14 55 14 70 14 65		09.88- 05.93 09.88- 05.93	CS519 CS535	12 1.0 12 0.9
Cavalier 1.6 1600	[16S]	09.75- 08.81	CA42IR	14 55		09.75- 08.81	CS70	12 0.8
Cavalier 1.6 i	[C16LZ]	08.86- 08.88 08.86- 08.88	CA158IR CA264IR	14 45 14 55		08.86- 08.88	CS263	12 0.8
	[C16NZ]	08.86- 08.88 08.86- 08.88	CA158IR CA264IR	14 45 14 55		08.86- 08.88	CS263	12 0.8
	[E16NZ]	09.88- 11.95 09.88- 11.95 09.88- 11.95 PS 09.88- 11.95 PS 09.88- 11.95 Chas. S1000001- 09.88- 11.95	CA513IR CA514IR CA861IR CA519IR CA861IR CA1146IR	14 55 14 70 14 70 14 65 14 70 14 70	Eng. 082382-, 085881	09.87- 12.91 09.87- 12.91	CS535 CS162	12 0.9 12 0.7
	[X16SZ]	09.94- 11.95 PS 09.94- 11.95 Chas. S1000001- 09.94- 11.95 Chas. -R7999999 09.94- 11.95	CA513IR CA861IR CA1146IR CA647IR	14 55 ▲ 14 70 14 70 14 70 ▲		09.94- 11.95 09.94- 11.95	CS1183 CS519	12 0.9 12 1.0
Cavalier 1.6 N	[16N]					09.81- 08.88 08.75- 08.81	CS263 CS70	12 0.8 12 0.8
Cavalier 1.6 S	[16S]	08.75- 08.81	CA42IR	14 55		08.75- 08.81	CS70	12 0.8
	[16SH]	09.81- 08.88	CA158IR	14 45		09.81- 08.88	CS263	12 0.8
		09.81- 08.88	CA264IR	14 55				
Cavalier 1.6 Diesel	[16D]					03.82- 08.88 03.82- 08.88	CS290 CS322	12 1.7 12 1.7
	[16DA]					03.82- 08.88 03.82- 08.88	CS290 CS322	12 1.7 12 1.7
Cavalier 1.6 Diesel 1600	[16D]					03.82- 08.88 03.82- 08.88	CS290 CS322	12 1.7 12 1.7
	[16DA]					03.82- 08.88 03.82- 08.88	CS290 CS322	12 1.7 12 1.7
Cavalier 1.7 Diesel	[17D]	09.88- 09.92	CA516IR	14 70		09.88- 09.92 09.88- 09.92	CS322 CS290	12 1.7 12 1.7
	[17DR]	07.92- 11.95	CA516IR	14 70		07.92- 11.95 07.92- 11.95	CS322 CS290	12 1.7 12 1.7
Cavalier 1.7 TD	[17DT (TC4EE1)]	09.88- 11.95	JA863IR	14 70		09.88- 11.95	JS753	12 1.4
Cavalier 1.8	[18SV]	09.88- 08.95	CA517IR	14 70		09.88- 12.94 09.88- 12.94	CS518 CS372	12 1.0 DR 12 1.4 BO
	[C18NZ]	09.88- 08.95	CA517IR	14 70		09.88- 12.94 09.88- 12.94	CS518 CS372	12 1.0 DR 12 1.4 BO
	[E18NV]	08.86- 08.88	CA264IR	14 55		08.86- 08.88	CS263	12 0.8
Cavalier 1.8 i	[18E]	09.81- 08.86 09.81- 08.88	CA158IR CA264IR	14 45 14 55		09.81- 08.88	CS263	12 0.8
	[18SE]	09.81- 08.88	CA264IR	14 55		09.86- 08.88	CS263	12 0.8
	[C18NZ]	03.90- 11.95	CA517IR	14 70		03.90- 12.94	CS372	12 1.4
Cavalier 1.9 S	[19S]	10.75- 03.78	CA42IR	14 55		10.75- 03.78	CS70	12 0.8
Cavalier 2.0 2000	[20S]	08.77- 08.81	CA42IR	14 55		08.77- 08.81	CS70	12 0.8
Cavalier 2.0 i 16V	[C20XE]					09.88- 11.95 09.88- 11.95	CS372 CS518	12 1.4 BO 12 1.0 DR
	[X20XE]	09.93- 11.95 09.93- 11.95 PS 09.93- 11.95	CA1045IR CA1053IR CA861IR	14 120 14 100 14 70		09.93- 11.95	CS879	12 1.1
Cavalier 2.0 i 16V 4x4	[C20XE]					09.88- 11.95 09.88- 11.95	CS372 CS518	12 1.4 BO 12 1.0 DR
Cavalier 2.0 i	[20NE]	09.88- 10.92	CA517IR	14 70		09.88- 10.92	CS372	12 1.4
	[20SEH]	09.88- 09.92	CA517IR	14 70		03.87- 09.92	CS372	12 1.4
	[C20NE]	09.88- 11.95	CA517IR	14 70		09.86- 11.95 09.88- 12.94 09.86- 08.88	CS727 CS372 CS518	12 1.1 12 1.4 12 1.0
Cavalier 2.0 i 4x4	[20NE]	09.88- 08.95 09.88- 08.95 PS 09.88- 08.95 Chas. -NV999999, -NV1999999, -N5999999 Chas. -MV206209, -M1175514, -M5247753	CA1045IR CA1053IR CA861IR CA515IR CA517IR	14 120 14 100 14 70 14 90 14 70	Eng. 14608701- 09.88- 08.95 Eng. -14608700 09.88- 08.95 Eng. -14608700 09.88- 08.95	09.88- 08.95 09.88- 08.95	CS727 CS372 CS518	12 1.1 12 1.4 BO 12 1.0 DR
	[20SEH]	09.88- 09.92	CA517IR	14 70		09.88- 09.92 09.88- 09.92	CS518 CS372	12 1.0 DR 12 1.4 BO
Cavalier 2.0 S	[20S]	01.78- 08.81	CA42IR	14 55		01.78- 08.81	CS70	12 0.8
Cavalier 2.5 V6	[C25XE]	02.93- 11.95 02.93- 11.95 02.93- 11.95	CA1051IR CA1070IR CA1103IR	14 70 14 120 14 100		02.93- 11.95	CS802	12 1.4
Cavalier MK 2.0 i 16V 4x4	[C20XE]					01.92- 11.93 01.92- 11.93	CS372 CS518	12 1.4 BO 12 1.0 DR
Cavalier MK 2.0 i Turbo 4x4	[C20LET]	09.92- 08.95 09.92- 08.95 PS 09.92- 08.95	CA1045IR CA1053IR CA861IR	14 120 14 100 14 70	Eng. -14005934 Eng. -14005933 Eng. 14005934- 09.92- 08.95	09.92- 08.95 09.92- 08.95	CS372 CS518 CS727	12 1.4 BO 12 1.0 DR 12 1.1
Chevette 1.3	[13N]	03.75- 01.80 03.75- 01.80 01.80- 01.84	CA17h CA18h CA48IR	14 34 14 43 14 45		03.75- 12.85	CS18	12 0.8
	[13S]	03.75- 01.80 03.75- 01.80 01.80- 12.85	CA17h CA18h CA48IR	14 34 14 43 14 45		03.75- 12.85	CS18	12 0.8
Combo 1.2	[C12NZ]	S4999999, -S6000012 07.94- 10.01 PS, Chas. -S3999999, -S4999999, -S6000012 07.94- 10.01 PS, Chas. S3000001-, S4000001-, S6000013- 07.94- 10.01 PS 07.94- 10.01 Chas. S3000001-, S4000001-, S6000013- 07.94- 10.01 ACPS 07.94- 10.01	CA513IR CA514IR CA1146IR CA1231IR CA1066IR CA861IR	14 55 14 70 14 70 14 55 14 55 14 70		07.94- 08.97	CS519	12 1.0
	[X12SZ]	07.94- 10.01 07.94- 10.01 PS, Chas. S3000001-, S4000001-, S6000013- 07.94- 10.01 PS, Chas. S3000001-, S4000001-, S6000013- 07.94- 10.01 PS 07.94- 10.01 ACPS 07.94- 10.01	CA513IR CA514IR CA1066IR CA1146IR CA1231IR CA861IR	14 55 14 70 14 55 14 70 14 55 14 70		07.94- 08.97	CS519	12 1.0
Combo 1.3 CDTi 16V	[Z13DT]	09.04- 09.04-	CA1855IR CA1862IR	14 75 14 90		09.04-	CS1334	12 1.1
	[Z13DTJ]	10.05- 10.05- 10.05-	CA1855IR CA1862IR CA1934IR	14 75 14 90 14 105		10.05-	CS1334	12 1.1



Combo 1.4	[C14NZ]	PS 07.94-10.01	CA8611R	14 70	07.94-10.01	CS519	12 1.0	
		Chas. -W3999999, -W4999999, -W6999999 07.94-10.01	CA1053IR	14 100				
		Chas. S3000001-, S4000001-, S6000013-07.94-10.01	CA1066IR	14 55				
		Chas. S3000001-, S4000001-, S6000013-07.94-10.01	CA1146IR	14 70				
		Chas. S3000001-, S4000001-, S6000013-07.94-10.01	CA1231IR	14 55				
		Chas. -R3999999, -R4999999, -S6000012 07.94-10.01	CA513IR	14 55				
		Chas. -R3999999, -R4999999, -S6000012 07.94-10.01	CA514IR	14 70				
		[C14SE]	07.94-10.01	CA8611R	14 70	07.94-10.01	CS519	12 1.0
		Chas. -W3999999, -W4999999, -W6999999 07.94-10.01	CA1053IR	14 100				
		Chas. S3000001-, S4000001-, S6000013-07.94-10.01	CA1045IR	14 120				
	Chas. S3000001-, S4000001-, S6000013-07.94-10.01	CA1066IR	14 55					
	Chas. S3000001-, S4000001-, S6000013-07.94-10.01	CA1231IR	14 55					
	Chas. -R3999999, -R4999999, -S6000012 07.94-10.01	CA892IR	14 55					
	[Z14XEP]	01.04-01.04	CA1658IR	14 120	01.04-	CS519	12 1.0	
		01.04-	CA1747IR	14 70				
		01.04-	CA1748IR	14 100				
Combo 1.6	[Z16SE]	08.01-10.04	CA1391IR	14 70	08.01-10.04	CS519	12 1.0	
		08.01-10.04	CA1581IR	14 100	08.01-10.04	CS1257	12 1.1	
Combo 1.6 16V CNG	[Z16YNG]	04.05-	CA1765IR	14 120	04.05-	CS1257	12 1.1	
Combo 1.7 CDTi 16V	[Z17DTH]	12.04-AC 12.04-	JA1900IR	14 110	12.04-	JS1158	12 1.4	
			JA1901IR	14 100				
Combo 1.7 Diesel 16V	[Y17DTL]	09.00-08.03	JA1521IR	14 100	09.00-08.03	JS1158	12 1.4	
		09.00-08.03	JA1526IR	14 70				
Combo 1.7 Diesel	[17D (4EE1)]	07.94-04.96	JA863IR	14 70	Eng. 00877696-07.94-04.96	JS941	12 1.4	
			JA1172IR	14 70	Eng. -00877695 07.94-04.96	JS651	12 1.4	
	[X17D (4EE1)]	04.96-	JA1172IR	14 70	Eng. -00877695 04.96-	JS651	12 1.4	
		04.96-	JA863IR	14 70	Eng. 00877696-04.96-	JS941	12 1.4	
Combo 1.7 DTi	[Y17DT]	10.01-AC 10.01-	JA1526IR	14 70	10.01-	JS1158	12 1.4	
			JA1521IR	14 100				
Corsa 1.4 i 16V	[X14XE]	09.94-08.99	CA1066IR	14 55	09.94-08.99	CS519	12 1.0	
		PS 09.94-08.99	CA1231IR	14 55				
	Chas. -W3999999, -Y4074789, -W6999999 09.94-08.99	ACPS 09.94-08.99	CA1053IR	14 100				
			CA8611R	14 70				
Corsa Mk III 1.0	[Z10XEP]	07.06-07.06-	CA1940IR	14 100	07.06-	CS1257	12 1.1	
			CA2046IR*	14 70				
Corsa Mk III 1.2	[Z12XEP]	07.06-07.06-	CA1940IR	14 100	07.06-	CS1257	12 1.1	
			CA2046IR*	14 70	07.06-	CS519	12 1.0	
Corsa Mk III 1.4	[Z14XEP]	07.06-07.06-	CA1940IR	14 100	07.06-	CS1257	12 1.1	
			CA2046IR*	14 70	07.06-	CS519	12 1.0	
Corsa B 1.0 i 12V	[X10XE]	09.96-09.00	CA1257IR	14 70	09.96-09.00	CS519	12 1.0	
		09.96-09.00	CA1329IR	14 55				
Corsa B 1.2 i 16V	[X12XE]	03.98-09.00	CA1257IR	14 70	03.98-09.00	CS519	12 1.0	
		03.98-09.00	CA1329IR	14 55				
Corsa B 1.2 i	[C12NZ]	09.94-09.00	CA1066IR	14 55	09.94-09.00	CS1257	12 1.1	
		09.94-09.00	CA1146IR	14 70				
		09.94-09.00	CA513IR	14 55				
		09.94-09.00	CA514IR	14 70				
		PS 09.94-09.00	CA1231IR	14 55				
		ACPS 09.94-09.00	CA8611R	14 70				
		[X12SZ]	09.94-09.00	CA1066IR	14 55	09.94-09.00	CS1257	12 1.1
			09.94-09.00	CA1146IR	14 70			
			09.94-09.00	CA513IR	14 55			
			09.94-09.00	CA514IR	14 70			
		PS 09.94-09.00	CA1231IR	14 55				
		ACPS 09.94-09.00	CA8611R	14 70				
Corsa B 1.4 i 16V	[X14XE]	09.94-09.00	CA1053IR	14 100	09.94-09.00	CS519	12 1.0	
		09.94-09.00	CA1231IR	14 55				
Corsa B 1.4 i	[C14NZ]	09.94-09.00	CA1053IR	14 100	03.93-09.00	CS519	12 1.0	
		09.94-09.00	CA1066IR	14 55				
		PS 09.94-09.00	CA1231IR	14 55				
		AT 09.94-09.00	CA1146IR	14 70				
		AC 09.94-09.00	CA1053IR	14 100				
	[C14SE]	04.94-08.00	CA1053IR	14 100	04.94-09.00	CS519	12 1.0	
	[X14SZ]	09.96-08.98	CA1053IR	14 100	09.96-08.98	CS519	12 1.0	
		PS 09.96-08.98	CA1231IR	14 55				
		AT 09.96-08.98	CA1146IR	14 70				
Corsa B 1.5 Diesel	[15D]	09.94-09.00	JA863IR	14 70	Eng. 00877696-09.94-09.00	JS941	12 1.4	
					Eng. -00877695 09.94-09.00	JS651	12 1.4	
Corsa B 1.5 TD	[15DT (T4EC1)]	03.93-09.94	JA863IR	14 70	03.93-10.96	JS941	12 1.4 LM	
		09.94-10.96	JA1172IR	14 70	03.93-10.96	JS651	12 1.4 SM	
	[X15DT (T4EC1)]	04.96-10.96	JA1172IR	14 70	04.96-10.96	JS651	12 1.4 SM	
		04.96-10.96	JA863IR	14 70	04.96-10.96	JS941	12 1.4 LM	
Corsa B 1.6 GSi 16V	[C16XE]	09.94-09.00	CA1053IR	14 100	09.94-09.00	CS519	12 1.0	
		09.94-09.00	CA1231IR	14 55				
Corsa B 1.6 i 16V	[X16XE]	09.94-08.99	CA1053IR	14 100	09.94-09.00	CS519	12 1.0	
		09.94-09.00	CA1231IR	14 55				
Corsa B 1.7 Diesel	[17D]	09.94-09.00	JA863IR	14 70	Eng. -00877695 09.94-09.00	JS651	12 1.4	
		02.96-09.00	JA1172IR	14 70	Eng. 00877696-09.94-09.00	JS941	12 1.4	
	[X17D]	04.96-09.00	JA1172IR	14 70	Eng. -00877695 04.96-09.00	JS651	12 1.4	
		04.96-09.00	JA863IR	14 70	Eng. 00877696-04.96-09.00	JS941	12 1.4	
Corsa MK II 1.4 16V	[C14SEL]	08.97-09.00	CA1053IR	14 100	08.97-09.00	CS519	12 1.0	
		PS 08.97-09.00	CA1231IR	14 55				
		PS 08.97-09.00	CA8611R	14 70				
Corsa MK II 1.6 16V	[C16SEL]	08.97-09.00	CA1053IR	14 100	08.97-09.00	CS519	12 1.0	
		PS 08.97-09.00	CA8611R	14 70				
CORSA Mk III 1.0 12V	[A10XEP]	06.10-06.10-	CA1940IR	14 100	06.10-	CS1257	12 1.1	
			CA2046IR*	14 70				
	[Z10XE]	09.00-02.01	CA1561IR	14 100	Chas. 19P00894-09.00-08.03	CS1257	12 1.1	
		09.00-02.01	CA1748IR	14 100	Chas. -19P00893 09.00-08.03	CS519	12 1.0	
		Chas. 23000001-, 24000001-, 26000001-09.00-02.01	CA1747IR	14 70				
	Chas. -13999999, -14999999, -16999999 09.00-02.01	CA1257IR	14 70					
	[Z10XEP]	11.03-08.05	CA1658IR	14 120	11.03-08.05	CS1257	12 1.1	
		11.03-08.05	CA1747IR	14 70				
Corsa MK III 1.2 Twinport	[Z12XEP]	07.04-	CA1748IR	14 100	07.04-	CS519	12 1.0	
CORSA Mk III 1.2 16V	[A12XER]	06.10-06.10-	CA1940IR	14 100	06.10-	CS519	12 1.0	
			CA2046IR*	14 70				
	[Z12XE]	09.00-02.01	CA1561IR	14 100	09.00-	CS519	12 1.0	
		09.00-02.01	CA1658IR	14 120	09.00-	CS1257	12 1.1	
		09.00-02.01	CA1748IR	14 100				
		Chas. 23000001-, 24000001-, 26000001-09.00-02.01	CA1747IR	14 70				
		Chas. -16999999 09.00-02.01	CA1257IR	14 70				
Corsa MK III 1.2 Dualfuel 16V	[Z12XE]	08.01-08.04	CA1561IR	14 100	08.01-08.04	CS519	12 1.0	
		08.01-08.04	CA1748IR	14 100	08.01-08.04	CS1257	12 1.1	
		Chas. 23000001-, 24000001-, 26000001-08.01-08.04	CA1747IR	14 70				



VAUXHALL Continued

		Chas. -16999999	08.01- 08.04	CA1257IR	14 70				
Corsa MK III 1.3 CDTi 16V	[Z13DT]		04.04- 04.04- 04.04- 04.04-	CA1855IR CA1862IR CA1934IR CA1935IR	14 75 14 90 14 105 14 120	09.03-	CS1334	12 1.1	
	[Z13DTE]		07.10- 07.10-	CA1955IR CA1956IR	14 70 14 100				
	[Z13DTJ]		09.05- 09.06- 09.05- 09.06- 09.05- 09.06-	CA1855IR CA1862IR CA1935IR	14 75 14 90 14 120	09.05- 09.06	CS1334	12 1.1	
Corsa Mk III 1.3 CDTi	[Z13DTH]		07.06- 07.06- 07.06-	CA1955IR CA1956IR CA1987IR	14 70 14 100 14 120	07.06-	CS1334	12 1.1	
	[Z13DTJ]		07.06- 07.06- 07.06-	CA1955IR CA1956IR CA1987IR	14 70 14 100 14 120	07.06-	CS1334	12 1.1	
Corsa MK III 1.4 Twinport	[Z14XEP]		06.03- 06.03-	CA1658IR CA1747IR	14 120 14 70	06.03-	CS519	12 1.0	
Corsa Mk III 1.4 16V	[A14XER]		07.10- 07.10-	CA1940IR CA2046IR*	14 100 14 70	07.10-	CS519	12 1.0	
	[Z14XE]		09.00- 08.03- 09.00- 08.03- 09.00- 08.03-	CA1391IR CA1581IR CA1821IR	14 70 14 100 14 120	09.00- 09.00-	CS1257 CS519	12 1.1 12 1.0	
Corsa MK III 1.6	[Z16LEL] [Z16SE]		05.07- 08.01- 10.04- 08.01- 10.04- 08.01- 10.04-	CA1973IR CA1391IR CA1581IR CA1765IR	14 120 14 70 14 100 14 120	05.07- 08.01- 10.04- 08.01- 10.04-	CS1438 CS1257 CS519	12 1.1 12 1.1 12 1.0	
Corsa Mk III 1.6 Turbo	[Z16LER]		02.07-	CA1973IR	14 120	02.07-	CS1438	12 1.1	
Corsa Mk III 1.7 CDTi 16V	[A17DTS] [Z17DTH]		07.10- 04.04-	CA2010IR JA1901IR	14 100 14 100	07.10- 04.04-	JS1158 JS1158	12 1.4 12 1.4	
Corsa Mk III 1.7 CDTi	[A17DTR]		07.06- AC 07.06-	CA2010IR CA2017IR	14 100 14 140	07.06-	JS1158	12 1.4	
Corsa MK III 1.7 DT 16V	[Y17DTL]		09.00- AC 09.00-	JA1526IR JA1521IR	14 70 14 100	09.00-	JS1158	12 1.4	
Corsa MK III 1.7 DTi 16V	[Y17DT]		09.00- AC 09.00-	JA1526IR JA1521IR	14 70 14 100	09.00- 08.03	JS1158	12 1.4	
Corsa MK III 1.8 16V	[Z18XE]		09.00- 09.00-	CA1391IR CA1581IR	14 70 14 100	09.01-	CS1257	12 1.1	
Corsa MK IV 1.6 VXR	[A16LES]		06.11-	CA1976IR	14 95				
Corsavan 1.4 i	[C14NZ]		01.94- 09.00- 01.94- 09.00- 01.94- 09.00- PS 01.94- 09.00- AT 01.94- 09.00-	CA1053IR CA1066IR CA861IR CA1231IR CA1146IR	14 100 14 55 14 70 14 55 14 70	01.94- 09.00	CS1257	12 1.1	
Corsavan 1.5 Diesel	[15D]		08.94- 12.95- 08.94- 12.95-	JA1172IR JA863IR	14 70 14 70	08.94- 12.95- 08.94- 12.95-	JS941 JS651	12 1.4 LM 12 1.4 SM	
Corsavan 1.7 Diesel	[17D (4EE1)] [X17D (4EE1)]	Eng. 00975025- 03.93- 09.00- Eng. -00975024 03.93- 09.00- Eng. 00975025- 04.96- 09.00- Eng. -00975024 04.96- 09.00-	03.93- 09.00- 03.93- 09.00- 04.96- 09.00- 04.96- 09.00-	JA1172IR JA863IR JA1172IR JA863IR	14 70 14 70 14 70 14 70	01.94- 09.00- 01.94- 09.00-	JS651 JS941 JS651 JS941	12 1.4 12 1.4 12 1.4 12 1.4	
Corsavan Mk II 1.4	[Z14XEP]		11.03- 11.06- 11.03- 11.06-	CA1658IR CA1747IR	14 120 14 70	11.03- 11.06	CS519	12 1.0	
Corsavan Mk III 1.2 16V	[A12XEL] [Z12XE]		07.06- 07.06- 09.00- 08.04- 09.00- 08.04- 09.00- 08.04- 09.00- 08.04-	CA1940IR CA2046IR* CA1257IR CA1561IR CA1658IR CA1747IR CA1748IR	14 100 14 70 14 70 14 100 14 120 14 70 14 100	07.06- 09.00- 08.04-	CS1257 CS1257	12 1.1 12 1.1	
		Chas. 23000001-, 24000001-, 26000001-09.00- 08.04- Chas. 23000001-, 24000001-, 26000001-09.00- 08.04-							
Corsavan MK III 1.2 Dualfuel 16V	[Z12XE]		08.01- 08.01-	CA1747IR CA1748IR	14 70 14 100	08.01- 08.01-	CS519 CS1257	12 1.0 12 1.1	
Corsavan MK III 1.3 CDTi 16V	[Z13DT] [Z13DTH] [Z13DTJ]		04.04- 04.04- 07.06- 07.06- 07.06- 07.06- 07.06- 07.06-	CA1855IR CA1862IR CA1955IR CA1956IR CA1987IR CA1955IR CA1956IR CA1987IR	14 75 14 90 14 70 14 100 14 120 14 70 14 100 14 120	04.04- 07.06-	CS1334 CS1334	12 1.1 12 1.1	
Corsavan MK III 1.7 Diesel	[Y17DTL]		09.00- 08.03- AC 09.00- 08.03-	JA1526IR JA1521IR	14 70 14 100	09.00- 08.03	JS1158	12 1.4	
Corsavan MK III 1.7 DTi 16V	[Y17DT]		09.00- 08.03- AC 09.00- 08.03-	JA1526IR JA1521IR	14 70 14 100	09.00- 08.03	JS1158	12 1.4	
Corsavan MK IV 1.2	[Z12XEP]		07.09- 07.09-	CA1940IR CA2046IR*	14 100 14 70	07.09-	CS519	12 1.0	
CORSAVAN MK IV 1.3 CDTi	[Z13DTE]		07.06- 07.06- 07.06-	CA1955IR CA1956IR CA1987IR	14 70 14 100 14 120				
Firenza 1.3 1300			01.71- 10.73-	CA17H	14 34				
Frontera 2.0	[C20NE] [X20SE]		04.95- 08.98- AC 04.95- 08.98- 04.95- 08.98-	CA1053IR CA1045IR CA1053IR	14 100 14 120 14 100	04.95- 08.98- 04.95- 08.98- 04.95- 08.98-	CS727 CS372 CS518 CS727 CS372 CS518	12 1.1 12 1.4 12 1.0 12 1.1 12 1.4 12 1.0	
			AC 04.95- 08.98-	CA1045IR	14 120	04.95- 08.98-	CS518	12 1.0	
Frontera A 2.0 i 4x4 Sport	[C20NE] [X20SE]		03.92- 08.95- 03.92- 08.95- 02.95- 10.98- 08.95- 10.98-	CA515IR CA517IR CA1045IR CA1053IR	14 90 14 70 14 120 14 100	03.92- 10.98- 03.92- 10.98- 03.92- 10.98-	CS372 CS727 CS518	12 1.4 BO 12 1.1 12 1.0 DR	
			AC 02.95- 08.98-	CA1053IR	14 100	02.95- 10.98-	CS727	12 1.1	
			AC 02.95- 08.98-	CA1045IR	14 120	02.95- 10.98-	CS372	12 1.4 BO	
Frontera A 2.2 i 4x4 Long	[X22XE]		03.95- 10.98- 03.95- 10.98-	CA1045IR CA1053IR	14 120 14 100	03.95- 10.98-	CS879	12 1.1	
Frontera A 2.3 TD 4x4 Long	[Z3DTR]		03.92- 10.98-	CA384IR	14 70	03.92- 10.98-	CS356	12 2.2	
Frontera A 2.4 i 4x4 Long	[C24NE]		03.92- 10.98- 03.92- 10.98-	CA221IR CA515IR CA570IR	14 65 14 90 14 70				
Frontera A 2.5 TD 4x4 Long	[Z5TDS]					06.96- 08.98-	CS1071	12 2.0	
Frontera A 2.5 TD 4x4 Sport	[Z5TDS]					06.96- 08.98-	CS1071	12 2.0	
Frontera A 2.8 TD 4x4 Long	[Z8TDJ]		03.95- 10.98-	JA1290IR	14 80	03.95- 10.98-	JS639	12 2.0	
Frontera A 2.8 TD 4x4 Sport	[Z8TDI]		03.95- 08.96-	JA1290IR	14 80	03.95- 08.96-	JS639	12 2.0	
Frontera B 2.2 i	[X22SE]		02.95- AC 02.95-	CA1053IR CA1045IR	14 100 14 120	02.95-	CS879	12 1.1	



	[Y22SE]	02.95-09.98-12.00	CA1045IR CA1053IR	14 120 14 100		02.95-09.98-09.98-09.98	CS879 CS976 CS976	12 1.1 12 2.0 12 2.0
Frontera B 2.2 DTi	[X22DTH] [Y22DTH]	09.98-09.98	CA1327IR	14 100		09.98-09.98	CS1438 CS1438	12 1.1 12 1.1
Insignia 1.6	[A16XER]					07.08-	CS1438	12 1.1
Insignia 1.6 Sedan	[A16LET] [A16XER]					07.08-07.08-	CS1438 CS1438	12 1.1 12 1.1
Insignia 1.6 Sports Tourer	[A16XER]					07.08-	CS1438	12 1.1
Insignia 1.6 Turbo	[A16LET]					01.09-	CS1438	12 1.1
Insignia 1.8	[A18XER]					07.08-	CS1438	12 1.1
Insignia 1.8 Estate	[A18XER]					07.08-	CS1438	12 1.1
Insignia 1.8 Sedan	[A18XER]					07.08-	CS1438	12 1.1
Insignia 2.0 Biturbo CDTi	[A20DTR]					03.12-03.12-	CS1264 CS1428	12 1.7 12 1.7
Insignia 2.0 Biturbo CDTi 4x4	[A20DTR]					03.12-03.12-	CS1264 CS1428	12 1.7 12 1.7
Insignia 2.0 CDTi 16V 4x4	[A20DTH]	07.08-	CA2005IR	14 100		07.08-07.08-AT 07.08-	CS1428 CS1264	12 1.7 12 1.7
Insignia 2.0 CDTi	[A20DTC] [A20DTH] [A20DTJ]	07.08-07.08-07.08-	CA2005IR	14 100		07.08-07.08-AT 07.08-	CS1428 CS1264 CS1428 CS1264	12 1.7 12 1.7 12 1.7 12 1.7
Insignia 2.0 CDTi 4x4	[A20DTR]	05.09-	CA2005IR	14 100		05.09-05.09-AT 07.08-	CS1264 CS1428	12 1.7 12 1.7
Insignia 2.0 CDTi Estate	[A20DTH] [A20DTJ]	07.08-07.08-	CA2005IR	14 100		07.08-07.08-AT 07.08-	CS1428 CS1264 CS1428	12 1.7 12 1.7 12 1.7
Insignia 2.0 CDTi Sedan	[A20DTC] [A20DTH] [A20DTJ]	07.08-07.08-07.08-	CA2005IR	14 100		07.08-07.08-AT 07.08-	CS1264 CS1428 CS1264 CS1428	12 1.7 12 1.7 12 1.7 12 1.7
Insignia 2.0 CDTi Sports Tourer	[A20DTC]	07.08-	CA2005IR	14 100		07.08-07.08-AT 07.08-	CS1428 CS1264	12 1.7 12 1.7
Insignia 2.8 Turbo V6 4x4	[A28NET]					07.08-	CS1488*	12
Insignia 2.8 Turbo V6 Estate 4x4	[A28NET]					07.08-	CS1488*	12
Insignia 2.8 Turbo V6 Sedan 4x4	[A28NET]					07.08-	CS1488*	12
Insignia 2.8 V6 24V	[A28NER]					07.09-	CS1488*	12
Insignia 2.8 V6 24V Sports Tourer	[A28NER]					07.09-	CS1488*	12
Magnum 1.8 1800		01.74-10.77	CA17v	14 34		01.76-10.77	CS19	12 0.8
Magnum 2.3		01.73-01.81	CA17v	14 34				
Meriva A 1.3 CDTi	[Z13DTJ]	09.03-09.03-	CA1934IR CA1935IR	14 105 14 120		09.03-	CS1334	12 1.1
Meriva A 1.4 16V Twinport	[Z14XEP]	07.04-07.04-07.04-07.04-	CA1658IR CA1747IR CA1748IR CA2046IR*	14 120 14 70 14 100 14 70		07.04-	CS519	12 1.0
Meriva A 1.6 i 16V	[Z16XE]	03.03-03.03-	CA1391IR CA1581IR	14 70 14 100		03.03-	CS1257	12 1.1
Meriva A 1.6 i 16V Twinport	[Z16XEP]	01.06-	CA1833IR	14 120		01.06-	CS519	12 1.0
Meriva A 1.6 i	[Z16SE]	03.03-	CA1581IR	14 100		03.03-	CS1257	12 1.1
Meriva A 1.6 Turbo	[Z16LET]	05.06-	CA1833IR	14 120		05.06-	CS1438	12 1.1
Meriva A 1.7 CDTi 16V	[Z17DTH]	AC 05.06-04.04-	CA1973IR JA1901IR	14 120 14 100		04.04-	JS1158	12 1.4
Meriva A 1.7 CDTi	[Z17DTR]	08.06-AT 08.06-	CA2010IR CA2017IR	14 100 14 140		08.06-	JS1158	12 1.4
Meriva A 1.8 i 16V	[Z18XE]	03.03-03.03-	CA1391IR CA1581IR	14 70 14 100		05.03-	CS1257	12 1.1
Meriva MK I 1.7 CDTi	[Y17DT]	06.03-	JA1521IR	14 100		06.03-	JS1158	12 1.4
Meriva MK II 1.3 CDTi 16V	[A13DTC]	06.10-06.10-06.10-	CA1955IR CA1956IR CA1987IR	14 70 14 100 14 120				
Meriva MK II 1.3 CDTi 16V ecoFlex	[A13DTE]	10.10-10.10-10.10-	CA1955IR CA1956IR CA1987IR	14 70 14 100 14 120				
Meriva MK II 1.7 CDTi 16V	[A17DT]	06.10-06.10-	CA2010IR CA2017IR	14 100 14 140		06.10-	JS1158	12 1.4
Meriva MK II 1.7 CDTi 16V Ecotec	[A17DTS]	10.10-10.10-	CA2010IR CA2017IR	14 100 14 140		10.10-	JS1158	12 1.4
Meriva MK II 1.7 CDTi	[A17DTC]	06.10-06.10-	CA2010IR CA2017IR	14 100 14 140		06.10-	JS1158	12 1.4
Midi 2.0	[20PET]	06.88-	JA697IR#	14 55				
Midi 2.0 Diesel	[4FC1T]	06.88-02.96	JA680IR#	14 50				
Midi 2.2 Diesel	[4FD1]	07.90-	JA680IR#	14 50				
Midi 2.4 Diesel	[24TD] [4FG1T]	10.94-08.97-09.94-	JA680IR# JA680IR#	14 50 14 50				
Monterey A 3.1 TD 4x4	[4JG2TC]	09.91-07.98-09.91-07.98-03.92-07.98	JA761IR JA873IR JA1290IR	14 50 14 60 14 80		01.95-07.98	JS639	12 2.0
Monterey B 3.0 DTi	[4JX1]					04.98-12.99	JS999	12 2.8
Movano 1.9 DTi	[F9Q770] [F9Q774]	09.00-10.01-10.01-AC 10.01-	CA1622IR CA1645IR CA1627IR	14 120 14 125 14 125		09.00-10.01-10.01-	CS1263 CS1193	12 2.0 12 1.8
Movano 2.0 DTi	[G9T720]	09.00-	CA1627IR	14 125		09.00-	CS1207	12 2.0
Movano 2.2 DTi	[G9T720]	09.00-	CA1627IR	14 125		09.00-	CS1207	12 2.0
Movano 2.3 CDTi FWD	[M9T670] [M9T672] [M9T676] [M9T678] [M9T680] [M9T690] [M9T692] [M9T694]					05.10-05.10-05.10-05.10-05.10-05.10-	CS1415 CS1415 CS1415 CS1415 CS1415 CS1415 CS1415	12 2.2 12 2.2 12 2.2 12 2.2 12 2.2 12 2.2 12 2.2
Movano 2.3 CDTi RWD	[M9T694] [M9T696]					05.10-07.10-07.10-	CS1415 CS1415 CS1415	12 2.2 12 2.2 12 2.2
Movano 2.5 CDTi	[G9U6 ] [G9U632] [G9U754]	08.06-08.06-04.04-08.06-	CA1827IR CA1827IR CA1827IR	14 150 14 150 14 150		08.06-08.06-04.04-08.06-	CS1207 CS1207 CS1207 CS1207	12 2.0 12 2.0 12 2.0 12 2.0



**VAUXHALL** *Continued*

Movano 2.5 Diesel	[S8U]	10.98-	CA1343IR	14 75	10.98- 09.00	CS1160	12 2.2
	[S8U772]	10.98- 09.00	CA1343IR	14 75	10.98- 09.00	CS1160	12 2.2
Movano 2.5 DTi	[G9U720]	10.01-	CA1661IR	14 125	10.01-	CS1207	12 2.0
	[G9U724]	10.03-	CA1661IR	14 125	10.03-	CS1207	12 2.0
	[G9U750]	04.04-	CA1827IR	14 150	04.04-	CS1207	12 2.0
	[G9U754]	04.04-	CA1827IR	14 150	04.04-	CS1207	12 2.0
Movano 2.8 DTi	[S9W702]	06.98- 10.01	CA1343IR	14 75	10.98- 10.01	CS1160	12 2.2
Movano 2.8 TDi	[S9W702]	10.98- 10.01	CA1343IR	14 75	10.98- 10.01	CS1160	12 2.2
	[S9W702]	10.98- 10.01	CA1434IR	14 110			
Movano 3.0 DTi	[ZD3200]	10.03-	CA2081IR*	14 120	10.03-	CS1491*	12 2.5
	[ZD3-202]	10.03-	CA2082IR*	14 135			
	[ZD3-202]	10.03-	CA2081IR*	14 120	10.03-	CS1491*	12 2.5
Movano MK II 2.3 CDTi 16V FWD	[M9T6..]				05.10-	CS1415	12 2.2
	[M9T67..]				05.10-	CS1415	12 2.2
	[M9T69..]				05.10-	CS1415	12 2.2
Movano MK II 2.3 CDTi 16V RWD	[M9T67..]				05.10-	CS1415	12 2.2
	[M9T69..]				05.10-	CS1415	12 2.2
Nova 1.4 S	[14NV]	01.90- 02.93	CA513IR	14 55	01.90- 02.93	CS535	12 0.9
	[14NV]	01.90- 02.93	CA513IR	14 55	01.90- 02.93	CS519	12 1.0
Nova 1.5 TD	[15DT (T4EC1)]	01.90- 02.93	JA673IR	14 70	01.90- 02.93	JS753	12 1.4
	[15DT (T4EC1)]	01.90- 02.93	JA871IR	14 70			
Nova A 1.0	[10S]	09.82- 08.88	CA128IR	14 45	09.82- 03.93	CS66	12 0.65
	[10S]	09.82- 08.88	CA99IR	14 55			
	[10S]	09.88- 03.93	CA513IR	14 55			
Nova A 1.2	[12ST]	05.83- 02.90	CA128IR	14 45	05.83- 02.90	CS162	12 0.7
	[12ST]	05.83- 02.90	CA99IR	14 55			
Nova A 1.2 i	[12NC]	05.83- 08.88	CA128IR	14 45	05.83- 03.93	CS162	12 0.7
	[12NC]	05.83- 03.93	CA513IR	14 55			
	[12NC]	05.83- 08.88	CA99IR	14 55			
	[C12NZ]	09.89- 03.93	CA513IR	14 55	09.90- 03.93	CS535	12 0.9
Nova A 1.2 N	[12NC]	01.85- 08.88	CA128IR	14 45	05.83- 03.93	CS162	12 0.7
	[12NC]	01.85- 03.93	CA513IR	14 55			
	[12NC]	01.85- 08.88	CA99IR	14 55			
	[12NV]	01.90- 03.93	CA513IR	14 55	01.90- 03.93	CS535	12 0.9
Nova A 1.2 S	[12ST]	05.83- 08.94	CA128IR	14 45	05.83- 03.93	CS162	12 0.7
	[12ST]	05.83- 08.94	CA513IR	14 55			
	[12ST]	05.83- 08.94	CA99IR	14 55			
	[12ST]	09.82- 02.90	CA128IR	14 45	09.82- 02.90	CS162	12 0.7
Nova A 1.3 i	[13NB]	09.85- 10.89	CA128IR	14 45	09.85- 10.89	CS162	12 0.7
	[13NB]	09.85- 10.89	CA99IR	14 55			
Nova A 1.3 S	[13NB]	09.89- 03.93	CA513IR	14 55	09.90- 03.93	CS535	12 0.9
	[13NB]	09.89- 03.93	CA513IR	14 55	09.90- 03.93	CS519	12 1.0
Nova A 1.3 S	[13SB]	09.82- 10.89	CA128IR	14 45	09.82- 10.89	CS162	12 0.7
	[13SB]	09.82- 10.89	CA99IR	14 55			
Nova A 1.4 i	[C14NZ]	01.90- 03.93	CA513IR	14 55	01.90- 03.93	CS535	12 0.9
	[C14NZ]	01.90- 03.93	CA513IR	14 55	01.90- 03.93	CS519	12 1.0
Nova A 1.4 S	[C14SE]	09.91- 03.93	CA892IR	14 55	09.91- 03.93	CS519	12 1.0
	[14NV]	01.90- 03.93	CA513IR	14 55	01.90- 03.93	CS535	12 0.9
Nova A 1.4 S	[14NV]	01.90- 03.93	CA513IR	14 55	01.90- 03.93	CS519	12 1.0
	[14NV]	01.90- 03.93	CA513IR	14 55			
Nova A 1.5 Diesel	[15D]	09.87- 03.93	JA673IR	14 70	09.87- 03.93	JS651	12 1.4
	[15D]	01.90- 03.93	JA871IR	14 70			
Nova A 1.5 TD	[15DT (T4EC1)]	01.90- 03.93	JA673IR	14 70	01.90- 03.93	JS753	12 1.4
	[15DT (T4EC1)]	01.90- 03.93	JA871IR	14 70			
Nova A 1.6 GSi	[C16SE]	02.92- 03.93	CA513IR	14 55	02.92- 03.93	CS535	12 0.9
	[C16SE]	02.92- 03.93	CA514IR	14 70	02.92- 03.93	CS519	12 1.0
	[C16SEi]	09.89- 03.93	CA513IR	14 55	09.89- 03.93	CS535	12 0.9
	[C16SEi]	09.89- 03.93	CA514IR	14 70	09.89- 03.93	CS519	12 1.0
Nova A 1.6 GSi	[E16SE]	05.88- 08.88	CA99IR	14 55	05.88- 03.92	CS535	12 0.9
	[E16SE]	09.88- 03.92	CA513IR	14 55	05.88- 03.92	CS519	12 1.0
	[E16SE]	09.88- 03.92	CA514IR	14 70			
	[E16SE]	09.88- 03.92	CA514IR	14 70			
Novavan 1.2	[12NV]	01.90- 10.94	CA513IR	14 55	01.90- 10.94	CS519	12 1.0
Novavan 1.5 Diesel	[15D (4EC1)]	01.91- 10.94	JA673IR	14 70	01.91- 10.94	JS651	12 1.4
	[15D (4EC1)]	01.91- 10.94	JA871IR	14 70			
Omega 2.0	[X20SE]	04.94- 12.00	CA861IR	14 70	03.94- 12.00	CS727	12 1.1
	[X20SE]	Chas. -Y1999999 04.94- 12.00	CA1045IR	14 120			
	[X20SE]	Chas. -Y1999999 04.94- 12.00	CA1053IR	14 100			
Omega 2.0 16V	[X20XE]	09.93- 08.99	CA861IR	14 70	09.93- 08.99	CS879	12 1.1
	[X20XE]	Chas. -Y1999999 09.93- 08.99	CA1045IR	14 120			
	[X20XE]	Chas. -Y1999999 09.93- 08.99	CA1053IR	14 100			
Omega 2.0 i	[20SE]	03.94- 12.00	CA1045IR	14 120	03.94- 12.00	CS727	12 1.1
	[20SE]	03.94- 12.00	CA1053IR	14 100			
	[20SE]	03.94- 12.00	CA861IR	14 70			
	[X20SE]	03.94- 12.00	CA861IR	14 70	Eng. 14005873- 04.94- 12.00	CS727	12 1.1
Omega 2.0 DTi 16V	[X20DTH]	10.98- 09.00	CA1326IR#	14 70	10.98- 09.00	CS976	12 2.0
	[X20DTH]	10.98- 09.00	CA1327IR	14 100			
	[X20DTH]	10.98- 09.00	CA1045IR	14 120			
Omega 2.2 i 16V	[Y22XE]	09.99- 09.04	CA1045IR	14 120	Chas. W1000001- 09.99- 09.04	CS879	12 1.1
	[Y22XE]	09.99- 09.04	CA1053IR	14 100			
	[Y22XE]	09.99- 09.04	CA861IR	14 70			
	[Z22XE]	09.99- 09.04	CA1045IR	14 120	Chas. W1000001- 09.99- 09.04	CS879	12 1.1
Omega 2.2 DTi 16V	[Y22DTH]	09.99- 09.04	CA1053IR	14 100			
	[Y22DTH]	09.00- 09.03	CA1577IR	14 120	09.00- 09.03	CS976	12 2.0
	[Y22DTH]	09.00- 09.03	CA1828IR	14 140			
Omega 2.5 V6	[X25XE]	04.94- 09.04	CA1103IR	14 100	03.94- 09.04	CS982	12 1.4
	[X25XE]	04.94- 10.96	CA1507IR	14 120			
	[X25XE]	11.96- 09.04	CA1070IR	14 120			
Omega 2.5 DTi 24V	[Y25DT]	09.01- 09.04	CA1584IR	14 150	09.01- 09.04	CS984	12 2.0
Omega 2.5 TD	[25DT]	04.94- 02.01	CA1150IR	14 105	04.94- 02.01	CS378	12 2.2
	[25DT]	04.94- 02.01	CA1150IR	14 105	04.94- 02.01	CS984	12 2.0
	[X25DT]	04.96-	CA1150IR	14 105	04.94- 02.01	CS378	12 2.2
Omega 2.6 i V6	[Y26SE]	09.00- 09.04	CA1731IR	14 120			



Omega 3.0 V6	[X30XE]	04.94- 02.01	CA1070IR	14 120	04.94- 02.01	CS982	12 1.4	
		04.94- 02.01	CA1103IR	14 100				
		04.94- 02.01	CA1507IR	14 120				
Omega 3.2 i V6	[Y32SE]	02.01-	CA1731IR	14 120				
Royale 2.8	[28H]	10.78- 12.82	CA221IR	14 65	10.79- 10.82	CS80	12 1.0	
		01.80- 12.82	CA42IR	14 55				
Royale 3.0	[30E]	10.78- 12.82	CA221IR	14 65	10.79- 10.82	CS80	12 1.0	
		10.79- 12.82	CA42IR	14 55				
Royale A 2.0	[H20E]				03.83- 10.84	CS70	12 0.8	
Royale A 2.5 E	[25E]	09.84- 08.87	CA221IR	14 65	09.84- 08.87	CS80	12 1.0	
		09.84- 08.87	CA42IR	14 55				
Royale A 2.8	[28H]				02.78- 04.81	CS80	12 1.0	
Royale A 3.0	[30E]	02.78- 12.82	CA221IR	14 65	02.78- 08.86	CS80	12 1.0	
		02.78- 12.82	CA42IR	14 55				
		[30H]	04.78- 07.82	CA221IR	14 65	04.78- 07.82	CS80	12 1.0
			01.80- 07.82	CA42IR	14 55			
		[C30LE]	09.85- 08.87	CA221IR	14 65	09.85- 08.87	CS80	12 1.0
		09.85- 08.87	CA515IR	14 90				
Royale A 3.0 E	[30E]	10.78- 12.86	CA42IR	14 55	10.78- 12.82	CS80	12 1.0	
Senator 2.5 i	[25E]	09.84- 10.90	CA221IR	14 65	09.84- 08.87	CS80	12 1.0	
		09.84- 08.87	CA42IR	14 55				
		09.87- 10.90	CA515IR	14 90				
Senator 3.0	[30NE]	09.87- 08.88	CA221IR	14 65				
		09.87- 08.88	CA42IR	14 55				
		09.87- 08.88	CA515IR	14 90				
		09.87- 08.88	CA570IR	14 70				
Senator 3.0 i	[30E]				09.84- 08.87	CS80	12 1.0	
Senator B 2.6 i	[C26NE]	09.90- 09.93	CA846IR	14 90				
Senator B 3.0	[30NE]	01.88- 09.90	CA221IR	14 65	01.88- 09.90	CS80	12 1.0	
		01.88- 09.90	CA515IR	14 90				
		[C30LE]	09.87- 09.93	CA221IR	14 65			
		09.87- 09.93	CA515IR	14 90				
Senator B 3.0 24V	[C30SE]	09.89- 09.93	CA515IR	14 90				
		09.89- 09.93	CA846IR	14 90				
Senator B 3.0 i	[C30NE]	01.88- 09.93	CA515IR	14 90				
		01.88- 09.93	CA570IR	14 70				
		01.88- 09.93	CA846IR	14 90				
Signum 1.8	[Z18XE]	06.03- 07.05	CA1581IR	14 100	06.03- 07.05	CS1257	12 1.1	
		06.03- 07.05	CA1765IR	14 120				
	[Z18XER]	Chas. 71052537- 08.05-	CA1960IR	14 120	08.05-	CS1438	12 1.1	
		Chas. -71052536 08.05-	CA1833IR	14 120				
Signum 1.9 CDTi 16V	[Z19DTH]	Chas. 71111928- 04.04-	CA1994IR	14 140	04.04- AT 04.04-	CS1428 CS1264	12 1.7 12 1.7	
		Chas. 71111928- 04.04-	CA2045IR	14 120				
		Chas. -71111927 04.04-	CA1884IR	14 105				
		Chas. -71111927 04.04-	CA1885IR	14 120				
		Chas. -71111927 04.04-	CA1890IR	14 130				
Signum 1.9 CDTi	[Z19DT]	Chas. 71111928- 04.04-	CA1994IR	14 140	04.04-	CS1264	12 1.7	
		Chas. 71111928- 04.04-	CA2045IR	14 120				
		Chas. -71111927 04.04-	CA1884IR	14 105				
		Chas. -71111927 04.04-	CA1885IR	14 120				
		Chas. -71111927 04.04-	CA1890IR	14 130				
Signum 2.0 i Turbo	[Z20NET]	05.03-	CA1740IR	14 120	05.03-	CS1291	12 1.8	
		05.03-	CA1858IR	14 100				
Signum 2.0 DTi	[Y20DTH]	05.03-	CA1577IR	14 120	05.03-	CS976	12 2.0	
		05.03-	CA1828IR	14 140				
Signum 2.2 i	[Z22YH]	05.03-	CA1740IR	14 120	05.03-	CS1395	12 1.4	
		05.03-	CA1858IR	14 100				
Signum 2.2 DTi	[Y22DTR]	05.03-	CA1577IR	14 120	05.03-	CS976	12 2.0	
		05.03-	CA1828IR	14 140				
Signum 3.2 V6	[Z32SE]	05.03-	CA1730IR	14 140	05.03-	CS1247	12 1.7	
Sintra 2.2 i 16V	[X22XE]	09.96- 09.99	CA1389IR	14 105	09.96- 09.99	CS879	12 1.1	
Sintra 2.2 DTi	[X22DTH]				09.97- 09.99	CS976	12 2.0	
Sintra 3.0 i 24V	[X30XE]				09.96- 09.99	CS802	12 1.4	
Speedster 2.0		10.03- 09.06	CA1740IR	14 120	10.03- 09.06	CS879	12 1.1	
		10.03- 09.06	CA1581IR	14 100				
Speedster 2.2 i	[Z22SE]	09.00-	CA1592IR	14 100	Chas. -11009958 09.00- Chas. 11009959- 09.00-	CS1291 CS1395	12 1.8 12 1.4	
		09.00-	CA1740IR	14 120				
Tigra 1.3 CDTi TwinTop	[Z13DT]	06.04-	CA1855IR	14 75	06.04-	CS1334	12 1.1	
		06.04-	CA1862IR	14 90				
		06.04-	CA1934IR	14 105				
		06.04-	CA1935IR	14 120				
Tigra 1.4	[Z14XEP]	06.04-	CA1748IR	14 100	09.04-	CS519	12 1.0	
		09.04-	CA1658IR	14 120				
		09.04-	CA1747IR	14 70				
Tigra 1.4 16V	[X14XE]	09.94- 08.99	CA1231IR	14 55	09.94- 08.99	CS519	12 1.0	
		09.94- 08.99	CA861IR	14 70				
Tigra 1.6 16V	[X16XE]	09.94- 08.99	CA1053IR	14 100	07.94-	CS519	12 1.0	
		09.94- 08.99	CA861IR	14 70				07.94-
Tigra 1.8	[Z18XE]	09.04-	CA1581IR	14 100	09.04-	CS1257	12 1.1	
		09.04-	CA1765IR	14 120				
Vectra 1.6	[Z16XEP]	Chas. 71052537- 01.06-	CA1960IR	14 120	01.06-	CS1257 CS519	12 1.1 12 1.0	
		Chas. -71052536 01.06-	CA1833IR	14 120				
Vectra 1.6 GTS	[Z16XEP]	Chas. 71052537- 01.06-	CA1960IR	14 120	01.06-	CS519 CS1257	12 1.0 12 1.1	
		Chas. -71052536 01.06-	CA1833IR	14 120				
Vectra 1.6 16V	[Z16XE]	06.04-	CA1581IR	14 100	06.04-	CS1257 CS519	12 1.1 12 1.0	
		06.04-	CA1765IR	14 120				
		06.04-	CA1821IR	14 120				
Vectra 1.6 16V GTS	[Z16XE]	06.04-	CA1581IR	14 100				
		06.04-	CA1765IR	14 120				
Vectra 1.6 i 16V	[X16XEL]	10.95-	CA1045IR	14 120	10.95-	CS1183 CS519	12 0.9 12 1.0	
		10.95-	CA1053IR	14 100				
		10.95-	CA861IR	14 70				
		[Y16XE]	09.99- 08.00	CA1045IR	14 120	10.95- 09.99- 08.00	CS1183 CS519	12 0.9 12 1.0
			09.99- 08.00	CA1053IR	14 100			
	[Z16XE]	PS 09.99- 08.00	CA861IR	14 70				
		09.00- 08.01	CA1045IR	14 120	10.95- 09.00- 08.01	CS1183 CS519	12 0.9 12 1.0	
		09.00- 08.01	CA1053IR	14 100				
		PS 09.00- 08.01	CA861IR	14 70				
Vectra 1.6 i	[X16SZR]	10.95-	CA1045IR	14 120	10.95-	CS1183 CS519 CS535	12 0.9 12 1.0 12 0.9	
		10.95-	CA1053IR	14 100				
		10.95-	CA861IR	14 70				
Vectra 1.7 TD	[X17DT (TC4EE1)] [X17DT (TC4EE1)]	10.95- 11.96	JA1172IR	14 70	10.95- 11.96	JS1091	12 1.2	
		11.96- 12.97	JA1172IR	14 70				
		AC 11.96- 12.97	JA1370IR	14 100				



**VAUXHALL** *Continued*

Vectra 1.8	[Z18XER]	Chas. 71052537-01.06-	CA1960IR	14 120	01.06-	CS1438	12 1.1
		Chas. -71052536 01.06-	CA1833IR	14 120			
		04.02-	CA1821IR	14 120	04.02-	CS1257	12 1.1
		04.02-	CA1765IR	14 120			
		04.02-	CA1581IR	14 100			
Vectra 1.8 GTS	[Z18XER]	Chas. 71052537-01.06-	CA1960IR	14 120	01.06-	CS1438	12 1.1
		Chas. -71052536 01.06-	CA1833IR	14 120			
Vectra 1.8 16V	[Z18XE]	10.03-	CA1581IR	14 100	10.03-	CS1257	12 1.1
		10.03-	CA1821IR	14 120			
Vectra 1.8 Dualfuel 16V	[Z18XE]	04.02-	CA1581IR	14 100	04.02-	CS1257	12 1.1
		04.02-	CA1765IR	14 120			
Vectra 1.8 Dualfuel 16V GTS	[Z18XE]	04.02-	CA1581IR	14 100	04.02-	CS1257	12 1.1
		04.02-	CA1765IR	14 120			
Vectra 1.8 i 16V	[X18XE]	10.95- 09.00	CA1045IR	14 120	10.95- 09.00	CS879	12 1.1
		10.95- 09.00	CA1053IR	14 100	11.96- 09.00	CS1183	12 0.9
		10.95- 09.00	CA861IR	14 70			
	[X18XE1]	09.98- 09.99	CA1045IR	14 120	09.98- 08.99	CS1188	12 1.1
		09.98- 09.99	CA1053IR	14 100	11.96-	CS879	12 1.1
		09.98- 08.99	CA861IR	14 70			
	[Z18XE]	PS 09.98- 09.99	CA861IR	14 70			
		09.00- 08.01	CA1045IR	14 120	04.02-	CS1257	12 1.1
		09.00- 08.01	CA861IR	14 70	09.00- 08.01	CS1188	12 1.1
		04.02-	CA1581IR	14 100			
		04.02-	CA1821IR	14 120			
Vectra 1.8 i 16V GTS	[Z18XE]	08.02-	CA1581IR	14 100	08.02- 08.05	CS1257	12 1.1
		08.02-	CA1821IR	14 120			
Vectra 1.9 CDTi 16V	[Z19DTH]	Chas. 71111928-04.04-	CA1994IR	14 140	AT 04.04-	CS1264	12 1.7
		Chas. 71111928-04.04-	CA2045IR	14 120	04.04-	CS1428	12 1.7
		Chas. -71111927 04.04-	CA1884IR	14 105			
		Chas. -71111927 04.04-	CA1885IR	14 120			
		Chas. -71111927 04.04-	CA1890IR	14 130			
Vectra 1.9 CDTi 16V GTS	[Z19DTH]	Chas. 71111928-04.04-	CA1994IR	14 140	AT 04.04-	CS1264	12 1.7
		Chas. 71111928-04.04-	CA2045IR	14 120	04.04-	CS1428	12 1.7
		Chas. -71111927 04.04-	CA1884IR	14 105			
		Chas. -71111927 04.04-	CA1885IR	14 120			
		Chas. -71111927 04.04-	CA1890IR	14 130			
Vectra 1.9 CDTi	[Z19DT]	Chas. 71111928-04.04-	CA1994IR	14 140	04.04-	CS1264	12 1.7
		Chas. 71111928-04.04-	CA2045IR	14 120			
		Chas. -71111927 04.04-	CA1884IR	14 105			
		Chas. -71111927 04.04-	CA1885IR	14 120			
		Chas. -71111927 04.04-	CA1890IR	14 130			
Vectra 1.9 CDTi GTS	[Z19DTL]	10.05-	CA1884IR	14 105	10.05-	CS1264	12 1.7
		10.05-	CA1994IR	14 140	04.04-	CS1264	12 1.7
	[Z19DT]	Chas. 71111928-04.04-	CA1994IR	14 140			
		Chas. 71111928-04.04-	CA2045IR	14 120			
		Chas. -71111927 04.04-	CA1884IR	14 105			
		Chas. -71111927 04.04-	CA1885IR	14 120			
		Chas. -71111927 04.04-	CA1890IR	14 130			
Vectra 2.0 i 16V	[X20XE]	10.95- 09.00	CA1045IR	14 120	10.95- 09.00	CS879	12 1.1
		10.95- 09.00	CA1053IR	14 100			
		10.95- 09.00	CA861IR	14 70			
		10.95- 03.02	CA1045IR	14 120	10.95- 03.02	CS727	12 1.1
		10.95- 03.02	CA1053IR	14 100			
Vectra 2.0 Turbo 16V	[Z20NET]	03.03-	CA1740IR	14 120	10.03-	CS1291	12 1.8
		Chas. 48008981-03.03-	CA1740IR	14 120			
		Chas. 31085253-, 38060500-03.03-	CA1592IR	14 100			
		Chas. 31085253-, 10.03-	CA1592IR	14 100			
		Chas. -31085252-, -38060499 03.03-	CA1858IR	14 100			
		Chas. -31085252 10.03-	CA1858IR	14 100			
Vectra 2.0 Turbo 16V GTS	[Z20NET]	03.03-	CA1740IR	14 120			
		Chas. 48008981-03.03-	CA1740IR	14 120			
		Chas. 31085253-, 38060500-03.03-	CA1592IR	14 100			
		Chas. -31085252-, -38060499 03.03-	CA1858IR	14 100			
Vectra 2.0 Diesel 16V	[X20DTL]	11.96-	CA1326IR#	14 70	11.96-	CS976	12 2.0
		11.96-	CA1327IR	14 100			
Vectra 2.0 Diesel Di 16V	[X20DTL]	11.96-	CA1326IR#	14 70	11.96-	CS976	12 2.0
		11.96-	CA1327IR	14 100			
Vectra 2.0 DTi 16V	[X20DTH]	06.97-	CA1326IR#	14 70	06.97-	CS976	12 2.0
		06.97-	CA1327IR	14 100			
	[Y20DTH]	04.02-	CA1828IR	14 140	06.97- 09.05	CS976	12 2.0
		06.97-	CA1490IR	14 70			
		06.97-	CA1501IR	14 100			
		06.97-	CA1577IR	14 120			
Vectra 2.0 DTi	[Y20DTH]	04.02-	CA1577IR	14 120	04.02-	CS976	12 2.0
		04.02-	CA1828IR	14 140			
Vectra 2.2 Direct	[Z22YH]	10.03-	CA1740IR	14 120	10.03-	CS1395	12 1.4
					10.03-	CS1291	12 1.8
Vectra 2.2 Direct GTS	[Z22YH]	10.03-	CA1740IR	14 120	10.03-	CS1395	12 1.4
Vectra 2.2 i 16V	[Z22SE]	09.00- 08.01	CA1592IR	14 100	Chas. 11170205-, 17085554-09.00- 08.01	CS1395	12 1.4
		09.00- 08.01	CA1740IR	14 120	Chas. -11170204-, -17085553 09.00- 08.01	CS1291	12 1.8
Vectra 2.2 i 16V GTS	[Z22SE]	08.02-	CA1592IR	14 100	08.02-	CS1291	12 1.8
		09.02-	CA1858IR	14 100			
Vectra 2.2 i	[C22SEL]	10.99- 08.01	CA1045IR	14 120	10.99- 08.01	CS879	12 1.1
Vectra 2.2 DTi 16V	[Y22DTR]	09.00- 08.01	CA1577IR	14 120	09.00- 08.01	CS976	12 2.0
		04.02-	CA1828IR	14 140			
Vectra 2.2 DTi 16V GTS	[Y22DTR]	04.02-	CA1577IR	14 120	04.02-	CS976	12 2.0
		04.02-	CA1828IR	14 140			
Vectra 2.2 DTi	[Y22DTR]	04.02-	CA1577IR	14 120	04.02-	CS976	12 2.0
		04.02-	CA1828IR	14 140			
Vectra 2.5 i V6	[X25XE]	05.95- 08.01	CA1507IR	14 120	09.95- 08.01	CS802	12 1.4
		05.95- 08.01	CA855IR	14 120			
		10.95- 09.00	CA1070IR	14 120			
		10.95- 09.00	CA1103IR	14 100			
		AC 10.95- 09.00	CA1507IR	14 120			
Vectra 2.6 i V6	[Y26SE]	09.00- 08.01	CA1730IR	14 140	09.00- 08.01	CS1247	12 1.7
Vectra 2.8 V6 Turbo	[Z28NEL]				08.05-	CS1488*	12
					08.05-	CS1488*	12
Vectra 2.8 V6 Turbo GTS	[Z28NEL]				08.05-	CS1488*	12
					08.05-	CS1488*	12
Vectra 3.2 i V6 GTS	[Z32SE]	08.02-	CA1730IR	14 140	08.02- 09.05	CS1247	12 1.7





Vectra 3.2 V6	[Z32SE]	06.03-	CA1730IR	14 140	06.03-	CS1247	12 1.7
Vectra MK II 1.8	[Z18XEL]	04.02- 07.08	CA1581IR	14 100	04.02- 07.08	CS1257	12 1.1
		04.02- 07.08	CA1765IR	14 120			
Vectra MK II 2.8 V6 Turbo	[Z28NET]				10.06- 08.08	CS1488*	12
Ventora 3.3 3300		03.69- 10.76	CA17v	14 34			
Viceroy 2.5 2500	[25S]	01.80- 10.82	CA221IR	14 65	01.80- 10.82	CS80	12 1.0
		01.80- 10.82	CA42IR	14 55			
Victor 1.6 1600		01.70- 09.72	CA17v	14 34	01.70- 09.72	CS19	12 0.8
Victor 1.8 1800		01.70- 10.76	CA17v	14 34	01.70- 10.76	CS19	12 0.8
Victor 2.0 2000		01.70- 09.72	CA17v	14 34	01.70- 09.72	CS19	12 0.8
Victor 2.3 2300		10.72- 10.76	CA17v	14 34	10.72- 10.76	CS19	12 0.8
Viva 1.1 1100	[11N]				01.63- 10.70	CS18	12 0.8
					01.66- 09.71	CS18	12 0.8
Viva 1.3		10.71- 10.75	CA17h	14 34	10.71- 10.75	CS18	12 0.8
		10.71- 10.75	CA15h#	14 28			
Viva 1.3 1300		10.75- 10.79	CA17h	14 34	10.75- 10.79	CS18	12 0.8
Viva 1.6 1600		01.68- 10.72	CA18v	14 43	01.68- 10.72	CS19	12 0.8
		01.68- 10.72	CA17v	14 34			
Viva 1.8 1800		01.73- 10.79	CA18v	14 43	01.73- 10.79	CS19	12 0.8
		01.73- 10.79	CA17v	14 34			
Vivaro 1.9 Diesel Di	[F9Q762]	08.01-	CA1645IR	14 125	08.01-	CS1193	12 1.8
		AC 08.01-	CA1627IR	14 125			
Vivaro 1.9 DTi	[F9Q760]	08.01-	CA1645IR	14 125	08.01-	CS1193	12 1.8
		AC 08.01-	CA1627IR	14 125			
Vivaro 2.0 16V	[F4R720]	08.01-	CA1829IR	14 100	08.01-	CS1255	12 0.9
		AC 08.01-	CA1627IR	14 125			
		AC 08.01-	CA1661IR	14 125			
		AC 08.01-	CA1824IR	14 150			
		A22 08.01-	CA1661IR	14 125			
Vivaro 2.0 CDTi	[M9R780]	08.06-	CA1959IR	14 150	08.06-	CS1415	12 2.2
	[M9R782]	01.06-	CA1959IR	14 150	01.06-	CS1415	12 2.2
					01.06-	CS1207	12 2.0
Vivaro 2.5 CDTi 16V	[G9U630]	01.06-	CA1827IR	14 150	01.06-	CS1207	12 2.0
		01.06-	CA1877IR	14 150			
Vivaro 2.5 CDTi	[G9U630]	08.06-	CA1827IR	14 150	08.06-	CS1207	12 2.0
Vivaro 2.5 Diesel	[G9U730]	04.03- 07.06	CA1627IR	14 125	04.03- 07.06	CS1207	12 2.0
		AC 04.03- 07.06	CA1661IR	14 125			
Vivaro 2.5 DTi	[G9U730]	04.04-	CA1627IR	14 125	04.04-	CS1207	12 2.0
		AC 04.04-	CA1661IR	14 125			
VX 2.0 i Turbo 220	[Z20LET]	04.03-	CA1581IR	14 100	04.03-	CS879	12 1.1
		04.03-	CA1592IR	14 100			
		04.03-	CA1740IR	14 120			
Zafira 1.6 16V	[X16XEL]	04.99-	CA1391IR	14 70	09.98- 08.99	CS519	12 1.0
		04.99-	CA1581IR	14 100			
	Chas. 12257453-, 15257664-, 18131575-04.99-		CA1821IR	14 120			
	Chas. -12257452-, -15257663-, -18131574 04.99-		CA1765IR	14 120			
Zafira 1.6 CNG	[Z16YNG]	09.01- 06.05	CA1581IR	14 100	09.01- 06.05	CS519	12 1.0
Zafira 1.8 16V	[X18XE1]	04.99-	CA1391IR	14 70	03.99- 09.00	CS1188	12 1.1
		04.99-	CA1581IR	14 100	Chas. 6G000001- 04.99- 09.00	CS1257	12 1.1
	Chas. 12257453-, 15257664-, 18131575-04.99-		CA1821IR	14 120			
	Chas. -12257452-, -15257663-, -18131574 04.99-		CA1765IR	14 120			
	[Z18XE]	09.00- 06.05	CA1391IR	14 70	09.00- 06.05	CS1257	12 1.1
		09.00- 06.05	CA1581IR	14 100			
		09.00- 06.05	CA1765IR	14 120			
	Chas. 12257453-, 15257664-, 18131575-09.00- 06.05		CA1821IR	14 120			
Zafira 2.0	[Z20LER]	06.02- 06.05	CA1909IR	14 120	06.02- 06.05	CS879	12 1.1
Zafira 2.0 Turbo 16V	[Z20LET]	Chas. 32240132- 09.01-	CA1765IR	14 120	09.01-	CS879	12 1.1
		Chas. -32240131 09.01-	CA1581IR	14 100			
Zafira 2.0 Diesel Di 16V	[X20DTL]	10.99-	CA1490IR	14 70	10.99-	CS976	12 2.0
		10.99-	CA1501IR	14 100			
		A19 10.99-	CA1582IR	14 120			
Zafira 2.0 DTi 16V	[Y20DTH]	04.99- 06.05	CA1582IR	14 120	04.99- 06.05	CS976	12 2.0
Zafira 2.2 16V	[Z22SE]	09.00- 06.05	CA1592IR	14 100	Chas. 22012029-, 09.00- 06.05	CS1395	12 1.4
					25005805-, 28038499-, 1H031121-		
		09.00- 06.05	CA1740IR	14 120	Chas. -22012028-, -09.00- 06.05	CS1291	12 1.8
					25005804-, -28038498-, 1H031120		
Zafira 2.2 Diesel	[Y22DTR]	06.01- 06.05	CA1577IR	14 120	06.01- 06.05	CS976	12 2.0
		06.01- 06.05	CA1828IR	14 140			
		A19 06.01- 06.05	CA1582IR	14 120			
		A19 06.01- 06.05	CA2067IR*	14 140			
Zafira MK I 1.8 Dualfuel Dualfuel	[Z18XE]	09.00- 08.05	CA1391IR	14 70	09.00- 08.05	CS1188	12 1.1
		09.00- 08.05	CA1581IR	14 100			
		09.00- 08.05	CA1765IR	14 120			
Zafira Mk II 1.6	[Z16XEP]	07.05-	CA1833IR	14 120	07.05-	CS1257	12 1.1
		07.05-	CA1882IR	14 100			
	[Z16XER]	12.07-	CA1882IR	14 100	12.07-	CS519	12 1.0
		Chas. 72095157- 12.07-	CA1960IR	14 120			
		Chas. -72095156 12.07-	CA1833IR	14 120			
Zafira MK II 1.6 CNG	[Z16YNG]	07.05-	CA1391IR	14 70	07.05-	CS1257	12 1.1
		07.05-	CA1581IR	14 100			
		07.05-	CA1765IR	14 120			
Zafira MK II 1.6 Turbo CNG	[A16XNT]	02.09-	CA1973IR	14 120	02.09-	CS1438	12 1.1
	[Z16XNT]	02.09-	CA1973IR	14 120	02.09-	CS1438	12 1.1
Zafira MK II 1.7 CDTi	[A17DTR]	01.08-	CA2010IR	14 100	01.08-	JS1158	12 1.4
		01.08-	CA2017IR	14 140			
Zafira MK II 1.7 TD	[A17DTJ]	04.09-	CA2010IR	14 100	04.09-	JS1158	12 1.4
		AC 04.09-	CA2017IR	14 140			
Zafira Mk II 1.8	[Z18XEP]	07.05-	CA1833IR	14 120	07.05-	CS1438	12 1.1
		07.05-	CA1882IR	14 100	07.05-	CS519	12 1.0
	[Z18XER]	07.05-	CA1833IR	14 120	07.05-	CS1438	12 1.1
					07.05-	CS519	12 1.0
Zafira Mk II 1.9 CDTi	[Z19DT]	07.05-	CA1884IR	14 105	07.05-	CS1264	12 1.7
		07.05-	CA1885IR	14 120			
		07.05-	CA1890IR	14 130			
		07.05-	CA1994IR	14 140			
		07.05-	CA2045IR	14 120			
	[Z19DTH]	07.05-	CA1884IR	14 105	AT 07.05-	CS1264	12 1.7
		07.05-	CA1885IR	14 120	07.05-	CS1428	12 1.7
		07.05-	CA1890IR	14 130			
		07.05-	CA1994IR	14 140			
		07.05-	CA2045IR	14 120			

**VAUXHALL Continued**

	[Z19DTL]	07.05- 07.05- 07.05- 07.05-	CA1884IR CA1890IR CA1994IR CA2045IR	14 105 14 130 14 140 14 120		07.05-	CS1264	12 1.7	
Zafira Mk II 2.0	[Z20LEH] [Z20LER]	01.06- 07.05-	CA1909IR CA1909IR	14 120 14 120		01.06- 07.05-	CS879 CS879	12 1.1 12 1.1	
Zafira Mk II 2.2	[Z22YH]					07.05-	CS1395	12 1.4	
Zafira MK III 1.6 CNG	[A16XNT]					10.11-	CS1438	12 1.1	
Zafira MK III 1.8	[A18XEL]					10.11-	CS1438	12 1.1	
Zafira MK III 2.0 CDTi	[A20DTL]	10.11-	CA2005IR	14 100		10.11- 10.11-	CS1428 CS1264	12 1.7 12 1.7	
<b>PASSENGER CARS AO</b>									
Cavalier 2.0 GSi	[20XE]	09.89- 08.92	CA861IR	14 70		09.89- 08.92 09.89- 08.92	CS518 CS727	12 1.0 DR 12 1.1 BO	
Cavalier 2.0 GSi 4WD	[20XE]	09.89- 08.92	CA861IR	14 70		09.89- 08.92 09.89- 08.92	CS727 CS518	12 1.1 BO 12 1.0 DR	
<b>Volvo</b>									
<b>PASSENGER CARS EU</b>									
66 1.1	[B11]	12.67- 08.78	CA165IR	14 50		12.67- 08.78	CS95	12 0.6	
66 1.3	[B130]	12.67- 08.78	CA165IR	14 50		12.67- 01.78	CS95	12 0.6	
164 3.0	[B30E]					09.67- 07.74	CS140	12 1.1	
164 3.0 E	[B30A]					08.68- 07.73	CS140	12 1.1	
240 2.0	[B19A]	08.76- 07.84	CA88IR	14 55		08.76- 07.84 08.83- 07.84	CS140 CS80	12 1.1 12 1.0	
	[B19ET]	10.82- 08.84	CA88IR	14 55		10.82- 08.84 10.82- 08.84	CS292 CS389	12 1.1 12 1.4	
	[B19K]	08.80- 07.84	CA88IR	14 55		09.76- 08.83 08.83- 07.84	CS140 CS80	12 1.1 12 1.0	
	[B200F]	09.88- 12.93 09.88- 12.93 AC 09.88- 12.93 AC 09.88- 12.93	CA899IR CA903IR CA381IR CA905IR	14 65 14 65 14 80 14 80					
	[B200K]	08.84- 07.85 08.84- 07.85	CA528IR CA88IR	14 55 14 55		08.84- 07.85 08.84- 07.85	CS292 CS140	12 1.1 12 1.1	
240 2.1	[B21A]	08.74- 07.84	CA88IR	14 55		08.74- 07.84 08.83- 07.84	CS140 CS292	12 1.1 12 1.1	
	[B21E]	08.74- 07.80	CA88IR	14 55		08.74- 07.80	CS140	12 1.1	
	[B21F]	08.81- 07.84	CA88IR	14 55		08.80- 07.83 08.83- 07.84	CS140 CS292	12 1.1 12 1.1	
240 2.1 Turbo	[B21ET]	08.81- 07.85	CA88IR	14 55		08.83- 07.85 08.80- 07.83	CS292 CS140	12 1.1 12 1.1	
240 2.3	[B230A]	08.84- 07.86	CA528IR	14 55		08.84- 07.86	CS292	12 1.1	
	[B230E]					08.83- 07.84 08.84- 07.85	CS140 CS292	12 1.1 12 1.1	
	[B230F]	08.86- 07.93 08.86- 07.91 08.88- 07.91 08.91- 07.93 08.91- 07.93 AC 08.92- 07.93	CA381IR CA528IR CA903IR CA899IR CA905IR CA905IR	14 80 14 55 14 65 14 65 14 80 14 80			03.87- 07.93 08.86- 07.88	CS389 CS292	12 1.4 12 1.1
	[B230K]	08.84- 07.90 08.86- 07.90 AC 08.84- 07.86 AC 08.86- 07.90	CA528IR CA381IR CA528IR CA381IR	14 55 14 80 14 55 14 80		08.84- 07.88 08.88- 07.90	CS292 CS389	12 1.1 12 1.4	
	[B23A]	08.81- 07.84	CA88IR	14 55		08.80- 07.84	CS140	12 1.1	
	[B23E]	08.81- 07.83 08.84- 07.86 07.86- 12.88 08.86- 12.89 AC 08.86- 12.89	CA88IR CA528IR CA381IR CA903IR CA381IR	14 55 14 55 14 80 14 65 14 80		01.83- 07.88 03.87- 12.89 08.78- 07.83	CS292 CS389 CS140	12 1.1 12 1.4 12 1.1	
	240 2.4 Diesel	[D24]	08.78- 08.93	CA238IR	14 55		06.84- 08.93 08.78- 05.84	CS386 CS347	12 2.2 12 2.0
	240 2.7 i	[B27E]					08.79- 07.80	CS135	12 1.1
	260 2.7	[B27A]					08.75- 07.77	CS135	12 1.1
		[B27E] [B27F]					07.75- 07.82 10.78- 07.82	CS135 CS135	12 1.1 12 1.1
260 2.8	[B28F]					08.80- 07.82	CS135	12 1.1	
340 1.3	[B13]	01.89- 12.90	CA289IR	14 55		01.89- 12.90	CS321	12 0.9	
340 1.4	[B14.3E]	08.79- 08.81 09.81- 08.85	CA165IR CA289IR	14 50 14 55		05.81- 08.85	CS321	12 0.9	
	[B14.4S]	06.78- 08.81 09.81- 12.88	CA165IR CA289IR	14 50 14 55		08.75- 09.78	CS95	12 0.6	
	[D16]	08.84- 07.91 Eng. -3319636 08.84- 07.91 Eng. 14932- 08.84- 07.91	CA373IR CA529IR CA529IR	14 60 14 60 14 60		08.84- 07.91	CS354	12 1.7	
340 1.7	[B172K]	08.85- 07.91	CA372IR	14 60		08.85- 07.91	CS310	12 0.9	
340 2.0	[B19A]	08.80- 07.84	CA88IR	14 55		08.80- 07.84	CS140	12 1.1	
	[B200K]	08.84- 07.88	CA528IR	14 55		08.84- 07.88	CS292	12 1.1	
343 1.4	[B14.4S]	08.83- 07.86	CA289IR	14 55		08.83- 07.86	CS321	12 0.9	
360 2.0	[B19A]	08.82- 07.84	CA88IR	14 55		09.83- 07.84 08.82- 07.84 08.82- 07.84	CS292 CS140 JS370	12 1.1 12 1.1 12 1.2	
	[B19E]	08.82- 07.84	CA88IR	14 55		08.82- 07.84 08.82- 07.84	CS140 JS370	12 1.1 12 1.2	
	[B200E]	08.84- 07.89 08.86- 07.89	CA528IR CA381IR	14 55 14 80		08.84- 07.88 08.88- 07.89	CS292 CS389	12 1.1 12 1.4	
	[B200EA]	08.86- 07.88	CA381IR	14 80		08.86- 07.88	CS292	12 1.1	
	[B200F]	08.86- 07.90 08.86- 07.90	CA381IR CA528IR	14 80 14 55		08.86- 07.88 08.88- 07.90	CS292 CS389	12 1.1 12 1.4	
	[B200K]	08.84- 07.86 08.86- 07.90	CA528IR CA381IR	14 55 14 80		08.84- 07.90	CS292	12 1.1	
	440 1.6	[B16F]	09.88- 07.97 AC 09.88- 07.97	CA574IR CA711IR	14 70 14 70		09.88- 07.97	CS310	12 0.9
	[B16FI]	09.91- 08.93 AC 09.91- 08.93	CA574IR CA711IR	14 70 14 70		09.91- 08.93	CS310	12 0.9	
	440 1.7	[B18EP]	09.88- 08.94 09.88- 08.94 AC 09.88- 08.94	CA574IR CA625IR CA711IR	14 70 14 60 14 70		09.88- 08.94	CS310	12 0.9
		[B18F]	08.88- 08.91 08.88- 08.91 AC 08.88- 08.91	CA574IR CA625IR CA711IR	14 70 14 60 14 70		08.88- 08.91	CS310	12 0.9



	[B18FP]	08.89- 07.92 08.89- 07.92 AC 08.89- 07.92	CA574IR CA625IR CA711IR	14 70 14 60 14 70		08.89- 07.92	CS310	12 0.9
	[B18KD]	09.88- 08.92 09.88- 08.92	CA625IR CA716IR	14 60 14 110		09.88- 08.92	CS310	12 0.9
	[B18KP]	09.88- 08.93 09.88- 08.93 AC 09.88- 08.93	CA574IR CA625IR CA711IR	14 70 14 60 14 70		09.88- 08.93	CS310	12 0.9
	[F3N.]	10.95-	CA1573IR#	14 75				
440 1.7 Turbo	[B18FT]	08.88- 12.96 08.88- 12.96 AC 08.88- 12.96	CA574IR CA625IR CA711IR	14 70 14 60 14 70		08.88- 12.96 01.91- 12.96	CS310 CS681	12 0.9 12 1.1
440 1.8	[B18U]	08.91- 07.97 08.91- 07.97 09.95- 07.97 AC 08.91- 07.97	CA574IR CA625IR CA716IR CA711IR	14 70 14 60 14 110 14 70	▲	09.95- 12.96 08.91- 07.97	CS310 CS681	12 0.9 12 1.1
440 1.9 TD	[D19T]	07.94- 12.96 AC 07.94- 12.96	CA574IR CA711IR	14 70 14 70		09.93- 07.97	CS684	12 1.7
440 2.0	[B20F]	08.92- 07.96 08.92- 07.96 01.95- 07.96 AC 08.92- 07.96	CA574IR CA625IR CA716IR CA711IR	14 70 14 60 14 110 14 70	▲	08.92- 07.96	CS681	12 1.1
460 1.6	[B16F]	07.92- 07.97 07.92- 07.97 01.95- 07.97 AC 07.92- 07.97	CA574IR CA625IR CA716IR CA711IR	14 70 14 60 14 110 14 70	▲	09.93- 07.97 07.92- 07.97	CS681 CS310	12 1.1 12 0.9
460 1.7	[B18EP]	08.89- 07.92 08.89- 07.92 AC 08.89- 07.92	CA574IR CA625IR CA711IR	14 70 14 60 14 70		08.89- 07.92 08.89- 07.92	CS310 CS681	12 0.9 12 1.1
	[B18FP]	03.90- 07.93 AC 03.90- 07.93	CA574IR CA711IR	14 70 14 70		03.90- 07.93	CS310	12 0.9
	[B18KD]	09.89- 08.91 09.89- 08.91 09.89- 08.91	CA574IR CA625IR CA711IR	14 70 14 60 14 70		09.89- 08.91 09.89- 08.91	CS310 CS681	12 0.9 12 1.1
	[F3N.]	10.95-	CA1573IR#	14 75				
460 1.7 Turbo	[B18FT]	08.89- 07.96 08.89- 07.96 01.95- 07.96 AC 08.89- 07.96	CA574IR CA625IR CA716IR CA711IR	14 70 14 60 14 110 14 70	▲	08.89- 07.96 08.89- 07.96	CS681 CS310	12 1.1 12 0.9
460 1.8	[B18U]	08.91- 07.96 08.91- 07.96 AC 08.91- 07.96	CA574IR CA625IR CA711IR	14 70 14 60 14 70		08.91- 07.96 08.91- 07.96	CS681 CS310	12 1.1 12 0.9
460 1.9 TD	[D19T]	09.93- 07.97 09.93- 07.97 07.94- 07.96 AC 09.93- 07.97	CA574IR CA625IR CA716IR CA711IR	14 70 14 60 14 110 14 70		09.93- 07.97	CS684	12 1.7
460 2.0	[B20F]	08.92- 07.96 08.92- 07.96 01.95- 07.96 AC 08.92- 07.96	CA574IR CA625IR CA716IR CA711IR	14 70 14 60 14 110 14 70	▲	08.92- 07.96	CS681	12 1.1
480 1.7	[B18E]	04.86- 07.89 04.86- 07.89 AC 04.86- 07.89	CA574IR CA625IR CA711IR	14 70 14 60 14 70		04.86- 07.89	CS310	12 0.9
	[B18EP]	08.89- 07.90 08.89- 07.90 AC 08.89- 07.90	CA574IR CA625IR CA711IR	14 70 14 60 14 70		08.89- 07.90	CS310	12 0.9
	[B18F]	08.87- 07.89 08.87- 07.89 AC 08.87- 07.89	CA574IR CA625IR CA711IR	14 70 14 60 14 70		08.87- 07.89	CS310	12 0.9
	[F3N.]	10.95-	CA1573IR#	14 75				
480 1.7 Turbo	[B18FT]	08.87- 07.96 08.87- 07.96 01.95- 07.96 AC 08.87- 07.96	CA574IR CA625IR CA716IR CA711IR	14 70 14 60 14 110 14 70	▲	08.87- 07.96 08.87- 07.96	CS310 CS681	12 0.9 12 1.1
480 2.0	[B20F]	08.92- 09.95 08.92- 09.95 08.92- 09.95	CA574IR CA625IR CA711IR	14 70 14 60 14 70		08.92- 09.95 08.92- 09.95	CS310 CS681	12 0.9 12 1.1
740 2.0	[B19ET]					12.83- 07.84	CS292	12 1.1
	[B200E]	08.86- 07.91	CA905IR	14 80		12.83- 07.84 08.85- 07.91 08.84- 07.85	CS389 CS389 CS292	12 1.4 12 1.4 12 1.1
	[B200ET]	01.85- 07.86 08.86- 07.89	CA528IR CA381IR	14 55 14 80		01.85- 07.89 01.85- 07.89	CS292 CS389	12 1.1 12 1.4
	[B200F]	08.89- 07.91	CA381IR	14 80		08.89- 07.91	CS389	12 1.4
	[B200K]	08.84- 07.86 08.86- 07.89	CA528IR CA381IR	14 55 14 80		08.84- 07.85 08.85- 07.89	CS292 CS389	12 1.1 12 1.4
740 2.0 Turbo	[B200ET]	05.85- 08.87 05.85- 08.87	CA381IR CA528IR	14 80 14 55		05.85- 08.87 05.85- 08.87	CS292 CS389	12 1.1 12 1.4
740 2.3	[B230A]	08.84- 07.87	CA528IR	14 55		08.84- 07.87	CS389	12 1.4
	[B230E]	08.84- 08.87 08.86- 07.88	CA528IR CA381IR	14 55 14 80		08.85- 07.88 08.84- 07.88	CS389 JS370 CS292	12 1.4 12 1.2 12 1.1
	[B230F]	08.84- 07.87 09.85- 07.91 08.86- 07.90 AC 09.85- 07.91 AC 08.91- 07.92	CA528IR CA903IR CA381IR CA381IR CA905IR	14 55 14 65 14 80 14 80 14 80		08.87- 07.92 08.84- 07.85 08.85- 07.92	JS370 CS292 CS389	12 1.2 12 1.1 12 1.4
	[B230FB]	08.88- 07.90 08.90- 07.95	CA381IR CA905IR	14 80 14 80		08.88- 07.90 08.90- 07.95	CS140 CS389	12 1.1 12 1.4
	[B230K]	09.85- 07.87 08.86- 07.90	CA528IR CA381IR	14 55 14 80		09.85- 07.90	CS389	12 1.4
	[B234F]	08.87- 07.90	CA1551IR	14 90		08.87- 07.90 08.87- 07.89	CS389 JS370	12 1.4 12 1.2
	[B23A]	08.84- 07.87 08.86- 07.90	CA528IR CA381IR	14 55 14 80		08.84- 07.85 08.85- 07.90	CS292 CS389	12 1.1 12 1.4
	[B23E]					08.83- 07.84	CS140	12 1.1
740 2.3 16V	[B234F]	08.88- 07.91	CA1551IR	14 90		08.88- 07.91 08.88- 07.91	JS370 CS389	12 1.2 12 1.4
740 2.3 i	[B234F]	07.89- 07.90	CA1551IR	14 90		07.89- 07.90	CS389	12 1.4
740 2.3 Turbo	[B230ET]					08.84- 07.85 08.85- 07.89	CS292 CS389	12 1.1 12 1.4
	[B230FT]	09.90- 07.91	CA903IR	14 65		08.86- 07.91	CS389	12 1.4
	[B230GT]					08.89- 07.90	CS389	12 1.4



**VOLVO** *Continued*

740 2.4 Diesel	[D24]	04.84- 07.84	CA238IR	14 55	04.84- 07.92	CS386	12 2.2
		08.86- 07.88	CA811IR	14 55			
		08.88- 07.91	CA528IR	14 55			
		08.88- 07.92	CA900IR	14 80			
740 2.4 TD	[D24T]	04.87- 07.88	CA528IR	14 55	04.85- 07.92	CS386	12 2.2
		08.88- 07.91	CA811IR	14 55			
		08.88- 07.92	CA900IR	14 80			
		Chas. 176800-,294100- 08.88- 07.91	CA528IR	14 55			
	Chas. 176800-,294100- 08.88- 07.91	CA900IR	14 80				
	Chas. -176799-,294099 08.86- 07.88	CA811IR	14 55				
	[D24TIC]	08.86- 07.92	CA528IR	14 55	08.86- 07.92	CS386	12 2.2
		08.86- 07.92	CA900IR	14 80			
740 2.4 TD Intercooler	[D24TIC]	08.86- 07.91	CA528IR	14 55	08.86- 07.92	CS386	12 2.2
		08.86- 07.92	CA900IR	14 80			
760 2.3	[B230FT]	01.88- 07.92	CA900IR	14 80	08.85- 07.92	CS389	12 1.4
					08.84- 07.85	CS292	12 1.1
760 2.3 Turbo	[B230ET]				08.84- 07.85	CS292	12 1.1
					08.84- 07.92	CS389	12 1.4
	[B23ET]				08.82- 07.83	CS140	12 1.1
					08.83- 07.84	CS292	12 1.1
760 2.4 Diesel	[D24]	08.84- 07.86	CA238IR	14 55	01.82- 05.84	CS347	12 2.0
		08.86- 07.87	CA811IR	14 55	05.84- 07.87	CS386	12 2.2
760 2.4 TD	[D24T]	08.82- 07.84	CA238IR	14 55	08.82- 07.92	CS386	12 2.2
		08.86- 07.92	CA811IR	14 55			
		04.87- 07.92	CA900IR	14 80			
760 2.4 TD Intercooler	[D24TIC]	08.88- 07.92	CA900IR	14 80	08.87- 07.92	CS386	12 2.2
760 2.8	[B280E]				02.82- 08.91	CS135	12 1.1
	[B280F]				05.86- 08.91	CS135	12 1.1
	[B28A]				01.82- 12.87	CS135	12 1.1
	[B28E]				08.81- 08.86	CS135	12 1.1
780 2.4 Diesel	[D24TIC]	04.86- 07.90	CA900IR	14 80	04.86- 07.90	CS386	12 2.2
780 2.8	[B280E]				05.86- 07.91	CS135	12 1.1
	[B280F]				05.86- 07.91	CS135	12 1.1
850 2.0	[B5202S]	08.94- 12.96	CA1088IR	14 100 BO	08.94- 12.96	CS680	12 1.4
		08.94- 12.96	CA1096IR	14 80			
		08.94- 12.96	CA1822IR	14 100 ND			
	[B5204F]	06.91- 12.96	CA1088IR	14 100 BO	06.91- 12.96	CS680	12 1.4
		06.91- 12.96	CA1096IR	14 80			
		06.91- 12.96	CA1822IR	14 100 ND			
850 2.0 Turbo	[B5204FT]	02.93- 01.98	CA1088IR	14 100 BO	02.93- 01.98	CS680	12 1.4
		02.93- 01.98	CA1096IR	14 80			
		02.93- 01.98	CA1822IR	14 100 ND			
	[B5204T]	01.95- 07.97	CA1088IR	14 100 BO	01.95- 07.97	CS680	12 1.4
		01.95- 07.97	CA1096IR	14 80			
		01.95- 07.97	CA1822IR	14 100 ND			
850 2.3 T5	[B5234FT]	02.93- 12.96	CA1056IR	14 120	02.93- 12.96	CS680	12 1.4
		02.93- 12.96	CA1088IR	14 100 BO			
		02.93- 12.96	CA1096IR	14 80			
		02.93- 12.96	CA1822IR	14 100 ND			
850 2.3 T5R	[B5234T4]	08.95- 12.96	CA1056IR	14 120	08.95- 12.96	CS680	12 1.4
		08.95- 12.96	CA1088IR	14 100 BO			
		08.95- 12.96	CA1096IR	14 80			
		08.95- 12.96	CA1822IR	14 100 ND			
850 2.5	[B5252]	08.92- 07.94	CA1056IR	14 120	08.92- 07.94	CS680	12 1.4
		08.92- 07.94	CA1088IR	14 100 BO			
		08.92- 07.94	CA1096IR	14 80			
		08.92- 07.94	CA1822IR	14 100 ND			
	[B5252S]	08.94- 12.96	CA1056IR	14 120	08.94- 12.96	CS680	12 1.4
		08.94- 12.96	CA1088IR	14 100 BO			
		08.94- 12.96	CA1096IR	14 80			
		08.94- 12.96	CA1822IR	14 100 ND			
850 2.5 AWD	[B5254T]	04.96- 12.96	CA1056IR	14 120	04.96- 12.96	CS680	12 1.4
		04.96- 12.96	CA1088IR	14 100 BO			
		04.96- 12.96	CA1096IR	14 80			
		04.96- 12.96	CA1822IR	14 100 ND			
850 2.5 10V	[B5252]	06.91- 07.94	CA1056IR	14 120	06.91- 07.94	CS680	12 1.4
		06.91- 07.94	CA1088IR	14 100 BO			
		06.91- 07.94	CA1096IR	14 80			
		06.91- 07.94	CA1822IR	14 100 ND			
	[B5252S]	08.94- 12.96	CA1056IR	14 120	08.94- 12.96	CS680	12 1.4
		08.94- 12.96	CA1088IR	14 100 BO			
08.94- 12.96		CA1096IR	14 80				
		08.94- 12.96	CA1822IR	14 100 ND			
850 2.5 20V	[B5254S]	08.91- 12.96	CA1056IR	14 120	08.91- 12.96	CS680	12 1.4
		08.91- 12.96	CA1088IR	14 100 BO			
		08.91- 12.96	CA1096IR	14 80			
		08.91- 12.96	CA1822IR	14 100 ND			
850 2.5 TDi	[D5252T]	05.96- 08.97	CA1096IR	14 80	05.96- 08.97	CS1051	12 2.2
		05.96- 08.97	CA1204IR	14 115			
940 2.0	[B200F]	09.90- 08.91	CA903IR	14 65	01.92- 07.94	CS389	12 1.4
		01.92- 08.93	CA899IR	14 65			
		01.92- 08.93	CA905IR	14 80			
		09.93- 08.95	CA1069IR	14 100			
		AC 09.90- 08.91	CA381IR	14 80			
		AC 09.91- 08.95	CA1069IR	14 100			
		AC 09.91- 08.95	CA905IR	14 80			
940 2.0 Turbo	[B200FT]	08.90- 10.98	CA1069IR	14 100	04.96- 10.98	CS292	12 1.1
		08.90- 12.94	CA905IR	14 80			
		04.96- 10.98	CA381IR	14 80			
940 2.3	[B230FB]	08.90- 08.93	CA899IR	14 65	08.90- 12.94	JS370	12 1.2
		08.90- 12.94	CA905IR	14 80			
		AC 08.90- 12.94	CA1069IR	14 100			
	[B230FD]	08.92- 08.93	CA899IR	14 65	08.92- 07.95	CS389	12 1.4
		08.92- 08.97	CA905IR	14 80			
		AC 08.92- 08.97	CA1069IR	14 100			
	[B230G]	09.91- 07.95	CA1069IR	14 100	08.90- 07.95	CS389	12 1.4
		09.91- 08.93	CA899IR	14 65			
		09.91- 07.95	CA905IR	14 80			
	[B234F]	08.88- 08.91	CA1551IR	14 90	08.88- 07.91	CS389	12 1.4
		AC 08.88- 08.91	CA1551IR	14 90			
		AC 06.91- 07.91	CA1069IR	14 100			
	[B234G]	08.90- 08.91	CA1551IR	14 90	08.90- 07.92	JS370	12 1.2
		AC 08.90- 07.92	CA1069IR	14 100			
AC 08.90- 08.91		CA1551IR	14 90				



940 2.3 Turbo	[B230FK]	09.94- 08.97	CA9051R	14 80	01.95- 08.97	CS389	12 1.4	
		AC 09.94- 08.97	CA10691R	14 100	01.95- 08.97	JS370	12 1.2	
	[B230FT]	08.90- 12.98	CA9051R	14 80	08.90- 08.97	JS370	12 1.2	
		01.95- 12.98	CA10691R	14 100	08.90- 12.98	CS389	12 1.4	
		AC 08.90- 08.97	CA10691R	14 100				
940 2.4 Diesel	[D24]	08.90- 12.94	CA9001R	14 80	08.90- 12.94	CS386	12 2.2	
940 2.4 TD	[D24T]	08.90- 12.94	CA9001R	14 80	08.90- 12.94	CS386	12 2.2	
		09.93- 07.94	CA10691R	14 100				
940 2.4 TD Intercooler	[D24TIC]	08.90- 08.97	CA9001R	14 80	08.90- 08.97	CS386	12 2.2	
		AC 09.90- 07.97	CA10691R	14 100				
960 2.0	[B204E]	09.91- 08.93	CA3811R	14 80	09.90- 07.94	CS389	12 1.4	
		09.92- 07.94	CA15511R	14 90				
	[B204FT]	AC 09.92- 07.94	CA10691R	14 100				
		09.91- 07.94	CA10691R	14 100	09.91- 07.94	CS389	12 1.4	
960 2.4 TD Intercooler	[D24TIC]	08.90- 08.97	CA9001R	14 80	08.90- 08.97	CS386	12 2.2	
		AC 09.93- 08.97	CA10691R	14 100				
960 2.5 24V	[B6254S]	07.94- 07.97	CA10561R	14 120 ▲	07.94- 08.95	CS600	12 1.7	
					09.95- 07.97	CS1113	12 1.7	
960 2.9	[B6304F]	08.90- 08.97	CA10561R	14 120	08.95- 08.97	CS1113	12 1.7	
		08.90- 08.97	CA10881R	14 100 BO	08.90- 08.95	CS600	12 1.7	
		08.90- 08.97	CA18221R	14 100 ND				
	[B6304S]	09.94- 07.95	CA10561R	14 120	09.94- 07.95	CS600	12 1.7	
		09.94- 07.95	CA10881R	14 100 BO	09.94- 07.95	CS1113	12 1.7	
		09.94- 07.95	CA18221R	14 100 ND				
960 2.9 24V	[B6304S]	09.90- 07.97	CA10561R	14 120 ▲	08.95- 07.97	CS1113	12 1.7	
		07.94- 08.94	CA10881R	14 100	09.90- 08.95	CS600	12 1.7	
960 3.0	[B6304F]	08.90- 07.94	CA10561R	14 120	08.90- 07.94	CS1113	12 1.7	
66 DL 1.1	[B11]	12.67- 11.79	CA1651R	14 50	12.67- 01.78	CS95	12 0.6	
66 GL 1.3	[B130]	12.67- 11.79	CA1651R	14 50	12.67- 01.78	CS95	12 0.6	
C30 1.6	[B4164S3]	10.06-	CA19621R	14 120	10.06-	CS1050	12 1.1	
C30 1.6 Diesel	[D4164T]	10.06-	CA18651R	14 120	10.06-	CS1341	12 1.2	
C30 1.8	[B4184S11]	10.06-	CA18641R	14 120	10.06-	CS1403	12 1.2	
		10.06-	CA19311R	14 150				
C30 1.8 Flexfuel	[B4184S8]	01.07-	CA18641R	14 120	01.07-	CS1403	12 1.2	
		01.07-	CA19311R	14 150				
C30 2.0	[B4204S3]	10.06-	CA18641R	14 120	10.06-	CS1403	12 1.2	
		10.06-	CA19311R	14 150				
C30 2.0 FlexFuel	[B4204S4]	01.10-	CA18641R	14 120	01.10-	CS1403	12 1.2	
C30 2.0 Diesel	[D4204T]	10.06-	CA18341R	14 150	10.06-	CS1377	12 2.2	
		10.06-	CA18651R	14 120				
		10.10-	CA19681R	14 150				
	[D5204T]	10.10-	CA19681R	14 150				
	[D5204T5]	10.10-	CA19681R	14 150				
C30 2.4 i	[B5254T3]	10.06-	CA19671R	14 150 BO	10.06-	CS1430	12 1.4	
C30 2.4 Diesel D5	[D5244T13]	10.06-	CA19671R	14 150 BO	10.06-	CS1271	12 2.2	
		10.06-	CA19671R	14 150 BO	10.06-	CS1271	12 2.2	
		10.06-	CA19671R	14 150	10.06-	CS1271	12 2.2	
		10.06-	CA19671R	14 150 BO	10.06-	CS1430	12 1.4	
	[D5244T8]	10.06-	CA19671R	14 150 BO	10.06-	CS1271	12 2.2	
	[D5244T9]	10.06-	CA19671R	14 150	10.06-	CS1271	12 2.2	
C30 2.5 Turbo T5	[B5244T3]	10.06-	CA19671R	14 150 BO	10.06-	CS1430	12 1.4	
		03.07-	CA19671R	14 150 BO	03.07-	CS1430	12 1.4	
C70 2.0 20V	[B5204T2]	01.97- 08.98	CA10881R	14 100 BO	01.97- 08.98	CS680	12 1.4	
		01.97- 08.98	CA10961R	14 80				
		01.97- 08.98	CA18221R	14 100 ND				
		03.98- 07.98	CA14391R	14 120				
C70 2.0 Turbo	[B5204T3]	03.97- 08.98	CA10881R	14 100 BO	03.97- 07.00	CS680	12 1.4	
		03.97- 07.00	CA10961R	14 80				
		03.97- 07.00	CA12041R	14 115				
		03.97- 08.98	CA18221R	14 100 ND				
		08.98- 07.00	CA14391R	14 120				
	[B5204T4]	08.99- 03.06	CA14391R	14 120	08.99- 03.06	CS680	12 1.4	
C70 2.0 Diesel	[D4204T]	01.08-	CA18341R	14 150	01.08-	CS1377	12 2.2	
		01.08-	CA18651R	14 120				
		10.10-	CA19681R	14 150				
		10.10-	CA19681R	14 150				
	[D5204T]	10.10-	CA19681R	14 150				
	[D5204T5]	10.10-	CA19681R	14 150				
C70 2.3 T5	[B5234T3]	09.97- 08.98	CA10881R	14 100 BO	09.97- 09.02	CS680	12 1.4	
		09.97- 09.02	CA10961R	14 80				
		09.97- 09.02	CA12041R	14 115				
		09.97- 08.98	CA18221R	14 100 ND				
		09.98- 09.02	CA14391R	14 120				
			[B5234T9]	07.02-	CA10961R	14 80	08.98- 10.05	CS680
		08.02- 10.05	CA14391R	14 120				
		08.98- 07.02	CA12041R	14 115				
C70 2.4	[B5244S5]	03.06- 08.06	CA19661R*	14 150 ND	03.06- 07.06	CS1398	12 1.4	
		08.06-	CA19671R	14 150 BO	07.06-	CS1430	12 1.4	
C70 2.4 i	[B5244S4]	03.06- 08.06	CA19661R*	14 150 ND	03.06- 07.06	CS1398	12 1.4	
		08.06-	CA19671R	14 150 BO	03.06-	CS1430	12 1.4	
C70 2.4 Turbo	[B5244T7]	07.02-	CA10961R	14 80	08.02- 03.06	CS680	12 1.4	
		08.02- 03.06	CA12041R	14 115				
		08.02- 03.06	CA14391R	14 120				
C70 2.4 Diesel D5	[D5244T8]	03.06-	CA19671R	14 150	03.06-	CS1271	12 2.2	
C70 2.5	[B5244S]	03.99- 07.00	CA14391R	14 120	03.99- 07.00	CS680	12 1.4	
		06.98- 07.00	CA14391R	14 120	06.98- 07.00	CS680	12 1.4	
C70 2.5 T5	[D5254T3]	03.06- 08.06	CA19661R*	14 150 ND	03.06-	CS1430	12 1.4	
		08.06-	CA19671R	14 150 BO	03.06- 07.06	CS1398	12 1.4	
C70 2.5 Turbo	[B5244T]	08.99- 07.02	CA14391R	14 120	08.99- 07.02	CS680	12 1.4	
		01.98- 08.98	CA10881R	14 100 BO	01.98- 07.02	CS680	12 1.4	
		01.98- 07.99	CA10961R	14 80				
		01.98- 07.99	CA12041R	14 115				
		01.98- 08.98	CA18221R	14 100 ND				
		08.98- 07.02	CA14391R	14 120				
C70 2.5 Turbo T5	[B5254T7]	03.07-	CA19671R	14 150 BO	03.07-	CS1398	12 1.4	
P 121 1.8	[B18]				02.67- 05.71	CS140	12 1.1	
P 121 2.0	[B20A]				11.68- 05.71	CS140	12 1.1	
					09.66- 05.71	CS140	12 1.1	
P 122 S 1.8 Amazon	[B18]				09.66- 05.71	CS140	12 1.1	
					02.67- 05.71	CS140	12 1.1	
P 122 S 2.0 Amazon	[B20B]				11.68- 05.71	CS140	12 1.1	
					08.66- 07.68	CS140	12 1.1	
P 140 1.8	[B18A]				08.66- 07.68	CS140	12 1.1	
					08.68- 07.74	CS140	12 1.1	
P 140 2.0	[B20A]				08.71- 07.72	CS140	12 1.1	
					09.70- 04.75	CS140	12 1.1	
					07.67- 01.72	CS140	12 1.1	
P 140 S 1.8	[B18B]				07.67- 01.72	CS140	12 1.1	
					11.68- 09.72	CS140	12 1.1	
P 140 S 2.0	[B20B]				09.72- 08.75	CS140	12 1.1	
					08.72- 07.74	CS140	12 1.1	
P 145 2.0	[B20E]				08.72- 07.74	CS140	12 1.1	
					08.72- 07.73	CS140	12 1.1	
					09.73- 02.75	CS140	12 1.1	
	[B20F]				09.73- 02.75	CS140	12 1.1	



**VOLVO** Continued

P 145 S 2.0	[B20A]				08.68- 07.74	<b>CS140</b>	12 1.1
P 1800 1.8					04.62- 05.70	<b>CS140</b>	12 1.1
P 1800 ES 2.0	[B20E]				08.70- 07.73	<b>CS140</b>	12 1.1
					08.70- 07.73	<b>CS140</b>	12 1.1
P 262 2.7	[B27E]				08.77- 07.78	<b>CS135</b>	12 1.1
P 264 2.7	[B27A]				08.76- 07.77	<b>CS135</b>	12 1.1
	[B27E]				08.74- 07.82	<b>CS135</b>	12 1.1
P 264 2.8	[B28A]				08.79- 07.84	<b>CS135</b>	12 1.1
	[B28E]				08.79- 07.84	<b>CS135</b>	12 1.1
S40 1.6	[B4164S]	09.95- 08.99	<b>CA1088IR</b>	14 100 BO	A15 09.95- 08.99	<b>CS978</b>	12 1.7
		09.95- 08.99	<b>CA1822IR</b>	14 100 ND	09.95- 08.99	<b>CS1060</b>	12 1.1
		01.97- 08.99	<b>CA1096IR</b>	14 80	A15 09.95- 08.99	<b>CS1132</b>	12 1.4
					AT 09.95- 08.99	<b>CS1272</b>	12 1.1
					09.95- 08.99	<b>CS680</b>	12 1.4
	[B4164S2]	08.99- 01.04	<b>CA1088IR</b>	14 100 BO	08.99- 01.04	<b>CS1132</b>	12 1.4
		08.99- 01.04	<b>CA1096IR</b>	14 80	AT 08.99- 01.04	<b>CS680</b>	12 1.4
		08.99- 01.04	<b>CA1822IR</b>	14 100 ND	08.99- 01.04	<b>CS1060</b>	12 1.1
	[B4164S3]	09.04-	<b>CA1962IR</b>	14 120	01.05-	<b>CS1050</b>	12 1.1
S40 1.6 Diesel	[D4164T]	01.05-	<b>CA1865IR</b>	14 120	01.05-	<b>CS1341</b>	12 1.2
S40 1.8	[B4184S]	07.95- 08.99	<b>CA1088IR</b>	14 100 BO	A15 07.95- 08.99	<b>CS978</b>	12 1.7
		07.95- 08.99	<b>CA1096IR</b>	14 80	A15 07.95- 08.99	<b>CS1132</b>	12 1.4
		07.95- 08.99	<b>CA1822IR</b>	14 100 ND	AT 07.95- 08.99	<b>CS680</b>	12 1.4
					07.95- 08.99	<b>CS1060</b>	12 1.1
					07.95- 08.99	<b>CS1272</b>	12 1.1
	[B4184S11]	04.04-	<b>CA1864IR</b>	14 120	04.04-	<b>CS1403</b>	12 1.2
		04.04-	<b>CA1931IR</b>	14 150			
	[B4184S2]	03.99- 12.03	<b>CA1096IR</b>	14 80	03.99- 12.03	<b>CS978</b>	12 1.7
					03.99- 12.03	<b>CS1060</b>	12 1.1
					03.99- 12.03	<b>CS1132</b>	12 1.4
					03.99- 12.03	<b>CS680</b>	12 1.4
	[B4184S3]	08.99- 01.04	<b>CA1096IR</b>	14 80	AT 08.99- 01.04	<b>CS680</b>	12 1.4
		08.99- 01.04	<b>CA1673IR</b>	14 140	AT 08.99- 01.04	<b>CS1272</b>	12 1.1
					08.99- 01.04	<b>CS1060</b>	12 1.1
					08.99- 01.04	<b>CS1132</b>	12 1.4
	[B4184S9]	03.99- 01.04	<b>CA1096IR</b>	14 80	03.99- 01.04	<b>CS1060</b>	12 1.1
		03.99- 01.04	<b>CA1673IR</b>	14 140	03.99- 01.04	<b>CS1132</b>	12 1.4
					AT 03.99- 01.04	<b>CS1272</b>	12 1.1
					03.99- 01.04	<b>CS680</b>	12 1.4
S40 1.8 Flexfuel	[B4184S8]	01.06-	<b>CA1864IR</b>	14 120	01.06-	<b>CS1403</b>	12 1.2
		01.06-	<b>CA1931IR</b>	14 150			
S40 1.8 i	[B4184SJ]	06.01- 12.03	<b>JA1522IR</b>	14 100	06.01- 12.03	<b>JS1139</b>	12 1.2
	[B4184SM]	03.98- 12.01	<b>JA1522IR</b>	14 100	03.98- 12.03	<b>JS1139</b>	12 1.2
S40 1.9 T4	[B4194T]	05.97- 07.99	<b>CA1088IR</b>	14 100 BO	A15 05.97- 07.99	<b>CS1132</b>	12 1.4
		05.97- 07.99	<b>CA1096IR</b>	14 80	AT 05.97- 07.99	<b>CS680</b>	12 1.4
		05.97- 07.99	<b>CA1822IR</b>	14 100 ND	05.97- 07.99	<b>CS1272</b>	12 1.1
					A15 05.97- 07.99	<b>CS1060</b>	12 1.1
	[B4194T2]	08.99- 07.00	<b>CA1673IR</b>	14 140	AT 08.99- 07.00	<b>CS680</b>	12 1.4
					AT 08.99- 07.00	<b>CS1272</b>	12 1.1
					08.99- 07.00	<b>CS1060</b>	12 1.1
					08.99- 07.00	<b>CS1132</b>	12 1.4
S40 1.9 Diesel Di	[D4192T2]	Eng. 31034- 03.99- 07.00	<b>CA1622IR</b>	14 120	03.99- 07.00	<b>CS684</b>	12 1.7
		Eng. -31033 03.99- 07.00	<b>CA1322IR</b>	14 120			
		AC, Eng. 31034- 03.99- 07.00	<b>CA1572IR</b>	14 120			
		AC, Eng. -31033 03.99- 07.00	<b>CA1303IR</b>	14 120			
	[D4192T3]	07.00- 12.03	<b>CA1645IR</b>	14 125	07.00- 12.03	<b>CS1281</b>	12 2.1
		AC 07.00- 12.02	<b>CA1627IR</b>	14 125			
	[D4192T4]	07.00- 12.03	<b>CA1645IR</b>	14 125	07.00- 12.03	<b>CS1281</b>	12 2.1
		AC 07.00- 12.03	<b>CA1627IR</b>	14 125			
S40 1.9 TD	[D4192T]	Eng. 36181 07.95- 08.99	<b>CA1307IR#</b>	14 110	07.95- 08.99	<b>CS684</b>	12 1.7
		Eng. 36181- 05.96- 07.99	<b>CA1331IR</b>	14 80			
		Eng. -36180 05.96- 07.99	<b>CA1080IR</b>	14 80			
		Eng. -36180 05.96- 07.99	<b>CA848IR</b>	14 110			
		AC 07.95- 08.99	<b>CA1309IR</b>	14 110			
S40 2.0	[B4204S]	07.95- 08.99	<b>CA1088IR</b>	14 100 BO	A15 07.95- 08.99	<b>CS1132</b>	12 1.4
		07.95- 08.99	<b>CA1096IR</b>	14 80	AT 07.95- 08.99	<b>CS680</b>	12 1.4
		07.95- 08.99	<b>CA1822IR</b>	14 100 ND	07.95- 08.99	<b>CS1060</b>	12 1.1
					A15 07.95- 08.99	<b>CS978</b>	12 1.7
	[B4204S3]	10.06-	<b>CA1864IR</b>	14 120	10.06-	<b>CS1403</b>	12 1.2
		10.06-	<b>CA1931IR</b>	14 150			
S40 2.0 16V	[B4204S]	07.95- 07.99	<b>CA1088IR</b>	14 100 BO	A15 07.95- 07.99	<b>CS1132</b>	12 1.4
		07.95- 07.99	<b>CA1096IR</b>	14 80	AT 07.95- 07.99	<b>CS680</b>	12 1.4
		07.95- 07.99	<b>CA1822IR</b>	14 100 ND	A15 07.95- 07.99	<b>CS978</b>	12 1.7
					AT 07.95- 07.99	<b>CS1272</b>	12 1.1
					07.95- 07.99	<b>CS1060</b>	12 1.1
	[B4204S2]	07.95- 12.03	<b>CA1088IR</b>	14 100 BO	07.99- 12.03	<b>CS1060</b>	12 1.1
		07.95- 12.03	<b>CA1096IR</b>	14 80	A15 07.99- 12.03	<b>CS1132</b>	12 1.4
		07.95- 12.03	<b>CA1822IR</b>	14 100 ND	AT 07.99- 12.03	<b>CS1272</b>	12 1.1
		Chas. 964075- 07.95- 12.03	<b>CA1673IR</b>	14 140	A15 07.95- 07.99	<b>CS978</b>	12 1.7
		Chas. 415000-964074 07.95- 12.03	<b>CA1439IR</b>	14 120	AT 07.99- 12.03	<b>CS680</b>	12 1.4
S40 2.0 Turbo	[B4204T]	10.97- 07.99	<b>CA1056IR</b>	14 120	10.97- 07.00	<b>CS1060</b>	12 1.1
		08.99- 07.00	<b>CA1439IR</b>	14 120	DK, IS, N, S, SF 10.97- 07.00	<b>CS978</b>	12 1.7
		08.99- 07.00	<b>CA1673IR</b>	14 140	DK, IS, N, S, SF 10.97- 07.00	<b>CS1132</b>	12 1.4
					AT 10.97- 07.00	<b>CS680</b>	12 1.4
					10.97- 07.00	<b>CS1272</b>	12 1.1
	[B4204T3]	Chas. 964075 - 06.01- 01.04	<b>CA1673IR</b>	14 140	07.00- 01.04	<b>CS1272</b>	12 1.1
		Chas. 964075- 08.00- 07.01	<b>CA1673IR</b>	14 140			
		Chas. -964074 08.00- 07.01	<b>CA1439IR</b>	14 120			
		Chas. - 964074 06.01- 01.04	<b>CA1439IR</b>	14 120			
S40 2.0 Turbo T4	[B4204T5]				AT 07.00- 12.03	<b>CS680</b>	12 1.4
					07.00- 12.03	<b>CS1060</b>	12 1.1
					07.00- 12.03	<b>CS1132</b>	12 1.4
		Chas. 964075- 07.00- 12.03	<b>CA1673IR</b>	14 140	AT 07.00- 12.03	<b>CS1272</b>	12 1.1
S40 2.0 F	[B4204S4]	10.06-	<b>CA1864IR</b>	14 120	10.06-	<b>CS1403</b>	12 1.2
S40 2.0 Diesel	[D4204T]	01.04-	<b>CA1834IR</b>	14 150	01.04-	<b>CS1377</b>	12 2.2
		01.04-	<b>CA1865IR</b>	14 120			
S40 2.0 Diesel D3	[D5204T5]	10.10-	<b>CA1968IR</b>	14 150			
S40 2.0 Diesel D4	[D5204T]	10.10-	<b>CA1968IR</b>	14 150			
S40 2.4	[B5244S]	07.04- 08.06	<b>CA1966IR*</b>	14 150 ND	01.04-	<b>CS1398</b>	12 1.4
		08.06-	<b>CA1967IR</b>	14 150 BO			
	[B5244S5]	07.04- 08.06	<b>CA1966IR*</b>	14 150 ND	12.03-	<b>CS1398</b>	12 1.4
		08.06-	<b>CA1967IR</b>	14 150 BO			
S40 2.5 T5	[B5254T3]	07.04- 08.06	<b>CA1966IR*</b>	14 150 ND	01.04-	<b>CS1398</b>	12 1.4
		08.06-	<b>CA1967IR</b>	14 150 BO			



S40 2.5 T5 AWD	[B5254T3]	07.04-08.06	CA1966IR* CA1967IR	14 150 ND 14 150 BO	04.04-	CS1398	12 1.4
S40 2.5 Turbo T5	[B5254T7]	03.07-	CA1967IR	14 150	01.08-03.07-01.08	CS1430 CS1398	12 1.4 12 1.4
S40 2.5 Turbo T5 AWD	[B5254T7]	03.07-	CA1967IR	14 150	01.08-03.07-01.08	CS1430 CS1398	12 1.4 12 1.4
S60 2.0 T5	[B4204T6]				04.10-	CS1403	12 1.2
S60 2.0 Turbo	[B4204T6] [B5204T5]	11.00-07.04 11.00-07.04 11.00-07.04 11.00-07.04 08.04-08.04	CA1439IR CA1443IR CA1673IR CA1861IR CA1988IR CA2028IR	14 120 14 120 14 140 14 160 14 140 14 160	11.00-	CS1403 CS680	12 1.2 12 1.4
S60 2.0 Diesel D3	[D5204T2]	04.10-04.10	CA1968IR CA2001IR	14 150 14 180			
S60 2.3 T5	[B5234T3]	11.00-03.04 11.00-03.04 11.00-03.04 11.00-03.04	CA1439IR CA1443IR CA1673IR CA1861IR	14 120 14 120 14 140 14 160	11.00-03.04	CS680	12 1.4
S60 2.4	[B5244S] [B5244S2]	11.00-07.04 11.00-07.04 11.00-07.04 11.00-07.04 08.04-08.04 11.00-07.04 11.00-07.04 11.00-07.04 11.00-07.04 08.04-08.04	CA1439IR CA1443IR CA1673IR CA1861IR CA1988IR CA2028IR CA1439IR CA1443IR CA1673IR CA1861IR CA1988IR CA2028IR	14 120 14 120 14 140 14 160 14 140 14 160 14 120 14 120 14 140 14 160 14 140 14 160	11.00-	CS680	12 1.4 12 1.4
S60 2.4 T5	[B5244T5]	04.04-07.04 04.04-07.04 04.04-07.04 08.04-08.04	CA1439IR CA1673IR CA1861IR CA1988IR CA2028IR	14 120 14 140 14 160 14 140 14 160	04.04-	CS680	12 1.4
S60 2.4 Turbo	[B5244T3]	11.00-07.04 11.00-07.04 11.00-07.04 11.00-07.04	CA1439IR CA1443IR CA1673IR CA1861IR	14 120 14 120 14 140 14 160	11.00-07.04	CS680	12 1.4
S60 2.4 Turbo AWD	[B5244T3]	11.01-07.03 11.01-07.03 11.01-07.03 11.01-07.03	CA1439IR CA1443IR CA1673IR CA1861IR	14 120 14 120 14 140 14 160	11.01-07.03	CS680	12 1.4
S60 2.4 Bifuel	[B5244SG2]	06.02-07.04 06.02-07.04 06.02-07.04 06.02-07.04 08.04-07.08 08.04-07.08	CA1439IR CA1443IR CA1673IR CA1861IR CA1988IR CA2028IR	14 120 14 120 14 140 14 160 14 140 14 160	06.02-	CS680	12 1.4
S60 2.4 Diesel	[D5244T] [D5244T11] [D5244T15] [D5244T2] [D5244T5] [D5244T7]	07.01-07.04 07.01-07.04 07.01-07.04 08.04-07.06 08.04-07.06 06.11-06.11- 06.11- 08.02-07.04 08.02-07.04 08.02-07.04 08.04-07.06 01.07-01.07- 08.01-07.04 08.01-07.04 08.01-07.04 08.01-07.04 08.04-07.06 08.04-07.06	CA1445IR CA1673IR CA1861IR CA1988IR CA2028IR CA1968IR CA2001IR CA1968IR CA2001IR CA1445IR CA1673IR CA1861IR CA2028IR CA1988IR CA2028IR CA1439IR CA1443IR CA1673IR CA1861IR CA1988IR CA2028IR	14 120 14 140 14 160 14 140 14 160 14 150 14 180 14 150 14 180 14 120 14 140 14 160 14 160 14 140 14 160 14 120 14 120 14 140 14 160 14 140 14 140 14 160	Chas. 61386-07.01- Chas. -61385 07.01-  Chas. 61386-08.02- Chas. -61385 08.02-  Chas. 522429-09.05-	CS1271 CS1196  CS1271 CS1196 CS1271	12 2.2 12 2.0  12 2.2 12 2.0 12 2.2
S60 2.4 Diesel D5	[D5244T10] [D5244T4]	04.10-04.10- 09.05-09.05-	CA1968IR CA2001IR CA1988IR CA2028IR	14 150 14 180 14 140 14 160	Chas. 522429-09.05-	CS1271	12 2.2
S60 2.4 Diesel D5 AWD	[D5244T10] [D5244T11] [D5244T15]	04.10-04.10- 06.11-06.11- 06.11-06.11- 06.11-06.11-	CA1968IR CA2001IR CA1968IR CA2001IR CA1968IR CA2001IR	14 150 14 180 14 150 14 180 14 150 14 180			
S60 2.5 Turbo	[B5254T2]	04.04-07.04 04.04-07.04 08.04-08.04	CA1673IR CA1861IR CA1988IR CA2028IR	14 140 14 160 14 140 14 160	01.07-04.04-01.07	CS1430 CS680	12 1.4 12 1.4
S60 2.5 Turbo AWD	[B5254T2]	04.04-07.04 04.04-07.04 08.04-08.04	CA1673IR CA1861IR CA1988IR CA2028IR	14 140 14 160 14 140 14 160	01.07-04.04-01.07	CS1430 CS680	12 1.4 12 1.4
S60 R 2.5 Turbo AWD	[B5254T4]	03.03-07.04 03.03-07.04 03.03-07.04 03.03-07.04 08.04-07.07	CA1439IR CA1443IR CA1673IR CA1861IR CA2028IR	14 120 14 120 14 140 14 160 14 160	03.03-	CS680	12 1.4
S70 2.0	[B5202S] [B5204F]	01.97-08.98 01.97-11.00 01.97-08.98 09.98-11.00 01.97-08.98 01.97-03.00 01.97-08.98 01.97-08.98 09.98-03.00	CA1088IR CA1096IR CA1822IR CA1439IR CA1088IR CA1096IR CA1204IR CA1822IR CA1439IR	14 100 BO 14 80 14 100 ND 14 120 14 100 BO 14 80 14 115 14 100 ND 14 120	01.97-11.00 01.97-03.00	CS680 CS680	12 1.4 12 1.4



**VOLVO** Continued

	[B5204T4]	01.97- 07.00	CA1439IR	14 120		01.97- 07.00	CS680	12 1.4
S70 2.0 20V	[B5204T2]	01.97- 08.98	CA1088IR	14 100 BO		01.97- 07.98	CS680	12 1.4
		01.97- 08.98	CA1096IR	14 80				
		01.97- 08.98	CA1204IR	14 115				
		01.97- 08.98	CA1822IR	14 100 ND				
		09.98- 11.00	CA1439IR	14 120				
S70 2.0 Turbo	[B5204T]	01.97- 08.98	CA1088IR	14 100 BO		01.97- 03.00	CS680	12 1.4
		01.97- 03.00	CA1096IR	14 80				
		01.97- 03.00	CA1204IR	14 115				
		01.97- 08.98	CA1822IR	14 100 ND				
		09.98- 03.00	CA1439IR	14 120				
	[B5204T3]	01.97- 08.98	CA1088IR	14 100 BO		08.98- 11.00	CS680	12 1.4
		01.97- 11.00	CA1096IR	14 80				
		01.97- 11.00	CA1204IR	14 115				
		01.97- 08.98	CA1822IR	14 100 ND				
		09.98- 11.00	CA1439IR	14 120				
S70 2.3	[B5234T7]	04.99- 09.00	CA1439IR	14 120		04.99- 09.00	CS680	12 1.4
S70 2.3 T5	[B5234T3]	01.97- 08.98	CA1088IR	14 100 BO		01.97- 11.00	CS680	12 1.4
		01.97- 11.00	CA1096IR	14 80				
		01.97- 08.98	CA1204IR	14 115				
		01.97- 08.98	CA1822IR	14 100 ND				
		09.98- 11.00	CA1439IR	14 120				
S70 2.3 Turbo	[B5234FT]	01.97- 08.98	CA1088IR	14 100 BO		01.97- 11.00	CS680	12 1.4
		01.97- 11.00	CA1096IR	14 80				
		01.97- 08.98	CA1204IR	14 115				
		01.97- 08.98	CA1822IR	14 100 ND				
		09.98- 11.00	CA1439IR	14 120				
S70 2.4	[B5244S]	01.97- 08.98	CA1088IR	14 100 BO		01.97- 11.00	CS680	12 1.4
		01.97- 11.00	CA1096IR	14 80				
		01.97- 11.00	CA1204IR	14 115				
		01.97- 08.98	CA1822IR	14 100 ND				
		09.98- 11.00	CA1439IR	14 120				
	[B5244S2]	08.99- 07.00	CA1439IR	14 120		08.99- 07.00	CS680	12 1.4
	[B5244SG]	08.99- 07.00	CA1439IR	14 120		08.99- 07.00	CS680	12 1.4
	[B5252S]	01.97- 08.98	CA1088IR	14 100 BO		01.97- 11.00	CS680	12 1.4
		01.97- 11.00	CA1096IR	14 80				
		01.97- 11.00	CA1204IR	14 115				
		01.97- 08.98	CA1822IR	14 100 ND				
		09.98- 11.00	CA1439IR	14 120				
	[B5254S]	01.97- 08.98	CA1088IR	14 100 BO		01.97- 07.99	CS680	12 1.4
		01.97- 07.99	CA1096IR	14 80				
		01.97- 07.99	CA1204IR	14 115				
		01.97- 08.98	CA1822IR	14 100 ND				
		09.98- 07.99	CA1439IR	14 120				
	[GB5252S]	10.98- 11.00	CA1096IR	14 80		10.98- 11.00	CS680	12 1.4
		10.98- 11.00	CA1204IR	14 115				
		10.98- 11.00	CA1439IR	14 120				
S70 2.4 AWD	[B5244S2]	04.99- 09.00	CA1439IR	14 120		04.99- 09.00	CS680	12 1.4
	[B5252FS]	11.96- 05.99	CA1088IR	14 100 BO		11.96- 05.99	CS680	12 1.4
		11.96- 05.99	CA1096IR	14 80				
		11.96- 05.99	CA1204IR	14 115				
		11.96- 05.99	CA1439IR	14 120				
		11.96- 05.99	CA1822IR	14 100 ND				
		10.98- 05.99	CA1822IR	14 100 ND		10.98- 05.99	CS680	12 1.4
		10.98- 05.99	CA1439IR	14 120				
		10.98- 05.99	CA1204IR	14 115				
		10.98- 05.99	CA1096IR	14 80				
		10.98- 05.99	CA1088IR	14 100 BO				
S70 2.4 Turbo	[B5244T]	01.99- 07.00	CA1439IR	14 120		01.99- 07.00	CS680	12 1.4
	[B5254T]	01.97- 08.98	CA1088IR	14 100 BO		01.97- 11.00	CS680	12 1.4
		01.97- 11.00	CA1096IR	14 80				
		01.97- 11.00	CA1204IR	14 115				
		01.97- 08.98	CA1822IR	14 100 ND				
		09.98- 11.00	CA1439IR	14 120				
S70 2.4 Blu-Fuel	[B5244S2]	07.97- 09.00	CA1088IR	14 100 BO		07.97- 09.00	CS680	12 1.4
		07.97- 09.00	CA1096IR	14 80				
		07.97- 09.00	CA1204IR	14 115				
		07.97- 09.00	CA1439IR	14 120				
		07.97- 09.00	CA1822IR	14 100 ND				
S70 2.5 Bifuel	[B5244SG]	07.99- 11.00	CA1204IR	14 115		07.99- 11.00	CS680	12 1.4
		07.99- 11.00	CA1439IR	14 120				
S70 2.5 TDi	[D5252T]	01.97- 11.00	CA1204IR	14 115		01.97- 11.00	CS1051	12 2.2
		01.97- 11.00	CA1445IR	14 120				
		01.97- 11.00	CA1673IR	14 140				
S70 2.5 TDi AWD	[D5252T]	10.99- 09.00	CA1204IR	14 115		10.99- 09.00	CS1051	12 2.2
		10.99- 09.00	CA1260IR	14 120				
		10.99- 09.00	CA1445IR	14 120				
		10.99- 09.00	CA1673IR	14 140				
S80 1.6 Diesel DRiVe	[D4164T]					01.10-	CS1341	12 1.2
						01.10-	CS1377	12 2.2
S80 2.0	[B4204S3]	01.08-	CA1923IR	14 150		01.08-	CS1403	12 1.2
	[B5204T4]	06.98- 07.00	CA1443IR	14 120		06.98- 07.00	CS680	12 1.4
		06.98- 07.00	CA1673IR	14 140				
S80 2.0 T5	[B4204T7]					10.10-	CS1403	12 1.2
S80 2.0 FlexFuel	[B4204S4]	01.08-	CA1923IR	14 150		01.08-	CS1403	12 1.2
S80 2.0 Turbo	[B4204T6]					01.10-	CS1403	12 1.2
	[B5204T3]	06.98- 07.00	CA1443IR	14 120		06.98- 07.00	CS680	12 1.4
		06.98- 07.00	CA1673IR	14 140				
	[B5204T5]	08.04- 07.06	CA1988IR	14 140		08.99- 07.06	CS680	12 1.4
		08.04- 07.06	CA2028IR	14 160				
		08.99- 08.04	CA1443IR	14 120				
		08.99- 07.04	CA1673IR	14 140				
		08.99- 07.04	CA1861IR	14 160				
		12.99- 08.04	CA1439IR	14 120				
S80 2.0 Diesel D3	[D5204T2]	01.10-	CA1968IR	14 150		01.10-	CS1271	12 2.2
		01.10-	CA2001IR	14 180				
S80 2.4	[B5244S]	01.99- 07.06	CA1439IR	14 120		01.99- 07.06	CS680	12 1.4
		01.99- 07.06	CA1443IR	14 120				
		01.99- 07.06	CA1673IR	14 140				
		01.99- 07.06	CA1861IR	14 160				
	[B5244S2]	01.99- 07.06	CA1439IR	14 120		01.99- 07.06	CS680	12 1.4
		01.99- 07.06	CA1443IR	14 120				
		01.99- 07.06	CA1673IR	14 140				
		01.99- 07.06	CA1861IR	14 160				





S80 2.4 T5 AWD	[B5244T3]	04.00- 09.03	CA1443IR	14 120		04.00- 09.03	CS680	12 1.4
		04.00- 09.03	CA1673IR	14 140				
S80 2.4 Turbo	[B5244T3]	06.00- 07.03	CA1439IR	14 120		06.00- 07.03	CS680	12 1.4
		06.00- 07.03	CA1443IR	14 120				
		06.00- 07.03	CA1673IR	14 140				
		06.00- 07.03	CA1861IR	14 160				
S80 2.4 Bifuel	[B5244SG2]	09.01- 07.04	CA1439IR	14 120		09.01- 07.06	CS680	12 1.4
		09.01- 07.04	CA1443IR	14 120				
		09.01- 07.04	CA1673IR	14 140				
		09.01- 07.04	CA1861IR	14 160				
		08.04- 07.06	CA1988IR	14 140				
		08.04- 07.06	CA2028IR	14 160				
S80 2.4 Diesel	[D5244T14]	01.10-	CA1968IR	14 150		01.10-	CS1271	12 2.2
		01.10-	CA2001IR	14 180				
	[D5244T2]	10.01- 07.06	CA1445IR	14 120		10.01- 07.06	CS1196	12 2.0
		10.01- 07.06	CA1673IR	14 140				
		10.01- 07.06	CA1861IR	14 160				
	[D5244T5]	03.06- 03.06-	CA1968IR CA2001IR	14 150 14 180		03.06-	CS1271	12 2.2
S80 2.4 Diesel D5	[D5244T]	08.01- 07.06	CA1673IR	14 140		08.01- 07.06	CS1196	12 2.0
		08.01- 07.06	CA1861IR	14 160				
	[D5244T10]	01.10-	CA1968IR	14 150		01.10-	CS1271	12 2.2
		01.10-	CA2001IR	14 180				
	[D5244T11]	06.11-	CA1968IR	14 150		06.11-	CS1271	12 2.2
		06.11-	CA2001IR	14 180				
[D5244T15]	06.11- 06.11-	CA1968IR CA2001IR	14 150 14 180		06.11-	CS1271	12 2.2	
S80 2.4 Diesel D5 AWD	[D5244T10]	01.10-	CA1968IR	14 150		01.10-	CS1271	12 2.2
		01.10-	CA2001IR	14 180				
	[D5244T11]	06.11-	CA1968IR	14 150		06.11-	CS1271	12 2.2
		06.11-	CA2001IR	14 180				
	[D5244T15]	06.11- 06.11-	CA1968IR CA2001IR	14 150 14 180		06.11-	CS1271	12 2.2
		01.07- 01.07-	CA1968IR CA2001IR	14 150 14 180		01.07-	CS1271	12 2.2
S80 2.5 Turbo FlexFuel	[B5254T8]	05.08- 05.08-	CA2001IR CA1968IR	14 180 14 150	Chas. 42020-	05.08-	CS1430	12 1.4
S80 2.5 Turbo	[B5254T10]	01.10-	CA1968IR	14 150		01.10-	CS1430	12 1.4
		01.10-	CA2001IR	14 180				
	[B5254T2]	07.03- 07.04	CA1673IR	14 140		07.03- 07.06	CS680	12 1.4
		07.03- 07.04	CA1861IR	14 160				
		08.04- 07.06	CA1988IR	14 140				
		08.04- 07.06	CA2028IR	14 160				
[B5254T6]	03.06- 08.06-	CA2001IR CA1968IR	14 180 14 150		08.06-	CS1430	12 1.4	
S80 2.5 Turbo AWD	[B5254T2]	07.03- 07.04	CA1673IR	14 140		07.03- 07.06	CS680	12 1.4
		07.03- 07.04	CA1861IR	14 160				
		08.04- 07.06	CA1988IR	14 140				
		08.04- 07.06	CA2028IR	14 160				
		01.10-	CA1968IR	14 150		01.10-	CS1430	12 1.4
S80 2.5 Turbo FlexFuel	[B5254T11]	01.10-	CA2001IR	14 180				
S80 2.5 TDi	[D5252T]	08.98- 08.01	CA1445IR	14 120		08.98- 08.01	CS1196	12 2.0
		01.99- 08.01	CA1673IR	14 140				
S80 2.8 T6	[B6284T]	05.98- 07.01	CA1443IR	14 120		05.98- 07.01	CS1113	12 1.7
S80 2.9	[B6294S]	03.99- 07.01	CA1443IR	14 120				
		03.99- 07.01	CA1673IR	14 140				
S80 2.9 24V	[B6304S3]	05.98- 08.99	CA1443IR	14 120		05.98- 08.99	CS1113	12 1.7
		05.98- 08.99	CA1673IR	14 140				
S80 3.0	[B6294S2]	08.01- 07.06	CA1439IR	14 120				
		08.01- 07.06	CA1443IR	14 120				
		08.01- 07.06	CA1673IR	14 140				
S80 3.0 T6	[B6294T]	06.01- 07.06	CA1439IR	14 120				
		06.01- 07.06	CA1443IR	14 120				
		06.01- 07.06	CA1673IR	14 140				
S90 2.5	[B6244FS]	11.96- 10.97	CA1056IR	14 120		11.96- 10.97	CS1113	12 1.7
	[B6254FS]	11.96- 10.98	CA1056IR	14 120		11.96- 10.98	CS1113	12 1.7
S90 2.9	[B6304G]	01.97- 05.98	CA1056IR	14 120		01.97- 05.98	CS1113	12 1.7
	[B6304S2]	01.97- 05.98	CA1056IR	14 120		01.97- 05.98	CS1113	12 1.7
V40 1.6	[B4164S]	12.95- 08.99	CA1088IR	14 100 BO	DK, IS, N, S, SF	12.95- 08.99	CS978	12 1.7
		12.95- 08.99	CA1822IR	14 100 ND	DK, IS, N, S, SF	12.95- 08.99	CS1132	12 1.4
		01.97- 08.99	CA1096IR	14 80		AT 12.95- 08.99	CS1272	12 1.1
						AT 12.95- 08.99	CS680	12 1.4
						12.95- 08.99	CS1060	12 1.1
	[B4164S2]	03.99- 04.04	CA1088IR	14 100 BO		AT 03.99- 04.04	CS680	12 1.4
		03.99- 04.04	CA1096IR	14 80		A15 03.99- 04.04	CS978	12 1.7
		03.99- 04.04	CA1822IR	14 100 ND		A15 03.99- 04.04	CS1132	12 1.4
						03.99- 04.04	CS1060	12 1.1
V40 1.8	[B4184S]	07.95- 08.99	CA1088IR	14 100 BO		A15 07.95- 08.99	CS978	12 1.7
		07.95- 08.99	CA1096IR	14 80		AT 07.95- 08.99	CS1272	12 1.1
		07.95- 08.99	CA1822IR	14 100 ND		AT 07.95- 08.99	CS680	12 1.4
						A15 07.95- 08.99	CS1132	12 1.4
						07.95- 08.99	CS1060	12 1.1
	[B4184S2]	03.99- 04.04	CA1096IR	14 80		AT 03.99- 04.04	CS1272	12 1.1
						A15 03.99- 04.04	CS1132	12 1.4
						03.99- 04.04	CS978	12 1.7
						AT 03.99- 04.04	CS680	12 1.4
						03.99- 04.04	CS1060	12 1.1
[B4184S3]	08.99- 04.04	CA1096IR	14 80		AT 08.99- 04.04	CS680	12 1.4	
					AT 08.99- 04.04	CS1272	12 1.1	
					08.99- 04.04	CS1060	12 1.1	
					08.99- 04.04	CS1132	12 1.4	
[B4184S9]	03.99- 04.04	CA1096IR	14 80		A15 03.99- 04.04	CS978	12 1.7	
					A15 03.99- 04.04	CS1132	12 1.4	
					AT 03.99- 04.04	CS1272	12 1.1	
					03.99- 04.04	CS680	12 1.4	
V40 1.8 i	[B4181SM]	03.98- 12.01	JA1522IR	14 100		03.98- 12.01	JS1139	12 1.2
	[B4184SJ]	06.01- 01.05	JA1522IR	14 100		06.01- 01.05	JS1139	12 1.2



**VOLVO** Continued

V40 1.9 T4	[B4194T]	05.97- 07.99	CA1056IR	14 120	A15 05.97- 07.99	CS1132	12 1.4
		05.97- 07.99	CA1096IR	14 80	05.97- 07.99	CS1060	12 1.1
		05.97- 07.99	CA1439IR	14 120	AT 05.97- 07.99	CS680	12 1.4
V40 1.9 Diesel Di	[D4192T2]	Eng. 31034- 08.98- 07.00	CA1622IR	14 120	08.98- 07.00	CS684	12 1.7
		Eng. -31033 08.98- 07.00	CA1322IR	14 120			
		AC, Eng. 31034- 08.98- 07.00	CA1572IR	14 120			
	[D4192T3]	AC, Eng. -31033 08.98- 07.00	CA1303IR	14 120			
		03.00- 04.04	CA1645IR	14 125	03.00- 04.04	CS1281	12 2.1
[D4192T4]	AC 03.00- 04.04	CA1627IR	14 125	03.00- 12.00	CS684	12 1.7	
V40 1.9 TD	[D4192T]	03.00- 04.04	CA1645IR	14 125	03.00- 04.04	CS1281	12 2.1
		AC 03.00- 04.04	CA1627IR	14 125	03.00- 12.00	CS684	12 1.7
		Eng. 36181- 07.95- 08.99	CA1307IR#	14 110	07.95- 08.99	CS684	12 1.7
		Eng. 36181- 07.95- 08.99	CA1331IR	14 80			
		Eng. -36180 07.95- 08.99	CA1080IR	14 80			
V40 2.0	[B4204S]	Eng. -36180 07.95- 08.99	CA848IR	14 110			
		AC 07.95- 08.99	CA1309IR	14 110			
		07.95- 08.99	CA1088IR	14 100 BO	A15 07.95- 08.99	CS1132	12 1.4
		07.95- 08.99	CA1096IR	14 80	AT 07.95- 08.99	CS680	12 1.4
		07.95- 08.99	CA1822IR	14 100 ND	A15 07.95- 08.99	CS978	12 1.7
V40 2.0 16V	[B4204S2]				AT 07.95- 08.99	CS1272	12 1.1
		07.95- 04.04	CA1088IR	14 100 BO	07.95- 04.04	CS1060	12 1.1
		07.95- 04.04	CA1096IR	14 80	A15 07.95- 04.04	CS978	12 1.7
		07.95- 04.04	CA1822IR	14 100 ND	AT 07.95- 04.04	CS1272	12 1.1
		Chas. 964075- 07.95- 04.04	CA1673IR	14 140	A15 07.95- 04.04	CS1132	12 1.4
V40 2.0 Turbo 16V	[B4204T]	Chas. 415000-964074 07.95- 04.04	CA1439IR	14 120	AT 07.95- 04.04	CS680	12 1.4
		10.97- 07.00	CA1439IR	14 120	A15 04.98- 07.99	CS1132	12 1.4
		10.97- 07.00	CA1673IR	14 140	AT 04.98- 07.99	CS1272	12 1.1
		04.98- 07.99	CA1088IR	14 100 BO	AT 04.98- 07.99	CS680	12 1.4
		04.98- 07.99	CA1096IR	14 80	04.98- 07.99	CS1060	12 1.1
V40 2.0 Turbo	[B4204T2]	04.98- 07.99	CA1822IR	14 100 ND			
		08.99- 07.00	CA1096IR	14 80	A34 07.00- 07.00	CS680	12 1.4
		Chas. 964075- 08.99- 07.00	CA1673IR	14 140	A34 07.00- 07.00	CS1272	12 1.1
		Chas. 415000-964074 08.99- 07.00	CA1439IR	14 120			
		Chas. -414999 08.99- 07.00	CA1056IR	14 120			
V40 2.0 Turbo T4	[B4204T5]	06.01- 04.04	CA1673IR	14 140	AT 06.01- 04.04	CS680	12 1.4
					AT 06.01- 04.04	CS1272	12 1.1
					06.01- 04.04	CS1132	12 1.4
		Chas. - 964074 08.00- 04.04	CA1439IR	14 120	06.01- 04.04	CS1060	12 1.1
		07.00- 04.04	CA1439IR	14 120	07.00- 04.04	CS1060	12 1.1
V50 1.6	[B4164S3]	07.00- 04.04	CA1673IR	14 140	A15 07.00- 04.04	CS1132	12 1.4
					AT 07.00- 04.04	CS1272	12 1.1
					07.00- 04.04	CS680	12 1.4
					01.05-	CS1050	12 1.1
V50 1.6 Diesel	[D4164T]	01.05-	CA1834IR	14 150	01.05-	CS1341	12 1.2
		01.05-	CA1865IR	14 120			
V50 1.6 Diesel D2	[D4162T]				01.10-	CS1377	12 2.2
V50 1.8	[B4184S11]	04.04-	CA1864IR	14 120	04.04-	CS1403	12 1.2
		04.04-	CA1931IR	14 150			
V50 1.8 FlexFuel	[B4184S8]	01.05-	CA1864IR	14 120	01.05-	CS1403	12 1.2
		01.05-	CA1931IR	14 150			
V50 2.0	[B4204S3]	10.06-	CA1864IR	14 120	10.06-	CS1403	12 1.2
		10.06-	CA1931IR	14 150			
V50 2.0 Flexfuel	[B4204S4]	01.10-	CA1864IR	14 120	01.10-	CS1403	12 1.2
V50 2.0 Diesel	[D4204T]	04.04-	CA1834IR	14 150	04.04-	CS1377	12 2.2
		04.04-	CA1865IR	14 120			
V50 2.0 Diesel D3	[D5204T5]	10.10-	CA1968IR	14 150			
V50 2.0 Diesel D4	[D5204T]	10.10-	CA1968IR	14 150			
V50 2.4	[B5244S]	04.04-	CA1967IR	14 150 BO	01.07-	CS1430	12 1.4
		07.04- 08.06	CA1966IR*	14 150 ND	04.04- 01.07	CS1398	12 1.4
		07.04- 08.06	CA1966IR*	14 150 ND	04.04- 01.07	CS1398	12 1.4
		08.06-	CA1967IR	14 150 BO	01.07-	CS1430	12 1.4
		08.06-	CA1966IR*	14 150 ND	04.04-	CS1398	12 1.4
V50 2.5 T5	[B5254T3]	04.04- 08.06	CA1966IR*	14 150 ND	04.04-	CS1398	12 1.4
		08.06-	CA1967IR	14 150 BO			
V50 2.5 T5 AWD	[B5254T3]	07.04- 08.06	CA1966IR*	14 150 ND	04.04-	CS1398	12 1.4
		08.06-	CA1967IR	14 150 BO			
V50 2.5 Turbo T5	[B5254T7]	03.07-	CA1967IR	14 150	03.07-	CS1430	12 1.4
					03.07- 01.08	CS1398	12 1.4
V50 2.5 Turbo T5 AWD	[B5254T7]				01.08-	CS1430	12 1.4
					03.07- 01.08	CS1398	12 1.4
V60 2.0 T5	[B4204T7]				09.10-	CS1403	12 1.2
V60 2.0 Turbo	[B4204T6]				09.10-	CS1403	12 1.2
V60 2.0 Diesel D3	[D5204T2]	09.10-	CA1968IR	14 150			
V60 2.4 Diesel D5	[D5244T10]	09.10-	CA1968IR	14 150			
V60 2.4 Diesel D5 AWD	[D5244T10]	09.10-	CA1968IR	14 150			
V70 1.6 D5 AWD	[B4164T]				A25 10.10-	CS1403	12 1.2
					10.10-	CS1403	12 1.2
					01.11-	CS1403	12 1.2
V70 1.6 T4F	[B4164T2]				01.10-	CS1341	12 1.2
V70 1.6 Diesel DRIVe	[D4164T]				01.10-	CS1377	12 2.2
V70 2.0	[B4204S3]	10.07-	CA1923IR	14 150	10.07-	CS1403	12 1.2
		01.97- 08.98	CA1088IR	14 100 BO	01.97- 03.00	CS680	12 1.4
		01.97- 03.00	CA1096IR	14 80			
		01.97- 08.98	CA1822IR	14 100 ND			
	[B5202S]	09.98- 03.00	CA1439IR	14 120			
		01.97- 08.98	CA1088IR	14 100 BO	01.97- 03.00	CS680	12 1.4
		01.97- 03.00	CA1096IR	14 80			
		01.97- 03.00	CA1204IR	14 115			
		01.97- 08.98	CA1822IR	14 100 ND			
		09.98- 03.00	CA1439IR	14 120			
[B5204T4]	01.97- 03.00	CA1439IR	14 120	01.97- 03.00	CS680	12 1.4	
V70 2.0 T6 AWD	[B4204T7]				01.10-	CS1403	12 1.2
V70 2.0 20V	[B5204T2]	01.97- 08.98	CA1088IR	14 100 BO	01.97- 08.98	CS680	12 1.4
		01.97- 08.98	CA1096IR	14 80			
		01.97- 08.98	CA1204IR	14 115			
		01.97- 08.98	CA1822IR	14 100 ND			
V70 2.0 FlexFuel	[B4204S4]	01.08-	CA1923IR	14 150	01.08-	CS1403	12 1.2
V70 2.0 Turbo	[B4204T6]				01.10-	CS1403	12 1.2
					01.97- 03.00	CS680	12 1.4
		03.00- 03.00	CA1673IR	14 140			
[B5204T]	01.97- 08.98	CA1088IR	14 100 BO				
	01.97- 03.00	CA1096IR	14 80				
	01.97- 03.00	CA1096IR	14 80				



		01.97- 03.00	CA1204IR	14 115			
		01.97- 08.98	CA1822IR	14 100 ND			
		09.98- 03.00	CA1439IR	14 120			
	[B5204T3]	01.97- 08.98	CA1088IR	14 100 BO	01.97- 08.99	CS680	12 1.4
		01.97- 08.99	CA1096IR	14 80			
		01.97- 08.99	CA1204IR	14 115			
		01.97- 08.98	CA1822IR	14 100 ND			
		09.98- 08.99	CA1439IR	14 120			
	[B5204T5]	03.00- 07.04	CA1439IR	14 120	03.00- 07.07	CS680	12 1.4
		03.00- 07.04	CA1673IR	14 140			
		03.00- 07.04	CA1861IR	14 160			
		08.04- 07.07	CA1988IR	14 140			
		08.04- 07.07	CA2028IR	14 160			
V70 2.0 Turbo AWD	[B5204T3]	01.97- 08.98	CA1088IR	14 100 BO	01.97- 08.99	CS680	12 1.4
		01.97- 08.99	CA1096IR	14 80			
		01.97- 08.99	CA1204IR	14 115			
		01.97- 08.98	CA1822IR	14 100 ND			
		09.98- 08.99	CA1439IR	14 120			
V70 2.0 Diesel	[D4204T]	10.07-	CA2000IR	14 150	10.07-	CS1377	12 2.2
V70 2.0 Diesel D5 AWD	[D5204T2]	03.10-	CA1968IR	14 150	03.10- 07.11	CS1271	12 2.2
V70 2.3	[B5234FT]	01.97- 08.98	CA1088IR	14 100 BO	01.97- 03.00	CS680	12 1.4
		01.97- 03.00	CA1096IR	14 80			
		01.97- 03.00	CA1204IR	14 115			
		01.97- 08.98	CA1822IR	14 100 ND			
		09.98- 03.00	CA1439IR	14 120			
	[B5234T7]	10.00- 09.04	CA1439IR	14 120	10.00- 09.04	CS680	12 1.4
V70 2.3 4x4	[B5234T3]	04.97- 09.98	CA1088IR	14 100	04.97- 09.98	CS680	12 1.4
		04.97- 09.98	CA1096IR	14 80			
		04.97- 09.98	CA1204IR	14 115			
		04.97- 09.98	CA1439IR	14 120			
V70 2.3 T5	[B5234T3]	03.00- 07.04	CA1443IR	14 120	01.97- 07.04	CS680	12 1.4
		03.00- 07.04	CA1673IR	14 140			
		03.00- 07.04	CA1861IR	14 160			
		01.97- 08.98	CA1088IR	14 100 BO			
		01.97- 08.98	CA1822IR	14 100 ND			
		09.98- 07.04	CA1439IR	14 120			
	[B5234T4]	03.00- 07.04	CA1439IR	14 120	03.00- 07.04	CS680	12 1.4
		03.00- 07.04	CA1443IR	14 120			
		03.00- 07.04	CA1673IR	14 140			
		03.00- 07.04	CA1861IR	14 160			
V70 2.3 T5 AWD	[B5234T3]	01.97- 08.98	CA1088IR	14 100 BO	01.97- 03.00	CS680	12 1.4
		01.97- 03.00	CA1096IR	14 80			
		01.97- 03.00	CA1204IR	14 115			
		01.97- 08.98	CA1822IR	14 100 ND			
		09.98- 03.00	CA1439IR	14 120			
V70 2.3 Turbo AWD	[B5234FT]	04.97- 08.98	CA1088IR	14 100 BO	04.97- 03.00	CS680	12 1.4
		04.97- 08.98	CA1822IR	14 100 ND			
		09.98- 03.00	CA1439IR	14 120			
V70 2.4	[B5244S]	03.00- 07.04	CA1439IR	14 120	03.00- 07.07	CS680	12 1.4
		03.00- 07.04	CA1443IR	14 120			
		03.00- 07.04	CA1673IR	14 140			
		03.00- 07.04	CA1861IR	14 160			
		08.04- 07.07	CA1988IR	14 140			
		08.04- 07.07	CA2028IR	14 160			
	[B5244S2]	03.00- 07.04	CA1439IR	14 120	03.00- 07.07	CS680	12 1.4
		03.00- 07.04	CA1443IR	14 120			
		03.00- 07.04	CA1673IR	14 140			
		03.00- 07.04	CA1861IR	14 160			
		08.04- 07.07	CA1988IR	14 140			
		08.04- 07.07	CA2028IR	14 160			
	[B5252S]	01.97- 08.98	CA1088IR	14 100 BO	01.97- 03.00	CS680	12 1.4
		01.97- 08.98	CA1822IR	14 100 ND			
		09.98- 03.00	CA1439IR	14 120			
	[B5254S]	01.97- 08.98	CA1088IR	14 100 BO	01.97- 03.00	CS680	12 1.4
		01.97- 08.98	CA1822IR	14 100 ND			
		06.98- 03.00	CA1096IR	14 80			
		06.98- 03.00	CA1204IR	14 115			
		09.98- 03.00	CA1439IR	14 120			
	[GB5244S2]	08.99- 03.00	CA1439IR	14 120	08.99- 03.00	CS680	12 1.4
	[GB5244SG2]	08.99- 03.00	CA1439IR	14 120	08.99- 03.00	CS680	12 1.4
V70 2.4 4x4		10.98- 05.99	CA1822IR	14 100 ND	10.98- 05.99	CS680	12 1.4
		10.98- 05.99	CA1439IR	14 120			
		10.98- 05.99	CA1088IR	14 100 BO			
V70 2.4 Turbo	[B5244T]	01.97- 08.98	CA1088IR	14 100 BO	01.97- 03.00	CS680	12 1.4
		01.97- 03.00	CA1096IR	14 80			
		01.97- 03.00	CA1204IR	14 115			
		01.97- 08.98	CA1822IR	14 100 ND			
		09.98- 03.00	CA1439IR	14 120			
	[B5244T3]	03.00- 07.02	CA1439IR	14 120	03.00- 07.02	CS680	12 1.4
		03.00- 07.02	CA1443IR	14 120			
		03.00- 07.02	CA1673IR	14 140			
		03.00- 07.02	CA1861IR	14 160			
	[B5254T]	01.97- 08.98	CA1088IR	14 100 BO	01.97- 03.00	CS680	12 1.4
		01.97- 03.00	CA1096IR	14 80			
		01.97- 03.00	CA1204IR	14 115			
		01.97- 08.98	CA1822IR	14 100 ND			
		09.98- 03.00	CA1439IR	14 120			
V70 2.4 Turbo AWD	[B5244T]	01.97- 08.98	CA1088IR	14 100 BO	01.97- 03.00	CS680	12 1.4
		01.97- 03.00	CA1096IR	14 80			
		01.97- 03.00	CA1204IR	14 115			
		01.97- 08.98	CA1822IR	14 100 ND			
		09.98- 03.00	CA1439IR	14 120			
	[B5244T3]	03.00- 07.03	CA1439IR	14 120	03.00- 07.03	CS680	12 1.4
		03.00- 07.03	CA1443IR	14 120			
		03.00- 07.03	CA1673IR	14 140			
		03.00- 07.03	CA1861IR	14 160			
	[B5254T]	01.97- 08.98	CA1088IR	14 100 BO	01.97- 03.00	CS680	12 1.4
		01.97- 03.00	CA1096IR	14 80			
		01.97- 03.00	CA1204IR	14 115			
		01.97- 08.98	CA1822IR	14 100 ND			
		09.98- 03.00	CA1439IR	14 120			



**VOLVO** Continued

V70 2.4 Turbo T5	[B5244T5]	04.04- 07.04	CA1439IR	14 120		04.04- 07.07	CS680	12 1.4	
		04.04- 07.04	CA1673IR	14 140					
		04.04- 07.04	CA1861IR	14 160					
		08.04- 07.07	CA1988IR	14 140					
		08.04- 07.07	CA2028IR	14 160					
V70 2.4	[GB5252S]	10.98- 08.99	CA1204IR	14 115		10.98- 08.99	CS680	12 1.4	
		10.98- 08.99	CA1439IR	14 120					
V70 2.4 Bifuel	[B5244SG]	09.01- 07.04	CA1443IR	14 120		08.99- 07.06	CS680	12 1.4	
		09.01- 07.04	CA1861IR	14 160					
		08.04- 07.07	CA1988IR	14 140					
		08.04- 07.07	CA2028IR	14 160					
		08.99- 03.00	CA1204IR	14 115					
		08.99- 07.04	CA1439IR	14 120					
		08.99- 07.04	CA1673IR	14 140					
V70 2.4 Diesel	[D5244T]	08.01- 07.04	CA1445IR	14 120	Chas. FC1/126990-, FC2/116323-	08.01- 07.06	CS1271	12 2.2	
		08.01- 07.04	CA1673IR	14 140	Chas. -FC1/126989, -FC2/116322	08.01- 07.06	CS1196	12 2.0	
		08.01- 07.04	CA1861IR	14 160					
		08.04- 07.06	CA1988IR	14 140					
		08.04- 07.06	CA2028IR	14 160					
		08.04- 07.06	CA1988IR	14 140					
		[D5244T10]	12.09-	CA1968IR	14 150				
			12.09-	CA2001IR	14 180				
		[D5244T14]	10.09- 07.10	CA2001IR	14 180				
		[D5244T2]	12.01- 07.04	CA1445IR	14 120	Chas. 1126990-, 2116323-	12.01- 07.06	CS1271	12 2.2
			12.01- 07.04	CA1673IR	14 140	Chas. -1126989, -2116322	12.01- 07.06	CS1196	12 2.0
			12.01- 07.04	CA1861IR	14 160				
			07.04- 07.06	CA2028IR	14 160				
			08.04- 07.06	CA1988IR	14 140				
	[D5244T5]	03.06-	CA1968IR	14 150		03.06-	CS1271	12 2.2	
		03.06-	CA2001IR	14 180					
V70 2.4 Diesel AWD	[D5244T10]	12.09-	CA1968IR	14 150					
		12.09-	CA2001IR	14 180					
V70 2.4 Diesel D5	[D5244T]	08.01- 07.04	CA1445IR	14 120	Chas. -FC1/126989, - 08.01-		CS1196	12 2.0	
					FC2/116322				
		08.01- 07.04	CA1673IR	14 140	Chas. FC1/126990- 08.01-		CS1271	12 2.2	
					FC1/555148,				
					FC2/116323-FC2/554220				
			08.01- 07.04	CA1861IR	14 160				
			08.04- 07.06	CA1988IR	14 140				
			08.04- 07.06	CA2028IR	14 160				
		[D5244T11]	06.11-	CA1968IR	14 150		06.11-	CS1271	12 2.2
		[D5244T15]	06.11-	CA1968IR	14 150		06.11-	CS1271	12 2.2
		[D5244T4]	12.05- 07.07	CA1988IR	14 140	Chas. FC1/126990-, FC2/116323-	12.05- 07.06	CS1271	12 2.2
			12.05- 07.07	CA2028IR	14 160	Chas. -FC1/126989, -FC2/116322	12.05- 07.06	CS1196	12 2.0
		[D5244T5]	08.07-	CA1968IR	14 150		08.07-	CS1271	12 2.2
		08.07-	CA2001IR	14 180					
V70 2.4 Diesel D5 AWD	[D5244T11]	06.11-	CA1968IR	14 150		06.11-	CS1271	12 2.2	
	[D5244T15]	06.11-	CA1968IR	14 150		06.11-	CS1271	12 2.2	
	[D5244T2]	12.01- 07.04	CA1445IR	14 120		12.01- 07.06	CS1196	12 2.0	
		12.01- 07.04	CA1673IR	14 140		12.01- 07.06	CS1271	12 2.2	
		12.01- 07.04	CA1861IR	14 160					
		08.04- 07.06	CA1988IR	14 140					
		08.04- 07.06	CA2028IR	14 160					
		[D5244T4]	12.05- 07.07	CA1988IR	14 140		12.05- 07.06	CS1196	12 2.0
			12.05- 07.07	CA2028IR	14 160		10.07-	CS1271	12 2.2
			10.07-	CA1968IR	14 150				
		10.07-	CA2001IR	14 180					
V70 2.5 AWD	[B5244T2]	03.99- 03.00	CA1204IR	14 115		03.99- 03.00	CS680	12 1.4	
		03.99- 03.00	CA1439IR	14 120					
V70 2.5 Turbo FlexFuel	[B5254T8]	05.08-	CA1968IR	14 150	Chas. 42020-	05.08-	CS1430	12 1.4	
		05.08-	CA2001IR	14 180					
V70 2.5 Turbo	[B5254T10]	01.10-	CA1968IR	14 150		01.10-	CS1430	12 1.4	
	[B5254T2]	04.04- 07.04	CA1439IR	14 120		04.04- 07.07	CS680	12 1.4	
		04.04- 07.04	CA1673IR	14 140					
		04.04- 07.04	CA1861IR	14 160					
		08.04-	CA1988IR	14 140					
		08.04-	CA2028IR	14 160					
	[B5254T6]	08.07-	CA1968IR	14 150		08.07-	CS1430	12 1.4	
		08.07-	CA2001IR	14 180					
V70 2.5 Turbo AWD	[B5254T2]	09.02- 07.04	CA1439IR	14 120		09.02- 07.07	CS680	12 1.4	
		09.02- 07.04	CA1673IR	14 140					
		09.02- 07.04	CA1861IR	14 160					
		08.04- 07.07	CA1988IR	14 140					
		08.04-	CA2028IR	14 160					
V70 2.5 Turbo R AWD	[B5254T4]	03.03- 07.04	CA1439IR	14 120		03.03- 07.07	CS680	12 1.4	
		03.03- 07.04	CA1673IR	14 140					
		03.03- 07.04	CA1861IR	14 160					
		08.04- 07.07	CA1988IR	14 140					
		08.04- 07.07	CA2028IR	14 160					
V70 2.5 Turbo FlexiFuel	[B5254T11]	10.09-	CA1968IR	14 150		10.09-	CS1430	12 1.4	
		10.09-	CA2001IR	14 180					
V70 2.5 TDi	[D5252T]	03.00- 07.01	CA1861IR	14 160		03.00- 07.01	CS1196	12 2.0	
		01.97- 03.00	CA1204IR	14 115		01.97- 07.01	CS1051	12 2.2	
		01.97- 03.00	CA1260IR	14 120					
		01.97- 07.01	CA1445IR	14 120					
		01.97- 07.01	CA1673IR	14 140					
V70 2.5 TDi AWD	[D5252T]	11.96- 02.00	CA1204IR	14 115		11.96- 02.00	CS1051	12 2.2	
		11.96- 02.00	CA1260IR	14 120					
		11.96- 02.00	CA1445IR	14 120					
		11.96- 02.00	CA1673IR	14 140					
V90 2.5	[B6244FS]	11.96- 10.97	CA1056IR	14 120		11.96- 10.97	CS1113	12 1.7	
	[B6254FS]	11.96- 10.98	CA1056IR	14 120		11.96- 10.98	CS1113	12 1.7	
V90 2.9	[B6304G]	01.97- 12.98	CA1056IR	14 120		01.97- 12.98	CS1113	12 1.7	
	[B6304S2]	01.97- 12.98	CA1056IR	14 120		01.97- 12.98	CS1113	12 1.7	
XC60 2.0 T5	[B4204T7]					09.10-	CS1403	12 1.2	
XC60 2.0 Turbo	[B4204T6]					03.10-	CS1403	12 1.2	
XC60 2.0 Diesel DRiVe	[D5204T2]	03.10-	CA1968IR	14 150					
		03.10-	CA2001IR	14 180					
XC60 2.4 Diesel	[D5244T11]	06.11-	CA1968IR	14 150		06.11-	CS1271	12 2.2	
		06.11-	CA2001IR	14 180					
	[D5244T5]	05.08-	CA1968IR	14 150		05.08-	CS1271	12 2.2	
		05.08-	CA2001IR	14 180					
XC60 2.4 Diesel D5	[D5244T4]	05.08-	CA1968IR	14 150		05.08-	CS1271	12 2.2	
		05.08-	CA2001IR	14 180					



XC60 2.4 Diesel D5 AWD	[D5244T10]	07.09-07.09-	CA1968IR	14 150		07.09-	CS1271	12 2.2
			CA2001IR	14 180				
	[D5244T11]	06.11-06.11-	CA1968IR	14 150		06.11-	CS1271	12 2.2
			CA2001IR	14 180				
XC60 2.4 Diesel DRIVE	[D5244T14]	07.09-07.09-	CA1968IR	14 150		07.09-	CS1271	12 2.2
			CA2001IR	14 180				
XC70 2.0 Diesel	[D5204T2]	08.11-08.11-	CA1968IR	14 150		08.11-	CS1271	12 2.2
			CA2001IR	14 180				
XC70 2.0 Diesel AWD	[D5204T2]	08.11-08.11-	CA1968IR	14 150		08.11-	CS1271	12 2.2
			CA2001IR	14 180				
XC70 2.4 AWD	[B5254T]	11.97-07.98	CA1096IR	14 80		11.97-03.00	CS680	12 1.4
		11.97-03.00	CA1204IR	14 115				
		11.97-03.00	CA1439IR	14 120				
XC70 2.4 Turbo AWD	[B5244T3]	03.00-09.02	CA1861IR	14 160		09.00-09.02	CS680	12 1.4
		09.00-09.02	CA1439IR	14 120				
		09.00-09.02	CA1443IR	14 120				
		09.00-09.02	CA1673IR	14 140				
XC70 2.4 Diesel	[D5244T10]	12.09-12.09-	CA1968IR	14 150		12.09-	CS1271	12 2.2
			CA2001IR	14 180				
	[D5244T14]	01.10-01.10-	CA1968IR	14 150		01.10-	CS1271	12 2.2
			CA2001IR	14 180				
XC70 2.4 Diesel AWD	[D5244T]	09.02-07.04	CA1445IR	14 120		Chas. 38344-09.02-07.06	CS1271	12 2.2
		09.02-07.04	CA1673IR	14 140		Chas. -38343 09.02-07.06	CS1196	12 2.0
		09.02-07.04	CA1861IR	14 160				
		08.04-07.06	CA1988IR	14 140				
		CA2028IR	14 160					
	[D5244T5]	08.07-08.07-	CA1968IR	14 150		08.07-	CS1271	12 2.2
		CA2001IR	14 180					
XC70 2.4 Diesel D5 AWD	[D5244T11]	06.11-06.11-	CA1968IR	14 150		06.11-	CS1271	12 2.2
			CA1968IR	14 150		06.11-	CS1271	12 2.2
	[D5244T15]	12.05-07.07	CA1988IR	14 140		08.07-	CS1271	12 2.2
		12.05-07.07	CA2028IR	14 160		12.05-07.06	CS1196	12 2.0
		08.07-08.07-	CA1968IR	14 150				
		CA2001IR	14 180					
XC70 2.5 Turbo AWD	[B5254T2]	09.02-07.04	CA1673IR	14 140		09.02-07.07	CS680	12 1.4
		09.02-07.04	CA1861IR	14 160				
		08.04-07.07	CA1988IR	14 140				
		08.04-07.07	CA2028IR	14 160				
XC90 2.4 D5	[D5244T5]	04.09-04.09-	CA1988IR	14 140		04.09-	CS1271	12 2.2
			CA2028IR	14 160				
XC90 2.4 Diesel	[D5244T]	08.02-07.04	CA1445IR	14 120		Chas. -38343 08.02-07.06	CS1196	12 2.0
		08.02-07.04	CA1673IR	14 140		Chas. 38344-08.02-07.06	CS1271	12 2.2
		08.02-07.04	CA1861IR	14 160				
		08.04-07.06	CA1988IR	14 140				
		08.04-07.06	CA2028IR	14 160				
XC90 2.4 Diesel D5	[D5244T]	01.03-07.04	CA1673IR	14 140		01.03-07.06	CS1271	12 2.2
		01.03-07.04	CA1861IR	14 160				
		08.04-07.06	CA1988IR	14 140				
		08.04-07.06	CA2028IR	14 160				
	[D5244T18]	01.11-01.11-	CA1988IR	14 140		01.11-	CS1271	12 2.2
			CA2028IR	14 160				
[D5244T4]	05.05-05.05-	CA1988IR	14 140		12.05-07.06	CS1271	12 2.2	
		CA2028IR	14 160					
XC90 2.5 Turbo	[B5254T2]	10.02-07.04	CA1673IR	14 140		10.02-	CS680	12 1.4
		10.02-07.04	CA1861IR	14 160				
		08.04-08.04-	CA1988IR	14 140				
			CA2028IR	14 160				
XC90 3.0 Turbo	[B6294T]	01.03-07.06	CA1673IR	14 140				
		01.03-07.06	CA1861IR	14 160				
<b>PASSENGER CARS US</b>								
122 1.8 S	[B18]					01.68-01.68	CS140	12 1.1
						01.62-01.67	CS140	12 1.1
142 1.8 S	[B18]					01.68-01.68	CS140	12 1.1
142 2.0	[B20B]					01.70-01.71	CS140	12 1.1
	[B20E]					01.72-01.74	CS140	12 1.1
142 2.0 E	[B20B]					01.71-01.71	CS140	12 1.1
142 2.0 GL	[B20E]					01.74-01.74	CS140	12 1.1
142 2.0 S	[B20B]					01.69-01.69	CS140	12 1.1
144 1.8 S	[B18]					01.68-01.68	CS140	12 1.1
						01.67-01.67	CS140	12 1.1
144 2.0	[B20B]					01.70-01.71	CS140	12 1.1
	[B20E]					01.72-01.74	CS140	12 1.1
						01.74-01.74	CS140	12 1.1
144 2.0 GL	[B20E]					01.69-01.69	CS140	12 1.1
144 2.0 S	[B20B]					01.68-01.68	CS140	12 1.1
145 1.8 S	[B18]					01.70-01.71	CS140	12 1.1
145 2.0	[B20B]					01.72-01.74	CS140	12 1.1
	[B20E]					01.69-01.69	CS140	12 1.1
145 2.0 S	[B20B]					01.70-01.71	CS140	12 1.1
164 3.0	[B30A]					01.70-01.71	CS140	12 1.1
	[B30E]					01.72-01.75	CS140	12 1.1
164 3.0 E	[B30E]					01.73-01.74	CS140	12 1.1
240 2.3	[B230F]	01.90-01.93	CA3811R	14 80		01.90-01.93	CS389	12 1.4
240 2.3 DL	[B230F]	01.90-01.90	CA3811R	14 80		01.90-01.90	CS389	12 1.4
			CA3811R	14 80		01.92-01.92	CS389	12 1.4
240 2.3 GL	[B230F]	01.92-01.92	CA3811R	14 80		01.91-01.91	CS389	12 1.4
240 2.3 SE	[B230F]	01.91-01.91	CA3811R	14 80				
242 2.0 GL	[B20E]					01.75-01.75	CS140	12 1.1
242 2.1	[B21F]					01.76-01.79	CS140	12 1.1
						01.81-01.81	CS140	12 1.1
242 2.1 DL	[B21F]	01.81-01.81	CA88IR	14 55				
			CA811IR	14 55				
		01.80-01.82	CA811IR	14 55		01.80-01.82	CS140	12 1.1
		01.80-01.82	CA88IR	14 55				
		01.83-01.83	CA811IR	14 55		01.83-01.83	CS140	12 1.1
		01.83-01.83	CA88IR	14 55				
242 2.1 GL	[B21F]	01.81-01.81	CA811IR	14 55		01.81-01.81	CS140	12 1.1
			CA88IR	14 55				
242 2.1 GLT		01.82-01.82	CA811IR	14 55		01.82-01.82	CS140	12 1.1
			CA88IR	14 55				
242 2.1 Turbo	[B21FT]	01.81-01.81	CA811IR	14 55		01.81-01.81	CS140	12 1.1
			CA88IR	14 55				
242 2.1 Turbo GLT	[B21FT]	01.81-01.84	CA811IR	14 55		01.81-01.84	CS140	12 1.1
			CA88IR	14 55				



**VOLVO** *Continued*

242 2.3 DL	[B23F]	01.83- 01.84 CA811IR	14 55	01.83- 01.84 CS140	12 1.1
		01.83- 01.84 CA88IR	14 55		
242 2.3 GLT		01.83- 01.83 CA88IR	14 55	01.83- 01.83 CS140	12 1.1
		01.83- 01.83 CA811IR	14 55		
244 2.0 GL	[B20E]			01.75- 01.75 CS140	12 1.1
244 2.1	[B21F]			01.76- 01.78 CS140	12 1.1
		01.81- 01.81 CA88IR	14 55	01.81- 01.81 CS140	12 1.1
		01.81- 01.81 CA811IR	14 55		
244 2.1 DL	[B21F]	01.79- 01.82 CA811IR	14 55	01.79- 01.82 CS140	12 1.1
		01.79- 01.82 CA88IR	14 55		
		01.83- 01.84 CA811IR	14 55	01.83- 01.84 CS140	12 1.1
		01.83- 01.84 CA88IR	14 55		
244 2.1 GL	[B21F]	01.82- 01.82 CA811IR	14 55	01.82- 01.82 CS140	12 1.1
		01.82- 01.82 CA88IR	14 55		
244 2.1 Turbo GLT	[B21FT]	01.82- 01.84 CA811IR	14 55	01.82- 01.84 CS140	12 1.1
		01.82- 01.84 CA88IR	14 55		
244 2.3 DL	[B230F]	01.85- 01.89 CA381IR	14 80	01.85- 01.89 CS140	12 1.1
				01.85- 01.89 CS389	12 1.4
	[B23F]	01.83- 01.84 CA811IR	14 55	01.83- 01.84 CS140	12 1.1
		01.83- 01.84 CA88IR	14 55		
244 2.3 GL	[B230F]	01.85- 01.89 CA381IR	14 80	01.85- 01.89 CS389	12 1.4
				01.85- 01.89 CS140	12 1.1
	[B23F]	01.84- 01.84 CA811IR	14 55	01.84- 01.84 CS140	12 1.1
		01.84- 01.84 CA88IR	14 55		
		01.83- 01.83 CA88IR	14 55	01.83- 01.83 CS140	12 1.1
		01.83- 01.83 CA811IR	14 55		
244 2.4 DL	[D24]	01.82- 01.84 CA238IR	14 55	01.82- 01.84 CS386	12 2.2
244 2.4 GL	[D24]	01.82- 01.84 CA238IR	14 55	01.82- 01.84 CS386	12 2.2
245 2.0	[B20E]			01.75- 01.75 CS140	12 1.1
245 2.1	[B21F]			01.76- 01.78 CS140	12 1.1
		01.81- 01.81 CA88IR	14 55	01.81- 01.81 CS140	12 1.1
		01.81- 01.81 CA811IR	14 55		
245 2.1 DL	[B21F]	01.79- 01.82 CA811IR	14 55	01.79- 01.82 CS140	12 1.1
		01.79- 01.82 CA88IR	14 55		
		01.83- 01.84 CA88IR	14 55	01.83- 01.84 CS140	12 1.1
		01.83- 01.84 CA811IR	14 55		
245 2.1 GL	[B21F]	01.82- 01.82 CA811IR	14 55	01.82- 01.82 CS140	12 1.1
		01.82- 01.82 CA88IR	14 55		
245 2.1 Turbo	[B21FT]	01.85- 01.85 CA811IR	14 55	01.85- 01.85 CS140	12 1.1
		01.85- 01.85 CA88IR	14 55		
245 2.1 Turbo GLT	[B21FT]	01.81- 01.84 CA811IR	14 55	01.81- 01.84 CS140	12 1.1
		01.81- 01.84 CA88IR	14 55		
245 2.3	[B230F]	01.85- 01.85 CA381IR	14 80	01.85- 01.85 CS140	12 1.1
				01.85- 01.85 CS389	12 1.4
	[B23F]	01.84- 01.84 CA811IR	14 55	01.84- 01.84 CS140	12 1.1
		01.84- 01.84 CA88IR	14 55		
245 2.3 DL	[B230F]	01.86- 01.89 CA381IR	14 80	01.86- 01.89 CS389	12 1.4
				01.86- 01.89 CS140	12 1.1
	[B23F]	01.83- 01.83 CA811IR	14 55	01.83- 01.83 CS140	12 1.1
		01.83- 01.83 CA88IR	14 55		
245 2.3 GL	[B230F]	01.86- 01.89 CA381IR	14 80	01.86- 01.89 CS140	12 1.1
				01.86- 01.89 CS389	12 1.4
	[B23F]	01.83- 01.83 CA811IR	14 55	01.83- 01.83 CS140	12 1.1
		01.83- 01.83 CA88IR	14 55		
245 2.4	[D24]	01.84- 01.84 CA238IR	14 55	01.84- 01.84 CS386	12 2.2
245 2.4 DL	[D24]	01.82- 01.82 CA238IR	14 55	01.82- 01.82 CS386	12 2.2
245 2.4 GL	[D24]	01.83- 01.83 CA238IR	14 55	01.83- 01.83 CS386	12 2.2
264 2.4 GL	[D24]			01.80- 01.81 CS188	12 2.0
264 2.4 GLE	[D24]			01.80- 01.80 CS188	12 2.0
265 2.4 GLE	[D24]			01.80- 01.80 CS188	12 2.0
544 1.8				01.62- 01.65 CS140	12 1.1
740 2.3	[B230F]	01.90- 01.92 CA381IR	14 80	01.90- 01.92 CS389	12 1.4
740 2.3 GL	[B230F]	01.89- 01.90 CA381IR	14 80	01.89- 01.90 CS389	12 1.4
740 2.3 GLE	[B230F]	01.85- 01.88 CA811IR	14 55	01.87- 01.89 CS389	12 1.4
		01.87- 01.89 CA381IR	14 80	01.85- 01.86 CS140	12 1.1
	[B234F]	01.90- 01.90 CA1551IR	14 90	01.90- 01.90 CS389	12 1.4
740 2.3 Turbo	[B230FT]			01.89- 01.92 CS389	12 1.4
740 2.3 Turbo GLE	[B230FT]	01.86- 01.86 CA811IR	14 55	01.86- 01.88 CS389	12 1.4
740 2.3 Turbo SE	[B230FT]			01.91- 01.91 CS389	12 1.4
740 2.4 Turbo GLE	[D24T]	01.86- 01.86 CA238IR	14 55	01.86- 01.86 CS386	12 2.2
745 2.3 GLE	[B230F]	01.85- 01.85 CA811IR	14 55	01.85- 01.85 CS140	12 1.1
745 2.3 Turbo GLE	[B230FT]	01.85- 01.85 CA811IR	14 55	01.85- 01.85 CS140	12 1.1
745 2.4 Turbo GLE	[D24T]	01.85- 01.85 CA238IR	14 55	01.85- 01.85 CS386	12 2.2
760 2.3 Turbo	[B230FT]	01.85- 01.85 CA811IR	14 55	01.89- 01.90 CS389	12 1.4
		01.89- 01.90 CA381IR	14 80	01.85- 01.85 CS140	12 1.1
760 2.3 Turbo GLE	[B230FT]	01.85- 01.87 CA811IR	14 55	01.88- 01.88 CS389	12 1.4
		01.88- 01.88 CA381IR	14 80	01.85- 01.87 CS140	12 1.1
	[B23FT]	01.84- 01.84 CA811IR	14 55	01.84- 01.84 CS140	12 1.1
	[D24]	01.83- 01.84 CA238IR	14 55	01.83- 01.84 CS386	12 2.2
760 2.4 GLE	[D24]			01.83- 01.84 CS386	12 2.2
760 2.4 Turbo GLE	[D24T]	01.83- 01.85 CA238IR	14 55	01.83- 01.85 CS386	12 2.2
780 2.3 Turbo	[B230FT]			01.89- 01.90 CS389	12 1.4
850 2.3 Turbo	[B5234FT]			01.94- 01.94 CS680	12 1.4
				01.95- 01.96 CS680	12 1.4
850 2.3 Turbo R	[B5254FT]	01.97- 01.97 CA1088IR	14 100		
		01.97- 01.97 CA1088IR	14 100	01.97- 01.97 CS680	12 1.4
850 2.3 Turbo T-5	[B5234T]	01.97- 01.97 CA1088IR	14 100		
850 2.4	[B5254FS]	01.97- 01.97 CA1088IR	14 100	01.93- 01.94 CS680	12 1.4
850 2.4 GLT	[B5254FS]			01.95- 01.96 CS680	12 1.4
850 2.4 Turbo GLT	[B52354F]	01.97- 01.97 CA1088IR	14 100		
940 2.3	[B230FD]	01.94- 01.95 CA381IR	14 80	01.94- 01.95 CS389	12 1.4
940 2.3 GLE	[B230F]	01.91- 01.91 CA1551IR	14 90	01.91- 01.91 CS389	12 1.4
940 2.3 Turbo	[B230FT]			01.91- 01.95 CS389	12 1.4
				01.92- 01.92 CS389	12 1.4
940 2.3 Turbo SE	[B230FT]			01.91- 01.91 CS389	12 1.4
960 2.9	[B6304F]	09.90- 08.94 CA1088IR	14 100	09.90- 08.95 CS600	12 1.7
		09.90- 08.94 CA1822IR	14 100	09.95- 07.97 CS1113	12 1.7
		09.94- 07.97 CA1056IR	14 120		
1800 1.8	[B18B]			01.67- 01.67 CS140	12 1.1
				01.62- 01.65 CS140	12 1.1
1800 1.8 S	[B18]			01.68- 01.68 CS140	12 1.1
1800 2.0 E	[B20E]			01.70- 01.72 CS140	12 1.1
1800 2.0 ES	[B20E]			01.72- 01.73 CS140	12 1.1
1800 2.0 S	[B20B]			01.69- 01.69 CS140	12 1.1
C70 2.3 Turbo	[B5234T3]	01.02- 01.03 CA1439IR	14 120	01.02- 01.03 CS680	12 1.4



C70 2.4	[B5254FS]	01.98- 01.98 01.98- 01.98	CA1088IR CA1096IR	14 100 14 80			
C70 2.4 Turbo	[B5244T]				01.02- 01.02	CS680	12 1.4
DL 2.1	[B21A]	01.84- 01.84 01.84- 01.84	CA8111R CA88IR	14 55 14 55	01.84- 01.84	CS140	12 1.1
GLE 2.3	[B23F-LH]	01.84- 01.84 01.84- 01.84	CA8111R CA88IR	14 55 14 55	01.84- 01.84	CS140	12 1.1
S40 2.4 I	[B5244S4]	01.05- 01.05-	CA1966IR* CA1967IR	14 150 ND 14 150 BO			
S60 2.3 Turbo	[B5234FT]	01.01- 01.01	CA1443IR	14 120			
S60 2.3 Turbo T5	[B5234T3]	01.02- 01.03 01.02- 01.03	CA1439IR CA1443IR	14 120 14 120	01.02- 01.03	CS680	12 1.4
S60 2.4	[B5244S]				01.02- 01.03	CS680	12 1.4
S60 2.4 Turbo	[B5244T3]				01.02- 01.02	CS680	12 1.4
S70 2.3 Turbo	[B5234FT]	01.98- 01.00 01.98- 01.00	CA1088IR CA1096IR	14 100 14 80			
S70 2.4	[B5254FS]	01.98- 01.98 01.98- 01.98 01.99- 01.00	CA1088IR CA1096IR CA1439IR	14 100 14 80 14 120			
S70 2.4 Turbo		01.99- 01.00	CA1439IR	14 120			
S70 2.4 Turbo GLT	[B5254FT]	01.98- 01.98 01.98- 01.98	CA1088IR CA1096IR	14 100 14 80			
S80 2.8 Turbo	[B6284T]	01.99- 01.03	CA1443IR	14 120	01.99- 01.03	CS1113	12 1.7
S80 2.9	[B6294S]				01.02- 01.03	CS1113	12 1.7
S90 2.9	[B6304F]				08.97- 05.98	CS1113	12 1.7
V50 2.4 I	[B5244S4]	01.05-	CA1966IR*	14 150 ND			
V70 2.3 Turbo	[B5234FT]	01.99- 01.01	CA1439IR	14 120			
V70 2.3 Turbo T5	[B5234T3]	01.02- 01.03	CA1439IR	14 120	01.02- 01.03	CS680	12 1.4
V70 2.4	[B5244S]				01.02- 01.03	CS680	12 1.4
	[B5244S6]	01.03- 07.04 01.03- 07.04 01.03- 07.04 01.03- 07.04 08.04- 08.04-	CA1439IR CA1443IR CA1673IR CA1861IR CA1988IR CA2028IR	14 120 14 120 14 140 14 160 14 140 14 160			
	[B5254FS]	01.98- 01.98 01.98- 01.98 01.99- 01.00	CA1088IR CA1096IR CA1439IR	14 100 14 80 14 120			
V70 2.4 Turbo	[B5244T3]				01.02- 01.02	CS680	12 1.4
V70 2.4 Turbo X/C	[B5244T3]				01.02- 01.02	CS680	12 1.4
V90 2.9	[B6304F]				01.98- 07.98	CS1113	12 1.7
XC90 2.5 Turbo	[B5254T2]	01.03- 07.04 01.03- 07.04 01.03- 07.04 01.03- 07.04 07.04- 07.04-	CA1439IR CA1443IR CA1673IR CA1861IR CA1988IR CA2028IR	14 120 14 120 14 140 14 160 14 140 14 160			
<b>PASSENGER CARS AO</b>							
740 2.0	[B200F]	09.90- 08.92 AC 09.90- 08.92	CA903IR CA381IR	14 65 14 80	09.90- 08.92	CS389	12 1.4
740 2.0 GLE	[B204E]	09.87- 08.90	CA1551IR	14 90	09.87- 08.90	CS389	12 1.4
740 2.0 Turbo	[B200ET]	09.87- 08.90	CA1069IR	14 100	09.87- 08.90	CS389	12 1.4
	[B200FT]	09.90- 08.91	CA1069IR	14 100	09.90- 08.91	CS389	12 1.4
740 2.3 Turbo	[B230FT]	09.89- 08.91	CA1069IR	14 100	09.89- 08.91	CS389	12 1.4
760 2.3 Turbo	[B230FT]	09.87- 07.92	CA1069IR	14 100	09.87- 07.92	CS389	12 1.4
850 2.0 Turbo	[B5204T2]	09.93- 10.97 09.93- 10.97 09.93- 10.97	CA1088IR CA1096IR CA1822IR	14 100 BO 14 80 14 100 ND	09.93- 10.97	CS680	12 1.4
850 2.3 T5 R	[B5234T2]	04.96- 10.96 04.96- 10.96	CA1088IR CA1096IR	14 100 14 80	04.96- 10.96	CS680	12 1.4
850 2.3 T5R	[B5234T2]	04.96- 07.97 AC 04.96- 07.97	CA1096IR CA1088IR	14 80 14 100	04.96- 07.97	CS680	12 1.4
850 2.3 Turbo R	[B5234T5]	06.95- 10.97 06.95- 10.97 06.95- 10.97	CA1088IR CA1096IR CA1822IR	14 100 BO 14 80 14 100 ND	06.95- 10.97	CS680	12 1.4
850 2.4 GLE	[B5254T]	09.93- 10.97 09.93- 10.97 09.93- 10.97	CA1088IR CA1096IR CA1822IR	14 100 BO 14 80 14 100 ND	09.93- 10.97	CS680	12 1.4
940 2.0	[B200G]	09.90- 12.95 09.90- 09.93 09.90- 12.95 09.90- 12.95	CA1069IR CA1551IR CA899IR CA905IR	14 100 14 90 14 65 14 80	09.90- 12.95	CS389	12 1.4
	[B204FT]	09.90- 05.97	CA1551IR	14 90	09.90- 05.97	CS389	12 1.4
940 2.0 GL	[B204E]	09.90- 04.92 09.90- 04.92 09.90- 04.92	CA1069IR CA1551IR CA899IR	14 100 14 90 14 65	09.90- 04.92	CS389	12 1.4
940 2.0 GLT	[B200GT]	10.94- 05.97 10.94- 05.97	CA1069IR CA905IR	14 100 14 80	10.94- 05.97	CS389	12 1.4
940 2.3	[B230GK]	10.94- 05.97	CA1069IR	14 100	10.94- 05.97	CS389	12 1.4
960 2.3 Turbo	[B230FT]	09.90- 08.93 09.90- 08.93	CA1069IR CA905IR	14 100 14 80	09.90- 08.93	CS389	12 1.4
960 2.8 GL	[B280E] [B280F]				09.90- 07.91 09.90- 07.91	CS135 CS135	12 1.1 12 1.1
S 60 2.4 AWD	[B5244T5]	02.04- 07.04 02.04- 07.04 02.04- 07.04 08.04- 08.04-	CA1439IR CA1673IR CA1861IR CA1988IR CA2028IR	14 120 14 140 14 160 14 140 14 160	02.04-	CS680	12 1.4
S40 1.8		06.01- 08.03 06.01- 08.03	CA1096IR CA1673IR	14 80 14 140	06.01- 08.03 AT 06.01- 08.03	CS1060 CS1272	12 1.1 12 1.1
					06.01- 08.03 AT 06.01- 08.03	CS1132 CS680	12 1.4 12 1.4
S40 2.0	[B4204S3]	03.06- 03.06-	CA1864IR CA1931IR	14 120 14 150	03.06-	CS1403	12 1.2
S40 2.4 Diesel	[D5244T8]	03.06- 08.06 08.06-	CA1966IR* CA1967IR	14 150 ND 14 150 BO	03.06-	CS1271	12 2.2
S60 2.3 T5	[B5234T7]	07.00- 03.04 07.00- 03.04 07.00- 03.04 07.00- 03.04	CA1439IR CA1443IR CA1673IR CA1861IR	14 120 14 120 14 140 14 160	07.00- 03.04	CS680	12 1.4
S70 2.3 AWD	[B5234T7]	04.99- 09.00	CA1439IR	14 120	04.99- 09.00	CS680	12 1.4
S70 2.3 T5 GLT AWD	[B5234T3]	11.96- 09.98 11.96- 09.98	CA1088IR CA1439IR	14 100 14 120	11.96- 09.98	CS680	12 1.4



**VOLVO** Continued

S70 2.3 T5 R AWD	[B5234T2]	11.96- 09.98	CA1088IR	14	100	11.96- 09.98	CS680	12	1.4
		11.96- 09.98	CA1439IR	14	120				
S70 2.3 T5 Sport AWD	[B5234T4]	07.97- 09.00	CA1088IR	14	100	07.97- 09.00	CS680	12	1.4
S70 2.4 T5 Sport AWD	[B5254T]	11.96- 04.99	CA1439IR	14	120	11.96- 04.99	CS680	12	1.4
S80 2.0 TDi	[D4204T]	02.08-	CA2000IR	14	150	02.08-	CS1377	12	2.2
S80 2.3 R	[B5234T7]	04.00- 07.04	CA1439IR	14	120	04.00- 08.05	CS680	12	1.4
		04.00- 07.04	CA1443IR	14	120				
		04.00- 07.04	CA1673IR	14	140				
		04.00- 07.04	CA1861IR	14	160				
		08.04- 08.05	CA1988IR	14	140				
S80 2.4 LTP	[B5244T4]	06.04- 07.06	CA1439IR	14	120	06.04- 07.06	CS680	12	1.4
		06.04- 07.06	CA1443IR	14	120				
		06.04- 07.06	CA1673IR	14	140				
		06.04- 07.06	CA1861IR	14	160				
		08.04- 07.06	CA1988IR	14	140				
S80 2.5 Turbo AWD	[B5254T6]	10.06-	CA1968IR	14	150	10.06-	CS1430	12	1.4
		10.06-	CA2001IR	14	180				
V50 2.4 Diesel	[D5244T8]	03.06- 08.06	CA1966IR*	14	150 ND	03.06-	CS1271	12	2.2
		08.06-	CA1967IR	14	150 BO				
V70 2.3 AWD	[B5234T7]	12.98- 09.04	CA1439IR	14	120	12.98- 09.04	CS680	12	1.4
		12.98- 09.04	CA1439IR	14	120				
V70 2.4	[B5234T8]	03.00- 09.03	CA1439IR	14	120	03.00- 09.03	CS680	12	1.4
		03.00- 09.03	CA1673IR	14	140				
		03.00- 09.03	CA1443IR	14	120				
		03.00- 09.03	CA1861IR	14	160				
V70 2.5 R Sport	[B5254T4]	12.02- 07.04	CA1439IR	14	120	12.02- 07.07	CS680	12	1.4
		12.02- 07.04	CA1443IR	14	120				
		12.02- 07.04	CA1673IR	14	140				
		12.02- 07.04	CA1861IR	14	160				
		08.04- 07.07	CA1988IR	14	140				
V70 2.5 Turbo	[B5254T6]	08.07-	CA1968IR	14	150	08.07-	CS1430	12	1.4
		08.07-	CA2001IR	14	180				
<b>TRUCKS EU</b>									
8700 12.1	[DH12D340]	01.99-	CA1667IR	28	140	01.99- A10 01.99-	CS1388 CS1472*	24	4.5 MI
		01.99-	CA1670IR	28	180				
		01.99-	CA1853IR	28	80				
		01.99-	CA1883IR	28	110				
		01.99-	CA907IR	28	80				
	[DH12D380]	01.99-	CA1667IR	28	140	01.99- A10 01.99-	CS1388 CS1472*	24	4.5 MI
		01.99-	CA1670IR	28	180				
		01.99-	CA1853IR	28	80				
		01.99-	CA1883IR	28	110				
		01.99-	CA907IR	28	80				
	[DH12E340]	01.99-	CA1667IR	28	140	01.99- A10 01.99-	CS1388 CS1472*	24	4.5 MI
		01.99-	CA1670IR	28	180				
		01.99-	CA1853IR	28	80				
		01.99-	CA1883IR	28	110				
		01.99-	CA907IR	28	80				
[DH12E380]	01.99-	CA1667IR	28	140	A10 01.99- 01.99-	CS1472* CS1388	24	4.5 MI	
	01.99-	CA1670IR	28	180					
	01.99-	CA1853IR	28	80					
	01.99-	CA1883IR	28	110					
	01.99-	CA907IR	28	80					
9700 12.1	[DH12D340]	04.01-	CA1667IR	28	140	A10 04.01- 04.01-	CS1472* CS1388	24	4.5 MI
		04.01-	CA1670IR	28	180				
		04.01-	CA1853IR	28	80				
		04.01-	CA1883IR	28	110				
		04.01-	CA907IR	28	80				
	[DH12D380]	04.01-	CA1853IR	28	80	A10 04.01- 04.01-	CS1472* CS1388	24	4.5 MI
		10.01-	CA1667IR	28	140				
		10.01-	CA1883IR	28	110				
		10.01-	CA907IR	28	80				
		10.01-	CA1853IR	28	80				
	[DH12D420]	04.01-	CA1853IR	28	80	A10 04.01- 04.01-	CS1472* CS1388	24	4.5 MI
		10.01-	CA1667IR	28	140				
		10.01-	CA1670IR	28	180				
		10.01-	CA1883IR	28	110				
		10.01-	CA1853IR	28	80				
[DH12E460]	10.07-	CA1853IR	28	80	A10 10.01- 10.01-	CS1472* CS1388	24	4.5 MI	
	10.01-	CA1853IR	28	80					
B 10L	[THD130K]	01.95-	CA1670IR	28	180				
B 10M	[DH10A]	01.95-	CA1670IR	28	180				
B 12 12.0	[TD122FH]	01.92- 10.95	CA518IR	28	55 BO	01.92- 10.95	CS544	24	5.5
		01.92- 10.95	CA722IR	28	45				
		01.92- 10.95	CA853IR	28	80				
		01.92- 10.95	CA858IR	28	55 PR				
		01.92- 10.95	CA518IR	28	55 BO				
	[TD122FL]	01.92- 10.95	CA518IR	28	55 BO	01.92- 10.95	CS544	24	5.5
		01.92- 10.95	CA722IR	28	45				
		01.92- 10.95	CA853IR	28	80				
		01.92- 10.95	CA858IR	28	55 PR				
		01.92- 10.95	CA518IR	28	55 BO				
	[TD123ES]	01.92- 10.95	CA518IR	28	55 BO	01.92- 10.95	CS544	24	5.5
		01.92- 10.95	CA853IR	28	80				
		01.92- 10.95	CA858IR	28	55 PR				
		01.92- 10.95	CA518IR	28	55 BO				
		01.92- 10.95	CA853IR	28	80				
B 12 12.1	[D12A420]	10.95-	CA1049IR	28	55	10.95-	CS1161	24	6.6
		10.95-	CA907IR	28	80				
	[D12C420]	02.06-	CA1667IR	28	140	02.06- A10 02.06-	CS1388 CS1472*	24	4.5 MI
		02.06-	CA1853IR	28	80				
		02.06-	CA1883IR	28	110				
	[D12D420]	02.06-	CA1667IR	28	140	A10 02.06- 02.06-	CS1472* CS1388	24	4.5 MI
		02.06-	CA1853IR	28	80				
		02.06-	CA1883IR	28	110				
	[DH12D340]	02.06-	CA1667IR	28	140	02.06- A10 02.06-	CS1388 CS1472*	24	4.5 MI
		02.06-	CA1853IR	28	80				
		02.06-	CA1883IR	28	110				
	[DH12E340]	02.06-	CA1667IR	28	140	A10 02.06- 02.06-	CS1472* CS1388	24	4.5 MI
		02.06-	CA1853IR	28	80				
		02.06-	CA1883IR	28	110				
	[DH12E380]	02.06-	CA1667IR	28	140	A10 02.06- 02.06-	CS1472* CS1388	24	4.5 MI
02.06-		CA1853IR	28	80					
02.06-		CA1883IR	28	110					





	[DH12E420]	02.06-02.06-02.06	CA1667IR CA1853IR CA1883IR	28 140 28 80 28 110		A10 02.06-02.06	CS1472* CS1388	24 4.5 MI 24 4.5 MI
	[DH12E460]	02.06-02.06-02.06	CA1667IR CA1853IR CA1883IR	28 140 28 80 28 110		A10 02.06-02.06	CS1388 CS1472*	24 4.5 MI 24 4.5 MI
B 12	[D12]	01.95-	CA1670IR	28 180				
B10M 9.6	[THD100DA]						CS506	24 5.4
	[THD100DC]						CS506	24 5.4 SM
	[THD100DD]						CS506	24 5.4
	[THD100EA]						CS506	24 5.4
F 10/260 9.6	[TD100G]	02.82-06.85 02.82-06.85 11.83-06.85 11.83-06.85	CA132IR CA366IR CA500IR CA857IR	28 45 14 90 28 55 BO 28 55 PR		02.82-06.85	CS544	24 5.5
	[TD100GA]	02.82-06.85 11.83-06.85 11.83-06.85	CA132IR CA500IR CA857IR	28 45 28 55 BO 28 55 PR		02.82-06.85	CS544	24 5.5
	[TD101G]	02.82-06.85 01.83-06.85 01.83-06.85	CA132IR CA500IR CA857IR	28 45 28 55 BO 28 55 PR		02.82-06.85	CS544	24 5.5
F 10/280 9.6	[TD100B]	08.77-02.82	CA132IR	28 45		08.77-02.82	CS99	24 6.0
F 10/300 9.6	[TD101F]	10.83-01.86 11.83-01.86 11.83-01.86 02.86-05.88 02.86-05.88 02.86-05.88	CA132IR CA500IR CA857IR CA518IR CA722IR CA858IR	28 45 28 55 BO 28 55 PR 28 55 BO 28 45 28 55 PR		10.83-05.88	CS544	24 5.5
	[TD101FA]	10.83-01.86 11.83-01.86 11.83-01.86 02.86-05.88 02.86-05.88 02.86-05.88	CA132IR CA500IR CA857IR CA518IR CA722IR CA858IR	28 45 28 55 BO 28 55 PR 28 55 BO 28 45 28 55 PR		10.83-05.88	CS544	24 5.5
F 10/320 9.6	[TD102F]	10.87-12.94 10.87-12.94 10.87-12.94	CA518IR CA722IR CA858IR	28 55 BO 28 45 28 55 PR		10.87-12.94	CS544	24 5.5
	[TD102FBQ]	10.87-12.94 10.87-12.94 10.87-12.94	CA518IR CA722IR CA858IR	28 55 BO 28 45 28 55 PR		10.87-12.94	CS544	24 5.5
	[TD102FDQ]	10.87-12.94 10.87-12.94 10.87-12.94	CA518IR CA722IR CA858IR	28 55 BO 28 45 28 55 PR		10.87-12.94	CS544	24 5.5
	[TD102FF]	10.87-12.94 10.87-12.94 10.87-12.94	CA518IR CA722IR CA858IR	28 55 BO 28 45 28 55 PR		10.87-12.94	CS544	24 5.5
	[TD102FL]	10.87-12.94 10.87-12.94 10.87-12.94	CA518IR CA722IR CA858IR	28 55 BO 28 45 28 55 PR		10.87-12.94	CS544	24 5.5
	[TD102FM]	10.87-12.94 10.87-12.94 10.87-12.94	CA518IR CA722IR CA858IR	28 55 BO 28 45 28 55 PR		10.87-12.90	CS544	24 5.5
	[TD103ES]	08.91-12.94 08.91-12.94 08.91-12.94	CA518IR CA722IR CA858IR	28 55 BO 28 45 28 55 PR		10.87-12.90	CS544	24 5.5
F 12/320 12.0	[TD120G]	08.77-10.84 11.83-10.84 11.83-10.84	CA132IR CA500IR CA857IR	28 45 28 55 BO 28 55 PR		08.77-10.84	CS99	24 6.0
	[TD121G]	10.83-01.86 11.83-01.86 11.83-01.86 02.86-05.88 02.86-05.88 02.86-05.88	CA132IR CA500IR CA857IR CA518IR CA722IR CA858IR	28 45 28 55 BO 28 55 PR 28 55 BO 28 45 28 55 PR		02.87-05.88 10.83-01.87	CS544 CS99	24 5.5 24 6.0
	[TD121GD]	10.83-01.86 11.83-01.86 11.83-12.94 02.86-12.94 02.86-12.94 02.86-12.94 05.88-12.94	CA132IR CA500IR CA857IR CA518IR CA722IR CA858IR CA853IR	28 45 28 55 BO 28 55 PR 28 55 BO 28 45 28 55 PR 28 80		10.83-01.87 02.87-12.94	CS99 CS544	24 6.0 24 5.5
F 12/330 12.0	[TD120G]	09.80-10.84 11.83-10.84	CA132IR CA500IR	28 45 28 55 BO		09.80-10.84	CS99	24 6.0
	[TD121G]	10.83-01.86 11.83-01.86 02.86-05.88 02.86-05.88 02.86-05.88	CA132IR CA500IR CA518IR CA722IR CA858IR	28 45 28 55 BO 28 55 BO 28 45 28 55 PR		10.83-01.87 02.87-05.88	CS99 CS544	24 6.0 24 5.5
	[TD121GD]	10.83-01.86 11.83-01.86 02.86-12.94 02.86-12.94 02.86-12.94 05.88-12.94	CA132IR CA500IR CA518IR CA722IR CA858IR CA853IR	28 45 28 55 BO 28 55 BO 28 45 28 55 PR 28 80		02.87-12.94 10.83-01.87	CS544 CS99	24 5.5 24 6.0
F 12/360 12.0	[TD122F]	10.87-12.94 10.87-12.94 10.87-12.94 01.88-12.94	CA518IR CA722IR CA858IR CA853IR	28 55 BO 28 45 28 55 PR 28 80		10.87-12.94	CS544	24 5.5
	[TD122FH]	01.90-12.94 01.90-12.94 01.90-12.94 01.90-12.94	CA518IR CA722IR CA853IR CA858IR	28 55 BO 28 45 28 80 28 55 PR		01.90-12.94	CS544	24 5.5
F 12/370 12.0	[TD121F]	10.83-01.86 11.83-01.86 11.83-01.86 02.86-05.88 02.86-05.88 02.86-05.88	CA132IR CA500IR CA857IR CA518IR CA722IR CA858IR	28 45 28 55 BO 28 55 PR 28 55 BO 28 45 28 55 PR		10.83-01.87 02.87-05.88	CS99 CS544	24 6.0 24 5.5
F 12/400 12.0	[TD122FL]	01.88-12.94 01.88-12.94 01.88-12.94 01.88-12.94	CA518IR CA722IR CA853IR CA858IR	28 55 BO 28 45 28 80 28 55 PR		01.88-12.94	CS544	24 5.5



**VOLVO** Continued

	[TD122FS]	10.87- 12.94 CA518IR 28 55 BO 10.87- 12.94 CA722IR 28 45 10.87- 12.94 CA853IR 28 80 10.87- 12.94 CA858IR 28 55 PR		10.87- 12.94 CS544	24 5.5
	[TD123ES]	01.88- 12.94 CA518IR 28 55 BO 01.88- 12.94 CA853IR 28 80 01.88- 12.94 CA858IR 28 55 PR		01.88- 12.94 CS544	24 5.5
F 12/410 12.0	[TD122FL]	01.88- 09.01 CA858IR 28 55 PR 10.89- 09.01 CA518IR 28 55 BO 10.89- 09.01 CA722IR 28 45 10.89- 09.01 CA853IR 28 80		01.88- 09.01 CS544	24 5.5
	[TD122FS]	11.87- 09.01 CA518IR 28 55 BO 11.87- 09.01 CA722IR 28 45 11.87- 09.01 CA853IR 28 80 11.87- 09.01 CA858IR 28 55 PR		11.87- 09.01 CS544	24 5.5
	[TD123ES]	01.92- 12.94 CA518IR 28 55 BO 01.92- 12.94 CA722IR 28 45 01.92- 12.94 CA853IR 28 80 01.92- 12.94 CA858IR 28 55 PR		01.88- 12.94 CS544	24 5.5
F 16/470 16.1	[TD162F]	01.88- 12.94 CA518IR 28 55 BO 01.88- 12.94 CA722IR 28 45 01.88- 12.94 CA853IR 28 80 01.88- 12.94 CA858IR 28 55 PR		01.88- 12.94 CS1116	24 6.6
	[TD162FJ]	01.88- 12.94 CA518IR 28 55 BO 01.88- 12.94 CA722IR 28 45 01.88- 12.94 CA853IR 28 80 01.88- 12.94 CA858IR 28 55 PR		01.88- 12.94 CS1116	24 6.6
	[TD162FL]	01.88- 12.94 CA518IR 28 55 BO 01.88- 12.94 CA722IR 28 45 01.88- 12.94 CA853IR 28 80 01.88- 12.94 CA858IR 28 55 PR		01.88- 12.94 CS1116	24 6.6
	[TD162FS]	01.88- 12.94 CA518IR 28 55 BO 01.88- 12.94 CA722IR 28 45 01.88- 12.94 CA853IR 28 80 01.88- 12.94 CA858IR 28 55 PR		01.88- 12.94 CS1116	24 6.6
F 16/485 16.1	[TD162F]	10.87- 12.94 CA518IR 28 55 BO 10.87- 12.94 CA722IR 28 45 10.87- 12.94 CA853IR 28 80 10.87- 12.94 CA858IR 28 55 PR		10.87- 12.94 CS1116	24 6.6
	[TD162FJ]	10.87- 12.94 CA518IR 28 55 BO 10.87- 12.94 CA722IR 28 45 10.87- 12.94 CA853IR 28 80 10.87- 12.94 CA858IR 28 55 PR		10.87- 12.94 CS1116	24 6.6
	[TD162FL]	10.87- 12.94 CA518IR 28 55 BO 10.87- 12.94 CA722IR 28 45 10.87- 12.94 CA853IR 28 80 10.87- 12.94 CA858IR 28 55 PR		10.87- 12.94 CS1116	24 6.6
	[TD162FS]	10.87- 12.94 CA518IR 28 55 BO 10.87- 12.94 CA722IR 28 45 10.87- 12.94 CA853IR 28 80 10.87- 12.94 CA858IR 28 55 PR		10.87- 12.94 CS1116	24 6.6
F 16/500 16.1	[TD163ES]	01.92- 12.94 CA853IR 28 80		01.92- 12.94 CS1116	24 6.6
F 406 3.9	[D39B]	09.75- 02.86 CA366IR 14 90			
F 408 3.6	[TD40A]	04.78- 02.86 CA366IR 14 90		04.78- 02.86 CS783	12 3.0
F 610 5.5	[TD60C]	02.80- 10.80 CA366IR 14 90 11.80- 01.86 CA132IR 28 45 11.80- 01.86 CA500IR 28 55 BO 11.80- 01.86 CA857IR 28 55 PR 02.86- 10.86 CA518IR 28 55 BO 02.86- 10.86 CA722IR 28 45 02.86- 10.86 CA858IR 28 55 PR		02.80- 10.86 CS1443 02.80- 10.86 CS1474 11.80- 02.86 CS391	24 4.0 ND 24 4.0 BOGR 24 4.0 BO
F 611 5.5	[TD60C]	02.80- 10.80 CA366IR 14 90 11.80- 02.86 CA132IR 28 45 11.80- 02.86 CA500IR 28 55 BO 11.80- 02.86 CA857IR 28 55 PR		11.80- 02.86 CS391 02.80- 02.86 CS1474 02.80- 02.86 CS1443	24 4.0 BO 24 4.0 BOGR 24 4.0 ND
F 612 5.5	[TD60C]	04.83- 02.86 CA132IR 28 45 04.83- 02.86 CA500IR 28 55		04.83- 02.86 CS1474 04.83- 02.86 CS391 04.83- 02.86 CS1443	24 4.0 BOGR 24 4.0 BO 24 4.0 ND
F 613 5.5	[TD60A]	11.80- CA518IR 28 55 BO 11.80- CA858IR 28 55 PR 02.86- CA722IR 28 45			
	[TD60B]	03.80- 10.80 CA366IR 14 90 11.80- 02.86 CA132IR 28 45 11.80- 02.86 CA500IR 28 55 BO 11.80- 02.86 CA857IR 28 55 PR		03.79- 02.86 CS391 09.79- 02.86 CS1443 09.75- 02.86 CS1474	24 4.0 BO 24 4.0 ND 24 4.0 BOGR
F 614 5.5	[TD60A]	11.80- CA518IR 28 55 BO 11.80- CA858IR 28 55 PR 02.86- CA722IR 28 45			
	[TD60B]	11.80- CA518IR 28 55 BO 11.80- CA858IR 28 55 PR 02.86- CA722IR 28 45		09.75- 02.86 CS1443 09.75- 02.86 CS391 09.75- 02.86 CS1474	24 4.0 ND 24 4.0 BO 24 4.0 BOGR
F 615 S 5.5	[TD60B]	12.78- 10.81 CA366IR 14 90			
F 616 5.5	[TD60B]	02.81- 02.86 CA132IR 28 45 02.81- 02.86 CA500IR 28 55 BO 02.81- 02.86 CA857IR 28 55 PR		02.81- 02.86 CS1474 02.81- 02.86 CS1443 02.81- 02.86 CS391	24 4.0 BOGR 24 4.0 ND 24 4.0 BO
F 617 S 5.5	[TD60B]	12.78- 02.86 CA366IR 14 90			
F 7 6.7	[TD70F]	08.78- 01.86 CA132IR 28 45 08.78- 05.88 CA366IR 14 90 08.78- 01.86 CA500IR 28 55 BO 08.78- 01.86 CA857IR 28 55 PR 02.86- 05.88 CA518IR 28 55 BO 02.86- 05.88 CA722IR 28 45 02.86- 05.88 CA858IR 28 55 PR		08.78- 12.85 CS1474 08.78- 12.88 CS1443 08.78- 05.88 CS391	24 4.0 BOGR 24 4.0 ND 24 4.0 BO
	[TD70FS]	08.78- 12.85 CA518IR 28 55		08.78- 12.85 CS391 08.78- 12.85 CS1443 08.78- 12.85 CS1474	24 4.0 BO 24 4.0 ND 24 4.0 BOGR
	[TD70G]	08.78- 12.85 CA518IR 28 55		08.78- 12.85 CS391 08.78- 12.85 CS1443 08.78- 12.85 CS1474	24 4.0 BO 24 4.0 ND 24 4.0 BOGR
F 88/260 9.6	[TD100A]	08.65- 06.77 CA366IR 14 90			
F 89 12.0	[TD120A]	10.70- 06.77 CA366IR 14 90			
F 89/330 12.0	[TD120A]	10.70- 06.77 CA366IR 14 90			
FH 12/340 12.1	[D12A340]	08.93- 08.98 CA1049IR 28 55 08.93- 08.98 CA907IR 28 80		08.93- 08.98 CS962 08.93- 08.98 CS1161	24 6.6 24 6.6



	[D12C340]	08.98- 08.02	CA1049IR	28 55		08.98- 08.02	CS962	24 6.6
		08.98- 08.02	CA907IR	28 80		08.98- 08.02	CS1161	24 6.6
	[D12D340]	12.01- 08.06	CA1049IR	28 55	A10	12.01- 08.06	CS1472*	24 4.5 MI
		Chas. TB89472912- 12.01- 08.06	CA1883IR	28 110		12.01- 08.06	CS1161	24 6.6 BO
		Chas. -A557642,B330019- 12.01- 08.06	CA907IR	28 80		12.01- 08.06	CS1388	24 4.5 MI
		Chas. A557642,B330019- 12.01- 08.06	CA1853IR	28 80		12.01- 08.06	CS962	24 6.6
FH 12/380 12.1	[D12A380]	08.93- 08.98	CA1049IR	28 55		08.93- 08.98	CS1161	24 6.6
		08.93- 08.98	CA907IR	28 80		08.93- 08.98	CS962	24 6.6
	[D12C380]	08.98- 08.02	CA1049IR	28 55		08.98- 08.02	CS1161	24 6.6
		08.98- 08.02	CA907IR	28 80		08.98- 08.02	CS962	24 6.6
	[D12D380]	12.01- 08.06	CA1049IR	28 55		12.01- 08.06	CS1161	24 6.6 BO
		Chas. TB89472912- 12.01- 08.06	CA1883IR	28 110	A10	12.01- 08.06	CS1472*	24 4.5 MI
		Chas. -A557642,B330019- 12.01- 08.06	CA907IR	28 80		12.01- 08.06	CS962	24 6.6
		Chas. A557642,B330019- 12.01- 08.06	CA1853IR	28 80		12.01- 08.06	CS1388	24 4.5 MI
FH 12/420 12.1	[D12A340]	08.93- 08.98	CA1049IR	28 55		08.93- 08.98	CS962	24 6.6
		08.93- 09.98	CA907IR	28 80		08.93- 09.98	CS1161	24 6.6
	[D12A420]	08.93- 08.98	CA1049IR	28 55		08.93- 08.98	CS1161	24 6.6
		08.93- 08.98	CA907IR	28 80		08.93- 08.98	CS962	24 6.6
	[D12C420]	08.98- 01.02	CA1049IR	28 55		08.98- 01.02	CS962	24 6.6
		08.98- 01.02	CA907IR	28 80		08.98- 01.02	CS1161	24 6.6
	[D12D340]	12.01- 08.06	CA1049IR	28 55		12.01- 08.06	CS962	24 6.6
		Chas. TB89472912- 12.01- 08.06	CA1883IR	28 110		12.01- 08.06	CS1161	24 6.6 BO
		Chas. -A557642,B330019- 12.01- 08.06	CA907IR	28 80	A10	12.01- 08.06	CS1472*	24 4.5 MI
		Chas. A557642,B330019- 12.01- 08.06	CA1853IR	28 80		12.01- 08.06	CS1388	24 4.5 MI
	[D12D420]	12.01- 08.06	CA1049IR	28 55		12.01- 08.06	CS962	24 6.6
		Chas. TB89472912- 12.01- 08.06	CA1883IR	28 110	A10	12.01- 08.06	CS1472*	24 4.5 MI
		Chas. -A557642,B330019- 12.01- 08.06	CA907IR	28 80		12.01- 08.06	CS1388	24 4.5 MI
		Chas. A557642,B330019- 12.01- 08.06	CA1853IR	28 80		12.01- 08.06	CS1161	24 6.6 BO
FH 12/460 12.1	[D12C460]	08.98- 08.02	CA1049IR	28 55		08.98- 08.02	CS1161	24 6.6
		08.98- 08.02	CA907IR	28 80		08.98- 08.02	CS962	24 6.6
	[D12D460]	12.01- 08.06	CA1049IR	28 55	A10	12.01- 08.06	CS1472*	24 4.5 MI
		Chas. TB89472912- 12.01- 08.06	CA1883IR	28 110		12.01- 08.06	CS1388	24 4.5 MI
		Chas. -A557642,B330019- 12.01- 08.06	CA907IR	28 80		12.01- 08.06	CS1161	24 6.6 BO
		Chas. A557642,B330019- 12.01- 08.06	CA1853IR	28 80		12.01- 08.06	CS1388	24 4.5 MI
FH 12/500 12.1	[D12D500]	09.01- 08.06	CA1049IR	28 55	A10	09.01- 08.06	CS1472*	24 4.5 MI
		Chas. TB89472912- 09.01- 08.06	CA1883IR	28 110		09.01- 08.06	CS1388	24 4.5 MI
		Chas. -A557642,B330019- 09.01- 08.06	CA907IR	28 80		09.01- 08.06	CS1161	24 6.6 BO
		Chas. A557642,B330019- 09.01- 08.06	CA1853IR	28 80		09.01- 08.06	CS1388	24 4.5 MI
FH 16/470 16.1	[D16A470]	08.93- 12.99	CA1049IR	28 55				
		08.93- 12.99	CA907IR	28 80				
FH 16/520 16.1	[D16A520]	08.93- 12.99	CA1049IR	28 55		08.93- 12.99	CS1116	24 6.6
		08.93- 12.99	CA907IR	28 80				
	[D16B520]	08.98- 12.02	CA1049IR	28 55		08.98- 12.02	CS1116	24 6.6
		08.98- 12.02	CA907IR	28 80				
FH 16/540 16.1	[D16C550]	08.07-	CA1853IR	28 80		08.07-	CS1451*	24 7.0
	[D16G540]	08.07-	CA1049IR	28 55		08.07-	CS1451*	24 7.0
		08.07-	CA1853IR	28 80				
		08.07-	CA907IR	28 80				
FH 16/550 16.1	[D16C550]	01.03-	CA1853IR	28 80		01.03-	CS1451*	24 7.0
	[D16G540]	08.07-	CA1049IR	28 55		08.07-	CS1451*	24 7.0
		08.07-	CA1853IR	28 80				
		08.07-	CA907IR	28 80				
FH 16/580 16.1	[D16E580]	09.06-	CA1853IR	28 80		09.06-	CS1451*	24 7.0
		01.09-	CA1049IR	28 55				
FH 16/600 16.1	[D16G600]	09.06-	CA1049IR	28 55		09.06-	CS1451*	24 7.0
		09.06-	CA1853IR	28 80				
		09.06-	CA907IR	28 80				
FH 16/610 16.1	[D16C610]	01.03-	CA1853IR	28 80		01.03-	CS1451*	24 7.0
FH 16/660 16.1	[D16E660]	09.06-	CA1853IR	28 80		09.06-	CS1451*	24 7.0
		01.07-	CA1049IR	28 55				
FH 16/700 16.1	[D16G700]	09.06-	CA1049IR	28 55		09.06-	CS1451*	24 7.0
		09.06-	CA907IR	28 80				
		01.09-	CA1853IR	28 80				
FH 400 12.8	[D13A400]	09.05-	CA1853IR	28 80	A10	09.05-	CS1472*	24 4.5 MI
		09.05-	CA1883IR	28 110		09.05-	CS1388	24 4.5 MI
	[D13B400]	09.05-	CA1853IR	28 80	A10	09.05-	CS1472*	24 4.5 MI
		09.05-	CA1883IR	28 110		09.05-	CS1388	24 4.5 MI
FH 420 12.8	[D13C420]	01.09-	CA1853IR	28 80		01.09-	CS1388	24 4.5 MI
		01.09-	CA1883IR	28 110	A10	01.09-	CS1472*	24 4.5 MI
FH 440 12.8	[D13A440]	09.05-	CA1853IR	28 80	A10	09.05-	CS1472*	24 4.5 MI
		09.05-	CA1883IR	28 110		09.05-	CS1388	24 4.5 MI
	[D13B440]	09.05-	CA1853IR	28 80	A10	09.05-	CS1472*	24 4.5 MI
		09.05-	CA1883IR	28 110		09.05-	CS1388	24 4.5 MI
FH 460 12.8	[D13C460]	01.09-	CA1853IR	28 80	A10	01.09-	CS1472*	24 4.5 MI
		01.09-	CA1883IR	28 110		01.09-	CS1388	24 4.5 MI
FH 480 12.8	[D13A480]	09.05-	CA1853IR	28 80		09.05-	CS1388	24 4.5 MI
		09.05-	CA1883IR	28 110	A10	09.05-	CS1472*	24 4.5 MI
FH 500 12.8	[D13B500]	09.07-	CA1853IR	28 80	A10	09.07-	CS1472*	24 4.5 MI
		09.07-	CA1883IR	28 110		09.07-	CS1388	24 4.5 MI
	[D13C500]	09.07-	CA1853IR	28 80	A10	09.07-	CS1472*	24 4.5 MI
		09.07-	CA1883IR	28 110		09.07-	CS1388	24 4.5 MI
FH 520 12.8	[D13A520]	09.05-	CA1853IR	28 80		09.05-	CS1388	24 4.5 MI
		09.05-	CA1883IR	28 110	A10	09.05-	CS1472*	24 4.5 MI
FH 540 12.8	[D13C540]	01.09-	CA1853IR	28 80	A10	01.09-	CS1472*	24 4.5 MI
		01.09-	CA1883IR	28 110		01.09-	CS1388	24 4.5 MI
FH 550 16.1	[D16C550]	09.05-	CA1853IR	28 80		09.05-	CS1451*	24 7.0
FH 610 16.1	[D16C610]	09.05-	CA1853IR	28 80		09.05-	CS1451*	24 7.0
FL 10/280 9.6	[TD101G]	09.85- 01.86	CA132IR	28 45		09.85- 12.93	CS544	24 5.5
		09.85- 01.86	CA500IR	28 55	BO			
		09.85- 01.86	CA857IR	28 55	PR			
		02.86- 12.93	CA518IR	28 55	BO			
		02.86- 12.93	CA722IR	28 45				
		02.86- 12.93	CA858IR	28 55	PR			
FL 10/320 9.6	[D10A320]	02.95- 12.99	CA1049IR	28 55		02.95- 12.99	CS544	24 5.5
		02.95- 12.99	CA907IR	28 80				
FL 10/320 9.6	[D10A320]	02.95- 12.99	CA1049IR	28 55		02.95- 12.99	CS544	24 5.5
		02.95- 12.99	CA907IR	28 80				
FL 10/360 9.6	[D10A360]	02.95-	CA1049IR	28 55		02.95-	CS544	24 5.5
		02.95-	CA907IR	28 80				
FL 10H/320 9.6	[D10A320]	02.95-	CA1049IR	28 55		02.95-	CS544	24 5.5
		02.95-	CA907IR	28 80				
FL 10H/360 9.6	[D10A360]	02.95-	CA1049IR	28 55		02.95-	CS544	24 5.5
		02.95-	CA907IR	28 80				



**VOLVO** *Continued*

FL 12/380 12.1	[D12A380]	09.95-09.95-	CA1049IR CA9071R	28 55 28 80		09.95-	CS962	24 6.6
FL 12/420 12.1	[D12A420]	09.95-09.95-	CA1049IR CA9071R	28 55 28 80		09.95-	CS962	24 6.6
FL 12H/380 12.1	[D12A380]	09.95-09.95-	CA1049IR CA9071R	28 55 28 80		09.95-	CS962	24 6.6
FL 12H/420 12.1	[D12A420]	09.95-09.95-	CA1049IR CA9071R	28 55 28 80		09.95-	CS962	24 6.6
FL 180 5.5	[D6B]	05.00-05.00-05.00-	CA518IR CA853IR CA858IR	28 55 28 80 28 55	BO PR	05.00-03.00-	CS391 CS1443 CS1474	24 4.0 BO 24 4.0 ND 24 4.0 BOGR
FL 220 5.5	[20NE]	05.00-05.00-05.00-	CA518IR CA853IR CA858IR	28 55 28 80 28 55	BO PR	05.00-03.00-	CS391 CS1474 CS1443	24 4.0 BO 24 4.0 BOGR 24 4.0 ND
	[D6B]	05.00-05.00-05.00-	CA518IR CA853IR CA858IR	28 55 28 80 28 55	BO PR	03.00-05.00-03.00-	CS1474 CS391 CS1443	24 4.0 BOGR 24 4.0 BO 24 4.0 ND
FL 250 5.5	[D6B]	03.00-03.00-03.00-	CA518IR CA853IR CA858IR	28 55 28 80 28 55	BO PR	03.00-05.00-03.00-	CS1443 CS391 CS1474	24 4.0 ND 24 4.0 BO 24 4.0 BOGR
FL 408 3.6	[TD41G]	02.86-02.86-02.86-	CA518IR CA722IR CA858IR	28 55 28 45 28 55	BO PR			
FL 608 5.5	[D6A180]	02.95-02.95-02.95-02.95-	CA518IR CA722IR CA853IR CA858IR	28 55 28 45 28 80 28 55	BO PR	02.95-02.95-01.91-	CS1443 CS391 CS1474	24 4.0 ND 24 4.0 BO 24 4.0 BOGR
	[D6A210]	02.95-02.95-02.95-02.95-	CA518IR CA722IR CA853IR CA858IR	28 55 28 45 28 80 28 55	BO PR	02.95-01.93-02.95-	CS391 CS1474 CS1443	24 4.0 BO 24 4.0 BOGR 24 4.0 ND
	[TD61G]	03.87-03.87-03.87-	CA518IR CA722IR CA853IR	28 55 28 45 28 80	BO	03.87-10.85-	CS1443 CS391 CS1474	24 4.0 ND 24 4.0 BO 24 4.0 BOGR
	[TD61GA]	09.86-09.86-09.86-09.86-	CA518IR CA722IR CA853IR CA858IR	28 55 28 45 28 80 28 55	BO PR	09.86-09.86-	CS391 CS1474 CS1443	24 4.0 BO 24 4.0 BOGR 24 4.0 ND
	[TD63E]	11.91-11.91-11.91-	CA518IR CA722IR CA853IR	28 55 28 45 28 80	BO	11.91-01.91-	CS1443 CS391 CS1474	24 4.0 ND 24 4.0 BO 24 4.0 BOGR
	[TD63ES]	12.94-12.94-12.94-	CA518IR CA722IR CA853IR CA858IR	28 55 28 45 28 80 28 55	BO PR	12.94-01.93-	CS1443 CS391 CS1474	24 4.0 ND 24 4.0 BO 24 4.0 BOGR
FL 610 5.5	[TD61G]	09.85-09.85-09.85-09.85-	CA518IR CA722IR CA853IR CA858IR	28 55 28 45 28 80 28 55	BO PR	09.85-09.85-	CS1443 CS391 CS1474	24 4.0 ND 24 4.0 BO 24 4.0 BOGR
FL 611 5.5	[D6A180]	02.95-02.95-02.95-02.95-	CA518IR CA722IR CA853IR CA858IR	28 55 28 45 28 80 28 55	BO PR	02.95-02.95-09.85-	CS1443 CS391 CS1474	24 4.0 ND 24 4.0 BO 24 4.0 BOGR
	[D6A210]	02.95-02.95-02.95-02.95-	CA518IR CA722IR CA853IR CA858IR	28 55 28 45 28 80 28 55	BO PR	02.95-12.94-02.95-	CS391 CS1474 CS1443	24 4.0 BO 24 4.0 BOGR 24 4.0 ND
	[TD61G]	09.85-09.85-09.85-09.85-02.86-02.86-	CA132IR CA500IR CA853IR CA857IR CA518IR CA722IR CA858IR	28 45 28 55 28 80 28 55 28 55 28 45 28 55	BO PR	09.85-09.85-	CS391 CS1443 CS1474	24 4.0 BO 24 4.0 ND 24 4.0 BOGR
	[TD61GA]	09.86-09.86-09.86-09.86-	CA518IR CA722IR CA853IR CA858IR	28 55 28 45 28 80 28 55	BO PR	09.86-09.85-	CS1443 CS391 CS1474	24 4.0 ND 24 4.0 BO 24 4.0 BOGR
	[TD61GC]	01.90-01.90-01.90-	CA518IR CA722IR CA853IR CA858IR	28 55 28 45 28 80 28 55	BO PR	01.90-09.85-	CS1443 CS391 CS1474	24 4.0 ND 24 4.0 BO 24 4.0 BOGR
	[TD61GS]	09.85-09.85-09.85-09.85-09.85-09.85-	CA132IR CA500IR CA518IR CA722IR CA853IR CA857IR CA858IR	28 45 28 55 28 55 28 45 28 80 28 55 28 55	BO PR	09.85-09.85-	CS1443 CS1474 CS391	24 4.0 ND 24 4.0 BOGR 24 4.0 BO
	[TD63E]	11.91-11.91-11.91-	CA518IR CA722IR CA853IR	28 55 28 45 28 80	BO	09.85-11.91-	CS1474 CS391 CS1443	24 4.0 BOGR 24 4.0 BO 24 4.0 ND
	[TD63ES]	12.94-12.94-12.94-	CA518IR CA722IR CA853IR CA858IR	28 55 28 45 28 80 28 55	BO PR	12.94-12.94-	CS391 CS1474 CS1443	24 4.0 BO 24 4.0 BOGR 24 4.0 ND
FL 612 5.5	[D6A180]	02.95-02.95-02.95-02.95-	CA518IR CA722IR CA853IR CA858IR	28 55 28 45 28 80 28 55	BO PR	02.95-02.95-09.85-	CS391 CS1443 CS1474	24 4.0 BO 24 4.0 ND 24 4.0 BOGR
	[D6A210]	02.95-02.95-02.95-02.95-	CA518IR CA722IR CA853IR CA858IR	28 55 28 45 28 80 28 55	BO PR	02.95-02.95-11.91-	CS1443 CS391 CS1474	24 4.0 ND 24 4.0 BO 24 4.0 BOGR
	[D6A230]	02.95-02.95-02.95-02.95-	CA518IR CA722IR CA853IR CA858IR	28 55 28 45 28 80 28 55	BO PR	02.95-02.95-	CS391 CS1474 CS1443	24 4.0 BO 24 4.0 BOGR 24 4.0 ND



	[D6A250]	02.95- 08.00	CA5181R	28 55	BO	12.95- 12.99	CS1474	24 4.0	BOGR
		02.95- 08.00	CA7221R	28 45		02.95- 08.00	CS1443	24 4.0	ND
		02.95- 08.00	CA8531R	28 80		02.95- 08.00	CS391	24 4.0	BO
		02.95- 08.00	CA8581R	28 55	PR				
	[TD61GC]	01.90- 11.94	CA5181R	28 55	BO	09.85- 12.99	CS1474	24 4.0	BOGR
		01.90- 11.94	CA7221R	28 45		01.90- 12.94	CS1443	24 4.0	ND
		01.90- 11.94	CA8531R	28 80		01.90- 11.94	CS391	24 4.0	BO
		01.90- 11.94	CA8581R	28 55	PR				
	[TD61GS]	09.85- 01.86	CA1321R	28 45		09.85- 12.99	CS1474	24 4.0	BOGR
		09.85- 01.86	CA5001R	28 55	BO	09.85- 11.94	CS1443	24 4.0	ND
		09.85- 11.94	CA8531R	28 80		09.85- 11.94	CS391	24 4.0	BO
		09.85- 01.86	CA8571R	28 55	PR				
02.86- 11.94		CA5181R	28 55	BO					
02.86- 11.94		CA7221R	28 45						
[TD63E]	02.86- 11.94	CA8581R	28 55	PR					
	11.91- 12.96	CA5181R	28 55	BO	11.91- 12.96	CS391	24 4.0	BO	
	11.91- 12.96	CA7221R	28 45		09.85- 12.99	CS1474	24 4.0	BOGR	
	11.91- 12.96	CA8531R	28 80		11.91- 12.96	CS1443	24 4.0	ND	
[TD63ES]	11.91- 12.96	CA8581R	28 55	PR					
	11.91- 12.96	CA5181R	28 55	BO	11.91- 12.96	CS1443	24 4.0	ND	
	11.91- 12.96	CA7221R	28 45		11.91- 12.99	CS1474	24 4.0	BOGR	
	11.91- 12.96	CA8531R	28 80		11.91- 12.96	CS391	24 4.0	BO	
FL 614 5.5	[D6A180]	02.95- 08.00	CA5181R	28 55	BO	09.85- 03.00	CS1474	24 4.0	BOGR
		02.95- 08.00	CA7221R	28 45		02.95- 03.00	CS1443	24 4.0	ND
		02.95- 08.00	CA8531R	28 80		02.95- 08.00	CS391	24 4.0	BO
		02.95- 08.00	CA8581R	28 55	PR				
	[D6A210]	02.95- 08.00	CA5181R	28 55	BO	02.95- 08.00	CS1443	24 4.0	ND
		02.95- 08.00	CA7221R	28 45		02.95- 08.00	CS391	24 4.0	BO
		02.95- 08.00	CA8531R	28 80		09.85- 03.00	CS1474	24 4.0	BOGR
		02.95- 08.00	CA8581R	28 55	PR				
	[D6A230]	12.95- 08.00	CA5181R	28 55	BO	12.95- 03.00	CS1474	24 4.0	BOGR
		12.95- 08.00	CA7221R	28 45		12.95- 08.00	CS1443	24 4.0	ND
		12.95- 08.00	CA8531R	28 80		12.95- 08.00	CS391	24 4.0	BO
		12.95- 08.00	CA8581R	28 55	PR				
[D6A250]	12.95- 08.00	CA5181R	28 55	BO	12.95- 08.00	CS391	24 4.0	BO	
	12.95- 08.00	CA7221R	28 45		12.95- 08.00	CS1443	24 4.0	ND	
	12.95- 08.00	CA8531R	28 80		12.95- 03.00	CS1474	24 4.0	BOGR	
	12.95- 08.00	CA8581R	28 55	PR					
[TD61F]	09.85- 01.86	CA1321R	28 45		09.85- 11.94	CS391	24 4.0	BO	
	09.85- 01.86	CA5001R	28 55	BO	09.85- 03.00	CS1474	24 4.0	BOGR	
	09.85- 11.90	CA8531R	28 80		09.85- 11.94	CS1443	24 4.0	ND	
	09.85- 01.86	CA8571R	28 55	PR					
	02.86- 11.94	CA5181R	28 55	BO					
	02.86- 11.94	CA7221R	28 45						
[TD61GC]	02.86- 11.94	CA8581R	28 55	PR					
	01.90- 11.94	CA5181R	28 55	BO	01.90- 11.94	CS1443	24 4.0	ND	
	01.90- 11.94	CA7221R	28 45		01.90- 11.94	CS391	24 4.0	BO	
	01.90- 11.94	CA8531R	28 80		09.85- 03.00	CS1474	24 4.0	BOGR	
[TD61GS]	01.90- 11.94	CA8581R	28 55	PR					
	09.85- 01.86	CA1321R	28 45		09.85- 11.94	CS391	24 4.0	BO	
	09.85- 01.86	CA5001R	28 55	BO	09.85- 11.94	CS1443	24 4.0	ND	
	09.85- 01.86	CA5501R	28 55	BO	09.85- 03.00	CS1474	24 4.0	BOGR	
	09.85- 11.94	CA8531R	28 80						
	09.85- 01.86	CA8571R	28 55	PR					
[TD63E]	02.86- 11.94	CA5181R	28 55	BO					
	02.86- 11.94	CA7221R	28 45						
	02.86- 11.94	CA8581R	28 55	PR					
	11.91- 12.96	CA5181R	28 55	BO	09.85- 03.00	CS1474	24 4.0	BOGR	
[TD63ES]	11.91- 12.96	CA7221R	28 45		11.91- 12.96	CS1443	24 4.0	ND	
	11.91- 12.96	CA8531R	28 80		11.91- 12.96	CS391	24 4.0	BO	
	11.91- 12.96	CA8581R	28 55	PR					
	11.91- 12.96	CA5181R	28 55	BO	09.85- 03.00	CS1474	24 4.0	BOGR	
FL 615 5.5	[D6A180]	02.95- 08.00	CA5181R	28 55	BO	02.95- 03.00	CS1443	24 4.0	ND
		02.95- 08.00	CA7221R	28 45		02.95- 08.00	CS391	24 4.0	BO
		02.95- 08.00	CA8531R	28 80		11.91- 03.00	CS1474	24 4.0	BOGR
		02.95- 08.00	CA8581R	28 55	PR				
	[D6A210]	02.95- 08.00	CA5181R	28 55	BO	11.91- 03.00	CS1474	24 4.0	BOGR
		02.95- 08.00	CA7221R	28 45		11.91- 08.00	CS391	24 4.0	BO
		02.95- 08.00	CA8531R	28 80		11.91- 03.00	CS1443	24 4.0	ND
		02.95- 08.00	CA8581R	28 55	PR				
	[D6A230]	12.95- 08.00	CA5181R	28 55	BO	12.95- 03.00	CS1443	24 4.0	ND
		12.95- 08.00	CA7221R	28 45		12.95- 08.00	CS391	24 4.0	BO
		12.95- 08.00	CA8531R	28 80		12.95- 03.00	CS1474	24 4.0	BOGR
		12.95- 08.00	CA8581R	28 55	PR				
[D6A250]	12.95- 08.00	CA5181R	28 55	BO	12.95- 08.00	CS391	24 4.0	BO	
	12.95- 08.00	CA7221R	28 45		12.95- 03.00	CS1474	24 4.0	BOGR	
	12.95- 08.00	CA8531R	28 80		12.95- 08.00	CS1443	24 4.0	ND	
	12.95- 08.00	CA8581R	28 55	PR					
[TD63E]	11.91- 12.96	CA5181R	28 55	BO	11.91- 03.00	CS1474	24 4.0	BOGR	
	11.91- 12.96	CA7221R	28 45		11.91- 12.96	CS1443	24 4.0	ND	
	11.91- 12.96	CA8531R	28 80		11.91- 12.96	CS391	24 4.0	BO	
	11.91- 12.96	CA8581R	28 55	PR					
	11.91- 12.96	CA5181R	28 55	BO	11.91- 12.96	CS391	24 4.0	BO	
	11.91- 12.96	CA7221R	28 45		11.91- 12.96	CS1443	24 4.0	ND	
[TD63ES]	11.91- 12.96	CA8531R	28 80		11.91- 03.00	CS1474	24 4.0	BOGR	
	11.91- 12.96	CA8581R	28 55	PR					
	11.91- 12.96	CA5181R	28 55	BO	11.91- 12.96	CS391	24 4.0	BO	
	11.91- 12.96	CA7221R	28 45		11.91- 12.96	CS1443	24 4.0	ND	
FL 618 5.5	[D6A180]	02.95- 08.00	CA5181R	28 55	BO	11.91- 03.00	CS1474	24 4.0	BOGR
		02.95- 08.00	CA7221R	28 45		02.95- 08.00	CS1443	24 4.0	ND
		02.95- 08.00	CA8531R	28 80		02.95- 08.00	CS391	24 4.0	BO
		02.95- 08.00	CA8581R	28 55	PR				
	[D6A210]	02.95- 08.00	CA5181R	28 55	BO	02.95- 08.00	CS1443	24 4.0	ND
		02.95- 08.00	CA7221R	28 45		02.95- 08.00	CS391	24 4.0	BO
		02.95- 08.00	CA8531R	28 80		11.91- 03.00	CS1474	24 4.0	BOGR
		02.95- 08.00	CA8581R	28 55	PR				
	[D6A230]	12.95- 08.00	CA5181R	28 55	BO	12.95- 03.00	CS1474	24 4.0	BOGR
		12.95- 08.00	CA7221R	28 45		12.95- 03.00	CS1443	24 4.0	ND
		12.95- 08.00	CA8531R	28 80		12.95- 08.00	CS391	24 4.0	BO
		12.95- 08.00	CA8581R	28 55	PR				



**VOLVO** Continued

	[D6A250]	12.95- 08.00 CA518IR 28 55 BO	12.95- 03.00 CS1474 24 4.0 BOGR
		12.95- 08.00 CA722IR 28 45	12.95- 08.00 CS391 24 4.0 BO
		12.95- 08.00 CA853IR 28 80	12.95- 03.00 CS1443 24 4.0 ND
		12.95- 08.00 CA858IR 28 55 PR	
	[TD63E]	11.91- 08.00 CA518IR 28 55 BO	11.91- 12.96 CS391 24 4.0 BO
		11.91- 08.00 CA722IR 28 45	11.91- 12.96 CS1443 24 4.0 ND
		11.91- 08.00 CA853IR 28 80	11.91- 03.00 CS1474 24 4.0 BOGR
		11.91- 08.00 CA858IR 28 55 PR	
	[TD63ES]	11.91- 12.96 CA518IR 28 55 BO	11.91- 12.96 CS1443 24 4.0 ND
		11.91- 12.96 CA722IR 28 45	11.91- 12.96 CS391 24 4.0 BO
		11.91- 12.96 CA853IR 28 80	11.91- 03.00 CS1474 24 4.0 BOGR
		11.91- 12.96 CA858IR 28 55 PR	
FL 619 5.5	[TD61F]	09.85- 11.94 CA518IR 28 55 BO	09.85- 11.94 CS1443 24 4.0 ND
		09.85- 11.94 CA722IR 28 45	09.85- 11.94 CS1474 24 4.0 BOGR
		09.85- 11.94 CA853IR 28 80	09.85- 11.94 CS391 24 4.0 BO
		09.85- 11.94 CA858IR 28 55 PR	
FL 7/230 6.7	[D7B230]	09.94- 10.99 CA518IR 28 55 BO	09.94- 10.99 CS699 24 5.4
		09.94- 10.99 CA722IR 28 45	
		09.94- 10.99 CA858IR 28 55 PR	
	[TD71F]	09.85- 01.86 CA132IR 28 45	09.85- 10.94 CS699 24 5.4
		09.85- 01.86 CA500IR 28 55 BO	
		09.85- 01.86 CA857IR 28 55 PR	
		02.86- 10.94 CA518IR 28 55 BO	
		02.86- 10.99 CA722IR 28 45	
		02.86- 10.99 CA858IR 28 55 PR	
	[TD71FQ]	09.85- 01.86 CA132IR 28 45	09.85- 10.94 CS699 24 5.4
		09.85- 01.86 CA500IR 28 55 BO	
		09.85- 01.86 CA857IR 28 55 PR	
		02.86- 10.99 CA518IR 28 55 BO	
		02.86- 10.99 CA722IR 28 45	
		02.86- 10.99 CA858IR 28 55 PR	
	[TD73E]	11.91- 10.99 CA518IR 28 55 BO	11.91- 10.99 CS699 24 5.4
		11.91- 10.99 CA722IR 28 45	
		11.91- 10.99 CA858IR 28 55 PR	
FL 7/260 6.7	[D7B260]	10.94- 10.99 CA518IR 28 55 BO	11.91- 10.99 CS699 24 5.4
		10.94- 10.99 CA722IR 28 45	
		10.94- 10.99 CA858IR 28 55 PR	
	[TD73ES]	11.91- 10.99 CA518IR 28 55 BO	11.91- 10.99 CS699 24 5.4
		11.91- 10.99 CA722IR 28 45	
		11.91- 10.99 CA858IR 28 55 PR	
FL 7/290 6.7	[D7A285]	10.93- 10.99 CA518IR 28 55 BO	10.93- 10.99 CS699 24 5.4
		10.93- 10.99 CA722IR 28 45	
		10.93- 10.99 CA858IR 28 55 PR	
FM 10/320 9.6	[D10B320]	04.99- 12.01 CA1049IR 28 55	04.99- 12.01 CS544 24 5.5
		04.99- 12.01 CA907IR 28 80	
FM 10/360 9.6	[D10B360]	04.99- 12.01 CA1049IR 28 55	04.99- 12.01 CS544 24 5.5
		04.99- 12.01 CA907IR 28 80	
FM 12/340 12.1	[D12C340]	08.98- 09.05 CA1049IR 28 55	08.98- 09.05 CS1161 24 6.6
		08.98- 09.05 CA907IR 28 80	
	[D12D340]	12.01- 09.05 CA1049IR 28 55	12.01- 09.05 CS1388 24 4.5 MI
		Chas. TB89472912- 12.01- 09.05 CA1883IR 28 110	A10 12.01- 09.05 CS1472* 24 4.5 MI
		Chas. -A557642,B330019 12.01- 09.05 CA907IR 28 80	12.01- 09.05 CS1161 24 6.6 BO
		Chas. A557642,B330019- 12.01- 09.05 CA1853IR 28 80	
FM 12/380 12.1	[D12C380]	08.98- 09.05 CA1049IR 28 55	08.98- 09.05 CS1161 24 6.6
		08.98- 09.05 CA907IR 28 80	
FM 12/460 12.1	[D12C460]	08.98- 09.05 CA1049IR 28 55	08.98- 09.05 CS962 24 6.6
		08.98- 09.05 CA907IR 28 80	08.98- 09.05 CS1161 24 6.6
FM 12H/340 12.1	[D12C340]	08.98- 09.05 CA1049IR 28 55	08.98- 09.05 CS1161 24 6.6
		08.98- 09.05 CA907IR 28 80	
	[D12D340]	12.01- 09.05 CA1049IR 28 55	12.01- 09.05 CS1388 24 4.5 MI
		Chas. TB89472912- 12.01- 09.05 CA1883IR 28 110	12.01- 09.05 CS1161 24 6.6 BO
		Chas. -A557642,B330019 12.01- 09.05 CA907IR 28 80	A10 12.01- 09.05 CS1472* 24 4.5 MI
		Chas. A557642,B330019- 12.01- 09.05 CA1853IR 28 80	
FM 12H/380 12.1	[D12C380]	08.98- 09.05 CA1049IR 28 55	08.98- 09.05 CS1161 24 6.6
		08.98- 09.05 CA907IR 28 80	
FM 12H/420 12.1	[D12C420]	08.98- 09.05 CA1049IR 28 55	08.98- 09.05 CS1161 24 6.6
		08.98- 09.05 CA907IR 28 80	
	[D12D420]	12.01- 09.05 CA1049IR 28 55	A10 12.01- 09.05 CS1472* 24 4.5 MI
		Chas. TB89472912- 12.01- 09.05 CA1883IR 28 110	12.01- 09.05 CS1388 24 4.5 MI
		Chas. -A557642,B330019 12.01- 09.05 CA907IR 28 80	12.01- 09.05 CS1161 24 6.6 BO
		Chas. A557642,B330019- 12.01- 09.05 CA1853IR 28 80	
FM 300 9.4	[D9A300]	09.05- CA1853IR 28 80	09.05- CS1495* 24 5.5
		09.05- CA907IR 28 80	
	[D9B300]	09.05- CA1049IR 28 55	09.05- CS1495* 24 5.5
		09.05- CA1853IR 28 80	
		09.05- CA907IR 28 80	
FM 340 9.4	[D9B340]	09.05- CA1853IR 28 80	
		09.05- CA907IR 28 80	
FM 360 12.8	[D13A360]	09.05- CA1853IR 28 80	A10 09.05- CS1472* 24 4.5 MI
		09.05- CA1883IR 28 110	09.05- CS1388 24 4.5 MI
	[D13B360]	09.05- CA1853IR 28 80	A10 09.05- CS1472* 24 4.5 MI
		09.05- CA1883IR 28 110	09.05- CS1388 24 4.5 MI
FM 380 12.8	[D13C380]	09.05- CA1853IR 28 80	A10 09.05- CS1472* 24 4.5 MI
		09.05- CA1883IR 28 110	09.05- CS1388 24 4.5 MI
FM 380 9.4	[D9B380]	09.05- CA1853IR 28 80	
		09.05- CA907IR 28 80	
FM 390 10.8	[D11B390]	06.08- CA1853IR 28 80	
FM 400 12.8	[D13A400]	09.05- CA1853IR 28 80	09.05- CS1388 24 4.5 MI
		09.05- CA1883IR 28 110	A10 09.05- CS1472* 24 4.5 MI
	[D13B400]	09.05- CA1853IR 28 80	A10 09.05- CS1472* 24 4.5 MI
		09.05- CA1883IR 28 110	09.05- CS1388 24 4.5 MI
FM 420 12.8	[D13C420]	09.05- CA1853IR 28 80	A10 09.05- CS1472* 24 4.5 MI
		09.05- CA1883IR 28 110	09.05- CS1388 24 4.5 MI
FM 440 12.8	[D13A440]	09.05- CA1853IR 28 80	09.05- CS1388 24 4.5 MI
		09.05- CA1883IR 28 110	A10 09.05- CS1472* 24 4.5 MI
	[D13B440]	09.05- CA1853IR 28 80	A10 09.05- CS1472* 24 4.5 MI
		09.05- CA1883IR 28 110	09.05- CS1388 24 4.5 MI
FM 460 12.8	[D13C460]	09.05- CA1853IR 28 80	A10 09.05- CS1472* 24 4.5 MI
		09.05- CA1883IR 28 110	09.05- CS1388 24 4.5 MI
FM 480 12.8	[D13A480]	09.05- CA1853IR 28 80	09.05- CS1388 24 4.5 MI
		09.05- CA1883IR 28 110	A10 09.05- CS1472* 24 4.5 MI
FM 500 12.8	[D13B500]	09.07- CA1853IR 28 80	A10 09.07- CS1472* 24 4.5 MI
		09.07- CA1883IR 28 110	09.07- CS1388 24 4.5 MI



	[D13C500]	09.05-09.05-	CA1853IR	28 80	A10	09.05-09.05-	CS1472*	24 4.5	MI
			CA1883IR	28 110			CS1388	24 4.5	MI
FM 7/250 7.3	[D7C250]	08.98-12.01	CA1049IR	28 55		08.98-12.01	CS699	24 5.4	
		08.98-12.01	CA907IR	28 80			CS1285	24 4.0	
									For vehicles with Auxiliary drive/PTO
FM 7/290 7.3	[D7C290]	08.98-12.01	CA1049IR	28 55		08.98-12.01	CS1285	24 4.0	
									For vehicles with Auxiliary drive/PTO
		08.98-12.01	CA907IR	28 80		08.98-12.01	CS699	24 5.4	
FM 9/260 9.4	[D9A260]	12.01-09.05	CA1049IR	28 55		12.01-09.05	CS1495*	24 5.5	
			CA1853IR	28 80					Chas. A557643-, B8330019-
		12.01-09.05	CA907IR	28 80					Chas. -A557642-, B330018
FM 9/300 9.4	[D9A300]	12.01-09.05	CA1049IR	28 55		12.01-09.05	CS1495*	24 5.5	
			CA1853IR	28 80					Chas. A557643-, B8330019-
		12.01-09.05	CA907IR	28 80					Chas. -A557642-, B330018
	[D9B300]	12.01-12.01-	CA1853IR	28 80					
			CA907IR	28 80					
FM 9/340 9.4	[D9A340]	12.01-09.05	CA1049IR	28 55		12.01-09.05	CS1495*	24 5.5	
			CA1853IR	28 80					Chas. A557643-, B8330019-
		12.01-09.05	CA907IR	28 80					Chas. -A557642-, B330018
FM 9/380 9.4	[D9A380]	12.01-09.05	CA1049IR	28 55		12.01-09.05	CS1495*	24 5.5	
			CA1853IR	28 80					Chas. A557643-, B8330019-
		12.01-09.05	CA907IR	28 80					Chas. -A557642-, B330018
FS 718/260 6.7	[D7B230]	09.94-03.96	CA518IR	28 55	BO	09.94-03.96	CS699	24 5.4	
		09.94-03.96	CA722IR	28 45					
		09.94-03.96	CA853IR	28 80					
		09.94-03.96	CA858IR	28 55	PR				
	[D7B260]	09.94-03.96	CA518IR	28 55	BO	09.94-03.96	CS699	24 5.4	
		09.94-03.96	CA722IR	28 45					
		09.94-03.96	CA853IR	28 80					
		09.94-03.96	CA858IR	28 55	PR				
N 10/270 9.6	[TD100G]	01.73-12.89	CA132IR	28 45		01.73-12.89	CS99	24 6.0	
	[TD101G]	01.73-12.89	CA132IR	28 45		01.73-12.89	CS99	24 6.0	
N 10/300 9.6	[TD100B]	01.73-12.89	CA518IR	28 55		01.73-12.89	CS544	24 5.5	
		01.73-12.89	CA722IR	28 45					
	[TD101F]	01.73-12.89	CA518IR	28 55		01.73-12.89	CS544	24 5.5	
		01.73-12.89	CA722IR	28 45					
N 7 6.7	[TD70ES]	01.75-09.80	CA132IR	28 45		01.73-09.80	CS1474	24 4.0	BOGR
						01.77-09.80	CS1443	24 4.0	ND
						01.77-09.80	CS391	24 4.0	BO
NH 12/380 12.1	[D12C380]	05.99-	CA907IR	28 80		05.99-	CS1161	24 6.6	
NH 12/420 12.1	[D12C420]	05.99-	CA907IR	28 80		05.99-	CS1161	24 6.6	
<b>INDUSTRY</b>									
EC 150 C Excavator		01.97-	CA858IR	28 55					
<b>Volvo BM</b>									
<b>AGRICULTURE</b>									
2650 5.5	[TD60B]	05.79-06.82	CA366IR	14 90					
2654 5.5	[TD60B]	05.79-06.82	CA366IR	14 90					
L 120 6.7		01.87-01.02	CA857IR	28 55					
L 160		01.87-01.02	CA857IR	28 55					
L 70 4.5	[TD45B]	11.91-	CA857IR	28 55		01.87-12.90	CS544	24 5.5	
L 90 5.5	[TD61GB]	11.91-01.94	CA857IR	28 55					
LM 621 4.0 Diesel	[D42A]					09.70-06.78	CS726	24 4.0	
LM 641 4.0 Diesel	[D42A]					09.70-06.78	CS726	24 4.0	
LM 841 5.0 Diesel	[D50B]					04.72-05.75	CS726	24 4.0	
LM 845 5.0 Diesel	[D50B]					01.71-12.73	CS726	24 4.0	
LM 846 5.0 Diesel	[D50B]					05.72-12.75	CS726	24 4.0	
ST 256 257 280	[4.107]					01.72-12.75	CS603	12 2.0	
<b>MOTORS</b>									
Engine Diesel	[D45]					06.83-	CS726	24 4.0	
<b>Volvo Penta</b>									
<b>MARINE</b>									
Engine 0.4	[2001]	01.91-	CA1192IR	14 50					
Engine 0.9	[2002]	06.83-01.93	CA1192IR	14 50					
Engine 1.1	[MD11]	07.75-06.83	CA1192IR	14 50					
Engine 1.3	[2003]	06.83-01.93	CA1192IR	14 50					
Engine 1.7	[MD17]	09.75-06.84	CA1192IR	14 50					
Engine 2.0	[AQ130]					01.70-12.77	CS140	12 1.1	
Engine 2.3	[AQ140]					11.75-12.79	CS140	12 1.1	
	[AQ145]	03.79-12.85	CA1192IR	14 50		03.79-12.85	CS140	12 1.1	
Engine 2.4	[TAMD30]	01.83-06.86	CA1192IR	14 50		01.83-06.86	CS1035	12 3.1	
						01.83-06.86	CS783	12 3.0	
	[TMD30]	01.83-06.86	CA1192IR	14 50		01.83-06.86	CS1035	12 3.1	
Engine 3.0	[AQ170]					01.70-12.78	CS140	12 1.1	
Engine 3.5	[TMD40]	02.77-06.86	CA1192IR	14 50					
Engine 3.6	[TMD41B]					01.86-12.97	CS1035	12 3.1	
Engine 5.0	[AQ200]	01.70-	CA1192IR	14 50					
Engine 5.5	[TAMD60]	10.76-10.86	CA132IR	28 45					
		10.86-	CA722IR	28 45					
	[TD60.]	01.82-06.86	CA132IR	28 45		01.82-06.86	CS955	24 5.4	
		01.86-	CA722IR	28 45					
Engine 6.7	[AQD70]					03.71-06.82	CS955	24 5.4	
	[TAMD72]	07.91-	CA858IR	28 55					
Engine	[AQ120]		CA1192IR	14 50					
Engine	[KAD32P]		CA1192IR	14 50		01.97-	CS1035	12 3.1	
	[KAD44P]		CA1192IR	14 50		01.97-	CS1035	12 3.1	
	[MD2010]	01.93-	CA1192IR	14 50					
	[MD2020]	01.93-	CA1192IR	14 50					
	[MD2030]	01.93-	CA1192IR	14 50		01.93-	JS737	12 1.2	
	[MD2040]	01.93-	CA1192IR	14 50		01.93-	JS1102	12 1.4	
	[TMD22P]	01.97-	CA1192IR	14 50					
Various Models			CA857IR	28 55					
<b>VW</b>									
<b>PASSENGER CARS EU</b>									
181 1.5	[H]	09.69-07.70	CG19	14 30		AT 09.69-07.70	CS117	12 0.7	
						09.69-07.70	CS62	12 0.7	
181 1.6	[AG]	08.70-07.73	CG19	14 30		08.70-03.73	CS62	12 0.7	
411 1.7	[V]					AT 08.69-07.73	CS117	12 0.7	
						08.69-07.73	CS62	12 0.7	
	[Z]					AT 08.69-07.73	CS117	12 0.7	
						08.69-07.73	CS62	12 0.7	
411 1.7 E	[W]					AT 08.69-07.72	CS117	12 0.7	
						08.69-07.72	CS62	12 0.7	
412 1.7	[W]					AT 08.69-07.72	CS117	12 0.7	
						08.69-07.72	CS62	12 0.7	



VW Continued

412 1.8 E	[AN]				AT 08.73- 07.74	<b>CS117</b>	12 0.7
	[AT]				08.73- 07.74	<b>CS62</b>	12 0.7
1500 1.5	[K]	08.67- 07.73	<b>CG19</b>	14 30	AT 08.67- 07.73	<b>CS117</b>	12 0.7
					08.66- 07.73	<b>CS62</b>	12 0.7
1600 1.5	[K]	07.68- 07.73	<b>CG19</b>	14 30	AT 08.67- 07.73	<b>CS117</b>	12 0.7
					08.66- 07.73	<b>CS62</b>	12 0.7
1600 1.6	[T]				AT 08.67- 07.73	<b>CS117</b>	12 0.7
	[U]				08.66- 07.73	<b>CS62</b>	12 0.7
1600 1.6 TL	[T]				AT 08.67- 07.73	<b>CS117</b>	12 0.7
	[U]				08.66- 07.73	<b>CS62</b>	12 0.7
Bora 1.4 16V	[AHW]	10.98- 06.05	<b>CA1511IR</b>	14 70	10.98- 06.05	<b>CS1343</b>	12 0.9
		10.98- 06.05	<b>CA1512IR</b>	14 90			
		AC 10.98- 06.05	<b>CA1378IR</b>	14 90			
	[AKQ]	09.98- 05.00	<b>CA1511IR</b>	14 70	09.98- 05.00	<b>CS1343</b>	12 0.9
		09.98- 05.00	<b>CA1512IR</b>	14 90			
		AC 09.98- 05.00	<b>CA1378IR</b>	14 90			
	[APE]	01.99- 05.00	<b>CA1378IR</b>	14 90	01.99- 05.00	<b>CS1062</b>	12 1.1
		01.99- 05.00	<b>CA1511IR</b>	14 70			
		01.99- 05.00	<b>CA1512IR</b>	14 90			
	[AXP]	05.00- 10.01	<b>CA1378IR</b>	14 90	05.00- 10.01	<b>CS1062</b>	12 1.1
		05.00- 10.01	<b>CA1511IR</b>	14 70			
		05.00- 10.01	<b>CA1512IR</b>	14 90			
Bora 1.6	[AEH]	10.98- 06.01	<b>CA1378IR</b>	14 90	10.98- 06.01	<b>CS1062</b>	12 1.1
		10.98- 06.01	<b>CA1436IR</b>	14 70	10.98- 06.01	<b>CS1343</b>	12 0.9
	[AKL]	09.98- 05.05	<b>CA1378IR</b>	14 90	09.98- 05.05	<b>CS1062</b>	12 1.1
		09.98- 05.05	<b>CA1394IR</b>	14 120	09.98- 05.05	<b>CS1343</b>	12 0.9
		09.98- 05.05	<b>CA1436IR</b>	14 70			
	[APF]	05.99- 09.00	<b>CA1378IR</b>	14 90	05.99- 09.00	<b>CS1062</b>	12 1.1
		05.99- 09.00	<b>CA1436IR</b>	14 70			
	[ATN]	08.99- 05.00	<b>CA1378IR</b>	14 90	08.99- 05.00	<b>CS1062</b>	12 1.1
		08.99- 05.00	<b>CA1511IR</b>	14 70			
		08.99- 05.00	<b>CA1512IR</b>	14 90			
		Chas. 1J-X-000001- 08.99- 05.00	<b>CA1512IR</b>	14 90			
	[AVU]	08.00- 05.05	<b>CA1378IR</b>	14 90	08.00- 05.05	<b>CS1062</b>	12 1.1
	08.00- 05.05	<b>CA1394IR</b>	14 120				
	08.00- 05.05	<b>CA1436IR</b>	14 70				
[AWB]	06.02- 10.04	<b>CA1144IR</b>	14 120 BO	AT 06.02- 10.04	<b>CS1062</b>	12 1.1	
	06.02- 10.04	<b>CA1378IR</b>	14 90 VA	06.02- 10.04	<b>CS1119</b>	12 1.1	
[BAD]	08.01- 05.05	<b>CA1733IR</b>	14 110	08.01- 06.02	<b>CS1197</b>	12 1.1	
				08.01- 05.05	<b>CS1282</b>	12 0.9	
[BFQ]	08.00- 05.05	<b>CA1378IR</b>	14 90	08.00- 05.05	<b>CS1062</b>	12 1.1	
	08.00- 05.05	<b>CA1394IR</b>	14 120				
	08.00- 05.05	<b>CA1436IR</b>	14 70				
[BJH]	12.01- 06.06	<b>CA1378IR</b>	14 90	12.01- 06.06	<b>CS1062</b>	12 1.1	
	12.01- 06.06	<b>CA1394IR</b>	14 120				
	12.01- 06.06	<b>CA1436IR</b>	14 70				
Bora 1.6 16V	[ATN]	08.99- 05.00	<b>CA1378IR</b>	14 90	08.99- 05.00	<b>CS1062</b>	12 1.1
		08.99- 05.00	<b>CA1511IR</b>	14 70			
		08.99- 05.00	<b>CA1512IR</b>	14 90			
		Chas. 1J-X-000 001- 08.99- 05.00	<b>CA1512IR</b>	14 90			
	[AUS]	05.00- 10.00	<b>CA1378IR</b>	14 90	05.00- 10.00	<b>CS1062</b>	12 1.1
		05.00- 10.00	<b>CA1511IR</b>	14 70			
		05.00- 10.00	<b>CA1512IR</b>	14 90			
		05.00- 10.00	<b>CA1542IR</b>	14 90			
	[AZD]	09.00- 11.01	<b>CA1504IR</b>	14 70	09.00- 11.01	<b>CS1062</b>	12 1.1
		09.00- 11.01	<b>CA1511IR</b>	14 70			
		09.00- 11.01	<b>CA1512IR</b>	14 90			
		AC 09.00- 11.01	<b>CA1378IR</b>	14 90			
[BCB]	11.01- 05.05	<b>CA1504IR</b>	14 70	11.01- 05.05	<b>CS1062</b>	12 1.1	
	11.01- 05.05	<b>CA1511IR</b>	14 70	11.01- 05.05	<b>CS1343</b>	12 0.9	
	11.01- 05.05	<b>CA1512IR</b>	14 90				
	11.01- 05.05	<b>CA1542IR</b>	14 90				
	AC 11.01- 05.05	<b>CA1378IR</b>	14 90				
Bora 1.8	[AGN]	10.98- 10.00	<b>CA1378IR</b>	14 90	10.98- 10.00	<b>CS1119</b>	12 1.1
		10.98- 10.00	<b>CA1436IR</b>	14 70			
	[ARX]	09.00- 04.01	<b>CA1378IR</b>	14 90	AT 09.00- 04.01	<b>CS1062</b>	12 1.1
		09.00- 04.01	<b>CA1436IR</b>	14 70	09.00- 04.01	<b>CS1119</b>	12 1.1
	[AUM]	09.00- 05.05	<b>CA1378IR</b>	14 90	09.00- 05.05	<b>CS1119</b>	12 1.1
		09.00- 05.05	<b>CA1394IR</b>	14 120			
[BAF]	08.01- 08.01	<b>CA1144IR</b>	14 120	08.01- 08.01	<b>CS1119</b>	12 1.1	
	08.01- 08.01	<b>CA1378IR</b>	14 90	AT 08.01-	<b>CS1062</b>	12 1.1	
	08.01- 08.01	<b>CA1436IR</b>	14 70				
Bora 1.8 4 Motion	[AGN]	02.99- 10.00	<b>CA1378IR</b>	14 90	02.99- 10.00	<b>CS1119</b>	12 1.1
		02.99- 10.00	<b>CA1436IR</b>	14 70			
Bora 1.8 Turbo	[AGU]	05.00- 05.05	<b>CA1378IR</b>	14 90	6SP 05.00- 05.05	<b>CS1181</b>	12 2.0
		05.00- 05.05	<b>CA1436IR</b>	14 70	5SP 05.00- 05.05	<b>CS1119</b>	12 1.1
		09.00- 05.05	<b>CA1394IR</b>	14 120	AT 05.00- 05.05	<b>CS1062</b>	12 1.1
	[ARX]	09.00- 04.01	<b>CA1378IR</b>	14 90	09.00-	<b>CS1181</b>	12 2.0
		09.00- 04.01	<b>CA1394IR</b>	14 120			
		09.00- 04.01	<b>CA1436IR</b>	14 70			
	[AUM]	09.00- 05.05	<b>CA1378IR</b>	14 90	6SP 09.00- 05.05	<b>CS1181</b>	12 2.0
		09.00- 05.05	<b>CA1394IR</b>	14 120	5SP 09.00- 05.05	<b>CS1119</b>	12 1.1
		09.00- 05.05	<b>CA1436IR</b>	14 70	AT 09.00- 05.05	<b>CS1062</b>	12 1.1
	[AUQ]	05.02- 05.03	<b>CA1378IR</b>	14 90	05.02- 05.03	<b>CS1337</b>	12 1.1
		05.02- 05.03	<b>CA1394IR</b>	14 120			
		05.02- 05.03	<b>CA1436IR</b>	14 70			
[BAE]	08.01- 01.06	<b>CA1144IR</b>	14 120 BO	6SP 08.01- 01.06	<b>CS1181</b>	12 2.0	
	08.01- 01.06	<b>CA1378IR</b>	14 90 VA	5SP 08.01- 01.06	<b>CS1119</b>	12 1.1	
				AT 08.01- 01.06	<b>CS1062</b>	12 1.1	
Bora 1.9 SDi	[AGP]	09.98- 04.01	<b>CA1394IR</b>	14 120	09.98- 04.01	<b>CS1287</b>	12 2.0
		09.98- 04.01	<b>CA1446IR</b>	14 90			
		09.98- 04.01	<b>CA1502IR</b>	14 70			





	[AQM]	10.98- 05.05 10.98- 05.05 10.98- 05.05	CA1394IR CA1446IR CA1502IR	14 120 14 90 14 70	Chas. 1J2500001- Chas. -1J2500000	10.98- 05.05 10.98- 05.05	CS1287 CS789	12 2.0 12 1.8	
Bora 1.9 TDi	[AGR]	10.98- 05.05 10.98- 05.05 10.98- 05.05	CA1394IR CA1446IR CA1502IR	14 120 14 90 14 70		AT 10.98- 05.05 AT 10.98- 05.05 10.98- 05.05	CS1287 CS789 CS974	12 2.0 12 1.8 12 1.8	
	[AHF]	10.98- 05.05 10.98- 05.05 10.98- 05.05	CA1394IR CA1446IR CA1502IR	14 120 14 90 14 70		AT 10.98- 05.05 AT 05.00- 05.05 05.99- 05.05	CS789 CS1287 CS974	12 1.8 12 2.0 12 1.8	
	[AJM]	09.98- 05.01 09.98- 05.01 09.98- 05.01 05.99- 05.00	CA1394IR CA1446IR CA1502IR CA1511IR	14 120 14 90 14 70 14 70		09.98- 05.01	CS1181	12 2.0	
	[ALH]	10.98- 05.05 10.98- 05.05 10.98- 05.05	CA1394IR CA1446IR CA1502IR	14 120 14 90 14 70		AT 10.98- 05.05 10.98- 05.05 AT 10.98- 05.05	CS789 CS974 CS1287	12 1.8 12 1.8 12 2.0	
	[ARL]	01.00- 05.05 01.00- 05.05 01.00- 05.05	CA1394IR CA1446IR CA1502IR	14 120 14 90 14 70		01.00- 05.05	CS1181	12 2.0	
	[ASV]	05.00- 05.05 05.00- 05.05 05.00- 05.05	CA1394IR CA1446IR CA1502IR	14 120 14 90 14 70		AT 05.00- 05.05 AT 05.00- 05.05 05.00- 05.05	CS1287 CS789 CS974	12 2.0 12 1.8 12 1.8	
	[ASZ]	01.01- 05.05 01.01- 05.05 01.01- 05.05	CA1394IR CA1446IR CA1502IR	14 120 14 90 14 70		AT, 5SP 01.01- 05.05 01.01- 05.05	CS1390 CS1181	12 2.3 12 2.0	
	[ATD]	01.00- 06.06 01.00- 06.06 01.00- 06.06	CA1394IR CA1446IR CA1502IR	14 120 14 90 14 70		5SP 01.00- 06.06 6SP 01.00- 06.06 AT, 5SP 01.00- 06.06	CS974 CS1181 CS1390	12 1.8 12 2.0 12 2.3	
	[AUY]	01.00- 04.01 01.00- 04.01 01.00- 04.01 01.00- 04.01	CA1394IR CA1446IR CA1502IR CA1511IR	14 120 14 90 14 70 14 70		AT, 5SP 01.00- 04.01 01.00- 04.01	CS1390 CS1181	12 2.3 12 2.0	
	[AXR]	05.01- 05.05 05.01- 05.05 05.01- 05.05	CA1394IR CA1446IR CA1502IR	14 120 14 90 14 70		5SP 05.01- 05.05 6SP 05.01- 05.05 AT, 5SP 05.01- 05.05	CS974 CS1181 CS1390	12 1.8 12 2.0 12 2.3	
	Bora 1.9 TDi 4 Motion	[AGR]	02.99- 05.05 02.99- 05.05 02.99- 05.05	CA1394IR CA1446IR CA1502IR	14 120 14 90 14 70		AT 02.99- 05.05 02.99- 05.05	CS789 CS974	12 1.8 12 1.8
		[AJM]	09.98- 05.01 09.98- 05.01 09.98- 05.01	CA1394IR CA1446IR CA1502IR	14 120 14 90 14 70		AT 09.98- 05.01 09.98- 05.01	CS1390 CS1181	12 2.3 12 2.0
		[ALH]	09.98- 05.05 09.98- 05.05 09.98- 05.05	CA1394IR CA1446IR CA1502IR	14 120 14 90 14 70		AT 09.98- 05.05 09.98- 05.05	CS789 CS974	12 1.8 12 1.8
		[ARL]	09.00- 05.05 09.00- 05.05 09.00- 05.05	CA1394IR CA1446IR CA1502IR	14 120 14 90 14 70		09.00- 05.05	CS1181	12 2.0
		[ASZ]	01.01- 05.05 01.01- 05.05 01.01- 05.05	CA1394IR CA1446IR CA1502IR	14 120 14 90 14 70		AT, 5SP 01.01- 05.05 01.01- 05.05	CS1390 CS1181	12 2.3 12 2.0
		[ATD]	01.00- 06.06 01.00- 06.06 01.00- 06.06	CA1394IR CA1446IR CA1502IR	14 120 14 90 14 70		5SP 01.00- 06.06 6SP 01.00- 06.06 AT, 5SP 01.00- 06.06	CS974 CS1181 CS1390	12 1.8 12 2.0 12 2.3
		[AUY]	05.00- 04.01 05.00- 04.01 05.00- 04.01	CA1394IR CA1446IR CA1502IR	14 120 14 90 14 70		05.00- 04.01 AT, 5SP 05.00- 04.01	CS1181 CS1390	12 2.0 12 2.3
		Bora 2.0	[APK]	10.98- 05.05 10.98- 05.05	CA1378IR CA1436IR	14 90 14 70		10.98- 05.05 AT 10.98- 05.05	CS1119 CS1062
[AQY]			09.98- 05.05 09.98- 05.05 09.98- 05.05	CA1378IR CA1394IR CA1436IR	14 90 14 120 14 70		AT 09.98- 05.05 09.98- 05.05	CS1062 CS1119	12 1.1 12 1.1
[AZG]			05.01- 05.05 05.01- 05.05 05.01- 05.05	CA1378IR CA1394IR CA1436IR	14 90 14 120 14 70		AT 05.01- 05.05 05.01- 05.05	CS1062 CS1119	12 1.1 12 1.1
[AZH]			04.00- 06.01 04.00- 06.01 04.00- 06.01	CA1378IR CA1394IR CA1436IR	14 90 14 120 14 70		04.00- 06.01 AT 04.00- 06.01	CS1119 CS1062	12 1.1 12 1.1
[AZJ]			05.01- 05.05 05.01- 05.05 05.01- 05.05	CA1378IR CA1394IR CA1436IR	14 90 14 120 14 70		AT 05.01- 05.05 05.01- 05.05	CS1062 CS1119	12 1.1 12 1.1
Bora 2.0 4 Motion	[AZH]		04.00- 05.05 04.00- 05.05 04.00- 05.05	CA1378IR CA1394IR CA1436IR	14 90 14 120 14 70		04.00- 05.05 AT 04.00- 05.05	CS1119 CS1062	12 1.1 12 1.1
	[AZJ]		05.01- 05.05 05.01- 05.05 05.01- 05.05	CA1378IR CA1394IR CA1436IR	14 90 14 120 14 70		AT 05.01- 05.05 05.01- 05.05	CS1062 CS1119	12 1.1 12 1.1
Bora 2.3 V5	[AGZ]		10.98- 02.01 10.98- 02.01 10.98- 02.01	CA1394IR CA1446IR CA1502IR	14 120 14 90 14 70		10.98- 02.01 AT 10.98- 02.01 AT 10.98- 02.01	CS1266 CS1287 CS789	12 1.8 12 2.0 12 1.8
	[AQN]		09.00- 05.05 09.00- 05.05 09.00- 05.05	CA1394IR CA1446IR CA1502IR	14 120 14 90 14 70		09.00- 05.05	CS1266	12 1.8
	Bora 2.3 V5 4 Motion		[AGZ]	12.98- 02.01 12.98- 02.01 12.98- 02.01	CA1394IR CA1446IR CA1502IR	14 120 14 90 14 70		12.98- 02.01 AT 12.98- 02.01	CS1266 CS789
[AQN]		09.00- 05.05 09.00- 05.05 09.00- 05.05	CA1394IR CA1446IR CA1502IR	14 120 14 90 14 70		09.00- 05.05	CS1266	12 1.8	
Bora 2.8 V6 4 Motion		[AQP]	05.99- 05.00 05.99- 05.00	CA1446IR CA1502IR	14 90 14 70		05.99- 05.00	CS1181	12 2.0
	[AUE]	01.00- 04.01 01.00- 04.01 01.00- 04.01	CA1394IR CA1446IR CA1502IR	14 120 14 90 14 70		AT 01.00- 04.01 01.00- 04.01	CS1477* CS1181	12 1.4 12 2.0	
	[BDE]	05.01- 05.05 05.01- 05.05 05.01- 05.05	CA1394IR CA1446IR CA1502IR	14 120 14 90 14 70		05.01- 05.05	CS1181	12 2.0	
	Bora 2.8 VR6	[AUE]	03.00- 05.00 03.00- 05.00 03.00- 05.00	CA1394IR CA1446IR CA1502IR	14 120 14 90 14 70		03.00- 05.00 AT 03.00- 05.00	CS1181 CS1477*	12 2.0 12 1.4
		Caddy 1.2 CDTi 16V	[CBZA]				09.10-	CS1322	12 1.1
Caddy 1.4			[AEX]	11.95- 12.97 11.95- 12.97 PS 11.95- 12.97 PS 11.95- 12.97	CA733IR CA740IR CA736IR CA827IR	14 70 14 90 14 90 14 70		11.95- 12.97 11.95- 12.97	CS880 CS788



VW Continued

	[AKV]	11.97- 09.00 CA733IR 14 70	11.97- 09.00 CS788 12 0.9
		11.97- 09.00 CA740IR 14 90	11.97- 09.00 CS880 12 1.1
		PS 11.97- 09.00 CA736IR 14 90	
		PS 11.97- 09.00 CA827IR 14 70	
	[APQ]	12.97- 06.03 CA733IR 14 70	12.97- 06.03 CS788 12 0.9
		12.97- 06.03 CA740IR 14 90	12.97- 06.03 CS880 12 1.1
		PS 12.97- 06.03 CA736IR 14 90	
		PS 12.97- 06.03 CA827IR 14 70	
	[AUA]	08.00- 06.03 CA1502IR 14 70	08.00- 06.03 CS880 12 1.1
		08.00- 06.03 CA1542IR 14 90	
	[AUD]	09.00- 06.03 CA1504IR 14 70	09.00- 06.03 CS788 12 0.9
		09.00- 06.03 CA1542IR 14 90	09.00- 06.03 CS880 12 1.1
	[BCA]	03.04- 05.06 CA1560IR 14 90	03.04- 05.06 CS1322 12 1.1
		03.04- 05.06 CA1815IR# 14 110	
		AC 03.04- 05.06 CA1729IR 14 110	
Caddy 1.4 16V	[AUA]	08.00- 06.03 CA1504IR 14 70	08.00- 06.03 CS880 12 1.1
		08.00- 06.03 CA1542IR 14 90	
	[BUD]	05.06- CA1729IR 14 110	05.06- CS1322 12 1.1
Caddy 1.5	[JB]	08.82- 07.83 CA140IR 14 45	08.82- 07.83 CS116 12 0.8
		08.82- 07.83 CA141IR 14 65	
		08.82- 07.83 CA241IR 14 55	
Caddy 1.6	[1F]	11.95- 05.97 CA733IR 14 70	11.95- 05.97 CS618 12 1.1
		11.95- 05.97 CA740IR 14 90	11.95- 05.97 CS1062 12 1.1
		AC 11.95- 05.97 CA736IR 14 90	
	[AEE]	06.96- 12.00 CA733IR 14 70	06.96- 12.00 CS880 12 1.1
		06.96- 12.00 CA827IR 14 70	06.96- 12.00 CS798 12 1.0
		06.97- 09.00 CA736IR 14 90	06.96- 12.00 CS788 12 0.9
		PS 06.96- 12.00 CA827IR 14 70	
		AC 06.96- 12.00 CA736IR 14 90	
	[BGU]	04.04- 05.05 CA1378IR 14 90	04.04- 05.05 CS1322 12 1.1
		04.04- 05.05 CA1782IR 14 140	
		04.04- 05.05 CA1818IR 14 110	
	[BSE]	06.05- CA1378IR 14 90	06.05- CS1322 12 1.1
		06.05- CA1782IR 14 140	
		06.05- CA1818IR 14 110	
	[BSF]	03.05- CA1378IR 14 90	03.05- CS1322 12 1.1
		03.05- CA1782IR 14 140	
		03.05- CA1818IR 14 110	
	[EM]	08.82- 07.83 CA140IR 14 45	08.82- 07.83 CS116 12 0.8
		08.82- 07.83 CA141IR 14 65 ▲	
		08.82- 07.83 CA241IR 14 55	
	[EW]	08.83- 07.85 CA140IR 14 45	08.86- 07.92 CS294 12 0.9
		08.83- 07.85 CA141IR 14 65	AT 08.83- 07.92 CS276 12 0.7
		08.83- 07.85 CA241IR 14 55	08.83- 07.86 CS116 12 0.8
		08.83- 07.85 CA242IR 14 65	
		08.83- 07.92 CA320IR 14 90	
		08.85- 07.92 CA296IR 14 55	
		08.85- 07.92 CA298IR 14 65	
Caddy 1.6 Diesel	[JK]	08.82- 07.85 CA136IR 14 45	08.82- 07.90 CS272 12 1.7
		08.82- 07.85 CA139IR 14 65	
		08.85- 07.90 CA319IR 14 65	
	[ME]	08.90- 07.92 CA319IR 14 65	08.90- 07.92 CS272 12 1.7
Caddy 1.6 TDi	[CAYD]	08.10- CA1782IR 14 140	A25 08.10- CS1505* 12 2.0
		08.10- CA1810IR 14 110	
		A25 08.10- CA2011IR 14 140	
	[CAYE]	08.10- CA1782IR 14 140	A25 08.10- CS1505* 12 2.0
		08.10- CA1810IR 14 110	
		A25 08.10- CA2011IR 14 140	
Caddy 1.7 SDi	[AHB]	07.96- 09.00 CA1260IR 14 120	07.96- 09.00 CS789 12 1.8
		Chas. 9K-X-515716- 09.98- 09.00 CA1510IR 14 70	
		Chas. -9K-X-515715 07.96- 09.98 CA1297IR 14 90	
Caddy 1.8	[JH]	08.85- 07.92 CA296IR 14 55	AT 08.85- 07.92 CS392 12 0.9
		08.85- 07.92 CA298IR 14 65	08.85- 07.92 CS294 12 0.9
		08.85- 07.92 CA320IR 14 90	
Caddy 1.9 Diesel	[1Y]	11.95- 06.03 CA733IR 14 70	02.02- 06.03 CS1287 12 2.0
		AC 11.95- 06.03 CA736IR 14 90	11.95- 06.03 CS789 12 1.8
	[AEF]	06.96- 12.00 CA1240IR 14 90	06.96- 12.00 CS1047 12 1.8
		06.96- 12.00 CA1255IR 14 70	
Caddy 1.9 SDi	[AEY]	11.95- 09.00 CA1260IR 14 120	11.95- 09.00 CS789 12 1.8
		11.95- 09.00 CA736IR 14 90	
		11.95- 09.00 CA827IR 14 70	
		Chas. 9K-X-515716- 09.98- 09.00 CA1510IR 14 70	
		Chas. -9K-X-515715 11.95- 08.98 CA1297IR 14 90	
		AC 11.95- 09.00 CA736IR 14 90	
		AC 11.95- 09.00 CA827IR 14 70	
	[AYQ]	09.00- 06.03 CA1394IR 14 120	09.00- 06.03 CS1287 12 2.0
		09.00- 06.03 CA1446IR 14 90	09.00- 06.03 CS789 12 1.8
		09.00- 06.03 CA1502IR 14 70	
Caddy 1.9 TDi	[1Z]	10.96- 03.97 CA1260IR 14 120	10.96- 03.97 CS974 12 1.8
		10.96- 03.97 CA1297IR 14 90	
		10.96- 03.97 CA1510IR 14 70	
	[AHU]	10.96- 09.00 CA1260IR 14 120	10.96- 09.00 CS974 12 1.8
		Chas. 9K-X-515716- 08.98- 09.00 CA1510IR 14 70	
		Chas. -9K-X-515715 10.96- 09.98 CA1297IR 14 90	
	[ALE]	09.97- 09.00 CA1260IR 14 120	09.97- 09.00 CS974 12 1.8
		Chas. 9K-X-515716- 09.97- 09.00 CA1510IR 14 70	
		Chas. -9K-X-515715 09.97- 09.00 CA1297IR 14 90	
	[ALH]	09.98- 05.05 CA1394IR 14 120	09.98- 05.05 CS974 12 1.8
		09.98- 05.05 CA1446IR 14 90	AT 09.98- 05.05 CS789 12 1.8
		09.98- 05.05 CA1502IR 14 70	
	[BJB]	04.04- CA1782IR 14 140	04.04- CS1293 12 2.0
		04.04- CA1810IR 14 110	
	[BLS]	06.05- CA1782IR 14 140	06.05- CS1293 12 2.0
		06.05- CA1810IR 14 110	
	[BSU]	09.05- CA1782IR 14 140	09.05- CS1293 12 2.0
		09.05- CA1810IR 14 110	
Caddy 1.9 TDi 4 Motion	[BJB]	05.08- CA1782IR 14 140	05.08- CS1293 12 2.0
		05.08- CA1810IR 14 110	
	[BLS]	05.08- CA1782IR 14 140	05.08- CS1293 12 2.0
		05.08- CA1810IR 14 110	
Caddy 1.9 TDi 4motion	[BLS]	11.08- 08.10 CA1782IR 14 140	11.08- 08.10 CS1323 12 2.0
		11.08- 08.10 CA1810IR 14 110	
Caddy 2.0 SDi	[BDJ]	03.04- CA1782IR 14 140	03.04- CS1397 12 1.7
		03.04- CA1810IR 14 110	



	[BST]	06.05-06.05-	CA1782IR	14 140		06.05-	CS1397	12 1.7
			CA1810IR	14 110				
Caddy 2.0 TDi 16V	[CFHC]	11.10-11.10- A25 11.10-	CA1782IR	14 140		11.10-	CS1323	12 2.0
			CA1810IR	14 110				
			CA2011IR	14 140				
Caddy 2.0 TDi 16V 4motion	[CFHC]	11.10-11.10- 11.10-	CA1782IR	14 140		11.10- A25 11.10-	CS1323 CS1508*	12 2.0 12 1.7
			CA1810IR	14 110				
			CA2011IR	14 140				
Caddy 2.0 TDi	[BMM]	09.07-09.07-	CA1782IR	14 140		6SP 09.07-	CS1323	12 2.0
			CA1810IR	14 110				
	[CFHE]	11.10-11.10-	CA1782IR	14 140		11.10-	CS1323	12 2.0
			CA1810IR	14 110				
Caddy 2.0 TDi 4motion	[CFHE]					12.10-	CS1323	12 2.0
	[CFHF]	08.10-08.10- A25 08.10-	CA1782IR	14 140		08.10-	CS1323	12 2.0
			CA1810IR	14 110				
			CA2011IR	14 140				
Caddy 2.0 EcoFuel	[BSX]	04.06-04.06-	CA1782IR	14 140		04.06-	CS1322	12 1.1
			CA1818IR	14 110				
Caravelle 1.8	[PD]	12.90-07.92 05.91-07.92	CA298IR	14 65		12.90-07.92	CS597	12 1.1
			CA320IR	14 90				
Corrado 1.8 16V	[KR]	09.88-07.89 09.88-07.89 08.89-07.92	CA342IR	14 65		AT 08.91-07.92 08.90-07.91 08.91-07.92	CS618 CS601 CS619	12 1.1 12 1.1 12 1.1
			CA343IR	14 90				
			CA521IR	14 90		AT 09.88-07.91 09.88-07.90	CS294 CS559	12 0.9 12 1.0
Corrado 1.8 G60	[PG]	09.88-09.93 09.88-09.93	CA840IR	14 65		AT 08.91-09.93 08.91-09.93	CS618 CS619	12 1.1 12 1.1
			CA841IR	14 90		AT 09.88-07.91 09.88-07.90	CS294 CS559	12 0.9 12 1.0
						08.90-07.91	CS601	12 1.1
Corrado 2.0 i 16V	[9A]	08.91-07.95	CA521IR	14 90		08.91-07.95 AT 08.91-07.95	CS619 CS618	12 1.1 12 1.1
Corrado 2.0 i	[2E]	04.93-09.94 04.93-09.94 AC 04.93-09.94	CA733IR	14 70		04.93-09.94	CS619	12 1.1
			CA740IR	14 90				
			CA736IR	14 90				
	[ADY]	10.94-07.95 10.94-07.95	CA733IR	14 70		AT 10.94-07.95	CS618	12 1.1
			CA740IR	14 90		10.94-07.95	CS619	12 1.1
Corrado 2.9 VR6	[ABV]	08.91-07.92 08.91-06.95 06.95-12.95	CA827IR	14 70		08.91-12.95 AT 08.91-12.95	CS620 CS713	12 1.7 12 1.8
			CA828IR	14 120 ▲				
			CA1142IR	14 120				
Crafter 30-35 2.5 TDi	[BJJ]	04.06-04.06- 04.06-	CA1782IR	14 140		04.06-	CS1435	12 2.0
			CA1810IR	14 110				
			CA1912IR	14 180				
	[BJK]	04.06-04.06- 04.06-	CA1782IR	14 140		04.06-	CS1435	12 2.0
			CA1810IR	14 110				
			CA1912IR	14 180				
	[BJL]	04.06-04.06- 04.06-	CA1782IR	14 140		04.06-	CS1435	12 2.0
			CA1810IR	14 110				
			CA1912IR	14 180				
	[BJM]	04.06-04.06- 04.06-	CA1782IR	14 140		04.06-	CS1435	12 2.0
			CA1810IR	14 110				
			CA1912IR	14 180				
Crafter 30-50 2.5 TDi	[BJJ]	04.06-04.06- 04.06-	CA1782IR	14 140		04.06-	CS1435	12 2.0
			CA1810IR	14 110				
			CA1912IR	14 180				
	[BJK]	04.06-04.06- 04.06-	CA1782IR	14 140		04.06-	CS1435	12 2.0
			CA1810IR	14 110				
			CA1912IR	14 180				
	[BJL]	04.06-04.06- 04.06-	CA1782IR	14 140		04.06-	CS1435	12 2.0
			CA1810IR	14 110				
			CA1912IR	14 180				
	[BJM]	04.06-04.06- 04.06-	CA1782IR	14 140		04.06-	CS1435	12 2.0
			CA1810IR	14 110				
			CA1912IR	14 180				
Derby 0.9	[HA]	02.77-07.79 08.79-09.81 02.80-09.81	CA85IR	14 55		02.77-09.81	CS79	12 0.8
			CA139IR	14 65				
			CA136IR	14 45				
Derby 1.0	[GL]	10.81-12.84 10.81-12.84 08.83-12.84	CA136IR	14 45		08.84-12.84 10.81-07.84	CS293 CS79	12 0.8 12 0.8
			CA139IR	14 65				
			CA85IR	14 55				
Derby 1.1	[HB]	02.77-01.80 08.79-07.83 02.80-07.83	CA85IR	14 55		01.77-07.83	CS79	12 0.8
			CA139IR	14 65				
			CA136IR	14 45				
Derby 1.3	[GK]	09.82-12.84 09.82-12.84 08.83-12.84	CA136IR	14 45		08.84-12.84 09.82-07.84	CS293 CS79	12 0.8 12 0.8
			CA139IR	14 65				
			CA85IR	14 55				
	[HH]	02.77-07.79 08.79-07.83 02.80-07.83	CA85IR	14 55		01.77-07.83	CS79	12 0.8
			CA139IR	14 65				
			CA136IR	14 45				
	[HJ]	01.77-09.81 01.77-07.79 08.79-09.81	CA136IR	14 45		01.77-09.81	CS79	12 0.8
			CA85IR	14 55				
			CA139IR	14 65				
	[HK]	08.83-12.84 08.83-12.84 08.83-12.84	CA136IR	14 45		08.84-12.84 08.83-07.84	CS293 CS79	12 0.8 12 0.8
			CA139IR	14 65				
			CA85IR	14 55				
Eos 1.4 TSi	[CAVD]	05.08-05.08-	CA1817IR	14 110		05.08-	CS1294	12 1.1
			CA1985IR	14 140				
	[CAXA]	05.08-	CA1985IR	14 140		05.08-	CS1294	12 1.1
EOS 1.6 FSi	[BLF]	06.06-	CA1817IR	14 110		06.06-	CS1322	12 1.1
EOS 2.0 FSi	[BVY]	03.06-	CA1782IR	14 140		03.06-	CS1294	12 1.1
			CA1818IR	14 110				
EOS 2.0 TFSi	[BWA]	03.06-03.06-	CA1782IR	14 140		AT 03.06- 03.06-	CS1409 CS1347	12 1.0 12 1.1
			CA1818IR	14 110		AT 03.06-	CS1286	12 2.0
	[CAWB]	03.06-03.06-	CA1782IR	14 140		03.06-	CS1347	12 1.1
			CA1818IR	14 110		AT 03.06-	CS1286	12 2.0
	[CCZA]	05.09-	CA1811IR	14 140		05.09- AT 05.09-	CS1347 CS1409	12 1.1 12 1.0
EOS 2.0 TSi	[CCZB]	11.09-	CA1811IR	14 140		DKG 11.09- 11.09-	CS1409 CS1347	12 1.0 12 1.1
EOS 2.0 TDi 16V	[CBAB]	05.08-	CA1782IR	14 140		05.08- DKG 05.08-	CS1323 CS1286	12 2.0 12 2.0
						AT 06.06- 06.06-	CS1286 CS1283	12 2.0 12 2.0
EOS 2.0 TDi	[BMM]	06.06-06.06-	CA1782IR	14 140				
			CA1810IR	14 110				



VW Continued

	[CFFA]				A25 05.08-05.08-	CS1508*	12 1.7
EOS 3.2 FSi	[BUB]	06.06-06.06-	CA1782IR	14 140	AT 06.06-	CS1323	12 2.0
			CA1810IR	14 110		CS1286	12 2.0
	[CBRA]				06.08-	CS1286	12 2.0
Eos 3.6 V6	[CDVA]				05.09-	CS1286	12 2.0
Fox 1.2	[BMD]	04.05-04.05-	CA1675IR	14 90	04.05-	CS1282	12 0.9
			CA1755IR	14 70			
	[CHFA]	09.10-09.10-	CA1675IR	14 90	09.10-	CS1282	12 0.9
			CA1755IR	14 70			
Fox 1.4	[BKR]	04.05-04.05-	CA1560IR	14 90	04.05-	CS1282	12 0.9
			CA1568IR	14 70			
		AC 04.05-	CA1542IR	14 90			
Fox 1.4 TDi	[BNM]	04.05-04.05-	CA1446IR	14 90	04.05-	CS1200	12 2.0
			CA2064IR*	14 90			
Golf 1.2 TSi	[CBZA]				05.10-	CS1322	12 1.1
Golf 1.6 Bi-Fuel Plus	[CHGA]	05.09-	CA1818IR	14 110	05.09-	CS1324	12 1.0
Golf 1.6 TDi Plus	[CAYB]	02.09-02.09-	CA1782IR	14 140			
			CA2011IR	14 140			
Golf VI 1.2 TSi	[CBZA]				05.10-	CS1322	12 1.1
	[CBZB]				06.11-	CS1322	12 1.1
Golf VI 1.4 TSi	[CAVD]	06.11-06.11-	CA1921IR	14 110	06.11-	CS1294	12 1.1
			CA1985IR	14 140			
		06.11-	CA1921IR	14 110			
Golf VI 1.6 MultiFuel	[CMXA]	07.09-07.09-	CA1782IR	14 140	07.09-	CS1324	12 1.0
			CA1921IR	14 110			
		07.09-	CA2011IR	14 140			
Golf VI 1.6 TDi	[CAYC]	06.11-06.11-	CA1782IR	14 140	A25 06.11-	CS1505*	12 2.0
		A25 06.11-	CA2011IR	14 140			
Golf I 1.1	[FA]	04.74-07.79	CA136IR	14 45	04.74-07.79	CS79	12 0.8
		04.74-07.79	CA85IR	14 55			
	[FJ]	08.74-07.79	CA85IR	14 55	08.74-07.79	CS79	12 0.8
	[GG]	08.79-07.83	CA139IR	14 65	08.81-07.83	CS293	12 0.8
		02.80-07.83	CA136IR	14 45	08.79-07.83	CS79	12 0.8
Golf I 1.3	[GF]	09.79-07.83	CA139IR	14 65	08.79-07.83	CS79	12 0.8
		02.80-07.83	CA136IR	14 45			
	[GS]	08.82-07.83	CA136IR	14 45	08.82-07.83	CS79	12 0.8
		08.82-07.83	CA139IR	14 65	08.82-07.83	CS293	12 0.8
Golf I 1.5	[FH]	04.74-12.75	CA52IR	14 55	AT 04.74-12.75	CS276	12 0.7
					08.75-12.75	CS116	12 0.8
	[JB]	04.74-07.79	CA35IR	14 35	AT 04.74-07.83	CS276	12 0.7
		08.76-07.79	CA52IR	14 55	08.75-07.83	CS116	12 0.8
		08.79-07.83	CA140IR	14 45			
		08.79-07.83	CA141IR	14 65			
Golf I 1.5 Diesel	[CK]	08.77-07.79	CA85IR	14 55			
		08.79-07.80	CA136IR	14 45			
		08.79-07.80	CA139IR	14 65			
Golf I 1.6	[EG]	01.79-07.82	CA140IR	14 45	AT 08.79-07.82	CS276	12 0.7
		01.79-07.82	CA141IR	14 65	01.79-07.82	CS116	12 0.8
		01.79-07.82	CA52IR	14 55			
	[EW]	01.83-02.84	CA140IR	14 45	08.83-12.92	CS294	12 0.9
		01.83-02.84	CA141IR	14 65	AT 01.83-12.92	CS276	12 0.7
		08.83-07.85	CA241IR	14 55	01.83-02.84	CS116	12 0.8
		08.83-07.85	CA242IR	14 65			
		08.83-12.92	CA320IR	14 90			
		08.85-12.92	CA296IR	14 55			
		08.85-12.92	CA298IR	14 65			
	[FN]	08.75-07.77	CA35IR	14 35	08.75-07.77	CS116	12 0.8
		08.75-07.77	CA52IR	14 55	AT 08.75-07.77	CS276	12 0.7
	[FP]	08.75-07.77	CA35IR	14 35	AT 08.75-07.77	CS276	12 0.7
		08.75-07.77	CA52IR	14 55	08.75-07.77	CS116	12 0.8
	[FT]	08.75-07.77	CA52IR	14 55	AT 08.75-07.77	CS276	12 0.7
					08.75-07.77	CS116	12 0.8
	[HN]	01.83-02.84	CA140IR	14 45	01.83-02.84	CS276	12 0.7
		01.83-02.84	CA141IR	14 65	01.83-02.84	CS116	12 0.8
	[RE]	04.86-07.90	CA296IR	14 55	04.86-07.90	CS116	12 0.8
		04.86-07.90	CA298IR	14 65	04.86-02.90	CS294	12 0.9
		04.86-07.90	CA320IR	14 90	AT 04.86-02.90	CS276	12 0.7
Golf I 1.6 GTi	[EG]	08.76-08.77	CA35IR	14 35	06.76-07.82	CS116	12 0.8
		08.76-07.79	CA52IR	14 55			
		09.77-07.82	CA140IR	14 45			
		09.77-07.82	CA141IR	14 65			
Golf I 1.6 Diesel	[CR]	08.80-07.83	CA136IR	14 45	AT 08.80-07.83	CS348	12 1.7
		08.80-07.83	CA139IR	14 65	08.80-07.83	CS272	12 1.7
		AC 08.80-07.83	CA237IR	14 65			
	[JK]	08.80-07.83	CA136IR	14 45	08.80-07.83	CS272	12 1.7
		08.80-07.83	CA139IR	14 65	AT 08.80-07.83	CS348	12 1.7
		AC 08.80-07.83	CA237IR	14 65			
Golf I 1.6 TD	[CY]	03.82-07.83	CA136IR	14 45	03.82-07.83	CS272	12 1.7
		03.82-07.83	CA139IR	14 65	AT 03.82-07.83	CS348	12 1.7
Golf I 1.8	[ZH]	08.89-08.93	CA296IR	14 55	08.89-08.93	CS294	12 0.9
		08.89-08.93	CA298IR	14 65			
		08.89-08.93	CA320IR	14 90			
	[DX]	08.82-07.83	CA140IR	14 45	08.83-07.92	CS294	12 0.9
		08.82-07.83	CA141IR	14 65			
		08.82-07.92	CA320IR	14 90			
		08.83-07.85	CA241IR	14 55			
		08.83-07.85	CA242IR	14 65			
		08.85-07.92	CA296IR	14 55			
		08.85-07.92	CA298IR	14 65			
	[EV]	01.84-07.85	CA241IR	14 55	01.84-07.87	CS294	12 0.9
		01.84-07.85	CA242IR	14 65			
		01.84-07.87	CA320IR	14 90			
		08.85-07.87	CA296IR	14 55			
		08.85-07.87	CA298IR	14 65			
	[EX]	08.83-07.85	CA241IR	14 55	08.83-12.92	CS294	12 0.9
		08.83-07.85	CA242IR	14 65	AT 08.83-12.92	CS392	12 0.9
		08.83-12.92	CA320IR	14 90			
		08.85-12.92	CA296IR	14 55			
		08.85-12.92	CA298IR	14 65			



	[JH]	08.83- 07.85	CA2411R	14 55	08.83- 08.93	CS294	12 0.9	
		08.83- 07.85	CA2421R	14 65	AT 08.83- 08.93	CS276	12 0.7	
		08.83- 08.93	CA3201R	14 90	AT 08.83- 04.93	CS392	12 0.9	
		08.85- 08.93	CA2961R	14 55				
		08.85- 08.93	CA2981R	14 65				
	[PB]	01.87- 07.92	CA2961R	14 55	01.87- 07.92	CS294	12 0.9	
		01.87- 07.92	CA2981R	14 65				
		01.87- 07.92	CA3201R	14 90				
Golf I 1.8 GTI	[DX]	08.82- 07.83	CA1401R	14 45				
		08.82- 07.83	CA1411R	14 65				
	[JU]	08.82- 07.83	CA1401R	14 45				
		08.82- 07.83	CA1411R	14 65				
Golf II 1.0	[GN]	08.83- 07.85	CA2761R	14 65	08.83- 07.85	CS293	12 0.8	
		08.85- 10.91	CA3761R	14 65	08.85- 10.91	CS293	12 0.8	
	[HZ]	08.85- 10.91	CA5881R	14 55				
Golf II 1.3	[ZG]	01.89- 07.92	CA3761R	14 65	01.89- 07.92	CS293	12 0.8	
		01.89- 07.92	CA5881R	14 55				
	[GT]	08.83- 07.85	CA2761R	14 65	08.83- 07.87	CS293	12 0.8	
		07.85- 07.87	CA3761R	14 65				
		07.85- 07.87	CA5881R	14 55				
	[HK]	08.83- 07.85	CA2761R	14 65	08.83- 07.85	CS293	12 0.8	
	[MH]	08.85- 12.88	CA3761R	14 65	08.85- 12.88	CS293	12 0.8	
		08.85- 12.88	CA5881R	14 55				
	[NU]	08.85- 12.87	CA3761R	14 65	08.85- 12.87	CS293	12 0.8	
		08.85- 12.87	CA5881R	14 55				
	[NZ]	08.85- 07.92	CA3761R	14 65	08.85- 07.92	CS293	12 0.8	
		08.85- 07.92	CA5881R	14 55				
	Golf II 1.6	[ABN]	08.91- 07.92	CA2961R	14 55	AT 08.91- 07.92	CS276	12 0.7
			08.91- 07.92	CA2981R	14 65	08.91- 07.92	CS294	12 0.9
08.91- 07.92			CA3201R	14 90				
08.91- 07.92			CA3761R	14 65				
[EZ]		08.83- 07.85	CA2411R	14 55	08.83- 08.91	CS294	12 0.9	
		08.83- 07.85	CA2421R	14 65	AT 08.83- 08.91	CS276	12 0.7	
	[HM]	08.83- 08.91	CA3201R	14 90				
		08.85- 08.91	CA2961R	14 55				
		08.85- 08.91	CA2981R	14 65				
		08.83- 07.85	CA2411R	14 55	AT 08.83- 07.88	CS276	12 0.7	
		08.83- 07.85	CA2421R	14 65	08.83- 07.88	CS294	12 0.9	
[PN]	10.86- 07.92	CA2961R	14 55	08.86- 07.92	CS294	12 0.9		
	10.86- 07.92	CA2981R	14 65	AT 08.86- 07.92	CS276	12 0.7		
	10.86- 07.92	CA3201R	14 90					
[RF]	02.86- 10.91	CA2961R	14 55	AT 02.86- 10.91	CS276	12 0.7		
	02.86- 10.91	CA2981R	14 65	02.86- 10.91	CS294	12 0.9		
	02.86- 10.91	CA3201R	14 90					
Golf II 1.6 Diesel	[JP]	08.83- 07.85	CA2761R	14 65	AT 08.83- 10.91	CS348	12 1.7	
		08.83- 07.85	CA2771R#	14 45	08.83- 10.91	CS295	12 1.7	
		08.85- 10.91	CA2971R	14 45				
		08.85- 10.91	CA3021R	14 65				
		08.85- 10.91	CA3761R	14 65				
		08.85- 10.91	CA5051R	14 45				
		AC 08.83- 05.84	CA3181R	14 90				
	AC 05.84- 10.91	CA10581R	14 90					
	[ME]	05.88- 10.91	CA2971R	14 45	AT 05.88- 10.91	CS348	12 1.7	
		05.88- 10.91	CA3021R	14 65	05.88- 10.91	CS295	12 1.7	
05.88- 10.91		CA3761R	14 65					
05.88- 10.91		CA5051R	14 45					
AC 05.88- 10.91	CA10581R	14 90						
Golf II 1.6 TD	[IV]	08.89- 07.92	CA2971R	14 45	08.89- 07.92	CS295	12 1.7	
		08.89- 07.92	CA3021R	14 65	AT 08.89- 07.92	CS348	12 1.7	
		08.89- 07.92	CA3761R	14 65				
		08.89- 07.92	CA5051R	14 45				
		AC 08.89- 07.92	CA10581R	14 90				
	[JR]	08.83- 07.85	CA2761R	14 65	AT 08.83- 10.91	CS348	12 1.7	
		08.83- 07.85	CA2771R#	14 45	08.83- 10.91	CS295	12 1.7	
		08.85- 10.91	CA2971R	14 45				
		08.85- 10.91	CA3021R	14 65				
		08.85- 10.91	CA3761R	14 65				
[MF]	08.85- 10.91	CA5051R	14 45					
	AC 08.83- 05.84	CA3181R	14 90					
	AC 05.84- 10.91	CA10581R	14 90					
	05.88- 10.91	CA2971R	14 45	05.88- 10.91	CS295	12 1.7		
	05.88- 10.91	CA3021R	14 65	AT 05.88- 10.91	CS348	12 1.7		
[RA]	04.89- 02.90	CA2971R	14 45	04.89- 02.90	CS295	12 1.7		
	04.89- 02.90	CA3021R	14 65	AT 04.89- 02.90	CS348	12 1.7		
	04.89- 02.90	CA3761R	14 65					
	04.89- 02.90	CA5051R	14 45					
	AC 04.89- 02.90	CA10581R	14 90					
[SB]	04.89- 10.91	CA2971R	14 45	04.89- 10.91	CS295	12 1.7		
	04.89- 10.91	CA3021R	14 65	AT 04.89- 10.91	CS348	12 1.7		
	04.89- 10.91	CA3761R	14 65					
	04.89- 10.91	CA5051R	14 45					
	AC 04.89- 10.91	CA10581R	14 90					
Golf II 1.8	[GU]	11.83- 07.85	CA2411R	14 55	11.83- 10.91	CS294	12 0.9	
		11.83- 07.85	CA2421R	14 65	AT 11.83- 10.91	CS392	12 0.9	
		11.83- 10.91	CA3201R	14 90				
		08.85- 10.91	CA2961R	14 55				
	[GX]	08.85- 10.91	CA2981R	14 65				
		06.83- 07.85	CA2421R	14 65	11.83- 10.91	CS294	12 0.9	
[HV]	09.83- 07.85	CA2411R	14 55	AT 11.83- 10.91	CS392	12 0.9		
	01.84- 10.91	CA3201R	14 90					
	08.85- 10.91	CA2961R	14 55					
	08.85- 10.91	CA2981R	14 65					
	08.83- 07.85	CA2411R	14 55	AT 04.84- 07.87	CS392	12 0.9		
	08.83- 07.85	CA2421R	14 65	04.84- 07.87	CS294	12 0.9		



VW Continued

	[RH]	08.86- 07.90 CA296IR 14 55		08.86- 07.90 CS294	12 0.9
		08.86- 07.90 CA298IR 14 65			
		08.86- 07.90 CA320IR 14 90			
	[RP]	10.87- 10.91 CA296IR 14 55	10.87- 10.91 CS294	12 0.9	
		10.87- 10.91 CA298IR 14 65	AT 10.87- 10.91 CS392	12 0.9	
Golf II 1.8 Syncro	[1P]	08.88- 07.91 CA296IR 14 55	08.88- 07.91 CS294	12 0.9	
		08.88- 07.91 CA298IR 14 65			
		08.88- 07.91 CA320IR 14 90			
	[GU]	02.86- 07.91 CA296IR 14 55	02.86- 07.91 CS294	12 0.9	
		02.86- 07.91 CA298IR 14 65			
		02.86- 07.91 CA320IR 14 90			
	[GX]	02.86- 07.88 CA296IR 14 55	02.86- 07.88 CS294	12 0.9	
		02.86- 07.88 CA298IR 14 65			
		02.86- 07.88 CA320IR 14 90			
	[RP]	08.87- 10.91 CA296IR 14 55	08.87- 10.91 CS294	12 0.9	
		08.87- 10.91 CA298IR 14 65			
		08.87- 10.91 CA320IR 14 90			
Golf II 1.8 G60 GTI	[PG]	04.90- 07.91 CA840IR 14 65	08.90- 07.91 CS601	12 1.1	
		04.90- 07.91 CA841IR 14 90	04.90- 07.90 CS559	12 1.0	
Golf II 1.8 G60 Syncro	[1H]	01.89- 01.90 CA840IR 14 65	01.89- 01.90 CS559	12 1.0	
		01.89- 01.90 CA841IR 14 90			
	[PG]	01.90- 07.91 CA840IR 14 65	08.90- 07.91 CS601	12 1.1	
		01.90- 07.91 CA841IR 14 90	01.90- 07.90 CS559	12 1.0	
Golf II 1.8 GTI 16V	[KR]	02.86- 10.91 CA342IR 14 65	02.86- 10.91 CS294	12 0.9	
		02.86- 10.91 CA343IR 14 90			
		AC 02.86- 10.91 CA343IR 14 90			
	[PL]	02.86- 10.91 CA342IR 14 65	02.86- 10.91 CS294	12 0.9	
		02.86- 10.91 CA343IR 14 90			
		AC 02.86- 10.91 CA343IR 14 90			
Golf II 1.8 GTI	[DX]	08.83- 07.85 CA241IR 14 55	AT 11.84- 12.92 CS276	12 0.7	
		08.83- 07.85 CA242IR 14 65	08.90- 12.92 CS618	12 1.1	
		08.83- 12.92 CA318IR 14 90	11.84- 10.91 CS294	12 0.9	
		08.83- 07.87 CA320IR 14 90			
		08.85- 07.87 CA296IR 14 55			
		08.85- 07.87 CA298IR 14 65			
	[EV]	08.83- 07.85 CA241IR 14 55	08.83- 07.87 CS294	12 0.9	
		08.83- 07.85 CA242IR 14 65			
		08.83- 07.87 CA320IR 14 90			
		08.85- 07.87 CA296IR 14 55			
		08.85- 07.87 CA298IR 14 65			
	[GZ]	08.83- 07.85 CA241IR 14 55	08.83- 07.87 CS294	12 0.9	
		08.83- 07.85 CA242IR 14 65			
		08.83- 07.87 CA320IR 14 90			
		08.85- 07.87 CA296IR 14 55			
		08.85- 07.87 CA298IR 14 65			
	[HT]	01.85- 07.85 CA241IR 14 55	01.85- 07.85 CS294	12 0.9	
		01.85- 07.85 CA242IR 14 65			
	[PB]	08.85- 10.91 CA296IR 14 55	01.87- 10.91 CS294	12 0.9	
		08.85- 10.91 CA298IR 14 65			
		07.87- 10.91 CA320IR 14 90			
	[PF]	08.85- 10.91 CA296IR 14 55	08.85- 10.91 CS294	12 0.9	
		08.85- 10.91 CA298IR 14 65	AT 08.85- 10.87 CS392	12 0.9	
		08.85- 10.91 CA320IR 14 90			
	[RD]	08.85- 10.87 CA296IR 14 55	AT 08.85- 10.87 CS392	12 0.9	
		08.85- 10.87 CA298IR 14 65	08.85- 10.87 CS294	12 0.9	
		08.85- 10.87 CA320IR 14 90			
Golf III 1.4	[ABD]	11.91- 07.95 CA732IR 14 60	08.92- 07.95 CS880	12 1.1	
		11.91- 07.95 CA733IR 14 70	11.91- 07.92 CS723	12 0.9	
		11.91- 07.95 CA740IR 14 90	08.92- 07.95 CS788	12 0.9	
		ACPS 11.91- 07.95 CA736IR 14 90	07.93- 07.95 CS618	12 1.1	
		ACPS 11.91- 07.95 CA827IR 14 70			
		AC 11.91- 07.95 CA828IR 14 120			
		AC 07.93- 07.95 CA736IR 14 90			
		AC 07.93- 07.95 CA827IR 14 70			
	[AEX]	07.95- 04.99 CA733IR 14 70	07.95- 04.99 CS618	12 1.1	
		07.95- 04.99 CA740IR 14 90	07.95- 04.99 CS1062	12 1.1	
		PS 07.95- 04.99 CA736IR 14 90			
		PS 07.95- 04.99 CA827IR 14 70			
		ACPS 07.95- 12.97 CA736IR 14 90			
	[APQ]	12.97- 05.98 CA733IR 14 70	12.97- 05.98 CS618	12 1.1	
		12.97- 05.98 CA740IR 14 90	12.97- 05.98 CS1062	12 1.1	
		AC 12.97- 05.98 CA736IR 14 90			
		AC 12.97- 05.98 CA827IR 14 70			
Golf III 1.6	[ABU]	09.92- 09.94 CA732IR 14 60	09.92- 09.94 CS880	12 1.1	
		09.92- 09.94 CA733IR 14 70			
		09.92- 09.94 CA740IR 14 90			
		ACPS 09.92- 09.94 CA736IR 14 90			
		ACPS 09.92- 09.94 CA827IR 14 70			
		AC 09.92- 09.94 CA736IR 14 90			
		AC 09.92- 09.94 CA827IR 14 70			
	[AEA]	10.94- 12.97 CA732IR 14 60	04.95- 12.97 CS618	12 1.1	
		10.94- 12.97 CA733IR 14 70	10.94- 03.95 CS1062	12 1.1	
		10.94- 12.97 CA740IR 14 90			
	[AEE]	07.95- 12.97 CA736IR 14 90	07.95- 01.96 CS618	12 1.1	
		07.95- 12.97 CA827IR 14 70	02.96- 12.97 CS1062	12 1.1	
	[AEK]	10.94- 12.95 CA733IR 14 70	10.94- 12.95 CS1062	12 1.1	
		10.94- 12.95 CA740IR 14 90	10.94- 12.95 CS618	12 1.1	
		ACPS 10.94- 12.95 CA736IR 14 90			
		ACPS 10.94- 12.95 CA827IR 14 70			
		ACPS 10.94- 12.95 CA828IR 14 120			
		AC 10.94- 12.95 CA736IR 14 90			
		AC 10.94- 12.95 CA827IR 14 70			
	[AFT]	12.95- 02.99 CA733IR 14 70	12.95- 05.98 CS1062	12 1.1	
		12.95- 02.99 CA740IR 14 90	12.95- 02.99 CS618	12 1.1	
		ACPS 12.95- 02.99 CA736IR 14 90			
		ACPS 12.95- 02.99 CA827IR 14 70			
		AC 12.95- 05.98 CA736IR 14 90			
		AC 12.95- 05.98 CA827IR 14 70			
	[AKS]	05.97- 10.00 CA733IR 14 70	05.97- 02.99 CS618	12 1.1	
		05.97- 10.00 CA740IR 14 90	05.97- 10.00 CS1062	12 1.1	
		ACPS 05.97- 02.99 CA736IR 14 90			
		ACPS 05.97- 02.99 CA827IR 14 70			
		AC 05.97- 10.00 CA736IR 14 90			
		AC 05.97- 10.00 CA827IR 14 70			



Golf III 1.8	[ABS]	11.91- 09.94	CA732IR	14 60		11.91- 07.95	CS618	12 1.1	
		11.91- 07.95	CA733IR	14 70		11.91- 07.95	CS1062	12 1.1	
		11.91- 07.95	CA740IR	14 90					
		07.93- 09.94	CA828IR	14 120					
		AC 11.91- 07.95	CA736IR	14 90					
		AC 11.91- 09.94	CA827IR	14 70					
			AC 11.91- 09.94	CA828IR	14 120				
	[ACC]	11.91- 12.97	CA732IR	14 60		11.91- 12.97	CS1062	12 1.1	
		11.91- 12.97	CA733IR	14 70		11.91- 12.97	CS618	12 1.1	
		11.91- 12.97	CA740IR	14 90					
		AC 11.91- 12.97	CA736IR	14 90					
		AC 11.91- 12.97	CA827IR	14 70					
		AC 11.91- 12.97	CA828IR	14 120					
	[ADZ]	10.94- 12.97	CA732IR	14 60		10.94- 12.97	CS618	12 1.1	
		10.94- 04.99	CA733IR	14 70		10.94- 04.99	CS1062	12 1.1	
		10.94- 04.99	CA740IR	14 90					
		10.94- 04.99	CA828IR	14 120					
		AC 10.94- 04.99	CA736IR	14 90					
		AC 10.94- 04.99	CA827IR	14 70					
			AC 10.94- 12.97	CA828IR	14 120				
	[ANN]	07.93- 04.99	CA733IR	14 70		07.93- 11.95	CS618	12 1.1	
		07.93- 04.99	CA740IR	14 90		07.93- 04.99	CS1062	12 1.1	
		07.93- 04.99	CA828IR	14 120					
		AC 07.93- 04.99	CA736IR	14 90					
AC 07.93- 04.99		CA827IR	14 70						
[ANP]	12.97- 04.99	CA733IR	14 70		12.97- 04.99	CS1062	12 1.1		
	12.97- 04.99	CA740IR	14 90						
	12.97- 04.99	CA828IR	14 120						
	AC 12.97- 04.99	CA736IR	14 90						
	AC 12.97- 04.99	CA827IR	14 70						
[AAM]	11.91- 12.97	CA732IR	14 60		11.91- 05.98	CS618	12 1.1		
	11.91- 04.99	CA733IR	14 70		11.91- 04.99	CS1062	12 1.1		
	11.91- 04.99	CA740IR	14 90						
	07.93- 04.99	CA828IR	14 120						
	PS 07.92- 12.97	CA827IR	14 70						
	AC 11.91- 04.99	CA736IR	14 90						
	AC 11.91- 04.99	CA827IR	14 70						
	AC 11.91- 12.97	CA828IR	14 120						
Golf III 1.8 Syncro	[ABS]	01.93- 09.94	CA733IR	14 70		01.93- 09.94	CS619	12 1.1	
		01.93- 09.94	CA740IR	14 90					
		AC 01.93- 09.94	CA736IR	14 90					
		AC 01.93- 09.94	CA827IR	14 70					
			AC 01.93- 09.94	CA828IR	14 120				
	[ADZ]	10.94- 12.97	CA733IR	14 70		10.94- 12.97	CS619	12 1.1	
		10.94- 12.97	CA740IR	14 90		10.94- 12.97	CS1119	12 1.1	
		AC 10.94- 12.97	CA736IR	14 90					
		AC 10.94- 12.97	CA827IR	14 70					
		AC 10.94- 12.97	CA828IR	14 120					
				AC 10.94- 12.97	CA828IR	14 120			
	Golf III 1.9 Diesel	[1Y]	11.91- 12.97	CA732IR	14 60		ECO 11.91- 12.97	CS713	12 1.8
11.91- 04.99			CA733IR	14 70		04.94- 04.99	CS789	12 1.8	
11.91- 04.99			CA740IR	14 90					
07.93- 04.99			CA828IR	14 120					
AC 11.91- 12.97			CA736IR	14 90					
AC 11.91- 12.97			CA827IR	14 70					
AC 11.91- 12.97			CA828IR	14 120					
AC 07.93- 04.99			CA1297IR	14 90					
				AC 07.93- 04.99	CA1297IR	14 90			
				AC 07.93- 04.99	CA1297IR	14 90			
Golf III 1.9 SDi	[AEY]	01.95- 12.97	CA736IR	14 90		04.97- 04.99	CS1287	12 2.0	
		01.95- 04.99	CA827IR	14 70		01.95- 04.99	CS789	12 1.8	
		01.95- 04.99	CA828IR	14 120					
				01.95- 04.99	CA828IR	14 120			
Golf III 1.9 TD	[AAZ]	11.91- 04.99	CA732IR	14 60		04.94- 04.99	CS789	12 1.8	
		11.91- 04.99	CA733IR	14 70		11.91- 06.94	CS713	12 1.8	
		11.91- 04.99	CA740IR	14 90					
		07.93- 04.99	CA828IR	14 120					
		AC 11.91- 04.99	CA1297IR	14 90					
		AC 11.91- 04.99	CA736IR	14 90					
		AC 11.91- 04.99	CA827IR	14 70					
		AC 11.91- 12.97	CA828IR	14 120					
Golf III 1.9 TDi	[1Z]	07.93- 07.96	CA1089IR	14 120		AT 04.94- 07.96	CS789	12 1.8	
		07.93- 07.96	CA736IR	14 90		04.94- 07.96	CS974	12 1.8	
		07.93- 07.96	CA827IR	14 70		07.93- 03.94	CS616	12 1.8	
				07.93- 07.96	CA827IR	14 70			
				07.93- 07.96	CA827IR	14 70			
				07.93- 07.96	CA827IR	14 70			
	[AFN]	02.96- 08.99	CA1260IR	14 120		02.96- 08.99	CS974	12 1.8	
		02.96- 04.99	CA736IR	14 90		AT 04.96- 08.97	CS1287	12 2.0	
		02.96- 04.99	CA827IR	14 70		AT, Chas. 7M-T-008001- 02.96- 04.99	CS789	12 1.8	
		03.96- 08.97	CA1089IR	14 120					
	[AHU]	07.96- 02.99	CA1089IR	14 120		07.96- 02.99	CS974	12 1.8	
		07.96- 02.99	CA736IR	14 90		AT 08.96- 02.99	CS789	12 1.8	
		07.96- 02.99	CA827IR	14 70					
		AC 08.96- 05.98	CA1260IR	14 120					
		AC 08.96- 05.98	CA1297IR	14 90					
		A21 08.96- 12.97	CA1260IR	14 120					
	[ALE]	05.97- 02.99	CA1089IR	14 120		05.97- 02.99	CS974	12 1.8	
		05.97- 02.99	CA736IR	14 90		AT 05.97- 02.99	CS789	12 1.8	
		05.97- 02.99	CA827IR	14 70					
		AC 05.97- 12.97	CA1297IR	14 90					
A21 05.97- 12.97		CA1260IR	14 120						
[AVG]	08.99- 10.00	CA1260IR	14 120		08.99- 10.00	CS974	12 1.8		
Golf III 1.9 TDi Syncro	[1Z]	08.95- 07.96	CA736IR	14 90		03.95- 07.96	CS974	12 1.8	
		08.95- 07.96	CA827IR	14 70					
		A21 08.95- 07.96	CA1089IR	14 120					
	[AHU]	07.96- 06.00	CA736IR	14 90		08.96- 06.00	CS974	12 1.8	
		07.96- 06.00	CA827IR	14 70					
		A21 08.96- 06.00	CA1260IR	14 120					
	[ALE]	05.96- 12.01	CA1089IR	14 120		05.96- 12.01	CS974	12 1.8	
		05.96- 12.01	CA736IR	14 90					
		05.96- 12.01	CA827IR	14 70					
	Golf III 2.0	[2E]	07.93- 09.94	CA733IR	14 70		09.93- 09.94	CS1062	12 1.1
07.93- 09.94			CA740IR	14 90		07.93- 09.94	CS618	12 1.1	
07.93- 09.94			CA828IR	14 120					
AC 09.93- 09.94			CA736IR	14 90					
AC 09.93- 09.94			CA827IR	14 70					
				AC 09.93- 09.94	CA827IR	14 70			



VW Continued

	[ADY]	10.94- 05.96 CA733IR 14 70	10.94- 05.96 CS618 12 1.1
		10.94- 05.96 CA740IR 14 90	10.94- 05.96 CS1062 12 1.1
		10.94- 05.96 CA828IR 14 120	
		AC 10.94- 07.95 CA736IR 14 90	
		AC 10.94- 07.95 CA827IR 14 70	
	[AGG]	07.95- 04.99 CA733IR 14 70	07.95- 04.99 CS1062 12 1.1
		07.95- 04.99 CA740IR 14 90	07.95- 04.99 CS618 12 1.1
		07.95- 04.99 CA828IR 14 120	
		AC 07.95- 04.99 CA736IR 14 90	
		AC 07.95- 04.99 CA827IR 14 70	
	[AKR]	04.97- 04.99 CA733IR 14 70	04.97- 04.99 CS618 12 1.1
		04.97- 04.99 CA740IR 14 90	04.97- 04.99 CS1062 12 1.1
		05.97- 04.99 CA828IR 14 120	
		AC 04.97- 04.99 CA736IR 14 90	
		AC 04.97- 04.99 CA827IR 14 70	
Golf III 2.0 Syncro	[AGG]	08.95- 12.97 CA733IR 14 70	08.95- 12.97 CS619 12 1.1
		08.95- 12.97 CA740IR 14 90	08.95- 12.97 CS1119 12 1.1
		08.95- 12.97 CA828IR 14 120	
		AC 08.95- 12.97 CA736IR 14 90	
		AC 08.95- 12.97 CA827IR 14 70	
Golf III 2.0 GTi 16V	[ABF]	08.92- 12.97 CA736IR 14 90	AT 08.92- 12.97 CS618 12 1.1
		08.92- 12.97 CA827IR 14 70	AT 08.92- 12.97 CS1062 12 1.1
		08.92- 12.97 CA828IR 14 120	08.92- 12.97 CS1119 12 1.1
			08.92- 12.97 CS619 12 1.1
Golf III 2.0 GTi	[2E]	11.91- 09.94 CA733IR 14 70	11.91- 09.94 CS618 12 1.1
		11.91- 09.94 CA740IR 14 90	
		11.91- 09.94 CA828IR 14 120	
		AC 11.91- 09.94 CA736IR 14 90	
		AC 11.91- 09.94 CA827IR 14 70	
	[ADY]	10.94- 12.97 CA733IR 14 70	10.94- 12.97 CS618 12 1.1
		10.94- 12.97 CA740IR 14 90	10.94- 12.97 CS1062 12 1.1
		AC 10.94- 12.97 CA736IR 14 90	
		AC 10.94- 12.97 CA827IR 14 70	
		AC 10.94- 12.97 CA828IR 14 120	
	[AGG]	07.95- 12.97 CA733IR 14 70	07.95- 12.97 CS618 12 1.1
		07.95- 12.97 CA740IR 14 90	07.95- 12.97 CS1062 12 1.1
		AC 07.95- 12.97 CA736IR 14 90	
		AC 07.95- 12.97 CA827IR 14 70	
		AC 07.95- 12.97 CA828IR 14 120	
	[AKR]	05.97- 12.97 CA733IR 14 70	05.97- 12.97 CS618 12 1.1
		05.97- 12.97 CA740IR 14 90	05.97- 12.97 CS1062 12 1.1
		05.97- 12.97 CA828IR 14 120	
		AC 05.97- 12.97 CA736IR 14 90	
		AC 05.97- 12.97 CA827IR 14 70	
Golf III 2.8 VR6	[AAA]	01.95- 12.97 CA1142IR 14 120	AT 01.92- 12.97 CS789 12 1.8
			AT 01.92- 12.97 CS713 12 1.8
			01.92- 12.97 CS620 12 1.7
Golf III 2.9 VR6	[ABV]	07.95- 12.97 CA1142IR 14 120	07.95- 12.97 CS620 12 1.7
Golf III 2.9 VR6 Syncro	[ABV]	01.94- 12.94 CA828IR 14 120 ▲	01.94- 12.97 CS620 12 1.7
		01.95- 12.97 CA1142IR 14 120	
Golf IV 1.4 16V	[AHW]	10.97- 05.98 CA1240IR 14 90	10.97- 06.06 CS1062 12 1.1
		10.97- 05.98 CA1267IR 14 70	
		05.98- 06.06 CA1511IR 14 70	
		05.98- 06.06 CA1512IR 14 90	
		AC 05.98- 06.06 CA1378IR 14 90	
		AC 05.98- 06.06 CA1436IR 14 70	
	[AKQ]	10.97- 05.98 CA1240IR 14 90	10.97- 05.00 CS1062 12 1.1
		10.97- 05.98 CA1267IR 14 70	
		05.98- 05.00 CA1511IR 14 70	
		05.98- 05.00 CA1512IR 14 90	
		AC 05.98- 05.00 CA1378IR 14 90	
		AC 05.98- 05.00 CA1436IR 14 70	
	[APE]	10.97- 05.98 CA1240IR 14 90	05.99- 05.00 CS1062 12 1.1
		10.97- 05.98 CA1267IR 14 70	
		05.99- 05.00 CA1511IR 14 70	
		05.99- 05.00 CA1512IR 14 90	
		AC 05.99- 05.00 CA1378IR 14 90	
		AC 05.99- 05.00 CA1436IR 14 70	
	[AXP]	05.00- 10.01 CA1511IR 14 70	05.00- 05.01 CS1062 12 1.1
		05.00- 10.01 CA1512IR 14 90	06.01- 10.01 CS1343 12 0.9
		AC 05.00- CA1436IR 14 70	
		AC 08.97- 06.05 CA1378IR 14 90	
	[BCA]	10.01- 05.04 CA1511IR 14 70	10.01- 05.04 CS1343 12 0.9
		10.01- 05.04 CA1512IR 14 90	
		AC 10.01- 05.04 CA1378IR 14 90	
		AC 10.01- 05.04 CA1436IR 14 70	
Golf IV 1.6	[AEH]	01.98- 04.01 CA1240IR 14 90	01.98- 04.01 CS1062 12 1.1
		01.98- 04.01 CA1241IR 14 120	
		01.98- 04.01 CA1267IR 14 70	
		01.98- 04.01 CA1378IR 14 90	
		01.98- 04.01 CA1394IR 14 120	
		05.98- 04.01 CA1436IR 14 70	
	[AFT]	06.98- 10.00 CA733IR 14 70	06.98- 10.00 CS1062 12 1.1
		06.98- 10.00 CA740IR 14 90	06.98- 10.00 CS1343 12 0.9
		AC 06.98- 10.00 CA736IR 14 90	
		AC 06.98- 10.00 CA827IR 14 70	
	[AKL]	10.97- 05.98 CA1240IR 14 90	10.97- CS1062 12 1.1
		10.97- 05.98 CA1241IR 14 120	
		10.97- 05.98 CA1267IR 14 70	
		10.97- CA1394IR 14 120	
		05.98- CA1378IR 14 90	
		05.98- CA1436IR 14 70	
	[AKS]	04.98- 10.00 CA733IR 14 70	04.98- 10.00 CS1343 12 0.9
		04.98- 10.00 CA740IR 14 90	04.98- 10.00 CS1062 12 1.1
		AC 04.98- 10.00 CA736IR 14 90	
		AC 04.98- 10.00 CA827IR 14 70	
	[APF]	05.99- 08.00 CA1378IR 14 90	05.99- 08.00 CS1062 12 1.1
		05.99- 08.00 CA1394IR 14 120	
		05.99- 08.00 CA1436IR 14 70	
	[AVU]	08.00- CA1378IR 14 90	08.00- CS1062 12 1.1
		08.00- CA1394IR 14 120	
		08.00- CA1436IR 14 70	
	[AWB]	08.03- 06.05 CA1378IR 14 90	08.03- 06.05 CS1287 12 2.0
	[BAD]	01.02- CA1733IR 14 110	01.02- CS1197 12 1.1





	[BFO]	08.00-08.00-08.00-	CA1378IR CA1394IR CA1436IR	14 90 14 120 14 70		08.00-	CS1062	12 1.1	
	[BJH]	08.00-08.00-08.00-	CA1378IR CA1394IR CA1436IR	14 90 14 120 14 70		08.00-	CS1062	12 1.1	
Golf IV 1.6 16V	[ATN]	11.99-	CA1378IR	14 90		11.99-	CS1062	12 1.1	
	[AUS]	05.00-05.00-AC 05.00-	CA1504IR CA1512IR CA1378IR	14 70 14 90 14 90		05.00-	CS1062	12 1.1	
	[AZD]	09.00-09.00-AC 09.00-	CA1504IR CA1512IR CA1378IR	14 70 14 90 14 90		09.00-	CS1062	12 1.1	
	[BCB]	11.01- 05.04 11.01- 05.04 AC 11.01- 05.04	CA1504IR CA1512IR CA1378IR	14 70 14 90 14 90		11.01- 05.04	CS1062	12 1.1	
	[BAD]	01.02-	CA1733IR	14 110		01.02-	CS1197	12 1.1	
	[BAG]	10.03- 07.04	CA1817IR	14 110		10.03- 07.04 10.03- 07.04	CS1347 CS1330	12 1.1 12 1.0	
Golf IV 1.8	[ADZ]	10.94- 10.00 10.94- 10.00 AC 10.94- 10.00	CA733IR CA740IR CA736IR	14 70 14 90 14 90		10.94- 10.00 10.94- 10.00	CS1343 CS618	12 0.9 12 1.1	
	[AGN]	08.97-08.97-08.97-08.97-	CA1240IR CA1241IR CA1267IR CA1436IR	14 90 14 120 14 70 14 70		AT 10.97-08.97-08.97-	CS1062 CS618 CS619	12 1.1 12 1.1 12 1.1	
	[AGU]	08.97-08.97-08.97-08.97-	CA1240IR CA1241IR CA1267IR CA1436IR	14 90 14 120 14 70 14 70		6SP 08.97-06.05 08.97-06.05 08.97-06.05	CS1181 CS619 CS1119	12 2.0 12 1.1 12 1.1	
	[ANN]	06.98- 10.00 06.98- 10.00 AC 06.98- 10.00	CA733IR CA740IR CA736IR	14 70 14 90 14 90		06.98- 10.00	CS618	12 1.1	
	[ANP]	06.98- 10.00 06.98- 10.00 AC 06.98- 10.00	CA733IR CA740IR CA736IR	14 70 14 90 14 90		06.98- 10.00	CS1343	12 0.9	
	[ARZ]	08.97-08.97-08.97-08.97-	CA1240IR CA1241IR CA1267IR CA1436IR	14 90 14 120 14 70 14 70		AT 08.97-08.97-	CS1062 CS1119	12 1.1 12 1.1	
	[AUM]	09.00- 05.06 09.00- 05.06 09.00- 05.06	CA1378IR CA1394IR CA1436IR	14 90 14 120 14 70		AT 08.97-6SP 09.00- 05.06 6SP 09.00- 05.06	CS1477* CS1181 CS1062	12 1.4 12 2.0 12 1.1	
	[AAM]	08.91- 10.00 08.91- 10.00 AC 08.91- 10.00	CA733IR CA740IR CA736IR	14 70 14 90 14 90		08.91- 10.00	CS618	12 1.1	
	Golf IV 1.8 4 Motion	[AGN]	10.97- 10.00 10.97- 10.00	CA1378IR CA1436IR	14 90 14 70		AT 10.98- 10.00 10.98- 10.00 05.98- 10.98	CS1062 CS1119 CS619	12 1.1 12 1.1 12 1.1
		[AUQ]	06.01-06.01-06.01-	CA1378IR CA1394IR CA1436IR	14 90 14 120 14 70		06.01-	CS1337	12 1.1
	Golf IV 1.8 Turbo	[AGU]	05.00- 05.03 05.00- 05.03 05.00- 05.03	CA1378IR CA1394IR CA1436IR	14 90 14 120 14 70		5SP 05.00- 05.03 6SP 05.00- 05.03	CS1062 CS1181	12 1.1 12 2.0
		[AUM]	09.00- 05.03 09.00- 05.03 09.00- 05.03	CA1378IR CA1394IR CA1436IR	14 90 14 120 14 70		5SP 09.00- 05.03 6SP 09.00- 05.03 AT 05.00-	CS1062 CS1181 CS1477*	12 1.1 12 2.0 12 1.4
		[AGP]	08.97- 04.01 08.97- 04.01 08.97- 04.01 08.97- 04.01 10.97- 04.01 10.97- 04.01	CA1144IR CA1502IR CA1570IR CA827IR CA1394IR CA1446IR	14 120 14 70 14 90 14 70 14 120 14 90		10.97- 04.01 08.97- 04.01	CS1287 CS789	12 2.0 12 1.8
		[AQM]	08.97- 05.06 08.97- 05.06 08.97- 05.06 11.98- 05.06 11.98- 05.06 11.98- 05.06	CA1144IR CA1570IR CA827IR CA1394IR CA1446IR CA1502IR	14 120 14 90 14 70 14 120 14 90 14 70		11.98- 05.06	CS1287	12 2.0
	Golf IV 1.9 TDi	[AGR]	10.97- 04.98 10.97- 04.98 10.97- 05.06 10.97- 04.98 05.98- 05.06 05.98- 05.06	CA1144IR CA1240IR CA1446IR CA1570IR CA1394IR CA1502IR	14 120 14 90 14 90 14 90 14 120 14 70		AT 10.97- 05.06 10.97- 05.06	CS789 CS974	12 1.8 12 1.8
		[AHF]	08.97- 04.98 08.97- 04.98 08.97- 04.98 05.98- 05.06 05.98- 05.06 05.98- 05.06	CA1144IR CA1240IR CA1570IR CA1394IR CA1446IR CA1502IR	14 120 14 90 14 90 14 120 14 90 14 70		AT 10.97- 05.06 10.97- 05.06 AT 10.97- 05.06	CS789 CS974 CS1287	12 1.8 12 1.8 12 2.0
[AHU]		06.98- 06.00 06.98- 06.00 06.98- 06.00 AC 04.98- 06.00 AC 06.98- 06.00	CA1089IR CA736IR CA827IR CA1260IR CA1297IR	14 120 14 90 14 70 14 120 14 90		AT 06.98- 06.00 06.98- 06.00	CS789 CS974	12 1.8 12 1.8	
[AJM]		05.99- 07.01 05.99- 07.01 05.99- 07.01 05.99- 07.01	CA1394IR CA1446IR CA1502IR CA1511IR	14 120 14 90 14 70 14 70		05.99- 07.01	CS1181	12 2.0	
[ALE]		05.96- 12.01 05.96- 12.01 05.96- 12.01 AC 05.96- 12.01 AC 05.96- 12.01	CA1089IR CA736IR CA827IR CA1260IR CA1297IR	14 120 14 90 14 70 14 120 14 90		AT 05.96- 12.01 05.96- 12.01	CS789 CS974	12 1.8 12 1.8	
[ALH]		10.97- 04.98 10.97- 04.98 10.97- 05.06 10.97- 05.06 10.97- 05.06 10.97- 04.98	CA1144IR CA1240IR CA1394IR CA1446IR CA1502IR CA1570IR	14 120 14 90 14 120 14 90 14 70 14 90		10.97- 05.06 AT 10.97- 05.06 AT 10.97- 05.06	CS974 CS789 CS1287	12 1.8 12 1.8 12 2.0	



VW Continued

	[ARL]	10.00- 05.06 CA1394IR 14 120 10.00- 05.06 CA1446IR 14 90 10.00- 05.06 CA1502IR 14 70		09.00- 05.06 CS1181 12 2.0
	[ASV]	05.00- 05.06 CA1394IR 14 120 05.00- 05.06 CA1446IR 14 90 05.00- 05.06 CA1502IR 14 70		AT 05.00- 05.06 CS789 12 1.8 05.00- 05.06 CS974 12 1.8
	[ASZ]	04.01- 05.06 CA1394IR 14 120 04.01- 05.06 CA1446IR 14 90 04.01- 05.06 CA1502IR 14 70		AT, 5SP 04.01- 05.06 CS1390 12 2.3 04.01- 05.06 CS1181 12 2.0
	[ATD]	02.00- 06.06 CA1394IR 14 120 02.00- 06.06 CA1446IR 14 90 02.00- 06.06 CA1502IR 14 70		5SP 02.00- 06.06 CS974 12 1.8 AT, 5SP 02.00- 06.06 CS1390 12 2.3 6SP 02.00- 06.06 CS1181 12 2.0
	[AUY]	05.99- 07.01 CA1394IR 14 120 05.99- 07.01 CA1446IR 14 90 05.99- 07.01 CA1502IR 14 70 05.99- 07.01 CA1511IR 14 70		05.99- 07.01 CS1181 12 2.0 AT, 5SP 05.99- 07.01 CS1390 12 2.3
	[AXR]	09.00- 06.06 CA1394IR 14 120 09.00- 06.06 CA1446IR 14 90 09.00- 06.06 CA1502IR 14 70		5SP 05.01- 06.06 CS974 12 1.8 6SP 05.01- 06.06 CS1181 12 2.0 AT, 5SP 05.01- 06.06 CS1390 12 2.3
Golf IV 1.9 TDi 4 Motion	[AGR]	10.97- 05.05 CA1394IR 14 120 10.97- 05.05 CA1446IR 14 90 10.97- 05.05 CA1502IR 14 70 Chas. 1J-X-000001- 07.98- 04.02 CA1378IR 14 90 Chas. 1J-X-000001- 07.98- 04.02 CA1394IR 14 120 Chas. 1J-X-000001- 07.98- 04.02 CA1446IR 14 90 Chas. 1J-X-000001- 07.98- 04.02 CA1502IR 14 70 Chas. -1J-W-200000 10.97- 07.98 CA1144IR 14 120		10.97- 05.05 CS974 12 1.8 AT 10.97- 05.05 CS1287 12 2.0 AT 10.97- 05.05 CS789 12 1.8
	[AJM]	02.99- 06.01 CA1394IR 14 120 02.99- 06.01 CA1446IR 14 90 02.99- 06.01 CA1502IR 14 70		02.99- 06.01 CS1181 12 2.0
	[ALH]	07.98- 05.06 CA1378IR 14 90 07.98- 05.06 CA1394IR 14 120 07.98- 05.06 CA1446IR 14 90 07.98- 05.06 CA1502IR 14 70 Chas. 1J-X-000001- 07.98- 05.06 CA1144IR 14 120 Chas. -1J-W-200000 07.98- 05.06 CA1144IR 14 120 Chas. -1J-W-200000 07.98- 05.06 CA1570IR 14 90		AT 07.98- 05.06 CS789 12 1.8 07.98- 05.06 CS974 12 1.8 AT 07.98- 05.06 CS1287 12 2.0
	[ARL]	10.00- 05.06 CA1394IR 14 120 10.00- 05.06 CA1446IR 14 90 10.00- 05.06 CA1502IR 14 70		09.00- 05.06 CS1181 12 2.0
	[ASZ]	04.01- 05.06 CA1394IR 14 120 04.01- 05.06 CA1446IR 14 90 04.01- 05.06 CA1502IR 14 70		04.01- 05.06 CS1181 12 2.0 AT, 5SP 04.01- 05.06 CS1390 12 2.3
	[ATD]	09.00- 05.06 CA1394IR 14 120 09.00- 05.06 CA1446IR 14 90 09.00- 05.06 CA1502IR 14 70		6SP 02.00- 05.06 CS1181 12 2.0 5SP 02.00- 05.06 CS974 12 1.8
	[AUY]	09.99- 06.01 CA1394IR 14 120 09.99- 06.01 CA1446IR 14 90 09.99- 06.01 CA1502IR 14 70		09.99- 06.01 CS1181 12 2.0 AT, 5SP 09.99- 06.01 CS1390 12 2.3
Golf IV 2.0	[AGG]	06.98- CA733IR 14 70 06.98- CA740IR 14 90 AC 06.98- CA736IR 14 90		06.98- CS1062 12 1.1
	[AKR]	06.98- 04.00 CA733IR 14 70 06.98- 04.00 CA740IR 14 90 AC 06.98- 04.00 CA736IR 14 90		06.98- 04.00 CS1062 12 1.1
	[APK]	08.98- 05.06 CA1378IR 14 90 08.98- 05.06 CA1436IR 14 70		AT 08.98- 05.06 CS1062 12 1.1 08.98- 05.06 CS1119 12 1.1
	[AQY]	08.98- 06.06 CA1378IR 14 90 08.98- 06.06 CA1436IR 14 70		AT 08.98- 06.06 CS1062 12 1.1 08.98- 06.06 CS1119 12 1.1
	[ATU]	06.99- 06.00 CA733IR 14 70 06.99- 06.00 CA740IR 14 90 AC 06.99- 06.00 CA736IR 14 90		06.99- 06.00 CS1062 12 1.1
	[AWF]	06.00- 06.02 CA733IR 14 70 06.00- 06.02 CA740IR 14 90 AC 06.00- 06.02 CA736IR 14 90		06.00- 06.02 CS1062 12 1.1
	[AWG]	06.00- 06.02 CA733IR 14 70 06.00- 06.02 CA740IR 14 90 AC 06.00- 06.02 CA736IR 14 90		06.00- 06.02 CS1062 12 1.1
	[AZG]	05.01- 04.02 CA1378IR 14 90 05.01- 04.02 CA1394IR 14 120 05.01- 04.02 CA1436IR 14 70		05.01- 04.02 CS1119 12 1.1
	[AZJ]	05.01- 05.06 CA1394IR 14 120 07.98- 06.06 CA1378IR 14 90 07.98- 06.06 CA1436IR 14 70		05.01- 06.06 CS1119 12 1.1 AT 05.01- 06.06 CS1062 12 1.1
Golf IV 2.0 4 Motion	[AZH]	04.00- 06.01 CA1378IR 14 90 04.00- 06.01 CA1394IR 14 120 04.00- 06.01 CA1436IR 14 70		04.00- 06.01 CS1062 12 1.1
	[AZJ]	05.01- 06.06 CA1378IR 14 90 05.01- 06.06 CA1394IR 14 120 05.01- 06.06 CA1436IR 14 70		AT 05.01- 06.06 CS1062 12 1.1
Golf IV 2.0 Bi-Fuel	[BEH]	05.02- 06.06 CA1394IR 14 120 05.02- 06.06 CA1436IR 14 70 AC 05.02- 06.06 CA1378IR 14 90		02.02- 06.06 CS1119 12 1.1
Golf IV 2.3 V5	[AGZ]	10.97- 02.01 CA1394IR 14 120 10.97- 02.01 CA1446IR 14 90 10.97- 02.01 CA1502IR 14 70		AT 08.97- 02.01 CS789 12 1.8 08.97- 02.01 CS1266 12 1.8
	[AQN]	09.00- CA1394IR 14 120 09.00- CA1446IR 14 90 09.00- CA1502IR 14 70		6SP 09.00- CS1181 12 2.0 5SP 09.00- CS1266 12 1.8 AT 10.00- CS1477* 12 1.4
Golf IV 2.3 V5 4 Motion	[AGZ]	10.97- 02.01 CA1394IR 14 120 10.97- 02.01 CA1446IR 14 90 10.97- 02.01 CA1502IR 14 70		10.97- 02.01 CS1266 12 1.8 AT 10.97- 02.01 CS789 12 1.8
	[AQN]	09.00- CA1394IR 14 120 09.00- CA1446IR 14 90 09.00- CA1502IR 14 70		AT 10.00- CS1477* 12 1.4 5SP 09.00- CS1266 12 1.8 6SP 09.00- CS1181 12 2.0
Golf IV 2.8 V6 4 Motion	[AQP]	05.99- 05.00 CA1394IR 14 120 05.99- 05.00 CA1446IR 14 90 05.99- 05.00 CA1502IR 14 70		6SP 05.99- 05.00 CS1181 12 2.0
	[AUE]	01.00- 04.01 CA1394IR 14 120 01.00- 04.01 CA1446IR 14 90 01.00- 04.01 CA1502IR 14 70		6SP 01.00- 04.01 CS1181 12 2.0
	[BDE]	05.01- 06.05 CA1394IR 14 120 05.01- 06.05 CA1446IR 14 90 05.01- 06.05 CA1502IR 14 70		6SP 01.01- 06.05 CS1181 12 2.0



Golf IV 3.2 4 Motion	[BFH]	06.02- 05.04	CA1394IR	14 120		AT 06.02- 05.04	CS1286	12 2.0	
		06.02- 05.04	CA1446IR	14 90		09.02- 06.05	CS1181	12 2.0	
	[BML]	06.02- 06.06	CA1394IR	14 120		AT 06.02- 06.06	CS1286	12 2.0	
		06.02- 06.06	CA1446IR	14 90		09.02- 06.06	CS1181	12 2.0	
Golf V 1.2 TSi Plus	[CBZB]					08.09-	CS1322	12 1.1	
Golf V 1.4	[BUD]	06.07-	CA1560IR	14 90		06.07-	CS1330	12 1.0	
		06.07-	CA1815IR#	14 110					
		AC 06.07-	CA1729IR	14 110					
	[CAXA]	05.07-	CA1817IR	14 110		05.07-	CS1294	12 1.1	
		05.07-	CA1921IR	14 110		DSG 05.07-	CS1470	12 1.1	
	05.07-	CA1985IR	14 140						
	05.07-	CA2056IR*	14 110						
Golf V 1.4 FSi Plus	[BLN]	07.05- 05.06	CA1817IR	14 110		07.05- 05.06	CS1330	12 1.0	
Golf V 1.4 16V	[BCA]	10.03-	CA1815IR#	14 110		5SP 10.03-	CS1330	12 1.0	
		01.05-	CA1511IR	14 70		01.05-	CS1343	12 0.9	
		01.05-	CA1512IR	14 90					
		AC 10.03-	CA1729IR	14 110					
		AC 01.05-	CA1378IR	14 90					
	[BUD]	05.06- 07.07	CA1560IR	14 90		05.06- 07.07	CS1330	12 1.0	
		05.06- 07.07	CA1815IR#	14 110					
		AC 05.06- 07.07	CA1729IR	14 110					
Golf V 1.4 16V Plus	[BUD]	05.06- 07.07	CA1560IR	14 90		05.06- 07.07	CS1330	12 1.0	
		05.06- 07.07	CA1815IR#	14 110					
		AC 05.06- 07.07	CA1729IR	14 110					
	[CGGA]	01.09-	CA1815IR#	14 110		01.09-	CS1330	12 1.0	
		AC 01.09-	CA1729IR	14 110					
Golf V 1.4 FSi	[BKG]	10.03-	CA1817IR	14 110		10.03-	CS1330	12 1.0	
						AT, 6SP 10.03-	CS1347	12 1.1	
Golf V 1.4 TSi	[BLG]	11.05-	CA1817IR	14 110		11.05-	CS1294	12 1.1	
		11.05-	CA1921IR	14 110		AT 11.05-	CS1409	12 1.0	
		11.05-	CA1985IR	14 140					
		AT 06.07-	CA1921IR	14 110					
		05.06-	CA1817IR	14 110		05.06-	CS1294	12 1.1	
	[BMY]	06.07-	CA1921IR	14 110		AT 05.06-	CS1409	12 1.0	
		AT 05.06-	CA1921IR	14 110					
		AT 05.06-	CA1985IR	14 140					
	[CAVD]	07.08-	CA1985IR	14 140		07.08-	CS1294	12 1.1	
		AT 07.08-	CA1921IR	14 110					
	[CAXA]	06.07-	CA1817IR	14 110		06.07-	CS1294	12 1.1	
		06.07-	CA1921IR	14 110		DSG 06.07-	CS1470	12 1.1	
		06.07-	CA1985IR	14 140					
		06.07-	CA2056IR*	14 110					
Golf V 1.4 TSi Plus	[BLG]	05.06-	CA1817IR	14 110		11.05-	CS1294	12 1.1	
		AT 05.06-	CA1921IR	14 110		AT 05.06-	CS1409	12 1.0	
		AT 05.06-	CA1985IR	14 140					
		[BMY]	05.06-	CA1817IR	14 110		AT 05.06-	CS1409	12 1.0
			05.06-	CA1921IR	14 110		05.06-	CS1294	12 1.1
		AT 05.06-	CA1985IR	14 140					
	[CAVD]	06.08-	CA1817IR	14 110		06.08-	CS1294	12 1.1	
		06.08-	CA1985IR	14 140		AT 06.08-	CS1470	12 1.1	
	[CAXA]	06.07-	CA1817IR	14 110		06.07-	CS1294	12 1.1	
		06.07-	CA1921IR	14 110		AT 06.07-	CS1470	12 1.1	
		06.07-	CA1985IR	14 140					
		06.07-	CA2056IR*	14 110					
Golf V 1.6	[BGU]	01.04- 06.05	CA1782IR	14 140		01.04- 06.05	CS1324	12 1.0	
		01.04- 06.05	CA1818IR	14 110		01.04-	CS1470	12 1.1	
						AT, 6SP 01.04- 06.05	CS1347	12 1.1	
		[BSE]	05.05-	CA1378IR	14 90		05.05-	CS1324	12 1.0
			05.05-	CA1782IR	14 140		AT 05.05-	CS1347	12 1.1
		05.05-	CA1818IR	14 110					
	[BSF]	05.05-	CA1378IR	14 90		AT, 6SP 05.05-	CS1347	12 1.1	
		05.05-	CA1782IR	14 140		05.05-	CS1324	12 1.0	
		05.05-	CA1818IR	14 110					
	[CCSA]	01.08-	CA1782IR	14 140		01.08-	CS1324	12 1.0	
Golf V 1.6 Plus	[BSE]	05.05-	CA1782IR	14 140		05.05-	CS1324	12 1.0	
		05.05-	CA1818IR	14 110		AT 05.05-	CS1347	12 1.1	
		[BSF]	05.05-	CA1782IR	14 140		AT 05.05-	CS1347	12 1.1
			05.05-	CA1818IR	14 110		05.05-	CS1324	12 1.0
		[CCSA]	11.07-	CA1378IR	14 90		11.07-	CS1324	12 1.0
		11.07-	CA1782IR	14 140					
		11.07-	CA1818IR	14 110					
Golf V 1.6 FSi	[BAG]	10.03- 07.04	CA1817IR	14 110		AT, 6SP 10.03- 07.04	CS1347	12 1.1	
						10.03- 07.04	CS1330	12 1.0	
		[BLF]	01.05- 05.07	CA1817IR	14 110		AT, 6SP 01.05- 05.07	CS1347	12 1.1
						01.05- 05.07	CS1330	12 1.0	
	[BLP]	10.03- 07.04	CA1817IR	14 110		AT, 6SP 10.03- 07.04	CS1347	12 1.1	
						10.03- 07.04	CS1330	12 1.0	
Golf V 1.6 Multifuel	[CCSA]	10.07-	CA1378IR	14 90		10.07-	CS1324	12 1.0	
		10.07-	CA1818IR	14 110					
		11.07-	CA1782IR	14 140					
Golf V 1.6 TDi Plus	[CAYC]	03.09-	CA1782IR	14 140		AT 03.09-	CS1480*	12 1.8	
						A25 03.09-	CS1505*	12 2.0	
Golf V 1.6 Plus Multifuel	[CCSA]	11.07-	CA1782IR	14 140		11.07-	CS1324	12 1.0	
		11.07-	CA1818IR	14 110					
Golf V 1.8 GTi	[AUQ]	06.01-	CA1378IR	14 90		08.06-	CS1119	12 1.1	
		06.01-	CA1394IR	14 120		6SP 06.01-	CS1337	12 1.1	
		06.01-	CA1436IR	14 70					
Golf V 1.9 TDi	[BKC]	10.03-	CA1782IR	14 140		AT 10.03-	CS1286	12 2.0	
		10.03-	CA1810IR	14 110		6SP 10.03-	CS1323	12 2.0	
						5SP 10.03-	CS1293	12 2.0	
						10.03-	CS1293	12 2.0	
		[BLS]	10.03-	CA1782IR	14 140		6SP 10.03-	CS1323	12 2.0
			10.03-	CA1810IR	14 110		5SP 10.03-	CS1293	12 2.0
						AT 10.03-	CS1286	12 2.0	
		[BRU]	05.04- 02.06	CA1782IR	14 140		05.04- 02.06	CS1293	12 2.0
			05.04- 02.06	CA1810IR	14 110				
		[BXE]	10.03-	CA1782IR	14 140		AT 10.03-	CS1286	12 2.0
			10.03-	CA1810IR	14 110		6SP 10.03-	CS1323	12 2.0
						5SP 10.03-	CS1293	12 2.0	
						01.05-	CS1293	12 2.0	
	[BXF]	02.06-	CA1782IR	14 140		02.06-	CS1293	12 2.0	
		02.06-	CA1810IR	14 110					
	[BXJ]	05.04-	CA1782IR	14 140		05.04-	CS1293	12 2.0	
		05.04-	CA1810IR	14 110					



VW Continued

Golf V 1.9 TDi 4 Motion	[BKC]	08.04-08.04-	CA1782IR CA1810IR	14 140 14 110		AT 08.04-08.04-	CS1286 CS1293	12 2.0 12 2.0	
	[BLS]	08.04-08.04-	CA1782IR CA1810IR	14 140 14 110		6SP 08.04-08.04- AT 01.08-08.04- AT, 6SP 08.04-	CS1323 CS1293 CS1286 CS1286	12 2.0 12 2.0 12 2.0 12 2.0	
		[BXE]	08.04-08.04-	CA1782IR CA1810IR	14 140 14 110		08.04-08.04- 6SP 08.04-08.04- AT 08.04-	CS1293 CS1323 CS1286	12 2.0 12 2.0 12 2.0
	Golf V 1.9 TDi Plus	[BLS]	01.05-01.05-	CA1782IR CA1810IR	14 140 14 110		AT 01.05-01.05-	CS1286 CS1293	12 2.0 12 2.0
[BRU]		05.05-05.05-	CA1782IR CA1810IR	14 140 14 110		05.05-	CS1293	12 2.0	
[BXF]		02.06-02.06-	CA1782IR CA1810IR	14 140 14 110		02.06-	CS1293	12 2.0	
[BXJ]		05.07-05.07-	CA1782IR CA1810IR	14 140 14 110		05.07-	CS1293	12 2.0	
Golf V 2.0		[BHY]	08.06-	CA1782IR	14 140		08.06-08.06-	CS1294 CS1347	12 1.1 VA 12 1.1 BO
Golf V 2.0 FSi	[AXW]	01.04-01.04-	CA1782IR CA1818IR	14 140 14 110		01.04-01.04- AT, 6SP 01.04-	CS1294 CS1347	12 1.1 12 1.1	
	[BLR]	01.04-01.04-	CA1782IR CA1818IR	14 140 14 110		01.04-01.04- AT, 6SP 01.04-	CS1294 CS1347	12 1.1 12 1.1	
	[BLX]	01.04-01.04-	CA1782IR CA1818IR	14 140 14 110		01.04-01.04- AT, 6SP 01.04-	CS1294 CS1347	12 1.1 12 1.1	
	[BLY]	01.04-01.04-	CA1782IR CA1818IR	14 140 14 110		01.04-01.04- AT, 6SP 01.04-	CS1294 CS1347	12 1.1 12 1.1	
	[BVX]	01.04-01.04-	CA1782IR CA1818IR	14 140 14 110		01.04-01.04- AT, 6SP 01.04-	CS1294 CS1347	12 1.1 12 1.1	
	[BKY]	01.04-01.04-	CA1782IR CA1818IR	14 140 14 110		01.04-01.04- AT, 6SP 01.04-	CS1294 CS1347	12 1.1 12 1.1	
	[BVZ]	01.04-01.04-	CA1782IR CA1818IR	14 140 14 110		01.04-01.04- AT, 6SP 01.04-	CS1294 CS1347	12 1.1 12 1.1	
	Golf V 2.0 FSi 4 Motion	[BLX]	05.04-05.04- 11.05-11.05-	CA1782IR CA1818IR	14 140 14 110		05.04-05.04- AT 05.04-11.05-	CS1294 CS1347	12 1.1 12 1.1
		[BVX]	11.05-11.05-	CA1782IR CA1818IR	14 140 14 110		11.05-11.05- AT 11.05-	CS1294 CS1347	12 1.1 12 1.1
		[BLR]	05.05-05.05-	CA1782IR CA1818IR	14 140 14 110		AT 05.05-05.05-	CS1347 CS1294	12 1.1 12 1.1
Golf V 2.0 FSi Plus	[BLY]	05.05-05.05-	CA1782IR CA1818IR	14 140 14 110		05.05-05.05- AT 05.05-	CS1294 CS1347	12 1.1 12 1.1	
	[BKY]	11.05-11.05-	CA1782IR CA1818IR	14 140 14 110		AT 11.05-11.05-	CS1347 CS1294	12 1.1 12 1.1	
	[BVZ]	11.05-11.05-	CA1782IR CA1818IR	14 140 14 110		11.05-11.05- AT 11.05-	CS1294 CS1347	12 1.1 12 1.1	
	[BXX]	10.04-10.04- 06.05-06.05-	CA1782IR CA1818IR	14 140 14 110		10.04-10.04- AT 10.04-06.05-	CS1347 CS1409	12 1.1 12 1.0	
Golf V 2.0 GTi	[BKY]	11.05-11.05-	CA1782IR CA1818IR	14 140 14 110		11.05-11.05- AT 11.05-	CS1347 CS1409	12 1.1 12 1.0	
	[BWA]	11.05-11.05-	CA1782IR CA1818IR	14 140 14 110		AT 11.05-11.05-	CS1409 CS1347	12 1.0 12 1.1	
	[BYD]	09.06-09.06- 05.07-05.07-	CA1782IR	14 140		09.06-09.06- 05.07-05.07-	CS1347	12 1.1	
Golf V 2.0 SDi	[BDK]	01.04-01.04- 05.07-05.07-	CA1782IR CA1810IR	14 140 14 110		01.04-01.04- 05.07-05.07-	CS1393	12 1.7	
Golf V 2.0 TDi 16V	[BKD]	10.03-10.03-	CA1782IR CA1810IR	14 140 14 110		10.03-10.03- AT 10.03-	CS1323 CS1286	12 2.0 12 2.0	
Golf V 2.0 TDi 16V 4 Motion	[BKD]	08.04-08.04-	CA1782IR CA1810IR	14 140 14 110		6SP 08.04-08.04- AT 08.04-	CS1323 CS1286	12 2.0 12 2.0	
Golf V 2.0 TDi	[AZV]	10.03-10.03-	CA1782IR CA1810IR	14 140 14 110		10.03-10.03- AT 10.03-	CS1323 CS1286	12 2.0 12 2.0	
	[BMM]	12.04-12.04-	CA1782IR CA1810IR	14 140 14 110		AT 12.04-12.04-	CS1286 CS1323	12 2.0 12 2.0	
	[BMN]	11.05-11.05-	CA1782IR CA1810IR	14 140 14 110		AT 11.05-11.05-	CS1286 CS1323	12 2.0 12 2.0	
	[AZV]	06.07-06.07-	CA1782IR	14 140		06.07-	CS1323	12 2.0	
Golf V 2.0 TDi 4 Motion	[BMM]	08.04-08.04-	CA1782IR CA1810IR	14 140 14 110		AT 08.04-08.04-	CS1286 CS1323	12 2.0 12 2.0	
	[AZV]	05.05-05.05-	CA1782IR CA1810IR	14 140 14 110		05.05-05.05- AT 05.05-	CS1323 CS1286	12 2.0 12 2.0	
	[BMM]	12.05-12.05-	CA1782IR CA1810IR	14 140 14 110		12.05-12.05- AT 12.05-	CS1323 CS1286	12 2.0 12 2.0	
Golf V 2.0 TDi Plus	[BVB]	11.05-11.05-	CA1810IR	14 110		11.05-11.05-	CS1323	12 2.0	
	[CBDC]	03.09-03.09-	CA1782IR	14 140		03.09-03.09- AT 03.09-	CS1323 CS1286	12 2.0 12 2.0	
	[BUB]	09.05-09.05-	CA1782IR	14 140		09.05-	CS1323	12 2.0	
	[BUB]	11.05-11.05-	CA1782IR	14 140		11.05-	CS1323	12 2.0	
Golf V 3.2 R32 4 Motion	[CBRA]	11.05-11.05-	CA1782IR	14 140		11.05-	CS1323	12 2.0	
Golf V 3.2 R32 4 Motion	[BFH]	01.04-01.04-	CA1394IR CA1446IR	14 120 14 90		01.04-01.04- AT 01.04-	CS1181 CS1286	12 2.0 12 2.0	
	[CBZB]					DSG 05.09-05.09-	CS1470 CS1322	12 1.1 12 1.1	
Golf VI 1.4	[BUD]	07.09-07.09-	CA1729IR	14 110		07.09-	CS1330	12 1.0	
	[CGGA]	10.08-10.08-	CA1729IR	14 110		10.08-	CS1330	12 1.0	
Golf VI 1.4 TSi	[CAVD]	10.08-10.08- 07.09-07.09- 07.09-07.09-	CA1782IR CA1921IR CA1817IR CA1985IR	14 140 14 110 14 110 14 140		A24 10.08-10.08-	CS1470 CS1294	12 1.1 12 1.1	
	[CAXA]	10.08-10.08- 07.09-07.09- 07.09-07.09- AT 07.09-	CA1921IR CA1817IR CA2056IR* CA1921IR	14 110 14 110 14 110 14 110		10.08-10.08- AT 10.08-	CS1294 CS1470	12 1.1 12 1.1	
	[BSE]	10.08-10.08-	CA1782IR CA1818IR	14 140 14 110		10.08-10.08- AT 07.09-10.08- AT 10.08-	CS1324 CS1347 CS1470	12 1.0 12 1.1 12 1.1	
	[BSF]	10.08-10.08-	CA1782IR CA1818IR	14 140 14 110		AT 10.08-10.08- AT 07.09-10.08-	CS1470 CS1324 CS1347	12 1.1 12 1.0 12 1.1	
	[CCSA]	10.08-10.08-	CA1782IR CA1818IR	14 140 14 110		10.08-	CS1324	12 1.0	
Golf VI 1.6	[BSE]	10.08-10.08-	CA1782IR CA1818IR	14 140 14 110		10.08-10.08- AT 07.09-10.08- AT 10.08-	CS1324 CS1347 CS1470	12 1.0 12 1.1 12 1.1	
	[BSF]	10.08-10.08-	CA1782IR CA1818IR	14 140 14 110		AT 10.08-10.08- AT 07.09-10.08-	CS1470 CS1324 CS1347	12 1.1 12 1.0 12 1.1	
	[CCSA]	10.08-10.08-	CA1782IR CA1818IR	14 140 14 110		10.08-	CS1324	12 1.0	
Golf VI 1.6 Multifuel	[CCSA]	10.08-10.08-	CA1782IR CA1818IR	14 140 14 110		10.08-	CS1324	12 1.0	
	[CMXA]	05.10-05.10-	CA1782IR CA1818IR	14 140 14 110		05.10-	CS1324	12 1.0	



Golf VI 1.6 BiFuel	[CHGA]	03.09-	CA1782IR	14 140	03.09-	CS1324	12 1.0	
		03.09-	CA1818IR	14 110				
Golf VI 1.6 TDi	[CAYB]	02.09-	CA2011IR	14 140	AT 12.09-	CS1480*	12 1.8	
		12.09-	CA1782IR	14 140	A25 02.09-	CS1505*	12 2.0	
	[CAYC]	02.09-	CA2011IR	14 140	A25 02.09-	CS1505*	12 2.0	
		07.09-	CA1782IR	14 140	DKG 02.09-	CS1480*	12 1.8	
		A25 07.09-	CA2011IR	14 140				
Golf VI 1.8 TSi	[CDAA]	06.09-	CA1811IR	14 140	06.09-	CS1294	12 1.1	
					DKG 06.09-	CS1470	12 1.1	
Golf VI 2.0	[CDLF]	11.09-	CA1782IR	14 140	11.09-	CS1347	12 1.1	
					AT 11.09-	CS1409	12 1.0	
Golf VI 2.0 4motion	[CDLC]	11.09-	CA1782IR	14 140	AT 11.09-	CS1409	12 1.0	
					11.09-	CS1347	12 1.1	
Golf VI 2.0 TSi	[CCZB]	04.09-	CA1811IR	14 140	04.09-	CS1347	12 1.1	
					AT 04.09-	CS1409	12 1.0	
Golf VI 2.0 TDi	[BMM]	07.09-	CA1782IR	14 140	07.09-	CS1286	12 2.0	
					07.09-	CS1323	12 2.0	
	[CBAB]	10.08-	CA2011IR	14 140	10.08-	CS1323	12 2.0	
					AT 10.08-	CS1286	12 2.0	
	[CBBB]	04.09- 11.09	CA1782IR	14 140	04.09- 11.09	CS1323	12 2.0	
		A25 04.09- 11.09	CA2011IR	14 140				
	[CBDA]	07.09- 09.10	CA1782IR	14 140	07.09- 09.10	CS1323	12 2.0	
	[CBDB]	07.09-	CA1782IR	14 140	07.09-	CS1323	12 2.0	
					07.09-	CS1286	12 2.0	
	[CBDC]	10.08-	CA1782IR	14 140				
	[CBAA]	10.08- 11.09	CA1782IR	14 140	10.08- 11.09	CS1323	12 2.0	
		10.08- 11.09	CA2011IR	14 140	AT 10.08- 11.09	CS1286	12 2.0	
	[CFFA]	11.09-	CA1782IR	14 140	11.09-	CS1323	12 2.0	
	A25 11.09-	CA1811IR	14 140					
[CFFB]	10.08-	CA1782IR	14 140	10.08-	CS1286	12 2.0		
	A25 10.08-	CA2011IR	14 140	10.08-	CS1323	12 2.0		
[CFHB]	07.10-	CA1782IR	14 140	07.10-	CS1323	12 2.0		
[CJAA]	10.08-	CA1782IR	14 140	AT 10.08-	CS1286	12 2.0		
	A25 10.08-	CA2011IR	14 140	10.08-	CS1323	12 2.0		
Golf VI 2.0 TDi 4 Motion	[CBAB]	10.08-	CA1782IR	14 140	10.08-	CS1323	12 2.0	
		A25 10.08-	CA2011IR	14 140	AT 10.08-	CS1286	12 2.0	
	[CFFB]	11.09-	CA1782IR	14 140	11.09-	CS1323	12 2.0	
	A25 11.09-	CA2011IR	14 140	AT 11.09-	CS1286	12 2.0		
Ittis 1.7	[WL]	03.79- 07.80	CA35IR	14 35				
		03.79- 07.80	CA52IR	14 55				
		08.80- 12.88	CA140IR	14 45				
		08.80- 12.88	CA141IR	14 65				
	[YX]	01.79- 07.80	CA35IR	14 35				
		01.79- 07.80	CA52IR	14 55				
		08.80- 12.88	CA140IR	14 45				
		08.80- 12.88	CA141IR	14 65				
Jetta 1.1	[GG]	08.80- 07.82	CA136IR	14 45	08.80- 12.82	CS79	12 0.8	
		08.80- 07.82	CA139IR	14 65				
Jetta 1.2 TSi	[CBZB]				02.11-	CS1322	12 1.1	
Jetta 1.3	[ZG]	01.89- 07.92	CA376IR	14 65	01.89- 07.92	CS293	12 0.8	
		01.89- 07.92	CA588IR	14 55				
	[GF]	02.80- 12.83	CA136IR	14 45	08.79- 12.83	CS79	12 0.8	
		08.81- 12.83	CA139IR	14 65				
	[GS]	08.82- 12.83	CA136IR	14 45	08.82- 12.83	CS79	12 0.8	
		08.82- 12.83	CA139IR	14 65				
	[GT]	01.84- 07.85	CA276IR	14 65	01.84- 07.87	CS293	12 0.8	
		01.84- 07.87	CA588IR	14 55				
		08.85- 07.87	CA376IR	14 65				
	[HK]	01.84- 07.85	CA276IR	14 65	01.84- 07.85	CS293	12 0.8	
	[MH]	08.85- 12.88	CA376IR	14 65	01.84- 12.88	CS293	12 0.8	
	08.85- 12.88	CA588IR	14 55					
[NZ]	02.87- 07.92	CA376IR	14 65	02.87- 07.92	CS293	12 0.8		
	02.87- 07.92	CA588IR	14 55					
Jetta 1.4 TSi	[BLG]	07.06-	CA1921IR	14 110	AT 07.06-	CS1409	12 1.0	
		07.06-	CA1985IR	14 140	07.06-	CS1294	12 1.1	
	[BMY]	07.06-	CA1921IR	14 110	AT 07.06-	CS1409	12 1.0	
		07.06-	CA1985IR	14 140	07.06-	CS1294	12 1.1	
	[CAVD]	07.08-	CA1921IR	14 110	07.08-	CS1294	12 1.1	
					AT 07.08-	CS1286	12 2.0	
[CAXA]	05.07-	CA1817IR	14 110	05.07-	CS1294	12 1.1		
				AT 05.07-	CS1347	12 1.1		
		DSG 05.07-	CA1921IR	14 110	DSG 05.07-	CS1470	12 1.1	
Jetta 1.5	[JB]	08.79- 12.83	CA140IR	14 45	AT 08.79- 12.83	CS276	12 0.7	
		08.79- 12.83	CA141IR	14 65	08.79- 12.83	CS116	12 0.8	
		08.79- 07.80	CA52IR	14 55				
Jetta 1.6	[FR]	08.80- 12.83	CA140IR	14 45	AT 08.80- 12.83	CS276	12 0.7	
		08.80- 12.83	CA141IR	14 65	08.80- 12.83	CS116	12 0.8	
	[ABN]	01.84- 07.85	CA241IR	14 55	01.84- 07.91	CS294	12 0.9	
		01.84- 07.85	CA242IR	14 65	AT 01.84- 07.91	CS276	12 0.7	
		01.84- 07.91	CA320IR	14 90				
		08.85- 07.92	CA296IR	14 55				
		08.85- 07.92	CA298IR	14 65				
	[BSE]	08.05-	CA1782IR	14 140	AT 08.05-	CS1347	12 1.1	
		08.05-	CA1818IR	14 110	08.05-	CS1324	12 1.0	
	[BSF]	10.05-	CA1782IR	14 140	AT 10.05-	CS1347	12 1.1	
		10.05-	CA1818IR	14 110	10.05-	CS1324	12 1.0	
	[CCSA]	08.05-	CA1782IR	14 140	08.05-	CS1324	12 1.0	
		08.05-	CA1818IR	14 110	AT 08.05-	CS1347	12 1.1	
	[EW]	08.82- 07.83	CA140IR	14 45	08.82- 07.83	CS276	12 0.7	
		08.82- 07.83	CA141IR	14 65				
	[EZ]	01.84- 07.85	CA241IR	14 55	AT 01.84- 07.91	CS276	12 0.7	
		01.84- 07.85	CA242IR	14 65	01.84- 07.91	CS294	12 0.9	
		01.84- 07.91	CA320IR	14 90				
		08.85- 07.92	CA296IR	14 55				
		08.85- 07.92	CA298IR	14 65				
	[HM]	01.84- 07.85	CA241IR	14 55	AT 01.84- 07.88	CS276	12 0.7	
01.84- 07.85		CA242IR	14 65	01.84- 07.88	CS294	12 0.9		
01.84- 07.88		CA320IR	14 90					
08.85- 07.88		CA296IR	14 55					
08.85- 07.88		CA298IR	14 65					
[PN]	10.86- 07.92	CA296IR	14 55	AT 10.86- 07.92	CS276	12 0.7		
	10.86- 07.92	CA298IR	14 65	10.86- 07.92	CS294	12 0.9		
	10.86- 07.92	CA320IR	14 90					



VW Continued

	[RF]	03.86- 10.91	CA296IR	14 55	AT 03.86- 10.91	CS276	12 0.7
		03.86- 10.91	CA298IR	14 65	03.86- 10.91	CS294	12 0.9
		03.86- 10.91	CA320IR	14 90			
Jetta 1.6 FSi	[BLF]	09.05-	CA1817IR	14 110	09.05- AT 09.05-	CS1330 CS1347	12 1.0 12 1.1
Jetta 1.6 GTI 4x4	[EG]	08.79- 07.82	CA140IR	14 45	08.79- 07.82	CS116	12 0.8
		08.79- 07.82	CA141IR	14 65			
Jetta 1.6 Multifuel	[CCSA]	01.08-	CA1782IR	14 140	01.08-	CS1324	12 1.0
		01.08-	CA1818IR	14 110			
Jetta 1.6 Diesel	[CR]	08.80- 12.83	CA136IR	14 45	08.80- 12.83	CS272	12 1.7
		08.80- 12.83	CA139IR	14 65	AT 08.80- 12.83	CS348	12 1.7
	[JK]	08.80- 12.83	CA136IR	14 45	AT 08.80- 12.83	CS348	12 1.7
		08.80- 12.83	CA139IR	14 65	08.80- 12.83	CS272	12 1.7
	[JP]	01.84- 07.85	CA276IR	14 65	01.84- 10.91	CS295	12 1.7
		01.84- 07.85	CA277IR#	14 45	AT 01.84- 10.91	CS348	12 1.7
		08.85- 10.91	CA297IR	14 45			
		08.85- 10.91	CA302IR	14 65			
		08.85- 10.91	CA376IR	14 65			
		08.85- 10.91	CA505IR	14 45			
		AC 01.84- 05.84	CA318IR	14 90			
		AC 05.84- 10.91	CA1058IR	14 90			
	[ME]	08.84- 07.85	CA276IR	14 65	08.84- 10.91	CS295	12 1.7
		08.84- 07.85	CA277IR#	14 45	AT 08.84- 10.91	CS348	12 1.7
		08.85- 10.91	CA297IR	14 45			
		08.85- 10.91	CA302IR	14 65			
		08.85- 10.91	CA376IR	14 65			
		08.85- 10.91	CA505IR	14 45			
		AC 05.84- 10.91	CA1058IR	14 90			
Jetta 1.6 TD	[1V]	08.89- 07.92	CA297IR	14 45	08.89- 07.92	CS295	12 1.7
		08.89- 07.92	CA302IR	14 65	AT 08.89- 07.92	CS348	12 1.7
		08.89- 07.92	CA376IR	14 65			
		08.89- 07.92	CA505IR	14 45			
		AC 08.89- 07.92	CA1058IR	14 90			
	[CY]	03.82- 12.83	CA136IR	14 45	03.82- 12.83	CS272	12 1.7
		03.82- 12.83	CA139IR	14 65	AT 03.82- 12.83	CS348	12 1.7
	[JR]	01.84- 07.85	CA276IR	14 65	AT 01.84- 10.91	CS348	12 1.7
		01.84- 07.85	CA277IR#	14 45	01.84- 10.91	CS295	12 1.7
		08.85- 10.91	CA297IR	14 45			
		08.85- 10.91	CA302IR	14 65			
		08.85- 10.91	CA376IR	14 65			
		08.85- 10.91	CA505IR	14 45			
		AC 01.84- 05.84	CA318IR	14 90			
		AC 05.84- 10.91	CA1058IR	14 90			
	[MF]	08.84- 07.85	CA276IR	14 65	AT 08.84- 07.92	CS348	12 1.7
		08.84- 07.85	CA277IR#	14 45	08.84- 07.92	CS295	12 1.7
		08.85- 07.92	CA297IR	14 45			
		08.85- 07.92	CA302IR	14 65			
		08.85- 07.92	CA376IR	14 65			
		08.85- 07.92	CA505IR	14 45			
		AC 05.84- 07.92	CA1058IR	14 90			
	[RA]	04.89- 02.90	CA297IR	14 45	04.89- 02.90	CS295	12 1.7
		04.89- 02.90	CA302IR	14 65	AT 04.89- 02.90	CS348	12 1.7
		04.89- 02.90	CA376IR	14 65			
		04.89- 02.90	CA505IR	14 45			
		AC 04.89- 02.90	CA1058IR	14 90			
	[SB]	08.89- 10.91	CA297IR	14 45	08.89- 10.91	CS295	12 1.7
		08.89- 10.91	CA302IR	14 65	AT 08.89- 10.91	CS348	12 1.7
		08.89- 10.91	CA376IR	14 65			
		08.89- 10.91	CA505IR	14 45			
		AC 08.89- 10.91	CA1058IR	14 90			
Jetta 1.6 TDI	[CAYC]	02.11-	CA1782IR	14 140			
		A25 02.11-	CA2011IR	14 140			
Jetta 1.8	[DX]	08.82- 12.83	CA140IR	14 45			
		08.82- 12.83	CA141IR	14 65			
	[EV]	01.84- 07.85	CA241IR	14 55	01.84- 07.87	CS294	12 0.9
		01.84- 07.85	CA242IR	14 65			
		01.84- 07.87	CA320IR	14 90			
		08.85- 07.87	CA296IR	14 55			
		08.85- 07.87	CA298IR	14 65			
	[GU]	12.83- 10.91	CA241IR	14 55	AT 12.83- 10.91	CS392	12 0.9
		12.83- 07.85	CA242IR	14 65	12.83- 10.91	CS294	12 0.9
		12.83- 10.91	CA320IR	14 90			
		01.84- 10.91	CA296IR	14 55			
		01.84- 10.91	CA297IR	14 45			
		01.84- 10.91	CA302IR	14 65			
		01.84- 10.91	CA505IR	14 45			
		08.85- 10.91	CA298IR	14 65			
	[GX]	08.84- 10.87	CA241IR	14 55	AT 08.84- 10.87	CS392	12 0.9
		08.84- 07.85	CA242IR	14 65	08.84- 10.87	CS294	12 0.9
		08.84- 10.87	CA296IR	14 55			
		08.84- 10.87	CA297IR	14 45			
		08.84- 10.87	CA302IR	14 65			
		08.84- 10.87	CA320IR	14 90			
		08.84- 10.87	CA505IR	14 45			
		08.84- 07.85	CA520IR	14 65			
		08.85- 10.87	CA298IR	14 65			
		08.85- 10.87	CA376IR	14 65			
	[GZ]	01.84- 07.85	CA241IR	14 55	01.84- 07.87	CS294	12 0.9
		01.84- 07.85	CA242IR	14 65			
		01.84- 07.87	CA320IR	14 90			
		08.85- 07.87	CA296IR	14 55			
		08.85- 07.87	CA298IR	14 65			
	[HV]	04.84- 07.85	CA241IR	14 55	04.84- 07.87	CS294	12 0.9
		04.84- 07.85	CA242IR	14 65	AT 04.84- 07.87	CS392	12 0.9
		04.84- 07.87	CA296IR	14 55			
		04.84- 07.87	CA297IR	14 45			
		04.84- 07.87	CA302IR	14 65			
		04.84- 07.87	CA376IR	14 65			
		04.84- 07.87	CA505IR	14 45			
		01.85- 07.87	CA320IR	14 90			
		08.85- 07.87	CA298IR	14 65			
	[JJ]	08.82- 12.83	CA140IR	14 45			
		08.82- 12.83	CA141IR	14 65			



	[PB]	02.87- 10.91 02.87- 10.91 02.87- 10.91	CA296IR CA298IR CA320IR	14 55 14 65 14 90		02.87- 10.91	CS294	12 0.9
	[PF]	08.85- 07.92 08.85- 07.92 08.85- 07.92	CA296IR CA298IR CA320IR	14 55 14 65 14 90		08.85- 07.92 AT 08.85- 10.87	CS294 CS392	12 0.9 12 0.9
	[RD]	08.85- 10.87 08.85- 10.87 08.85- 10.87	CA296IR CA298IR CA320IR	14 55 14 65 14 90		08.85- 10.87 AT 08.85- 10.87	CS294 CS392	12 0.9 12 0.9
	[RH]	08.86- 07.90 08.86- 07.90 08.86- 07.90	CA296IR CA298IR CA320IR	14 55 14 65 14 90		AT 08.86- 01.90 08.86- 07.90	CS392 CS294	12 0.9 12 0.9
	[RP]	01.84- 07.85 01.84- 07.85 01.84- 10.91 08.85- 10.91 08.85- 10.91	CA241IR CA242IR CA320IR CA296IR CA298IR	14 55 14 65 14 90 14 55 14 65		01.84- 10.91 AT 01.84- 10.91	CS294 CS392	12 0.9 12 0.9
Jetta 1.8 Syncro	[1P]	08.88- 07.92 08.88- 07.92 08.88- 07.92	CA296IR CA298IR CA320IR	14 55 14 65 14 90		08.88- 07.92	CS294	12 0.9
	[RP]	10.87- 10.91 10.87- 10.91 10.87- 10.91 10.87- 10.91 10.87- 10.91 10.87- 10.91 10.87- 10.91	CA296IR CA297IR CA298IR CA302IR CA320IR CA376IR CA505IR	14 55 14 45 14 65 14 65 14 90 14 65 14 45		AT 10.87- 10.91 10.87- 10.91	CS392 CS294	12 0.9 12 0.9
Jetta 1.8 16V	[KR]	08.86- 10.91 08.86- 10.91 AC 08.86- 10.91	CA342IR CA343IR CA343IR	14 65 14 90 14 90		08.86- 10.91	CS294	12 0.9
	[PL]	08.86- 10.91 08.86- 10.91 AC 08.86- 10.91	CA342IR CA343IR CA343IR	14 65 14 90 14 90		08.86- 10.91	CS294	12 0.9
Jetta 1.9 TDi	[BKC]	08.05- 08.05-	CA1782IR CA1810IR	14 140 14 110		AT 08.05- 08.05-	CS1286 CS1293	12 2.0 12 2.0
	[BLS]	08.05- 08.05-	CA1782IR CA1810IR	14 140 14 110		AT 08.05- 08.05-	CS1293 CS1470	12 2.0 12 1.1
	[BXE]	08.05- 08.05-	CA1782IR CA1810IR	14 140 14 110		AT 08.05- 08.05-	CS1286 CS1293	12 2.0 12 2.0
Jetta 2.0 FSi	[BLR]	08.05- 11.05 08.05- 11.05	CA1782IR CA1818IR	14 140 14 110		08.05- 11.05 AT 08.05- 11.05	CS1294 CS1347	12 1.1 12 1.1
	[BLY]	10.05- 11.05 10.05- 11.05	CA1782IR CA1818IR	14 140 14 110		AT 10.05- 11.05 10.05- 11.05	CS1347 CS1294	12 1.1 12 1.1
	[BVY]	12.05- 12.05-	CA1782IR CA1818IR	14 140 14 110		12.05- AT 12.05-	CS1294 CS1347	12 1.1 12 1.1
	[BVZ]	12.05- 12.05-	CA1782IR CA1818IR	14 140 14 110		12.05- AT 12.05-	CS1294 CS1347	12 1.1 12 1.1
Jetta 2.0 TFSi	[BPY]	10.05- 10.05-	CA1782IR CA1818IR	14 140 14 110		10.05- AT 10.05-	CS1347 CS1409	12 1.1 12 1.0
	[BWA]	10.05- 10.05-	CA1782IR CA1818IR	14 140 14 110		AT 10.05- 10.05-	CS1409 CS1347	12 1.0 12 1.1
	[CCTA]	02.08- 02.08-	CA1782IR CA1818IR	14 140 14 110		02.08- 02.08-	CS1347 CS1409	12 1.1 12 1.0
Jetta 2.0 TSi	[CBFA]	12.10-	CA1811IR	14 140		12.10-	CS1347	12 1.1
	[CCTA]	12.10-	CA1811IR	14 140		12.10-	CS1347	12 1.1
	[CCZA]	12.10-	CA1811IR	14 140		12.10-	CS1347	12 1.1
Jetta 2.0 TDi	[AZV]	09.05- 09.05-	CA1782IR CA1810IR	14 140 14 110		6SP 09.05-	CS1323	12 2.0
	[BKD]	08.05- 08.05-	CA1782IR CA1810IR	14 140 14 110		AT 08.05- 08.05-	CS1286 CS1323	12 2.0 12 2.0
	[BMM]	10.05- 10.05-	CA1782IR CA1810IR	14 140 14 110		10.05- AT 10.05-	CS1323 CS1286	12 2.0 12 2.0
	[BMN]	10.06- 10.06-	CA1782IR CA1810IR	14 140 14 110		10.06- AT 10.06-	CS1323 CS1286	12 2.0 12 2.0
	[CBEA]	04.08- 04.08-	CA1782IR CA1921IR	14 140 14 110		04.08- 04.08-	CS1286 CS1323	12 2.0 12 2.0
	[CFFB]	02.11- 02.11-	CA1782IR CA1782IR	14 140 14 140		02.11- 02.11-	CS1323 CS1323	12 2.0 12 2.0
	[CFHC]	02.11- 02.11-	CA1782IR CA1782IR	14 140 14 140		02.11- 02.11-	CS1323 CS1323	12 2.0 12 2.0
	[CJAA]	02.11- 02.11-	CA1782IR CA1782IR	14 140 14 140		02.11- 02.11-	CS1323 CS1323	12 2.0 12 2.0
	[CLCB]	02.11- 02.11-	CA1782IR CA1782IR	14 140 14 140		02.11- 02.11-	CS1323 CS1294	12 2.0 12 1.1
Jetta 2.5	[BTK]					09.06-	CS1294	12 1.1
K 70 1.6	[DA]	08.70- 10.74 08.70- 10.74	CA35IR CA52IR	14 35 14 55				
	[DB]	08.70- 07.71 08.70- 07.71	CA35IR CA52IR	14 35 14 55				
K 70 1.8	[DC]	08.73- 10.74 08.73- 10.74	CA35IR CA52IR	14 35 14 55				
Kaefer 1.2	[D]	08.69- 07.73 08.74- 12.85	CG19 CA93IR	14 30 14 51		08.69- 12.85	CS62	12 0.7
Kaefer 1.2 1303	[D]	04.75- 07.75	CA93IR	14 51		04.75- 07.75	CS62	12 0.7
Kaefer 1.3	[AB]	08.70- 07.73 08.74- 07.75	CG19 CA93IR	14 30 14 51		AT 08.70- 07.75 08.70- 07.75	CS117 CS62	12 0.7 12 0.7
	[AR]	08.72- 07.73 08.74- 07.75	CG19 CA93IR	14 30 14 51		AT 08.72- 07.75 08.72- 07.75	CS62 CS117	12 0.7 12 0.7
	[F]	08.69- 07.70	CG19	14 30		AT 08.69- 07.70 08.69- 07.70	CS117 CS62	12 0.7 12 0.7
kaefer 1.3 1302	[AB]	08.70- 07.72	CG19	14 30		08.70- 07.72 AT 08.70- 07.72	CS62 CS117	12 0.7 12 0.7
Kaefer 1.3 1303	[AB]	08.70- 07.73 08.74- 07.75	CG19 CA93IR	14 30 14 51		AT 08.70- 07.75 08.70- 07.75	CS117 CS62	12 0.7 12 0.7
Kaefer 1.3 Karmann	[F]	08.69- 07.70	CG19	14 30		AT 08.69- 07.70 08.69- 07.70	CS117 CS62	12 0.7 12 0.7
Kaefer 1.5	[H]	08.69- 12.70	CG19	14 30		AT 08.69- 07.70 08.69- 07.70	CS117 CS62	12 0.7 12 0.7
Kaefer 1.6	[ACD]	10.92-	CA93IR	14 51		10.92- 07.03	CS62	12 0.7
	[AD]	07.70- 12.79 07.70- 06.79	CA93IR CG19	14 51 14 30		07.70- 12.79 AT 07.70- 12.79	CS62 CS117	12 0.7 12 0.7
	[AF]					05.73- 09.92	CS62	12 0.7
	[AJ]	08.72- 07.73 08.74- 12.79	CG19 CA93IR	14 30 14 51		AT 08.72- 12.79 08.72- 12.79	CS117 CS62	12 0.7 12 0.7
	[AS]	08.72- 07.73 08.74- 12.79	CG19 CA93IR	14 30 14 51		AT 08.72- 12.79 08.72- 12.79	CS117 CS62	12 0.7 12 0.7
Karmann Ghia 1.6 1600	[AD]	01.70- 07.73	CG19	14 30		01.70- 07.74 AT 01.70- 07.74	CS62 CS117	12 0.7 12 0.7



VW Continued

LT 28-35 2.0	[CH]	04.75- 07.79	CA35IR	14 35	04.75- 11.82	CS83	12 0.8
		04.75- 07.79	CA52IR	14 55			
		04.79- 11.82	CA141IR	14 65			
		08.79- 11.82	CA140IR	14 45			
LT 28-35 2.3	[AGL]	05.96- 11.01	CA1300IR	14 115	05.96- 11.01	CS1075	12 1.2
		05.96- 11.01	CA1301IR	14 90			
LT 28-35 2.4	[DL]	12.82- 07.85	CA140IR	14 45	12.82- 07.92	CS300	12 1.5
		12.82- 07.85	CA141IR	14 65			
		12.82- 07.92	CA320IR	14 90			
		08.83- 07.84	CA318IR	14 90			
		08.85- 07.92	CA298IR	14 65			
		08.85- 07.92	CA520IR	14 65			
LT 28-35 2.4 Syncro	[1E]	08.92- 07.94	CA298IR	14 65	08.92- 07.94	CS300	12 1.5
		08.92- 07.94	CA320IR	14 90			
		08.92- 07.94	CA537IR	14 45			
LT 28-35 2.4 i	[DL]	08.91- 07.92	CA140IR	14 45	08.91- 07.92	CS300	12 1.5
		08.91- 07.92	CA298IR	14 65			
		08.91- 07.92	CA320IR	14 90			
		08.91- 07.92	CA537IR	14 45			
LT 28-35 2.4 i	[1E]	10.88- 07.93	CA298IR	14 65	10.88- 06.96	CS300	12 1.5
		10.88- 06.96	CA318IR	14 90			
		10.88- 07.93	CA320IR	14 90			
		10.88- 06.96	CA520IR	14 65			
		10.88- 04.96	CA537IR	14 45			
LT 28-35 2.4 Diesel	[1S]	08.88- 07.92	CA318IR	14 90	08.88- 07.92	CS350	12 2.2
		08.88- 07.92	CA337IR	14 45			
		08.88- 07.92	CA520IR	14 65 ▲			
		08.89- 07.92	CA298IR	14 65			
		08.89- 07.92	CA320IR	14 90			
		08.89- 07.92	CA537IR	14 45			
	[ACT]	08.92- 04.96	CA318IR	14 90	08.92- 04.96	CS350	12 2.2
		08.92- 07.93	CA320IR	14 90			
		08.92- 04.96	CA337IR	14 45			
	[CP]	08.92- 04.96	CA520IR	14 65 ▲	08.78- 11.82	CS347	12 2.0
		08.78- 07.79	CA35IR	14 35			
		01.79- 11.82	CA141IR	14 65			
[DW]	08.79- 11.82	CA140IR	14 45	08.84- 07.92	CS350	12 2.2	
	11.82- 07.85	CA140IR	14 45				
	11.82- 07.85	CA141IR	14 65				
	11.82- 07.92	CA320IR	14 90				
	11.82- 07.92	CA520IR	14 65 ▲				
	08.83- 07.92	CA318IR	14 90				
	08.85- 07.92	CA298IR	14 65				
	08.85- 07.92	CA337IR	14 45				
	08.85- 07.92	CA537IR	14 45				
	08.85- 07.92	CA911IR#	14 65				
LT 28-35 2.4 TD	[1G]	08.88- 08.92	CA298IR	14 65	08.88- 08.92	CS386	12 2.2
		08.88- 08.92	CA318IR	14 90			
		08.88- 08.92	CA320IR	14 90			
		08.88- 08.92	CA337IR	14 45			
		08.88- 08.92	CA520IR	14 65			
		08.88- 08.92	CA537IR	14 45			
	[ACL]	09.92- 06.96	CA318IR	14 90	09.92- 06.96	CS386	12 2.2
		09.92- 06.96	CA337IR	14 45			
		09.92- 06.96	CA520IR	14 65			
	[DV]	12.82- 07.85	CA140IR	14 45	12.82- 08.92	CS386	12 2.2
		12.82- 07.85	CA141IR	14 65			
		12.82- 08.92	CA320IR	14 90			
08.83- 08.92		CA318IR	14 90				
08.85- 08.92		CA298IR	14 65				
08.85- 08.92		CA337IR	14 45				
08.85- 08.92		CA520IR	14 65				
08.85- 08.92		CA537IR	14 45				
08.85- 08.92		CA537IR	14 45				
08.85- 08.92		CA537IR	14 45				
LT 28-35 2.5 SDi	[AGX]	07.96- 07.98	CA1228IR	14 90	07.96- 04.01	CS1115	12 2.0
		07.96- 07.98	CA1229IR	14 120			
		07.98- 04.01	CA1402IR	14 90			
		07.98- 04.01	CA1445IR	14 120			
		07.98- 04.01	CA1445IR	14 120			
LT 28-35 2.5 TDi	[AHD]	05.96- 07.98	CA1228IR	14 90	05.96- 08.99	CS1165	12 2.0
		05.96- 07.98	CA1229IR	14 120			
		07.98- 08.99	CA1402IR	14 90			
		07.98- 08.99	CA1445IR	14 120			
	[ANJ]	05.99- 07.06	CA1402IR	14 90	05.99- 07.06	CS1187	12 2.0
		05.99- 07.06	CA1445IR	14 120			
	[APA]	05.99- 07.06	CA1402IR	14 90	05.99- 07.06	CS1165	12 2.0
		05.99- 07.06	CA1445IR	14 120			
	[AVR]	12.02- 07.06	CA1402IR	14 90	05.99- 07.06	CS1165	12 2.0
		12.02- 07.06	CA1445IR	14 120			
	[BBE]	05.01- 07.06	CA1402IR	14 90	05.01- 07.06	CS1187	12 2.0
		05.01- 07.06	CA1445IR	14 120			
[BBF]	05.01- 07.06	CA1402IR	14 90	05.01- 07.06	CS1165	12 2.0	
	05.01- 07.06	CA1445IR	14 120				
LT 28-35 2.7 Diesel	[CG (Perkins)]	01.76- 03.80	CA52IR	14 55	01.76- 03.80	CS35IR	14 35
		08.76- 03.80	CA35IR	14 35			
LT 28-35 2.8 TDi	[AGK]	06.97- 07.98	CA1228IR	14 90	06.97- 07.98	CA1229IR	14 120
		06.97- 07.98	CA1229IR	14 120			
		07.98- 12.98	CA1549IR	14 120			
		07.98- 12.98	CA1587IR	14 90			
		07.98- 12.98	CA1587IR	14 90			
	[ATA]	01.99- 01.02	CA1549IR	14 120	01.99- 01.02	CA1587IR	14 90
		01.99- 01.02	CA1587IR	14 90			
	[AUH]	04.02- 07.06	CA1394IR	14 120 ▲	04.02- 07.06	CA1446IR	14 90 ▲
		04.02- 07.06	CA1446IR	14 90 ▲			
	[BCQ]	04.02- 07.06	CA1394IR	14 120 ▲	04.02- 07.06	CA1446IR	14 90 ▲
04.02- 07.06		CA1446IR	14 90 ▲				
LT 40-55 2.3	[AGL]	05.96- 11.01	CA1300IR	14 115	05.96- 11.01	CS1075	12 1.2
		05.96- 11.01	CA1301IR	14 90			
LT 40-55 2.4	[DL]	08.85- 07.89	CA140IR	14 45	12.82- 07.92	CS300	12 1.5
		08.85- 07.89	CA298IR	14 65			
		08.85- 07.92	CA320IR	14 90			
		08.85- 07.92	CA537IR	14 45			
		08.85- 07.92	CA520IR	14 65			
LT 40-55 2.4 4x4	[DL]				12.82- 07.92	CS300	12 1.5





LT 40-55 2.4 i	[1E]	10.88- 04.96	CA320IR	14 90	10.88- 04.96	CS300	12 1.5	
		10.88- 04.96	CA520IR	14 65				
		10.88- 04.96	CA537IR	14 45				
		07.93- 04.96	CA318IR	14 90				
LT 40-55 2.4 Diesel	[1S]	08.89- 07.92	CA318IR	14 90	08.89- 07.92	CS350	12 2.2	
		08.89- 07.92	CA337IR	14 45				
		08.89- 07.92	CA520IR	14 65 ▲				
	[ACT]	08.92- 12.95	CA318IR	14 90	08.92- 12.95	CS350	12 2.2	
		08.92- 12.95	CA337IR	14 45				
		08.92- 12.95	CA520IR	14 65 ▲				
	[CP]	08.78- 07.79	CA35IR	14 35	08.78- 11.82	CS347	12 2.0	
		08.79- 11.82	CA140IR	14 45				
		08.79- 11.82	CA141IR	14 65				
	[DW]	12.82- 07.85	CA140IR	14 45	12.82- 07.87	CS347	12 2.0	
		12.82- 07.85	CA141IR	14 65				
		12.82- 07.92	CA320IR	14 90	12.82- 07.92	CS350	12 2.2	
		11.84- 07.92	CA318IR	14 90				
		08.85- 07.92	CA298IR	14 65				
		08.85- 07.92	CA337IR	14 45				
	08.85- 07.92	CA537IR	14 45					
LT 40-55 2.4 Diesel 4x4	[DW]	12.82- 07.85	CA140IR	14 45	12.82- 07.92	CS350	12 2.2	
		12.82- 07.92	CA320IR	14 90				
		08.84- 07.92	CA318IR	14 90				
		08.85- 07.92	CA337IR	14 45				
		08.85- 07.92	CA520IR	14 65				
LT 40-55 2.4 TD	[1G]	08.88- 08.92	CA318IR	14 90	08.88- 08.92	CS386	12 2.2	
		08.88- 08.92	CA337IR	14 45				
		08.88- 08.92	CA520IR	14 65				
	[ACL]	09.92- 04.96	CA318IR	14 90	09.92- 04.96	CS386	12 2.2	
		09.92- 04.96	CA337IR	14 45				
		09.92- 04.96	CA520IR	14 65				
	[DV]	12.82- 08.85	CA140IR	14 45	12.82- 09.92	CS386	12 2.2	
		12.82- 08.92	CA318IR	14 90				
		08.85- 08.92	CA337IR	14 45				
		08.85- 08.92	CA520IR	14 65				
	LT 40-55 2.4 TD 4x4	[DV]	12.82- 08.92	CA298IR	14 65	12.82- 08.92	CS386	12 2.2
			12.82- 08.92	CA318IR	14 90			
12.82- 08.92			CA320IR	14 90				
12.82- 08.92			CA520IR	14 65				
12.82- 08.92			CA537IR	14 45				
LT 40-55 2.5 SDi	[AGX]	05.96- 07.98	CA1228IR	14 90	05.96- 04.01	CS1115	12 2.0	
		05.96- 07.98	CA1229IR	14 120				
		08.98- 04.01	CA1402IR	14 90				
		08.98- 04.01	CA1445IR	14 120				
LT 40-55 2.5 TDi	[AHD]	05.96- 07.98	CA1228IR	14 90	05.96- 05.99	CS1165	12 2.0	
		05.96- 07.98	CA1229IR	14 120				
		08.98- 05.99	CA1402IR	14 90				
		08.98- 05.99	CA1445IR	14 120				
	[ANJ]	05.99-	CA1402IR	14 90	05.99-	CS1165	12 2.0	
		05.99-	CA1445IR	14 120				05.99-
	[APA]	05.99- 04.01	CA1402IR	14 90	05.99- 04.01	CS1165	12 2.0	
		05.99- 04.01	CA1445IR	14 120				
	[AVR]	12.02- 07.06	CA1402IR	14 90	05.99-	CS1165	12 2.0	
		12.02- 07.06	CA1445IR	14 120				12.02- 07.06
	[BBE]	05.01-	CA1402IR	14 90	05.01-	CS1165	12 2.0	
		05.01-	CA1445IR	14 120				
	[BBF]	05.01-	CA1402IR	14 90	05.01-	CS1165	12 2.0	
		05.01-	CA1445IR	14 120				
	LT 40-55 2.8 TDi	[AGK]	07.97- 07.98	CA1228IR	14 90			
			07.97- 07.98	CA1229IR	14 120			
08.98- 12.98			CA1549IR	14 120				
08.98- 12.98			CA1587IR	14 90				
[ATA]		01.99- 01.02	CA1549IR	14 120				
		01.99- 01.02	CA1587IR	14 90				
[AUH]		04.02- 07.06	CA1394IR	14 120 ▲				
		04.02- 07.06	CA1446IR	14 90 ▲				
[BCQ]		04.02- 07.06	CA1394IR	14 120 ▲				
		04.02- 07.06	CA1446IR	14 90 ▲				
Lupo 1.0		[AER]	01.99- 05.00	CA1560IR	14 90	01.98- 05.00	CS788	12 0.9
			01.99- 05.00	CA1568IR	14 70			
	PS 01.99- 05.00		CA1504IR	14 70				
	PS 01.99- 05.00		CA1542IR	14 90				
	[AHT]	10.98- 05.00	CA1542IR	14 90	10.98- 05.00	CS1211	12 0.9	
		10.98- 05.00	CA1586IR	14 70				
		PS 10.98- 05.00	CA1504IR	14 70				
		PS 10.98- 05.00	CA1542IR	14 90				
	[ALD]	05.99- 07.05	CA1560IR	14 90	04.98- 07.05	CS788	12 0.9	
		05.99- 07.05	CA1568IR	14 70				
		PS 05.99- 07.05	CA1504IR	14 70				
		PS 05.99- 07.05	CA1542IR	14 90				
	[ALL]	10.98- 05.00	CA1560IR	14 90	10.98- 05.00	CS788	12 0.9	
		10.98- 05.00	CA1568IR	14 70				
		PS 10.98- 05.00	CA1504IR	14 70				
		ACPS 10.98- 05.00	CA1542IR	14 90				
[ANV]	05.99- 05.00	CA1560IR	14 90	05.99- 05.00	CS788	12 0.9		
	05.99- 05.00	CA1568IR	14 70					
	PS 05.99- 05.00	CA1504IR	14 70					
	PS 05.99- 05.00	CA1542IR	14 90					
[AUC]	05.00- 07.05	CA1560IR	14 90	05.00- 07.05	CS788	12 0.9		
	05.00- 07.05	CA1568IR	14 70					
	PS 05.00- 07.05	CA1504IR	14 70					
	ACPS 05.00- 07.05	CA1542IR	14 90					
Lupo 1.2 TDi 3L	[ANY]	11.98- 11.00	CA1441IR	14 90	10.98- 11.00	CS1194	12 1.8	
		07.99- 11.00	CA1644IR	14 120				
		07.99- 11.00	CA1682IR	14 70				
[AYZ]	11.00- 07.05	CA1441IR	14 90	Chas. 6E4003501-, 11.00- 07.05	CS988	12 1.8		
	11.00- 07.05	CA1644IR	14 120				Chas. -6E4003500, 11.00- 07.05	CS1194
Lupo 1.4	[AHW]	01.99-	CA1504IR	14 70	01.99-	CS880	12 1.1	
		01.99-	CA1542IR	14 90				
[AKQ]	10.98-	CA1504IR	14 70	10.98-	CS880	12 1.1		
	10.98-	CA1542IR	14 90				AT 09.98- 07.05	CS1063



VW Continued

	[APE]		05.99- 05.99-	CA1504IR CA1542IR	14 70 14 90		05.99-	CS880	12 1.1
	[AUA]		09.00- 04.02 09.00- 04.02	CA1504IR CA1542IR	14 70 14 90		AC 09.00- 04.02 09.00- 04.02	CS1063 CS880	12 1.1 12 1.1
	[AUD]		10.00- 10.00-	CA1542IR CA1568IR	14 90 14 70		AT 10.00- 10.00- 10.00-	CS1063 CS880 CS788	12 1.1 12 1.1 12 0.9
	[BBY]		11.01- 11.01-	CA1504IR CA1542IR	14 70 14 90		11.01- AC 11.01-	CS880 CS1063	12 1.1 12 1.1
Lupo 1.4 16V	[AFK]		05.99- 05.99-	CA1504IR CA1542IR	14 70 14 90		05.99-	CS880	12 1.1
	[ANM]		05.99- 05.99-	CA1504IR CA1542IR	14 70 14 90		05.99-	CS880	12 1.1
	[AQQ]		05.99- 05.99-	CA1504IR CA1542IR	14 70 14 90		05.99-	CS880	12 1.1
	[AUB]		05.00- 05.00-	CA1504IR CA1542IR	14 70 14 90		05.00-	CS880	12 1.1
Lupo 1.4 FSi	[ARR]		AC 02.01-	CA1733IR	14 110				
Lupo 1.4 TDi	[AMF]		10.98- 01.99- 01.99-	CA1682IR CA1441IR CA1644IR	14 70 14 90 14 120		01.99-	CS974	12 1.8
Lupo 1.6 GTi	[AVY]		09.00- 09.00- 09.00-	CA1511IR CA1512IR CA1542IR	14 70 14 90 14 90		09.00- 09.00-	CS1282 CS1197	12 0.9 12 1.1
Lupo 1.7 SDi	[AKU]		04.98- 07.05 04.98- 07.05	CA1547IR CA1548IR	14 70 14 90		04.98- 07.05	CS988	12 1.8
Multivan 1.9 TDi	[AXB]		04.03- 04.03- 04.03-	CA1394IR CA1446IR CA1782IR	14 120 14 90 14 140		04.03-	CS1293	12 2.0
	[BRR]		01.06- 01.06- 01.06-	CA1394IR CA1446IR CA1782IR	14 120 14 90 14 140		01.06-	CS1293	12 2.0
	[BRS]		06.06- 06.06- 06.06-	CA1394IR CA1446IR CA1782IR	14 120 14 90 14 140		06.06-	CS1293	12 2.0
Multivan 2.0	[AXA]		11.03- 11.03-	CA1394IR CA1782IR	14 120 14 140		11.03-	CS1294	12 1.1
Multivan 2.0 BiTDI	[CFCA]						09.09-	CS1323	12 2.0
Multivan 2.0 BiTDI 4 Motion	[CFCA]						09.09-	CS1323	12 2.0
Multivan 2.0 TDi	[CAAC]						09.09-	CS1323	12 2.0
Multivan 2.0 TDi 4 Motion	[CAAC]						09.09-	CS1323	12 2.0
Multivan 2.5	[AET]		Chas. 70-X-075001- 08.96- 06.03 Chas. 70-X-075001- 08.96- 06.03 Chas. -70-X-075000 08.96- 06.03 Chas. -70-X-075000 08.96- 06.03 AC, Chas. 70-X-075001- 08.96- 06.03 AC, Chas. -70-X-075000 08.96- 06.03	CA1402IR CA1445IR CA1228IR CA1229IR CA1445IR CA828IR	14 90 14 120 14 90 14 120 14 120 14 120 ▲		AT 08.96- 06.03 08.96- 06.03	CS295 CS801	12 1.7 12 1.8
	[APL]		05.99- 06.03 05.99- 06.03 AC 05.99- 06.03	CA1402IR CA1445IR CA1445IR	14 90 14 120 14 120		05.99- 06.03	CS801	12 1.8
	[AVT]		12.99- 06.03 12.99- 06.03	CA1402IR CA1445IR	14 90 14 120		12.99- 06.03 AT 12.99- 06.03	CS801 CS295	12 1.8 12 1.7
Multivan 2.5 TDi	[AXD]		04.03- 04.03-	CA1819IR CA1820IR	14 150 14 180		04.03-	CS1405	12 2.2
	[AXE]		04.03- 04.03-	CA1819IR CA1820IR	14 150 14 180		04.03-	CS1405	12 2.2
	[BLJ]		11.03- 11.03-	CA1819IR CA1820IR	14 150 14 180		11.03-	CS1405	12 2.2
	[BNZ]		04.03- 04.03-	CA1819IR CA1820IR	14 150 14 180		04.03-	CS1405	12 2.2
	[BPC]		04.03- 04.03-	CA1819IR CA1820IR	14 150 14 180		04.03-	CS1405	12 2.2
Multivan 2.5 TDi 4 Motion	[AXD]		07.04- 07.04-	CA1819IR CA1820IR	14 150 14 180		07.04-	CS1405	12 2.2
	[AXE]		07.04- 07.04- 07.04-	CA1819IR CA1820IR CA1820IR	14 150 14 180 14 180		07.04-	CS1405	12 2.2
	[BNZ]		07.04- 07.04-	CA1819IR CA1820IR	14 150 14 180		07.04-	CS1405	12 2.2
	[BPC]		07.04- 07.04-	CA1819IR CA1820IR	14 150 14 180		07.04-	CS1405	12 2.2
Multivan 3.2 V6	[BDL]		04.03- 04.03-	CA1394IR CA1763IR	14 120 14 150		04.03-	CS1323	12 2.0
	[BKK]		02.04- 02.04-	CA1394IR CA1763IR	14 120 14 150		02.04-	CS1323	12 2.0
	[CFLA]		02.04- 02.04-	CA1394IR CA1763IR	14 120 14 150		02.04-	CS1323	12 2.0
Multivan 3.2 V6 4 Motion	[BKK]		07.04- 07.04-	CA1394IR CA1763IR	14 120 14 150		07.04-	CS1323	12 2.0
	[CFLA]		07.04- 07.04-	CA1394IR CA1763IR	14 120 14 150		07.04-	CS1323	12 2.0
New Beetle 1.4	[BCA]		11.01- AC 11.01-	CA1511IR CA1512IR	14 70 14 90		11.01- 06.02 07.02-	CS1197 CS1282	12 1.1 12 0.9
New Beetle 1.6	[AWH]		10.99- 10.00 10.99- 10.00 10.99- 10.00	CA1378IR CA1394IR CA1436IR	14 90 14 120 14 70		10.99- 10.00	CS1062	12 1.1
	[AYD]		09.00- 05.01 09.00- 05.01 09.00- 05.01	CA1378IR CA1394IR CA1436IR	14 90 14 120 14 70		AT 09.00- 05.01 09.00- 05.01	CS1062 CS1119	12 1.1 12 1.1
	[BFS]		01.03- 01.03- 01.03-	CA1378IR CA1394IR CA1436IR	14 90 14 120 14 70		01.03-	CS1119	12 1.1
New Beetle 1.8	[AGU]		10.00- 10.00- 10.00-	CA1378IR CA1394IR CA1436IR	14 90 14 120 14 70		AT 10.00- 10.00-	CS1062 CS1337	12 1.1 12 1.1
	[APH]		10.98- 05.01 10.98- 05.01	CA1378IR CA1436IR	14 90 14 70		AT 10.98- 05.01	CS1062	12 1.1
	[AVC]		05.99- 10.00 05.99- 10.00 05.99- 10.00	CA1378IR CA1394IR CA1436IR	14 90 14 120 14 70		05.99- 10.00 AT 05.99- 10.00	CS1181 CS1062	12 2.0 12 1.1
	[AWU]		10.00- 10.00- 10.00-	CA1378IR CA1394IR CA1436IR	14 90 14 120 14 70		10.00- 10.00- AT 10.00-	CS1181 CS1337 CS1062	12 2.0 12 1.1 12 1.1



[AWV]	06.00-06.04	CA1378IR	14 90	06.00-06.04	CS1181	12 2.0	
	06.00-06.04	CA1394IR	14 120	AT 06.00-06.04	CS1062	12 1.1	
	06.00-06.04	CA1436IR	14 70	06.00-06.04	CS1337	12 1.1	
[BKF]	10.00-	CA1378IR	14 90	AT 10.00-	CS1062	12 1.1	
	10.00-	CA1394IR	14 120	10.00-	CS1181	12 2.0	
	10.00-	CA1436IR	14 70	10.00-	CS1337	12 1.1	
New Beetle 1.8 Turbo	[AWP]	11.01-06.05	CA1394IR	14 120	11.01-06.05	CS1119	12 1.1
		11.01-06.05	CA1436IR	14 70			
		11.01-06.05	CA1542IR	14 90			
	[AWU]	01.03-	CA1378IR	14 90	AT 01.03-	CS1062	12 1.1
		01.03-	CA1394IR	14 120	01.03-	CS1119	12 1.1
		01.03-	CA1436IR	14 70			
	[AWV]	01.03-06.04	CA1378IR	14 90	AT 01.03-06.04	CS1062	12 1.1
		01.03-06.04	CA1394IR	14 120	01.03-06.04	CS1119	12 1.1
		01.03-06.04	CA1436IR	14 70			
	[BKF]	07.04-	CA1378IR	14 90	AT 07.04-	CS1062	12 1.1
		07.04-	CA1394IR	14 120	07.04-	CS1119	12 1.1
		07.04-	CA1436IR	14 70			
[BNU]				5SP 07.04-6SP 07.04-	CS1119	12 1.1	
New Beetle 1.9 TDi	[ALH]	01.98-06.04	CA1394IR	14 120	01.98-06.04	CS974	12 1.8
		01.98-06.04	CA1446IR	14 90	AT 04.02-06.04	CS1287	12 2.0
		01.98-06.04	CA1502IR	14 70	AT 01.98-04.02	CS789	12 1.8
	[ATD]	02.01-	CA1394IR	14 120	02.01-	CS974	12 1.8
		02.01-	CA1446IR	14 90			
		02.01-	CA1502IR	14 70			
	[AXR]	06.03-06.05	CA1394IR	14 120	06.03-06.05	CS974	12 1.8
		06.03-06.05	CA1446IR	14 90			
		06.03-06.05	CA1502IR	14 70			
	[BEW]	07.03-	CA1394IR	14 120	07.03-	CS974	12 1.8
		07.03-	CA1446IR	14 90			
		07.03-	CA1502IR	14 70			
[BSW]	07.05-	CA1394IR	14 120	07.05-	CS974	12 1.8	
	07.05-	CA1446IR	14 90				
	07.05-	CA1446IR	14 90				
New Beetle 2.0	[AEG]	01.98-03.98	CA1240IR	14 90	01.98-03.98	CS619	12 1.1
		01.98-03.98	CA1267IR	14 70	03.98-10.01	CS1119	12 1.1
		01.98-10.01	CA1394IR	14 120	AT 01.98-10.01	CS1062	12 1.1
		03.98-10.01	CA1378IR	14 90			
		03.98-10.01	CA1436IR	14 70			
	[APK]	06.00-06.05	CA1378IR	14 90	AT 06.00-06.05	CS1062	12 1.1
		06.00-06.05	CA1394IR	14 120	06.00-06.05	CS1119	12 1.1
		06.00-06.05	CA1436IR	14 70			
	[AQY]	11.98-06.05	CA1378IR	14 90	11.98-06.05	CS1119	12 1.1
		11.98-06.05	CA1394IR	14 120	AT 11.98-06.05	CS1062	12 1.1
		11.98-06.05	CA1436IR	14 70			
	[AVH]	09.00-	CA1378IR	14 90	AT 09.00-	CS1062	12 1.1
		09.00-	CA1394IR	14 120	09.00-	CS1119	12 1.1
		09.00-	CA1436IR	14 70	AT 01.98-	CS1337	12 1.1
	[AZG]	08.00-06.05	CA1378IR	14 90	AT 08.00-06.05	CS1062	12 1.1
		08.00-06.05	CA1394IR	14 120			
		08.00-06.05	CA1436IR	14 70			
	[AZJ]	01.03-	CA1378IR	14 90	AT 01.03-	CS1337	12 1.1
		01.03-	CA1394IR	14 120	AT 01.03-	CS1062	12 1.1
		01.03-	CA1436IR	14 70	01.03-	CS1119	12 1.1
	[BDC]	01.03-06.03	CA1378IR	14 90	01.03-06.03	CS1119	12 1.1
		01.03-06.03	CA1394IR	14 120	AT, 4SP 01.03-06.03	CS1062	12 1.1
		01.03-06.03	CA1436IR	14 70	AT, 6SP 01.03-06.03	CS1337	12 1.1
	[BEV]	01.03-06.05	CA1378IR	14 90	AT 06.03-	CS1062	12 1.1
01.03-06.05		CA1394IR	14 120	06.03-	CS1119	12 1.1	
01.03-06.05		CA1436IR	14 70	AT, 6SP 01.03-06.05	CS1337	12 1.1	
[BGD]	01.03-06.05	CA1378IR	14 90	01.03-06.05	CS1119	12 1.1	
	01.03-06.05	CA1394IR	14 120	AT, 6SP 01.03-06.05	CS1337	12 1.1	
	01.03-06.05	CA1436IR	14 70				
New Beetle 2.3 V5	[AQN]	10.00-	CA1394IR	14 120	10.00-	CS1266	12 1.8
		10.00-	CA1446IR	14 90			
		10.00-	CA1502IR	14 70			
New Beetle 3.2 RSi	[AXJ]	04.00-05.01	CA1378IR	14 90	04.00-05.01	CS1181	12 2.0
		04.00-05.01	CA1394IR	14 120			
		04.00-05.01	CA1436IR	14 70			
Passat 1.3	[EP]	08.83-07.85	CA241IR	14 55			
		08.83-07.85	CA242IR	14 65			
		08.83-07.87	CA320IR	14 90			
		08.83-07.85	CA520IR	14 65			
		08.85-07.87	CA296IR	14 55			
		08.85-07.87	CA298IR	14 65			
	[EU]	01.78-12.79	CA85IR	14 55	01.78-07.83	CS79	12 0.8
		12.79-07.83	CA136IR	14 45			
		08.80-07.83	CA139IR	14 65			
		08.83-07.85	CA241IR	14 55			
		08.83-07.85	CA242IR	14 65			
		08.83-07.85	CA320IR	14 90			
	[FY]	01.78-07.83	CA136IR	14 45	01.78-07.83	CS79	12 0.8
		01.78-07.83	CA139IR	14 65			
		01.78-07.79	CA85IR	14 55			
	[FZ]	01.78-07.83	CA136IR	14 45	01.78-07.83	CS79	12 0.8
		01.78-07.83	CA139IR	14 65			
		01.78-07.83	CA85IR	14 55			
[ZA]	05.73-01.78	CA35IR	14 35	05.73-01.78			
	05.73-01.78	CA52IR	14 55				
[ZF]	05.73-01.78	CA35IR	14 35				
	05.73-01.78	CA52IR	14 55				
Passat 1.4 TSi	[CAXA]	05.07-	CA1921IR	14 110	AT 05.07-	CS1470	12 1.1
		05.07-	CA1985IR	14 140	6SP 05.07-	CS1294	12 1.1
					A25 08.10-	CS1293	12 2.0
					A26 08.10-	CS1293	12 2.0
Passat 1.4 TSi MultiFuel	[CKMA]				DKG 11.10-	CS1293	12 2.0
					11.10-	CS1293	12 2.0
					11.10-	CS1294	12 1.1



**VW Continued**

Passat 1.4 TSi EcoFuel	[CDGA]	01.09-	CA1985IR	14 140	A24 01.09- A25 08.10- A26 08.10- 01.09-	CS1470 CS1293 CS1293 CS1294	12 1.1 12 2.0 12 2.0 12 1.1	
Passat 1.5	[YJ]	08.74- 08.75 08.74- 08.75	CA351R CA521R	14 35 14 55				
	[ZB]	07.73- 07.74 07.73- 07.74	CA351R CA521R	14 35 14 55				
	[ZC]	07.73- 08.75 07.73- 08.75	CA351R CA521R	14 35 14 55				
	[CK]	08.77- 07.80 08.77- 07.80 08.77- 07.79 08.79- 07.80	CA1411R CA2371R CA351R CA1401R	14 65 14 65 14 35 14 45	08.77- 07.80	CS185	12 1.5	
Passat 1.6	[1F]	04.88- 07.90 04.88- 07.90	CA2981R CA3201R	14 65 14 90	04.88- 07.90	CS559	12 1.0	
	[ADP]	10.96- 09.98 10.96- 11.00 10.96- 09.98 09.98- 11.00 09.98- 11.00 09.98- 11.00	CA10931R CA11391R CA11401R CA15451R CA15461R CA16641R	14 70 14 90 14 120 14 70 14 90 14 120	10.96- 11.00	CS612	12 1.1	
	[AEK]	10.94- 12.95 10.94- 12.95 AC 10.94- 12.95 AC 10.94- 12.95	CA7331R CA7401R CA7361R CA8271R	14 70 14 90 14 90 14 70	10.94- 12.95 AT 10.94- 12.95	CS619 CS618	12 1.1 12 1.1	
	[AFT]	12.95- 03.97 12.95- 03.97 AC 12.95- 03.97 AC 12.95- 03.97	CA7331R CA7401R CA7361R CA8271R	14 70 14 90 14 90 14 70	AT 12.95- 03.97 12.95- 03.97	CS618 CS619	12 1.1 12 1.1	
	[AHL]	09.88- 11.00 10.96- 09.98 10.96- 09.98 10.96- 09.98 09.98- 11.00 09.98- 11.00 09.98- 11.00	CA17591R CA10931R CA11391R CA11401R CA15451R CA15461R CA16641R	14 120 14 70 14 90 14 120 14 70 14 90 14 120	10.96- 11.00	CS612	12 1.1	
	[ALZ]	11.00- 05.05 11.00- 05.05 11.00- 05.05 11.00- 05.05	CA15451R CA15461R CA16641R CA17591R	14 70 14 90 14 120 14 120	Chas. -3B-4-200000 11.00- 11.03 Chas. 3B-4-200001- 11.03- 05.05	CS612 CS1394	12 1.1 12 1.2	
	[ANA]	07.99- 11.00 07.99- 11.00 07.99- 11.00 07.99- 11.00	CA15451R CA15461R CA16641R CA17591R	14 70 14 90 14 120 14 120	07.97- 11.00	CS612	12 1.1	
	[ARM]	01.99- 11.00 01.99- 11.00 01.99- 11.00 01.99- 11.00	CA15451R CA15461R CA16641R CA17591R	14 70 14 90 14 120 14 120	01.99- 11.00	CS612	12 1.1	
	[BSE]	05.05- 05.05-	CA17821R CA18181R	14 140 14 110	05.05-	CS1322	12 1.1	
	[BSF]	05.05- 05.05-	CA17821R CA18181R	14 140 14 110	05.05-	CS1322	12 1.1	
	[DT]	08.80- 07.85 08.80- 03.88 08.80- 03.88 08.80- 03.88 08.83- 07.85 08.83- 08.84	CA2411R CA2961R CA2981R CA3201R CA2421R CA3181R	14 55 14 55 14 65 14 90 14 65 14 90	08.80- 03.88	CS297	12 0.95	
	[EZ]	02.88- 09.91 02.88- 09.91	CA2981R CA3201R	14 65 14 90	02.88- 07.91 08.90- 07.91 07.91- 09.91	CS559 CS601 CS619	12 1.0 12 1.1 12 1.1	
	[FS]	02.76- 07.79 08.77- 07.79	CA521R CA11411R	14 55 14 120				
	[JU]	08.83- 07.85 08.83- 07.85 08.83- 09.86 08.85- 09.86 08.85- 09.86	CA2411R CA2421R CA3201R CA2961R CA2981R	14 55 14 65 14 90 14 55 14 65	08.84- 09.86	CS297	12 0.95	
	[PP]	03.87- 03.88 03.87- 03.88 03.87- 03.88	CA2961R CA2981R CA3201R	14 55 14 65 14 90	08.87- 03.88	CS297	12 0.95	
	[RF]	03.88- 07.89 03.88- 07.89 03.88- 07.89	CA2961R CA2981R CA3201R	14 55 14 65 14 90	03.88- 07.89	CS559	12 1.0	
	[RL]	02.86- 03.88 02.86- 03.88 02.86- 03.88	CA2961R CA2981R CA3201R	14 55 14 65 14 90	02.86- 03.88	CS297	12 0.95	
	[WV]	08.81- 07.83 08.81- 07.83	CA1401R CA1411R	14 45 14 65	08.81- 07.83	CS297	12 0.95	
	[YN]	09.75- 07.79 09.75- 07.79 08.77- 07.81 08.79- 07.81	CA351R CA521R CA1411R CA1401R	14 35 14 55 14 65 14 45				
	[YP]	08.75- 07.79 08.75- 07.79 08.77- 02.83 08.79- 02.83	CA351R CA521R CA1411R CA1401R	14 35 14 55 14 65 14 45	08.75- 02.83	CS297	12 0.95	
	Passat 1.6 FSi	[BLF]	03.05- 03.05-	CA18171R CA19851R	14 110 14 140	AT 03.05- 03.05-	CS1347 CS1322	12 1.1 12 1.1
	Passat 1.6 i	[YS]	06.78- 07.80 06.78- 07.80 06.78- 07.79 08.79- 07.80	CA1411R CA1631R CA521R CA1401R	14 65 14 75 14 55 14 45			
	Passat 1.6	[RA]	08.88- 07.89 08.88- 07.89 08.88- 07.89 08.88- 07.89	CA10581R CA3021R CA5051R CA6101R	14 90 14 65 14 45 14 90	08.88- 07.89 AT 08.88- 07.89	CS574 CS295	12 1.7 12 1.7
Passat 1.6 Diesel	[CR]	08.80- 07.82 08.80- 07.82	CA2371R CA3671R	14 65 14 45	08.80- 07.82 08.80- 07.82	CS606 CS185	12 1.7 12 1.5	



	[JK]	08.82- 07.85	CA237IR	14 65		08.82- 03.88	CS606	12 1.7
		08.82- 07.85	CA367IR	14 45		08.82- 03.88	CS185	12 1.5
		08.85- 03.88	CA337IR	14 45				
		08.85- 03.88	CA520IR	14 65				
		AC 08.85- 03.88	CA318IR	14 90				
Passat 1.6 TD	[CY]	04.82- 07.85	CA237IR	14 65		04.82- 03.88	CS606	12 1.7
		04.82- 07.85	CA367IR	14 45		04.82- 03.88	CS185	12 1.5
		08.85- 03.88	CA337IR	14 45				
		08.85- 03.88	CA520IR	14 65				
		AC 08.85- 03.88	CA318IR	14 90				
	[RA]	08.88- 07.89	CA302IR	14 65		AT 08.88- 07.89	CS295	12 1.7
		08.88- 07.89	CA505IR	14 45		08.88- 07.89	CS574	12 1.7
		08.88- 07.89	CA610IR	14 90				
		AC 08.88- 07.89	CA1058IR	14 90				
	[SB]	08.89- 10.93	CA302IR	14 65		08.89- 10.93	CS574	12 1.7
		08.89- 10.93	CA505IR	14 45		08.89- 10.93	CS616	12 1.8
		08.89- 10.93	CA610IR	14 90				
		AC 08.89- 09.93	CA1058IR	14 90				
Passat 1.6 Tdi	[CAYC]					A25 08.10-	CS1505*	12 2.0
Passat 1.8	[ABS]	Chas. 31-P-200001- 12.91- 05.97	CA732IR	14 60		08.91- 09.94	CS619	12 1.1
		Chas. 31-P-200001- 12.91- 05.97	CA733IR	14 70		AT 08.91- 09.94	CS618	12 1.1
		Chas. 31-P-200001- 12.91- 05.97	CA740IR	14 90				
		Chas. -31-P-200000 08.91- 12.92	CA298IR	14 65				
		Chas. -31-P-200000 08.91- 12.92	CA320IR	14 90 ▲				
		AC 07.92- 05.97	CA736IR	14 90				
		AC 07.92- 05.97	CA827IR	14 70				
	[ADR]	10.96- 09.98	CA1093IR	14 70		10.96- 01.99	CS612	12 1.1
		10.96- 09.98	CA1139IR	14 90				
		10.96- 09.98	CA1140IR	14 120				
		09.98- 01.99	CA1545IR	14 70				
		09.98- 01.99	CA1546IR	14 90				
		09.98- 01.99	CA1664IR	14 120				
	[ADZ]	10.94- 05.97	CA733IR	14 70		10.94- 05.97	CS1119	12 1.1
		10.94- 05.97	CA740IR	14 90		AT 10.94- 05.97	CS1062	12 1.1
		AC 10.94- 05.97	CA736IR	14 90		10.94- 05.97	CS619	12 1.1
		AC 10.94- 05.97	CA827IR	14 70		AT 10.94- 05.97	CS618	12 1.1
		AC 10.94- 05.97	CA828IR	14 120				
	[AFY]	01.97- 09.98	CA1093IR	14 70		01.97- 04.00	CS612	12 1.1
		01.97- 09.98	CA1140IR	14 120				
		09.98- 04.00	CA1546IR	14 90				
	[APT]	01.99- 08.00	CA1545IR	14 70		01.99- 08.00	CS612	12 1.1
		01.99- 08.00	CA1546IR	14 90				
		01.99- 08.00	CA1664IR	14 120				
	[ARG]	02.99- 11.00	CA1545IR	14 70		02.99- 11.00	CS612	12 1.1
		02.99- 11.00	CA1546IR	14 90				
		02.99- 11.00	CA1664IR	14 120				
		02.99- 11.00	CA1759IR	14 120				
	[DS]	01.83- 07.85	CA241IR	14 55		01.83- 03.88	CS297	12 0.95
		01.83- 07.85	CA242IR	14 65				
		01.83- 03.88	CA320IR	14 90				
		08.85- 03.88	CA296IR	14 55				
		08.85- 03.88	CA298IR	14 65				
	[DZ]	12.83- 07.94	CA241IR	14 55		12.83- 03.88	CS297	12 0.95
		12.83- 07.85	CA242IR	14 65				
		12.83- 03.88	CA320IR	14 90				
		08.85- 03.88	CA296IR	14 55				
		08.85- 03.88	CA298IR	14 65				
	[JN]	01.83- 07.85	CA241IR	14 55		01.83- 03.88	CS297	12 0.95
		01.83- 07.85	CA242IR	14 65				
		01.83- 03.88	CA320IR	14 90				
		08.85- 03.88	CA296IR	14 55				
		08.85- 03.88	CA298IR	14 65				
	[PB]	04.88- 07.90	CA296IR	14 55		AT 04.88- 07.90	CS294	12 0.9
		04.88- 07.90	CA298IR	14 65		04.88- 07.90	CS559	12 1.0
		04.88- 07.90	CA320IR	14 90				
	[PF]	04.88- 07.90	CA320IR	14 90		04.88- 07.90	CS559	12 1.0
						AT 04.88- 07.90	CS294	12 0.9
	[RM]	05.86- 03.88	CA296IR	14 55		05.86- 03.88	CS297	12 0.95
		05.86- 03.88	CA298IR	14 65				
		05.86- 03.88	CA320IR	14 90				
	[RP]	02.88- 07.91	CA298IR	14 65		AT 02.88- 07.91	CS294	12 0.9
		02.88- 07.91	CA320IR	14 90		08.90- 07.91	CS601	12 1.1
						02.88- 07.90	CS559	12 1.0
	[AAM]	08.90- 11.92	CA298IR	14 65		08.90- 07.91	CS601	12 1.1
		08.90- 12.92	CA320IR	14 90		08.90- 07.91	CS559	12 1.0
		12.91- 05.97	CA732IR	14 60		08.91- 05.97	CS619	12 1.1
		12.92- 05.97	CA733IR	14 70		AT 08.90- 07.91	CS294	12 0.9
		12.92- 05.97	CA740IR	14 90		AT 08.91- 05.97	CS618	12 1.1
		12.92- 05.97	CA828IR	14 120				
		AC 07.92- 05.97	CA736IR	14 90				
		AC 07.92- 05.97	CA827IR	14 70				
Passat 1.8 4 Motion	[AWM]	03.01- 05.05	CA1545IR	14 70		Chas. 3B4157001- 03.01- 05.05	CS1394	12 1.2
		03.01- 05.05	CA1546IR	14 90		Chas. -3B4157000 03.01- 05.05	CS612	12 1.1
		03.01- 05.05	CA1664IR	14 120				
		03.01- 05.05	CA1759IR	14 120				
Passat 1.8 Syncro	[DS]	01.86- 03.88	CA298IR	14 65		01.86- 03.88	CS297	12 0.95
		01.86- 03.88	CA320IR	14 90				
	[JN]	01.86- 03.88	CA298IR	14 65		01.86- 03.88	CS297	12 0.95
		01.86- 03.88	CA320IR	14 90				
Passat 1.8 Syncro 4 Motion	[ADR]	06.97- 09.98	CA1093IR	14 70		12.96- 11.00	CS612	12 1.1
		06.97- 09.98	CA1139IR	14 90				
		06.97- 09.98	CA1140IR	14 120				
		09.98- 11.00	CA1545IR	14 70				
		09.98- 11.00	CA1546IR	14 90				
		09.98- 11.00	CA1664IR	14 120				
	[APT]	01.99- 11.00	CA1545IR	14 70		01.99- 11.00	CS612	12 1.1
		01.99- 11.00	CA1546IR	14 90				
		01.99- 11.00	CA1664IR	14 120				
	[ARG]	01.99- 11.00	CA1545IR	14 70		01.99- 11.00	CS612	12 1.1
		01.99- 11.00	CA1546IR	14 90				
		01.99- 11.00	CA1664IR	14 120				
		01.99- 11.00	CA1759IR	14 120				



**VW Continued**

Passat 1.8 16V	[KR]	04.88- 07.92	CA342IR	14 65	AT 08.91- 07.92	CS618	12 1.1	
		04.88- 07.89	CA343IR	14 90	08.90- 07.91	CS601	12 1.1	
		07.89- 07.92	CA521IR	14 90	AT 08.90- 07.91	CS294	12 0.9	
Passat 1.8 G60 Syncro	[PG]	09.89- 06.92	CA840IR	14 65	08.90- 07.93	CS601	12 1.1	
		09.89- 06.92	CA841IR	14 90	09.89- 07.90	CS559	12 1.0	
		07.92- 03.97	CA732IR	14 60				
		07.92- 03.97	CA733IR	14 70				
		07.92- 03.97	CA740IR	14 90				
		07.92- 03.97	CA828IR	14 120				
		AC 07.92- 03.97	CA736IR	14 90				
		AC 07.92- 03.97	CA827IR	14 70				
Passat 1.8 TSi	[BZB]	05.07-	CA1811IR	14 140	AT 05.07- AT, 7SP 05.07- 05.07-	CS1347 CS1470 CS1294	12 1.1 12 1.1 12 1.1	
		[CDAB]	02.11-	CA1811IR	14 140	02.11-	CS1294	12 1.1
		[CDAA]	06.08-	CA1811IR	14 140	AT 11.09- 06.08-	CS1470 CS1294	12 1.1 12 1.1
Passat 1.8 Turbo 20V	[AWL]	11.00- 05.05	CA1545IR	14 70	Chas. 3B-4-200001-11.03- 05.05	CS1394	12 1.2	
		11.00- 05.05	CA1546IR	14 90	Chas. -3B-4-200000 11.00- 11.03	CS612	12 1.1	
		11.00- 05.05	CA1664IR	14 120				
	[AWT]	AC 11.00- 05.05	CA1546IR	14 90				
		11.00- 05.05	CA1545IR	14 70	Chas. -3B-4-200000 11.00- 11.03	CS612	12 1.1	
		11.00- 05.05	CA1546IR	14 90	Chas. 3B-4-200001- 11.03- 05.05	CS1394	12 1.2	
		AC 11.00- 05.05	CA1546IR	14 90				
Passat 1.8 Turbo	[AEB]	10.96- 09.98	CA1093IR	14 70	10.96- 11.00	CS612	12 1.1	
		10.96- 09.98	CA1139IR	14 90				
		10.96- 09.98	CA1140IR	14 120				
		05.97- 11.00	CA1759IR	14 120				
		09.98- 11.00	CA1545IR	14 70				
		09.98- 11.00	CA1546IR	14 90				
	[ANB]	09.98- 11.00	CA1664IR	14 120				
		08.98- 11.00	CA1545IR	14 70	08.98- 11.00	CS612	12 1.1	
		08.98- 11.00	CA1546IR	14 90				
	[APU]	08.98- 11.00	CA1664IR	14 120				
		08.98- 11.00	CA1759IR	14 120				
		01.99- 11.00	CA1545IR	14 70	01.99- 11.00	CS612	12 1.1	
[AWM]	01.99- 11.00	CA1546IR	14 90					
	01.99- 11.00	CA1664IR	14 120					
	01.99- 11.00	CA1759IR	14 120					
Passat 1.9	[WNI]	02.01- 05.05	CA1545IR	14 70	Chas. -3B-4-200000 02.00- 10.03	CS612	12 1.1	
		02.01- 05.05	CA1546IR	14 90	Chas. 3B-4-200001- 11.03- 05.05	CS1394	12 1.2	
		02.01- 05.05	CA1664IR	14 120				
Passat 1.9 Diesel	[1Y]	01.81- 07.83	CA140IR	14 45	01.81- 07.83	CS132	12 1.1	
		01.81- 07.83	CA141IR	14 65				
		01.81- 07.81	CA163IR	14 75				
Passat 1.9 Diesel	[1Y]	05.89- 11.91	CA302IR	14 65	05.89- 07.91	CS574	12 1.7	
		05.89- 11.91	CA505IR	14 45	08.91- 09.93	CS616	12 1.8	
		05.89- 11.91	CA610IR	14 90	AT 05.89- 09.93	CS713	12 1.8	
		11.91- 09.93	CA732IR	14 60				
		11.91- 09.93	CA733IR	14 70				
		11.91- 09.93	CA740IR	14 90				
		AC 05.89- 09.93	CA828IR	14 120				
		AC 11.91- 09.93	CA736IR	14 90				
		AC 11.91- 09.93	CA827IR	14 70				
Passat 1.9 TD	[AAZ]	03.91- 03.97	CA732IR	14 60	04.94- 03.97	CS974	12 1.8	
		03.91- 03.97	CA733IR	14 70	AT 03.91- 03.97	CS713	12 1.8	
		03.91- 03.97	CA740IR	14 90	03.91- 07.91	CS574	12 1.7	
		03.91- 03.97	CA828IR	14 120	08.91- 02.96	CS616	12 1.8	
		AC 03.91- 03.97	CA736IR	14 90				
		AC 03.91- 03.97	CA827IR	14 70				
		AC 03.91- 03.97	CA828IR	14 120				
Passat 1.9 TDi	[1Z]	10.93- 08.96	CA1089IR	14 120	10.93- 02.96	CS616	12 1.8	
		10.93- 08.96	CA736IR	14 90	04.94- 08.96	CS974	12 1.8	
		10.93- 08.96	CA827IR	14 70	AT 10.93- 08.96	CS713	12 1.8	
	[AFN]	03.96- 03.97	CA1260IR	14 120	03.96- 03.97	CS974	12 1.8	
		03.96- 03.97	CA736IR	14 90	AT 03.96- 03.97	CS1287	12 2.0	
		03.96- 03.97	CA827IR	14 70	AT 03.96- 03.97	CS789	12 1.8	
		10.96- 09.98	CA1248IR	14 120	10.96- 11.00	CS624	12 1.8	
		10.96- 09.98	CA1486IR	14 90				
		09.98- 11.00	CA1540IR	14 90				
	[AHH]	09.98- 11.00	CA1541IR	14 120				
		05.98- 09.98	CA1248IR	14 120	08.97- 11.00	CS624	12 1.8	
		05.98- 09.98	CA1486IR	14 90				
	[AHU]	09.98- 11.00	CA1540IR	14 90				
		09.98- 11.00	CA1541IR	14 120				
		08.96- 03.97	CA1089IR	14 120	08.96- 03.97	CS974	12 1.8	
		08.96- 03.97	CA736IR	14 90	10.96- 11.00	CS624	12 1.8	
		08.96- 03.97	CA827IR	14 70				
		10.96- 06.97	CA1403IR	14 120				
	[AJM]	10.96- 09.98	CA1486IR	14 90				
		06.97- 09.98	CA1248IR	14 120				
		09.98- 11.00	CA1540IR	14 90				
		09.98- 11.00	CA1541IR	14 120				
		01.98- 08.98	CA1486IR	14 90	AT 08.98- 11.00	CS624	12 1.8	
		08.98- 09.98	CA1248IR	14 120	08.98- 11.00	CS1208	12 1.8	
[ATJ]	09.98- 11.00	CA1540IR	14 90					
	09.98- 11.00	CA1541IR	14 120					
[AVB]	12.99- 11.00	CA1540IR	14 90	12.99- 11.00	CS1208	12 1.8		
	12.99- 11.00	CA1541IR	14 120	AT 12.99- 11.00	CS624	12 1.8		
[AVF]	10.00-	CA1540IR	14 90	AT 10.00-	CS624	12 1.8		
	10.00-	CA1541IR	14 120					
	10.00-	CA1678IR	14 140					
[AVG]	11.00-	CA1540IR	14 90	11.00- 12.03	CS1208	12 1.8		
	11.00-	CA1541IR	14 120	01.04-	CS1387	12 1.7		
	11.00-	CA1678IR	14 140	AT 11.00-	CS624	12 1.8		
[AWX]	08.99- 11.00	CA1540IR	14 90	08.99- 11.00	CS624	12 1.8		
	08.99- 11.00	CA1541IR	14 120					
[AWX]	11.00-	CA1540IR	14 90	11.00-	CS624	12 1.8		
	11.00-	CA1541IR	14 120					
	11.00-	CA1678IR	14 140					



	[BKC]	03.05-03.05-	CA1782IR CA1912IR	14 140 14 180		03.05-	CS1293	12 2.0
	[BLS]	03.05-03.05-	CA1782IR CA1912IR	14 140 14 180		03.05-	CS1293	12 2.0
	[BXE]	03.05-03.05-	CA1782IR CA1912IR	14 140 14 180		03.05-	CS1293	12 2.0
Passat 1.9 TDi 4 Motion	[AVF]	11.00-05.05 11.00-05.05	CA1541IR CA1678IR	14 120 14 140		AT 11.00-05.05 01.04-05.05 11.00-12.03	CS624 CS1387 CS1208	12 1.8 12 1.7 12 1.8
Passat 1.9 TDi Syncro 4 Motion	[AFN]	06.97-09.98 06.97-09.98 09.98-08.99 09.98-08.99	CA1248IR CA1486IR CA1540IR CA1541IR	14 120 14 90 14 90 14 120		06.97-08.99	CS624	12 1.8
	[AJM]	08.99-02.01 08.99-02.01	CA1540IR CA1541IR	14 90 14 120		08.99-02.01	CS624	12 1.8
	[ATJ]	08.99-02.01 08.99-02.01	CA1540IR CA1541IR	14 90 14 120		AT 08.99-02.01 01.00-11.00	CS624 CS1208	12 1.8 12 1.8
	[AVG]	08.99-10.00 08.99-10.00	CA1540IR CA1541IR	14 90 14 120		08.99-10.00	CS624	12 1.8
Passat 2.0	[2E]	03.90-07.92 03.90-07.92 07.92-09.94 07.92-09.94 07.92-09.94 07.92-09.94 AC 07.92-09.94 AC 07.92-09.94	CA298IR CA320IR CA732IR CA733IR CA740IR CA828IR CA736IR CA827IR	14 65 14 90 14 60 14 70 14 90 14 120 14 90 14 70		08.90-07.91 AT 08.91-09.94 AT 08.90-07.91 08.90-07.91 08.91-09.94	CS601 CS618 CS294 CS559 CS619	12 1.1 12 1.1 12 0.9 12 1.0 12 1.1
	[ADY]	10.94-07.95 10.94-07.95 10.94-07.95 10.94-07.95 AC 10.94-07.95 AC 10.94-07.95	CA732IR CA733IR CA740IR CA828IR CA736IR CA827IR	14 60 14 70 14 90 14 120 14 90 14 70		10.94-07.95 AT 10.94-07.95	CS619 CS618	12 1.1 12 1.1
	[AEP]	03.95-08.96 03.95-08.96 AC 03.95-08.96 AC 03.95-08.96	CA733IR CA740IR CA736IR CA827IR	14 70 14 90 14 90 14 70		AT 10.94-03.97 10.94-03.97	CS618 CS619	12 1.1 12 1.1
	[AGG]	07.95-03.97 07.95-03.97 07.95-03.97 07.95-03.97 AC 07.95-03.97 AC 07.95-03.97	CA732IR CA733IR CA740IR CA828IR CA736IR CA827IR	14 60 14 70 14 90 14 120 14 90 14 70		AT 07.95-03.97 07.95-03.97	CS618 CS619	12 1.1 12 1.1
	[ALT]	11.01-05.05	CA1546IR	14 90		Chas. 3B-4-200001-11.03-05.05 Chas. -3B-4-200000 11.01-10.03	CS1394 CS612	12 1.2 12 1.1
	[ASU]	04.00-11.00 04.00-11.00 04.00-11.00	CA1545IR CA1546IR CA1759IR	14 70 14 90 14 120		01.00-11.00	CS612	12 1.1
	[AUZ]	04.00-11.00 04.00-11.00 04.00-11.00	CA1545IR CA1546IR CA1759IR	14 70 14 90 14 120		01.00-11.00	CS612	12 1.1
	[AZM]	11.00-05.05 11.00-05.05 11.00-05.05 11.00-05.05	CA1545IR CA1546IR CA1664IR CA1759IR	14 70 14 90 14 120 14 120		Chas. -3B-4-200000 11.00-11.03 Chas. 3B-4-200001-11.03-05.05	CS612 CS1394	12 1.1 12 1.2
	[BFF]	11.00-02.07 11.00-02.07 11.00-02.07 11.00-02.07	CA1545IR CA1546IR CA1664IR CA1759IR	14 70 14 90 14 120 14 120		Chas. 3B-4-200001-11.03-02.07 Chas. -3B-4-200000 11.00-11.03	CS1394 CS612	12 1.2 12 1.1
	[HP]	08.83-07.87 08.83-03.88 08.83-07.87 08.85-07.87 08.85-03.88 AC 08.83-07.87	CA318IR CA320IR CA708IR CA298IR CA911IR# CA708IR	14 90 14 90 14 90 14 65 14 65 14 90		08.84-03.88 08.83-07.84	CS282 CS132	12 1.1 12 1.1
	[JS]	08.83-03.88 08.85-03.88 AC 12.85-03.88	CA320IR CA911IR# CA708IR	14 90 14 65 14 90		08.84-03.88 08.83-07.84	CS282 CS132	12 1.1 12 1.1
Passat 2.0 4 Motion	[ASU]	04.00-11.00 04.00-11.00 04.00-11.00	CA1545IR CA1546IR CA1759IR	14 70 14 90 14 120		01.00-11.00	CS612	12 1.1
	[AUZ]	04.00-11.00 04.00-11.00 04.00-11.00	CA1545IR CA1546IR CA1759IR	14 70 14 90 14 120		04.00-11.00	CS612	12 1.1
	[AZM]	11.00-05.05 11.00-05.05 11.00-05.05 11.00-05.05	CA1545IR CA1546IR CA1664IR CA1759IR	14 70 14 90 14 120 14 120		Chas. 3B-4-200001-11.03-05.05 Chas. -3B-4-200000 11.00-11.03	CS1394 CS612	12 1.2 12 1.1
Passat 2.0 Syncro	[2E]	10.90-07.92 10.90-07.92 07.92-09.94 07.92-09.94 07.92-09.94 07.92-09.94 AC 07.92-09.94 AC 07.92-09.94	CA298IR CA320IR CA732IR CA733IR CA740IR CA828IR CA736IR CA827IR	14 65 14 90 14 60 14 70 14 90 14 120 14 90 14 70		10.90-07.91 08.91-09.94	CS601 CS619	12 1.1 12 1.1
	[ADY]	10.94-12.95 10.94-12.95 10.94-12.95 10.94-12.95 AC 10.94-12.95 AC 10.94-12.95	CA732IR CA733IR CA740IR CA828IR CA736IR CA827IR	14 60 14 70 14 90 14 120 14 90 14 70		10.94-12.95	CS619	12 1.1
	[AGG]	07.95-12.96 07.95-12.96 07.95-12.96 07.95-12.96 AC 07.95-12.96 AC 07.95-12.96	CA732IR CA733IR CA740IR CA828IR CA736IR CA827IR	14 60 14 70 14 90 14 120 14 90 14 70		07.95-12.96	CS619	12 1.1
	[JS]	08.84-07.85	CA320IR	14 90		08.84-07.85	CS282	12 1.1
Passat 2.0 16V	[9A]	08.88-09.93 08.88-07.89	CA342IR CA343IR	14 65 14 90		AT 08.91-09.93 08.90-07.91 AT 08.90-07.91 08.90-07.91 08.91-09.93	CS618 CS601 CS294 CS559 CS619	12 1.1 12 1.1 12 0.9 12 1.0 12 1.1



VW Continued

	[ABF]	01.94- 03.97	CA736IR	14 90	AT 01.94- 03.97	CS618	12 1.1
		01.94- 03.97	CA827IR	14 70	01.94- 03.97	CS619	12 1.1
		01.94- 03.97	CA828IR	14 120			
Passat 2.0 16V GT	[9A]	08.88- 09.93	CA342IR	14 65	08.91- 09.93	CS619	12 1.1
		08.88- 07.89	CA343IR	14 90	AT 08.91- 09.93	CS618	12 1.1
					AT 08.90- 07.91	CS294	12 0.9
					08.90- 07.91	CS559	12 1.0
					08.90- 07.91	CS601	12 1.1
Passat 2.0 FSi	[BLR]	03.05- 11.05	CA1782IR	14 140	03.05- 11.05	CS1294	12 1.1
		03.05- 11.05	CA1912IR	14 180	AT 03.05- 11.05	CS1347	12 1.1
	[BLY]	03.05- 11.05	CA1782IR	14 140	03.05- 11.05	CS1294	12 1.1
		03.05- 11.05	CA1912IR	14 180	AT 03.05- 11.05	CS1347	12 1.1
	[BVY]	11.05- 11.05	CA1782IR	14 140	11.05- 11.05	CS1294	12 1.1
		11.05- 11.05	CA1912IR	14 180	AT 11.05- 11.05	CS1347	12 1.1
	[BVZ]	08.05- 08.05	CA1782IR	14 140	08.05- 08.05	CS1294	12 1.1
		08.05- 08.05	CA1912IR	14 180	AT 08.05- 08.05	CS1347	12 1.1
Passat 2.0 FSi 4 Motion	[BLX]	09.05- 09.05	CA1782IR	14 140	09.05- 09.05	CS1294	12 1.1
		09.05- 09.05	CA1912IR	14 180	AT 09.05- 09.05	CS1347	12 1.1
	[BLY]	09.05- 09.05	CA1782IR	14 140	AT 09.05- 09.05	CS1347	12 1.1
		09.05- 09.05	CA1912IR	14 180	09.05- 09.05	CS1294	12 1.1
	[BVX]	09.05- 09.05	CA1782IR	14 140	AT 09.05- 09.05	CS1347	12 1.1
		09.05- 09.05	CA1912IR	14 180	09.05- 09.05	CS1294	12 1.1
Passat 2.0 TFSi	[AXX]	07.05- 07.05	CA1782IR	14 140	07.05- 07.05	CS1347	12 1.1
		07.05- 07.05	CA1912IR	14 180			
	[BPY]	07.05- 07.05	CA1782IR	14 140	07.05- 07.05	CS1347	12 1.1
		07.05- 07.05	CA1912IR	14 180			
	[BWA]	07.05- 07.05	CA1782IR	14 140	07.05- 07.05	CS1347	12 1.1
		07.05- 07.05	CA1912IR	14 180			
	[CAWB]	11.07- 11.07	CA1811IR	14 140	AT 11.07- 11.07	CS1347	12 1.1
	[CBFA]	12.07- 12.07	CA1811IR	14 140	12.07- 12.07	CS1347	12 1.1
	[CCTA]	12.07- 12.07	CA1811IR	14 140	AT 12.07- 12.07	CS1347	12 1.1
	[CCZA]	11.09- 11.09	CA1811IR	14 140	11.09- 11.09	CS1347	12 1.1
Passat 2.0 TSi	[CCZB]				11.10- 11.10	CS1347	12 1.1
Passat 2.0 TSi CC	[CAWB]	06.08- 11.09	CA1811IR	14 140	06.08- 11.09	CS1347	12 1.1
	[CCTA]	06.08- 06.08	CA1811IR	14 140	06.08- 06.08	CS1347	12 1.1
	[CCZA]	11.09- 11.09	CA1811IR	14 140	11.09- 11.09	CS1347	12 1.1
Passat 2.0 TDi 16V	[BKP]	03.05- 03.05	CA1782IR	14 140	03.05- 03.05	CS1323	12 2.0
		03.05- 03.05	CA1912IR	14 180			
	[CBAB]	01.08- 01.08	CA1782IR	14 140	AT 01.08- 01.08	CS1286	12 2.0
		01.08- 01.08	CA1810IR	14 110	01.08- 01.08	CS1323	12 2.0
		01.08- 01.08	CA1912IR	14 180			
Passat 2.0 TDi 16V 4 Motion	[BKP]	03.05- 03.05	CA1782IR	14 140	03.05- 03.05	CS1323	12 2.0
		03.05- 03.05	CA1912IR	14 180	AT 03.05- 03.05	CS1286	12 2.0
	[CBAB]	05.08- 05.08	CA1782IR	14 140	AT 05.08- 05.08	CS1286	12 2.0
		05.08- 05.08	CA1810IR	14 110	05.08- 05.08	CS1323	12 2.0
		05.08- 05.08	CA1912IR	14 180			
Passat 2.0 TDi	[BGH]	11.03- 05.05	CA1540IR	14 90	11.03- 12.03	CS1208	12 1.8
		11.03- 05.05	CA1541IR	14 120	01.04- 05.05	CS1387	12 1.7
		11.03- 05.05	CA1678IR	14 140	AT 11.03- 05.05	CS624	12 1.8
	[BGW]	11.03- 05.05	CA1540IR	14 90	AT 11.03- 05.05	CS624	12 1.8
		11.03- 05.05	CA1541IR	14 120	01.04- 05.05	CS1387	12 1.7
		11.03- 05.05	CA1678IR	14 140	11.03- 12.03	CS1208	12 1.8
	[BMA]	03.05- 03.05	CA1782IR	14 140	6SP 03.05- 03.05	CS1323	12 2.0
		03.05- 03.05	CA1912IR	14 180	AT 03.05- 03.05	CS1286	12 2.0
	[BMP]	03.05- 03.05	CA1782IR	14 140	03.05- 03.05	CS1323	12 2.0
		03.05- 03.05	CA1912IR	14 180	AT 03.05- 03.05	CS1286	12 2.0
		08.05- 08.05	CA1810IR	14 110			
	[BMR]	08.05- 08.05	CA1782IR	14 140	AT 08.05- 08.05	CS1286	12 2.0
		08.05- 08.05	CA1912IR	14 180	08.05- 08.05	CS1323	12 2.0
	[BVD]	08.05- 08.05	CA1782IR	14 140	08.05- 08.05	CS1323	12 2.0
		08.05- 08.05	CA1912IR	14 180			
	[BVE]	08.05- 08.05	CA1782IR	14 140	08.05- 08.05	CS1323	12 2.0
		08.05- 08.05	CA1912IR	14 180			
	[BWV]	11.05- 11.05	CA1782IR	14 140	11.05- 11.05	CS1323	12 2.0
		11.05- 11.05	CA1912IR	14 180	AT 11.05- 11.05	CS1286	12 2.0
	[CBAB]	06.08- 06.08	CA1782IR	14 140	DSG 06.08- 06.08	CS1286	12 2.0
		06.08- 06.08	CA1912IR	14 180	06.08- 06.08	CS1323	12 2.0
	[CBBB]	08.05- 08.05	CA1782IR	14 140	08.05- 08.05	CS1323	12 2.0
		08.05- 08.05	CA1810IR	14 110	08.05- 08.05	CS1286	12 2.0
		08.05- 08.05	CA1912IR	14 180	08.05- 08.05	CS1508*	12 1.7
	[CBDC]	11.08- 11.08	CA1782IR	14 140	A25 11.08- 11.08	CS1505*	12 2.0
	[CBAA]	01.08- 01.08	CA1782IR	14 140	01.08- 01.08	CS1323	12 2.0
		01.08- 01.08	CA1912IR	14 180	DSG 01.08- 01.08	CS1286	12 2.0
	[CFFA]	08.10- 08.10	CA1782IR	14 140	A25 08.10- 08.10	CS1508*	12 1.7
		08.10- 08.10	CA1912IR	14 180	08.10- 08.10	CS1323	12 2.0
	[CFFB]	08.10- 08.10	CA1782IR	14 140	08.10- 08.10	CS1323	12 2.0
		08.10- 08.10	CA1912IR	14 180			
	[CFGB]	08.10- 08.10	CA1782IR	14 140	08.10- 08.10	CS1323	12 2.0
		08.10- 08.10	CA1912IR	14 180			
		A25 08.10- 08.10	CA2011IR	14 140			
	[CLLA]	08.10- 08.10	CA1782IR	14 140	08.10- 08.10	CS1323	12 2.0
		08.10- 08.10	CA1912IR	14 180			
		A25 08.10- 08.10	CA2011IR	14 140			
Passat 2.0 TDi 4 Motion	[BMP]	03.05- 03.05	CA1782IR	14 140	AT 03.05- 03.05	CS1286	12 2.0
		03.05- 03.05	CA1912IR	14 180	03.05- 03.05	CS1323	12 2.0
	[CBAB]	08.09- 08.09	CA1782IR	14 140	08.09- 08.09	CS1323	12 2.0
		08.09- 08.09	CA1912IR	14 180	08.09- 08.09	CS1508*	12 1.7
					AT 08.09- 08.09	CS1286	12 2.0
	[CBBB]	05.09- 05.09	CA1782IR	14 140	05.09- 05.09	CS1323	12 2.0
		05.09- 05.09	CA1810IR	14 110	AT 05.09- 05.09	CS1286	12 2.0
		05.09- 05.09	CA1912IR	14 180			
Passat 2.0 TDi 4motion	[CFFB]	08.10- 08.10	CA1782IR	14 140	08.10- 08.10	CS1508*	12 1.7
		08.10- 08.10	CA1912IR	14 180			
	[CFGB]	08.10- 08.10	CA1782IR	14 140			
		08.10- 08.10	CA1912IR	14 180			
		A25 08.10- 08.10	CA2011IR	14 140			
	[CLLA]	08.10- 08.10	CA1782IR	14 140	08.10- 08.10	CS1508*	12 1.7
		08.10- 08.10	CA1912IR	14 180			
		A25 08.10- 08.10	CA2011IR	14 140			
Passat 2.0 TDi Blue	[CBAC]	05.09- 05.09	CA1782IR	14 140	05.09- 05.09	CS1323	12 2.0
		05.09- 05.09	CA1912IR	14 180	AT 05.09- 05.09	CS1286	12 2.0
					05.09- 05.09	CS1508*	12 1.7





Passat 2.0 TDi BlueTDI	[CBAC]	01.09-	CA1782IR	14 140	AT 01.09-	CS1286	12 2.0	
		01.09-	CA1810IR	14 110		01.09-	CS1323	12 2.0
		01.09-	CA1912IR	14 180				
Passat 2.0 TDi CC	[CBBB]	06.08-	CA1782IR	14 140	06.08-	CS1286	12 2.0	
		06.08-	CA1912IR	14 180		06.08-	CS1323	12 2.0
	[CBAA]	06.08-	CA1782IR	14 140	06.08-	CS1286	12 2.0	
		06.08-	CA1912IR	14 180		06.08-	CS1323	12 2.0
Passat 2.1	[WE]	08.81- 07.83	CA140IR	14 45	08.81- 07.83	CS132	12 1.1	
Passat 2.2	[KV]	01.85- 03.88	CA320IR	14 90	01.85- 03.88	CS282	12 1.1	
		08.85- 03.88	CA911IR#	14 65				
		AC 12.85- 03.88	CA708IR	14 90 ▲				
	[KX]	08.85- 03.88	CA320IR	14 90	08.85- 03.88	CS282	12 1.1	
		08.85- 03.88	CA911IR#	14 65				
AC 12.85- 03.88	CA708IR	14 90 ▲						
Passat 2.2 Syncro	[JT]	08.85- 03.88	CA320IR	14 90	08.85- 03.88	CS282	12 1.1	
		08.85- 03.88	CA911IR#	14 65				
		AC 12.85- 03.88	CA708IR	14 90 ▲				
Passat 2.3 V5	[AZX]	11.00- 05.05	CA1546IR	14 90 ▲				
		11.00- 05.05	CA1664IR	14 120 ▲				
Passat 2.3 V5 4 Motion	[AZX]	11.00- 05.05	CA1546IR	14 90 ▲				
		11.00- 05.05	CA1664IR	14 120 ▲				
Passat 2.3 VR5	[AGZ]	09.97- 09.98	CA1139IR	14 90 ▲				
		09.98- 08.00	CA1546IR	14 90 ▲				
		09.98- 08.00	CA1664IR	14 120 ▲				
	[AZX]	11.00- 05.05	CA1546IR	14 90 ▲				
		11.00- 05.05	CA1664IR	14 120 ▲				
Passat 2.3 VR5 4 Motion	[AZX]	11.00- 05.05	CA1546IR	14 90 ▲				
11.00- 05.05	CA1664IR	14 120 ▲						
Passat 2.3 VR5 Syncro 4 Motion	[AGZ]	09.98- 08.00	CA1546IR	14 90 ▲				
		09.98- 08.00	CA1664IR	14 120 ▲				
Passat 2.5 TDi	[AFB]	07.98- 11.00	CA1588IR	14 120	07.98- 11.00	CS1114	12 2.0	
		11.00- 05.03	CA1546IR	14 90 ▲		07.98- 05.03	CS1114	12 2.0
	[AKN]	07.98- 05.03	CA1588IR	14 120				
		05.03- 05.03	CA1546IR	14 90 ▲	05.03-	CS1114	12 2.0	
		05.03- 05.03	CA1588IR	14 120				
05.03- 05.03	CA1746IR	14 140						
Passat 2.5 TDi 4 Motion	[AFB]	11.00- 05.05	CA1546IR	14 90	11.00- 01.03	CS1114	12 2.0	
		11.00- 05.05	CA1588IR	14 120				
	[AKN]	11.00- 01.03	CA1546IR	14 90 ▲	11.00- 01.03	CS1114	12 2.0	
		11.00- 01.03	CA1588IR	14 120				
	[BAU]	01.03- 01.03	CA1546IR	14 90 ▲	01.03-	CS1114	12 2.0	
		01.03- 01.03	CA1588IR	14 120				
		01.03- 01.03	CA1746IR	14 140				
	[BDH]	01.03- 01.03	CA1546IR	14 90 ▲	01.03-	CS1114	12 2.0	
01.03- 01.03		CA1588IR	14 120					
01.03- 01.03		CA1588IR	14 120					
01.03- 01.03		CA1746IR	14 140					
Passat 2.5 TDi Syncro 4 Motion	[AFB]	08.98- 11.00	CA1141IR	14 120	08.98- 11.00	CS1114	12 2.0	
		08.98- 11.00	CA1588IR	14 120				
	[AKN]	05.99- 11.00	CA1588IR	14 120	05.99- 11.00	CS1114	12 2.0	
Passat 2.8	[APR]	01.99- 11.00	CA1588IR	14 120	01.99- 11.00	CS1074	12 1.4	
		08.96- 11.00	CA837IR	14 90		01.97- 04.97	CS725	12 1.4
	[ACK]	01.97- 11.00	CA855IR	14 120	05.97- 11.00	CS1074	12 1.4	
		06.97- 11.00	CA1588IR	14 120				
		05.97- 09.98	CA837IR	14 90		05.97- 09.99	CS1074	12 1.4
	[AGE]	05.97- 09.98	CA855IR	14 120				
		09.97- 09.99	CA1139IR	14 90				
	[A855IR]	09.98- 09.99	CA1588IR	14 120				
		01.99- 11.00	CA1546IR	14 90	01.99- 11.00	CS1074	12 1.4	
	01.99- 11.00	CA1588IR	14 120					
	[ATX]	09.99- 11.00	CA1546IR	14 90	09.99- 11.00	CS1074	12 1.4	
		09.99- 11.00	CA1588IR	14 120				
	[BBG]	10.99- 11.00	CA1546IR	14 90	09.99- 11.00	CS1074	12 1.4	
		10.99- 11.00	CA1588IR	14 120				
Passat 2.8 4 Motion	[AMX]	11.00- 05.05	CA1588IR	14 120	11.00- 05.05	CS1074	12 1.4	
		11.00- 05.05	CA1813IR	14 150				
	[ATQ]	11.00- 05.05	CA1588IR	14 120	11.00- 05.05	CS1074	12 1.4	
		11.00- 05.05	CA1813IR	14 150				
		09.99- 11.00	CA1546IR	14 90		09.99- 11.00	CS1074	12 1.4
[ATX]	09.99- 11.00	CA1588IR	14 120					
	09.99- 11.00	CA1813IR	14 150					
Passat 2.8 Syncro		05.97- 08.00	CA1588IR	14 120	05.97- 08.00	CS1074	12 1.4	
		05.97- 08.00	CA837IR	14 90				
		05.97- 08.00	CA855IR	14 120				
Passat 2.8 Syncro 4 Motion	[APR]	01.99- 11.00	CA1588IR	14 120	01.99- 11.00	CS1074	12 1.4	
		01.99- 11.00	CA1813IR	14 150				
	[ACK]	01.97- 11.00	CA1813IR	14 150	01.97- 04.97	CS725	12 1.4	
		01.97- 09.98	CA837IR	14 90		01.97- 11.00	CS1074	12 1.4
		01.97- 09.98	CA855IR	14 120				
	[ALG]	09.98- 11.00	CA1588IR	14 120				
		05.97- 09.98	CA837IR	14 90	05.97- 11.00	CS1074	12 1.4	
	05.97- 09.98	CA855IR	14 120					
	06.97- 11.00	CA1813IR	14 150					
	09.98- 11.00	CA1546IR	14 90					
09.98- 11.00	CA1588IR	14 120						
[AQD]	01.99- 11.00	CA1588IR	14 120	01.99- 11.00	CS1074	12 1.4		
	01.99- 11.00	CA1813IR	14 150					
Passat 2.8 VR6	[AAA]	06.91- 07.92	CA827IR	14 70	AT 06.91- 03.97	CS713	12 1.8	
		06.91- 12.94	CA828IR	14 120		06.91- 03.97	CS620	12 1.7
		12.94- 03.97	CA1142IR	14 120				
Passat 2.9 VR6 Syncro	[ABV]	01.94- 11.94	CA828IR	14 120	01.94- 03.97	CS620	12 1.7	
11.94- 03.97	CA1260IR	14 120						
Passat 3.2 FSi 4 Motion	[AXZ]	11.05-	CA1782IR	14 140	AT 11.05-	CS1286	12 2.0	
		11.05-	CA1912IR	14 180				
Passat 3.6 4 Motion	[BWS]				AT 06.08-	CS1286	12 2.0	
Passat 3.6 R36 4motion	[BWS]				AT 04.07-	CS1286	12 2.0	
Passat 3.6 FSi 4motion	[BWS]				01.11-	CS1286	12 2.0	
Passat CC 1.4 TSi MultiFuel	[CKMA]				01.11-	CS1294	12 1.1	
Passat CC 2.0 TSi	[CCZB]	11.10-	CA1811IR	14 140	11.10-	CS1347	12 1.1	
Phaeton 3.0 TDi 4 Motion	[CARA]				06.07-	CS1411	12 2.2	
Phaeton 3.0 V6 TDi 4 Motion	[BMK]				09.04- 05.07	CS1411	12 2.2	



VW Continued

Polo 0.8	[HE]	01.76- 05.77	CA136IR	14 45	01.76- 05.77	CS79	12 0.8
		01.76- 05.77	CA85IR	14 55			
Polo 0.9	[HA]	04.75- 09.81	CA136IR	14 45	04.75- 09.81	CS79	12 0.8
		04.75- 09.81	CA139IR	14 65			
		04.75- 09.81	CA85IR	14 55			
Polo 1.0	[ACM]	02.92- 09.94	CA376IR	14 65	02.92- 09.94	CS293	12 0.8
		02.92- 09.94	CA588IR	14 55			
	[AER]	03.96- 12.99	CA733IR	14 70	09.96- 10.99	CS788	12 0.9
		03.96- 12.99	CA740IR	14 90			
		PS 03.96- 12.99	CA736IR	14 90			
		PS 03.96- 12.99	CA827IR	14 70			
	[AEV]	10.94- 12.99	CA733IR	14 70	10.94- 12.99	CS788	12 0.9
		10.94- 12.99	CA740IR	14 90			
		PS 10.94- 12.99	CA736IR	14 90			
		PS 10.94- 12.99	CA827IR	14 70			
	[ALD]	07.98- 09.01	CA1560IR	14 90	07.98- 09.01	CS788	12 0.9
		07.98- 09.01	CA1568IR	14 70			
		PS 07.98- 09.01	CA1504IR	14 70			
		AC 07.98- 09.01	CA1542IR	14 90			
	[ALL]	05.97- 12.99	CA733IR	14 70	05.97- 12.99	CS788	12 0.9
		05.97- 12.99	CA740IR	14 90			
		PS 05.97- 12.99	CA1240IR	14 90			
		PS 05.97- 12.99	CA736IR	14 90			
		PS 05.97- 12.99	CA827IR	14 70			
	[AUC]	10.99- 09.01	CA1560IR	14 90	10.99- 09.01	CS788	12 0.9
		10.99- 09.01	CA1568IR	14 70			
		PS 10.99- 09.01	CA1504IR	14 70			
		AC 10.99- 09.01	CA1542IR	14 90			
[GL]	10.81- 07.85	CA136IR	14 45	08.84- 10.86	CS293	12 0.8	
	10.81- 07.85	CA139IR	14 65	10.81- 07.84	CS79	12 0.8	
	08.83- 07.85	CA85IR	14 55				
	08.85- 10.86	CA347IR	14 55				
	08.85- 10.86	CA354IR	14 65				
[HZ]	08.85- 12.88	CA347IR	14 55	08.85- 08.90	CS293	12 0.8	
	08.85- 12.88	CA354IR	14 65				
	12.88- 08.90	CA376IR	14 65				
	12.88- 08.90	CA588IR	14 55				
[AAK]	08.89- 09.94	CA376IR	14 65	08.89- 09.94	CS293	12 0.8	
	08.89- 09.94	CA588IR	14 55				
[AAU]	10.90- 09.94	CA364IR	14 55	10.90- 09.94	CS293	12 0.8	
	10.90- 09.94	CA376IR	14 65				
	10.90- 09.94	CA588IR	14 55				
Polo 1.05	[AEV]	10.94- 12.99	CA733IR	14 70	10.94- 12.99	CS788	12 0.9
		10.94- 12.99	CA740IR	14 90			
		PS 10.94- 12.99	CA736IR	14 90			
		PS 10.94- 12.99	CA827IR	14 70			
Polo 1.1	[HB]	03.75- 07.83	CA136IR	14 45	03.75- 07.83	CS79	12 0.8
		03.75- 07.79	CA85IR	14 55			
		08.79- 07.83	CA139IR	14 65			
	[HC]	03.75- 07.77	CA136IR	14 45	03.75- 07.77	CS79	12 0.8
		03.75- 07.77	CA85IR	14 55			
Polo 1.2	[AWY]	Chas. 9N-3-070001- 01.02- 05.04	CA1675IR	14 90	01.02- 05.04	CS1282	12 0.9
		Chas. 9N-3-070001- 01.02- 05.04	CA1755IR	14 70	01.02- 05.04	CS1197	12 1.1
		Chas. -9N-3-070000 01.02- 05.04	CA1675IR	14 90			
		Chas. -9N-3-070000 01.02- 05.04	CA1755IR	14 70			
	[AZQ]	10.01- 05.04	CA1675IR	14 90	10.01- 05.04	CS1197	12 1.1
		10.01- 05.04	CA1755IR	14 70	10.01- 05.04	CS1282	12 0.9
	[BBM]	05.07- 05.07	CA1675IR	14 90	05.07- 05.07	CS1330	12 1.0
		05.07- 05.07	CA1755IR	14 70			
	[BMD]	05.04- 05.07	CA1675IR	14 90	05.04- 05.07	CS1282	12 0.9
		05.04- 05.07	CA1755IR	14 70			
	[BME]	08.02- 08.02	CA1675IR	14 90	08.02- 08.02	CS1330	12 1.0
		08.02- 08.02	CA1755IR	14 70			
	[BZG]	05.07- 05.07	CA1675IR	14 90	05.07- 05.07	CS1330	12 1.0
05.07- 05.07		CA1755IR	14 70				
[CGPA]	06.09- 06.09	CA1675IR	14 90	06.09- 06.09	CS1330	12 1.0	
[CGPB]	06.09- 06.09	CA1675IR	14 90	06.09- 06.09	CS1330	12 1.0	
Polo 1.2 TSi	[CBZB]	A25 06.09-	CA2011IR	14 140	06.09- 06.09	CS1470	12 1.1
					06.09- 06.09	CS1330	12 1.0
Polo 1.2 TDi	[CFWA]				A25 10.09-	CS1505*	12 2.0
Polo 1.3	[2G]	12.88- 09.94	CA376IR	14 65	12.88- 09.94	CS293	12 0.8
		12.88- 09.94	CA588IR	14 55			
	[3F]	10.89- 09.94	CA376IR	14 65	10.89- 09.94	CS293	12 0.8
		10.89- 09.94	CA588IR	14 55			
	[ADX]	10.94- 07.95	CA733IR	14 70	10.94- 07.95	CS788	12 0.9
		10.94- 07.95	CA740IR	14 90			
		PS 10.94- 07.95	CA736IR	14 90			
		PS 10.94- 07.95	CA827IR	14 70			
	[GK]	09.82- 07.85	CA136IR	14 45	09.82- 07.84	CS79	12 0.8
		09.82- 07.85	CA139IR	14 65	08.84- 08.90	CS293	12 0.8
		09.82- 07.85	CA85IR	14 55			
		08.85- 12.88	CA347IR	14 55			
		08.85- 12.88	CA354IR	14 65			
		12.88- 08.90	CA376IR	14 65			
		12.88- 08.90	CA588IR	14 55			
	[HH]	01.77- 07.83	CA136IR	14 45	01.77- 07.83	CS79	12 0.8
		01.77- 07.83	CA85IR	14 55			
		08.79- 07.83	CA139IR	14 65			
	[HJ]	10.81- 07.82	CA136IR	14 45	10.81- 07.82	CS79	12 0.8
		10.81- 07.82	CA139IR	14 65			
	[HK]	08.83- 07.85	CA136IR	14 45	08.83- 07.84	CS79	12 0.8
		08.83- 07.85	CA139IR	14 65	08.84- 07.85	CS293	12 0.8
		08.83- 07.85	CA85IR	14 55			
	[HW]	08.83- 07.85	CA136IR	14 45	08.84- 07.85	CS293	12 0.8
08.83- 07.85		CA139IR	14 65	08.83- 07.84	CS79	12 0.8	
08.83- 07.85		CA85IR	14 55				
[MH]	08.85- 12.88	CA347IR	14 55	08.85- 12.88	CS293	12 0.8	
	08.85- 12.88	CA354IR	14 65				
[NZ]	08.86- 08.90	CA347IR	14 55	08.86- 12.92	CS293	12 0.8	
	08.86- 08.90	CA354IR	14 65				
	12.88- 12.92	CA376IR	14 65				
	12.88- 12.92	CA588IR	14 55				
[AAV]	01.91- 09.94	CA376IR	14 65	01.91- 09.94	CS293	12 0.8	
	01.91- 09.94	CA588IR	14 55				



Polo 1.3 G40	[PY]	01.87- 09.94	CA354IR	14 65	01.87- 09.94	CS293	12 0.8
		12.88- 08.90	CA376IR	14 65			
Polo 1.3 Diesel	[MN]	08.86- 08.90	CA302IR	14 65	08.86- 08.90	CS500	12 1.4
		08.86- 08.90	CA364IR	14 55			
		08.86- 08.90	CA376IR	14 65			
		08.86- 08.90	CA588IR	14 55			
Polo 1.4	[AEX]	07.95- 12.99	CA733IR	14 70	AT 07.95- 12.99	CS1063	12 1.1
		07.95- 12.99	CA740IR	14 90	08.95- 10.99	CS880	12 1.1
		08.95- 10.99	CA732IR	14 60	07.95- 12.99	CS788	12 0.9
		07.96- 12.97	CA1240IR	14 90			
		PS 07.95- 12.99	CA736IR	14 90			
		PS 07.95- 12.99	CA827IR	14 70			
		AC 05.98- 12.99	CA736IR	14 90			
	[AKK]	05.97- 09.01	CA1504IR	14 70	10.99- 09.01	CS788	12 0.9
		05.97- 09.01	CA1560IR	14 90	10.99- 09.01	CS880	12 1.1
		05.97- 09.01	CA1568IR	14 70			
		10.99- 09.01	CA1240IR	14 90			
		10.99- 09.01	CA1542IR	14 90			
	ACPS 10.99- 09.01	CA1542IR	14 90				
		A20 05.97- 09.01	CA736IR	14 90			
	[AKP]	12.98- 09.01	CA1560IR	14 90	AT 12.98- 09.01	CS1063	12 1.1
		12.98- 09.01	CA1568IR	14 70	12.98- 09.01	CS788	12 0.9
		PS 12.98- 09.01	CA1504IR	14 70	12.98- 09.01	CS880	12 1.1
		AC 12.98- 09.01	CA1542IR	14 90			
	[AKV]	05.97- 12.99	CA733IR	14 70	05.97- 08.99	CS880	12 1.1
		05.97- 12.99	CA740IR	14 90	AT 05.95- 12.99	CS1063	12 1.1
		12.97- 08.99	CA1240IR	14 90	05.95- 12.99	CS788	12 0.9
		PS 05.97- 12.99	CA736IR	14 90			
PS 05.97- 12.99		CA827IR	14 70				
[ANW]	10.99- 08.00	CA1240IR	14 90	10.99- 08.00	CS880	12 1.1	
	10.99- 08.00	CA1542IR	14 90	10.99- 08.00	CS788	12 0.9	
	A20 10.99- 08.00	CA736IR	14 90				
[APQ]	11.97- 12.99	CA733IR	14 70	11.97- 12.99	CS788	12 0.9	
	11.97- 12.99	CA740IR	14 90	AT 11.97- 12.99	CS1063	12 1.1	
	12.97- 08.99	CA1240IR	14 90	11.97- 12.99	CS880	12 1.1	
	PS 11.97- 12.99	CA736IR	14 90				
PS 11.97- 12.99	CA827IR	14 70					
[AUB]	10.01- 04.02	CA1560IR	14 90	10.01- 04.02	CS1197	12 1.1	
	10.01- 04.02	CA1568IR	14 70	10.01- 04.02	CS1282	12 0.9	
	AC 10.01- 04.02	CA1542IR	14 90				
[AUD]	06.00- 09.01	CA1504IR	14 70	10.99- 09.01	CS788	12 0.9	
	10.99- 09.01	CA1560IR	14 90	AT 10.99- 09.01	CS1063	12 1.1	
	10.99- 09.01	CA1568IR	14 70	06.00- 09.01	CS880	12 1.1	
	PS 10.99- 09.01	CA1504IR	14 70				
	ACPS 10.99- 09.01	CA1542IR	14 90				
A20 10.99- 09.01	CA736IR	14 90					
[BBY]	07.03-	CA1542IR	14 90	07.03-	CS1282	12 0.9	
	07.03-	CA1568IR	14 70	07.03- 08.04	CS1063	12 1.1	
	07.03-	CA1729IR	14 110				
[BBZ]	11.03-	CA1542IR	14 90	11.03-	CS1282	12 0.9	
	11.03-	CA1568IR	14 70				
[BKY]	07.03-	CA1542IR	14 90	07.03- 08.04	CS1063	12 1.1	
	07.03-	CA1568IR	14 70	07.03-	CS1282	12 0.9	
	07.03-	CA1729IR	14 110				
[CGGB]	06.09-	CA1560IR	14 90	A24 06.09-	CS1470	12 1.1	
	06.09-	CA1815IR#	14 110	06.09-	CS1330	12 1.0	
	AC 06.09-	CA1542IR	14 90				
	AC 06.09-	CA1729IR	14 110				
[AAK]	09.98- 09.01	CA1560IR	14 90	09.98- 09.01	CS788	12 0.9	
	09.98- 09.01	CA1568IR	14 70	AT 09.98- 09.01	CS1063	12 1.1	
	ACPS 09.98- 09.01	CA1542IR	14 90				
Polo 1.4 Classic	[ANX]	01.98- 08.99	CA740IR	14 90	01.98- 08.99	CS788	12 0.9
		PS 01.98- 08.99	CA827IR	14 70	01.98- 08.99	CS880	12 1.1
Polo 1.4 16V	[AFH]	04.96- 10.99	CA736IR	14 90	04.96- 10.99	CS880	12 1.1
		04.96- 10.99	CA827IR	14 70			
	[AFK]	09.98- 09.01	CA1504IR	14 70	09.98- 09.01	CS880	12 1.1
		09.98- 09.01	CA1542IR	14 90			
	[AHW]	01.99- 09.01	CA1504IR	14 70	AT 01.99- 09.01	CS1063	12 1.1
		01.99- 09.01	CA1542IR	14 90	01.99- 09.01	CS880	12 1.1
	[APE]	01.99- 09.01	CA1504IR	14 70	AT 01.99- 09.01	CS1063	12 1.1
		01.99- 09.01	CA1542IR	14 90	01.99- 09.01	CS880	12 1.1
	[AQQ]	09.98- 09.01	CA1504IR	14 70	09.98- 09.01	CS880	12 1.1
		09.98- 09.01	CA1542IR	14 90			
	[AUA]	06.00- 09.01	CA1240IR	14 90	06.00- 09.01	CS1197	12 1.1
		06.00- 09.01	CA1560IR	14 90	10.01-	CS1282	12 0.9
		10.99- 09.01	CA1504IR	14 70	AT 10.99- 09.01	CS1063	12 1.1
		10.99- 09.01	CA1542IR	14 90	10.99- 09.01	CS880	12 1.1
		10.99- 09.01	CA1568IR	14 70			
	AC 10.99- 09.01	CA1729IR	14 110				
	[AUB]	10.99- 09.01	CA1504IR	14 70	10.99- 09.01	CS880	12 1.1
		10.99- 09.01	CA1542IR	14 90			
		10.99- 09.01	CA1568IR	14 70			
		AC 10.99- 09.01	CA1729IR	14 110			
	[BBY]	10.01-	CA1560IR	14 90	10.01-	CS1282	12 0.9
		10.01-	CA1568IR	14 70	10.01-	CS1197	12 1.1
		AC 10.01-	CA1542IR	14 90	AT 10.01-	CS1063	12 1.1
		AC 10.01-	CA1729IR	14 110			
[BBZ]	10.01-	CA1560IR	14 90	10.01-	CS1197	12 1.1	
	10.01-	CA1568IR	14 70				
	AC 10.01-	CA1542IR	14 90				
[BKY]	10.01-	CA1560IR	14 90	10.01-	CS1282	12 0.9	
	10.01-	CA1568IR	14 70	AT 10.01- 04.05	CS1063	12 1.1	
	AC 10.01-	CA1542IR	14 90	10.01-	CS1197	12 1.1	
	AC 10.01-	CA1729IR	14 110	10.01-	CS1330	12 1.0	
[BUD]	05.06-	CA1560IR	14 90	05.06-	CS1330	12 1.0	
	05.06-	CA1568IR	14 70				
	AC 05.06-	CA1542IR	14 90				
Polo 1.4 FSi	[AXU]	02.02- 07.06	CA1817IR	14 110	02.02- 07.06	CS1282	12 0.9
Polo 1.4 GTi	[CAVE]	05.10-	CA1921IR	14 110			
		05.10-	CA1985IR	14 140			
Polo 1.4 Diesel	[1W]	10.90- 09.94	CA302IR	14 65	01.91- 09.94	CS293	12 0.8
		10.90- 09.94	CA364IR	14 55	10.90- 09.94	CS500	12 1.4



VW Continued

Polo 1.4 Flexfuel	[CMAA]	03.10- 01.11	CA1560IR	14 90	03.10- 01.11	CS1330	12 1.0
		03.10- 01.11	CA1815IR#	14 110			
		AC 03.10- 01.11	CA1542IR	14 90			
		AC 03.10- 01.11	CA1729IR	14 110			
Polo 1.4 TDi	[AMF]	10.99-	CA1441IR	14 90	10.99-	CS974	12 1.8
		10.99-	CA1644IR	14 120			
		10.99-	CA1682IR	14 70			
	[BAY]	10.01- 03.05	CA1441IR	14 90	11.04- 03.05	CS1293	12 2.0
		10.01- 03.05	CA1644IR	14 120			
		10.01- 03.05	CA1682IR	14 70			
		07.03- 03.05	CA1841IR	14 140			
	[BMS]	04.05-	CA1644IR	14 120	04.05-	CS1293	12 2.0
		04.05-	CA2064IR*	14 90			
		04.05-	CA2065IR	14 110			
	[BNM]	04.05-	CA1682IR	14 70	04.05-	CS1393	12 1.7
		04.05-	CA2064IR*	14 90			
		Chas. -9N- 6D020576, -9N- 6U000101, -9N- 6Y049692	04.05-	CA1441IR			
	[BNV]	04.05-	CA1682IR	14 70	04.05-	CS1293	12 2.0
		04.05-	CA2064IR*	14 90			
		04.05-	CA2065IR	14 110			
		AC 04.05-	CA1441IR	14 90			
		AC 04.05-	CA1644IR	14 120			
	[BWB]	04.05-	CA1682IR	14 70	04.05-	CS1393	12 1.7
		04.05-	CA2064IR*	14 90			
Chas. -9N- 6D020576, -9N- 6U000101, -9N- 6Y049692		04.05-	CA1441IR	14 90			
Polo 1.6	[1F]	11.95- 09.97	CA1240IR	14 90	11.95- 09.97	CS1062	12 1.1
		11.95- 09.97	CA733IR	14 70			
		11.95- 09.97	CA740IR	14 90			
		AC 11.95- 09.97	CA736IR	14 90			
	[AEA]	09.94- 12.95	CA736IR	14 90	09.94- 12.95	CS880	12 1.1
		09.94- 12.95	CA827IR	14 70			
	[AEE]	07.95- 12.99	CA736IR	14 90	07.95- 12.99	CS880	12 1.1
		07.95- 12.99	CA827IR	14 70			
	[AEH]	AC 09.97- 12.98	CA736IR	14 90	AT 07.95- 12.99	CS1063	12 1.1
		10.99- 09.01	CA1240IR	14 90			
	[AFT]	10.99- 09.01	CA1378IR	14 90	10.99- 09.01	CS618	12 1.1
		10.99- 09.01	CA1436IR	14 70			
	[AHS]	A20 10.99- 09.01	CA736IR	14 90	12.95- 08.99	CS618	12 1.1
		12.95- 08.99	CA733IR	14 70			
	[AKL]	12.95- 08.99	CA740IR	14 90	03.96- 12.99	CS1063	12 1.1
		05.97- 08.99	CA1240IR	14 90			
	[ALM]	AC 12.95- 08.99	CA736IR	14 90	03.96- 12.99	CS880	12 1.1
		03.96- 12.99	CA827IR	14 70			
	[APF]	10.99- 09.01	CA1240IR	14 90	10.99- 09.01	CS1062	12 1.1
		10.99- 09.01	CA1378IR	14 90			
	[AUR]	10.99- 09.01	CA1436IR	14 70	10.99- 09.01	CS618	12 1.1
		A20 10.99- 09.01	CA736IR	14 90			
	[CFNB]	11.95- 09.01	CA1542IR	14 90	11.95- 09.01	CS788	12 0.9
		07.98- 09.01	CA1240IR	14 90			
	[ALM]	AC 11.95- 09.01	CA736IR	14 90	11.95- 09.01	CS880	12 1.1
		03.00- 10.00	CA1240IR	14 90			
	[APF]	03.00- 10.00	CA1378IR	14 90	03.00- 10.00	CS1062	12 1.1
		03.00- 10.00	CA1436IR	14 70			
	[AUR]	A20 03.00- 10.00	CA736IR	14 90	03.00- 10.00	CS618	12 1.1
		07.00- 09.01	CA1240IR	14 90			
	[AUR]	12.95- 09.01	CA1378IR	14 90	12.95- 09.01	CS1062	12 1.1
		12.95- 09.01	CA1436IR	14 70			
[AUR]	AC 07.00- 09.01	CA1378IR	14 90	07.00- 09.01	CS618	12 1.1	
	A20 12.95- 09.01	CA736IR	14 90				
[BTS]	05.06-	CA1817IR	14 110	AT 11.10- 11.10-	CS1347	12 1.1	
	05.06-	CA1817IR	14 110				
Polo 1.6 16V	[BTS]	05.06-	CA1817IR	14 110	AT, 6SP 05.06- 05.06-	CS1330	12 1.0
		05.06-	CA1817IR	14 110			
Polo 1.6 GTi 16V	[AJV]	04.98- 12.99	CA1240IR	14 90	AT 04.98- 12.99	CS1063	12 1.1
		04.98- 12.99	CA736IR	14 90			
		04.98- 12.99	CA827IR	14 70			
	[ARC]	10.99- 09.01	CA1504IR	14 70	10.99- 09.01	CS880	12 1.1
[AVY]	10.99- 09.01	CA1542IR	14 90	05.00- 09.01	CS880	12 1.1	
	05.00- 09.01	CA1504IR	14 70				
Polo 1.6 BiFuel	[CNKA]	05.00- 09.01	CA1542IR	14 90	01.11-	CS1330	12 1.0
		01.11-	CA1817IR	14 110			
Polo 1.6 TDi	[CAYA]	06.09-	CA1782IR	14 140	A25 06.09-	CS1505*	12 2.0
		06.09-	CA1810IR	14 110			
	[CAYB]	06.09-	CA1782IR	14 140	A25 06.09-	CS1505*	12 2.0
		06.09-	CA1810IR	14 110			
	[CAYC]	A25 06.09-	CA2011IR	14 140	AT 06.09-	CS1480*	12 1.8
		06.09-	CA1782IR	14 140			
[CAYC]	06.09-	CA1810IR	14 110	A25 06.09-	CS1505*	12 2.0	
	A25 06.09-	CA2011IR	14 140				
Polo 1.6 Total Flex	[BPA]	10.04-	CA1394IR	14 120			
		10.04-	CA1542IR	14 90			
		10.04-	CA1568IR	14 70			
Polo 1.7 SDi	[AHG]	04.97- 12.99	CA1239IR	14 90	04.97- 09.01	CS988	12 1.8
		04.97- 12.99	CA1255IR	14 70			
		10.99- 09.01	CA1547IR	14 70			
		10.99- 09.01	CA1548IR	14 90			
		A21 04.97- 12.99	CA1401IR	14 90			
	[AKU]	05.97- 12.99	CA1239IR	14 90	05.97- 09.01	CS988	12 1.8
		05.97- 12.99	CA1255IR	14 70			
		10.99- 09.01	CA1547IR	14 70			
		10.99- 09.01	CA1548IR	14 90			
		A21 05.97- 12.99	CA1401IR	14 90			
[AKW]	A17 05.97- 12.99	CA1401IR	14 90	11.97- 08.99	CS789	12 1.8	
	11.97- 08.99	CA1260IR	14 120				
		11.97- 08.99	CA1297IR	14 90			



Polo 1.8	[ADD]	03.98-09.01	CA1240IR	14 90	03.98-09.01	CS1062	12 1.1			
		03.98-09.01	CA733IR	14 70						
		03.98-09.01	CA740IR	14 90						
		AC 03.98-09.01	CA736IR	14 90						
Polo 1.8	[ADZ]	01.97-09.01	CA733IR	14 70	01.97-09.01	CS618	12 1.1			
		01.97-09.01	CA740IR	14 90						
		AC 01.97-09.01	CA736IR	14 90						
Polo 1.8 GTI	[BJX]	09.05-09.05	CA1297IR	14 90	09.05-	CS1294	12 1.1			
		09.05-09.05	CA1378IR	14 90						
		09.05-09.05	CA1436IR	14 70						
Polo 1.9 Diesel	[1Y]	01.96-10.96	CA732IR	14 60	01.96-10.96	CS789	12 1.8			
		01.96-10.96	CA733IR	14 70						
		10.94-09.95	CA736IR	14 90				10.94-09.01	CS988	12 1.8
		10.94-01.96	CA827IR	14 70 ▲						
		09.95-01.96	CA1226IR	14 90						
		01.96-07.01	CA1239IR	14 90						
	01.96-07.01	CA1255IR	14 70							
	10.99-09.01	CA1587IR	14 90 ▲							
	Polo 1.9 Diesel	[AGD]	07.96-12.99	CA1239IR	14 90	07.96-12.99	CS988	12 1.8		
			07.96-12.99	CA1255IR	14 70					
			A21 07.96-12.99	CA1401IR	14 90					
Polo 1.9 SDi	[1Y]	12.95-08.99	CA736IR	14 90	12.95-08.99	CS789	12 1.8			
		12.95-08.99	CA827IR	14 70						
		AC 12.95-08.99	CA736IR	14 90						
	Polo 1.9 SDi	[AEY]	12.95-08.99	CA1089IR	14 120	12.95-08.99	CS789	12 1.8		
			12.95-08.99	CA1260IR	14 120					
			12.95-08.99	CA827IR	14 70					
			Chas. -6K-X-507839	CA1297IR	14 90					
			Chas. 6K-X-507830-	CA1510IR	14 70					
			AC 12.95-08.99	CA736IR	14 90					
	Polo 1.9 SDi	[AGD]	07.96-12.99	CA1239IR	14 90	07.96-09.01	CS988	12 1.8		
			07.96-12.99	CA1255IR	14 70					
			PS 10.99-09.01	CA1587IR	14 90 ▲					
			A21 07.96-12.99	CA1401IR	14 90					
	Polo 1.9 SDi	[AGP]	08.99-09.01	CA1240IR	14 90	08.99-09.01	CS789	12 1.8		
			08.99-09.01	CA1394IR	14 120					
			08.99-09.01	CA1446IR	14 90					
			08.99-09.01	CA1502IR	14 70					
Polo 1.9 SDi	[AQM]	08.99-09.01	CA1240IR	14 90	08.99-09.01	CS789	12 1.8			
		08.99-09.01	CA1394IR	14 120						
		08.99-09.01	CA1446IR	14 90						
		08.99-09.01	CA1502IR	14 70						
Polo 1.9 SDi	[ASX]	10.99-09.01	CA1547IR	14 70	10.99-09.01	CS988	12 1.8			
		10.99-09.01	CA1548IR	14 90						
Polo 1.9 SDi	[ASY]	10.01-10.01	CA1394IR	14 120	10.01-04.05	CS1200	12 2.0			
		10.01-10.01	CA1446IR	14 90						
		10.01-10.01	CA1502IR	14 70						
		09.02-09.02	CA1147IR	14 120						
		09.02-09.02	CA1378IR	14 90						
Polo 1.9 TDi	[AFN]	06.98-08.99	CA1089IR	14 120	06.98-08.99	CS974	12 1.8			
		06.98-08.99	CA1297IR	14 90						
		Chas. -6K-X-507839	CA1260IR	14 120						
		Chas. 6K-X-507830-	CA1510IR	14 70						
	Polo 1.9 TDi	[AGR]	10.99-09.01	CA1240IR	14 90	10.99-09.01	CS974	12 1.8		
			10.99-09.01	CA1394IR	14 120					
			10.99-09.01	CA1446IR	14 90					
			10.99-09.01	CA1502IR	14 70					
	Polo 1.9 TDi	[AHU]	07.96-08.99	CA1089IR	14 120	07.96-08.99	CS974	12 1.8		
			07.96-08.99	CA1240IR	14 90					
			07.96-08.99	CA1260IR	14 120					
			07.96-08.99	CA1297IR	14 90					
			07.96-08.99	CA1510IR	14 70					
			Chas. -6K-X-507839	CA1297IR	14 90					
	Chas. 6K-X-507830-	CA1510IR	14 70							
	Polo 1.9 TDi	[ALE]	09.96-08.99	CA1240IR	14 90	11.97-08.99	CS974	12 1.8		
			09.96-08.99	CA1260IR	14 120					
			11.97-08.99	CA1089IR	14 120					
			11.97-08.99	CA1297IR	14 90					
			05.98-08.99	CA1510IR	14 70					
Chas. -6K-X-507839			CA1297IR	14 90						
Chas. 6K-X-507830-	CA1510IR	14 70								
Polo 1.9 TDi	[ALH]	10.99-09.01	CA1240IR	14 90	10.99-09.01	CS974	12 1.8			
		10.99-09.01	CA1394IR	14 120						
		10.99-09.01	CA1446IR	14 90						
		10.99-09.01	CA1502IR	14 70						
Polo 1.9 TDi	[ASV]	10.99-09.01	CA1394IR	14 120	10.99-09.01	CS974	12 1.8			
		10.99-09.01	CA1446IR	14 90						
		10.99-09.01	CA1502IR	14 70						
Polo 1.9 TDi	[ASZ]	11.03-11.03	CA1394IR	14 120	11.03-	CS1181	12 2.0			
		11.03-11.03	CA1446IR	14 90						
		11.03-11.03	CA1502IR	14 70						
Polo 1.9 TDi	[ATD]	10.01-10.01	CA1394IR	14 120	10.01-04.05	CS974	12 1.8			
		10.01-10.01	CA1446IR	14 90						
		10.01-10.01	CA1502IR	14 70						
Polo 1.9 TDi	[AXR]	10.01-10.01	CA1394IR	14 120	10.01-04.05	CS974	12 1.8			
		10.01-10.01	CA1446IR	14 90						
		10.01-10.01	CA1502IR	14 70						
Polo 1.9 TDi	[BLT]	11.03-05.04	CA1446IR	14 90	11.03-	CS1181	12 2.0			
		05.04-05.04	CA1394IR	14 120						
		05.04-05.04	CA1502IR	14 70						
Polo 1.9 TDi	[BMT]	05.06-05.06	CA1394IR	14 120	05.06-05.06	CS1293	12 2.0			
		05.06-05.06	CA1446IR	14 90						
		05.06-05.06	CA1502IR	14 70						
		05.06-05.06	CA2064IR*	14 90						
Polo 2.0	[ADC]	08.99-08.99	CA733IR	14 70	AT 08.99-	CS618	12 1.1			
		08.99-08.99	CA740IR	14 90						
		AC 08.99-08.99	CA1240IR	14 90						
Santana 1.3	[FZ]	08.80-07.83	CA136IR	14 45	08.80-07.83	CS79	12 0.8			
		08.80-07.83	CA139IR	14 65						
		08.80-07.83	CA85IR	14 55						
Santana 1.6	[DT]	08.83-12.84	CA241IR	14 55	08.83-12.84	CS297	12 0.95			
		08.83-12.84	CA242IR	14 65						
		08.83-12.84	CA296IR	14 55						



VW Continued

		08.83- 12.84	CA298IR	14 65			
		08.83- 12.84	CA320IR	14 90			
		AC 08.83- 12.84	CA238IR	14 55			
	[VV]	08.81- 07.83	CA140IR	14 45			
		08.81- 07.83	CA141IR	14 65			
		08.81- 07.83	CA163IR	14 75			
	[YP]	08.81- 12.82	CA140IR	14 45			
		08.81- 12.82	CA141IR	14 65			
		08.81- 12.82	CA163IR	14 75			
Santana 1.6 Diesel	[CR]	08.81- 07.82	CA237IR	14 65	08.81- 07.82	CS606	12 1.7
		08.81- 07.82	CA367IR	14 45	08.81- 07.82	CS185	12 1.5
	[JK]	08.82- 12.84	CA237IR	14 65	08.82- 12.84	CS185	12 1.5
		08.82- 12.84	CA367IR	14 45	08.82- 12.84	CS606	12 1.7
Santana 1.6 TD	[CY]	04.82- 12.84	CA237IR	14 65	04.82- 12.84	CS606	12 1.7
		04.82- 12.84	CA367IR	14 45	04.82- 12.84	CS185	12 1.5
Santana 1.8	[DS]	01.83- 12.84	CA141IR	14 65	01.83- 12.84	CS297	12 0.95
		01.83- 12.84	CA163IR	14 75			
		01.83- 12.84	CA241IR	14 55			
		01.83- 12.84	CA242IR	14 65			
		01.83- 12.84	CA320IR	14 90			
		01.95-	CA320IR	14 90	01.95-	CS297	12 0.95
Santana 1.8 i	[AFE]	01.95-	CA320IR	14 90	01.95-	CS297	12 0.95
Santana 1.9	[WN]	08.81- 07.83	CA140IR	14 45	08.81- 07.83	CS282	12 1.1
		08.81- 07.83	CA141IR	14 65			
		08.81- 07.83	CA163IR	14 75			
		AC 08.81- 07.83	CA163IR	14 75			
Santana 2.0	[HP]	08.83- 12.84	CA242IR	14 65	08.83- 12.84	CS282	12 1.1
	[JS]				08.83- 12.84	CS282	12 1.1
Santana 2.1	[WE]	08.82- 12.83	CA140IR	14 45	08.82- 12.83	CS282	12 1.1
		08.82- 12.83	CA141IR	14 65			
Scirocco 1.1	[FA]	04.74- 07.79	CA85IR	14 55	04.74- 07.79	CS79	12 0.8
Scirocco 1.3	[GF]	08.79- 12.83	CA136IR	14 45	08.79- 12.83	CS79	12 0.8
		08.79- 12.83	CA139IR	14 65			
Scirocco 1.4 TSi	[CAVD]	09.08-	CA1985IR	14 140	DSG 09.08- 05.10	CS1470	12 1.1
					09.08-	CS1294	12 1.1
	[CAXA]				09.08-	CS1294	12 1.1
Scirocco 1.5	[FH]	02.74- 12.75	CA35IR	14 35			
		02.74- 12.75	CA52IR	14 55			
	[JB]	08.77- 01.80	CA35IR	14 35	AT 08.77- 12.83	CS276	12 0.7
		08.77- 01.80	CA52IR	14 55	08.77- 12.83	CS116	12 0.8
		02.80- 12.83	CA140IR	14 45			
		02.80- 12.83	CA141IR	14 65			
	[YJ]	02.74- 08.75	CA35IR	14 35			
		02.74- 08.75	CA52IR	14 55			
	[ZB]	02.74- 12.76	CA35IR	14 35			
		02.74- 12.76	CA52IR	14 55			
	[ZC]	02.74- 12.77	CA35IR	14 35			
		02.74- 12.77	CA52IR	14 55			
Scirocco 1.6	[FR]	08.75- 01.80	CA35IR	14 35	08.75- 12.83	CS116	12 0.8
		08.75- 01.80	CA52IR	14 55	AT 08.79- 12.83	CS276	12 0.7
		02.80- 07.83	CA140IR	14 45			
		02.80- 05.83	CA141IR	14 65			
		06.83- 12.83	CA241IR	14 55			
		06.83- 12.83	CA242IR	14 65			
	[EG]	06.76- 08.78	CA35IR	14 35	06.76- 07.82	CS116	12 0.8
		06.76- 01.80	CA52IR	14 55			
		09.78- 07.82	CA141IR	14 65			
		02.80- 07.82	CA140IR	14 45			
		08.80- 03.81	CA163IR	14 75			
		AC 03.81- 07.82	CA163IR	14 75			
	[EW]	01.83- 05.83	CA140IR	14 45	01.83- 07.84	CS116	12 0.8
		01.83- 05.83	CA141IR	14 65	AT 01.83- 07.92	CS276	12 0.7
		06.83- 07.84	CA241IR	14 55	08.84- 07.92	CS294	12 0.9
		06.83- 07.85	CA242IR	14 65			
		06.83- 07.92	CA320IR	14 90			
		08.84- 07.92	CA296IR	14 55			
		08.85- 07.92	CA298IR	14 65			
	[EWA]	01.83- 05.83	CA140IR	14 45	01.83- 07.84	CS116	12 0.8
		05.83- 07.87	CA141IR	14 65	AT 01.83- 07.87	CS276	12 0.7
		06.83- 07.84	CA241IR	14 55	08.84- 07.87	CS294	12 0.9
		06.83- 07.85	CA242IR	14 65			
		06.83- 07.87	CA320IR	14 90			
		08.84- 07.87	CA296IR	14 55			
		08.85- 07.87	CA298IR	14 65			
	[FN]	08.75- 07.77	CA35IR	14 35	08.75- 07.77	CS116	12 0.8
		08.75- 07.77	CA52IR	14 55	AT 08.75- 07.77	CS276	12 0.7
	[FP]	08.75- 07.77	CA35IR	14 35	AT 08.75- 07.77	CS276	12 0.7
		08.75- 07.77	CA52IR	14 55	08.75- 07.77	CS116	12 0.8
	[FT]	08.75- 07.77	CA35IR	14 35	08.75- 07.77	CS116	12 0.8
		08.75- 07.77	CA52IR	14 55	AT 08.75- 07.77	CS276	12 0.7
	[RE]	04.86- 07.90	CA296IR	14 55	04.86- 07.90	CS294	12 0.9
		04.86- 07.90	CA298IR	14 65			
Scirocco 1.8	[DX]	08.82- 05.83	CA140IR	14 45	08.83- 07.92	CS294	12 0.9
		08.82- 05.83	CA141IR	14 65			
		08.82- 12.82	CA163IR	14 75			
		01.83- 07.92	CA320IR	14 90			
		06.83- 07.84	CA241IR	14 55			
		06.83- 07.85	CA242IR	14 65			
		08.84- 07.92	CA296IR	14 55			
		08.85- 07.92	CA298IR	14 65			
	[EV]	08.82- 05.83	CA140IR	14 45	08.83- 07.92	CS294	12 0.9
		08.82- 05.83	CA141IR	14 65			
		08.82- 12.82	CA163IR	14 75			
		01.83- 07.92	CA320IR	14 90			
		06.83- 07.84	CA241IR	14 55			
		06.83- 07.85	CA242IR	14 65			
		08.84- 07.92	CA296IR	14 55			
		08.85- 07.92	CA298IR	14 65			
	[EX]	08.83- 07.84	CA241IR	14 55	08.83- 07.92	CS294	12 0.9
		08.83- 07.85	CA242IR	14 65	AT 08.83- 07.92	CS392	12 0.9
		08.83- 07.92	CA320IR	14 90			
		08.84- 07.92	CA296IR	14 55			
		08.85- 07.92	CA298IR	14 65			



	[JH]	05.83- 07.84 05.83- 07.85 05.83- 07.92 08.84- 07.92 08.85- 07.92	CA2411R CA2421R CA3201R CA2961R CA2981R	14 55 14 65 14 90 14 55 14 65		08.83- 07.92 AT 05.83- 07.92	CS294 CS276	12 0.9 12 0.7
	[JJ]	08.82- 05.83 08.82- 05.83 08.82- 12.82 01.83- 07.92 06.83- 07.84 06.83- 07.85 08.84- 07.92 08.85- 07.92	CA1401R CA1411R CA1631R CA3201R CA2411R CA2421R CA2961R CA2981R	14 45 14 65 14 75 14 90 14 55 14 65 14 55 14 65		08.83- 07.92	CS294	12 0.9
	[PB]	08.82- 05.83 08.82- 05.83 08.82- 12.82 01.83- 07.92 06.83- 07.84 06.83- 07.85 08.84- 07.92 08.85- 07.92	CA1401R CA1411R CA1631R CA3201R CA2411R CA2421R CA2961R CA2981R	14 45 14 65 14 75 14 90 14 55 14 65 14 55 14 65		08.83- 07.92	CS294	12 0.9
Scirocco 1.8 16V	[KR]	10.85- 07.89 10.85- 07.89 AC 10.85- 07.89	CA3421R CA3431R CA3431R	14 65 14 90 14 90		10.85- 07.89	CS294	12 0.9
	[PL]	03.86- 07.92 03.86- 07.92 AC 03.86- 07.92	CA3421R CA3431R CA3431R	14 65 14 90 14 90		03.86- 07.92	CS294	12 0.9
Scirocco 2.0 R	[CDLA]	11.09-	CA17821R	14 140		11.09- AT 11.09- 05.10	CS1347 CS1409	12 1.1 12 1.0
Scirocco 2.0 TSi	[CAWB]	09.08- 09.08-	CA17591R CA18111R	14 120 14 140		AT 09.08- 09.08-	CS1409 CS1347	12 1.0 12 1.1
	[CCZB]	11.09-	CA18111R	14 140		11.09- AT 11.09- 05.10	CS1347 CS1409	12 1.1 12 1.0
	[CDLC]	11.09-	CA17821R	14 140		DKG 11.09- 11.09-	CS1409 CS1347	12 1.0 12 1.1
Scirocco 2.0 TDi	[CBBB]	05.09-	CA17821R	14 140		AT 05.09- 05.09-	CS1286 CS1323	12 2.0 12 2.0
	[CBDB]	09.08-	CA17821R	14 140		09.08- AT 09.08-	CS1323 CS1286	12 2.0 12 2.0
	[CFHB]	11.10- 11.10-	CA17821R CA20111R	14 140 14 140		11.10- A25 11.10-	CS1323 CS1508*	12 2.0 12 1.7
Sharan 1.8 Turbo 20V	[AJH]	11.97- 09.98 11.97- 04.99 11.97- 02.00 11.97- 02.00 10.98- 02.00 05.99- 02.00	CA11441R CA15701R CA7361R CA8271R CA13941R CA14461R	14 120 14 90 14 90 14 70 14 120 14 90		AT 11.97- 05.98 05.98- 02.00 AT 05.98- 02.00 11.97- 05.98	CS618 CS1119 CS1062 CS619	12 1.1 12 1.1 12 1.1 12 1.1
	[AWC]	05.00- 05.00-	CA13941R CA17821R	14 120 14 140		05.00-	CS1337	12 1.1
Sharan 1.9 TDi	[1Z]	09.95- 07.96 09.95- 07.96	CA10891R CA7361R	14 120 14 90		09.95- 07.96	CS974	12 1.8
	[AFN]	09.96- 04.00 09.96- 11.96 12.96- 04.00	CA12601R CA7361R CA12971R	14 120 14 90 14 90		AT 09.96- 04.00 AT 09.96- 04.00 09.96- 04.00	CS789 CS1287 CS974	12 1.8 12 2.0 12 1.8
	[AHU]	07.96- 04.99 05.99- 02.00 05.99- 02.00	CA7361R CA13941R CA14461R	14 90 14 120 14 90		07.96- 02.00	CS974	12 1.8
	[ANU]	04.00- 04.00- 04.00-	CA13941R CA14461R CA17821R	14 120 14 90 14 140		04.00-	CS1181	12 2.0
	[ASZ]	11.02- 05.05 11.02- 05.05	CA13941R CA14461R	14 120 14 90		11.02- 05.05	CS1181	12 2.0
	[AUY]	04.00- 04.00-	CA13941R CA14461R	14 120 14 90		04.00- AT, 5SP 04.00-	CS1181 CS1390	12 2.0 12 2.3
	[AVG]	08.99- 04.00 08.99- 04.00	CA12601R CA12971R	14 120 14 90		AT 08.99- 04.00 08.99- 04.00 AT 08.99- 04.00	CS789 CS974 CS1287	12 1.8 12 1.8 12 2.0
	[BTB]	05.05- 05.05-	CA13941R CA17821R	14 120 14 140		05.05-	CS1181	12 2.0
	[BVK]	11.05- 11.05-	CA13941R CA17821R	14 120 14 140		11.05- AT, 5SP 11.05-	CS1181 CS1390	12 2.0 12 2.3
Sharan 1.9 TDi 4 Motion	[AUY]	04.00- 04.00-	CA13941R CA14461R	14 120 14 90		AT, 5SP 04.00- 04.00-	CS1390 CS1181	12 2.3 12 2.0
	[BVK]	04.00- 04.00- 04.00-	CA13941R CA14461R CA17821R	14 120 14 90 14 140		04.00- AT, 5SP 04.00-	CS1181 CS1390	12 2.0 12 2.3
Sharan 2.0	[ADY]	09.95- 02.00 09.95- 02.00 AC 09.95- 02.00	CA7401R CA8281R CA7361R	14 90 14 120 14 90		AT 05.98- 02.00 05.98- 02.00 AT 09.95- 05.98 09.95- 05.98	CS1062 CS1119 CS618 CS619	12 1.1 12 1.1 12 1.1 12 1.1
	[ATM]	05.00-	CA13941R	14 120		05.00- AT 05.00-	CS1337 CS1062	12 1.1 12 1.1
Sharan 2.0 TSi	[CCZA]	12.10-	CA18111R	14 140				
Sharan 2.0 LPG	[ATM]	05.08- 05.08-	CA13941R CA17821R	14 120 14 140		05.08- AT 05.08-	CS1337 CS1062	12 1.1 12 1.1
Sharan 2.0 TDi	[BRT]	11.05- 11.05-	CA13941R CA17821R	14 120 14 140		6SP 11.05-	CS1181	12 2.0
	[BVH]	11.05- 03.10 11.05- 03.10	CA13941R CA17821R	14 120 14 140		11.05- 03.10	CS1181	12 2.0
	[CFFA]	05.10-	CA20111R	14 140		05.10-	CS1508*	12 1.7
	[CFFB]	07.10-	CA20111R	14 140		07.10- 08.10-	CS1508* CS1508*	12 1.7 12 1.7
Sharan 2.0 TDi 4motion	[CFFA]	05.11-	CA20111R	14 140		05.11-	CS1508*	12 1.7
	[CFFB]	05.11-	CA20111R	14 140		05.11-	CS1508*	12 1.7
Sharan 2.8 V6 24V	[AYL]	04.00- 04.00-	CA13941R CA17631R	14 120 14 150		04.00-	CS1181	12 2.0
Sharan 2.8 V6 24V VR6 Syncro	[AYL]	04.00- 09.00-	CA13941R CA17631R	14 120 14 150		04.00-	CS1181	12 2.0
Sharan 2.8 VR6	[AMY]	09.95- 04.99 09.95- 04.00	CA11421R CA11431R	14 120 14 150		09.95- 04.00 AT 09.95- 04.00 09.95- 04.00	CS620 CS789 CS1287	12 1.7 12 1.8 12 2.0
	[AAA]	09.95- 04.99 09.95- 04.00	CA11421R CA11431R	14 120 14 150		AT 09.95- 04.00 09.95- 04.00 09.95- 04.00	CS789 CS620 CS1287	12 1.8 12 1.7 12 2.0



VW Continued

Sharan 2.8 VR6 Syncro	[AMY]	07.96- 02.00	CA11431R	14 150	07.96- 02.00	CS1287	12 2.0	
		07.96- 09.98	CA8281R	14 120	07.96- 02.00	CS620	12 1.7	
		11.96- 02.00	CA11421R	14 120	AT 07.96- 02.00	CS789	12 1.8	
	[AAA]	07.96- 02.00	CA11431R	14 150	07.96- 02.00	CS620	12 1.7	
		Chas. -7M-X-055000	07.96- 09.98	CA8281R	14 120	AT 07.96- 02.00	CS789	12 1.8
					07.96- 02.00	CS1287	12 2.0	
Spacefox 1.6 FSi	[BPA]	03.06-	CA15421R	14 90				
Taro 1.8	[2Y]	04.89- 09.94	JA144	14 45	04.89- 12.93	JS385	12 1.0	
Taro 2.2	[4Y]	04.89- 07.94	JA144	14 45	04.89- 12.93	JS385	12 1.0	
Taro 2.4	[22R]	06.89- 10.92	JA11231R	14 60	06.89- 12.93	JS669	12 1.4	
					06.89- 12.93	JS316	12 1.0	
Taro 2.4 Diesel	[2L]	04.89- 03.97	JA777	14 55	04.89- 03.97	JS642	12 2.0	
					04.89- 02.97	JS392	12 2.5	
Taro 2.4 Diesel 4x4	[2L]	04.89- 03.97	JA777	14 55	04.89- 02.97	JS392	12 2.5	
					04.89- 03.97	JS642	12 2.0	
Tiguan 1.4 TSi	[BWK]	09.07-	CA19851R	14 140	09.07-	CS1347	12 1.1	
	[CAVA]	11.08-	CA19851R	14 140	11.08-	CS1347	12 1.1	
Tiguan 2.0 TFSi	[CAWA]	09.07-	CA18111R	14 140	09.07-	CS1347	12 1.1	
	[CAWB]	09.07-	CA18111R	14 140	09.07-	CS1347	12 1.1	
	[CCZA]	11.09-	CA18111R	14 140	11.09-	CS1347	12 1.1	
Tiguan 2.0 TDi	[CBAB]	09.07-	CA17821R	14 140	09.07-	CS1323	12 2.0	
	[CBBB]	09.07-	CA17821R	14 140	09.07-	CS1323	12 2.0	
	[CBAA]	11.07-	CA17821R	14 140	11.07-	CS1323	12 2.0	
	[CFFD]	05.10-	CA17821R	14 140	A25 05.10-	CS1508*	12 1.7	
					05.10-	CS1323	12 2.0	
Tiguan 2.0 TDi 4motion	[CBBA]	02.08- 08.09	CA17821R	14 140	02.08- 08.09	CS1323	12 2.0	
Touareg 2.5 TDi	[BAC]	01.03-	CA18191R	14 150	01.03-	CS1378	12 2.2	
		01.03-	CA18201R	14 180				
	[BPE]	01.03-	CA18191R	14 150				
		01.03-	CA18201R	14 180				
Touareg 2.5 TDi R5	[BLK]	08.03- 11.06	CA18191R	14 150	08.03-	CS1378	12 2.2	
		08.03- 11.06	CA18201R	14 180				
Touareg 3.0 TDi	[BKS]	11.04-	CA19371R	14 180				
	[BUN]	12.06- 11.07	CA19371R	14 180				
	[CASB]	11.07-	CA19371R	14 180				
Touareg 3.0 V6 TDi	[CASA]	11.07-	CA19371R	14 180				
Touareg 3.2 V6	[AZZ]	10.02-	CA17491R	14 150	10.02-	CS1327	12 1.7	
	[BKJ]	05.03-	CA17491R	14 150	10.02-	CS1327	12 1.7	
	[BMV]	10.02-	CA17491R	14 150	10.02-	CS1327	12 1.7	
	[BMX]	11.04-	CA17491R	14 150	11.04-	CS1327	12 1.7	
	[BRJ]	10.02-	CA17491R	14 150	10.02-	CS1327	12 1.7	
Touareg 3.6 FSi V6	[BHK]	08.05-	CA17491R	14 150	08.05-	CS1327	12 1.7	
	[BHL]	10.05-	CA17491R	14 150	10.05-	CS1327	12 1.7	
Touran 1.2 TSi	[CBZB]				05.10-	CS1322	12 1.1	
Touran 1.4 FSi	[BLG]	12.06-	CA18171R	14 110	AT 12.06-	CS1409	12 1.0	
		12.06-	CA19851R	14 140	12.06-	CS1294	12 1.1	
		AT 12.06-	CA19211R	14 110				
	[CAVB]	11.08-	CA19211R	14 110	11.08-	CS1470	12 1.1	
Touran 1.4 TSi	[BMY]	02.06-	CA19851R	14 140	AT 02.06-	CS1409	12 1.0	
					02.06-	CS1294	12 1.1	
	[CAVC]	11.08-	CA19211R	14 110	A24 02.06-	CS1470	12 1.1	
					6SP 11.08-	CS1294	12 1.1	
Touran 1.4 TSi EcoFuel	[CDGA]				6SP 05.09-	CS1294	12 1.1	
					AT 05.09-	CS1470	12 1.1	
Touran 1.6	[BGU]	07.03-	CA17821R	14 140	07.03-	CS1322	12 1.1	
		07.03-	CA18181R	14 110	AT, 6SP 07.03-	CS1347	12 1.1	
	[BSE]	07.03-	CA17821R	14 140	07.03-	CS1322	12 1.1	
		07.03-	CA18181R	14 110	AT, 6SP 07.03-	CS1347	12 1.1	
	[BSF]	07.03-	CA17821R	14 140	AT, 6SP 07.03-	CS1347	12 1.1	
		07.03-	CA18181R	14 110	07.03-	CS1322	12 1.1	
Touran 1.6 FSi	[BAG]	02.03-	CA18171R	14 110	AT 02.03-	CS1347	12 1.1	
					02.03-	CS1322	12 1.1	
	[BLF]	02.03-	CA18171R	14 110	AT 02.03-	CS1347	12 1.1	
					02.03-	CS1322	12 1.1	
	[BLP]	05.04- 05.05	CA18171R	14 110	AT 05.04- 05.05	CS1347	12 1.1	
					05.04- 05.05	CS1322	12 1.1	
Touran 1.6 TDi	[CAYB]	05.10-	CA20111R	14 140	A25 05.10-	CS1505*	12 2.0	
	[CAYC]	05.10-	CA20111R	14 140	A25 05.10-	CS1505*	12 2.0	
Touran 1.9 TDi	[AVQ]	02.03-	CA17821R	14 140	02.03-	CS1293	12 2.0	
					AT 02.03-	CS1286	12 2.0	
	[BKC]	08.03- 02.06	CA17821R	14 140	AT 08.03- 02.06	CS1286	12 2.0	
		08.03- 02.06	CA18101R	14 110	6SP 08.03- 02.06	CS1293	12 2.0	
	[BLS]	08.03- 02.06	CA17821R	14 140	6SP 08.03- 02.06	CS1293	12 2.0	
		08.03- 02.06	CA18101R	14 110	DKG 11.06- 05.10	CS1480*	12 1.8	
					AT 08.03- 02.06	CS1286	12 2.0	
	[BRU]	06.05- 06.06	CA17821R	14 140	06.05- 06.06	CS1293	12 2.0	
		06.05- 06.06	CA18101R	14 110				
	[BXE]	08.03- 02.06	CA17821R	14 140	AT 08.03- 02.06	CS1286	12 2.0	
		08.03- 02.06	CA18101R	14 110	6SP 08.03- 02.06	CS1293	12 2.0	
	[BXJ]	06.06-	CA17821R	14 140	06.06-	CS1293	12 2.0	
		06.06-	CA18101R	14 110				
Touran 2.0 FSi	[AXW]	10.03-	CA17821R	14 140	10.03-	CS1294	12 1.1	
		10.03-	CA18181R	14 110	AT 10.03-	CS1347	12 1.1	
	[BJZ]	10.04-	CA13941R	14 120	10.04-	CS1294	12 1.1	
		10.04-	CA17821R	14 140				
	[BLR]	02.05-	CA17821R	14 140	02.05-	CS1294	12 1.1	
		02.05-	CA18181R	14 110	AT 02.05-	CS1347	12 1.1	
	[BLX]	10.03-	CA17821R	14 140	10.03-	CS1294	12 1.1	
		10.03-	CA18181R	14 110	AT 10.03-	CS1347	12 1.1	
	[BLY]	10.03- 11.05	CA17821R	14 140	10.03- 11.05	CS1294	12 1.1	
		10.03- 11.05	CA18181R	14 110				
Touran 2.0 TDi 16V	[BKD]	08.03-	CA17821R	14 140	AT 08.03-	CS1286	12 2.0	
		08.03-	CA18101R	14 110	08.03-	CS1323	12 2.0	
Touran 2.0 TDi	[AZV]	02.03-	CA17821R	14 140	02.03-	CS1323	12 2.0	
	[BMM]	12.05-	CA17821R	14 140	12.05-	CS1323	12 2.0	
		12.05-	CA18101R	14 110				
	[BMN]	12.05-	CA17821R	14 140	12.05-	CS1323	12 2.0	
		12.05-	CA18101R	14 110				
	[CLCA]	05.10-	CA20111R	14 140	05.10-	CS1508*	12 1.7	
					05.10-	CS1323	12 2.0	
Touran 2.0 EcoFuel	[BSX]	02.06-	CA17821R	14 140	02.06-	CS1322	12 1.1	
		02.06-	CA18181R	14 110				
Transporter 1.5 T1		10.65- 07.68	CG19	14 30	07.66- 07.67	CS62	12 0.7	
Transporter 1.6 T1	[B]	08.64- 12.68	CG19	14 30	08.64- 12.68	CS62	12 0.7	





Transporter 1.6 T2	[AD]	08.74- 04.79	CA931R	14 51	07.75- 04.79	CS115	12 0.7
					08.70- 07.75	CS62	12 0.7
	[AE]	08.70- 04.79	CA931R	14 51			
	[AF]	08.74- 04.79	CA931R	14 51	08.70- 07.75	CS62	12 0.7
					08.75- 04.79	CS115	12 0.7
Transporter 1.6 T3	[CT]	05.79- 12.82	CA2051R	14 45	08.70- 07.75	CS62	12 0.7
					08.75- 04.79	CS115	12 0.7
					07.75- 07.79	CS115	12 0.7
					08.68- 07.75	CS62	12 0.7
Transporter 1.6 Diesel T3	[CS]	01.81- 06.81	CA1361R	14 45	01.81- 01.85	CS299	12 1.7
		01.81- 12.85	CA1391R	14 65	01.85- 07.87	CS358	12 1.7
		01.81- 07.87	CA3181R	14 90			
		08.85- 07.87	CA6101R	14 90			
		12.85- 07.87	CA3191R	14 65			
Transporter 1.6 TD T3	[JX]	08.84- 07.85	CA3181R	14 90	08.84- 12.84	CS299	12 1.7
		08.85- 07.92	CA6101R	14 90	01.85- 07.92	CS358	12 1.7
		12.85- 07.92	CA3191R	14 65			
		A20 08.85- 07.92	CA3191R	14 65			
Transporter 1.6 TD T3 Syncro	[JX]	03.86- 07.92	CA3191R	14 65	03.86- 07.92	CS358	12 1.7
		03.86- 07.92	CA6101R	14 90			
		A20 03.86- 07.92	CA3181R	14 90			
		A20 03.86- 07.92	CA3191R	14 65			
Transporter 1.7 T2	[CA]				08.71- 10.73	CS62	12 0.7
	[CB]				08.71- 12.73	CS62	12 0.7
Transporter 1.7 Diesel T3	[KY]	10.86- 07.92	CA3191R	14 65	10.86- 07.92	CS358	12 1.7
		10.86- 07.92	CA6101R	14 90			
		A20 10.86- 07.92	CA3181R	14 90			
		A20 10.86- 07.92	CA3191R	14 65			
Transporter 1.8 T2	[AP]				11.73- 07.75	CS62	12 0.7
Transporter 1.8 T4	[PD]	12.90- 07.92	CA2981R	14 65	12.90- 07.92	CS597	12 1.1
		12.90- 07.92	CA3201R	14 90			
Transporter 1.9 T3	[DF]	08.82- 07.85	CA1401R	14 45	08.82- 11.86	CS298	12 0.8
		08.82- 07.85	CA1411R	14 65	09.82- 07.92	CS683	12 0.95
		08.82- 07.92	CA3201R	14 90			
		08.85- 07.92	CA2981R	14 65			
		08.85- 07.92	CA5371R	14 45			
		08.85- 07.92	CA9111R#	14 65			
	[DG]	08.82- 07.85	CA1401R	14 45	AT 08.82- 07.92	CS531	12 0.8
		08.82- 07.85	CA1411R	14 65	09.82- 07.92	CS683	12 0.95
		08.82- 07.92	CA3201R	14 90	08.82- 11.86	CS298	12 0.8
		08.85- 07.92	CA2981R	14 65			
Transporter 1.9 T3 Syncro	[DG]	11.84- 07.85	CA1401R	14 45	11.84- 11.86	CS298	12 0.8
		11.84- 07.85	CA1411R	14 65	12.86- 07.92	CS683	12 0.95
		11.84- 07.92	CA3201R	14 90			
		08.85- 07.92	CA5371R	14 45			
Transporter 1.9 Diesel T4	[1X]	08.85- 07.92	CA9111R#	14 65			
		09.90- 07.92	CA3021R	14 65	09.90- 12.95	CS598	12 1.8
		09.90- 07.92	CA8441R	14 100			
		08.92- 12.95	CA7321R	14 60			
		08.92- 12.95	CA7331R	14 70			
Transporter 1.9 TD T4	[ABL]	08.92- 12.95	CA7401R	14 90			
		10.92- 06.03	CA7321R	14 60	Chas. 70-S-059839- 01.95- 06.03	CS801	12 1.8
		10.92- 06.03	CA7331R	14 70	Chas. -70-S-059838 10.92- 12.94	CS598	12 1.8
		10.92- 06.03	CA7401R	14 90			
		10.92- 06.03	CA8281R	14 120			
		01.99- 06.03	CA17501R	14 90			
		AC 10.92- 06.03	CA7361R	14 90			
		AC 10.92- 06.03	CA8281R	14 120			
		A20 10.92- 06.03	CA7361R	14 90			
Transporter 1.9 TDi T5	[AXB]	04.03-	CA13941R	14 120	04.03-	CS1293	12 2.0
		04.03-	CA14461R	14 90			
		04.03-	CA17821R	14 140			
	[AXC]	04.03-	CA13941R	14 120	04.03-	CS1293	12 2.0
		04.03-	CA14461R	14 90			
		04.03-	CA17821R	14 140			
	[BRR]	01.06-	CA13941R	14 120	01.06-	CS1293	12 2.0
		01.06-	CA14461R	14 90			
Transporter 2.0 T2	[CJ]				AT 08.75- 07.79	CS117	12 0.7
					08.75- 07.79	CS115	12 0.7
	[GD]				AT 08.75- 07.77	CS117	12 0.7
					08.75- 07.77	CS115	12 0.7
Transporter 2.0 T3	[CU]	05.79- 12.82	CA2051R	14 45	AT 08.76- 06.79	CS117	12 0.7
					08.76- 06.79	CS115	12 0.7
					AT 05.79- 07.81	CS117	12 0.7
					AT 08.81- 07.82	CS531	12 0.8
Transporter 2.0 T4	[CV]	05.79- 12.82	CA2051R	14 45	05.79- 12.80	CS115	12 0.7
					01.81- 12.82	CS298	12 0.8
					05.79- 01.81	CS115	12 0.7
Transporter 2.0 T4	[AAC]	07.90- 06.03	CA2981R	14 65	02.82- 12.82	CS298	12 0.8
		07.90- 06.03	CA8281R	14 120	06.98- 06.03	CS1176	12 1.1
		05.91- 06.03	CA3201R	14 90	09.90- 04.03	CS597	12 1.1
		08.92- 06.03	CA7401R	14 90	AT 09.90- 06.03	CS294	12 0.9
		08.98- 06.03	CA15421R	14 90			
		01.99- 06.03	CA17501R	14 90			
		AC 07.90- 06.03	CA7361R	14 90			
		AC 07.90- 06.03	CA8281R	14 120			
		A20 07.90- 09.91	CA8291R	14 90			
		A20 09.91- 04.03	CA7361R	14 90			
		A20 09.91- 04.03	CA8281R	14 120			



VW Continued

Transporter 2.0 T5	[AXA]	04.03-04.03-	CA1394IR CA1782IR	14 120 14 140		04.03-	CS1294	12 1.1
Transporter 2.0 BiTDI T5	[CFCA]					09.09-	CS1323	12 2.0
Transporter 2.0 BiTDI T5 4 Motion	[CFCA]					09.09-	CS1323	12 2.0
Transporter 2.0 TDi T5	[CAAC]					09.09-	CS1323	12 2.0
Transporter 2.0 TDi T5 4 Motion	[CAAC]					09.09-	CS1323	12 2.0
Transporter 2.1 T3	[DJ]	07.85- 07.92	CA320IR	14 90		05.86- 07.92 AT 07.85- 07.92 07.85- 05.86	CS683 CS531 CS298	12 0.95 12 0.8 12 0.8
	[MV]	08.85- 07.92	CA320IR	14 90		05.86- 07.92 AT 07.85- 07.92 07.85- 04.86	CS683 CS531 CS298	12 0.95 12 0.8 12 0.8
	[SR]	10.86- 07.92	CA320IR	14 90		AT 10.86- 07.92 10.86- 07.92	CS531 CS683	12 0.8 12 0.95
	[SS]	08.89- 07.92	CA320IR	14 90		AT 08.89- 07.92 08.89- 07.92	CS531 CS683	12 0.8 12 0.95
Transporter 2.1 T3 Syncro	[DJ]	01.86- 07.92 01.86- 07.92 01.86- 07.92	CA320IR CA537IR CA911IR#	14 90 14 45 14 65		01.86- 04.86 05.86- 07.92	CS298 CS683	12 0.8 12 0.95
	[MV]	08.85- 07.92 08.85- 07.92 08.85- 07.92	CA320IR CA537IR CA911IR#	14 90 14 45 14 65		05.86- 07.92 08.85- 04.86	CS683 CS298	12 0.95 12 0.8
	[SR]	10.86- 07.92 10.86- 07.92	CA298IR CA537IR	14 65 14 45		10.86- 07.92	CS683	12 0.95
Transporter 2.1 i T3	[SS]	08.89- 07.92	CA320IR	14 90		08.89- 07.92 AT 08.89- 07.92	CS683 CS531	12 0.95 12 0.8
Transporter 2.4 Diesel T4	[AJA]	08.97- 08.98 08.97- 08.98 08.98- 04.03 08.98- 04.03	CA1228IR CA1229IR CA1549IR CA1587IR	14 90 14 120 14 120 14 90		AT 08.97- 04.03 08.97- 04.03	CS295 CS801	12 1.7 12 1.8
	[AAB]	09.90- 12.95 09.90- 07.92 09.90- 07.92 07.92- 12.95 01.95- 12.95 01.96- 04.03 01.96- 04.03	CA610IR CA708IR CA906IR CA844IR CA828IR CA1228IR CA1229IR	14 90 ▲ 14 90 14 65 14 100 ▲ 14 120 ▲ 14 90 14 120		AT 09.90- 04.03 AT 09.90- 09.98 Chas. 70S059839- 07.90- 04.03 Chas. -70S055000 09.90- 11.94	CS295 CS272 CS801 CS599	12 1.7 12 1.7 12 1.8 12 2.2
Transporter 2.4 Diesel T4 Syncro	[AAB]	11.92- 01.95 11.92- 01.95 01.95- 12.95 01.96- 10.98 01.96- 10.98 11.98- 04.03 11.98- 04.03 11.98- 04.03 A20 11.92- 01.95	CA610IR CA844IR CA828IR CA1228IR CA1229IR CA1402IR CA1549IR CA1587IR CA708IR	14 90 14 100 ▲ 14 120 ▲ 14 90 14 120 14 90 14 120 14 90 14 90		11.92- 09.98 10.92- 04.03	CS599 CS801	12 2.2 12 1.8
Transporter 2.5 T4	[ACU]	10.91- 08.96 01.94- 12.95 01.94- 12.95 12.95- 10.96 12.95- 10.96	CA827IR CA736IR CA828IR CA1228IR CA1229IR	14 70 14 90 14 120 ▲ 14 90 14 120		12.94- 10.96 01.94- 12.94 AT 01.94- 10.96	CS801 CS598 CS295	12 1.8 12 1.8 12 1.7
	[AEN]	10.91- 12.95 01.94- 12.95 01.94- 12.95 09.95- 10.96 09.95- 10.96	CA827IR CA736IR CA828IR CA1228IR CA1229IR	14 70 14 90 14 120 14 90 14 120		AT 01.94- 10.96 01.94- 11.94 09.95- 12.95	CS295 CS598 CS801	12 1.7 12 1.8 12 1.8
	[AET]	Chas. 70-X-075001- 08.96- 06.03 Chas. 70-X-075001- 08.96- 06.03 Chas. -70-X-075000 08.96- 06.03 Chas. -70-X-075000 08.96- 06.03 AC, Chas. 70-X-075001- 08.96- 06.03 AC, Chas. -70-X-075000 08.96- 06.03	CA1402IR CA1445IR CA1228IR CA1229IR CA1445IR CA828IR	14 90 14 120 14 90 14 120 14 120 14 120 ▲		08.96- 06.03 AT 08.96- 06.03	CS801 CS295	12 1.8 12 1.7
	[AEU]	11.90- 06.03 01.94- 12.95 01.94- 12.95 08.96- 06.03 08.96- 06.03 08.96- 06.03 10.98- 04.03 10.98- 04.03 AT 08.96- 06.03	CA1445IR CA736IR CA827IR CA1228IR CA1229IR CA1402IR CA828IR CA1549IR CA1587IR CA828IR	14 120 14 90 14 70 14 90 14 120 14 90 14 120 14 120 14 90 14 120		08.96- 06.03 01.94- 11.94 AT 01.94- 06.03	CS801 CS598 CS295	12 1.8 12 1.8 12 1.7
	[APL]	05.99- 06.03 05.99- 06.03 AC 05.99- 06.03	CA1402IR CA1445IR CA1445IR	14 90 14 120 14 120		05.99- 06.03	CS801	12 1.8
	[AVT]	12.99- 06.03 12.99- 06.03	CA1402IR CA1445IR	14 90 14 120		12.99- 06.03 AT 12.99- 06.03	CS801 CS295	12 1.8 12 1.7
	[AAF]	09.90- 09.91 09.90- 09.91 11.90- 09.91 10.91- 12.93 10.91- 12.93 10.91- 12.93	CA708IR CA906IR CA610IR CA736IR CA827IR CA828IR	14 90 14 65 14 90 ▲ 14 90 14 70 14 120		AT 09.90- 12.93 09.90- 12.93	CS295 CS598	12 1.7 12 1.8
Transporter 2.5 T4 Syncro	[ACU]	01.94- 12.95 01.94- 10.96 01.94- 12.95 12.95- 10.96 12.95- 10.96	CA736IR CA827IR CA828IR CA1228IR CA1229IR	14 90 14 70 14 120 ▲ 14 90 14 120		01.94- 12.94 12.94- 10.96	CS598 CS801	12 1.8 12 1.8
	[AEN]	09.95- 12.95 09.95- 12.95 09.95- 12.95 09.95- 12.95	CA1228IR CA1229IR CA736IR CA828IR	14 90 14 120 14 90 14 120		09.95- 12.95 AT 09.95- 12.95	CS801 CS295	12 1.8 12 1.7
	[AET]	Chas. 70-X-075001- 07.96- 06.03 Chas. 70-X-075001- 07.96- 06.03 Chas. -70-X-075000 07.96- 06.03 Chas. -70-X-075000 07.96- 06.03 AC, Chas. 70-X-075001- 07.96- 06.03 AC, Chas. -70-X-075000 07.96- 06.03	CA1402IR CA1445IR CA1228IR CA1229IR CA1445IR CA828IR	14 90 14 120 14 90 14 120 14 120 14 120 ▲		AT 07.96- 06.03 07.96- 06.03	CS295 CS801	12 1.7 12 1.8
	[AEU]	10.92- 10.98 10.92- 11.01 10.92- 04.02 11.98- 04.02 AT 11.92- 11.01	CA1228IR CA1229IR CA1445IR CA1402IR CA828IR	14 90 14 120 14 120 14 90 14 120		AT 06.97- 04.02 06.97- 04.02	CS295 CS801	12 1.7 12 1.8



	[APL]	05.99- 06.03 05.99- 06.03 AC 05.99- 06.03	CA1402IR CA1445IR CA1445IR	14 90 14 120 14 120		05.99- 06.03	CS801	12 1.8
	[AVT]	12.99- 06.03 12.99- 06.03	CA1402IR CA1445IR	14 90 14 120		12.99- 06.03 AT 12.99- 06.03	CS801 CS295	12 1.8 12 1.7
	[AAF]	11.92- 12.93 11.92- 12.93 11.92- 12.93	CA736IR CA827IR CA828IR	14 90 14 70 14 120		11.92- 12.93	CS598	12 1.8
Transporter 2.5 TD T4	[AJT]	04.01- 06.03 05.98- 10.98 05.98- 10.98 05.98- 04.01 10.98- 06.03 10.98- 06.03	CA1763IR CA1228IR CA1229IR CA1848IR CA1402IR CA1445IR	14 150 14 90 14 120 14 150 14 90 14 120		AT 05.98- 06.03 AT 05.98- 04.02 AT 04.02- 06.03 05.98- 06.03	CS295 CS789 CS1287 CS801	12 1.7 12 1.8 12 2.0 12 1.8
	[AAY]	10.01- 06.03 10.01- 06.03 10.01- 06.03	CA1402IR CA1445IR CA1763IR	14 90 14 120 14 150		AT 10.01- 06.03 10.01- 06.03	CS295 CS801	12 1.7 12 1.8
Transporter 2.5 TDi T4	[ACV]	04.01- 06.03 01.95- 10.98 01.95- 10.98 01.95- 04.01 10.98- 06.03 10.98- 06.03	CA1763IR CA1228IR CA1229IR CA1848IR CA1402IR CA1445IR	14 150 ▲ 14 90 14 120 14 150 14 90 14 120		AT 01.95- 04.02 AT 04.02- 06.03 01.95- 06.03 AT 01.95- 06.03	CS789 CS1287 CS801 CS295	12 1.8 12 2.0 12 1.8 12 1.7
	[AHY]	05.98- 03.04 05.98- 03.04	CA1402IR CA1445IR	14 90 14 120		05.98- 03.04 05.98- 03.04	CS801 CS1209	12 1.8 12 2.0
	[AJT]	04.01- 06.03 05.98- 10.98 05.98- 10.98 05.98- 04.01 10.98- 06.03 10.98- 06.03	CA1763IR CA1228IR CA1229IR CA1848IR CA1402IR CA1445IR	14 150 14 90 14 120 14 150 14 90 14 120		05.98- 06.03 AT 04.02- 06.03 AT 05.98- 06.03 AT 05.98- 04.02	CS801 CS1287 CS295 CS789	12 1.8 12 2.0 12 1.7 12 1.8
	[AUF]	04.01- 06.03 05.99- 06.03 05.99- 06.03 05.99- 04.01	CA1763IR CA1402IR CA1445IR CA1848IR	14 150 ▲ 14 90 14 120 14 150		AT 05.99- 06.03 AT 04.02- 06.03 05.99- 06.03 AT 05.99- 04.02	CS295 CS1287 CS801 CS789	12 1.7 12 2.0 12 1.8 12 1.8
	[AXG]	05.98- 03.04 05.98- 03.04	CA1402IR CA1445IR	14 90 14 120		05.98- 03.04 09.00- 06.03	CS1209 CS801	12 2.0 12 1.8
	[AYC]	04.01- 06.03 04.01- 06.03 04.01- 06.03 05.99- 04.01	CA1402IR CA1445IR CA1763IR CA1848IR	14 90 14 120 14 150 ▲ 14 150		AT 04.01- 06.03 04.01- 06.03	CS295 CS801	12 1.7 12 1.8
	[AAY]	10.01- 06.03 10.01- 06.03 10.01- 06.03	CA1402IR CA1445IR CA1763IR	14 90 14 120 14 150		AT 10.01- 06.03 10.01- 06.03	CS295 CS801	12 1.7 12 1.8
Transporter 2.5 TDi T4 Syncro	[ACV]	04.01- 06.03 01.95- 10.98 01.95- 10.98 01.95- 04.01 10.98- 06.03 10.98- 06.03	CA1763IR CA1228IR CA1229IR CA1848IR CA1402IR CA1445IR	14 150 14 90 14 120 14 150 14 90 14 120		AT 01.95- 06.03 AT 04.02- 06.03 01.95- 06.03 AT 01.95- 04.02	CS295 CS1287 CS801 CS789	12 1.7 12 2.0 12 1.8 12 1.8
	[AXL]	04.01- 06.03 01.95- 10.98 01.95- 10.98 01.95- 04.01 10.98- 06.03 10.98- 06.03	CA1763IR CA1228IR CA1229IR CA1848IR CA1402IR CA1445IR	14 150 14 90 14 120 14 150 14 90 14 120		AT 01.95- 04.02 01.95- 06.03 AT 04.02- 06.03 AT 01.95- 06.03	CS789 CS801 CS1287 CS295	12 1.8 12 1.8 12 2.0 12 1.7
Transporter 2.5 TDi T5	[AXD]	04.03- 04.03-	CA1819IR CA1820IR	14 150 14 180		04.03-	CS1405	12 2.2
	[AXE]	04.03- 04.03-	CA1819IR CA1820IR	14 150 14 180		04.03-	CS1405	12 2.2
Transporter 2.5 TDi T5 4 Motion	[AXD]	07.04- 07.04-	CA1819IR CA1820IR	14 150 14 180		07.04-	CS1405	12 2.2
	[AXE]	04.04- 04.04-	CA1819IR CA1820IR	14 150 14 180		04.04-	CS1405	12 2.2
	[BPC]	04.04- 04.04-	CA1819IR CA1820IR	14 150 14 180		04.04-	CS1405	12 2.2
Transporter 2.8 V6 T4	[AMV]	04.00- 04.03 04.00- 04.03	CA1143IR CA1763IR	14 150 14 150		04.00- 04.03 AT 04.00- 04.03 04.00- 04.03	CS1209 CS295 CS801	12 2.0 12 1.7 12 1.8
Transporter 2.8 VR6 T4	[AES]	11.95- 05.00 01.96- 05.00 01.96- 05.00	CA1402IR CA1142IR CA1143IR	14 90 14 120 14 150		11.95- 05.00 AT 11.95- 05.00	CS801 CS295	12 1.8 12 1.7
	[AMV]	06.00- 04.03 06.00- 04.03	CA1143IR CA1644IR	14 150 14 120		06.00- 08.01 09.01- 04.03 AT 06.00- 04.03	CS1209 CS801 CS295	12 2.0 12 1.8 12 1.7
Transporter 3.2 V6 T5	[BDL]	04.03- 04.03-	CA1394IR CA1763IR	14 120 14 150		04.03-	CS1323	12 2.0
	[BKK]	08.03- 08.03-	CA1394IR CA1763IR	14 120 14 150		08.03-	CS1323	12 2.0
	[CFLA]	08.03- 08.03-	CA1394IR CA1763IR	14 120 14 150		08.03-	CS1323	12 2.0
Vento 1.4	[ABD]	11.91- 07.95 11.91- 07.95 11.91- 07.95 ACPS 11.91- 07.95 ACPS 11.91- 09.95	CA732IR CA733IR CA740IR CA736IR CA827IR	14 60 14 70 14 90 14 90 14 70		07.92- 07.95 11.91- 06.92	CS788 CS723	12 0.9 12 0.9
	[AEX]	07.95- 12.97 07.95- 12.97 07.95- 12.97 PS 07.95- 12.97 PS 07.95- 12.97	CA732IR CA733IR CA740IR CA736IR CA827IR	14 60 14 70 14 90 14 90 14 70		07.95- 12.97 07.95- 12.97	CS1062 CS618	12 1.1 12 1.1
Vento 1.6	[ABU]	09.92- 09.94 09.92- 07.95 09.92- 07.95 ACPS 09.92- 07.95 ACPS 09.92- 07.95 AC 09.92- 09.94	CA732IR CA733IR CA740IR CA736IR CA827IR CA828IR	14 60 14 70 14 90 14 90 14 70 14 120		09.92- 09.94 10.94- 07.95	CS880 CS618	12 1.1 12 1.1
	[AEA]	10.94- 12.97 10.94- 12.97	CA733IR CA740IR	14 70 14 90		10.94- 12.97 10.94- 12.97	CS618 CS1062	12 1.1 12 1.1
	[AEE]	07.95- 12.97 07.95- 12.97	CA733IR CA740IR	14 70 14 90		07.95- 12.97 07.95- 12.97	CS618 CS1062	12 1.1 12 1.1
	[AEK]	10.94- 12.95 10.94- 12.95 10.94- 12.95	CA732IR CA733IR CA740IR	14 60 14 70 14 90		10.94- 12.95 10.94- 12.95	CS1062 CS618	12 1.1 12 1.1



VW Continued

		10.94- 12.95	CA828IR	14 120			
		ACPS 10.94- 12.95	CA736IR	14 90			
		ACPS 10.94- 12.95	CA827IR	14 70			
	[AFT]	12.95- 12.97	CA732IR	14 60	12.95- 12.97	CS618	12 1.1
		12.95- 12.97	CA733IR	14 70	12.95- 12.97	CS1062	12 1.1
		12.95- 12.97	CA740IR	14 90			
		12.95- 12.97	CA828IR	14 120			
		ACPS 12.95- 12.97	CA736IR	14 90			
		ACPS 12.95- 12.97	CA827IR	14 70			
Vento 1.8	[ABS]	11.91- 09.94	CA732IR	14 60	11.91- 09.94	CS618	12 1.1
		11.91- 09.94	CA733IR	14 70			
		11.91- 09.94	CA740IR	14 90			
		11.91- 09.94	CA828IR	14 120			
		AC 11.91- 09.94	CA736IR	14 90			
		AC 11.91- 09.94	CA827IR	14 70			
	[ADZ]	10.94- 12.97	CA732IR	14 60	10.94- 12.97	CS618	12 1.1
		10.94- 12.97	CA733IR	14 70	11.91- 09.98	CS1062	12 1.1
		10.94- 12.97	CA740IR	14 90			
		10.94- 12.97	CA828IR	14 120			
		AC 10.94- 12.97	CA736IR	14 90			
		AC 10.94- 12.97	CA827IR	14 70			
	[AAM]	11.91- 12.97	CA732IR	14 60	11.91- 12.97	CS618	12 1.1
		11.91- 12.97	CA733IR	14 70	11.91- 12.97	CS1062	12 1.1
		02.92- 12.97	CA740IR	14 90			
		AC 11.91- 12.97	CA736IR	14 90			
		AC 11.91- 12.97	CA827IR	14 70			
		AC 11.91- 12.97	CA828IR	14 120			
Vento 1.9 Diesel	[1Y]	11.91- 12.97	CA732IR	14 60	11.91- 06.94	CS713	12 1.8
		11.91- 12.97	CA733IR	14 70	07.94- 12.97	CS789	12 1.8
		11.91- 12.97	CA740IR	14 90			
		AC 11.91- 12.97	CA736IR	14 90			
		AC 11.91- 12.97	CA827IR	14 70			
		AC 11.91- 12.97	CA828IR	14 120			
Vento 1.9 SDi	[AEY]	01.95- 12.97	CA1089IR	14 120	01.95- 12.97	CS789	12 1.8
		01.95- 12.97	CA827IR	14 70	ECO 01.95- 12.97	CS713	12 1.8
		01.97- 12.97	CA736IR	14 90			
Vento 1.9 TD	[AAZ]	11.91- 12.97	CA732IR	14 60	11.91- 06.94	CS713	12 1.8
		11.91- 12.97	CA733IR	14 70	07.94- 12.97	CS789	12 1.8
		11.91- 12.97	CA740IR	14 90			
		AC 11.91- 12.97	CA736IR	14 90			
		AC 11.91- 12.97	CA827IR	14 70			
		AC 11.91- 12.97	CA828IR	14 120			
Vento 1.9 TDi	[1Z]	09.93- 07.96	CA1089IR	14 120	07.94- 07.96	CS974	12 1.8
		09.93- 07.96	CA736IR	14 90	AT 09.93- 06.94	CS713	12 1.8
		09.93- 07.96	CA827IR	14 70	AT 07.94- 07.96	CS789	12 1.8
					09.93- 06.94	CS616	12 1.8
	[AFN]	02.96- 09.98	CA1260IR	14 120	02.96- 09.98	CS789	12 1.8
		02.96- 09.98	CA736IR	14 90	02.96- 09.98	CS974	12 1.8
		02.96- 09.98	CA827IR	14 70			
		02.96- 09.98	CA828IR	14 120			
	[AHU]	08.96- 12.97	CA1089IR	14 120	AT 08.96- 12.97	CS789	12 1.8
		08.96- 12.97	CA1260IR	14 120	08.96- 12.97	CS974	12 1.8
		08.96- 12.97	CA736IR	14 90			
		08.96- 12.97	CA827IR	14 70			
	[ALE]	05.97- 12.97	CA1089IR	14 120	AT 05.97- 12.97	CS789	12 1.8
		05.97- 12.97	CA1260IR	14 120	05.97- 12.97	CS974	12 1.8
		05.97- 12.97	CA736IR	14 90			
		05.97- 12.97	CA827IR	14 70			
Vento 2.0	[2E]	11.91- 09.94	CA732IR	14 60	11.91- 09.94	CS618	12 1.1
		11.91- 09.94	CA733IR	14 70			
		11.91- 09.94	CA740IR	14 90			
		11.91- 09.94	CA828IR	14 120			
		AC 11.91- 09.94	CA736IR	14 90			
		AC 11.91- 09.94	CA827IR	14 70			
	[ADY]	10.94- 05.96	CA732IR	14 60	10.94- 05.96	CS618	12 1.1
		10.94- 05.96	CA733IR	14 70			
		10.94- 05.96	CA740IR	14 90			
		10.94- 05.96	CA828IR	14 120			
		AC 10.94- 05.96	CA736IR	14 90			
		AC 10.94- 05.96	CA827IR	14 70			
	[AGG]	07.95- 12.97	CA732IR	14 60	07.95- 12.97	CS618	12 1.1
		07.95- 12.97	CA733IR	14 70			
		07.95- 12.97	CA740IR	14 90			
		07.95- 12.97	CA828IR	14 120			
		AC 07.95- 12.97	CA736IR	14 90			
		AC 07.95- 12.97	CA827IR	14 70			
	[AKR]	05.97- 12.97	CA732IR	14 60	05.97- 12.97	CS618	12 1.1
		05.97- 12.97	CA733IR	14 70			
		05.97- 12.97	CA740IR	14 90			
		05.97- 12.97	CA828IR	14 120			
		AC 05.97- 12.97	CA736IR	14 90			
		AC 05.97- 12.97	CA827IR	14 70			
Vento 2.8 VR6	[AAA]	01.95- 12.97	CA1142IR	14 120	AT 01.92- 03.94	CS713	12 1.8
					01.92- 12.97	CS620	12 1.7
					03.94- 12.97	CS789	12 1.8
<b>PASSENGER CARS US</b>							
411 1.7	[EA]				01.72- 01.72	CS117	12 0.7
	[W]				01.71- 01.72	CS117	12 0.7
	[Z]				01.71- 01.72	CS117	12 0.7
412 1.7	[EA]				01.73- 01.74	CS117	12 0.7
	[EB]				01.73- 01.73	CS117	12 0.7
	[W]				01.73- 01.73	CS117	12 0.7
	[Z]				01.73- 01.73	CS117	12 0.7
412 1.8	[AN]				01.74- 01.74	CS117	12 0.7
	[AT]				01.74- 01.74	CS117	12 0.7
	[EC]				01.74- 01.74	CS117	12 0.7
Beetle 1.5	[H]				01.67- 01.69	CS117	12 0.7
					01.67- 01.69	CS62	12 0.7
Beetle 1.6	[AE]				01.71- 01.73	CS117	12 0.7
					01.71- 01.73	CS62	12 0.7
	[AH]				01.72- 01.74	CS117	12 0.7
					01.72- 01.74	CS62	12 0.7
	[AJ]				01.75- 01.79	CS117	12 0.7
					01.75- 01.79	CS62	12 0.7



	[AK]				01.73- 01.74	CS117	12	0.7	
					01.73- 01.74	CS62	12	0.7	
	[B]				01.70- 01.70	CS117	12	0.7	
					01.70- 01.70	CS62	12	0.7	
Beetle 1.8 Turbo	[APH]	01.99- 01.00	CA1549IR	14	120	01.99- 01.00	CS1119	12	1.1
		01.99- 01.00	CA827IR	14	70	01.99- 01.00	CS1062	12	1.1
	[AWV]	01.01- 01.01	CA1549IR	14	120	01.01- 01.01	CS1062	12	1.1
		01.01- 01.01	CA827IR	14	70	01.01- 01.01	CS1119	12	1.1
		01.02- 01.03	CA1378IR	14	90				
		01.02- 01.03	CA1394IR	14	120				
Beetle 1.8 Turbo S	[AWP]	01.02- 01.03	CA1378IR	14	90				
		01.02- 01.03	CA1394IR	14	120				
Beetle 1.9 Turbo	[ALH]	01.02- 01.02	CA1394IR	14	120	01.98- 01.01	CS974	12	1.8
		01.99- 01.01	CA1446IR	14	90				
Beetle 2.0	[AEG]	01.98- 01.98	CA1570IR	14	90	01.98- 01.00	CS1062	12	1.1
		01.99- 01.00	CA1436IR	14	70	01.98- 01.98	CS619	12	1.1
		01.99- 01.00	CA1549IR	14	120	01.98- 01.00	CS1119	12	1.1
		01.99- 01.00	CA827IR	14	70				
	[AVH]	01.01- 01.03	CA1436IR	14	70	01.01- 01.01	CS1062	12	1.1
		01.01- 01.01	CA1549IR	14	120	01.01- 01.01	CS1119	12	1.1
		01.01- 01.03	CA827IR	14	70				
	[AZG]	01.01- 01.02	CA1436IR	14	70	01.01- 01.01	CS1119	12	1.1
		01.01- 01.01	CA1549IR	14	120	01.01- 01.01	CS1062	12	1.1
			01.01- 01.02	CA827IR	14	70			
[BDC]	01.03- 01.03	CA1436IR	14	70					
	01.03- 01.03	CA827IR	14	70					
Cabrio 2.0	[ABA]	01.95- 01.02	CA736IR	14	90	01.95- 01.97	CS974	12	1.8
		01.95- 01.98	CA827IR	14	70	01.95- 01.01	CS618	12	1.1
Cabrio 2.0 Highline	[ABA]	01.97- 01.97	CA736IR	14	90	01.97- 01.97	CS618	12	1.1
		01.97- 01.97	CA827IR	14	70	01.97- 01.97	CS974	12	1.8
Cabriolet 1.8	[ZH]	01.90- 01.93	CA296IR	14	55	01.90- 01.93	CS294	12	0.9
		01.90- 01.93	CA318IR	14	90				
		01.90- 01.93	CA911IR#	14	65				
	[JH]	01.85- 01.87	CA242IR	14	65	01.85- 01.89	CS294	12	0.9
		01.85- 01.87	CA320IR	14	90	01.85- 01.87	CS276	12	0.7
		01.88- 01.89	CA296IR	14	55				
01.88- 01.89		CA318IR	14	90					
		01.88- 01.89	CA911IR#	14	65				
Cabriolet 1.8 Carat	[ZH]	01.91- 01.92	CA296IR	14	55	01.91- 01.92	CS294	12	0.9
		01.91- 01.92	CA318IR	14	90				
		01.91- 01.92	CA911IR#	14	65				
Cabriolet 1.8 Etienne Aigner	[ZH]	01.91- 01.91	CA296IR	14	55	01.91- 01.91	CS294	12	0.9
		01.91- 01.91	CA318IR	14	90				
		01.91- 01.91	CA911IR#	14	65				
Campmobile 1.6	[AD]					01.71- 01.71	CS62	12	0.7
	[AE]					01.71- 01.71	CS62	12	0.7
	[AF]					01.71- 01.71	CS62	12	0.7
	[B]					01.69- 01.70	CS62	12	0.7
	[C]					01.69- 01.70	CS62	12	0.7
Campmobile 1.7	[CA]					01.72- 01.73	CS117	12	0.7
						01.72- 01.73	CS62	12	0.7
	[CB]					01.72- 01.73	CS117	12	0.7
						01.72- 01.73	CS62	12	0.7
	[CD]					01.73- 01.73	CS117	12	0.7
						01.73- 01.73	CS62	12	0.7
[CE]					01.73- 01.73	CS117	12	0.7	
					01.73- 01.73	CS62	12	0.7	
Campmobile 1.8	[AP]					01.74- 01.75	CS117	12	0.7
						01.74- 01.75	CS62	12	0.7
	[AW]					01.74- 01.74	CS117	12	0.7
						01.74- 01.74	CS62	12	0.7
[ED]					01.74- 01.75	CS117	12	0.7	
					01.74- 01.75	CS62	12	0.7	
Campmobile 2.0	[CJ]					01.76- 01.79	CS115	12	0.7
						01.76- 01.79	CS117	12	0.7
	[GD]					01.76- 01.77	CS115	12	0.7
					01.76- 01.77	CS117	12	0.7	
[GE]					01.78- 01.79	CS115	12	0.7	
					01.78- 01.79	CS117	12	0.7	
Corrado 1.8 Super	[PG]	01.90- 01.92	CA841IR	14	90	01.91- 01.92	CS601	12	1.1
						01.90- 01.92	CS294	12	0.9
						01.90- 01.92	CS559	12	1.0
Corrado 2.8 SLC	[AAA]	01.92- 01.94	CA736IR	14	90	01.92- 01.94	CS295	12	1.7
		01.92- 01.94	CA828IR	14	120				
Corrado 2.8 V6	[AAA]	01.93- 01.94	CA736IR	14	90	01.93- 01.94	CS295	12	1.7
		01.93- 01.94	CA828IR	14	120				
Dasher 1.5	[XR]	01.75- 01.75	CA35IR	14	35	01.75- 01.75	CS293	12	0.8
		01.75- 01.75	CA52IR	14	55				
		01.75- 01.75	CA35IR	14	35	01.75- 01.75	CS293	12	0.8
	[XS]	01.75- 01.75	CA35IR	14	35	01.75- 01.75	CS293	12	0.8
		01.75- 01.75	CA52IR	14	55				
	[XV]	01.74- 01.74	CA35IR	14	35	01.74- 01.74	CS293	12	0.8
		01.74- 01.74	CA52IR	14	55				
	[XW]	01.74- 01.74	CA35IR	14	35	01.74- 01.74	CS293	12	0.8
		01.74- 01.74	CA52IR	14	55				
[XY]	01.74- 01.74	CA35IR	14	35	01.74- 01.74	CS293	12	0.8	
	01.74- 01.74	CA52IR	14	55					
[XZ]	01.74- 01.74	CA35IR	14	35	01.74- 01.74	CS293	12	0.8	
	01.74- 01.74	CA52IR	14	55					
Dasher 1.5	[CK]	01.79- 01.80	CA139IR	14	65	01.79- 01.80	CS185	12	1.5
		01.79- 01.80	CA252IR	14	55				
		01.79- 01.80	CA35IR	14	35				
		01.79- 01.80	CA52IR	14	55				
Dasher 1.6	[YG]	01.76- 01.80	CA35IR	14	35	01.76- 01.80	CS293	12	0.8
		01.76- 01.80	CA52IR	14	55				
	[YH]	01.76- 01.80	CA35IR	14	35	01.76- 01.80	CS293	12	0.8
[YK]	01.76- 01.76	CA35IR	14	35	01.76- 01.76	CS293	12	0.8	
		01.76- 01.76	CA52IR	14	55				
Dasher 1.6	[CR]	01.81- 01.81	CA139IR	14	65	01.81- 01.81	CS185	12	1.5
Eurovan 2.4	[AAB]	01.93- 01.95	CA610IR	14	90	10.92- 11.94	CS599	12	2.2
		01.93- 01.95	CA844IR	14	100	12.94- 01.96	CS801	12	1.8
		01.96- 10.98	CA1229IR	14	120				
Eurovan 2.4 Camper	[AAB]				01.95-	CS801	12	1.8	



VW Continued

Eurovan 2.4 CL	[AAB]	10.92- 01.95	CA610IR	14 90	01.93- 11.94	CS599	12 2.2
		10.92- 01.95	CA844IR	14 100	12.94-	CS801	12 1.8
		01.96- 10.98	CA1229IR	14 120			
Eurovan 2.4 CV	[AAB]				01.93- 01.94	CS599	12 2.2
Eurovan 2.4 GL	[AAB]				01.93- 12.94	CS599	12 2.2
					12.94-	CS801	12 1.8
Eurovan 2.4 GLS	[AAB]				01.94- 12.94	CS599	12 2.2
Eurovan 2.5	[ACU]	01.95- 01.95	CA736IR	14 90	01.95- 01.95	CS295	12 1.7
		01.95- 01.95	CA827IR	14 70			
		01.95- 01.95	CA828IR	14 120			
	[AAF]	01.94- 01.94	CA736IR	14 90	01.94- 01.94	CS295	12 1.7
		01.94- 01.94	CA827IR	14 70			
		01.94- 01.94	CA828IR	14 120			
Eurovan 2.5 Camper	[ACU]	01.95- 01.95	CA736IR	14 90	01.95- 01.95	CS295	12 1.7
		01.95- 01.95	CA827IR	14 70			
		01.95- 01.95	CA828IR	14 120			
Eurovan 2.5 CL	[AAF]	01.93- 01.93	CA736IR	14 90	01.93- 01.93	CS295	12 1.7
		01.93- 01.93	CA827IR	14 70			
		01.93- 01.93	CA828IR	14 120			
Eurovan 2.5 CV	[AAF]	01.93- 01.94	CA736IR	14 90	01.93- 01.94	CS295	12 1.7
		01.93- 01.94	CA827IR	14 70			
		01.93- 01.94	CA828IR	14 120			
Eurovan 2.5 GL	[AAF]	01.93- 01.94	CA736IR	14 90	01.93- 01.94	CS295	12 1.7
		01.93- 01.94	CA827IR	14 70			
		01.93- 01.94	CA828IR	14 120			
Eurovan 2.5 GLS	[ACU]	01.95- 01.95	CA736IR	14 90	01.95- 01.95	CS295	12 1.7
		01.95- 01.95	CA827IR	14 70			
		01.95- 01.95	CA828IR	14 120			
Eurovan 2.5 MV	[AAF]	01.93- 01.94	CA736IR	14 90	01.93- 01.94	CS295	12 1.7
		01.93- 01.94	CA827IR	14 70			
		01.93- 01.94	CA828IR	14 120			
Eurovan 2.5 Transport	[ACU]	01.95- 01.95	CA736IR	14 90	01.95- 01.95	CS295	12 1.7
		01.95- 01.95	CA827IR	14 70			
		01.95- 01.95	CA828IR	14 120			
Eurovan 2.8	[AES]	01.00- 01.00	CA827IR	14 70	01.99- 01.00	CS974	12 1.8
		01.99-	CA828IR	14 120			
Eurovan 2.8 Camper	[AES]	01.97- 01.98	CA828IR	14 120	01.97- 01.98	CS974	12 1.8
Fastback 1.6	[P]				01.68- 01.73	CS117	12 0.7
					01.68- 01.73	CS62	12 0.7
					01.67- 01.73	CS117	12 0.7
					01.67- 01.73	CS62	12 0.7
					01.68- 01.73	CS117	12 0.7
					01.68- 01.73	CS62	12 0.7
Fox 1.8	[ABG]	01.91- 01.93	CA296IR	14 55	01.91- 01.93	CS297	12 0.95
		01.91- 01.93	CA318IR	14 90			
		01.91- 01.93	CA911IR#	14 65			
	[JN]	01.87- 01.90	CA296IR	14 55	01.87- 01.90	CS297	12 0.95
		01.87- 01.90	CA318IR	14 90			
		01.87- 01.90	CA911IR#	14 65			
[UM]	01.87- 01.87	CA296IR	14 55	01.87- 01.87	CS297	12 0.95	
	01.87- 01.87	CA318IR	14 90				
	01.87- 01.87	CA911IR#	14 65				
Fox 1.8 GL	[ABG]	01.91- 01.93	CA296IR	14 55	01.91- 01.93	CS297	12 0.95
		01.91- 01.93	CA318IR	14 90			
		01.91- 01.93	CA911IR#	14 65			
	[JN]	01.87- 01.90	CA296IR	14 55	01.87- 01.90	CS297	12 0.95
		01.87- 01.90	CA318IR	14 90			
		01.87- 01.90	CA911IR#	14 65			
[UM]	01.87- 01.87	CA296IR	14 55	01.87- 01.87	CS297	12 0.95	
	01.87- 01.87	CA318IR	14 90				
	01.87- 01.87	CA911IR#	14 65				
Fox 1.8 GL Sport	[JN]	01.89- 01.90	CA296IR	14 55	01.89- 01.90	CS297	12 0.95
		01.89- 01.90	CA318IR	14 90			
Golf II 1.6	[ME]	01.85- 01.86	CA276IR	14 65	01.85- 01.86	CS295	12 1.7
		01.85- 01.86	CA277IR#	14 45			
		01.85- 01.86	CA302IR	14 65			
Golf II 1.6 GL	[ME]	01.87- 01.88	CA302IR	14 65	01.87- 01.88	CS295	12 1.7
		01.87- 01.88	CA376IR	14 65			
Golf II 1.8	[PF]	01.88- 01.89	CA296IR	14 55	01.88- 01.89	CS294	12 0.9
		01.88- 01.89	CA318IR	14 90			
		01.88- 01.89	CA342IR	14 65			
		01.88- 01.89	CA343IR	14 90			
		01.88- 01.89	CA911IR#	14 65			
	[RV]	01.88- 01.89	CA296IR	14 55	01.88- 01.89	CS294	12 0.9
Golf II 1.8 GL	[GX]	01.87- 01.87	CA296IR	14 55	01.87- 01.87	CS294	12 0.9
		01.87- 01.87	CA318IR	14 90			
		01.87- 01.87	CA342IR	14 65			
		01.87- 01.87	CA343IR	14 90			
		01.87- 01.87	CA911IR#	14 65			
	[PF]	01.88- 01.92	CA296IR	14 55	01.88- 01.92	CS294	12 0.9
		01.88- 01.92	CA318IR	14 90			
		01.88- 01.92	CA342IR	14 65			
		01.88- 01.92	CA343IR	14 90			
		01.88- 01.92	CA911IR#	14 65			
	[RV]	01.88- 01.92	CA296IR	14 55	01.88- 01.91	CS294	12 0.9
		01.88- 01.92	CA318IR	14 90			
01.88- 01.91		CA342IR	14 65				
01.88- 01.91		CA343IR	14 90				
01.88- 01.92		CA911IR#	14 65				
Golf II 1.8 GT	[PF]	01.88- 01.88	CA296IR	14 55	01.88- 01.88	CS294	12 0.9
		01.88- 01.88	CA318IR	14 90			
		01.88- 01.88	CA342IR	14 65			
		01.88- 01.88	CA343IR	14 90			
		01.88- 01.88	CA911IR#	14 65			
	[RD]	01.87- 01.87	CA296IR	14 55	01.87- 01.87	CS294	12 0.9
		01.87- 01.87	CA318IR	14 90			
		01.87- 01.87	CA342IR	14 65			



		01.87- 01.87	CA343IR	14 90			
		01.87- 01.87	CA911IR#	14 65			
Golf II 1.8 GTi 16V	[PL]	01.87- 01.89	CA296IR	14 55	01.87- 01.89	CS294	12 0.9
		01.87- 01.89	CA318IR	14 90			
		01.87- 01.89	CA342IR	14 65			
		01.87- 01.89	CA343IR	14 90			
		01.87- 01.89	CA911IR#	14 65			
Golf II 1.8 GTi	[HT]	01.85- 01.86	CA242IR	14 65	01.85- 01.86	CS294	12 0.9
		01.85- 01.86	CA320IR	14 90			
	[PF]	01.90- 01.92	CA296IR	14 55	01.90- 01.92	CS294	12 0.9
		01.90- 01.92	CA318IR	14 90			
		01.90- 01.92	CA911IR#	14 65			
	[RD]	01.85- 01.87	CA296IR	14 55	01.85- 01.87	CS294	12 0.9
		01.85- 01.87	CA318IR	14 90			
		01.85- 01.87	CA342IR	14 65			
		01.85- 01.87	CA343IR	14 90			
		01.85- 01.87	CA911IR#	14 65			
	[RV]	01.90- 01.92	CA296IR	14 55	01.90- 01.92	CS294	12 0.9
		01.90- 01.92	CA318IR	14 90			
		01.90- 01.92	CA911IR#	14 65			
Golf II 2.0 GTi 16V	[9A]	01.90- 01.92	CA342IR	14 65	01.90- 01.92	CS601	12 1.1
		01.90- 01.92	CA343IR	14 90			
Golf III 1.8 Turbo	[AWD]	01.00- 01.00	CA1549IR	14 120	01.00- 01.00	CS1119	12 1.1
		01.00- 01.00	CA827IR	14 70	01.00- 01.00	CS1062	12 1.1
	[AWW]	01.00- 01.00	CA1549IR	14 120	01.00- 01.00	CS1119	12 1.1
		01.00- 01.00	CA827IR	14 70	01.00- 01.00	CS1062	12 1.1
Golf III 1.9	[AAZ]	01.93- 01.95	CA733IR	14 70	01.93- 01.95	CS295	12 1.7
		01.93- 01.95	CA736IR	14 90			
		01.93- 01.95	CA740IR	14 90			
		01.93- 01.95	CA827IR	14 70			
		01.93- 01.95	CA828IR	14 120			
Golf III 1.9 TDi	[AHU]	01.97- 01.97	CA1089IR	14 120	01.97- 01.97	CS974	12 1.8
		01.97- 01.97	CA736IR	14 90			
		01.97- 01.97	CA827IR	14 70			
	[ALH]	01.99- 01.99	CA1436IR	14 70	01.99- 01.99	CS974	12 1.8
		01.99- 01.99	CA1549IR	14 120			
		01.99- 01.99	CA827IR	14 70			
	[AAZ]	01.96- 01.96	CA733IR	14 70	01.96- 01.96	CS974	12 1.8
		01.96- 01.96	CA736IR	14 90			
		01.96- 01.96	CA740IR	14 90			
		01.96- 01.96	CA827IR	14 70			
		01.96- 01.96	CA828IR	14 120			
Golf III 1.9 Turbo	[ALH]	01.00- 01.00	CA1436IR	14 70	01.00- 01.00	CS974	12 1.8
		01.00- 01.00	CA1549IR	14 120			
		01.00- 01.00	CA827IR	14 70			
Golf III 2.0	[ABA]	01.98- 01.98	CA733IR	14 70	01.98- 01.98	CS618	12 1.1
		01.98- 01.98	CA736IR	14 90			
		01.98- 01.98	CA740IR	14 90			
		01.98- 01.98	CA827IR	14 70			
		01.98- 01.98	CA828IR	14 120			
	[AEG]	01.00- 01.00	CA1549IR	14 120	01.00- 01.00	CS1119	12 1.1
		01.00- 01.00	CA827IR	14 70			
Golf III 2.0 Celebration Edit	[ABA]	01.95- 01.95	CA733IR	14 70	01.95- 01.95	CS618	12 1.1
		01.95- 01.95	CA736IR	14 90			
		01.95- 01.95	CA740IR	14 90			
		01.95- 01.95	CA827IR	14 70			
		01.95- 01.95	CA828IR	14 120			
Golf III 2.0 City	[ABA]	01.95- 01.95	CA733IR	14 70	01.95- 01.95	CS618	12 1.1
		01.95- 01.95	CA736IR	14 90			
		01.95- 01.95	CA740IR	14 90			
		01.95- 01.95	CA827IR	14 70			
		01.95- 01.95	CA828IR	14 120			
Golf III 2.0 GL	[ABA]	01.93- 01.97	CA733IR	14 70	01.99- 01.99	CS1119	12 1.1
		01.93- 01.97	CA736IR	14 90	01.93- 01.99	CS618	12 1.1
		01.93- 01.97	CA740IR	14 90			
		01.93- 01.97	CA828IR	14 120			
		01.94- 01.99	CA827IR	14 70			
		01.99- 01.99	CA1549IR	14 120			
	[AEG]	01.99- 01.99	CA1549IR	14 120	01.99- 01.99	CS618	12 1.1
		01.99- 01.99	CA827IR	14 70	01.99- 01.99	CS1119	12 1.1
Golf III 2.0 GLS	[AEG]	01.99- 01.99	CA1549IR	14 120	01.99- 01.99	CS1119	12 1.1
		01.99- 01.99	CA827IR	14 70	01.99- 01.99	CS618	12 1.1
Golf III 2.0 JAZZ	[ABA]	01.97- 01.97	CA733IR	14 70	01.97- 01.97	CS618	12 1.1
		01.97- 01.97	CA736IR	14 90			
		01.97- 01.97	CA740IR	14 90			
		01.97- 01.97	CA827IR	14 70			
		01.97- 01.97	CA828IR	14 120			
Golf III 2.0 K2	[ABA]	01.97- 01.97	CA733IR	14 70	01.97- 01.97	CS618	12 1.1
		01.97- 01.97	CA736IR	14 90			
		01.97- 01.97	CA740IR	14 90			
		01.97- 01.97	CA827IR	14 70			
		01.97- 01.97	CA828IR	14 120			
		01.98- 01.98	CA828IR	14 120	01.98- 01.98	CS618	12 1.1
		01.98- 01.98	CA740IR	14 90			
		01.98- 01.98	CA736IR	14 90			
		01.98- 01.98	CA827IR	14 70			
		01.98- 01.98	CA733IR	14 70			
Golf III 2.0 Sport	[ABA]	01.95- 01.95	CA733IR	14 70	01.95- 01.95	CS618	12 1.1
		01.95- 01.95	CA736IR	14 90			
		01.95- 01.95	CA740IR	14 90			
		01.95- 01.95	CA827IR	14 70			
		01.95- 01.95	CA828IR	14 120			
Golf III 2.0 Trek	[ABA]	01.97- 01.97	CA733IR	14 70	01.97- 01.97	CS618	12 1.1
		01.97- 01.97	CA736IR	14 90			
		01.97- 01.97	CA740IR	14 90			
		01.97- 01.97	CA827IR	14 70			
		01.97- 01.97	CA828IR	14 120			
Golf III 2.0 GTi	[ABA]	01.93- 01.98	CA733IR	14 70	01.93- 01.99	CS618	12 1.1
		01.93- 01.98	CA736IR	14 90	01.99- 01.99	CS1119	12 1.1
		01.93- 01.98	CA740IR	14 90			
		01.93- 01.98	CA828IR	14 120			
		01.94- 01.99	CA827IR	14 70			
		01.99- 01.99	CA1549IR	14 120			



VW Continued

	[AEG]	01.99- 01.00	CA1549IR	14 120		01.99- 01.00	CS1119	12 1.1
		01.99- 01.00	CA827IR	14 70				
Golf III 2.8 GTi	[AFP]	01.99- 01.02	CA1549IR	14 120				
		01.99- 01.02	CA827IR	14 70				
	[AAA]	01.99- 01.99	CA1549IR	14 120				
		01.99- 01.99	CA827IR	14 70				
Golf III 2.8 VR6	[AAA]	01.95- 01.98	CA736IR	14 90		01.95- 01.97	CS295	12 1.7
		01.95- 01.98	CA827IR	14 70				
		01.95- 01.98	CA828IR	14 120				
Golf III 1.8 GTi Turbo	[AWD]	01.01- 01.01	CA1549IR	14 120		01.01- 01.01	CS1181	12 2.0
		01.01- 01.01	CA827IR	14 70		01.01- 01.01	CS1119	12 1.1
	[AWP]	01.02- 01.03	CA1378IR	14 90		01.02- 01.03	CS1181	12 2.0
		01.02- 01.03	CA1549IR	14 120		01.02- 01.03	CS1119	12 1.1
		01.02- 01.03	CA827IR	14 70				
	[AWW]	01.01- 01.01	CA1549IR	14 120		01.01- 01.01	CS1181	12 2.0
		01.01- 01.01	CA827IR	14 70		01.01- 01.01	CS1119	12 1.1
Golf III 1.8 Turbo	[AWD]	01.01- 01.01	CA1549IR	14 120		01.01- 01.01	CS1181	12 2.0
		01.01- 01.01	CA827IR	14 70		01.01- 01.01	CS1119	12 1.1
	[AWW]	01.01- 01.01	CA1549IR	14 120		01.01- 01.01	CS1119	12 1.1
		01.01- 01.01	CA827IR	14 70		01.01- 01.01	CS1181	12 2.0
Golf III 1.9 Turbo	[ALH]	01.01- 01.01	CA1436IR	14 70		01.01- 01.01	CS974	12 1.8
		01.01- 01.01	CA1446IR	14 90				
		01.01- 01.01	CA1549IR	14 120				
		01.01- 01.01	CA827IR	14 70				
		01.02- 01.02	CA1394IR	14 120				
Golf III 2.0	[AEG]	01.01- 01.01	CA1549IR	14 120		01.01- 01.01	CS1119	12 1.1
		01.01- 01.01	CA827IR	14 70		01.01- 01.01	CS1062	12 1.1
	[AVH]	01.02- 01.03	CA827IR	14 70		01.02- 01.03	CS1062	12 1.1
						01.02- 01.03	CS1119	12 1.1
Jetta 1.6	[EJ]	01.80- 01.80	CA139IR	14 65		01.80- 01.80	CS116	12 0.8
		01.80- 01.80	CA35IR	14 35		01.80- 01.80	CS276	12 0.7
Jetta 1.6	[IV]	01.91- 01.91	CA139IR	14 65		01.91- 01.91	CS295	12 1.7
		01.91- 01.91	CA297IR	14 45				
		01.91- 01.91	CA302IR	14 65				
		01.91- 01.91	CA376IR	14 65				
	[ME]	01.87- 01.92	CA302IR	14 65		01.87- 01.92	CS295	12 1.7
		01.87- 01.92	CA376IR	14 65				
		01.92- 01.92	CA139IR	14 65				
		01.92- 01.92	CA297IR	14 45				
Jetta 1.6 Deluxe	[CR]	01.81- 01.81	CA139IR	14 65				
		01.81- 01.82	CA252IR	14 55				
	[JK]	01.83- 01.84	CA252IR	14 55				
	[ME]	01.85- 01.86	CA276IR	14 65		01.85- 01.86	CS295	12 1.7
		01.85- 01.86	CA277IR#	14 45				
		01.85- 01.86	CA302IR	14 65				
Jetta 1.6 GL	[IV]	01.92- 01.92	CA139IR	14 65		01.92- 01.92	CS295	12 1.7
		01.92- 01.92	CA297IR	14 45				
		01.92- 01.92	CA376IR	14 65				
	[ME]	01.89- 01.91	CA302IR	14 65		01.89- 01.91	CS295	12 1.7
		01.89- 01.91	CA376IR	14 65				
		01.91- 01.91	CA139IR	14 65				
		01.91- 01.91	CA297IR	14 45				
Jetta 1.6 Turbo	[MF]	01.85- 01.88	CA276IR	14 65		01.85- 01.88	CS295	12 1.7
		01.85- 01.88	CA277IR#	14 45				
		01.85- 01.88	CA302IR	14 65				
Jetta 1.6 Turbo Deluxe	[CY]	01.83- 01.84	CA252IR	14 55				
	[MF]	01.85- 01.85	CA276IR	14 65		01.85- 01.85	CS295	12 1.7
		01.85- 01.85	CA277IR#	14 45				
		01.85- 01.85	CA302IR	14 65				
Jetta 1.6 Turbo GL	[MF]	01.86- 01.88	CA302IR	14 65		01.86- 01.88	CS295	12 1.7
		01.86- 01.88	CA376IR	14 65				
Jetta 1.7 Deluxe	[EN]	01.81- 01.84	CA139IR	14 65		01.81- 01.84	CS116	12 0.8
		01.81- 01.84	CA141IR	14 65		01.81- 01.84	CS276	12 0.7
Jetta 1.8	[GX]	01.87- 01.87	CA296IR	14 55		01.87- 01.87	CS294	12 0.9
		01.87- 01.87	CA318IR	14 90				
		01.87- 01.87	CA911IR#	14 65				
	[MZ]	01.85- 01.86	CA242IR	14 65		01.85- 01.86	CS294	12 0.9
		01.85- 01.86	CA320IR	14 90				
	[PF]	01.89- 01.92	CA296IR	14 55		01.89- 01.89	CS294	12 0.9
		01.89- 01.92	CA318IR	14 90				
		01.89- 01.89	CA342IR	14 65				
		01.89- 01.89	CA343IR	14 90				
		01.89- 01.92	CA911IR#	14 65				
	[RV]	01.88- 01.92	CA296IR	14 55		01.88- 01.92	CS294	12 0.9
		01.88- 01.92	CA318IR	14 90				
		01.88- 01.89	CA342IR	14 65				
		01.88- 01.89	CA343IR	14 90				
		01.88- 01.92	CA911IR#	14 65				
Jetta 1.8 Carat	[PF]	01.88- 01.88	CA296IR	14 55		01.88- 01.88	CS294	12 0.9
		01.88- 01.88	CA318IR	14 90				
		01.88- 01.88	CA342IR	14 65				
		01.88- 01.88	CA343IR	14 90				
		01.88- 01.88	CA911IR#	14 65				
	[RD]	01.88- 01.88	CA296IR	14 55		01.88- 01.88	CS294	12 0.9
		01.88- 01.88	CA318IR	14 90				
		01.88- 01.88	CA342IR	14 65				
		01.88- 01.88	CA343IR	14 90				
		01.88- 01.88	CA911IR#	14 65				
	[RV]	01.89- 01.92	CA296IR	14 55		01.89- 01.92	CS294	12 0.9
		01.89- 01.92	CA318IR	14 90				
		01.89- 01.91	CA342IR	14 65				
		01.89- 01.91	CA343IR	14 90				
		01.89- 01.92	CA911IR#	14 65				
Jetta 1.8 Deluxe	[GX]	01.85- 01.87	CA242IR	14 65		01.85- 01.87	CS294	12 0.9
		01.85- 01.87	CA320IR	14 90				
	[JH]	01.84- 01.84	CA242IR	14 65		01.84- 01.84	CS116	12 0.8
		01.84- 01.84	CA320IR	14 90				
Jetta 1.8 GL	[PF]	01.88- 01.92	CA296IR	14 55		01.88- 01.92	CS294	12 0.9
		01.88- 01.92	CA318IR	14 90				
		01.88- 01.90	CA342IR	14 65				
		01.88- 01.90	CA343IR	14 90				
		01.88- 01.92	CA911IR#	14 65				
	[RD]	01.88- 01.88	CA296IR	14 55		01.88- 01.88	CS294	12 0.9
		01.88- 01.88	CA318IR	14 90				





		01.88- 01.88	CA342IR	14 65			
		01.88- 01.88	CA343IR	14 90			
		01.88- 01.88	CA911IR#	14 65			
	[RV]	01.88- 01.92	CA296IR	14 55	01.88- 01.92	CS294	12 0.9
		01.88- 01.92	CA318IR	14 90			
		01.88- 01.92	CA342IR	14 65			
		01.88- 01.92	CA343IR	14 90			
		01.88- 01.92	CA911IR#	14 65			
Jetta 1.8 GLi	[HT]	01.85- 01.85	CA242IR	14 65	01.85- 01.85	CS294	12 0.9
		01.85- 01.85	CA320IR	14 90			
	[PF]	01.87- 01.88	CA296IR	14 55	01.87- 01.88	CS294	12 0.9
		01.87- 01.88	CA318IR	14 90			
		01.87- 01.88	CA911IR#	14 65			
		01.88- 01.88	CA342IR	14 65			
		01.88- 01.88	CA343IR	14 90			
	[RD]	01.86- 01.87	CA296IR	14 55	01.86- 01.87	CS294	12 0.9
		01.86- 01.87	CA318IR	14 90			
		01.86- 01.87	CA911IR#	14 65			
Jetta 1.8 16V GLi	[PL]	01.87- 01.89	CA296IR	14 55	01.87- 01.89	CS294	12 0.9
		01.87- 01.89	CA318IR	14 90			
		01.87- 01.89	CA911IR#	14 65			
Jetta 1.8 Turbo GLS	[AWD]	01.00- 01.01	CA1549IR	14 120	01.00- 01.01	CS1119	12 1.1
		01.00- 01.01	CA827IR	14 70	01.00- 01.01	CS1062	12 1.1
					01.01- 01.01	CS1181	12 2.0
	[AWP]	01.02- 01.03	CA1378IR	14 90	01.02- 01.03	CS1119	12 1.1
		01.02- 01.03	CA1549IR	14 120	01.02- 01.03	CS1181	12 2.0
		01.02- 01.03	CA827IR	14 70			
	[AWW]	01.00- 01.01	CA1549IR	14 120	01.00- 01.01	CS1119	12 1.1
		01.00- 01.01	CA827IR	14 70	01.00- 01.01	CS1062	12 1.1
					01.01- 01.01	CS1181	12 2.0
Jetta 1.9	[AAZ]	10.92- 01.95	CA733IR	14 70	01.93- 01.95	CS295	12 1.7
		10.92- 01.95	CA828IR	14 120			
		AC 10.92- 01.95	CA736IR	14 90			
		AC 10.92- 01.95	CA827IR	14 70			
Jetta 1.9 TDi	[AHU]	01.97- 01.98	CA1089IR	14 120	01.97- 01.98	CS974	12 1.8
		01.97- 01.98	CA736IR	14 90			
		01.97- 01.98	CA827IR	14 70			
	[ALH]	01.02- 01.02	CA1394IR	14 120	01.99- 01.01	CS974	12 1.8
		01.99- 01.01	CA1436IR	14 70			
		01.99- 01.01	CA1549IR	14 120			
		01.99- 01.01	CA827IR	14 70			
	[AAZ]	01.96- 01.96	CA733IR	14 70	01.96- 01.96	CS974	12 1.8
		01.96- 01.96	CA828IR	14 120			
		AC 01.96- 01.96	CA736IR	14 90			
		AC 01.96- 01.96	CA827IR	14 70			
Jetta 2.0	[AVH]	01.01- 01.02	CA1549IR	14 120	01.01- 01.03	CS1062	12 1.1
		01.01- 01.03	CA827IR	14 70	01.01- 01.03	CS1119	12 1.1
		01.03- 01.03	CA1378IR	14 90			
	[AZG]	01.01- 01.02	CA1549IR	14 120	01.01- 01.02	CS1119	12 1.1
		01.01- 01.02	CA827IR	14 70	01.01- 01.02	CS1062	12 1.1
Jetta 2.0 Celebration Edit	[ABA]	01.95- 01.95	CA733IR	14 70	01.95- 01.95	CS618	12 1.1
		01.95- 01.95	CA736IR	14 90			
		01.95- 01.95	CA740IR	14 90			
		01.95- 01.95	CA827IR	14 70			
		01.95- 01.95	CA828IR	14 120			
Jetta 2.0 City	[ABA]	01.95- 01.95	CA733IR	14 70	01.95- 01.95	CS618	12 1.1
		01.95- 01.95	CA736IR	14 90			
		01.95- 01.95	CA740IR	14 90			
		01.95- 01.95	CA827IR	14 70			
		01.95- 01.95	CA828IR	14 120			
Jetta 2.0 GL	[ABA]	01.94- 01.98	CA733IR	14 70	01.94- 01.99	CS618	12 1.1
		01.94- 01.98	CA736IR	14 90	01.99- 01.99	CS1119	12 1.1
		01.94- 01.98	CA740IR	14 90			
		01.94- 01.99	CA827IR	14 70			
		01.94- 01.98	CA828IR	14 120			
		01.99- 01.99	CA1549IR	14 120			
		AC 01.94- 01.94	CA740IR	14 90			
	[AEG]	01.99- 01.01	CA1549IR	14 120	01.99- 01.01	CS1119	12 1.1
		01.99- 01.01	CA827IR	14 70	01.01- 01.01	CS1062	12 1.1
	[AVH]	01.02- 01.03	CA1378IR	14 90	01.02- 01.03	CS1119	12 1.1
		01.03- 01.03	CA827IR	14 70	01.02- 01.03	CS1062	12 1.1
	[AZG]	01.02- 01.02	CA1378IR	14 90	01.02- 01.02	CS1062	12 1.1
					01.02- 01.02	CS1119	12 1.1
Jetta 2.0 GLS	[ABA]	01.94- 01.98	CA733IR	14 70	01.94- 01.99	CS618	12 1.1
		01.94- 01.98	CA736IR	14 90	01.99- 01.99	CS1119	12 1.1
		01.94- 01.98	CA740IR	14 90			
		01.94- 01.99	CA827IR	14 70			
		01.94- 01.98	CA828IR	14 120			
		01.99- 01.99	CA1549IR	14 120			
	[AEG]	01.99- 01.00	CA1549IR	14 120	01.99- 01.00	CS1119	12 1.1
		01.99- 01.00	CA827IR	14 70			
Jetta 2.0 GT	[ABA]	01.97- 01.98	CA733IR	14 70	01.97- 01.98	CS618	12 1.1
		01.97- 01.98	CA736IR	14 90			
		01.97- 01.98	CA740IR	14 90			
		01.97- 01.98	CA827IR	14 70			
		01.97- 01.98	CA828IR	14 120			
Jetta 2.0 JAZZ	[ABA]	01.97- 01.97	CA733IR	14 70	01.97- 01.97	CS618	12 1.1
		01.97- 01.97	CA736IR	14 90			
		01.97- 01.97	CA740IR	14 90			
		01.97- 01.97	CA827IR	14 70			
		01.97- 01.97	CA828IR	14 120			
Jetta 2.0 K2	[ABA]	01.98- 01.98	CA733IR	14 70	01.98- 01.98	CS618	12 1.1
		01.98- 01.98	CA736IR	14 90			
		01.98- 01.98	CA740IR	14 90			
		01.98- 01.98	CA827IR	14 70			
		01.98- 01.98	CA828IR	14 120			
Jetta 2.0 Trek	[ABA]	01.96- 01.96	CA733IR	14 70	01.96- 01.96	CS618	12 1.1
		01.96- 01.96	CA736IR	14 90			
		01.96- 01.96	CA740IR	14 90			
		01.96- 01.96	CA827IR	14 70			
		01.96- 01.96	CA828IR	14 120			
Jetta 2.0 Trek II	[ABA]	01.97- 01.97	CA733IR	14 70	01.97- 01.97	CS618	12 1.1
		01.97- 01.97	CA736IR	14 90			
		01.97- 01.97	CA740IR	14 90			



VW Continued

		01.97- 01.97	CA827IR	14 70			
		01.97- 01.97	CA828IR	14 120			
Jetta 2.0 Wolfsburg Edition	[ABA]	01.96- 01.96	CA733IR	14 70	01.96- 01.96	CS618	12 1.1
		01.96- 01.96	CA736IR	14 90			
		01.96- 01.96	CA740IR	14 90			
		01.96- 01.96	CA827IR	14 70			
		01.96- 01.96	CA828IR	14 120			
Jetta 2.0 16V GLI	[9A]	01.90- 01.92	CA521IR	14 90	01.90- 01.92	CS601	12 1.1
Jetta 2.0 16V GTX	[9A]	01.90- 01.92	CA521IR	14 90	01.90- 01.92	CS601	12 1.1
Jetta 2.8 GLS	[AFP]	01.99- 01.02	CA1549IR	14 120			
		01.99- 01.02	CA827IR	14 70			
	[BDF]	01.02- 01.02	CA1549IR	14 120			
		01.02- 01.02	CA827IR	14 70			
Jetta 2.8 GLX	[AFP]	01.99- 01.02	CA1549IR	14 120			
		01.99- 01.02	CA827IR	14 70			
	[BDF]	01.02- 01.02	CA1549IR	14 120			
		01.02- 01.02	CA827IR	14 70			
	[AAA]	01.95- 01.98	CA736IR	14 90	01.95- 01.95	CS295	12 1.7
		01.95- 01.99	CA827IR	14 70			
		01.95- 01.98	CA828IR	14 120			
		01.99- 01.99	CA1549IR	14 120			
Karmann Ghia 1.5	[H]				01.67- 01.69	CS117	12 0.7
					01.67- 01.69	CS62	12 0.7
Karmann Ghia 1.6	[AE]				01.71- 01.73	CS117	12 0.7
					01.71- 01.73	CS62	12 0.7
	[AH]				01.72- 01.74	CS117	12 0.7
					01.72- 01.74	CS62	12 0.7
	[AK]				01.73- 01.74	CS117	12 0.7
					01.73- 01.74	CS62	12 0.7
	[B]				01.70- 01.70	CS117	12 0.7
					01.70- 01.70	CS62	12 0.7
Passat 1.8 Turbo	[AUG]	01.00- 01.01	CA1546IR	14 90	01.00- 01.01	CS612	12 1.1
	[AEB]	01.99- 01.99	CA1139IR	14 90	01.99- 01.99	CS612	12 1.1
	[ATW]	01.00- 01.01	CA1546IR	14 90	01.00- 01.01	CS612	12 1.1
	[AWM]	01.01- 01.03	CA1546IR	14 90	01.01- 01.03	CS612	12 1.1
Passat 1.8 Turbo GLS	[AEB]	01.98- 01.98	CA1139IR	14 90	01.98- 01.98	CS612	12 1.1
Passat 1.9	[AAZ]	01.92- 01.94	CA733IR	14 70	01.92- 01.94	CS295	12 1.7
		01.92- 01.94	CA736IR	14 90			
		01.92- 01.94	CA740IR	14 90			
		01.92- 01.94	CA827IR	14 70			
		01.92- 01.94	CA828IR	14 120			
Passat 1.9 TDi	[1Z]	01.96- 01.96	CA736IR	14 90	01.96- 01.96	CS974	12 1.8
		01.96- 01.96	CA827IR	14 70	01.96- 01.96	CS295	12 1.7
		01.96- 01.96	CA828IR	14 120			
	[AHU]	01.97- 01.97	CA736IR	14 90	01.97- 01.97	CS974	12 1.8
		01.97- 01.97	CA827IR	14 70			
		01.97- 01.97	CA828IR	14 120			
	[ALH]	01.98- 01.98	CA1139IR	14 90			
Passat 2.0	[9A]	01.90- 01.92	CA342IR	14 65	01.90- 01.92	CS601	12 1.1
		01.90- 01.92	CA343IR	14 90			
		01.90- 01.92	CA521IR	14 90			
Passat 2.0 CL	[9A]	01.92- 01.92	CA342IR	14 65	01.92- 01.92	CS618	12 1.1
		01.92- 01.92	CA343IR	14 90	01.92- 01.92	CS619	12 1.1
		01.92- 01.92	CA521IR	14 90			
Passat 2.0 GL	[9A]	01.90- 01.93	CA342IR	14 65	01.90- 01.93	CS601	12 1.1
		01.90- 01.93	CA343IR	14 90			
		01.90- 01.93	CA521IR	14 90			
Passat 2.0 GLS	[ABA]	01.96- 01.96	CA736IR	14 90	01.96- 01.96	CS618	12 1.1
		01.96- 01.96	CA828IR	14 120	01.96- 01.96	CS619	12 1.1
Passat 2.8	[AHA]				01.99- 01.99	CS725	12 1.4
	[ATQ]	01.00- 01.02	CA1546IR	14 90	01.00- 01.02	CS1074	12 1.4
Passat 2.8 4 Motion	[ATQ]	01.01- 01.02	CA1546IR	14 90	01.01- 01.02	CS1074	12 1.4
Passat 2.8 GLS	[AHA]				01.98- 01.98	CS725	12 1.4
	[AAA]	01.93- 01.93	CA736IR	14 90	01.93- 01.93	CS295	12 1.7
		01.93- 01.93	CA827IR	14 70			
		01.93- 01.93	CA828IR	14 120			
Passat 2.8 GLX	[AHA]	01.98- 01.98	CA855IR	14 120	01.98- 01.98	CS725	12 1.4
	[AAA]	01.93- 01.97	CA736IR	14 90	01.93- 01.97	CS295	12 1.7
		01.93- 01.97	CA827IR	14 70			
		01.93- 01.97	CA828IR	14 120			
Passat 2.8 VR6 GLX	[AAA]	01.95- 01.95	CA736IR	14 90	01.95- 01.95	CS295	12 1.7
		01.95- 01.95	CA828IR	14 120			
Quantum 1.6 Turbo Custom	[CY]				01.83- 01.83	CS185	12 1.5
Quantum 1.6 Turbo DLX	[CY]	01.82- 01.83	CA252IR	14 55	01.82- 01.83	CS185	12 1.5
Quantum 1.6 Turbo GL Custom	[CY]				01.84- 01.84	CS185	12 1.5
	[MD]				01.85- 01.85	CS185	12 1.5
Quantum 1.7 Custom	[WT]	01.82- 01.83	CA139IR	14 65	01.82- 01.83	CS297	12 0.95
		01.82- 01.83	CA141IR	14 65	01.82- 01.83	CS293	12 0.8
		01.82- 01.83	CA163IR	14 75			
Quantum 1.7 DLX	[WT]	01.82- 01.83	CA139IR	14 65	01.82- 01.83	CS297	12 0.95
		01.82- 01.83	CA141IR	14 65	01.82- 01.83	CS293	12 0.8
		01.82- 01.83	CA163IR	14 75			
Quantum 2.2	[KM]	01.85- 01.85	CA320IR	14 90	01.85- 01.85	CS282	12 1.1
	[KX]	01.85- 01.87	CA318IR	14 90	01.85- 01.87	CS282	12 1.1
		01.85- 01.87	CA708IR	14 90			
Quantum 2.2 Custom	[WE]	01.83- 01.83	CA163IR	14 75	01.83- 01.83	CS282	12 1.1
Quantum 2.2 GL	[KX]	01.88- 01.88	CA318IR	14 90	01.88- 01.88	CS282	12 1.1
		01.88- 01.88	CA708IR	14 90			
Quantum 2.2 GL Custom	[KM]	01.84- 01.85	CA163IR	14 75	01.84- 01.85	CS282	12 1.1
	[KX]	01.85- 01.87	CA318IR	14 90	01.85- 01.87	CS282	12 1.1
		01.85- 01.87	CA708IR	14 90			
Quantum 2.2 GL Deluxe	[KM]	01.84- 01.84	CA163IR	14 75	01.84- 01.84	CS282	12 1.1
Quantum 2.2 Syncro	[JT]	01.86- 01.87	CA318IR	14 90	01.86- 01.87	CS282	12 1.1
		01.86- 01.87	CA708IR	14 90			
	[KX]	01.88- 01.88	CA318IR	14 90	01.88- 01.88	CS282	12 1.1
		01.88- 01.88	CA708IR	14 90			
Rabbit 1.5	[EH]	01.79- 01.80	CA139IR	14 65	01.79- 01.80	CS276	12 0.7
		01.79- 01.80	CA141IR	14 65	01.79- 01.80	CS116	12 0.8
		01.79- 01.80	CA35IR	14 35			
		01.79- 01.80	CA52IR	14 55			
	[FC]	01.75- 01.75	CA136IR	14 45	01.75- 01.75	CS276	12 0.7
		01.75- 01.75	CA139IR	14 65	01.75- 01.75	CS79	12 0.8
	[FG]	01.75- 01.75	CA136IR	14 45	01.75- 01.75	CS79	12 0.8
		01.75- 01.75	CA139IR	14 65	01.75- 01.75	CS276	12 0.7



	[FX]	01.80- 01.80	CA139IR	14 65		01.80- 01.80	CS116	12 0.8
		01.80- 01.80	CA141IR	14 65		01.80- 01.80	CS276	12 0.7
		01.80- 01.80	CA35IR	14 35				
		01.80- 01.80	CA52IR	14 55				
Rabbit 1.5	[CK]	01.77- 01.80	CA136IR	14 45				
		01.77- 01.80	CA139IR	14 65				
Rabbit 1.6	[EE]	01.77- 01.77	CA139IR	14 65		01.77- 01.77	CS276	12 0.7
		01.77- 01.77	CA141IR	14 65		01.77- 01.77	CS116	12 0.8
		01.77- 01.77	CA35IR	14 35				
		01.77- 01.77	CA52IR	14 55				
	[EJ]	01.80- 01.80	CA139IR	14 65		01.80- 01.80	CS276	12 0.7
		01.80- 01.80	CA141IR	14 65		01.80- 01.80	CS116	12 0.8
		01.80- 01.80	CA35IR	14 35				
		01.80- 01.80	CA52IR	14 55				
	[FN]	01.76- 01.76	CA136IR	14 45		01.76- 01.76	CS116	12 0.8
		01.76- 01.76	CA139IR	14 65		01.76- 01.76	CS276	12 0.7
Rabbit 1.6	[CR]	01.81- 01.83	CA139IR	14 65				
		01.81- 01.83	CA252IR	14 55				
Rabbit 1.6 L	[CR]	01.83- 01.83	CA139IR	14 65				
		01.83- 01.83	CA252IR	14 55				
	[JK]	01.84- 01.84	CA139IR	14 65		01.84- 01.84	CS295	12 1.7
		01.84- 01.84	CA252IR	14 55				
Rabbit 1.6 L Custom	[CR]	01.81- 01.82	CA139IR	14 65				
		01.81- 01.82	CA252IR	14 55				
Rabbit 1.6 LS Custom	[CR]	01.83- 01.83	CA139IR	14 65				
		01.83- 01.83	CA252IR	14 55				
Rabbit 1.6 LS Deluxe	[CR]	01.81- 01.82	CA139IR	14 65				
		01.81- 01.82	CA252IR	14 55				
Rabbit 1.7	[EN]	01.81- 01.83	CA139IR	14 65		01.81- 01.83	CS276	12 0.7
		01.81- 01.83	CA141IR	14 65		01.81- 01.83	CS116	12 0.8
		01.81- 01.83	CA35IR	14 35				
		01.81- 01.83	CA52IR	14 55				
Rabbit 1.7 GL DLX	[EN]	01.83- 01.83	CA139IR	14 65		01.83- 01.83	CS276	12 0.7
		01.83- 01.83	CA141IR	14 65		01.83- 01.83	CS116	12 0.8
		01.83- 01.83	CA35IR	14 35				
		01.83- 01.83	CA52IR	14 55				
Rabbit 1.7 L	[EN]	01.84- 01.84	CA139IR	14 65		01.84- 01.84	CS276	12 0.7
		01.84- 01.84	CA141IR	14 65		01.84- 01.84	CS116	12 0.8
		01.84- 01.84	CA35IR	14 35				
		01.84- 01.84	CA52IR	14 55				
	[JF]	01.83- 01.84	CA139IR	14 65		01.83- 01.84	CS116	12 0.8
		01.83- 01.84	CA141IR	14 65		01.83- 01.84	CS276	12 0.7
		01.83- 01.84	CA35IR	14 35				
		01.83- 01.84	CA52IR	14 55				
Rabbit 1.7 L Custom	[EN]	01.82- 01.82	CA139IR	14 65		01.82- 01.82	CS116	12 0.8
		01.82- 01.82	CA141IR	14 65		01.82- 01.82	CS276	12 0.7
		01.82- 01.82	CA35IR	14 35				
		01.82- 01.82	CA52IR	14 55				
Rabbit 1.7 LS Custom	[EN]	01.83- 01.83	CA139IR	14 65		01.83- 01.83	CS276	12 0.7
		01.83- 01.83	CA141IR	14 65		01.83- 01.83	CS116	12 0.8
		01.83- 01.83	CA35IR	14 35				
		01.83- 01.83	CA52IR	14 55				
Rabbit 1.7 LS Deluxe	[EN]	01.82- 01.82	CA139IR	14 65		01.82- 01.82	CS276	12 0.7
		01.82- 01.82	CA141IR	14 65		01.82- 01.82	CS116	12 0.8
		01.82- 01.82	CA35IR	14 35				
		01.82- 01.82	CA52IR	14 55				
Rabbit 1.8	[JH]	01.83- 01.83	CA139IR	14 65		01.83- 01.84	CS116	12 0.8
		01.83- 01.83	CA141IR	14 65				
		01.83- 01.83	CA35IR	14 35				
		01.83- 01.83	CA52IR	14 55				
		01.84- 01.84	CA242IR	14 65				
		01.84- 01.84	CA320IR	14 90				
Rabbit 1.8 GTI Sport	[JH]	01.83- 01.84	CA139IR	14 65		01.83- 01.84	CS116	12 0.8
		01.83- 01.84	CA141IR	14 65				
		01.83- 01.84	CA35IR	14 35				
		01.83- 01.84	CA52IR	14 55				
Scirocco 1.5	[FC]	01.75- 01.75	CA136IR	14 45		01.75- 01.75	CS79	12 0.8
		01.75- 01.75	CA139IR	14 65		01.75- 01.75	CS276	12 0.7
	[FG]	01.75- 01.75	CA136IR	14 45		01.75- 01.75	CS79	12 0.8
		01.75- 01.75	CA139IR	14 65		01.75- 01.75	CS276	12 0.7
Scirocco 1.6	[EE]	01.77- 01.77	CA139IR	14 65		01.77- 01.77	CS276	12 0.7
		01.77- 01.77	CA141IR	14 65		01.77- 01.77	CS116	12 0.8
		01.77- 01.77	CA35IR	14 35				
		01.77- 01.77	CA52IR	14 55				
	[EJ]	01.79- 01.80	CA139IR	14 65		01.79- 01.80	CS116	12 0.8
		01.79- 01.80	CA141IR	14 65		01.79- 01.80	CS276	12 0.7
		01.79- 01.80	CA35IR	14 35				
		01.79- 01.80	CA52IR	14 55				
	[FN]	01.76- 01.76	CA136IR	14 45		01.76- 01.76	CS116	12 0.8
		01.76- 01.76	CA139IR	14 65		01.76- 01.76	CS276	12 0.7
Scirocco 1.7 DLX	[EN]	01.81- 01.83	CA139IR	14 65		01.81- 01.83	CS276	12 0.7
		01.81- 01.83	CA141IR	14 65		01.81- 01.83	CS116	12 0.8
Scirocco 1.8	[JH]	01.88- 01.88	CA296IR	14 55		01.88- 01.88	CS276	12 0.7
		01.88- 01.88	CA318IR	14 90		01.88- 01.88	CS294	12 0.9
		01.88- 01.88	CA342IR	14 65				
		01.88- 01.88	CA343IR	14 90				
		01.88- 01.88	CA911IR#	14 65				
Scirocco 1.8 DLX	[JH]	01.83- 01.83	CA139IR	14 65		01.84- 01.87	CS294	12 0.9
		01.83- 01.83	CA141IR	14 65		01.83- 01.83	CS116	12 0.8
		01.83- 01.83	CA35IR	14 35		01.83- 01.87	CS276	12 0.7
		01.83- 01.83	CA52IR	14 55				
		01.84- 01.85	CA242IR	14 65				
		01.84- 01.85	CA320IR	14 90				
		01.86- 01.87	CA296IR	14 55				
		01.86- 01.87	CA318IR	14 90				
		01.86- 01.87	CA342IR	14 65				
		01.86- 01.87	CA343IR	14 90				
		01.86- 01.87	CA911IR#	14 65				
Scirocco 1.8 16V	[PL]	01.87- 01.88	CA296IR	14 55		01.87- 01.88	CS294	12 0.9
		01.87- 01.88	CA318IR	14 90		01.87- 01.88	CS276	12 0.7
		01.87- 01.88	CA342IR	14 65				
		01.87- 01.88	CA343IR	14 90				
		01.87- 01.88	CA911IR#	14 65				



**VW Continued**

Squareback 1.6	[P]				01.68- 01.73	<b>CS117</b>	12	0.7
					01.68- 01.73	<b>CS62</b>	12	0.7
	[T]				01.67- 01.73	<b>CS117</b>	12	0.7
					01.67- 01.73	<b>CS62</b>	12	0.7
	[U]				01.68- 01.73	<b>CS117</b>	12	0.7
Super Beetle 1.6	[AE]				01.71- 01.73	<b>CS117</b>	12	0.7
					01.71- 01.73	<b>CS62</b>	12	0.7
	[AH]				01.73- 01.74	<b>CS117</b>	12	0.7
					01.73- 01.74	<b>CS62</b>	12	0.7
	[AJ]				01.75- 01.79	<b>CS117</b>	12	0.7
Thing 1.6	[AF]				01.74- 01.74	<b>CS117</b>	12	0.7
	[AG]				01.73- 01.74	<b>CS117</b>	12	0.7
	[AL]				01.73- 01.74	<b>CS117</b>	12	0.7
	[AM]				01.73- 01.74	<b>CS117</b>	12	0.7
	[H]				01.67- 01.67	<b>CS62</b>	12	0.7
Transporter 1.5					01.63- 01.66	<b>CS62</b>	12	0.7
	[AD]				01.71- 01.71	<b>CS62</b>	12	0.7
	[AE]				01.71- 01.71	<b>CS62</b>	12	0.7
	[AF]				01.71- 01.71	<b>CS62</b>	12	0.7
	[B]				01.69- 01.70	<b>CS62</b>	12	0.7
Transporter 1.6 211	[C]				01.69- 01.70	<b>CS62</b>	12	0.7
	[AD]				01.71- 01.71	<b>CS62</b>	12	0.7
	[AE]				01.71- 01.71	<b>CS62</b>	12	0.7
	[AF]				01.71- 01.71	<b>CS62</b>	12	0.7
	[AD]				01.71- 01.71	<b>CS62</b>	12	0.7
Transporter 1.6 215	[AE]				01.71- 01.71	<b>CS62</b>	12	0.7
	[AF]				01.71- 01.71	<b>CS62</b>	12	0.7
	[AD]				01.71- 01.71	<b>CS62</b>	12	0.7
	[AE]				01.71- 01.71	<b>CS62</b>	12	0.7
	[AF]				01.71- 01.71	<b>CS62</b>	12	0.7
Transporter 1.6 261	[AD]				01.71- 01.71	<b>CS62</b>	12	0.7
	[AE]				01.71- 01.71	<b>CS62</b>	12	0.7
	[AF]				01.71- 01.71	<b>CS62</b>	12	0.7
	[AD]				01.71- 01.71	<b>CS62</b>	12	0.7
	[AE]				01.71- 01.71	<b>CS62</b>	12	0.7
Transporter 1.6 265	[AF]				01.71- 01.71	<b>CS62</b>	12	0.7
	[AD]				01.71- 01.71	<b>CS62</b>	12	0.7
	[AE]				01.71- 01.71	<b>CS62</b>	12	0.7
	[AF]				01.71- 01.71	<b>CS62</b>	12	0.7
	[CA]				01.72- 01.73	<b>CS117</b>	12	0.7
Transporter 1.7					01.72- 01.73	<b>CS62</b>	12	0.7
	[CB]				01.72- 01.73	<b>CS117</b>	12	0.7
					01.72- 01.73	<b>CS62</b>	12	0.7
	[CD]				01.73- 01.73	<b>CS117</b>	12	0.7
					01.73- 01.73	<b>CS62</b>	12	0.7
Transporter 1.7 211	[CE]				01.73- 01.73	<b>CS117</b>	12	0.7
					01.73- 01.73	<b>CS62</b>	12	0.7
	[CA]				01.72- 01.73	<b>CS117</b>	12	0.7
					01.72- 01.73	<b>CS62</b>	12	0.7
	[CB]				01.72- 01.73	<b>CS117</b>	12	0.7
Transporter 1.7 215					01.72- 01.73	<b>CS62</b>	12	0.7
	[CD]				01.73- 01.73	<b>CS117</b>	12	0.7
					01.73- 01.73	<b>CS62</b>	12	0.7
	[CE]				01.73- 01.73	<b>CS117</b>	12	0.7
					01.73- 01.73	<b>CS62</b>	12	0.7
Transporter 1.8	[AP]				01.74- 01.75	<b>CS117</b>	12	0.7
					01.74- 01.75	<b>CS62</b>	12	0.7
	[AW]				01.74- 01.74	<b>CS117</b>	12	0.7
					01.74- 01.74	<b>CS62</b>	12	0.7
	[ED]				01.74- 01.75	<b>CS117</b>	12	0.7
Transporter 1.8 211					01.74- 01.75	<b>CS62</b>	12	0.7
	[AP]				01.74- 01.74	<b>CS117</b>	12	0.7
					01.74- 01.74	<b>CS62</b>	12	0.7
	[AW]				01.74- 01.74	<b>CS117</b>	12	0.7
					01.74- 01.74	<b>CS62</b>	12	0.7
Transporter 1.9	[ED]				01.74- 01.74	<b>CS117</b>	12	0.7
					01.74- 01.74	<b>CS62</b>	12	0.7
	[DH]	01.85- 01.85	<b>CA320IR</b>	14 90	01.85- 01.85	<b>CS131</b>	12	0.8
	[CJ]				01.76- 01.79	<b>CS115</b>	12	0.7
					01.76- 01.79	<b>CS117</b>	12	0.7
Transporter 2.0	[GD]				01.76- 01.77	<b>CS115</b>	12	0.7
					01.76- 01.77	<b>CS117</b>	12	0.7
	[GE]				01.78- 01.79	<b>CS115</b>	12	0.7
					01.78- 01.79	<b>CS117</b>	12	0.7
	[MV]	01.86- 01.91	<b>CA318IR</b>	14 90	01.86- 01.91	<b>CS131</b>	12	0.8
Transporter 2.5	[AAF]	01.93- 01.93	<b>CA736IR</b>	14 90	01.93- 01.93	<b>CS295</b>	12	1.7
		01.93- 01.93	<b>CA827IR</b>	14 70				
		01.93- 01.93	<b>CA828IR</b>	14 120				
		01.93- 01.93	<b>CA139IR</b>	14 65				
Vanagon 1.6	[CS]	01.82- 01.83	<b>CA139IR</b>	14 65	01.82- 01.83	<b>CS358</b>	12	1.7
		01.82- 01.83	<b>CA139IR</b>	14 65	01.82- 01.83	<b>CS358</b>	12	1.7
	[DH]	01.83- 01.85	<b>CA320IR</b>	14 90	01.83- 01.85	<b>CS131</b>	12	0.8
		01.83- 01.85	<b>CA320IR</b>	14 90	01.83- 01.85	<b>CS131</b>	12	0.8
	[CV]	01.80- 01.83	<b>CA205IR</b>	14 45	01.80- 01.80	<b>CS115</b>	12	0.7
Vanagon 1.9					01.80- 01.81	<b>CS117</b>	12	0.7
					01.81- 01.83	<b>CS131</b>	12	0.8
	[CV]	01.80- 01.83	<b>CA205IR</b>	14 45	01.81- 01.83	<b>CS131</b>	12	0.8
					01.80- 01.80	<b>CS115</b>	12	0.7
					01.80- 01.83	<b>CS117</b>	12	0.7
Vanagon 2.0					01.81- 01.83	<b>CS131</b>	12	0.8
					01.80- 01.80	<b>CS115</b>	12	0.7
					01.80- 01.83	<b>CS117</b>	12	0.7
	[CV]	01.81- 01.81	<b>CA205IR</b>	14 45	01.81- 01.81	<b>CS131</b>	12	0.8
					01.81- 01.81	<b>CS117</b>	12	0.7
Vanagon 2.1	[MV]	01.86- 01.91	<b>CA318IR</b>	14 90	01.86- 01.91	<b>CS131</b>	12	0.8
		01.86- 01.91	<b>CA318IR</b>	14 90	01.86- 01.91	<b>CS131</b>	12	0.8
	[MV]	01.86- 01.91	<b>CA318IR</b>	14 90	01.86- 01.91	<b>CS131</b>	12	0.8
		01.86- 01.91	<b>CA318IR</b>	14 90	01.86- 01.91	<b>CS131</b>	12	0.8
	[MV]	01.86- 01.91	<b>CA318IR</b>	14 90	01.86- 01.91	<b>CS131</b>	12	0.8



**PASSENGER CARS AO**

Bora 1.8 4 Motion	[ARX]	10.00- 05.01 10.00- 05.01	CA1378IR CA1436IR	14 90 14 70			
Fox 1.0	[AQZ]	10.03- 04.05 10.03- 04.05 10.03- 04.05 10.03- 04.05	CA1378IR CA1436IR CA1542IR CA1568IR	14 90 BO 14 70 BO 14 90 VA 14 70 VA	10.03- 04.05	CS1197	12 1.1
Fox 1.0 Alcohol	[BNX]	10.03- 04.05 10.03- 04.05 10.03- 10.03-	CA1378IR CA1436IR CA1542IR CA1568IR	14 90 BO 14 70 BO 14 90 VA 14 70 VA			
Fox 1.6	[BAH]	10.03- 10.04 10.03- 10.04	CA1378IR CA1542IR	14 90 BO 14 90 VA	10.03- 10.04	CS1197	12 1.1
Fox 1.6 Alcohol	[BJA]	10.03- 01.05 10.03- 01.05	CA1378IR CA1542IR	14 90 BO 14 90 VA	10.03- 01.05	CS1197	12 1.1
Golf III 1.3 CL	[2G]	08.91- 07.92 08.91- 07.92	CA376IR CA588IR	14 65 14 55	08.91- 07.92	CS293	12 0.8
Golf III 2.0	[AEP]	01.95- 12.97 01.95- 12.97 01.95- 12.97 AC 01.95- 12.97 AC 01.95- 12.97	CA733IR CA740IR CA828IR CA736IR CA827IR	14 70 14 90 14 120 14 90 14 70	01.95- 12.97	CS1062	12 1.1
Golf III 2.0 GL	[AEP]	01.95- 12.97 01.95- 12.97 01.95- 12.97 AC 01.95- 12.97 AC 01.95- 12.97	CA733IR CA740IR CA828IR CA736IR CA827IR	14 70 14 90 14 120 14 90 14 70	01.95- 12.97	CS1062	12 1.1
Golf III 2.8 VR6	[AAA]	07.94- 12.97 07.94- 12.97	CA1142IR CA1402IR	14 120 14 90	AT 07.94- 12.97 07.94- 12.97 07.94- 12.97	CS789 CS620 CS1266	12 1.8 12 1.7 12 1.8
Golf IV 1.9 TDi	[ARL]	06.01- 06.01- 06.01-	CA1394IR CA1446IR CA1502IR	14 120 14 90 14 70	06.01-	CS1181	12 2.0
Golf V 2.5 TDi	[BDG]	10.03- 02.06 10.03- 02.06 10.03- 02.06	CA1546IR CA1588IR CA1746IR	14 90 ▲ 14 120 14 140	10.03- 02.06	CS1114	12 2.0
Multivan 3.2 4 Motion	[BDL]	11.03- 06.06 11.03- 06.06 11.03- 06.06	CA1394IR CA1763IR CA1912IR	14 120 14 150 14 180	11.03- 06.06	CS1323	12 2.0
Passat 1.8	[KR]	08.91- 09.93	CA521IR	14 90	08.91- 09.93 AT 08.91- 09.93	CS601 CS1062	12 1.1 12 1.1
Passat 1.8 GL	[KR]	08.91- 09.93 08.91- 09.93	CA342IR CA521IR	14 65 14 90	08.91- 09.93 AT 08.91- 09.93	CS601 CS1062	12 1.1 12 1.1
Passat 1.8 T	[AWM]	05.02- 08.05 05.02- 08.05 05.02- 08.05	CA1545IR CA1546IR CA1664IR	14 70 14 90 14 120	11.03- 08.05 05.02- 10.03	CS1394 CS612	12 1.2 12 1.1
Passat 1.8 T Syncro	[AEB]	11.96- 08.98 11.96- 08.98 11.96- 08.98 11.96- 08.00 09.98- 08.00 09.98- 08.00 09.98- 08.00	CA1093IR CA1139IR CA1140IR CA1759IR CA1545IR CA1546IR CA1664IR	14 70 14 90 14 120 14 120 14 70 14 90 14 120	11.96- 08.00	CS612	12 1.1
Passat 2.8 Syncro	[AGE]	05.97- 08.98 05.97- 08.98 08.98- 11.00 09.98- 11.00	CA837IR CA855IR CA1546IR CA1588IR	14 90 14 120 14 90 14 120	05.97- 11.00	CS725	12 1.4
Polo 1.6 Sportline	[BAH]	08.02- 05.05 08.02- 05.05	CA1441IR CA1568IR	14 90 14 70	08.02- 05.05	CS1197	12 1.1
Polo 1.8 GTI Cup Edition	[BBU]	05.06- 05.06- 05.06-	CA1378IR CA1394IR CA1436IR	14 90 14 120 14 70	05.06-	CS1294	12 1.1
Santana 1.8	[DS]	08.84- 07.94 08.84- 07.94 08.84- 07.94 08.84- 07.94 08.84- 07.94 08.84- 07.94 08.84- 07.94	CA241IR CA242IR CA296IR CA298IR CA318IR CA320IR CA520IR	14 55 14 65 14 55 14 65 14 90 14 90 14 65	08.84- 07.94	CS297	12 0.95
Transporter 2.5 TDi T5	[BLJ]	11.03- 11.03-	CA1819IR CA1820IR	14 150 14 180	11.03-	CS1405	12 2.2
Transporter 2.8 T4	[AES]	05.96- 05.00 05.96- 05.00 05.96- 05.00	CA1142IR CA1143IR CA1402IR	14 120 14 150 14 90 VA	AT 05.96- 05.00 05.96- 05.00	CS295 CS801	12 1.7 12 1.8
Transporter 2.8 T4 Syncro	[AES]	01.96- 04.96 01.96- 04.96 01.96- 04.96	CA1142IR CA1143IR CA1402IR	14 120 14 150 14 90 VA	AT 01.96- 04.96 01.96- 04.96	CS295 CS801	12 1.7 12 1.8
Transporter 3.2 T5 4 Motion	[BDL]	11.03- 06.06 11.03- 06.06	CA1394IR CA1763IR	14 120 14 150	11.03- 06.06	CS1323	12 2.0
	[BKK]	11.03- 11.03-	CA1394IR CA1763IR	14 120 14 150	11.03-	CS1323	12 2.0
	[CFLA]	11.03- 11.03-	CA1394IR CA1763IR	14 120 14 150	11.03-	CS1323	12 2.0
Transporter 3.2 V6 T5 4 Motion	[BKK]	11.03- 11.03-	CA1394IR CA1763IR	14 120 14 150	11.03-	CS1323	12 2.0
	[CFLA]	11.03- 11.03-	CA1394IR CA1763IR	14 120 14 150	11.03-	CS1323	12 2.0
Vento 2.0 GL	[AEP]	05.96- 12.97 05.96- 12.97 05.96- 12.97 AC 05.96- 12.97 AC 05.96- 12.97	CA733IR CA740IR CA828IR CA736IR CA827IR	14 70 14 90 14 120 14 90 14 70	05.96- 12.97	CS1062	12 1.1
Vento 2.8 VR6	[AAA]	08.95- 04.96 08.95- 04.96	CA1142IR CA1402IR	14 120 14 90	AT 08.95- 04.96 08.95- 04.96	CS620 CS789	12 1.7 12 1.8
<b>Yanmar</b>							
<b>MARINE</b>							
1GM		01.80-	JA116IR	14 35	01.80-	JS1145	12 1.0
2GM			JA986IR	14 55		JS1145	12 1.0
			JA116IR	14 35			
3GM			JA116IR	14 35		JS1145	12 1.0
			JA986IR	14 55			
3HM			JA116IR	14 35			

**YANMAR Continued**

3JH			JA116IR	14	35						
3TN63						10.95-	JS1356	12	0.9		
3TN66						10.95-	JS1356	12	0.9		
3TN68						10.95-	JS1356	12	0.9		
4JH			JA986IR	14	55		JS731	12	1.4		
4LH			JA986IR	14	55						
<b>MOTORS</b>											
Various Models	[3T-7A-7]					01.84-	JS909	12	1.0		
Various Models	[3T72]						JS729	12	1.3		
	[3TNA72]						JS729	12	1.3		
	[3TNA75]						JS729	12	1.3		
<b>Zastava</b>											
<b>PASSENGER CARS EU</b>											
101 1.1	[128A.000]	06.73-	01.90	CA77IR	14	33	06.73-	01.90	CS91	12	0.8
101 1.1 1100	[128A.064]	05.75-	12.93	CA77IR	14	33	05.75-	12.93	CS91	12	0.8
101 1.1 Super	[128AC5000]	07.79-	09.81	CA77IR	14	33	07.79-	09.81	CS91	12	0.8
101 1.3 1100	[128AR000]	07.89-	12.93	CA252IR	14	55	10.81-	12.93	CS91	12	0.8
		07.89-	12.93	CA254IR	14	65					
Yugo 0.9	[9A]	01.85-	06.92	CA307IR	14	45					
Yugo 1.1 60 EFI	[100GL.0.64]	08.91-	12.93	CA127IR	14	45	08.91-	12.93	CS91	12	0.8
		08.91-	12.93	CA252IR	14	55					
	[11E1.064]	08.91-	12.93	CA127IR	14	45	08.91-	12.93	CS91	12	0.8
		08.91-	12.93	CA252IR	14	55					
Yugo 1.1 Florida	[138B.0000]	08.89-	12.93	CA127IR	14	45					
		08.89-	12.93	CA252IR	14	55					
Yugo 1.3	[13E.3.064]	03.91-	12.93	CA252IR	14	55	03.91-	12.93	CS91	12	0.8
		03.91-	12.93	CA254IR	14	65					
Yugo 1.3 65 EFI	[13E1.064]	08.91-	12.93	CA252IR	14	55					
		08.91-	12.93	CA254IR	14	65					
Yugo 1.4 Florida	[160A1.000]	10.88-	06.95	CA252IR	14	55					
		10.88-	06.95	CA254IR	14	65					
Yugo 1.6 Florida	[149A.000]	08.89-	06.95	CA252IR	14	55					
		08.89-	06.95	CA254IR	14	65					
<b>Zetor</b>											
<b>AGRICULTURE</b>											
3321							01.97-	CS944	12	3.0	
3340							01.92-	CS944	12	3.0	
3341							01.97-	CS944	12	3.0	
4718							01.74-	01.81	CS944	12	3.0
7320							01.92-	CS944	12	3.0	
7321							01.92-	CS944	12	3.0	
7340							01.92-	CS944	12	3.0	
7341							01.97-	CS944	12	3.0	
7745 3.9							01.88-	01.03	CS944	12	3.0
12011		01.97-	CA195IR	14	65						
12045		01.97-	CA195IR	14	65						
16045		01.97-	CA195IR	14	65						

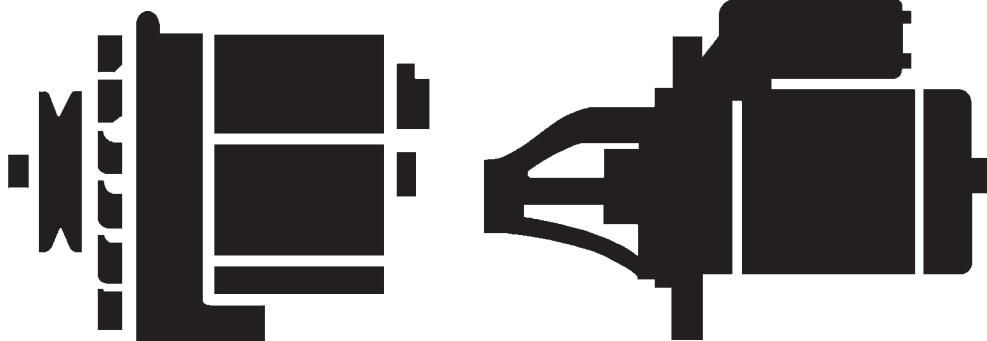

D

**VERGLEICHSLISTE**

DK

**OMSÆTNINGSLISTE**

O.E. nr. - Vort nr.

E

**TABLA DE CONVERSIÓN**

F

**TABEAU DE CORRESPONDANCE**

O.E. No. - Nôtre No.

GB

**CROSS REFERENCE**

FI

**MUUNTOLISTA**

Alkuperä nro - meidän nro

I

**TABELLA DE CORRISPONDENZA**

O.E. No. - Nostro No.

NL

**VERGELIJKINGSTABEL**

O.E. nummer. - Onze nummer

PL

**LISTA ZAMIENNIKÓW**

Numer O.E. - Numer HC

S

**JÄMFÖRELSETABELL**

Original Nr. - Vårt Nr.

O.E. NO.	HC-PARTS	O.E. NO.	HC-PARTS	O.E. NO.	HC-PARTS	O.E. NO.	HC-PARTS
ALFA ROMEO		002/206	CS191	7515426	CA2052IR	12311360491	CA1911R
7691663	CA1055IR	002/306	CS191	7521178	CA1953IR	12311361373	CA1251R
7782314	CA1223IR	002/508	CS191	7523450	CS1413	12311361374	CA1921R
46305329	CA1223IR	002/509	CS191	7523897	CA1867IR	12311361823	CA1921R
46430533	CA1189IR	002/511	CS191	7525376	CA1953IR	12311361824	CA1251R
46445658	CA1223IR	002/601	CS191	7530086	CA1325IR	12311362029	CA1991R
46473784	CS1045	002/608	CS191	7542351	CA2035IR	12311362030	CA1891R
46532667	CA1485IR	002/611	CS191	7542529	CA2009IR	12311362077	CA1221R
46532669	CA1648IR	002/702	CS191	7543083	CA2009IR	12311362276	CA1221R
46544329	CA1558IR	002/703	CS506	7550469	CA2035IR	12311362467	CA1891R
46765836	CA1223IR	002/704	CS191	7551252	CA1325IR	12311362468	CA1991R
46765838	CA1558IR	002/801	CS191	7551256	CA1953IR	12311364399	CA1211R
46769369	CA1223IR	002/802	CS191	7555926	CA1953IR	12311364401	CA1211R
46791692	CS1053	002/803	CS191	7562388	CA2006IR	12311364402	CA1221R
46809068	CA1698IR	002/806	CS191	7570488	CS1445	12311364404	CA1221R
46823543	CS1264	002/808	CS191	7574365	CA2006IR	12311364405	CA1911R
50500728	CA2016IR	002/809	CS191	7575650	CA2006IR	12311364407	CA1911R
51734825	CA2016IR	002/901	CS191	7788680	CS1473	12311403936	CA1332IR
55183906	CS1461	002/902	CS198	7798006	CS1467	12311404153	CA1332IR
55192482	CS1264	002/903	CS191	7799180	CA1904IR	12311405902	CA1332IR
60522387	CS375	002/904	CS191	7802471	CA1904IR	12311405918	CA1332IR
60562973	CS131	002/906	CS191	7804140	CS1467	12311427287	CA1106IR
60562974	CS687	002/907	CS191	7812034	CS1467	12311432831	CA1207IR
60583572	CA1061IR	002/909	CS191	7823700	CS1467	12311432977	CA1256IR
60588395	CA1102IR	002/911	CS191	7823701	CS1467	12311432978	CA1256IR
60604238	CA1492IR	012/810	CS951	7834160	CA1905IR	12311432982	CA1256IR
60613073	CA1102IR	IM18	CS950	8506657	CS1467	12311432986	CA1591IR
60652354	CA1492IR	IM310	CS198	8509198	CS1467	12311432987	CA1591IR
60654127	CA1492IR	IM325	CS710	12311079452	CA1869IR	12311433265	CA1207IR
60672342	CA1688IR	IM326	CS99	12311247287	CA1106IR	12311435423	CA1569IR
60673305	CA1688IR	IM327	CS546	12311247288	CA1398IR	12311435424	CA1569IR
60808773	CS709	IM332	CS99	12311247310	CA1398IR	12311435425	CA1569IR
60808791	CA644IR	IM34/3	CS951	12311247311	CA1106IR	12311435426	CA1569IR
60811651	CA644IR	IM360	CS198	12311247487	CA1261IR	12311435427	CA1580IR
60812058	CA1107IR	IM361	CS121	12311247488	CA1261IR	12311435429	CA1569IR
60812535	CA1223IR	IM362	CS526	12311266660	CA196IR	12311435938	CA1578IR
60812583	CA1208IR	IM37	CS952	12311267401	CA196IR	12311702096	CA1207IR
60812713	CA1216IR	IM380	CS99	12311267461	CA196IR	12311702926	CA1579IR
60813458	CS1124	IM401	CS951	12311270901	CA196IR	12311704081	CA1449IR
60813461	CS1053	IM414	CS1031	12311271663	CA251IR	12311704082	CA1245IR
60814706	CS585	IM502	CS191	12311273131	CA251IR	12311705483	CA1632IR
60814911	CS1045	IM503	CS565	12311276139	CA199IR	12311706056	CA362IR
60815944	CA1698IR	IM504	CS805	12311276164	CA250IR	12311706426	CA542IR
60816045	CA1558IR	IM505	CS544	12311276269	CA196IR	12311710562	CA902IR
60816046	CA1223IR	IM508	CS506	12311277116	CA250IR	12311711203	CA362IR
60816047	CA1216IR	IM509	CS506	12311277216	CA121IR	12311713363	CA541IR
60816083	CS1335	IM510	CS198	12311277217	CA121IR	12311713449	CA503IR
60816557	CA1558IR	IM511	CS502	12311277219	CA199IR	12311713450	CA503IR
60816954	CA1698IR	IM513	CS544	12311277223	CA122IR	12311714581	CA349IR
73501591	CA1995IR	IM522	CS194	12311277226	CA191IR	12311715659	CA1259IR
73503235	CA1885IR	IM528	CS955	12311277229	CA196IR	12311717078	CA541IR
		IM530	CS383	12311277230	CA192IR	12311717575	CA538IR
AUDI → VOLKSWAGEN		IM536	CS384	12311277232	CA125IR	12311718857	CA539IR
		IM543	CS546	12311277239	CA251IR	12311720591	CA540IR
AVF (DELCO - H/MOGURT)		IM544	CS1034	12311277246	CA121IR	12311721134	CA630IR
808002	CS191	IM561	CS699	12311277247	CA122IR	12311721202	CA630IR
001/004	CS198	IM562	CS617	12311277248	CA191IR	12311721229	CA538IR
001/109	CS198	IM601	CS198	12311277249	CA192IR	12311721667	CA608IR
001/504	CS198	IM605	CS526	12311277502	CA125IR	12311721912	CA826IR
001/506	CS198	IM606	CS564	12311277503	CA196IR	12311721915	CA826IR
001/507	CS198	IM623	CS954	12311277504	CA199IR	12311721921	CA1041IR
001/508	CS198	IM642	CS881	12311277505	CA251IR	12311722207	CA539IR
001/605	CS198	IM643	CS1040	12311277581	CA196IR	12311726055	CA547IR
001/609	CS198	IM645	CS121	12311284461	CA251IR	12311726248	CA547IR
001/702	CS198	IM647	CS1284	12311285006	CA251IR	12311726372	CA901IR
001/706	CS198	IM653	CS688	12311285012	CA199IR	12311726602	CA503IR
001/803	CS198	IM801	CS198	12311286612	CA199IR	12311726603	CA503IR
001/806	CS198	VG323	CA1094IR	12311288408	CA251IR	12311726897	CA1073IR
001/809	CS198	VG921/W	CA810IR	12311288409	CA251IR	12311727576	CA1041IR
001/810	CS198	VG986/1/W	CA809IR	12311289403	CA251IR	12311730257	CA362IR
001/811	CS198	VG986W	CA808IR	12311289404	CA251IR	12311730261	CA1054IR
001/903	CS198			12311318079	CA1332IR	12311730580	CA1064IR
001/905	CS198	BMW		12311352279	CA191IR	12311730725	CA1073IR
001/911	CS198	1489995	CS1445	12311352708	CA121IR	12311730753	CA1073IR
002/009	CS191	1517328	CS1445	12311353453	CA191IR	12311733060	CA1259IR
002/010	CS191	1705483	CA1632IR	12311353455	CA191IR	12311733772	CA1259IR
002/103	CS191	7509097	CA1580IR	12311354213	CA121IR	12311734322	CA1042IR
002/105	CS191	7509112	CA1580IR	12311360430	CA191IR	12311735120	CA859IR
		7515029	CA1676IR	12311360431	CA191IR	12311735121	CA859IR



O.E. NO.	HC-PARTS	O.E. NO.	HC-PARTS	O.E. NO.	HC-PARTS	O.E. NO.	HC-PARTS
12311735122.....	CA859IR	12317516098.....	CA1654IR	12317834160.....	CA1905IR	12417521123.....	CS1412
12311735232.....	CA859IR	12317516101.....	CA1660IR	12341735122.....	CA1063IR	12417523450.....	CS1413
12311735234.....	CA859IR	12317516104.....	CA1660IR	12411266463.....	CS516	12417524843.....	CS1413
12311735395.....	CA1091IR ▲	12317516107.....	CA1654IR	12411266737.....	CS119	12417526236.....	CS1412
12311735397.....	CA1054IR	12317516723.....	CA1660IR	12411268127.....	CS74	12417526236.....	CS1412
12311735403.....	CA1073IR	12317519618.....	CA1826IR	12411269696.....	CS119	12417526239.....	CS1413
12311735693.....	CA1054IR	12317519721.....	CA1825IR	12411270966.....	CS74	12417540897.....	CS1417
12311735702.....	CA541IR	12317520495.....	CA1774IR	12411271749.....	CS119	12417550017.....	CS1417
12311735703.....	CA902IR	12317521135.....	CA1825IR	12411272150.....	CS119	12417550975.....	CS1419
12311735705.....	CA902IR	12317521137.....	CA1825IR	12411279747.....	CS377	12417552105.....	CS1417
12311735743.....	CA1064IR	12317521178.....	CA1953IR	12411287788.....	CS378	12417570488.....	CS1445
12311735792.....	CA1064IR ▲	12317521382.....	CA1773IR	12411288166.....	CS378	12417582309.....	CS1417
12311738068.....	CA859IR	12317521383.....	CA1773IR	12411289520.....	CS378	12417589350.....	CS1419
12311738079.....	CA1063IR	12317521384.....	CA1774IR	12411308543.....	CS577	12417589352.....	CS1419
12311738088.....	CA1054IR	12317521385.....	CA1774IR	124113212104.....	CS577	12417589353.....	CS1419
12311738091.....	CA1091IR	12317521488.....	CA1773IR	12411312130.....	CS577	12417785691.....	CS984
12311738351.....	CA1092IR	12317521488.....	CA1773IR	12411317584.....	CS1078	12417785715.....	CS984
12311738508.....	CA897IR	12317521489.....	CA1773IR	12411350042.....	CS74	12417787354.....	CS1328
12311738511.....	CA1073IR	12317521490.....	CA1774IR	12411350236.....	CS76	12417787356.....	CS1328
12311738512.....	CA1073IR	12317522962.....	CA1774IR	12411351042.....	CS76	12417787925.....	CS1171
12311738514.....	CA1091IR	12317523897.....	CA1867IR	12411351233.....	CS74	12417788680.....	CS1473
12311739362.....	CA826IR	12317525376.....	CA1953IR	12411352502.....	CS119	12417788682.....	CS1473
12311739363.....	CA826IR	12317530086.....	CA1325IR	12411352504.....	CS119	12417791335.....	JS1358
12311740624.....	CA1256IR	12317532964.....	CA1773IR	12411355693.....	CS76	12417794952.....	CS1406
12311740629.....	CA1325IR	12317532966.....	CA1774IR	12411361022.....	CS183	12417796892.....	CS1406
12311740633.....	CA1256IR	12317532968.....	CA1773IR	12411361874.....	CS183	12417798006.....	CS1467
12311741135.....	CA1579IR	12317533270.....	CA1774IR	12411402990.....	CS1078	12417798035.....	CS1406
12311741138.....	CA1207IR	12317535097.....	CA1990IR *	12411489994.....	CS1254	12417798036.....	CS1406
12311742910.....	CA1207IR	12317535098.....	CA1990IR *	12411489995.....	CS1445	12417801203.....	CS1466
12311744560.....	CA1064IR	12317541694.....	CA1825IR	12411517328.....	CS1445	12417802508.....	CS1466
12311744561.....	CA1323IR	12317541696.....	CA1825IR	12411711403.....	CS1046	12417803514.....	CS1329
12311744562.....	CA1064IR	12317542351.....	CA2035IR	12411712937.....	CS1067	12417804138.....	CS1466
12311744563.....	CA1092IR	12317542529.....	CA2009IR	12411713898.....	CS515	12417804140.....	CS1467
12311744564.....	CA1064IR	12317543083.....	CA2009IR	12411714750.....	CS516	12417811601.....	CS1466
12311744567.....	CA1092IR	12317546284.....	CA1825IR	12411715230.....	CS119	12417812034.....	CS1467
12311747204.....	CA1245IR	12317550319.....	CA1868IR	12411715238.....	CS516	12417823700.....	CS1467
12311747205.....	CA1449IR	12317550469.....	CA2035IR	12411717174.....	CS119	12417823701.....	CS1467
12311795397.....	CA1054IR	12317550968.....	CA1953IR	12411717175.....	CS183	12418506657.....	CS1467
12312240875.....	CA609IR	12317550997.....	CA1868IR	12411720246.....	CS1046	12418509198.....	CS1467
12312241262.....	CA609IR	12317551252.....	CA1325IR	12411720636.....	CS515	12418620033.....	CS76
12312242248.....	CA894IR	12317551256.....	CA1953IR	12411720663.....	CS515	12418620903.....	CS76
12312244833.....	CA845IR	12317553009.....	CA2006IR	12411720664.....	CS515	12419056639.....	CS76
12312244883.....	CA845IR	12317555926.....	CA1953IR	12411726504.....	CS377	12419069808.....	CS984
12312244884.....	CA845IR	12317559223.....	CA1868IR	12411726508.....	CS377		
12312245576.....	CA1247IR	12317562388.....	CA2006IR	12411729981.....	CS792	BOSCH	
12312245654.....	CA1247IR	12317574365.....	CA2006IR	12411729982.....	CS793	0001106001.....	CS294
12312246070.....	CA1400IR	12317575650.....	CA2006IR	12411735400.....	CS516	0001106002.....	CS294
12312246078.....	CA1400IR	12317575873.....	CA2006IR	12411736921.....	CS792	0001106011.....	CS519
12312246149.....	CA1503IR	12317576513.....	CA1954IR	12411736922.....	CS793	0001106012.....	CS1179
12312246572.....	CA1400IR	12317576514.....	CA1954IR	12411740373.....	CS1067	0001106014.....	CS1241
12312246573.....	CA1400IR	12317787346.....	CA1756IR	12411740374.....	CS1067	0001106015.....	CS519
12312247389.....	CA1559IR	12317788222.....	CA1756IR	12411740375.....	CS1067	0001106016.....	CS610
12312248296.....	CA1584IR	12317788223.....	CA1756IR ▲	12411740379.....	CS1067	0001106017.....	CS1179
12312248297.....	CA1584IR	12317788247.....	CA1756IR	12411740584.....	CS1078	0001106018.....	CS1445
12312249966.....	CA1756IR	12317789980.....	CA1757IR	12412242231.....	CS378	0001106019.....	CS1254
12314487081.....	CA2009IR	12317789981.....	CA1905IR	12412242619.....	CS378	0001106022.....	CS1179
12317501592.....	CA1256IR	12317789983.....	CA1757IR	12412242702.....	CS378	0001106023.....	CS1255
12317501593.....	CA1591IR	12317789984.....	CA1905IR	12412242703.....	CS378	0001106024.....	CS1255
12317501595.....	CA1591IR	12317792072.....	CA1905IR	12412244344.....	CS378	0001106405.....	CS1417
12317501597.....	CA1591IR	12317792092.....	CA1584IR	12412245328.....	CS1048	0001106406.....	CS1417
12317501599.....	CA1591IR	12317796125.....	CA2095IR *	12412246388.....	CS1048	0001107003.....	CS601
12317501690.....	CA1591IR	12317797519.....	CA1904IR	12412246570.....	CS984	0001107004.....	CS601
12317501755.....	CA1591IR	12317797521.....	CA1905IR	12412246571.....	CS984	0001107005.....	CS597
12317508052.....	CA1632IR	12317797522.....	CA1905IR	12412246574.....	CS378	0001107006.....	CS597
12317508054.....	CA1632IR	12317797660.....	CA1757IR	12412247063.....	CS1265	0001107007.....	CS294
12317508258.....	CA1632IR	12317799180.....	CA1904IR	12412247391.....	CS1171	0001107008.....	CS294
12317508286.....	CA1632IR	12317799181.....	CA1904IR	12412247492.....	CS1171	0001107009.....	CS687
12317509097.....	CA1580IR	12317799204.....	CA1905IR	12412249295.....	CS1265	0001107010.....	JS1079
12317509100.....	CA1569IR	12317800308.....	CA2051IR *	12414496934.....	CS1265	0001107011.....	JS1081
12317509102.....	CA1578IR	12317801124.....	CA2100IR *	12417501668.....	CS1067	0001107012.....	CS569
12317509112.....	CA1580IR	12317801173.....	CA2095IR *	12417501738.....	CS1067	0001107013.....	CS569
12317509113.....	CA1569IR	12317802261.....	CA2041IR	12417505979.....	CS1256	0001107014.....	CS724
12317509342.....	CA1676IR	12317802471.....	CA1904IR	12417515390.....	CS1067	0001107015.....	CS727
12317512151.....	CA1654IR ▲	12317802619.....	CA2041IR	12417515390.....	CS1067	0001107016.....	CS790
12317515029.....	CA1676IR	12317802928.....	CA2051IR *	12417515391.....	CS1067	0001107017.....	CS612
12317515030.....	CA1869IR	12317802929.....	CA1905IR	12417515392.....	CS1067	0001107018.....	CS612
12317515030.....	CA1869IR	12317804266.....	CA2100IR *	12417521116.....	CS1412	0001107019.....	CS566
12317515033.....	CA2052IR	12317830791.....	CA1982IR	12417521116.....	CS1412	0001107020.....	CS618
12317515426.....	CA2052IR	12317831436.....	CA1982IR	12417521122.....	CS1412	0001107021.....	CS618

O.E. NO.	HC-PARTS	O.E. NO.	HC-PARTS	O.E. NO.	HC-PARTS	O.E. NO.	HC-PARTS
<b>BOSCH <i>Continued</i></b>							
0001107022.....	<b>CS619</b>	0001107426.....	<b>CS1413</b>	0001108075.....	<b>CS359</b>	0001108167.....	<b>CS680</b>
0001107023.....	<b>CS619</b>	0001107427.....	<b>CS1394</b>	0001108076.....	<b>CS614</b>	0001108169.....	<b>CS1078</b>
0001107025.....	<b>CS880</b>	0001107428.....	<b>CS1394</b>	0001108077.....	<b>CS614</b>	0001108170.....	<b>CS802</b>
0001107026.....	<b>CS880</b>	0001107429.....	<b>CS1334</b>	0001108078.....	<b>CS372</b>	0001108171.....	<b>CS372</b>
0001107027.....	<b>CS724</b>	0001107433.....	<b>JS1236</b>	0001108079.....	<b>CS372</b>	0001108173.....	<b>CS1132</b>
0001107028.....	<b>CS724</b>	0001107434.....	<b>JS1236</b>	0001108080.....	<b>CS1166</b>	0001108174.....	<b>CS1074</b>
0001107030.....	<b>JS1105</b>	0001107435.....	<b>CS1257</b>	0001108081.....	<b>CS375</b>	0001108175.....	<b>CS1074</b>
0001107031.....	<b>CS990</b>	0001107436.....	<b>CS1257</b>	0001108082.....	<b>CS329</b>	0001108176.....	<b>CS715</b>
0001107033.....	<b>CS807</b>	0001107437.....	<b>CS1334</b>	0001108083.....	<b>CS330</b>	0001108177.....	<b>CS982</b>
0001107034.....	<b>CS879</b>	0001107438.....	<b>CS1407</b>	0001108084.....	<b>CS328</b>	0001108178.....	<b>CS982</b>
0001107037.....	<b>CS1075</b>	0001107439.....	<b>CS1407</b>	0001108085.....	<b>CS715</b>	0001108180.....	<b>CS784</b>
0001107038.....	<b>JS1079</b>	0001107440.....	<b>CS1453</b>	0001108086.....	<b>CS551</b>	0001108182.....	<b>CS784</b>
0001107039.....	<b>JS1081</b>	0001107441.....	<b>CS1453</b>	0001108087.....	<b>CS685</b>	0001108183.....	<b>CS594</b>
0001107041.....	<b>CS562</b>	0001107442.....	<b>CS1067</b>	0001108088.....	<b>CS389</b>	0001108184.....	<b>CS372</b>
0001107043.....	<b>CS1050</b>	0001107443.....	<b>CS1067</b>	0001108089.....	<b>CS135</b>	0001108186.....	<b>CS784</b>
0001107044.....	<b>CS727</b>	0001107448.....	<b>CS1450</b>	0001108090.....	<b>CS690</b>	0001108188.....	<b>CS982</b>
0001107045.....	<b>CS879</b>	0001107449.....	<b>CS1450</b>	0001108091.....	<b>CS346</b>	0001108190.....	<b>CS1067</b>
0001107047.....	<b>CS681</b>	0001107450.....	<b>CS1437</b>	0001108092.....	<b>CS878</b>	0001108196.....	<b>CS1256</b>
0001107048.....	<b>CS1075</b>	0001107451.....	<b>CS1437</b>	0001108093.....	<b>CS535</b>	0001108197.....	<b>CS1249</b>
0001107049.....	<b>CS990</b>	0001107490.....	<b>CS1053</b>	0001108094.....	<b>CS615</b>	0001108202.....	<b>CS1264</b>
0001107052.....	<b>CS618</b>	0001107491.....	<b>CS1053</b>	0001108095.....	<b>CS615</b>	0001108204.....	<b>CS1212</b>
0001107053.....	<b>CS618</b>	0001107499.....	<b>CS1050</b>	0001108098.....	<b>CS622</b>	0001108213.....	<b>CS1072</b>
0001107054.....	<b>CS612</b>	0001107500.....	<b>CS1050</b>	0001108099.....	<b>CS332</b>	0001108214.....	<b>CS1072</b>
0001107055.....	<b>CS612</b>	0001107501.....	<b>CS1289</b>	0001108100.....	<b>CS972</b>	0001108217.....	<b>CS1172</b>
0001107056.....	<b>CS879</b>	0001107502.....	<b>CS1289</b>	0001108101.....	<b>CS282</b>	0001108218.....	<b>CS1172</b>
0001107059.....	<b>CS986</b>	0001107508.....	<b>CS1437</b>	0001108102.....	<b>CS282</b>	0001108220.....	<b>CS1074</b>
0001107062.....	<b>CS807</b>	0001107509.....	<b>CS1437</b>	0001108103.....	<b>CS979</b>	0001108221.....	<b>CS1074</b>
0001107063.....	<b>CS566</b>	0001108001.....	<b>CS282</b>	0001108104.....	<b>CS979</b>	0001108222.....	<b>CS1414</b>
0001107066.....	<b>CS1053</b>	0001108002.....	<b>CS282</b>	0001108105.....	<b>JS762</b>	0001108223.....	<b>CS1414</b>
0001107067.....	<b>CS1060</b>	0001108003.....	<b>CS327</b>	0001108106.....	<b>CS685</b>	0001108224.....	<b>CS1264</b>
0001107068.....	<b>CS612</b>	0001108004.....	<b>CS357</b>	0001108107.....	<b>CS680</b>	0001108230.....	<b>CS1067</b>
0001107069.....	<b>CS612</b>	0001108005.....	<b>CS615</b>	0001108109.....	<b>CS328</b>	0001108231.....	<b>CS1067</b>
0001107070.....	<b>CS1064</b>	0001108006.....	<b>CS615</b>	0001108110.....	<b>CS330</b>	0001108234.....	<b>CS1264</b>
0001107071.....	<b>CS1064</b>	0001108009.....	<b>CS282</b>	0001108111.....	<b>CS329</b>	0001108235.....	<b>CS1264</b>
0001107072.....	<b>CS1075</b>	0001108010.....	<b>CS282</b>	0001108112.....	<b>CS542</b>	0001108239.....	<b>CS1264</b>
0001107073.....	<b>CS612</b>	0001108011.....	<b>CS375</b>	0001108113.....	<b>CS725</b>	0001108240.....	<b>CS1264</b>
0001107074.....	<b>CS612</b>	0001108012.....	<b>CS346</b>	0001108114.....	<b>CS725</b>	0001108400.....	<b>CS594</b>
0001107075.....	<b>JS1105</b>	0001108016.....	<b>CS282</b>	0001108115.....	<b>CS516</b>	0001108401.....	<b>CS1067</b>
0001107076.....	<b>CS1272</b>	0001108017.....	<b>CS282</b>	0001108117.....	<b>CS972</b>	0001108402.....	<b>CS1398</b>
0001107077.....	<b>CS1188</b>	0001108018.....	<b>CS377</b>	0001108118.....	<b>CS328</b>	0001108403.....	<b>CS1249</b>
0001107078.....	<b>JS737</b>	0001108019.....	<b>CS1110</b>	0001108119.....	<b>CS328</b>	0001108404.....	<b>CS1249</b>
0001107079.....	<b>JS1024</b>	0001108021.....	<b>CS578</b>	0001108121.....	<b>CS719</b>	0001108405.....	<b>CS1339</b>
0001107080.....	<b>CS1253</b>	0001108023.....	<b>CS359</b>	0001108122.....	<b>CS1070</b>	0001108406.....	<b>CS1339</b>
0001107082.....	<b>CS986</b>	0001108024.....	<b>CS686</b>	0001108123.....	<b>JS942</b>	0001108408.....	<b>CS1404</b>
0001107085.....	<b>CS807</b>	0001108025.....	<b>CS514</b>	0001108124.....	<b>CS327</b>	0001108409.....	<b>CS1249</b>
0001107087.....	<b>CS1050</b>	0001108026.....	<b>CS282</b>	0001108125.....	<b>CS542</b>	0001108410.....	<b>CS1249</b>
0001107088.....	<b>JS1236</b>	0001108027.....	<b>CS282</b>	0001108126.....	<b>CS585</b>	0001108428.....	<b>CS1509</b>
0001107091.....	<b>CS1213</b>	0001108030.....	<b>CS389</b>	0001108127.....	<b>CS615</b>	0001108429.....	<b>CS1509</b>
0001107092.....	<b>JS1079</b>	0001108031.....	<b>CS1036</b>	0001108128.....	<b>CS884</b>	0001108430.....	<b>CS1404</b>
0001107093.....	<b>JS1315</b>	0001108032.....	<b>CS979</b>	0001108129.....	<b>CS807</b>	0001108431.....	<b>CS1404</b>
0001107094.....	<b>CS1259</b>	0001108033.....	<b>CS357</b>	0001108130.....	<b>CS715</b>	0001109001.....	<b>CS500</b>
0001107095.....	<b>CS1259</b>	0001108035.....	<b>CS328</b>	0001108132.....	<b>CS330</b>	0001109002.....	<b>CS500</b>
0001107096.....	<b>CS1075</b>	0001108037.....	<b>CS330</b>	0001108133.....	<b>CS328</b>	0001109014.....	<b>CS1044</b>
0001107097.....	<b>CS1213</b>	0001108038.....	<b>CS346</b>	0001108134.....	<b>CS979</b>	0001109015.....	<b>CS976</b>
0001107098.....	<b>CS1188</b>	0001108039.....	<b>CS330</b>	0001108135.....	<b>JS762</b>	0001109018.....	<b>CS1037</b>
0001107100.....	<b>CS879</b>	0001108040.....	<b>CS329</b>	0001108136.....	<b>CS585</b>	0001109021.....	<b>CS1114</b>
0001107101.....	<b>CS879</b>	0001108042.....	<b>CS577</b>	0001108137.....	<b>CS589</b>	0001109022.....	<b>CS1114</b>
0001107103.....	<b>CS880</b>	0001108043.....	<b>CS500</b>	0001108138.....	<b>CS551</b>	0001109025.....	<b>CS984</b>
0001107104.....	<b>CS880</b>	0001108046.....	<b>CS979</b>	0001108139.....	<b>CS685</b>	0001109026.....	<b>CS1177</b>
0001107108.....	<b>CS879</b>	0001108047.....	<b>CS372</b>	0001108140.....	<b>CS685</b>	0001109030.....	<b>CS1045</b>
0001107109.....	<b>CS1213</b>	0001108048.....	<b>CS585</b>	0001108141.....	<b>CS972</b>	0001109033.....	<b>CS1071</b>
0001107110.....	<b>CS1213</b>	0001108051.....	<b>CS784</b>	0001108143.....	<b>CS784</b>	0001109034.....	<b>JS1135</b>
0001107111.....	<b>CS1213</b>	0001108052.....	<b>CS1036</b>	0001108145.....	<b>CS1078</b>	0001109035.....	<b>CS1471</b>
0001107401.....	<b>CS1257</b>	0001108053.....	<b>CS535</b>	0001108146.....	<b>CS514</b>	0001109036.....	<b>CS1044</b>
0001107402.....	<b>CS1257</b>	0001108056.....	<b>CS1036</b>	0001108148.....	<b>CS802</b>	0001109040.....	<b>CS1049</b>
0001107403.....	<b>CS1075</b>	0001108057.....	<b>CS330</b>	0001108149.....	<b>CS327</b>	0001109041.....	<b>CS1196</b>
0001107404.....	<b>CS1257</b>	0001108061.....	<b>CS135</b>	0001108150.....	<b>CS982</b>	0001109045.....	<b>CS1335</b>
0001107405.....	<b>CS1257</b>	0001108062.....	<b>CS690</b>	0001108151.....	<b>CS372</b>	0001109048.....	<b>CS1212</b>
0001107406.....	<b>CS1283</b>	0001108063.....	<b>CS577</b>	0001108152.....	<b>CS329</b>	0001109052.....	<b>CS976</b>
0001107407.....	<b>CS1050</b>	0001108064.....	<b>CS377</b>	0001108153.....	<b>CS680</b>	0001109055.....	<b>CS976</b>
0001107408.....	<b>CS1257</b>	0001108065.....	<b>CS516</b>	0001108154.....	<b>CS1036</b>	0001109062.....	<b>CS976</b>
0001107409.....	<b>CS1257</b>	0001108066.....	<b>CS979</b>	0001108155.....	<b>CS330</b>	0001109064.....	<b>CS1423</b>
0001107410.....	<b>CS1289</b>	0001108068.....	<b>CS979</b>	0001108156.....	<b>CS1066</b>	0001109065.....	<b>CS1423</b>
0001107411.....	<b>CS1053</b>	0001108069.....	<b>CS979</b>	0001108157.....	<b>CS1067</b>	0001109066.....	<b>CS1114</b>
0001107417.....	<b>CS1050</b>	0001108070.....	<b>JS762</b>	0001108158.....	<b>CS329</b>	0001109067.....	<b>CS1114</b>
0001107418.....	<b>CS1289</b>	0001108071.....	<b>CS329</b>	0001108159.....	<b>CS585</b>	0001109068.....	<b>CS976</b>
0001107423.....	<b>CS1412</b>	0001108072.....	<b>CS282</b>	0001108160.....	<b>CS1190</b>	0001109069.....	<b>CS1466</b>
0001107424.....	<b>CS1412</b>	0001108073.....	<b>CS282</b>	0001108162.....	<b>CS542</b>	0001109070.....	<b>CS1466</b>
0001107425.....	<b>CS1413</b>	0001108074.....	<b>CS542</b>	0001108166.....	<b>CS680</b>	0001109200.....	<b>CS984</b>

O.E. NO.	HC-PARTS	O.E. NO.	HC-PARTS	O.E. NO.	HC-PARTS	O.E. NO.	HC-PARTS
0001109201.....	CS984	0001110067.....	CS624	0001112032.....	JS380	0001121006.....	CS1062
0001109204.....	CS1408	0001110069.....	CS620	0001112033.....	CS592	0001121007.....	CS1062
0001109205.....	CS1421	0001110070.....	CS620	0001112035.....	CS519	0001121008.....	CS1119
0001109250.....	CS1044	0001110071.....	CS793	0001112037.....	CS592	0001121009.....	CS1119
0001109252.....	CS1271	0001110072.....	CS792	0001112038.....	CS618	0001121010.....	CS1176
0001109253.....	CS1335	0001110075.....	CS360	0001112039.....	CS618	0001121011.....	CS1176
0001109258.....	CS1411	0001110076.....	CS713	0001112041.....	CS581	0001121016.....	CS1197
0001109259.....	CS1411	0001110077.....	CS713	0001112044.....	CS788	0001121017.....	CS1197
0001109264.....	CS1271	0001110079.....	CS1054	0001112045.....	CS788	0001121018.....	CS1475
0001109268.....	CS1335	0001110081.....	CS888	0001113001.....	CS293	0001121019.....	CS1475
0001109269.....	CS1335	0001110082.....	CS374	0001113002.....	CS293	0001121022.....	CS1337
0001109270.....	CS1335	0001110084.....	CS616	0001113003.....	CS592	0001121023.....	CS1337
0001109300.....	CS1389	0001110085.....	CS616	0001113004.....	CS131	0001121024.....	CS1475
0001109301.....	CS1389	0001110086.....	CS620	0001113005.....	CS592	0001121025.....	CS1475
0001109302.....	CS1449	0001110087.....	CS620	0001113006.....	CS796	0001121026.....	CS1119
0001109303.....	CS1449	0001110088.....	CS341	0001113007.....	CS723	0001121027.....	CS1119
0001109304.....	CS1421	0001110089.....	CS684	0001113008.....	CS723	0001121028.....	CS1062
0001109305.....	CS1421	0001110090.....	CS1049	0001113009.....	CS592	0001121029.....	CS1062
0001109306.....	CS1203	0001110091.....	CS360	0001113010.....	CS960	0001121030.....	CS1063
0001109307.....	CS1203	0001110092.....	CS1037	0001113013.....	CS788	0001121031.....	CS1063
0001109310.....	CS1271	0001110095.....	CS684	0001113014.....	CS788	0001121034.....	CS1063
0001109311.....	CS1271	0001110098.....	CS713	0001113017.....	CS960	0001121035.....	CS1063
0001109313.....	CS1449	0001110099.....	CS713	0001114003.....	CS509	0001121402.....	CS1347
0001109324.....	CS1421	0001110100.....	CS1041	0001114004.....	CS509	0001121403.....	CS1347
0001109325.....	CS1421	0001110101.....	CS1041	0001114005.....	CS294	0001121408.....	CS1294
0001109328.....	CS1421	0001110102.....	CS1037	0001114006.....	CS294	0001121409.....	CS1294
0001109329.....	CS1421	0001110104.....	CS341	0001114008.....	CS562	0001121410.....	CS1322
0001109334.....	CS1449	0001110105.....	CS341	0001114009.....	CS559	0001121411.....	CS1322
0001109335.....	CS1449	0001110106.....	CS624	0001114010.....	CS559	0001121412.....	CS1409
0001109340.....	CS1408	0001110107.....	CS624	0001114014.....	CS592	0001121413.....	CS1409
0001109341.....	CS1408	0001110108.....	CS624	0001114015.....	CS509	0001123001.....	CS1440
0001109364.....	CS885	0001110110.....	CS1048	0001114016.....	CS509	0001123002.....	CS1327
0001109371.....	CS1203	0001110112.....	CS360	0001114017.....	CS562	0001123003.....	CS1327
0001109387.....	CS1421	0001110113.....	CS583	0001114020.....	CS592	0001123012.....	CS1293
0001109388.....	CS1421	0001110114.....	CS684	0001114021.....	CS562	0001123013.....	CS1293
0001109389.....	CS1408	0001110115.....	CS322	0001115002.....	CS1113	0001123014.....	CS1323
0001110001.....	CS295	0001110118.....	CS620	0001115005.....	CS1072	0001123015.....	CS1323
0001110002.....	CS295	0001110119.....	CS620	0001115008.....	CS1172	0001123016.....	CS1286
0001110003.....	CS684	0001110120.....	CS1049	0001115011.....	CS888	0001123017.....	CS1286
0001110005.....	CS286	0001110122.....	CS624	0001115012.....	CS1250	0001123018.....	CS1393
0001110007.....	CS606	0001110123.....	CS624	0001115013.....	CS888	0001123019.....	CS1393
0001110008.....	CS606	0001110124.....	CS1037	0001115015.....	CS1247	0001123020.....	CS1397
0001110009.....	CS358	0001110125.....	CS1059	0001115020.....	CS1247	0001123021.....	CS1397
0001110010.....	CS358	0001110126.....	CS624	0001115021.....	CS1045	0001123036.....	CS1286
0001110011.....	CS588	0001110127.....	CS624	0001115024.....	CS1250	0001123037.....	CS1286
0001110012.....	CS322	0001110128.....	CS624	0001115025.....	CS1045	0001123038.....	CS1323
0001110013.....	CS341	0001110129.....	CS624	0001115040.....	CS1406	0001123039.....	CS1323
0001110014.....	CS295	0001110132.....	JS1135	0001115041.....	CS1406	0001124001.....	CS974
0001110015.....	CS295	0001110133.....	CS295	0001115045.....	CS1406	0001124002.....	CS974
0001110016.....	CS360	0001110134.....	CS295	0001115046.....	CS1406	0001124003.....	CS789
0001110017.....	CS373	0001110136.....	CS624	0001115047.....	CS1410	0001124004.....	CS789
0001110019.....	CS341	0001110137.....	CS624	0001115048.....	CS1410	0001124005.....	CS801
0001110022.....	CS548	0001110138.....	CS624	0001115049.....	CS1072	0001124006.....	CS801
0001110023.....	CS548	0001110139.....	CS624	0001115050.....	CS1072	0001124007.....	CS988
0001110025.....	CS374	0001112003.....	CS294	0001115068.....	CS1466	0001124008.....	CS988
0001110026.....	CS684	0001112004.....	CS294	0001115069.....	CS1466	0001124011.....	CS988
0001110029.....	CS985	0001112005.....	CS569	0001115070.....	CS1072	0001124012.....	CS988
0001110030.....	CS985	0001112006.....	CS569	0001115071.....	CS1072	0001124013.....	CS1047
0001110031.....	CS574	0001112007.....	CS390	0001115074.....	CS1410	0001124014.....	CS1047
0001110032.....	CS574	0001112008.....	CS162	0001115075.....	CS1410	0001124015.....	CS1440
0001110039.....	CS583	0001112009.....	CS562	0001116001.....	CS1057	0001124018.....	CS1194
0001110041.....	CS515	0001112010.....	CS559	0001116003.....	CS1111	0001124019.....	CS1194
0001110042.....	CS515	0001112011.....	CS559	0001116005.....	CS796	0001124020.....	CS1208
0001110043.....	CS341	0001112012.....	CS592	0001116006.....	JS1226	0001124021.....	CS1208
0001110045.....	CS548	0001112013.....	CS569	0001116008.....	JS1307	0001124022.....	CS988
0001110046.....	CS548	0001112014.....	CS569	0001116009.....	JS1305	0001124023.....	CS988
0001110048.....	CS300	0001112015.....	CS1183	0001117008.....	CS295	0001124024.....	CS988
0001110049.....	CS300	0001112016.....	CS592	0001120400.....	CS1282	0001124025.....	CS988
0001110051.....	CS541	0001112017.....	JS1016	0001120401.....	CS1282	0001124026.....	CS988
0001110053.....	CS583	0001112018.....	JS305	0001120402.....	CS1343	0001124027.....	CS988
0001110055.....	CS322	0001112019.....	CS581	0001120403.....	CS1343	0001125001.....	CS801
0001110056.....	CS373	0001112020.....	CS609	0001120406.....	CS1330	0001125002.....	CS801
0001110059.....	CS888	0001112021.....	CS723	0001120407.....	CS1330	0001125005.....	CS789
0001110061.....	CS598	0001112022.....	CS723	0001120408.....	CS1324	0001125006.....	CS789
0001110062.....	CS598	0001112024.....	CS285	0001120409.....	CS1324	0001125007.....	CS974
0001110063.....	CS600	0001112025.....	CS980	0001120410.....	CS1322	0001125008.....	CS974
0001110064.....	CS341	0001112027.....	CS788	0001120411.....	CS1322	0001125009.....	CS1266
0001110065.....	CS541	0001112028.....	CS788	0001121001.....	CS1063	0001125010.....	CS1266
0001110066.....	CS624	0001112029.....	CS581	0001121002.....	CS1063	0001125011.....	CS801

O.E. NO.	HC-PARTS	O.E. NO.	HC-PARTS	O.E. NO.	HC-PARTS	O.E. NO.	HC-PARTS
<b>BOSCH <i>Continued</i></b>							
0001125012.....	<b>CS974</b>	0001208019.....	<b>CS69</b>	0001208526.....	<b>CS310</b>	0001211529.....	<b>CS293</b>
0001125013.....	<b>CS974</b>	0001208020.....	<b>CS69</b>	0001208528.....	<b>CS310</b>	0001211530.....	<b>CS293</b>
0001125016.....	<b>CS1209</b>	0001208026.....	<b>CS83</b>	0001208702.....	<b>CS130</b>	0001211533.....	<b>CS78</b>
0001125017.....	<b>CS1209</b>	0001208027.....	<b>CS69</b>	0001208706.....	<b>CS78</b>	0001211535.....	<b>CS123</b>
0001125018.....	<b>CS1181</b>	0001208028.....	<b>CS69</b>	0001208707.....	<b>CS326</b>	0001211536.....	<b>CS371</b>
0001125019.....	<b>CS1181</b>	0001208030.....	<b>CS69</b>	0001208709.....	<b>CS297</b>	0001211987.....	<b>CS180</b>
0001125021.....	<b>CS1200</b>	0001208031.....	<b>CS69</b>	0001208710.....	<b>CS297</b>	0001211988.....	<b>CS131</b>
0001125022.....	<b>CS1200</b>	0001208032.....	<b>CS74</b>	0001208711.....	<b>CS297</b>	0001211989.....	<b>CS78</b>
0001125031.....	<b>CS801</b>	0001208033.....	<b>CS83</b>	0001208712.....	<b>CS297</b>	0001211991.....	<b>CS69</b>
0001125032.....	<b>CS801</b>	0001208038.....	<b>CS70</b>	0001208713.....	<b>CS297</b>	0001211992.....	<b>CS62</b>
0001125035.....	<b>CS1287</b>	0001208039.....	<b>CS70</b>	0001208714.....	<b>CS297</b>	0001211993.....	<b>CS62</b>
0001125036.....	<b>CS1287</b>	0001208040.....	<b>CS69</b>	0001208715.....	<b>CS78</b>	0001211995.....	<b>CS69</b>
0001125039.....	<b>CS1266</b>	0001208041.....	<b>CS69</b>	0001208717.....	<b>CS310</b>	0001211996.....	<b>CS69</b>
0001125040.....	<b>CS1266</b>	0001208050.....	<b>CS69</b>	0001208718.....	<b>CS78</b>	0001211997.....	<b>CS62</b>
0001125042.....	<b>CS974</b>	0001208053.....	<b>CS70</b>	0001211006.....	<b>CS69</b>	0001211998.....	<b>CS62</b>
0001125043.....	<b>CS974</b>	0001208054.....	<b>CS70</b>	0001211007.....	<b>CS69</b>	0001212002.....	<b>CS117</b>
0001125046.....	<b>CS1209</b>	0001208055.....	<b>CS69</b>	0001211010.....	<b>CS69</b>	0001212005.....	<b>CS117</b>
0001125047.....	<b>CS1209</b>	0001208056.....	<b>CS83</b>	0001211011.....	<b>CS69</b>	0001212006.....	<b>CS117</b>
0001125048.....	<b>CS1181</b>	0001208058.....	<b>CS83</b>	0001211012.....	<b>CS62</b>	0001212007.....	<b>CS117</b>
0001125049.....	<b>CS1181</b>	0001208060.....	<b>CS83</b>	0001211013.....	<b>CS62</b>	0001212008.....	<b>CS117</b>
0001125051.....	<b>CS1200</b>	0001208061.....	<b>CS83</b>	0001211014.....	<b>CS62</b>	0001212012.....	<b>CS117</b>
0001125052.....	<b>CS1200</b>	0001208172.....	<b>CS278</b>	0001211018.....	<b>CS69</b>	0001212206.....	<b>CS276</b>
0001125053.....	<b>CS1392</b>	0001208200.....	<b>CS83</b>	0001211019.....	<b>CS69</b>	0001212207.....	<b>CS276</b>
0001125054.....	<b>CS1392</b>	0001208201.....	<b>CS83</b>	0001211204.....	<b>CS77</b>	0001212208.....	<b>CS117</b>
0001125055.....	<b>CS1435</b>	0001208202.....	<b>CS70</b>	0001211205.....	<b>CS77</b>	0001212209.....	<b>CS117</b>
0001125056.....	<b>CS1435</b>	0001208203.....	<b>CS93</b>	0001211206.....	<b>CS78</b>	0001212211.....	<b>CS531</b>
0001125501.....	<b>CS1165</b>	0001208204.....	<b>CS74</b>	0001211207.....	<b>CS180</b>	0001212212.....	<b>CS531</b>
0001125502.....	<b>CS1165</b>	0001208205.....	<b>CS93</b>	0001211208.....	<b>CS180</b>	0001212213.....	<b>CS531</b>
0001125503.....	<b>CS1115</b>	0001208206.....	<b>CS69</b>	0001211209.....	<b>CS77</b>	0001212214.....	<b>CS531</b>
0001125504.....	<b>CS1115</b>	0001208208.....	<b>CS83</b>	0001211210.....	<b>CS77</b>	0001212400.....	<b>CS392</b>
0001125507.....	<b>CS1187</b>	0001208209.....	<b>CS170</b>	0001211213.....	<b>CS79</b>	0001212401.....	<b>CS392</b>
0001125508.....	<b>CS1187</b>	0001208211.....	<b>CS352</b>	0001211214.....	<b>CS79</b>	0001212402.....	<b>CS531</b>
0001125511.....	<b>CS1165</b>	0001208213.....	<b>CS168</b>	0001211215.....	<b>CS131</b>	0001212403.....	<b>CS531</b>
0001125512.....	<b>CS1165</b>	0001208214.....	<b>CS93</b>	0001211216.....	<b>CS79</b>	0001212404.....	<b>CS338</b>
0001125513.....	<b>CS1115</b>	0001208216.....	<b>CS83</b>	0001211217.....	<b>CS79</b>	0001212405.....	<b>CS361</b>
0001125514.....	<b>CS1115</b>	0001208217.....	<b>CS83</b>	0001211218.....	<b>CS77</b>	0001212406.....	<b>CS386</b>
0001125517.....	<b>CS1187</b>	0001208218.....	<b>CS139</b>	0001211219.....	<b>CS77</b>	0001212407.....	<b>CS386</b>
0001125518.....	<b>CS1187</b>	0001208219.....	<b>CS78</b>	0001211220.....	<b>CS77</b>	0001212408.....	<b>CS331</b>
0001125600.....	<b>CS1378</b>	0001208220.....	<b>CS181</b>	0001211221.....	<b>CS115</b>	0001212409.....	<b>CS507</b>
0001125601.....	<b>CS1378</b>	0001208223.....	<b>CS278</b>	0001211222.....	<b>CS115</b>	0001212410.....	<b>CS376</b>
0001125605.....	<b>CS1405</b>	0001208224.....	<b>CS263</b>	0001211223.....	<b>CS116</b>	0001212411.....	<b>CS378</b>
0001125606.....	<b>CS1405</b>	0001208226.....	<b>CS142</b>	0001211224.....	<b>CS116</b>	0001212412.....	<b>CS504</b>
0001138001.....	<b>CS1419</b>	0001208227.....	<b>CS170</b>	0001211227.....	<b>CS123</b>	0001212413.....	<b>CS356</b>
0001138002.....	<b>CS1419</b>	0001208228.....	<b>CS142</b>	0001211228.....	<b>CS78</b>	0001212414.....	<b>CS350</b>
0001139001.....	<b>CS1467</b>	0001208229.....	<b>CS70</b>	0001211229.....	<b>CS69</b>	0001212415.....	<b>CS350</b>
0001139002.....	<b>CS1467</b>	0001208232.....	<b>CS278</b>	0001211230.....	<b>CS79</b>	0001212416.....	<b>CS351</b>
0001139015.....	<b>CS1467</b>	0001208233.....	<b>CS131</b>	0001211231.....	<b>CS79</b>	0001212417.....	<b>CS576</b>
0001139016.....	<b>CS1467</b>	0001208405.....	<b>CS154</b>	0001211233.....	<b>CS79</b>	0001212418.....	<b>CS386</b>
0001139025.....	<b>CS1485</b>	0001208406.....	<b>CS93</b>	0001211234.....	<b>CS79</b>	0001212419.....	<b>CS350</b>
0001139026.....	<b>CS1485</b>	0001208408.....	<b>CS275</b>	0001211235.....	<b>CS79</b>	0001212420.....	<b>CS370</b>
0001148009.....	<b>CS1467</b>	0001208409.....	<b>CS278</b>	0001211236.....	<b>CS79</b>	0001212421.....	<b>CS361</b>
0001148010.....	<b>CS1467</b>	0001208411.....	<b>CS267</b>	0001211237.....	<b>CS181</b>	0001212422.....	<b>CS331</b>
0001155009.....	<b>CS66</b>	0001208412.....	<b>CS267</b>	0001211239.....	<b>CS181</b>	0001212423.....	<b>CS343</b>
0001155010.....	<b>CS66</b>	0001208414.....	<b>CS267</b>	0001211241.....	<b>CS156</b>	0001212424.....	<b>CS611</b>
0001155016.....	<b>CS66</b>	0001208416.....	<b>CS294</b>	0001211242.....	<b>CS133</b>	0001212425.....	<b>CS510</b>
0001155017.....	<b>CS66</b>	0001208417.....	<b>CS294</b>	0001211246.....	<b>CS285</b>	0001212426.....	<b>CS378</b>
0001157001.....	<b>CS66</b>	0001208418.....	<b>CS294</b>	0001211247.....	<b>CS77</b>	0001212427.....	<b>CS1046</b>
0001157002.....	<b>CS66</b>	0001208419.....	<b>CS294</b>	0001211248.....	<b>CS77</b>	0001212428.....	<b>CS794</b>
0001157003.....	<b>CS66</b>	0001208422.....	<b>CS393</b>	0001211251.....	<b>CS298</b>	0001212429.....	<b>CS370</b>
0001157004.....	<b>CS66</b>	0001208423.....	<b>CS278</b>	0001211252.....	<b>CS298</b>	0001212430.....	<b>CS351</b>
0001157008.....	<b>CS397</b>	0001208425.....	<b>CS683</b>	0001211253.....	<b>CS298</b>	0001212431.....	<b>CS510</b>
0001157009.....	<b>CS66</b>	0001208426.....	<b>CS683</b>	0001211254.....	<b>CS298</b>	0001212432.....	<b>CS721</b>
0001157010.....	<b>CS66</b>	0001208428.....	<b>CS683</b>	0001211255.....	<b>CS116</b>	0001212433.....	<b>CS613</b>
0001157012.....	<b>CS66</b>	0001208429.....	<b>CS683</b>	0001211256.....	<b>CS116</b>	0001212434.....	<b>CS343</b>
0001157013.....	<b>CS66</b>	0001208501.....	<b>CS69</b>	0001211257.....	<b>CS294</b>	0001212435.....	<b>CS331</b>
0001157021.....	<b>CS141</b>	0001208506.....	<b>CS168</b>	0001211258.....	<b>CS294</b>	0001212436.....	<b>CS794</b>
0001157022.....	<b>CS122</b>	0001208507.....	<b>CS352</b>	0001211259.....	<b>CS77</b>	0001212437.....	<b>CS576</b>
0001157024.....	<b>CS162</b>	0001208508.....	<b>CS130</b>	0001211502.....	<b>CS79</b>	0001212438.....	<b>CS386</b>
0001157025.....	<b>CS66</b>	0001208510.....	<b>CS316</b>	0001211503.....	<b>CS79</b>	0001212439.....	<b>CS386</b>
0001157028.....	<b>CS162</b>	0001208513.....	<b>CS78</b>	0001211504.....	<b>CS297</b>	0001212440.....	<b>CS350</b>
0001157029.....	<b>CS66</b>	0001208514.....	<b>CS181</b>	0001211505.....	<b>CS297</b>	0001212441.....	<b>CS350</b>
0001157030.....	<b>CS162</b>	0001208515.....	<b>CS310</b>	0001211512.....	<b>CS123</b>	0001212442.....	<b>CS350</b>
0001207001.....	<b>CS60</b>	0001208516.....	<b>CS326</b>	0001211513.....	<b>CS78</b>	0001212443.....	<b>CS599</b>
0001207005.....	<b>CS60</b>	0001208517.....	<b>CS310</b>	0001211514.....	<b>CS69</b>	0001212444.....	<b>CS599</b>
0001207016.....	<b>CS61</b>	0001208518.....	<b>CS355</b>	0001211515.....	<b>CS181</b>	0001212445.....	<b>CS709</b>
0001207017.....	<b>CS61</b>	0001208519.....	<b>CS181</b>	0001211525.....	<b>CS293</b>	0001212446.....	<b>CS504</b>
0001207018.....	<b>CS61</b>	0001208520.....	<b>CS708</b>	0001211526.....	<b>CS293</b>	0001212447.....	<b>CS356</b>
0001207019.....	<b>CS61</b>	0001208521.....	<b>CS78</b>	0001211527.....	<b>CS79</b>	0001212448.....	<b>CS611</b>
0001208009.....	<b>CS83</b>	0001208524.....	<b>CS708</b>	0001211528.....	<b>CS79</b>	0001212449.....	<b>CS507</b>

O.E. NO.	HC-PARTS	O.E. NO.	HC-PARTS	O.E. NO.	HC-PARTS	O.E. NO.	HC-PARTS
0001218127	CS721	0001231033	CS1112	0001311145	CS80	0001359045	CS106
0001218128	CS613	0001231036	CS1486	0001311146	CS292	0001359046	CS103
0001218129	CS343	0001231040	CS1486	0001311147	CS292	0001359049	CS103
0001218130	CS386	0001231041	CS1331	0001311149	CS86	0001359069	CS106
0001218131	CS376	0001231045	CS1382	0001311150	CS119	0001359073	CS103
0001218133	CS709	0001241001	CS1399	0001311151	CS183	0001359074	CS503
0001218134	CS378	0001241003	CS1380	0001312001	CS957	0001359075	CS511
0001218135	CS1046	0001241007	CS1380	0001312100	CS508	0001359078	CS103
0001218141	CS554	0001241014	CS1380	0001312102	CS547	0001359082	CS339
0001218145	CS376	0001241015	CS1420	0001312108	CS348	0001359083	CS718
0001218146	CS709	0001241019	CS1380	0001312109	CS348	0001359084	CS186
0001218147	CS709	0001241020	CS1420	0001312110	CS508	0001359090	CS395
0001218150	CS331	0001261001	CS1399	0001312111	CS547	0001359091	CS240
0001218151	CS782	0001261002	CS1399	0001313001	CS81	0001359095	CS607
0001218152	CS1201	0001261007	CS1420	0001313003	CS81	0001359102	CS240
0001218153	CS1055	0001261008	CS1420	0001313005	CS81	0001359106	CS266
0001218154	CS351	0001261012	CS1420	0001313007	CS81	0001359107	CS1121
0001218155	CS504	0001261013	CS1420	0001314002	CS81	0001359108	CS335
0001218156	CS1162	0001261026	CS1399	0001314005	CS311	0001359110	CS339
0001218157	CS885	0001305016	CS140	0001314012	CS136	0001359111	CS605
0001218158	CS611	0001307024	CS959	0001314013	CS136	0001359119	CS783
0001218159	CS973	0001310007	CS60	0001314014	CS185	0001359122	CS682
0001218160	CS794	0001310008	CS60	0001314015	CS185	0001359124	CS604
0001218162	CS1162	0001311001	CS140	0001314018	CS81	0001359128	CS266
0001218163	CS370	0001311016	CS76	0001314022	CS273	0001359217	CS266
0001218164	CS782	0001311023	CS72	0001314025	CS119	0001360010	CS97
0001218165	CS331	0001311024	CS72	0001314026	CS286	0001360012	CS530
0001218166	JS1088	0001311025	CS76	0001314027	CS268	0001360014	CS530
0001218167	CS370	0001311027	CS140	0001314029	CS311	0001360015	CS232
0001218168	CS1201	0001311028	CS80	0001314030	CS311	0001360022	CS120
0001218171	CS378	0001311029	CS80	0001314032	CS119	0001360023	CS726
0001218172	CS1185	0001311030	CS80	0001314033	CS81	0001360026	CS388
0001218173	CS1051	0001311031	CS80	0001314034	CS342	0001360035	CS530
0001218174	CS1118	0001311032	CS140	0001314035	CS268	0001360036	CS726
0001218175	CS611	0001311033	CS72	0001314036	CS268	0001360037	CS120
0001218177	CS1180	0001311034	CS72	0001314037	CS300	0001360038	CS97
0001218620	CS361	0001311037	CS72	0001314038	CS300	0001360043	CS232
0001218710	CS576	0001311038	CS86	0001314043	CS119	0001360049	CS101
0001218715	CS350	0001311039	CS118	0001314047	CS1340	0001360050	CS608
0001218725	CS611	0001311041	CS132	0001315002	CS957	0001360052	CS120
0001218728	CS613	0001311042	CS119	0001317006	CS299	0001360058	CS388
0001218741	CS554	0001311044	CS184	0001317007	CS185	0001360061	CS391
0001218757	CS885	0001311045	CS76	0001317008	CS185	0001360063	CS394
0001218765	CS331	0001311046	CS72	0001317009	CS272	0001360065	CS120
0001218768	CS1201	0001311048	CS86	0001317010	CS272	0001362001	CS188
0001218771	CS378	0001311049	CS72	0001317011	CS299	0001362002	CS188
0001218772	CS1185	0001311056	CS959	0001317012	CS299	0001362003	CS113
0001218774	CS1118	0001311100	CS119	0001317013	CS290	0001362004	CS113
0001218818	JS568	0001311101	CS72	0001317016	CS299	0001362005	CS128
0001223001	CS885	0001311103	CS140	0001317017	CS299	0001362006	CS128
0001223002	CS1185	0001311104	CS140	0001317018	CS272	0001362008	CS109
0001223003	CS1203	0001311105	CS135	0001317019	CS272	0001362012	CS707
0001223005	CS1202	0001311106	CS690	0001317022	CS290	0001362014	CS124
0001223007	CS1203	0001311108	CS89	0001317023	CS325	0001362015	CS124
0001223013	CS1198	0001311109	CS72	0001317025	CS290	0001362016	CS114
0001223014	CS1326	0001311110	CS334	0001330008	CS1400	0001362025	CS550
0001223024	CS1203	0001311111	CS334	0001354038	CS995	◆ 0001362027	CS113
0001223504	CS572	0001311112	CS80	0001354073	CS503	◆ 0001362028	CS113
0001230002	CS1376	0001311113	CS86	0001354080	CS503	◆ 0001362029	CS188
0001230006	CS1130	0001311114	CS140	0001354100	CS707	◆ 0001362030	CS188
0001230009	CS682	0001311115	CS958	0001358020	CS335	0001362032	CS572
0001230012	CS718	0001311116	CS184	0001358021	CS1121	◆ 0001362034	CS114
0001230014	CS1130	0001311118	CS132	0001358041	CS706	◆ 0001362037	CS149
0001231002	CS1112	0001311120	CS72	0001358046	CS103	0001362038	CS113
0001231003	CS1279	0001311122	CS132	0001358047	CS804	0001362039	CS572
0001231004	CS1285	0001311123	CS184	0001358049	CS103	0001362041	CS707
0001231007	CS1243	0001311124	CS135	0001358050	CS1121	◆ 0001362043	CS550
0001231008	CS1267	0001311125	CS183	0001358051	CS335	0001362044	CS128
0001231009	CS1464	0001311128	CS324	0001358200	CS337	0001362045	CS128
0001231011	CS1248	0001311131	CS334	0001358201	CS337	0001362046	CS804
0001231012	CS388	0001311132	CS286	0001358202	CS337	0001362047	CS188
0001231013	CS1331	0001311133	CS184	0001359008	CS607	0001362051	CS1120
0001231014	CS1474	0001311136	CS132	0001359012	CS103	0001362052	CS1121
0001231016	CS1268	0001311137	CS132	0001359014	CS503	0001362059	CS1073
0001231017	CS1382	0001311139	CS622	0001359016	CS395	0001362060	CS705
0001231019	CS1243	0001311140	CS132	0001359019	CS511	0001362061	CS301
0001231029	CS1267	0001311141	CS132	0001359021	CS240	0001362062	CS230
0001231030	CS1243	0001311142	CS132	0001359027	CS103	0001362063	CS503
0001231032	CS1112	0001311143	CS132	0001359038	CS718	0001362064	CS511

O.E. NO.	HC-PARTS	O.E. NO.	HC-PARTS	O.E. NO.	HC-PARTS	O.E. NO.	HC-PARTS
<b>BOSCH <i>Continued</i></b>							
0001362067	CS200	0001368019	CS232	0001411013	CS1284	0001420015	CS797
0001362069	CS347	0001368020	CS394	0001411016	CS506	0001420024	CS797
0001362070	CS347	0001368024	CS120	0001411017	CS564	0010300003	DC1012
0001362071	CS148	0001368030	CS726	0001411021	CS121	0010300006	DC1011
0001362073	CS289	0001368034	CS388	0001411025	CS526	0010300100	DC1011
0001362077	CS347	0001368038	CS349	0001411026	CS564	0101206063	CG16
0001362078	CS347	0001368055	CS120	0001413006	CS951	0101206107	CG16
0001362079	CS301	0001368056	CS595	0001413017	CS1031	0101302027	CG23K
0001362081	CS314	0001368062	CS120	0001414003	CS194	0101302028	CG23K
0001362092	CS1073	0001368063	CS391	0001414010	CS194	0101302036	CG23K
0001362102	CS689	0001368070	CS608	0001414011	CS955	0101302053	CG23K
0001362105	CS572	0001368074	CS391	0001415001	CS191	0101302067	CG19
0001362300	CS503	0001368081	CS269	0001415002	CS194	0101302068	CG19
0001362301	CS511	0001368082	CS1261	0001415007	CS805	0101302069	CG16
0001362305	CS114	0001368083	CS989	0001415011	CS565	0101302070	CG16
0001362306	CS550	0001368088	CS530	0001415016	CS506	0101302075	CG19
0001362307	CS337	0001368300	CS120	0001415017	CS502	0101302076	CG19
0001362310	CS106	0001368301	CS97	0001416002	CS191	0101302083	CG17
0001362312	CS706	0001368304	CS608	0001416003	CS001	0101302084	CG17
0001362313	CS114	0001368305	CS595	0001416004	CS805	0101302085	CG19
0001362314	CS550	0001368306	CS608	0001416005	CS544	0101302086	CG19
0001362316	CS706	0001368307	CS120	0001416009	CS506	0101302089	CG16
0001362600	CS188	0001368309	CS120	0001416010	CS191	0101302090	CG16
0001362601	CS716	0001368310	CS595	0001416011	CS502	0101302107	CG17
0001362602	CS340	0001368311	CS1280	0001416012	CS1178	0101302108	CG17
0001362603	CS340	0001368313	CS1331	0001416022	CS194	0101302111	CG19
0001362606	CS340	0001368316	CS97	0001416024	CS194	0101302112	CG19
0001362607	CS340	0001368317	CS595	0001416028	CS955	0101302113	CG16
0001362700	CS1184	0001369001	CS395	0001416030	CS383	0101302114	CG16
0001363101	CS231	0001369005	CS395	0001416036	CS384	0101302115	CG19
0001363101	CS231	0001369007	CS1069	0001416043	CS546	0101302116	CG19
0001363111	CS231	0001369014	CS887	0001416044	CS1034	0101302117	CG19
0001364100	CS501	0001369015	CS1126	0001416047	CS194	0101302118	CG19
0001364102	CS387	0001369017	CS1173	0001416052	CS502	0101304005	CG17
0001364104	CS387	0001369019	CS1069	0001416054	CS194	0101304006	CG17
0001364200	CS387	0001369022	CS395	0001416061	CS699	0101304013	CG19
0001364203	CS387	0001369023	CS1126	0001416062	CS617	0101304014	CG19
0001364301	CS501	0001369024	CS887	0001416065	CS699	0120300528	CA45
0001364400	CS1129	0001371004	CS1169	0001416067	CS617	0120300529	CA45
0001364402	CS387	0001371006	CS1061	0001416070	CS544	0120300535	CA734IR
0001365004	CS398	0001371008	CS1199	0001416074	CS1178	0120300550	CA46
0001366001	CS707	0001372001	CS1077	0001416076	CS506	0120300551	CA46
0001366005	CS995	0001372002	CS1274	0001416078	CS191	0120300552	CA76
0001366014	CS995	0001372003	CS1274	0001416079	CS191	0120300558	CA45
0001367001	CS503	0001372005	CS1333	0001417001	CS198	0120300559	CA45
0001367004	CS103	0001372006	CS1269	0001417005	CS526	0120300562	CA734IR
0001367005	CS718	0001372007	CS1274	0001417006	CS564	0120300568	CA45
0001367006	CS1126	0001372008	CS1274	0001417007	CS121	0120300569	CA45
0001367010	CS605	0001401011	CS951	0001417007	CS198	0120300591	CA46
0001367013	CS335	0001401023	CS1030	0001417038	CS198	0120300592	CA46
0001367014	CS240	0001401028	CS956	0001417041	CS99	0120300596	CA617IR
0001367017	CS1123	0001401050	CS951	0001417042	CS881	0120335007	CA618IR
0001367023	CS240	0001401060	CS1030	0001417043	CS1040	0120335008	JA868IR
0001367028	CS240	0001402055	CS194	0001417045	CS121	0120335010	CA732IR
0001367029	CS682	0001402059	CS194	0001417047	CS1284	0120335012	CA637IR
0001367032	CS604	0001402079	CS955	0001417051	CS198	0120339502	CA15H
0001367034	CS186	0001402081	CS194	0001417053	CS688	0120339506	CA15H
0001367039	CS605	0001402083	CS194	0001417061	CS688	0120339509	CA17H
0001367042	CS106	0001410015	CS195	0001417063	CS1167	0120339510	CA17H
0001367043	CS266	0001410016	CS195	0001417064	CS1163	0120339512	CA734IR
0001367049	CS783	0001410024	CS198	0001417065	CS962	0120339513	CA734IR
0001367055	CS339	0001410037	CS98	0001417067	CS1167	0120339514	CA76IR
0001367056	CS345	0001410041	CS195	0001417069	CS1116	0120339515	CA77IR
0001367059	CS186	0001410044	CS710	0001417074	CS564	0120339516	CA77IR
0001367070	CS607	0001410046	CS99	0001417075	CS1161	0120339521	CA616IR
0001367075	CS395	0001410053	CS383	0001417076	CS1116	0120339526	CA603IR
0001367077	CS1205	0001410063	CS383	0001418014	CS1031	0120339527	CA77IR
0001367078	CS395	0001410065	CS526	0001418016	CS1122	0120339528	CA77IR
0001367082	CS240	0001410067	CS546	0001420001	CS797	0120339531	CA76IR
0001367300	CS186	0001410068	CS1034	0001420002	US827	0120339533	CA46IR
0001367301	CS186	0001410088	CS198	0001420003	US823	0120339534	CA46IR
0001367302	CS607	0001410098	CS121	0001420004	US823	0120339536	CA616IR
0001367303	CS186	0001410111	CS384	0001420006	US827	0120339543	CA734IR
0001368001	CS530	0001410115	CS121	0001420008	US827	0120339544	CA734IR
0001368007	CS530	0001410116	CS99	0001420009	US823	0120339545	CA734IR
0001368010	CS97	0001411005	CS121	0001420010	US827	0120389502	CA15H
0001368016	CS269	0001411008	CS99	0001420011	US827	0120389503	CA15H
0001368017	CS391	0001411009	CS198	0001420012	CS797	0120400504	CA38
0001368018	CS101	0001411012	CS99	0001420013	US823	0120400505	CA38

O.E. NO.	HC-PARTS	O.E. NO.	HC-PARTS	O.E. NO.	HC-PARTS	O.E. NO.	HC-PARTS
0120400600	CA62	0120400848	CA283	0120465022	CA855IR	0120468154	CA1456IR
0120400601	CA62	0120400852	CA88	0120465023	CA855IR	0120468162	CA1456IR
0120400603	CA62	0120400853	CA88	0120465026	CA1107IR ▲	0120469001	CA333IR
0120400604	CA30	0120400856	CA69IR	0120465028	CA1107IR	0120469002	CA843IR
0120400605	CA30	0120400857	CA69IR	0120465031	CA1092IR	0120469003	CA842IR
0120400606	CA37	0120400858	CA87IR	0120465032	CA542IR	0120469005	CA897IR
0120400607	CA62	0120400859	CA87IR	0120468007	CA542IR	0120469006	CA1073IR
0120400611	CA62	0120400860	CA259IR	0120468008	CA542IR	0120469007	CA1073IR
0120400615	CA98	0120400861	CA259IR	0120468009	CA622IR	0120469008	CA501IR
0120400628	CA38	0120400862	CA93	0120468010	CA622IR	0120469009	CA324IR
0120400629	CA38	0120400863	CA93	0120468013	CA902IR	0120469010	CA1336IR
0120400632	CA75	0120400866	CA96IR	0120468014	CA902IR	0120469011	CA842IR
0120400637	CA62	0120400867	CA96IR	0120468017	CA700IR	0120469012	CA842IR
0120400640	CA180	0120400870	CA55	0120468019	CA700IR	0120469013	CA502IR
0120400642	CA180	0120400871	CA55	0120468020	CA700IR	0120469014	CA518IR
0120400645	CA38	0120400872	CA94IR	0120468022	CA700IR	0120469016	CA846IR
0120400656	CA38	0120400873	CA94IR	0120468023	CA700IR	0120469017	CA846IR
0120400657	CA38	0120400876	CA184	0120468024	CA700IR	0120469018	CA1049IR
0120400658	CA98	0120400877	CA184	0120468028	CA1381IR	0120469019	CA333IR
0120400659	CA98	0120400882	CA184	0120468029	CA1074IR	0120469021	CA610IR ▲
0120400672	CA154	0120400887	CA75	0120468032	CA1259IR	0120469022	CA1336IR
0120400675	CA62	0120400888	CA184	0120468033	CA1259IR	0120469023	CA1336IR
0120400686	CA42	0120400891	CA184	0120468037	CA853IR	0120469025	CA333IR
0120400687	CA42	0120400893	CA154	0120468042	CA540IR	0120469026	CA1336IR
0120400694	CA180	0120400894	CA154	0120468043	CA540IR	0120469028	CA712IR
0120400700	CA118	0120400895	CA154	0120468044	CA700IR ▲	0120469029	CA712IR ▲
0120400704	CA190IR	0120400896	CA154	0120468052	CA700IR	0120469030	CA501IR
0120400705	CA190IR	0120400900	CA60IR	0120468053	CA1035IR	0120469033	CA1049IR
0120400708	CA78	0120400901	CA60IR	0120468057	CA645IR	0120469034	CA727IR
0120400710	CA38	0120400902	CA61IR	0120468058	CA645IR	0120469039	CA333IR
0120400711	CA38	0120400903	CA61IR	0120468059	CA645IR ▲	0120469044	CA1049IR
0120400712	CA183	0120400905	CA75	0120468060	CA645IR	0120469048	CA1336IR
0120400713	CA183	0120400906	CA61IR	0120468061	CA1054IR	0120469101	CA333IR
0120400719	CA154	0120400907	CA75	0120468062	CA1054IR	0120469102	CA501IR
0120400720	CA75	0120400912	CA88	0120468063	CA1054IR	0120469103	CA333IR
0120400721	CA154	0120400913	CA88	0120468064	CA1054IR	0120469108	CA1336IR
0120400722	CA70	0120400916	CA117	0120468065	CA1438IR	0120469110	CA1336IR
0120400723	CA70	0120400917	CA117	0120468070	CA700IR ▲	0120469113	CA1336IR
0120400726	CA154	0120400921	CA55	0120468078	CA1091IR ▲	0120469115	CA1593IR
0120400727	CA154	0120400922	CA55	0120468079	CA700IR ▲	0120469116	CA1593IR
0120400728	CA854IR	0120400932	CA88	0120468084	CA844IR	0120469119	CA1505IR
0120400730	CA98	0120400933	CA88	0120468085	CA844IR	0120469500	CA244IR
0120400731	CA98	0120400934	CA183	0120468086	CA844IR ▲	0120469501	CA244IR
0120400736	CA62	0120400938	CA273	0120468093	CA907IR	0120469502	CA163IR
0120400740	CA38	0120400939	CA273	0120468094	CA1438IR	0120469503	CA163IR
0120400741	CA38	0120400941	CA273	0120468096	CA542IR	0120469504	CA163IR
0120400744	CA35IR	0120400942	CA273	0120468098	CA902IR	0120469505	CA163IR
0120400752	CA50	0120400943	CA316IR	0120468101	CA1074IR	0120469507	CA366IR
0120400753	CA50	0120421142	CA96IR	0120468103	CA1054IR	0120469509	CA333IR
0120400754	CA184	0120421401	CA96IR	0120468105	CA1091IR	0120469510	CA284IR
0120400756	CA89	0120421581	CA60IR	0120468107	CA1035IR	0120469511	CA284IR
0120400757	CA89	0120450011	UA1212	0120468108	CA700IR ▲	0120469512	CA225IR
0120400758	CA259IR	0120450012	UA1212	0120468109	CA700IR ▲	0120469513	CA225IR
0120400759	CA259IR	0120450013	UA1212	0120468110	CA1091IR	0120469514	CA328IR
0120400767	CA50	0120450014	UA1212	0120468111	CA1091IR	0120469515	CA328IR
0120400768	CA50	0120450016	UA1212	0120468112	CA700IR ▲	0120469516	CA225IR
0120400771	CA191IR	0120450017	UA1212	0120468113	CA1035IR	0120469517	CA225IR
0120400772	CA191IR	0120450018	UA1212	0120468114	CA853IR	0120469518	CA333IR
0120400782	CA42	0120450019	UA1212	0120468116	CA1438IR	0120469519	CA501IR
0120400783	CA42	0120450024	UA1212	0120468117	CA1035IR	0120469520	CA501IR
0120400786	CA283	0120450026	UA1214 ▲	0120468118	CA1035IR	0120469521	CA501IR
0120400787	CA283	0120450027	UA1214	0120468119	CA844IR	0120469522	CA366IR
0120400791	CA180	0120450028	UA1214 ▲	0120468122	CA521IR ▲	0120469523	CA500IR
0120400806	CA96IR	0120450029	UA1213	0120468123	CA700IR	0120469524	CA163IR
0120400807	CA96IR	0120465004	CA646IR ▲	0120468124	CA1438IR	0120469525	CA163IR
0120400808	CA94IR	0120465006	CA1056IR	0120468125	CA1074IR	0120469526	CA502IR
0120400809	CA94IR	0120465007	CA855IR	0120468127	CA1447IR	0120469527	CA240IR
0120400810	CA96IR	0120465008	CA855IR	0120468128	CA1447IR	0120469528	CA163IR
0120400814	CA190IR	0120465009	CA1107IR ▲	0120468129	CA1438IR	0120469530	CA225IR
0120400815	CA38	0120465010	CA1107IR ▲	0120468130	CA1438IR	0120469531	CA225IR
0120400830	CA134	0120465012	CA1088IR	0120468131	CA1148IR	0120469534	CA328IR
0120400833	CA99IR	0120465013	CA646IR ▲	0120468132	CA1744IR	0120469535	CA328IR
0120400834	CA99IR	0120465014	CA646IR	0120468135	CA907IR	0120469537	CA284IR
0120400835	CA78	0120465015	CA1081IR ▲	0120468137	CA1035IR	0120469538	CA251IR
0120400836	CA93	0120465016	CA1081IR ▲	0120468140	CA1456IR	0120469539	CA251IR
0120400837	CA93	0120465017	CA1081IR ▲	0120468141	CA700IR	0120469541	CA244IR
0120400838	CA48IR	0120465018	CA1069IR	0120468143	CA1505IR	0120469542	CA244IR
0120400839	CA48IR	0120465020	CA828IR	0120468144	CA907IR	0120469548	CA328IR ▲
0120400847	CA283	0120465021	CA1399IR	0120468145	CA1505IR	0120469549	CA326IR

O.E. NO.	HC-PARTS	O.E. NO.	HC-PARTS	O.E. NO.	HC-PARTS	O.E. NO.	HC-PARTS
<b>BOSCH Continued</b>							
0120469551	CA2441R	0120469676	CA3241R	0120469808	CA3241R	0120469935	CA1551R
0120469552	CA2441R	0120469677	CA3241R	0120469811	CA3351R	0120469936	CA7121R ▲
0120469553	CA2441R	0120469679	CA3261R	0120469813	CA6101R ▲	0120469937	CA7121R ▲
0120469555	CA3281R ▲	0120469680	CA5901R	0120469814	CA6101R ▲	0120469938	CA6441R
0120469556	CA3281R ▲	0120469681	CA5901R	0120469818	CA2841R	0120469939	CA6441R
0120469557	CA3281R ▲	0120469682	CA5661R	0120469819	CA2841R	0120469940	CA7121R
0120469558	CA3281R ▲	0120469683	CA5661R	0120469820	CA5151R	0120469944	CA2631R
0120469559	CA3221R ▲	0120469684	CA5671R	0120469821	CA5151R	0120469945	CA2631R
0120469560	CA2511R	0120469685	CA5671R	0120469822	CA5211R	0120469947	CA3351R
0120469561	CA2511R	0120469686	CA3331R	0120469823	CA5211R	0120469958	CA3241R
0120469562	CA2401R	0120469687	CA5021R	0120469827	CA5381R	0120469959	CA2271R
0120469563	CA2711R	0120469688	CA2251R	0120469828	CA5381R	0120469962	CA16861R ▲
0120469564	CA2711R	0120469689	CA3431R	0120469829	CA5381R	0120469963	CA5501R
0120469566	CA3221R ▲	0120469690	CA3431R	0120469830	CA5381R	0120469967	CA10641R ▲
0120469567	CA5911R	0120469693	CA2271R	0120469831	CA3431R	0120469969	CA8971R
0120469569	CA2271R	0120469696	CA3201R	0120469832	CA5211R	0120469970	CA16861R
0120469571	CA2251R	0120469697	CA3201R	0120469838	CA15511R	0120469971	CA8431R ▲
0120469572	CA2251R	0120469698	CA3201R	0120469839	CA5211R	0120469972	CA8431R ▲
0120469573	CA2251R	0120469699	CA3201R	0120469847	CA7121R	0120469973	CA10631R
0120469574	CA2251R	0120469700	CA3201R	0120469848	CA7121R ▲	0120469974	CA10631R
0120469575	CA2841R	0120469701	CA3201R	0120469858	CA6441R	0120469976	CA10581R
0120469576	CA2841R	0120469702	CA3201R	0120469859	CA6441R	0120469977	CA10581R
0120469579	CA5951R	0120469706	CA10581R	0120469860	CA7271R	0120469978	CA13361R
0120469580	CA5951R	0120469707	CA10581R	0120469861	CA7271R	0120469979	CA12341R
0120469581	CA3201R	0120469709	CA3431R	0120469862	CA3201R	0120469982	CA3331R
0120469582	CA3201R	0120469710	CA5691R	0120469863	CA3181R	0120469983	CA2401R
0120469583	CA2631R	0120469713	CA3221R	0120469864	CA8411R	0120469984	CA10731R
0120469584	CA2631R	0120469721	CA3281R ▲	0120469865	CA8411R	0120469985	CA10731R
0120469585	CA5011R	0120469722	CA6101R	0120469868	CA5391R	0120469988	CA5151R
0120469588	CA2631R	0120469723	CA6101R	0120469869	CA5391R	0120469990	CA5411R
0120469589	CA2631R	0120469727	CA3201R	0120469870	CA5631R	0120469991	CA10581R
0120469590	CA2631R	0120469728	CA3201R	0120469871	CA5631R	0120469992	CA9051R
0120469591	CA2631R	0120469729	CA3201R ▲	0120469874	CA5631R	0120469993	CA9051R
0120469592	CA2401R	0120469730	CA3201R	0120469875	CA7271R	0120469996	CA9001R
0120469593	CA2511R	0120469731	CA3201R	0120469876	CA5391R	0120469997	CA9001R
0120469600	CA3201R	0120469732	CA3201R	0120469877	CA5391R	0120469999	CA13361R
0120469601	CA3181R	0120469733	CA3201R	0120469878	CA6081R	0120484001	CA14331R
0120469602	CA3181R	0120469734	CA3181R	0120469879	CA6081R	0120484002	CA8471R
0120469603	CA3181R	0120469735	CA3181R	0120469880	CA5661R	0120484003	CA8471R
0120469604	CA3201R	0120469736	CA3181R	0120469881	CA5661R	0120484004	CA8391R
0120469608	CA2721R	0120469737	CA3181R	0120469882	CA15511R	0120484005	CA8391R
0120469609	CA2721R	0120469738	CA3181R	0120469883	CA15511R	0120484006	CA8391R
0120469611	CA5661R	0120469739	CA3181R	0120469885	CA3201R	0120484010	CA8391R
0120469617	CA2511R	0120469740	CA10581R	0120469886	CA3201R	0120484011	CA11981R
0120469618	CA2511R	0120469741	CA10581R	0120469888	CA5211R	0120484014	CA8391R
0120469619	CA2511R	0120469744	CA3351R	0120469889	CA5211R	0120484016	CA8471R
0120469620	CA5661R	0120469745	CA3351R	0120469890	CA3261R	0120484017	CA10681R
0120469628	CA5911R	0120469746	CA3351R	0120469891	CA2401R	0120484018	CA11981R
0120469631	CA3201R	0120469747	CA3231R	0120469892	CA7271R ▲	0120484019	CA10681R
0120469632	CA3201R	0120469748	CA3231R	0120469893	CA7121R	0120484020	CA8471R
0120469633	CA3201R	0120469752	CA5951R	0120469896	CA3351R	0120484021	CA13351R
0120469635	CA3201R	0120469753	CA5951R	0120469897	CA3351R	0120484024	CA17361R
0120469636	CA3201R	0120469754	CA3221R	0120469899	CA3221R	0120484026	CA11981R
0120469637	CA3201R	0120469757	CA3621R	0120469900	CA2271R	0120484050	CA11981R
0120469638	CA3201R	0120469759	CA3621R	0120469901	CA5471R	0120485007	CA5201R
0120469642	CA2631R	0120469761	CA2401R	0120469902	CA5471R	0120485011	CA7241R
0120469643	CA2271R	0120469763	CA2271R	0120469906	CA9011R	0120485012	CA7241R ▲
0120469644	CA5671R	0120469768	CA3181R	0120469907	CA9011R	0120485015	JA6651R
0120469645	CA5671R	0120469772	CA5011R	0120469909	CA8461R	0120485018	CA8371R
0120469646	CA5691R	0120469775	CA5411R	0120469910	CA8461R	0120485020	CA8291R
0120469647	CA5691R	0120469776	CA5411R	0120469911	CA8591R	0120485022	CA8331R
0120469650	CA5151R	0120469777	CA5031R	0120469912	CA8591R	0120485023	CA8291R ▲
0120469651	CA5151R	0120469779	CA5031R	0120469913	CA10411R	0120485025	CA7371R
0120469655	CA2991R	0120469780	CA3431R	0120469914	CA10411R	0120485026	CA10971R
0120469656	CA2991R	0120469781	CA2991R	0120469915	CA15511R	0120485029	CA7381R
0120469657	CA2251R	0120469784	CA3811R	0120469916	CA15511R	0120485030	CA7391R
0120469658	CA2251R	0120469785	CA3811R	0120469918	CA10411R	0120485034	CA7331R
0120469659	CA3221R	0120469786	CA3811R	0120469919	CA10411R	0120485036	CA7401R
0120469660	CA3221R	0120469787	CA3811R	0120469920	CA5501R	0120485038	CA7361R
0120469661	CA3241R	0120469788	CA9001R	0120469923	CA5151R	0120485039	CA9121R
0120469662	CA3241R	0120469789	CA9001R	0120469924	CA5151R	0120485041	CA12441R
0120469664	CA5911R	0120469790	CA5211R ▲	0120469927	CA7231R	0120485043	CA8271R
0120469665	CA2721R	0120469793	CA3811R	0120469928	CA7141R	0120485044	CA12661R
0120469666	CA5691R	0120469798	CA5181R	0120469929	CA6101R ▲	0120485045	CA8521R
0120469668	CA5911R	0120469799	CA2841R	0120469930	CA6101R ▲	0120485046	CA8521R
0120469669	CA2721R	0120469800	CA2841R	0120469931	CA7081R	0120485047	CA9081R
0120469670	CA5901R	0120469801	CA5151R	0120469932	CA7081R	0120485048	CA10641R
0120469674	CA10581R	0120469802	CA5151R	0120469933	CA7081R	0120485050	JA9921R
0120469675	CA10581R	0120469807	CA2271R	0120469934	CA7081R	0120488000	CA3841R



O.E. NO.	HC-PARTS	O.E. NO.	HC-PARTS	O.E. NO.	HC-PARTS	O.E. NO.	HC-PARTS
0120488001	CA384IR	0120488226	CA906IR	0120489039	CA122IR	0120489147	CA316IR ▲
0120488002	CA383IR	0120488227	CA906IR	0120489040	CA196IR	0120489148	CA96IR
0120488003	CA383IR	0120488228	CA1554IR	0120489041	CA191IR	0120489149	CA195IR
0120488004	CA382IR	0120488228	CA1691IR	0120489042	CA191IR	0120489152	CA355IR ▲
0120488005	CA382IR	0120488229	CA903IR	0120489043	CA192IR	0120489153	CA355IR
0120488008	CA384IR	0120488230	CA903IR	0120489044	CA192IR	0120489156	CA915IR
0120488009	CA384IR	0120488231	CA903IR	0120489045	CA121IR	0120489157	CA294IR
0120488012	CA384IR	0120488233	CA1242IR	0120489046	CA121IR	0120489158	CA294IR
0120488114	CA238IR ▲	0120488235	CA254IR	0120489048	CA96IR	0120489163	CA178IR
0120488118	CA593IR	0120488236	CA588IR	0120489049	CA60IR	0120489164	CA178IR
0120488119	CA593IR	0120488237	CA376IR	0120489050	CA94IR	0120489170	CA129IR
0120488120	JA146IR	0120488239	CA588IR	0120489051	CA96IR	0120489172	CA259IR
0120488121	JA146IR	0120488240	CA376IR	0120489052	CA94IR	0120489173	CA308IR
0120488132	CA1735IR	0120488241	CA364IR	0120489054	CA94IR	0120489174	CA308IR
0120488133	CA1735IR	0120488242	CA1046IR	0120489057	CA125IR	0120489181	CA84IR
0120488134	CA1242IR	0120488243	CA1046IR	0120489058	CA125IR	0120489182	CA84IR
0120488137	CA710IR	0120488248	CA1067IR	0120489060	CA132IR	0120489183	CA238IR ▲
0120488138	CA1450IR	0120488249	CA1067IR	0120489061	CA87IR	0120489184	CA287IR
0120488140	CA254IR	0120488250	CA355IR ▲	0120489062	CA140IR	0120489185	CA298IR
0120488144	CA840IR	0120488252	CA1448IR	0120489065	CA88IR	0120489187	CA252IR
0120488145	CA840IR	0120488253	CA1448IR	0120489066	CA88IR	0120489188	CA252IR
0120488146	CA594IR ▲	0120488254	CA506IR	0120489069	CA238IR	0120489189	CA315IR
0120488148	CA594IR	0120488255	CA647IR	0120489070	CA238IR	0120489190	CA315IR
0120488149	CA562IR	0120488256	CA854IR	0120489072	CA504IR	0120489191	CA199IR
0120488153	CA702IR	0120488257	CA238IR	0120489073	CA504IR	0120489192	CA130IR
0120488156	CA198IR	0120488258	CA238IR	0120489074	CA226IR	0120489193	CA291IR
0120488157	CA198IR	0120488259	CA904IR	0120489075	CA226IR	0120489194	CA291IR
0120488158	CA513IR	0120488260	CA904IR	0120489076	CA136IR	0120489195	CA242IR
0120488159	CA513IR	0120488261	CA899IR	0120489077	CA139IR	0120489196	CA242IR
0120488160	CA604IR	0120488262	CA899IR	0120489078	CA287IR	0120489197	CA910IR
0120488161	CA604IR	0120488265	CA588IR	0120489079	CA287IR	0120489198	CA277IR
0120488162	CA548IR	0120488267	CA1027IR	0120489084	CA190IR	0120489202	CA276IR
0120488163	CA548IR	0120488268	CA327IR	0120489088	CA126IR	0120489203	CA276IR
0120488164	CA514IR	0120488269	CA710IR	0120489090	CA305IR	0120489205	CA277IR
0120488165	CA514IR	0120488270	CA710IR	0120489091	CA226IR	0120489210	CA357IR
0120488166	CA519IR	0120488271	CA222IR	0120489092	CA96IR	0120489211	CA357IR
0120488170	CA570IR	0120488274	CA504IR ▲	0120489093	CA305IR	0120489212	CA355IR
0120488171	CA570IR	0120488275	CA254IR ▲	0120489095	CA96IR	0120489214	CA96IR
0120488172	CA517IR	0120488277	CA854IR	0120489096	CA60IR	0120489219	CA355IR
0120488173	CA517IR	0120488278	CA854IR	0120489097	CA60IR	0120489221	CA187IR
0120488176	CA1227IR	0120488280	CA295IR	0120489098	CA94IR	0120489225	CA187IR
0120488176	CA305IR	0120488282	CA186IR	0120489099	CA94IR	0120489226	CA710IR
0120488177	CA1227IR	0120488283	CA702IR	0120489100	CA94IR	0120489227	CA710IR
0120488177	CA305IR	0120488284	CA642IR	0120489101	CA94IR	0120489228	CA241IR
0120488178	CA562IR	0120488286	CA325IR	0120489103	CA126IR	0120489229	CA241IR
0120488179	CA562IR	0120488287	CA1055IR	0120489104	CA259IR	0120489230	CA334IR
0120488180	CA562IR	0120488289	CA334IR	0120489106	CA255IR	0120489231	CA187IR
0120488181	CA1692IR	0120488290	CA1027IR	0120489107	CA316IR	0120489232	CA321IR
0120488182	CA305IR	0120488291	CA854IR	0120489108	CA110IR	0120489233	CA321IR ▲
0120488183	CA630IR	0120488293	CA1197IR	0120489109	CA110IR	0120489235	CA241IR
0120488184	CA630IR	0120488297	CA1082IR	0120489110	CA42IR	0120489236	CA241IR
0120488185	CA238IR	0120489002	CA141IR	0120489111	CA42IR	0120489237	CA278IR
0120488186	CA516IR	0120489003	CA141IR	0120489112	CA221IR	0120489242	CA195IR
0120488187	CA516IR	0120489006	CA141IR	0120489113	CA221IR	0120489243	CA195IR
0120488189	CA561IR	0120489007	CA141IR	0120489114	CA48IR	0120489244	CA293IR
0120488190	CA514IR	0120489008	CA52IR	0120489115	CA48IR	0120489245	CA293IR
0120488191	CA514IR	0120489009	CA52IR	0120489116	CA128IR	0120489248	CA242IR
0120488192	CA517IR	0120489010	CA52IR	0120489117	CA128IR	0120489249	CA242IR
0120488193	CA517IR	0120489011	CA52IR	0120489118	CA99IR	0120489251	CA306IR
0120488194	CA631IR	0120489012	CA136IR	0120489119	CA99IR	0120489251	CA561IR
0120488195	CA631IR	0120489013	CA136IR	0120489120	CA158IR	0120489252	CA306IR
0120488196	CA588IR	0120489014	CA140IR	0120489121	CA507IR	0120489253	CA592IR
0120488197	CA588IR	0120489015	CA140IR	0120489122	CA158IR	0120489254	CA592IR
0120488198	CA376IR	0120489016	CA139IR	0120489123	CA264IR	0120489258	CA294IR
0120488199	CA376IR	0120489017	CA139IR	0120489124	CA508IR	0120489259	CA294IR
0120488200	CA519IR	0120489020	CA129IR	0120489125	CA264IR	0120489260	CA85IR
0120488201	CA519IR	0120489022	CA339IR	0120489126	CA127IR	0120489261	CA85IR
0120488205	CA1197IR	0120489023	CA341IR	0120489127	CA127IR	0120489262	CA139IR
0120488208	CA334IR	0120489024	CA195IR	0120489128	CA254IR	0120489263	CA254IR
0120488209	CA238IR ▲	0120489025	CA287IR	0120489130	CA504IR	0120489266	CA96IR
0120488210	CA1690IR	0120489026	CA287IR	0120489132	CA119IR	0120489268	CA61IR
0120488211	CA325IR ▲	0120489028	CA250IR	0120489133	CA119IR	0120489269	CA61IR
0120488214	CA294IR	0120489029	CA250IR	0120489134	CA129IR	0120489272	CA506IR
0120488215	CA294IR	0120489030	CA196IR	0120489135	CA129IR	0120489273	CA506IR
0120488217	CA1027IR	0120489031	CA196IR	0120489136	CA506IR	0120489274	CA287IR ▲
0120488218	CA1027IR	0120489032	CA186IR	0120489138	CA353IR	0120489275	CA287IR ▲
0120488219	CA826IR	0120489036	CA199IR	0120489139	CA353IR	0120489277	CA228IR
0120488220	CA826IR	0120489037	CA199IR	0120489145	CA255IR ▲	0120489278	CA228IR
0120488224	CA341IR	0120489038	CA122IR	0120489146	CA316IR	0120489284	CA187IR

O.E. NO.	HC-PARTS	O.E. NO.	HC-PARTS	O.E. NO.	HC-PARTS	O.E. NO.	HC-PARTS
<b>BOSCH <i>Continued</i></b>							
0120489286	CA358IR	0120489384	CA564IR	0120489541	CA129IR	0120489672	CA119IR
0120489287	CA293IR	0120489385	CA564IR	0120489542	CA129IR	0120489673	CA119IR
0120489290	CA305IR	0120489386	CA910IR	0120489543	CA122IR	0120489678	CA35IR
0120489292	CA306IR	0120489393	CA369IR	0120489544	CA122IR	0120489683	CA87IR
0120489293	CA564IR	0120489394	CA369IR	0120489546	CA35IR	0120489684	CA334IR
0120489295	CA528IR	0120489395	JA199IR	0120489547	CA69IR	0120489685	CA192IR
0120489296	CA358IR	0120489396	JA199IR	0120489548	CA69IR	0120489686	CA192IR
0120489297	CA528IR	0120489397	CA195IR	▲ 0120489549	CA300IR	0120489687	CA125IR
0120489298	CA287IR	▲ 0120489398	CA195IR	▲ 0120489550	CA300IR	0120489688	CA125IR
0120489300	CA321IR	▲ 0120489400	CA254IR	0120489556	CA87IR	0120489691	CA60IR
0120489301	CA321IR	0120489408	CA325IR	0120489557	CA33IR	0120489692	CA60IR
0120489302	CA321IR	▲ 0120489410	CA212IR	0120489558	CA33IR	0120489698	CA35IR
0120489303	CA722IR	0120489412	CA212IR	0120489559	CA85IR	0120489699	CA35IR
0120489304	CA96IR	0120489414	CA212IR	0120489560	CA85IR	0120489700	CA94IR
0120489305	CA96IR	0120489418	CA530IR	▲ 0120489561	CA190IR	0120489701	CA94IR
0120489307	CA506IR	0120489420	CA530IR	▲ 0120489562	CA190IR	0120489702	CA130IR
0120489309	CA238IR	▲ 0120489421	CA365IR	0120489565	CA93IR	0120489703	CA522IR
0120489310	CA310IR	0120489426	CA293IR	0120489566	CA93IR	0120489704	CA522IR
0120489311	CA310IR	0120489427	CA347IR	0120489567	CA259IR	0120489705	CA126IR
0120489312	CA310IR	0120489428	CA347IR	0120489568	CA259IR	0120489706	CA126IR
0120489315	CA186IR	0120489429	CA354IR	0120489575	CA284IR	0120489707	CA341IR
0120489316	CA568IR	0120489430	CA354IR	0120489576	CA284IR	0120489708	CA207IR
0120489317	CA915IR	0120489431	CA354IR	0120489581	CA33IR	0120489709	CA207IR
0120489318	CA506IR	0120489432	CA619IR	0120489583	CA93IR	0120489710	CA339IR
0120489319	CA506IR	0120489433	CA619IR	0120489584	CA93IR	0120489711	CA139IR
0120489321	CA345IR	0120489434	CA319IR	0120489585	CA99IR	0120489712	CA139IR
0120489322	CA345IR	0120489435	CA319IR	0120489586	CA99IR	0120489713	CA141IR
0120489323	CA321IR	0120489439	CA537IR	0120489587	CA60IR	0120489714	CA141IR
0120489324	CA321IR	0120489440	CA537IR	0120489588	CA60IR	0120489715	CA511IR
0120489325	CA345IR	0120489441	CA911IR	0120489589	CA61IR	0120489716	CA511IR
0120489326	CA345IR	0120489442	CA376IR	0120489590	CA61IR	0120489717	CA196IR
0120489327	CA345IR	▲ 0120489444	CA337IR	0120489592	CA94IR	0120489718	CA196IR
0120489328	CA345IR	0120489445	CA520IR	▲ 0120489593	CA94IR	0120489719	CA235IR
0120489329	CA345IR	0120489446	CA364IR	0120489594	CA96IR	0120489720	CA235IR
0120489330	CA345IR	0120489447	CA364IR	0120489595	CA96IR	0120489723	CA152IR
0120489331	CA1072IR	0120489448	CA911IR	0120489606	CA122IR	0120489724	CA152IR
0120489331	CA321IR	0120489450	CA504IR	0120489607	CA122IR	0120489725	CA186IR
0120489332	CA321IR	0120489451	JA146IR	0120489608	CA122IR	0120489726	CA186IR
0120489333	CA1072IR	0120489452	JA146IR	0120489609	CA191IR	0120489727	CA187IR
0120489334	CA641IR	0120489460	CA594IR	0120489610	CA191IR	0120489728	CA187IR
0120489335	CA641IR	0120489461	CA594IR	▲ 0120489612	CA212IR	0120489730	CA341IR
0120489336	CA642IR	0120489465	CA811IR	0120489613	CA125IR	0120489731	CA368IR
0120489337	CA642IR	0120489466	CA811IR	0120489614	CA125IR	0120489732	CA141IR
0120489339	CA353IR	0120489467	CA359IR	0120489615	CA125IR	0120489735	CA124IR
0120489340	CA353IR	0120489473	CA349IR	0120489617	CA96IR	0120489736	CA125IR
0120489341	CA352IR	0120489474	CA349IR	0120489618	CA199IR	0120489737	CA125IR
0120489342	CA509IR	0120489476	CA359IR	0120489619	CA199IR	0120489738	CA127IR
0120489343	CA352IR	0120489477	CA620IR	0120489620	CA189IR	0120489739	CA127IR
0120489344	CA308IR	0120489478	CA620IR	0120489621	CA189IR	0120489740	CA119IR
0120489345	CA305IR	0120489479	CA379IR	0120489622	CA52IR	0120489741	CA119IR
0120489346	CA1554IR	0120489480	CA379IR	0120489623	CA69IR	0120489742	CA129IR
0120489346	CA325IR	0120489485	CA504IR	0120489625	CA99IR	0120489743	CA129IR
0120489347	CA1554IR	0120489486	CA198IR	0120489626	CA99IR	0120489744	CA33IR
0120489347	CA325IR	0120489487	CA198IR	0120489627	CA48IR	0120489745	CA33IR
0120489348	CA254IR	0120489488	CA530IR	0120489628	CA48IR	0120489746	CA85IR
0120489350	CA504IR	0120489489	CA530IR	0120489629	CA110IR	0120489747	CA85IR
0120489354	CA321IR	0120489490	CA711IR	0120489630	CA110IR	0120489748	CA195IR
0120489355	CA321IR	0120489491	CA574IR	0120489631	CA42IR	0120489749	CA195IR
0120489358	CA315IR	0120489493	CA221IR	0120489632	CA42IR	0120489750	CA195IR
0120489360	CA342IR	0120489494	CA221IR	0120489635	CA99IR	0120489751	CA195IR
0120489361	CA342IR	0120489495	CA619IR	0120489636	CA99IR	0120489756	CA340IR
0120489362	CA296IR	0120489496	CA619IR	0120489639	CA212IR	0120489757	CA186IR
0120489363	CA296IR	0120489499	CA298IR	0120489641	CA129IR	0120489759	CA124IR
0120489364	CA298IR	0120489500	CA35IR	0120489642	CA129IR	0120489760	CA124IR
0120489365	CA298IR	0120489501	CA35IR	0120489643	CA132IR	0120489761	CA255IR
0120489367	CA337IR	0120489508	CA190IR	0120489644	CA121IR	0120489762	CA255IR
0120489368	CA337IR	0120489510	CA259IR	0120489645	CA121IR	0120489763	CA316IR
0120489370	CA520IR	0120489511	CA190IR	0120489646	CA122IR	0120489765	CA255IR
0120489371	CA911IR	▲ 0120489519	CA35IR	0120489647	CA122IR	0120489766	CA128IR
0120489372	CA297IR	0120489520	CA52IR	0120489648	CA122IR	0120489767	CA128IR
0120489374	CA376IR	0120489521	CA52IR	0120489649	CA191IR	0120489768	CA99IR
0120489375	CA376IR	0120489522	CA190IR	0120489650	CA191IR	0120489769	CA99IR
0120489376	CA505IR	0120489526	CA87IR	0120489653	CA124IR	0120489770	CA316IR
0120489377	CA505IR	0120489527	CA87IR	0120489654	CA124IR	0120489771	CA237IR
0120489378	CA302IR	0120489532	CA35IR	0120489657	CA124IR	0120489772	CA237IR
0120489379	CA302IR	0120489533	CA121IR	0120489659	CA124IR	0120489780	CA221IR
0120489380	CA297IR	0120489534	CA121IR	0120489660	CA125IR	0120489781	CA221IR
0120489382	CA588IR	0120489535	CA52IR	0120489666	CA226IR	0120489782	CA198IR
0120489383	CA588IR	0120489536	CA190IR	0120489667	CA226IR	0120489783	CA198IR

O.E. NO.	HC-PARTS	O.E. NO.	HC-PARTS	O.E. NO.	HC-PARTS	O.E. NO.	HC-PARTS
0120489792	CA212IR	0120489918	CA87IR	0121615003	CA1922IR	0123310051	JA1364IR
0120489793	CA212IR	0120489920	CA119IR	0121615005	CA1968IR	0123310052	JA1364IR
0120489795	CA212IR	0120489921	CA119IR	0121615006	CA1923IR	0123310053	CA1037IR
0120489796	CA212IR	0120489928	CA287IR	0121615008	CA1919IR	0123310054	CA1087IR
0120489797	CA235IR	0120489930	CA287IR	0121615009	CA1970IR	0123310055	CA1552IR
0120489798	CA235IR	0120489933	CA87IR	0121615012	CA2006IR	0123315001	CA733IR
0120489799	CA33IR	0120489935	CA195IR	0121615013	CA1819IR	0123315002	CA827IR
0120489800	CA33IR	0120489936	CA195IR	0121615014	CA1967IR	0123315004	CA826IR
0120489801	CA226IR	0120489937	CA259IR	0121615027	CA2006IR	0123315005	CA724IR
0120489803	CA190IR	0120489938	CA259IR	0121615028	CA2000IR	0123315006	CA1266IR
0120489804	CA190IR	0120489940	CA190IR	0121615029	CA1819IR	0123315007	JA1405IR
0120489805	CA61IR	0120489942	CA254IR	0121715001	CA1888IR	0123315008	CA1136IR
0120489806	CA61IR	0120489943	CA254IR	0121715003	CA1912IR	0123315013	CA1256IR
0120489814	CA246IR	0120489944	CA222IR	0121715004	CA1820IR	0123315015	CA1075IR
0120489815	CA261IR	0120489945	CA228IR	0121715008	CA2001IR	0123315016	CA1096IR
0120489818	CA205IR	0120489946	CA228IR	0121715012	CA1953IR	0123315017	CA1136IR
0120489819	CA205IR	0120489947	CA507IR	0121715017	CA2035IR	0123315018	CA1075IR
0120489820	CA52IR	0120489948	CA507IR	0121715020	CA1937IR	0123315020	JA1405IR
0120489821	CA52IR	0120489949	CA158IR	0121715029	CA2032IR	0123315021	CA1096IR
0120489823	CA506IR	0120489950	CA264IR	0122468015	CA1632IR	0123315022	CA1580IR
0120489824	CA506IR	0120489951	CA264IR	0122469002	UA1114IR	0123315023	CA1580IR
0120489827	CA334IR	0120489952	CA264IR	0123100001	CA1231IR	0123315500	CA1556IR
0120489828	CA87IR	0120489956	CA61IR	0123100002	CA1066IR	0123315501	CA1062IR
0120489833	CA226IR	0120489957	CA61IR	0123100003	CA1329IR	0123315501	CA1062IR
0120489834	CA236IR	0120489958	CA312IR	0123100004	CA820IR	0123315502	CA1556IR
0120489835	CA236IR	0120489959	CA312IR	0123110005	CA1146IR	0123315503	CA1556IR
0120489838	CA316IR	0120489960	CA706IR	0123110006	CA1326IR	0123320001	CA736IR
0120489839	CA96IR	0120489961	CA706IR	0123110007	JA1176IR	0123320002	CA740IR
0120489841	CA126IR	0120489964	CA136IR	0123110008	CA1257IR	0123320003	CA829IR
0120489842	CA126IR	0120489965	CA136IR	0123115008	JA868IR	0123320005	CA912IR
0120489843	CA226IR	0120489966	CA367IR	0123115009	JA1426IR	0123320006	CA740IR
0120489844	CA226IR	0120489967	CA367IR	0123115010	JA868IR	0123320007	CA736IR
0120489846	CA60IR	0120489968	CA246IR	0123115011	JA991IR	0123320008	CA1269IR
0120489847	CA60IR	0120489969	CA246IR	0123115014	JA1426IR	0123320009	CA1486IR
0120489849	CA94IR	0120489971	CA141IR	0123120001	CA861IR	0123320011	CA1246IR
0120489850	CA94IR	0120489972	CA141IR	0123212001	CA731IR	0123320012	CA1261IR
0120489851	CA94IR	0120489974	CA237IR	0123213006	CA1088IR	0123320014	CA1071IR
0120489854	CA61IR	0120489975	CA237IR	0123213007	CA1069IR	0123320016	CA1139IR
0120489858	CA140IR	0120489976	CA237IR	0123214002	CA1245IR	0123320017	CA736IR
0120489859	CA140IR	0120489982	CA139IR	0123310001	CA827IR	0123320018	CA1228IR
0120489860	CA140IR	0120489983	CA139IR	0123310002	CA733IR	0123320019	CA1265IR
0120489861	CA136IR	0120489986	CA140IR	0123310003	CA1266IR	0123320020	CA1097IR
0120489862	CA136IR	0120489987	CA140IR	0123310004	CA1102IR	0123320021	CA1149IR
0120489863	CA136IR	0120489988	CA140IR	0123310005	CA724IR	0123320023	CA1061IR
0120489864	CA136IR	0120489990	CA205IR	0123310006	CA1106IR	0123320024	CA1269IR
0120489865	CA136IR	0120489991	CA205IR	0123310007	CA852IR	0123320025	CA1486IR
0120489866	CA136IR	0120489992	CA236IR	0123310010	CA1043IR	0123320026	CA1244IR
0120489868	CA139IR	0120489993	CA236IR	0123310011	CA1152IR	0123320027	CA1240IR
0120489869	CA139IR	0120489997	CA207IR	0123310012	CA1155IR	0123320029	CA1563IR
0120489870	CA139IR	0120489998	CA84IR	0123310013	CA1151IR	0123320031	CA1570IR
0120489871	CA139IR	0120489999	CA84IR	0123310014	CA738IR	0123320032	CA1570IR
0120489872	CA139IR	0120689511	CA1224IR	0123310015	CA1032IR	0123320033	CA1226IR
0120489873	CA139IR	0120689513	CA823IR	0123310016	JA665IR	0123320034	CA1240IR
0120489874	CA504IR	0120689517	CA1393IR	0123310017	CA1096IR	0123320035	CA1500IR
0120489875	CA504IR	0120689519	CA1751IR	0123310018	CA1268IR	0123320036	CA1239IR
0120489881	CA207IR	0120689520	CA824IR	0123310019	CA827IR	0123320038	CA1297IR
0120489882	CA207IR	0120689522	CA1393IR	0123310020	CA733IR	0123320039	CA1246IR
0120489885	CA327IR	0120689526	CA1235IR	0123310022	CA1093IR	0123320041	CA1209IR
0120489886	CA327IR	0120689533	CA824IR	0123310023	CA1087IR	0123320044	CA1044IR
0120489888	CA61IR	0120689535	CA1236IR	0123310024	CA827IR	0123320045	CA1062IR
0120489889	CA61IR	0120689536	CA1924IR	0123310025	CA827IR	0123320046	CA1395IR
0120489892	CA140IR	0120689537	CA1751IR	0123310026	CA737IR	0123320047	CA1090IR
0120489893	CA140IR	0120689540	CA1393IR	0123310027	CA1324IR	0123320048	CA829IR
0120489894	CA190IR	0120689541	CA1237IR	0123310028	CA1102IR	0123320049	CA1395IR
0120489895	CA61IR	0120689543	CA1224IR	0123310029	CA1037IR	0123320050	CA1145IR
0120489896	CA126IR	0120689544	CA1751IR	0123310030	CA1096IR	0123320051	CA1489IR
0120489897	CA287IR	0120689546	CA1770IR	0123310031	CA1562IR	0123320052	CA1139IR
0120489898	CA287IR	0120689548	CA1667IR	0123310032	CA827IR	0123320054	CA1139IR
0120489903	CA300IR	0120689552	CA1667IR	0123310033	JA1364IR	0123320055	CA1486IR
0120489904	CA300IR	0120689562	CA1624IR	0123310035	CA1249IR	0123320057	CA1138IR
0120489905	CA511IR	0120689566	CA1667IR	0123310037	CA1267IR	0123320058	CA1500IR
0120489906	CA511IR	0120689567	CA1659IR	0123310038	CA1255IR	0123320060	CA1301IR
0120489911	CA235IR	0120689569	CA1237IR	0123310040	CA1543IR	0123320061	CA1062IR
0120489912	CA235IR	0120689571	CA1236IR	0123310043	CA1093IR	0123320062	CA1090IR
0120489913	CA236IR	0120689572	CA1770IR	0123310044	CA1093IR	0123320065	CA1489IR
0120489914	CA236IR	0120689575	CA1237IR	0123310047	CA1093IR	0123320067	CA1145IR
0120489915	CA205IR	0120689587	CA1236IR	0123310048	CA1552IR	0123325003	JA987IR
0120489916	CA205IR	0120689591	CA824IR	0123310049	CA1510IR	0123325005	JA1134IR
0120489917	CA87IR	0121615002	CA1928IR	0123310050	CA1087IR	0123325005	CA1262IR

O.E. NO.	HC-PARTS	O.E. NO.	HC-PARTS	O.E. NO.	HC-PARTS	O.E. NO.	HC-PARTS
<b>BOSCH Continued</b>							
0123325006	CA1401IR	0123510048	CA1492IR	0123545003	CA1056IR	0124325046	CA1489IR
0123325007	CA1138IR	0123510049	CA1299IR	0123545004	CA1081IR	0124325049	CA1540IR
0123325008	JA1377IR	0123510050	CA1300IR	0124215002	CA1084IR	0124325050	CA1733IR
0123325010	CA1256IR	0123510051	CA1057IR	0124225001	CA1257IR	0124325051	CA1657IR
0123325011	CA1569IR	0123510052	CA1070IR	0124225002	CA1391IR	0124325052	CA1684IR ▲
0123325012	JA987IR	0123510053	CA1142IR	0124225004	CA1490IR	0124325053	CA1700IR
0123325013	JA1599IR	0123510056	CA828IR ▲	0124225009	CA1440IR	0124325056	CA1729IR
0123325014	JA987IR	0123510058	CA1254IR	0124225010	CA1575IR	0124325057	CA1815IR
0123325015	CA1569IR	0123510059	CA1081IR	0124225011	CA1576IR	0124325058	CA1471IR
0123325500	CA1695IR	0123510060	CA1480IR	0124225016	CA1161IR	0124325059	CA1648IR ▲
0123335001	CA1244IR	0123510061	CA855IR	0124225018	CA1747IR	0124325060	CA1743IR
0123335002	CA1044IR	0123510062	CA1070IR	0124225020	CA2024IR	0124325062	CA1654IR ▲
0123335003	CA1062IR	0123510063	CA1045IR	0124225022	CA1257IR	0124325072	CA1654IR
0123335005	CA1138IR	0123510064	CA1507IR	0124225023	CA1490IR	0124325073	CA1441IR
0123335006	CA1044IR	0123510065	CA1241IR	0124225024	CA1391IR	0124325074	CA1512IR
0123335008	CA1301IR	0123510066	CA1057IR	0124225025	CA1440IR	0124325075	CA1567IR
0123340001	CA829IR	0123510067	CA1057IR	0124225028	CA861IR	0124325079	JA1894IR
0123340002	CA740IR	0123510068	CA1300IR	0124225031	CA1146IR	0124325081	CA1729IR
0123340003	CA736IR	0123510072	CA1299IR ▲	0124225037	CA2024IR	0124325083	CA1810IR
0123340005	CA912IR	0123510074	CA1480IR	0124225041	CA1747IR	0124325085	CA1907IR
0123340007	CA1209IR ▲	0123510075	CA1480IR	0124225046	CA1391IR	0124325087	CA1773IR
0123345004	CA1061IR	0123510079	CA1300IR	0124225049	CA1747IR	0124325088	CA1446IR ▲
0123500001	CA1477IR	0123510080	CA1299IR	0124225050	CA1391IR	0124325093	CA1489IR
0123500004	CA1088IR	0123510081	CA1300IR	0124225051	CA1889IR	0124325095	CA1817IR
0123500005	CA1069IR	0123510082	CA1481IR	0124225052	CA2102IR	0124325096	CA1818IR
0123500006	CA1655IR	0123510088	CA1140IR	0124225053	CA1942IR	0124325097	CA1587IR ▲
0123500007	CA1507IR	0123510095	CA1492IR	0124225054	CA1929IR	0124325100	CA1779IR
0123500008	CA1327IR	0123510096	CA1555IR	0124225055	CA1930IR	0124325101	CA1446IR
0123505001	CA1045IR	0123510099	CA1107IR ▲	0124225056	CA2066IR	0124325102	CA1866IR
0123505002	CA1045IR	0123510100	CA1300IR	0124315001	CA1502IR	0124325105	CA1489IR
0123505003	CA1070IR	0123510101	CA1299IR	0124315003	CA1436IR	0124325106	CA1815IR
0123505004	CA1070IR	0123510102	CA1254IR	0124315004	CA1511IR	0124325108	CA1867IR
0123505005	CA828IR	0123510106	CA1590IR ▲	0124315005	CA1504IR	0124325116	CA1773IR
0123505007	CA855IR	0123510107	CA1481IR	0124315006	CA1547IR	0124325122	CA1915IR
0123505007	CA855IR	0123510108	CA1481IR	0124315007	CA1568IR	0124325125	CA1729IR
0123505008	CA1140IR ▲	0123510109	CA1590IR	0124315008	CA1566IR	0124325126	CA1815IR
0123505009	CA855IR	0123512500	CA1493IR	0124315010	CA1545IR	0124325127	CA1729IR
0123505010	CA1399IR	0123515001	CA1207IR	0124315013	CA1682IR	0124325128	CA1817IR
0123505011	CA1089IR	0123515002	CA1207IR	0124315014	CA1586IR	0124325129	CA1818IR
0123505012	CA1089IR ▲	0123515002	CA1207IR	0124315016	JA1605IR	0124325130	CA1810IR
0123505013	CA1089IR	0123515003	CA1248IR	0124315019	CA1639IR	0124325131	CA1446IR
0123505014	CA1088IR	0123515004	CA1325IR	0124315024	JA1605IR	0124325137	CA1378IR
0123510001	CA828IR	0123515007	CA1503IR	0124315027	CA1639IR	0124325139	CA1866IR
0123510002	CA1477IR	0123515008	CA1403IR	0124315029	JA1605IR	0124325141	CA2064IR *
0123510003	CA1070IR	0123515009	CA1147IR	0124315032	CA1502IR	0124325142	CA2065IR
0123510004	CA1206IR ▲	0123515010	CA1207IR	0124315036	CA1511IR	0124325145	CA1471IR
0123510005	CA1399IR	0123515010	CA1207IR	0124320001	CA1557IR	0124325146	CA1648IR
0123510006	CA828IR	0123515011	CA1147IR	0124320002	CA1684IR	0124325148	CA1743IR
0123510007	CA1142IR	0123515012	CA1141IR	0124325001	CA1446IR	0124325149	CA1446IR
0123510008	CA1147IR	0123515014	CA1089IR	0124325002	CA1402IR ▲	0124325150	CA1542IR
0123510009	CA1147IR	0123515016	CA1229IR	0124325003	CA1378IR	0124325158	CA1868IR
0123510010	CA1452IR	0123515017	CA1260IR	0124325004	CA1402IR	0124325160	CA1729IR
0123510012	CA1057IR	0123515018	CA1089IR	0124325006	JA1415IR	0124325168	CA1592IR
0123510013	CA1232IR	0123515020	CA1260IR	0124325008	CA1585IR	0124325171	CA1940IR
0123510014	CA855IR	0123515021	CA1144IR	0124325009	CA1485IR	0124325172	CA2005IR
0123510015	CA1140IR ▲	0123515022	CA1591IR	0124325010	CA1075IR	0124325185	CA1544IR
0123510017	CA1056IR ▲	0123515023	CA1207IR	0124325011	CA1512IR	0124325186	CA1866IR
0123510018	CA1206IR	0123515024	CA1141IR	0124325012	CA1441IR	0124415001	CA1561IR
0123510020	CA1507IR	0123515028	CA1204IR	0124325013	CA1542IR	0124415002	CA1581IR
0123510021	CA1206IR ▲	0123515500	CA1831IR	0124325014	CA1548IR	0124415005	CA1501IR
0123510022	CA1300IR	0123515501	CA1831IR	0124325015	CA1560IR	0124415006	CA1482IR
0123510023	CA1477IR	0123515502	CA1984IR	0124325016	CA1567IR	0124415007	CA1628IR
0123510026	CA1229IR	0123515503	CA1831IR	0124325017	CA1546IR	0124415008	CA1053IR
0123510027	CA1341IR	0123520002	CA1143IR	0124325018	CA1540IR	0124415009	CA1592IR
0123510028	CA1141IR	0123520006	CA1845IR	0124325019	CA1546IR	0124415010	CA1473IR
0123510029	CA1107IR ▲	0123520007	CA1206IR	0124325020	CA1546IR	0124415011	CA1471IR
0123510030	CA1107IR	0123520008	CA1206IR ▲	0124325021	CA1587IR	0124415012	CA1648IR
0123510031	CA1076IR	0123520011	CA1845IR	0124325022	CA1587IR	0124415013	CA1470IR
0123510032	CA828IR ▲	0123520012	CA1845IR	0124325023	CA1342IR	0124415014	CA1470IR
0123510033	CA1140IR	0123520013	CA1845IR	0124325024	CA1544IR	0124415015	CA1223IR
0123510034	CA828IR	0123520014	CA1848IR	0124325031	CA1544IR	0124415016	CA1636IR
0123510037	CA1478IR	0123520017	CA1491IR	0124325032	CA1542IR	0124415023	CA1748IR
0123510038	CA1299IR	0123520023	CA1630IR	0124325033	CA1560IR	0124415025	CA1592IR
0123510039	CA1057IR	0123525500	CA2040IR	0124325035	CA1587IR	0124415026	CA1858IR
0123510040	CA1081IR	0123525501	CA1663IR	0124325036	CA1546IR ▲	0124415030	CA1636IR
0123510043	CA1328IR	0123525502	CA1633IR	0124325039	CA1489IR	0124415032	CA1636IR
0123510044	CA1571IR	0123540002	CA1081IR ▲	0124325040	CA1732IR ▲	0124415038	CA1470IR
0123510045	CA1321IR	0123545001	CA1088IR	0124325044	CA1817IR	0124415040	CA1470IR
0123510047	CA1144IR	0123545002	CA1069IR	0124325045	CA1732IR	0124415041	CA1470IR

O.E. NO.	HC-PARTS	O.E. NO.	HC-PARTS	O.E. NO.	HC-PARTS	O.E. NO.	HC-PARTS		
0124415043	CA1628IR	0124515081	CA1582IR	0124525135	CA1824IR	0136355030	DC1014		
0124425004	CA1740IR	0124515083	CA1541IR	0124525136	CA1944IR	0136355060	DC1014		
0124425005	CA1833IR	0124515085	CA1658IR	0124525137	CA1877IR	0136355072	DC1016		
0124425009	CA1765IR	0124515086	CA1045IR	0124525139	CA1974IR	0136355081	DC1017		
0124425010	CA1658IR	0124515087	CA1688IR	0124525140	CA1876IR	0986010028	CS122		
0124425013	CA1860IR	0124515088	CA1752IR	0124525141	CA1827IR	0986010030	CS162		
0124425015	CA1909IR	0124515090	CA1688IR	0124525143	CA1961IR	0986010031	CS162		
0124425018	CA1945IR	0124515091	CA1481IR	0124525151	CA1918IR	0986010033	CS162		
0124425019	CA1592IR	0124515095	CA1740IR	0124525187	CA2011IR	0986010040	CS66		
0124425020	CA1882IR	0124515096	CA1740IR	▲	0124525525	CA1782IR	0986010041	CS66	
0124425021	CA1748IR	0124515098	CA1660IR	0124555027	CA1985IR	0986010060	CS60		
0124425022	CA1581IR	0124515101	CA1644IR	0124555001	CA1666IR	0986010110	CS83		
0124425024	CA1748IR	0124515105	CA1826IR	0124555002	CA1666IR	0986010128	CS70		
0124425025	CA1581IR	0124515110	CA1394IR	▲	0124555003	CA1694IR	0986010130	CS87	
0124425027	CA1765IR	0124515113	CA1854IR	▲	0124555004	CA1666IR	0986010131	CS87	
0124425028	CA1658IR	0124515114	CA1481IR	0124555005	CA1699IR	0986010140	CS74		
0124425029	CA1860IR	▲	0124515117	CA1394IR	0124555008	CA1851IR	0986010150	CS93	
0124425033	CA1916IR	0124515120	CA1854IR	▲	0124555009	CA1853IR	0986010170	CS69	
0124425034	CA1887IR	0124515121	CA1394IR	0124555013	CA1870IR	0986010190	CS170		
0124425037	CA1860IR	0124515124	CA1394IR	▲	0124555014	CA1847IR	0986010191	CS170	
0124425039	CA1878IR	0124515125	CA1394IR	0124555017	CA1853IR	0986010200	CS352		
0124425040	CA1916IR	0124515131	CA1656IR	0124555018	CA1917IR	0986010201	CS352		
0124425048	CA1916IR	0124515132	CA1872IR	0124555020	CA1853IR	0986010220	CS168		
0124425050	CA1960IR	0124525001	CA1673IR	▲	0124555022	CA1666IR	0986010221	CS168	
0124425053	CA1740IR	0124525008	CA1746IR	0124555027	CA1853IR	0986010248	CS278		
0124425056	CA1740IR	0124525009	CA1811IR	0124555028	CA1853IR	0986010250	CS263		
0124425058	CA2045IR	0124525010	CA1678IR	0124555032	CA1666IR	0986010251	CS263		
0124425059	CA1994IR	0124525012	CA1730IR	0124555040	CA1694IR	0986010258	CS263		
0124425060	CA1973IR	0124525014	CA1673IR	0124555041	CA1694IR	0986010260	CS142		
0124425069	CA1878IR	0124525016	CA1683IR	0124555065	CA1666IR	0986010261	CS142		
0124425070	CA1887IR	0124525020	CA1837IR	0124615002	CA1509IR	0986010268	CS142		
0124425071	CA1860IR	0124525022	CA1730IR	0124615006	CA1763IR	▲	0986010268	CS355	
0124425074	CA1945IR	0124525026	CA1825IR	0124615007	CA1813IR	0986010270	CS154		
0124425096	CA2045IR	0124525027	CA1841IR	0124615009	CA1769IR	0986010271	CS154		
0124425097	CA1994IR	0124525028	CA1823IR	0124615012	CA1776IR	0986010280	CS130		
0124425100	CA1884IR	0124525029	CA1673IR	0124615015	CA1630IR	0986010280	CS93		
0124510001	CA1854IR	0124525030	CA1828IR	0124615016	CA1763IR	▲	0986010281	CS130	
0124515004	CA1765IR	0124525031	CA2067IR	*	0124615017	CA1763IR	0986010281	CS93	
0124515005	CA1577IR	0124525034	CA1674IR	0124615019	CA1630IR	0986010290	CS275		
0124515010	CA1394IR	0124525035	CA1761IR	0124615026	CA1749IR	0986010291	CS275		
0124515011	CA1394IR	0124525039	CA1782IR	0124615027	CA1553IR	0986010300	CS278		
0124515012	CA1394IR	▲	0124525040	CA1828IR	0124615028	CA1775IR	0986010308	CS278	
0124515013	CA1445IR	0124525042	CA1774IR	0124615031	CA1819IR	0986010310	CS310		
0124515017	CA1443IR	0124525043	CA1824IR	0124615033	CA1630IR	0986010311	CS310		
0124515018	CA1443IR	0124525044	CA1827IR	0124615035	CA1630IR	0986010330	CS180		
0124515019	CA1439IR	0124525045	CA1774IR	0124615038	CA1763IR	0986010331	CS180		
0124515020	CA1445IR	0124525047	CA1863IR	0124615040	CA1763IR	0986010340	CS131		
0124515021	CA1445IR	0124525049	CA1824IR	0124615044	CA1776IR	0986010341	CS131		
0124515022	CA1644IR	0124525050	CA1782IR	0124615049	CA1776IR	0986010358	CS77		
0124515025	CA1759IR	0124525054	CA1908IR	0124625001	CA1861IR	▲	0986010360	CS115	
0124515026	CA1541IR	0124525055	CA1908IR	0124625002	CA1701IR	0986010370	CS116		
0124515027	CA1664IR	▲	0124525059	CA1774IR	0124625003	CA1861IR	0986010378	CS116	
0124515028	CA1588IR	0124525060	CA1988IR	0124625006	CA1846IR	0986010398	CS123		
0124515031	CA1821IR	0124525063	CA1914IR	0124625014	CA1859IR	0986010400	CS78		
0124515032	CA1582IR	0124525064	CA1913IR	0124625018	CA1820IR	0986010401	CS78		
0124515033	CA1740IR	0124525066	CA1782IR	0124625019	CA1764IR	0986010408	CS78		
0124515034	CA1664IR	0124525067	CA1782IR	0124625022	CA1840IR	0986010410	CS79		
0124515035	CA1549IR	0124525070	CA1944IR	0124625024	CA2028IR	0986010411	CS79		
0124515038	CA1445IR	▲	0124525074	CA1985IR	0124625028	CA1912IR	0986010418	CS79	
0124515039	CA1644IR	0124525076	CA1877IR	0124625045	CA1859IR	0986010430	CS156		
0124515040	CA1588IR	0124525080	CA1825IR	0124655001	CA1739IR	0986010431	CS156		
0124515041	CA2076IR	*	0124525081	CA1974IR	0124655002	CA1739IR	0986010450	CS285	
0124515044	CA1679IR	0124525082	CA1876IR	0124655003	CA1693IR	0986010451	CS285		
0124515045	CA1623IR	0124525083	CA2009IR	0124655004	CA1739IR	0986010468	CS77		
0124515046	CA1689IR	0124525084	CA1827IR	0124655005	CA1812IR	0986010470	CS298		
0124515048	CA2076IR	*	0124525086	CA2068IR	*	0124655007	CA1880IR	0986010480	CS79
0124515049	CA1731IR	0124525088	CA1811IR	0124655008	CA1883IR	0986010498	CS79		
0124515050	CA1591IR	0124525089	CA1678IR	0124655009	CA1871IR	0986010530	CS62		
0124515054	CA1439IR	0124525091	CA1782IR	0124655012	CA1883IR	0986010570	CS276		
0124515055	CA1656IR	0124525092	CA1782IR	0124655014	CA1939IR	0986010580	CS117		
0124515056	CA1872IR	0124525093	CA1985IR	0124655016	CA1739IR	0986010590	CS338		
0124515057	CA1549IR	0124525098	CA1763IR	0124655019	CA1883IR	0986010590	CS353		
0124515058	CA1588IR	0124525101	CA1918IR	0124655023	CA1739IR	0986010591	CS353		
0124515059	CA1754IR	0124525102	CA1782IR	▲	0124655025	CA1997IR	0986010600	CS361	
0124515060	CA2076IR	*	0124525113	CA2007IR	0124655036	CA1693IR	0986010601	CS361	
0124515064	CA1481IR	0124525114	CA1986IR	0124655037	CA1693IR	0986010610	CS76		
0124515067	CA2064IR	*	0124525116	CA1992IR	0124655039	CA1693IR	0986010630	CS119	
0124515068	CA1445IR	0124525128	CA1763IR	0125711017	CA1928IR	0986010648	CS72		
0124515080	CA1577IR	0124525133	CA1827IR	0125711059	CA1928IR	0986010658	CS292		

O.E. NO.	HC-PARTS	O.E. NO.	HC-PARTS	O.E. NO.	HC-PARTS	O.E. NO.	HC-PARTS
<b>BOSCH <i>Continued</i></b>							
0986010658	JS370	0986011460	CS383	0986012600	CS294	0986013571	JS339
0986010660	CS135	0986011490	CS198	0986012610	CS507	0986013581	JS356
0986010678	CS89	0986011510	CS198	0986012620	CS378	0986013581	JS765
0986010690	CS1166	0986011513	CS198	0986012658	CS348	0986013590	CS293
0986010690	CS80	0986011520	CS99	0986012660	CS508	0986013600	CS389
0986010691	CS80	0986011550	CS194	0986012670	CS572	0986013618	CS372
0986010710	CS86	0986011570	CS191	0986012671	CS572	0986013620	CS393
0986010718	CS86	0986011580	CS565	0986012680	CS511	0986013621	CS393
0986010720	CS183	0986011600	CS166	0986012690	CS716	0986013630	CS504
0986010730	CS324	0986011601	CS166	0986012700	CS501	0986013640	CS351
0986010731	CS785	0986011611	CS18	0986012710	CS335	0986013641	CS351
0986010770	CS184	0986011651	CS95	0986012730	CS384	0986013650	CS370
0986010788	CS132	0986011658	CS95	0986012740	CS710	0986013660	CS510
0986010810	CS508	0986011671	CS126	0986012780	CS783	0986013670	CS300
0986010830	CS185	0986011671	CS94	0986012821	JS316	0986013690	CS604
0986010850	CS81	0986011690	CS150	0986012831	JS674	0986013720	CS595
0986010858	CS81	0986011701	CS127	0986012851	JS315	0986013733	CS191
0986010860	CS273	0986011710	CS151	0986012851	JS375	0986013740	CS344
0986010870	CS119	0986011730	CS126	0986012861	JS327	0986013741	CS344
0986010880	CS286	0986011731	CS126	0986012871	JS350	0986013791	CS365
0986010881	CS286	0986011731	CS94	0986012881	JS394	0986013801	CS362
0986010890	CS268	0986011748	CS95	0986012901	JS373	0986013811	CS381
0986010900	CS311	0986011770	CS169	0986012911	JS304	0986013821	CS366
0986010910	CS185	0986011771	CS169	0986012921	JS556	0986013831	CS573
0986010918	CS185	0986011780	CS280	0986012931	JS329	0986013841	CS385
0986010920	CS136	0986011781	CS280	0986012931	JS343	0986013850	CS390
0986010920	CS272	0986011790	CS163	0986012950	CS120	0986013851	CS390
0986010928	CS136	0986011791	CS163	0986012980	CS311	0986013861	CS317
0986010928	CS272	0986011801	CS155	0986012990	CS81	0986013871	CS333
0986010930	CS290	0986011810	CS321	0986013000	CS268	0986013880	CS547
0986010940	CS299	0986011811	CS321	0986013010	CS327	0986013910	CS576
0986010950	CS337	0986011820	CS165	0986013050	CS295	0986013913	CS576
0986010960	CS607	0986011830	CS315	0986013070	CS1110	0986013940	CS371
0986010961	CS607	0986011838	CS315	0986013088	CS322	0986013941	CS371
0986010970	CS608	0986011871	CS91	0986013098	CS341	0986013971	JS376
0986010971	CS608	0986011891	CS90	0986013100	CS356	0986013981	JS386
0986010980	CS391	0986011898	CS90	0986013118	CS343	0986013991	JS521
0986010990	CS114	0986011910	CS139	0986013120	CS326	0986014041	JS765
0986011000	CS113	0986011911	CS139	0986013121	CS326	0986014051	JS319
0986011010	CS707	0986011921	CS147	0986013140	CS386	0986014061	JS645
0986011020	CS1173	0986011941	CS308	0986013150	CS360	0986014071	JS629
0986011020	CS550	0986011950	CS232	0986013160	CS346	0986014081	JS354
0986011030	CS128	0986012000	JS331	0986013180	CS349	0986014091	JS353
0986011031	CS128	0986012010	JS331	0986013190	CS345	0986014101	JS365
0986011040	CS804	0986012061	JS336	0986013200	CS684	0986014111	JS344
0986011050	CS188	0986012090	JS302	0986013201	CS354	0986014151	JS362
0986011060	CS230	0986012101	JS307	0986013210	CS306	0986014161	JS355
0986011061	CS230	0986012111	JS301	0986013211	CS306	0986014181	JS662
0986011070	CS148	0986012121	JS395	0986013228	CS714	0986014191	JS345
0986011080	CS289	0986012150	JS315	0986013230	CS316	0986014201	JS309
0986011081	CS289	0986012160	JS310	0986013231	CS316	0986014211	JS378
0986011090	CS347	0986012161	JS310	0986013240	CS373	0986014221	JS513
0986011110	CS314	0986012171	JS342	0986013241	CS373	0986014231	JS308
0986011111	CS314	0986012211	JS333	0986013260	CS506	0986014231	JS935
0986011130	CS503	0986012221	JS333	0986013270	CS592	0986014261	JS649
0986011140	CS114	0986012231	JS300	0986013280	CS592	0986014271	JS363
0986011150	CS188	0986012241	JS755	0986013293	CS592	0986014281	JS379
0986011160	CS231	0986012251	JS335	0986013298	CS592	0986014331	JS558
0986011161	CS231	0986012261	JS646	0986013340	CS578	0986014341	JS670
0986011170	CS387	0986012271	JS325	0986013350	CS358	0986014350	JS380
0986011180	CS398	0986012281	JS327	0986013368	CS329	0986014351	JS380
0986011200	CS103	0986012290	JS305	0986013380	CS392	0986014361	JS630
0986011220	CS240	0986012290	JS759	0986013400	CS376	0986014371	JS512
0986011221	CS240	0986012291	JS305	0986013418	CS350	0986014391	JS659
0986011240	CS186	0986012301	JS349	0986013420	CS502	0986014451	JS669
0986011250	CS605	0986012311	JS388	0986013430	CS526	0986014471	JS392
0986011270	CS530	0986012328	CS282	0986013440	CS564	0986014481	JS381
0986011280	CS97	0986012330	CS267	0986013450	CS881	0986014491	JS377
0986011290	CS269	0986012340	CS326	0986013470	CS297	0986014501	JS382
0986011291	CS269	0986012341	CS326	0986013478	CS297	0986014511	JS385
0986011310	CS232	0986012350	CS78	0986013480	CS186	0986014531	JS317
0986011311	CS232	0986012358	CS78	0986013490	CS120	0986014541	JS357
0986011330	CS394	0986012418	CS268	0986013501	JS325	0986014541	JS631
0986011331	CS394	0986012420	CS395	0986013511	JS325	0986014560	CS617
0986011360	CS120	0986012440	CS340	0986013521	JS312	0986014570	CS514
0986011370	CS726	0986012470	CS339	0986013531	JS338	0986014580	CS500
0986011380	CS388	0986012480	CS121	0986013541	JS333	0986014590	CS542
0986011430	CS98	0986012570	CS690	0986013541	JS371	0986014591	CS542
0986011440	CS195	0986012598	CS294	0986013551	JS306	0986014600	CS330

O.E. NO.	HC-PARTS	O.E. NO.	HC-PARTS	O.E. NO.	HC-PARTS	O.E. NO.	HC-PARTS
0986014610	CS328	0986015791	JS668	0986016880	CS879	0986017920	CS879
0986014628	CS548	0986015910	CS709	0986016890	CS372	0986017930	CS1111
0986014630	CS569	0986015920	JS568	0986016900	CS1059	0986017940	CS1063
0986014640	CS509	0986015930	CS554	0986016910	CS585	0986017950	CS611
0986014660	CS331	0986015970	CS713	0986016920	CS792	0986017960	CS1180
0986014680	CS794	0986015981	JS633	0986016930	CS884	0986017980	CS1331
0986014691	CS524	0986015991	JS647	0986016950	CS885	0986017990	CS1279
0986014700	CS374	0986016001	JS628	0986016961	CS711	0986018000	CS1178
0986014710	CS90	0986016011	JS637	0986016980	CS974	0986018010	CS1257
0986014718	CS90	0986016021	JS539	0986016990	CS801	0986018010	CS519
0986014730	CS706	0986016031	JS517	0986017000	CS789	0986018020	CS1114
0986014740	CS395	0986016031	JS660	0986017010	CS782	0986018030	CS1196
0986014761	JS389	0986016041	JS522	0986017020	CS973	0986018040	CS1119
0986014770	CS364	0986016100	CS1167	0986017030	CS796	0986018050	CS1132
0986014771	CS364	0986016110	CS614	0986017041	CS1038	0986018060	CS1041
0986014800	CS396	0986016120	CS715	0986017050	CS962	0986018080	CS1340
0986014810	CS559	0986016130	CS551	0986017060	CS1050	0986018090	CS1161
0986014820	CS559	0986016141	CS1177	0986017070	CS960	0986018100	CS1116
0986014830	CS683	0986016141	CS373	0986017110	CS1067	0986018151	CS703
0986014840	CS377	0986016151	JS651	0986017120	CS519	0986018161	CS1032
0986014860	CS1183	0986016161	JS753	0986017131	CS964	0986018180	CS1172
0986014861	CS535	0986016171	JS651	0986017160	CS1046	0986018190	CS282
0986014870	CS546	0986016190	CS598	0986017170	CS793	0986018200	CS294
0986014890	CS515	0986016200	CS1073	0986017180	CS1048	0986018210	CS322
0986014900	CS516	0986016210	CS1201	0986017190	CS1113	0986018220	CS341
0986014910	CS544	0986016230	CS615	0986017220	CS376	0986018230	CS592
0986014920	CS99	0986016240	CS624	0986017220	CS709	0986018240	CS329
0986014940	CS583	0986016250	CS888	0986017230	CS709	0986018250	CS350
0986014950	CS332	0986016261	JS534	0986017240	CS1112	0986018260	CS372
0986014951	CS332	0986016271	JS358	0986017250	CS1040	0986018270	CS1202
0986014960	CS686	0986016280	CS727	0986017260	CS1044	0986018290	CS1185
0986014971	JS365	0986016290	CS618	0986017260	CS1485	0986018310	CS594
0986014981	JS325	0986016290	CS713	0986017300	CS984	0986018321	JS941
0986014991	JS1000	0986016300	CS619	0986017320	CS1077	0986018331	JS1091
0986014991	JS325	0986016310	CS616	0986017330	CS982	0986018340	CS1074
0986014991	JS640	0986016320	CS723	0986017361	CS882	0986018350	CS1188
0986015001	JS525	0986016330	CS612	0986017381	CS684	0986018360	CS1179
0986015010	CS310	0986016340	CS599	0986017391	CS684	0986018370	CS1269
0986015011	CS310	0986016350	CS685	0986017420	CS976	0986018380	CS1165
0986015021	JS397	0986016370	CS531	0986017430	CS1185	0986018390	CS1181
0986015031	JS317	0986016380	CS1075	0986017440	CS1049	0986018400	CS1060
0986015040	CS106	0986016390	CS1162	0986017440	CS589	0986018410	CS1047
0986015050	CS577	0986016390	CS331	0986017450	CS988	0986018420	CS502
0986015090	CS613	0986016400	CS681	0986017460	CS974	0986018430	CS1197
0986015158	CS357	0986016401	CS681	0986017470	CS1055	0986018450	CS1212
0986015178	CS708	0986016411	CS584	0986017480	CS1051	0986018460	CS1067
0986015190	CS609	0986016421	JS563	0986017490	CS1118	0986018470	CS1176
0986015200	CS562	0986016431	JS671	0986017500	JS1135	0986018480	JS1236
0986015230	CS329	0986016441	JS657	0986017510	CS1126	0986018490	CS1203
0986015230	CS359	0986016451	JS1092	0986017520	CS989	0986018500	CS1200
0986015260	CS541	0986016470	CS719	0986017530	CS986	0986018511	CS978
0986015270	CS721	0986016480	CS1058	0986017541	JS759	0986018521	CS542
0986015320	CS606	0986016480	CS1070	0986017551	JS766	0986018531	CS1108
0986015328	CS606	0986016500	JS560	0986017561	JS357	0986018541	JS1147
0986015331	JS642	0986016511	JS652	0986017571	JS1092	0986018551	JS1152
0986015341	JS359	0986016520	CS198	0986017591	JS1080	0986018561	CS886
0986015351	JS644	0986016530	CS566	0986017601	JS650	0986018570	CS1117
0986015391	JS538	0986016531	CS566	0986017611	JS892	0986018571	CS1117
0986015401	CS567	0986016550	CS887	0986017641	JS632	0986018581	CS1060
0986015411	CS580	0986016560	CS878	0986017651	JS1003	0986018591	CS681
0986015420	CS1184	0986016570	CS784	0986017661	JS1100	0986018601	JS648
0986015430	CS699	0986016581	JS672	0986017681	JS747	0986018611	CS1055
0986015470	CS574	0986016591	JS627	0986017691	JS350	0986018621	JS1142
0986015481	JS557	0986016600	CS980	0986017721	JS643	0986018630	JS1226
0986015540	CS555	0986016611	CS338	0986017750	CS1123	0986018641	CS1262
0986015551	CS692	0986016651	JS648	0986017760	CS1061	0986018651	CS1128
0986015560	CS687	0986016660	CS680	0986017770	CS1053	0986018661	CS1251
0986015600	CS585	0986016681	JS999	0986017781	CS981	0986018671	CS523
0986015610	CS611	0986016700	CS620	0986017790	CS1264	0986018680	JS1135
0986015630	CS375	0986016711	CS791	0986017790	CS992	0986018690	JS1024
0986015670	CS688	0986016730	JS1016	0986017810	CS1169	0986018701	JS1024
0986015670	CS983	0986016740	JS1214	0986017830	CS1062	0986018711	JS1096
0986015680	US827	0986016750	CS597	0986017840	CS1057	0986018721	JS1000
0986015701	CS561	0986016780	CS725	0986017850	CS1163	0986018731	JS770
0986015721	JS626	0986016790	CS788	0986017860	CS269	0986018741	JS1023
0986015740	CS588	0986016800	CS880	0986017863	CS269	0986018751	JS392
0986015751	JS520	0986016840	CS600	0986017870	CS595	0986018761	JS913
0986015761	JS663	0986016860	CS802	0986017880	CS1261	0986018770	CS1179
0986015781	JS661	0986016870	CS1037	0986017890	CS1072	0986018780	CS1274

O.E. NO.	HC-PARTS	O.E. NO.	HC-PARTS	O.E. NO.	HC-PARTS	O.E. NO.	HC-PARTS
<b>BOSCH <i>Continued</i></b>							
0986018790	CS121	0986020193	CS1474	0986021480	CS1399	0986023340	JS1351
0986018800	CS1199	0986020220	CS1324	0986021490	CS1380	0986023370	JS1349
0986018810	CS564	0986020230	CS1347	0986021500	CS1412	0986023380	CS1377
0986018830	CS1445	0986020240	CS1294	0986021520	CS388	0986023420	JS553
0986018840	CS1254	0986020250	CS1293	0986021530	CS1450	0986023430	CS1292
0986018850	CS1075	0986020260	CS1323	0986021550	CS1407	0986023440	CS109
0986018860	CS1255	0986020270	CS1405	0986021560	CS1453	0986023450	US857
0986018870	CS1272	0986020280	CS1286	0986021580	CS1404	0986023460	JS730
0986018880	CS1213	0986020290	CS1330	0986021590	CS1379	0986023470	JS1366
0986018890	CS1256	0986020300	CS1393	0986021600	CS1244	0986023480	CS1290
0986018900	CS1335	0986020320	CS1397	0986021610	CS1423	0986023490	CS1204
0986018910	CS1271	0986020330	CS1322	0986021620	CS1271	0986023500	CS1277
0986018920	CS1337	0986020350	CS1283	0986021630	CS1435	0986023510	CS693
0986018930	CS1194	0986020370	CS1208	0986021640	CS1389	0986023520	JS1359
0986018940	CS1187	0986020381	JS1095	0986021651	CS1260	0986023530	CS1415
0986018950	CS1203	0986020391	JS925	0986021671	CS1344	0986023540	JS1295
0986018960	CS1198	0986020401	JS1139	0986021741	CS1273	0986023550	JS1308
0986018970	CS1326	0986020411	CS1459	0986021810	CS1421	0986023560	JS1358
0986018990	CS1243	0986020421	JS1221	0986021820	CS1408	0986023570	CS1403
0986018993	CS1243	0986020441	JS1215	0986021830	CS1045	0986023580	CS1391
0986019000	CS191	0986020491	JS1017	0986021870	CS1209	0986023590	CS1386
0986019003	CS191	0986020501	JS1153	0986021970	CS1417	0986023600	JS1365
0986019010	CS1248	0986020511	JS756	0986021973	CS1417	0986023610	JS1317
0986019020	CS1130	0986020521	JS634	0986022003	CS1466	0986023620	CS1058
0986019030	CS610	0986020531	JS760	0986022010	CS1419	0986023630	JS1312
0986019040	CS807	0986020541	JS1233	0986022020	CS1467	0986023640	JS1353
0986019081	JS1004	0986020551	JS1230	0986022033	JS1158	0986023650	CS1043
0986019091	JS925	0986020551	JS1236	0986022101	CS1210	0986023660	CS1438
0986019101	JS1001	0986020561	JS1299	0986022111	CS1191	0986023670	JS1320
0986019121	JS1023	0986020571	JS1223	0986022121	CS1275	0986023680	JS1225
0986019131	JS1024	0986020581	JS1088	0986022131	CS1341	0986023690	CS1338
0986019141	JS918	0986020591	JS1155	0986022151	CS1206	0986023700	CS19
0986019151	JS1141	0986020601	JS1154	0986022250	CS1400	0986023710	JS908
0986019161	JS918	0986020621	JS912	0986022260	CS1420	0986023720	JS1319
0986019171	JS1021	0986020631	JS1302	0986022241	CS1379	0986023740	CS800
0986019181	JS894	0986020671	JS1297	0986022470	CS1440	0986023760	CS1426
0986019200	CS985	0986020681	JS1219	0986022561	CS961	0986023770	JS1360
0986019220	JS762	0986020691	JS924	0986022571	CS1211	0986023790	JS901
0986019271	CS684	0986020701	JS763	0986022581	CS1265	0986023800	CS1115
0986019291	CS963	0986020711	JS939	0986022591	JS1311	0986023810	CS1052
0986019301	CS1125	0986020721	JS1235	0986022601	JS1303	0986023820	CS946
0986019311	CS788	0986020731	JS1136	0986022611	JS1364	0986023830	CS1381
0986019320	CS689	0986020741	JS1094	0986022621	JS1321	0986023840	JS1217
0986019361	JS1158	0986020751	JS890	0986022631	CS1396	0986023850	CS1416
0986019370	CS990	0986020761	JS917	0986022673	CS1466	0986023870	JS1367
0986019500	CS1249	0986020771	JS1103	0986022680	CS994	0986023890	JS1316
0986019550	CS1266	0986020780	CS1282	0986022690	JS1159	0986023900	JS1238
0986019830	CS1285	0986020791	JS1157	0986022700	JS1221	0986023910	JS1224
0986019840	CS1395	0986020801	JS754	0986022710	CS1171	0986023920	JS1361
0986019843	CS1395	0986020811	JS914	0986022720	JS1140	0986023970	JS1357
0986019860	CS1071	0986020821	JS1137	0986022740	JS1227	0986023980	JS1304
0986019870	CS1257	0986020831	JS1015	0986022750	CS200	0986024130	CS1509
0986019873	CS1257	0986020841	JS1085	0986022760	CS1242	0986024140	CS1195
0986019880	JS942	0986020850	CS1064	0986022770	JS1298	0986024150	JS922
0986019890	CS1343	0986020860	CS1398	0986022780	JS923	0986024160	JS1300
0986019900	CS378	0986020870	CS1257	0986022790	CS1329	0986024170	JS1229
0986019910	CS1190	0986020880	CS1333	0986022800	CS1332	0986024180	CS1401
0986019920	CS1253	0986020890	CS1413	0986022820	JS1234	0986024190	CS1385
0986019930	CS1053	0986020900	CS1289	0986022830	CS1186	0986024200	CS1346
0986019940	CS1241	0986021010	CS1475	0986022840	CS1336	0986024210	CS1192
0986019960	CS1250	0986021030	CS1179	0986022850	CS1246	0986030050	CG19
0986019970	CS1247	0986021041	CS1109	0986022880	CS1473	0986030110	CA734IR
0986019980	CS984	0986021051	CS1174	0986022900	CS1384	0986030120	CA77IR
0986019991	CS579	0986021060	JS1236	0986022910	CS1252	0986030130	CA76IR
0986020031	JS664	0986021070	JS1315	0986022930	CS1328	0986030140	CA616IR
0986020041	JS658	0986021190	CS1382	0986022940	CS1383	0986030150	CA62
0986020061	JS641	0986021210	CS1394	0986022950	JS1149	0986030170	CA37
0986020070	CS1267	0986021217	CS1394	0986022960	JS1156	0986030190	CA118
0986020073	CS1267	0986021220	CS1392	0986022970	JS1006	0986030210	CA183
0986020091	CS1160	0986021230	CS1406	0986022980	CS1463	0986030250	CA89
0986020093	CS1160	0986021240	CS1334	0986022990	CS1464	0986030251	CA89
0986020113	JS999	0986021260	CS1172	0986023093	CS1420	0986030290	CA180
0986020121	CS1263	0986021280	CS1249	0986023120	CS1449	0986030300	CA334IR
0986020131	CS1193	0986021290	CS1072	0986023180	JS1352	0986030320	CA134
0986020141	CS1207	0986021300	CS1414	0986023190	CS201	0986030350	CA283
0986020151	CS691	0986021310	CS1249	0986023220	JS1355	0986030410	CA184
0986020170	CS1268	0986021320	CS1072	0986023230	JS1310	0986030450	CA154
0986020181	CS977	0986021351	CS1245	0986023250	CS1291	0986030480	CA88
0986020190	CS1474	0986021360	CS1410	0986023260	JS1362	0986030481	CA88



O.E. NO.	HC-PARTS	O.E. NO.	HC-PARTS	O.E. NO.	HC-PARTS	O.E. NO.	HC-PARTS
0986030500	CA273	0986031210	CA124IR	0986032320	CA268IR	0986033570	CA187IR
0986030518	CA328IR	0986031230	CA334IR	0986032321	CA268IR	0986033670	CA345IR
0986030520	CA333IR	0986031250	CA130IR	0986032340	CA307IR	0986033680	CA345IR
0986030538	CA163IR	0986031250	CA155IR	0986032341	CA307IR	0986033710	CA263IR
0986030548	CA163IR	0986031251	CA130IR	0986032361	CA229IR	0986033720	CA263IR
0986030550	CA271IR	0986031251	CA155IR	0986032381	JA130	0986033728	CA345IR
0986030580	CA141IR	0986031260	CA341IR	0986032391	JA131	0986033730	CA345IR
0986030588	CA141IR	0986031270	CA339IR	0986032401	JA130	0986033740	CA321IR
0986030590	CA52IR	0986031280	CA511IR	0986032421	JA131	0986033750	CA1072IR
0986030598	CA52IR	0986031290	CA152IR	0986032431	JA100	0986033750	CA321IR
0986030618	CA136IR	0986031300	CA186IR	0986032441	JA101	0986033760	CA241IR
0986030628	CA139IR	0986031310	CA187IR	0986032451	JA121	0986033768	CA241IR
0986030660	CA186IR	0986031320	CA368IR	0986032471	JA119	0986033780	CA87IR
0986030670	CA199IR	0986031330	CA340IR	0986032571	JA137	0986033810	CA345IR
0986030690	CA196IR	0986031340	CA212IR	0986032591	JA131	0986033811	CA345IR
0986030700	CA121IR	0986031350	CA96IR	0986032591	JA137	0986033820	CA334IR
0986030710	CA125IR	0986031358	CA96IR	0986032601	JA150IR	0986033823	CA334IR
0986030720	CA87IR	0986031360	CA207IR	0986032611	JA151IR	0986033830	CA306IR
0986030721	CA87IR	0986031370	CA327IR	0986032631	JA152IR	0986033831	CA306IR
0986030730	CA88IR	0986031373	CA327IR	0986032641	JA795IR	0986033840	CA500IR
0986030731	CA88IR	0986031388	CA61IR	0986032651	JA104IR	0986033840	CA857IR
0986030740	CA136IR	0986031390	CA235IR	0986032661	JA158IR	0986033840	CA858IR
0986030748	CA136IR	0986031391	CA235IR	0986032661	JA887IR	0986033841	CA857IR
0986030750	CA139IR	0986031400	CA87IR	0986032671	JA108IR	0986033841	CA858IR
0986030758	CA139IR	0986031408	CA87IR	0986032681	JA104IR	0986033860	CA293IR
0986030768	CA226IR	0986031410	CA119IR	0986032691	JA138	0986033878	CA910IR
0986030768	CA305IR	0986031411	CA119IR	0986032700	CA71	0986033880	CA255IR
0986030778	CA60IR	0986031420	CA287IR	0986032710	CA366IR	0986033881	CA255IR
0986030780	CA94IR	0986031430	CA87IR	0986032720	CA227IR	0986033890	CA129IR
0986030788	CA94IR	0986031431	CA87IR	0986032720	CA749IR	0986033891	CA129IR
0986030798	CA126IR	0986031440	CA195IR	0986032721	CA749IR	0986033891	CA1435IR
0986030800	CA259IR	0986031450	CA222IR	0986032738	CA320IR	0986033900	CA310IR
0986030810	CA110IR	0986031453	CA222IR	0986032740	CA288IR	0986033900	CA592IR
0986030811	CA110IR	0986031460	CA228IR	0986032748	CA288IR	0986033910	CA567IR
0986030830	CA42IR	0986031461	CA228IR	0986032770	CA84IR	0986033940	CA312IR
0986030831	CA42IR	0986031470	CA706IR	0986032781	CA131IR	0986033970	CA315IR
0986030848	CA221IR	0986031478	CA706IR	0986032790	CA294IR	0986033971	CA315IR
0986030850	CA48IR	0986031480	CA367IR	0986032791	CA294IR	0986033980	CA150IR
0986030851	CA48IR	0986031488	CA367IR	0986032800	CA87IR	0986033981	CA150IR
0986030861	CA48IR	0986031500	CA237IR	0986032930	CA238IR	0986033990	CA512IR
0986030870	CA128IR	0986031508	CA237IR	0986032930	CA358IR	0986033998	CA512IR
0986030871	CA128IR	0986031518	CA237IR	0986032980	CA272IR	0986034000	CA373IR
0986030880	CA99IR	0986031528	CA140IR	0986032990	CA591IR	0986034001	CA373IR
0986030881	CA99IR	0986031530	CA140IR	0986033010	CA591IR	0986034008	CA373IR
0986030900	CA507IR	0986031540	CA205IR	0986033013	CA591IR	0986034018	CA299IR
0986030901	CA507IR	0986031550	CA236IR	0986033070	CA603IR	0986034020	CA335IR
0986030908	CA507IR	0986031641	CA165IR	0986033090	CA502IR	0986034030	CA335IR
0986030918	CA158IR	0986031670	CA84IR	0986033100	CA240IR	0986034048	CA141IR
0986030928	CA264IR	0986031671	CA84IR	0986033118	CA328IR	0986034050	CA1072IR
0986030928	CA508IR	0986031711	CA169IR	0986033120	CA251IR	0986034050	CA321IR
0986030938	CA264IR	0986031720	CA81IR	0986033140	CA263IR	0986034060	CA345IR
0986030940	CA127IR	0986031730	CA84	0986033150	CA263IR	0986034070	CA595IR
0986030948	CA127IR	0986031740	CA149IR	0986033165	CA320IR	0986034080	CA251IR
0986030970	CA316IR	0986031741	CA149IR	0986033170	CA251IR	0986034110	CA251IR
0986030971	CA316IR	0986031830	CA170IR	0986033188	CA242IR	0986034120	CA566IR
0986030980	CA129IR	0986031831	CA170IR	0986033200	CA140IR	0986034130	CA320IR
0986030981	CA129IR	0986031840	CA166	0986033210	CA141IR	0986034140	CA322IR
0986030990	CA308IR	0986031931	CA112	0986033228	CA96IR	0986034158	CA320IR
0986030991	CA308IR	0986031931	CA115	0986033230	CA316IR	0986034168	CA320IR
0986031000	CA291IR	0986031941	CA114	0986033248	CA96IR	0986034170	CA362IR
0986031008	CA291IR	0986032010	CA148	0986033250	CA252IR	0986034180	CA277IR
0986031010	CA35IR	0986032020	CA112	0986033251	CA252IR	0986034190	CA357IR
0986031040	CA52IR	0986032021	CA112	0986033260	CA276IR	0986034198	CA357IR
0986031041	CA124IR	0986032050	CA176IR	0986033268	CA276IR	0986034200	CA305IR
0986031058	CA190IR	0986032051	CA176IR	0986033278	CA277IR	0986034210	CA710IR
0986031070	CA121IR	0986032061	CA173IR	0986033288	CA321IR	0986034220	CA296IR
0986031080	CA69IR	0986032080	CA172IR	0986033290	CA321IR	0986034221	CA296IR
0986031088	CA69IR	0986032081	CA172IR	0986033298	CA321IR	0986034230	CA298IR
0986031090	CA300IR	0986032100	CA120	0986033318	CA96IR	0986034231	CA298IR
0986031091	CA300IR	0986032120	CA131	0986033320	CA522IR	0986034240	CA337IR
0986031110	CA85IR	0986032121	CA131	0986033330	CA341IR	0986034248	CA337IR
0986031118	CA85IR	0986032150	CA46IR	0986033340	CA246IR	0986034250	CA297IR
0986031120	CA93IR	0986032210	CA104	0986033400	CA333IR	0986034251	CA297IR
0986031150	CA125IR	0986032231	CA169IR	0986033441	JA107IR	0986034260	CA186IR
0986031158	CA125IR	0986032241	CA175IR	0986033461	JA131	0986034270	CA568IR
0986031170	CA52IR	0986032261	CA174IR	0986033471	JA197IR	0986034281	JA127IR
0986031178	CA52IR	0986032301	CA356IR	0986033481	JA100	0986034291	JA128IR
0986031190	CA132IR	0986032310	CA224IR	0986033510	CA187IR	0986034301	JA125IR
0986031200	CA191IR	0986032311	CA224IR	0986033550	CA823IR	0986034321	JA140

O.E. NO.	HC-PARTS	O.E. NO.	HC-PARTS	O.E. NO.	HC-PARTS	O.E. NO.	HC-PARTS
<b>BOSCH Continued</b>							
0986034331	JA131	0986035041	JA139	0986036198	CA7171R	0986037070	CA7331R
0986034350	CA7221R	0986035061	JA114	0986036211	CA7171R	0986037071	JA1661R
0986034370	CA5181R	0986035081	JA157	0986036230	CA6311R	0986037110	CA7391R
0986034370	CA8581R	0986035101	JA1771R	0986036240	CA14381R	0986037120	CA5061R
0986034380	CA5901R	0986035111	JA1131R	0986036241	CA5581R	0986037120	CA6011R
0986034390	CA2951R	0986035121	JA153	0986036250	CA5161R	0986037121	CA5061R
0986034391	CA2951R	0986035131	JA1791R	0986036268	CA3641R	0986037130	CA2541R
0986034400	CA3331R	0986035141	JA1741R	0986036268	CA5881R	0986037130	CA5961R
0986034420	CA3261R	0986035151	JA8841R	0986036280	CA5501R	0986037140	CA5061R
0986034430	CA5011R	0986035161	JA1281R	0986036280	CA7481R	0986037150	CA10551R
0986034450	CA3841R	0986035181	JA1251R	0986036281	CA7481R	0986037150	CA5061R
0986034461	CA3521R	0986035201	JA1751R	0986036301	JA6571R	0986037160	CA2541R
0986034468	CA3521R	0986035211	JA1171R	0986036311	JA193	0986037160	CA5961R
0986034468	CA5171R	0986035211	JA8651R	0986036331	JA1731R	0986037170	CA2541R
0986034470	CA15541R	0986035231	JA1461R	0986036350	CA7231R	0986037201	JA5981R
0986034470	CA3251R	0986035291	JA1591R	0986036360	CA7141R	0986037201	JA6901R
0986034473	CA3251R	0986035301	JA6921R	0986036370	CA6451R	0986037210	JA7571R
0986034480	CA2541R	0986035311	JA1651R	0986036390	CA6451R	0986037221	CA7051R
0986034490	CA5041R	0986035321	JA14221R	0986036433	CA16861R	0986037241	CA721
0986034500	CA5201R	0986035331	JA1651R	0986036441	JA1151R	0986037261	JA7521R
0986034508	CA5201R	0986035331	JA7781R	0986036471	JA5751R	0986037271	JA5511R
0986034518	CA2981R	0986035341	JA6911R	0986036480	CA5251R	0986037281	CA6401R
0986034518	CA9111R	0986035391	JA103	0986036481	CA5251R	0986037291	CA5241R
0986034520	CA3761R	0986035401	JA1581R	0986036490	CA8111R	0986037301	CA5261R
0986034530	CA2971R	0986035411	JA1051R	0986036501	JA1711R	0986037311	CA6021R
0986034530	CA5051R	0986035421	JA784	0986036510	CA6191R	0986037321	CA5491R
0986034550	CA3471R	0986035430	JA1091R	0986036520	CA5931R	0986037321	CA6491R
0986034558	CA3471R	0986035431	JA1091R	0986036530	CA6041R	0986037380	CA6461R
0986034560	CA3191R	0986035431	JA1971R	0986036538	CA6041R	0986037410	CA3331R
0986034580	CA5371R	0986035451	JA6521R	0986036540	CA5191R	0986037420	CA8241R
0986034610	CA12241R	0986035461	JA1881R	0986036561	CA6501R	0986037440	CA8541R
0986034620	CA871R	0986035491	JA155	0986036581	CA10281R	0986037450	CA10271R
0986034621	CA871R	0986035501	JA1611R	0986036581	CA3111R	0986037460	CA15511R
0986034630	CA3131R	0986035501	JA9961R	0986036590	CA10281R	0986037491	JA5991R
0986034631	CA3131R	0986035511	JA144	0986036590	CA3111R	0986037491	JA6991R
0986034640	CA2541R	0986035521	JA144	0986036611	CA10291R	0986037511	JA6591R
0986034650	CA3531R	0986035591	JA134	0986036611	CA6111R	0986037521	JA6581R
0986034650	CA5141R	0986035601	JA1421R	0986036631	CA10311R	0986037531	JA7731R
0986034651	CA3531R	0986035611	JA1671R	0986036631	CA7191R	0986037561	JA7981R
0986034660	CA5091R	0986035630	CA3551R	0986036641	JA1601R	0986037581	JA6571R
0986034668	CA5091R	0986035641	CA3501R	0986036651	CA3511R	0986037651	JA6941R
0986034700	CA3811R	0986035670	CA3421R	0986036660	CA3431R	0986037691	JA5761R
0986034710	CA3811R	0986035681	JA5731R	0986036660	CA5211R	0986037701	JA5991R
0986034720	CA2871R	0986035690	CA1961R	0986036690	CA7381R	0986037731	JA6661R
0986034730	CA3691R	0986035700	CA6441R	0986036701	CA10831R	0986037760	CA8531R
0986034731	CA3691R	0986035710	CA7271R	0986036701	CA8561R	0986037770	CA10351R
0986034740	CA3751R	0986035720	CA7121R	0986036750	CA5061R	0986037781	CA3321R
0986034741	CA3751R	0986035730	CA5411R	0986036760	CA5391R	0986037791	CA7351R
0986034741	CA7281R	0986035740	CA5391R	0986036760	CA5471R	0986037791	CA8251R
0986034761	CA3711R	0986035750	CA5401R	0986036770	CA5381R	0986037801	CA5561R
0986034771	CA3031R	0986035760	CA6421R	0986036780	CA7271R	0986037811	JA6731R
0986034778	CA3031R	0986035770	CA5691R	0986036790	CA6101R	0986037831	JA8741R
0986034780	CA3781R	0986035780	CA5861R	0986036800	CA8471R	0986037841	JA8711R
0986034781	CA3781R	0986035791	JA1291R	0986036810	CA7241R	0986037871	CA8161R
0986034791	CA2681R	0986035800	CA6301R	0986036820	CA8331R	0986037880	CA9041R
0986034801	CA2241R	0986035810	CA5421R	0986036831	CA5871R	0986037890	CA2381R
0986034810	CA3721R	0986035820	CA5031R	0986036841	CA3771R	0986037901	CA3721R
0986034811	CA3721R	0986035841	CA6091R	0986036851	CA3801R	0986037901	CA6121R
0986034818	CA3721R	0986035851	JA1291R	0986036860	CA7111R	0986037911	CA2291R
0986034821	CA2891R	0986035871	JA5311R	0986036861	CA7111R	0986037970	CA10811R
0986034830	CA3591R	0986035881	JA1911R	0986036871	CA5831R	0986037970	CA6461R
0986034831	CA3591R	0986035890	CA6451R	0986036880	CA5741R	0986037981	JA6661R
0986034841	CA5571R	0986035901	JA1411R	0986036881	CA5741R	0986037990	CA14771R
0986034850	CA2291R	0986035910	CA7021R	0986036891	CA5331R	0986038003	JA6611R
0986034851	CA2291R	0986036000	CA3241R	0986036901	CA6431R	0986038011	JA1421R
0986034861	CA3141R	0986036010	CA3051R	0986036911	CA5101R	0986038030	CA7311R
0986034871	CA5341R	0986036020	CA12271R	0986036920	CA2401R	0986038041	JA6531R
0986034881	CA3291R	0986036020	CA3051R	0986036930	CA9091R	0986038041	JA9741R
0986034890	CA3611R	0986036048	CA5601R	0986036941	CA5271R	0986038050	CA14501R
0986034891	CA3611R	0986036058	CA2991R	0986036951	CA2911R	0986038060	JA6651R
0986034901	CA3381R	0986036060	CA5611R	0986036961	CA5891R	0986038070	CA7331R
0986034910	CA8241R	0986036063	CA5611R	0986036981	JA170	0986038080	CA9061R
0986034930	CA1981R	0986036071	CA5841R	0986036991	JA6961R	0986038090	CA3181R
0986034931	CA1981R	0986036071	CA7071R	0986037011	JA7711R	0986038100	CA10581R
0986034938	CA1981R	0986036100	CA5941R	0986037021	JA168	0986038100	CA3181R
0986034990	CA3021R	0986036110	CA16901R	0986037031	JA5311R	0986038110	CA8391R
0986035010	CA3541R	0986036150	CA5621R	0986037040	CA3241R	0986038121	JA6931R
0986035018	CA3541R	0986036160	CA5631R	0986037051	CA3701R	0986038130	CA8261R
0986035020	CA5691R	0986036191	CA7171R	0986037061	JA1631R	0986038151	JA6821R

O.E. NO.	HC-PARTS	O.E. NO.	HC-PARTS	O.E. NO.	HC-PARTS	O.E. NO.	HC-PARTS
0986038160	CA1044IR	0986039080	CA1143IR	0986040001	CA896IR	0986040900	CA1075IR
0986038170	CA1062IR	0986039090	CA1089IR	0986040011	CA1320IR	0986040900	CA1136IR
0986038176	CA1062IR	0986039100	CA1064IR	0986040021	CA836IR	0986040910	JA1405IR
0986038180	CA855IR	0986039120	CA900IR	0986040031	CA535IR	0986040920	CA1097IR
0986038190	CA515IR	0986039130	CA1336IR	0986040041	CA579IR	0986040930	CA1226IR
0986038200	CA846IR	0986039140	CA1235IR	0986040051	CA535IR	0986040940	CA1240IR
0986038211	JA689IR	0986039150	CA899IR	0986040061	CA1040IR	0986040950	CA1297IR
0986038220	JA682IR	0986039150	CA903IR	0986040071	CA914IR	0986040960	JA1134IR
0986038230	CA724IR	0986039170	CA1056IR	0986040081	CA1036IR	0986040970	CA1262IR
0986038260	CA1057IR	0986039180	CA1069IR	0986040091	CA716IR	0986040980	CA1452IR
0986038281	JA974IR	0986039200	CA1245IR	0986040101	CA1033IR	0986040990	CA1241IR
0986038290	CA1236IR	0986039210	CA1399IR	0986040111	CA821IR	0986041000	CA1107IR
0986038300	CA700IR	0986039220	CA1106IR	0986040121	CA1225IR	0986041010	CA1144IR
0986038310	CA1054IR	0986039230	CA1066IR	0986040131	CA720IR	0986041030	CA1505IR
0986038320	CA902IR	0986039240	CA1045IR	0986040141	CA819IR	0986041040	CA1062IR
0986038330	CA1063IR	0986039250	CA1070IR	0986040151	CA815IR	0986041060	CA1480IR
0986038330	CA1073IR	0986039260	CA907IR	0986040161	CA895IR	0986041080	CA1580IR
0986038330	CA901IR	0986039280	CA908IR	0986040170	CA1090IR	0986041090	CA333IR
0986038340	CA841IR	0986039300	CA1043IR	0986040180	CA1209IR	0986041100	CA1096IR
0986038351	CA898IR	0986039321	CA822IR	0986040190	CA1095IR	0986041103	CA1096IR
0986038370	CA736IR	0986039330	CA737IR	0986040191	CA1095IR	0986041110	CA1254IR
0986038380	CA740IR	0986039340	CA1438IR	0986040201	CA1038IR	0986041120	CA1299IR
0986038390	CA827IR	0986039350	CA1301IR	0986040210	CA1065IR	0986041140	CA1445IR
0986038401	JA756IR	0986039360	CA1299IR	0986040211	CA1065IR	0986041150	CA1443IR
0986038421	JA552IR	0986039370	CA1300IR	0986040220	CA1152IR	0986041153	CA1443IR
0986038431	JA598IR	0986039390	CA1299IR	0986040221	CA1152IR	0986041160	JA987IR
0986038451	JA154IR	0986039400	CA1057IR	0986040231	CA1203IR	0986041170	JA1599IR
0986038460	JA868IR	0986039420	CA1563IR	0986040241	CA1080IR	0986041180	JA1377IR
0986038471	JA798IR	0986039431	CA845IR	0986040260	CA1593IR	0986041190	CA1569IR
0986038481	JA698IR	0986039440	CA829IR	0986040270	CA1204IR	0986041200	CA1140IR
0986038491	JA761IR	0986039440	CA912IR	0986040280	CA1198IR	0986041210	CA1300IR
0986038501	JA780IR	0986039450	CA844IR	0986040290	CA1197IR	0986041220	CA1299IR
0986038551	JA753IR	0986039460	JA987IR	0986040300	JA1176IR	0986041230	CA1402IR
0986038561	JA751IR	0986039471	CA890IR	0986040310	CA1207IR	0986041240	CA1257IR
0986038571	JA753IR	0986039481	CA1042IR	0986040320	CA1239IR	0986041250	CA1490IR
0986038581	JA980IR	0986039490	CA1148IR	0986040330	CA1228IR	0986041260	CA1391IR
0986038591	JA759IR	0986039501	CA893IR	0986040340	CA1139IR	0986041270	CA1440IR
0986038600	CA861IR	0986039510	CA1087IR	0986040350	CA1248IR	0986041280	CA1688IR
0986038603	CA861IR	0986039513	CA1087IR	0986040360	CA1229IR	0986041290	CA1591IR
0986038610	CA829IR	0986039520	CA1147IR	0986040370	CA1088IR	0986041300	CA1260IR
0986038621	CA851IR	0986039530	CA1237IR	0986040370	CA1822IR	0986041310	CA1560IR
0986038630	CA1088IR	0986039530	CA1393IR	0986040380	CA1261IR	0986041320	CA1300IR
0986038641	CA894IR	0986039540	CA852IR	0986040390	CA1256IR	0986041330	CA1327IR
0986038650	CA1032IR	0986039550	CA1093IR	0986040400	CA1246IR	0986041351	CA1079IR
0986038660	CA1071IR	0986039570	CA1146IR	0986040410	CA1102IR	0986041361	CA1449IR
0986038670	CA1324IR	0986039620	CA1259IR	0986040430	CA1231IR	0986041371	CA1200IR
0986038680	CA1149IR	0986039630	CA1073IR	0986040441	JA768IR	0986041381	CA1039IR
0986038690	CA1076IR	0986039650	CA1207IR	0986040461	JA988IR	0986041391	CA1579IR
0986038710	CA617IR	0986039660	CA1138IR	0986040471	JA976IR	0986041401	CA1052IR
0986038711	CA617IR	0986039670	JA992IR	0986040481	JA670IR	0986041411	CA1077IR
0986038730	CA618IR	0986039690	CA1141IR	0986040491	JA755IR	0986041421	CA1078IR
0986038740	CA637IR	0986039690	CA700IR	0986040501	JA1178IR	0986041431	CA1250IR
0986038751	CA820IR	0986039700	CA1145IR	0986040511	JA671IR	0986041441	CA848IR
0986038771	CA715IR	0986039720	CA1325IR	0986040521	JA1126IR	0986041451	CA1150IR
0986038781	CA638IR	0986039730	CA1503IR	0986040531	JA981IR	0986041461	CA1099IR
0986038791	CA825IR	0986039740	CA1044IR	0986040541	JA1188IR	0986041471	CA1156IR
0986038801	CA614IR	0986039743	CA1044IR	0986040551	JA973IR	0986041480	CA1502IR
0986038811	CA639IR	0986039750	CA1395IR	0986040561	JA677IR	0986041490	CA1446IR
0986038821	CA606IR	0986039756	CA1395IR	0986040581	JA769IR	0986041500	CA1378IR
0986038831	CA532IR	0986039760	CA1155IR	0986040600	CA1403IR	0986041510	CA1436IR
0986038838	CA532IR	0986039780	CA1151IR	0986040621	CA1221IR	0986041520	CA1845IR
0986038841	CA889IR	0986039790	CA1593IR	0986040631	CA1189IR	0986041530	CA1489IR
0986038851	CA635IR	0986039800	CA1242IR	0986040631	CA1216IR	0986041550	CA1491IR
0986038861	CA605IR	0986039810	CA1068IR	0986040641	CA1216IR	0986041570	CA1593IR
0986038871	CA816IR	0986039820	CA1335IR	0986040651	CA1220IR	0986041580	CA333IR
0986038881	CA818IR	0986039831	CA1247IR	0986040661	CA1158IR	0986041590	CA1481IR
0986038891	CA1251IR	0986039851	CA913IR	0986040671	CA1160IR	0986041600	CA570IR
0986038901	CA817IR	0986039860	CA1500IR	0986040681	CA1159IR	0986041610	CA548IR
0986038910	CA1206IR	0986039870	CA1074IR	0986040691	CA1190IR	0986041620	CA352IR
0986038920	JA991IR	0986039891	CA1085IR	0986040800	CA1299IR	0986041620	CA517IR
0986038930	JA1117IR	0986039913	CA1655IR	0986040800	CA1395IR	0986041630	CA364IR
0986038940	CA1244IR	0986039921	CA1238IR	0986040830	JA1129IR	0986041630	CA588IR
0986038950	CA828IR	0986039931	CA1086IR	0986040830	JA1426IR	0986041640	CA1236IR
0986038960	CA826IR	0986039941	CA1098IR	0986040840	CA1268IR	0986041650	CA1206IR
0986038970	CA384IR	0986039951	CA633IR	0986040850	JA1364IR	0986041660	CA1254IR
0986038990	CA1037IR	0986039961	CA838IR	0986040860	CA1249IR	0986041730	CA1439IR
0986039000	CA1092IR	0986039971	CA830IR	0986040870	CA1267IR	0986041740	CA1439IR
0986039030	CA1142IR	0986039980	CA634IR	0986040880	CA1255IR	0986041750	CA1632IR
0986039060	CA1089IR	0986039991	CA1059IR	0986040890	CA1543IR	0986041760	CA1634IR

O.E. NO.	HC-PARTS	O.E. NO.	HC-PARTS	O.E. NO.	HC-PARTS	O.E. NO.	HC-PARTS
<b>BOSCH Continued</b>							
0986041771	JA863IR	0986042650	CA1639IR	0986044370	CA1500IR	0986045360	CA1763IR
0986041781	JA863IR	0986042660	JA1605IR	0986044380	CA1512IR	0986045370	CA1779IR
0986041790	JA1172IR	0986042670	CA1684IR	0986044390	CA1567IR	0986045380	CA1752IR
0986041791	JA1172IR	0986042680	CA1585IR	0986044400	CA1553IR	0986045390	CA1810IR
0986041793	JA1172IR	0986042690	CA1075IR	0986044410	CA1658IR	0986045410	CA1634IR
0986041800	CA1342IR	0986042700	CA1441IR	0986044420	CA1658IR	0986045420	CA1701IR
0986041810	CA1591IR	0986042710	CA1548IR	0986044430	CA1730IR	0986045461	JA1609IR
0986041820	CA1329IR	0986042720	CA1544IR	0986044440	CA1582IR	0986045481	JA1520IR
0986041830	CA1257IR	0986042730	CA1732IR	0986044460	CA1678IR	0986045490	CA1694IR
0986041840	CA1433IR	0986042740	CA1581IR	0986044470	CA1746IR	0986045491	JA1610
0986041850	CA1628IR	0986042750	CA1103IR	0986044480	CA1813IR	0986045500	CA1693IR
0986041860	CA1394IR	0986042760	CA1648IR	0986044490	CA2024IR	0986045511	JA1353IR
0986041870	CA1541IR	0986042770	CA1470IR	0986044521	CA1495IR	0986045521	JA1515IR
0986041900	CA1549IR	0986042780	CA1223IR	0986044530	CA1141IR	0986045531	JA876IR
0986041910	CA1504IR	0986042790	CA1636IR	0986044540	CA1546IR	0986045541	JA1303IR
0986041920	CA1542IR	0986042800	CA1765IR	0986044550	CA1321IR	0986045551	JA1283
0986041930	CA1509IR	0986042800	CA1821IR	0986044571	CA627IR	0986045561	JA1183IR
0986041940	CA1448IR	0986042810	CA1644IR	0986044581	CA17H	0986045571	JA1802IR
0986041950	CA1482IR	0986042820	CA1679IR	0986044591	CA564IR	0986045581	JA1523IR
0986041960	CA1557IR	0986042830	CA1541IR	0986044601	CA17V	0986045591	JA1519IR
0986041970	CA1556IR	0986042840	CA1673IR	0986044611	CA1034IR	0986045601	JA1533IR
0986041980	CA1556IR	0986042850	CA1237IR	0986044621	CA1318IR	0986045611	JA1617IR
0986041990	JA1415IR	0986042853	CA1237IR	0986044631	CA1217IR	0986045621	JA1357IR
0986042000	CA1471IR	0986042861	JA1520IR	0986044651	CA1475IR	0986045631	JA769IR
0986042010	CA1485IR	0986042871	JA879IR	0986044661	JA1376IR	0986045641	JA1287IR
0986042020	CA1486IR	0986042881	JA994IR	0986044671	CA1483IR	0986045651	JA1528IR
0986042031	CA1343IR	0986042891	JA689IR	0986044681	CA1137IR	0986045671	JA1607IR
0986042041	CA1434IR	0986042901	JA671IR	0986044691	CA1316IR	0986045681	JA1516IR
0986042051	CA898IR	0986042911	JA1409	0986044701	CA1340IR	0986045691	JA1702IR
0986042061	CA1339IR	0986042921	JA806IR	0986044721	JA975IR	0986045701	JA1607IR
0986042071	CA1442IR	0986042941	JA1374IR	0986044731	JA1425IR	0986045711	JA1407IR
0986042081	CA1496IR	0986042951	JA1182IR	0986044741	CA1100IR	0986045721	JA1713IR
0986042091	CA1564IR	0986042981	JA571IR	0986044761	CA1191IR	0986045731	JA1704IR
0986042101	CA1344IR	0986042991	JA1274IR	0986044771	CA1252IR	0986045741	CA2083IR
0986042111	CA1305IR	0986043001	JA750IR	0986044781	CA628IR	0986045751	JA193IR
0986042121	CA1333IR	0986043021	JA1166IR	0986044791	JA555IR	0986045761	JA1612IR
0986042131	CA1345IR	0986043031	JA1134IR	0986044801	JA1174IR	0986045771	JA1356IR
0986042141	CA1303IR	0986043041	JA981IR	0986044811	JA685IR	0986045791	JA1293IR
0986042151	CA1322IR	0986043051	JA1134IR	0986044821	CA718IR	0986045801	JA1612IR
0986042171	CA1157IR	0986043061	JA1369IR	0986044841	CA1559IR	0986045811	JA1793IR
0986042181	CA1444IR	0986043091	CA1572IR	0986044850	CA1540IR	0986045821	JA1595IR
0986042191	CA1304IR	0986043101	JA1526IR	0986044880	CA1552IR	0986045831	JA1794IR
0986042201	CA1309IR	0986043111	JA680IR	0986044890	CA1854IR	0986045841	JA1722IR
0986042211	CA1308IR	0986043113	JA680IR	0986044900	CA1673IR	0986045851	JA1714IR
0986042221	CA607IR	0986043121	JA1290IR	0986044910	CA1769IR	0986045861	JA1517IR
0986042231	CA1060IR	0986043130	CA1480IR	0986044940	JA1421IR	0986045871	JA1119IR
0986042241	JA775IR	0986043141	CA1317IR	0986044940	JA867IR	0986045881	JA1604IR
0986042261	JA585IR	0986043151	CA1101IR	0986044960	CA1326IR	0986045891	JA1410IR
0986042271	JA585IR	0986043480	CA1381IR	0986044970	CA1507IR	0986045911	JA1280IR
0986042281	JA878IR	0986043580	CA1232IR	0986044991	JA862IR	0986045930	JA1421IR
0986042291	JA1271IR	0986043650	CA1489IR	0986045001	JA761IR	0986045930	JA867IR
0986042301	JA1531IR	0986043660	CA1481IR	0986045031	CA1584IR	0986045941	JA1181IR
0986042311	JA674IR	0986043670	CA1776IR	0986045063	JA1120IR	0986045951	JA1187IR
0986042331	JA976IR	0986043680	CA1053IR	0986045073	JA761IR	0986045961	JA1163IR
0986042350	CA1456IR	0986043683	CA1053IR	0986045081	JA697IR	0986045961	JA760IR
0986042360	CA1666IR	0986043890	CA1505IR	0986045083	JA697IR	0986045981	CA1333IR
0986042370	CA1666IR	0986043900	CA1481IR	0986045101	CA1645IR	0986045990	CA1667IR
0986042380	CA1666IR	0986043910	CA1630IR	0986045103	CA1645IR	0986046000	CA1062IR
0986042390	CA1739IR	0986043931	CA1051IR	0986045110	CA1829IR	0986046010	CA1570IR
0986042400	CA1739IR	0986043941	JA1370IR	0986045130	CA1730IR	0986046020	CA1555IR
0986042410	CA1739IR	0986043951	CA1389IR	0986045160	CA1699IR	0986046030	CA1493IR
0986042420	CA1632IR	0986043960	CA1561IR	0986045170	CA2040IR	0986046040	CA1633IR
0986042470	CA1576IR	0986043970	CA1748IR	0986045181	CA1390IR	0986046050	CA1587IR
0986042490	CA1634IR	0986043981	JA1521IR	0986045201	CA1302IR	0986046060	CA1700IR
0986042520	CA1489IR	0986043990	CA1473IR	0986045211	CA1392IR	0986046070	CA1729IR
0986042530	CA1489IR	0986044000	CA1577IR	0986045221	CA1298IR	0986046081	CA1508IR
0986042540	CA1623IR	0986044010	CA1592IR	0986045231	CA1504IR	0986046090	CA1743IR
0986042550	CA1689IR	0986044020	CA1740IR	0986045241	CA1627IR	0986046100	CA1512IR
0986042560	CA1656IR	0986044030	CA1577IR	0986045251	CA1756IR	0986046110	JA1894IR
0986042570	CA1872IR	0986044060	CA1624IR	0986045261	CA1637IR	0986046120	CA1907IR
0986042580	CA1695IR	0986044070	CA1744IR	0986045270	CA1053IR	0986046130	CA1773IR
0986042583	CA1695IR	0986044210	CA1747IR	0986045273	CA1045IR	0986046140	CA1833IR
0986042590	CA1663IR	0986044280	UA1214	0986045280	CA1666IR	0986046150	CA1765IR
0986042593	CA1663IR	0986044290	JA1162IR	0986045290	CA1739IR	0986046160	CA1754IR
0986042600	CA1511IR	0986044300	CA1546IR	0986045300	CA1729IR	0986046170	CA1826IR
0986042610	CA1547IR	0986044310	CA1664IR	0986045310	CA1815IR	0986046180	CA1811IR
0986042620	CA1568IR	0986044320	CA1759IR	0986045320	CA1817IR	0986046190	CA1683IR
0986042630	CA1566IR	0986044330	CA1588IR	0986045330	CA1818IR	0986046210	CA1837IR
0986042640	CA1586IR	0986044340	CA1545IR	0986045340	CA1782IR	0986046220	CA1825IR

O.E. NO.	HC-PARTS	O.E. NO.	HC-PARTS	O.E. NO.	HC-PARTS	O.E. NO.	HC-PARTS
0986046230	CA1828IR	0986048110	CA1739IR	0986049520	CA1635IR	0986080530	CA1646IR
0986046240	CA1761IR	0986048150	CA1206IR	0986049530	CA1885IR	0986080540	CA1843IR
0986046250	CA1824IR	0986048160	CA1657IR	0986049540	CA1742IR	0986080550	CA1350IR
0986046260	CA1827IR	0986048170	CA1446IR	0986049550	JA1708IR	0986080560	CA1886IR
0986046270	CA1774IR	0986048180	CA1782IR	0986049560	CA1665IR	0986080570	JA1897IR
0986046280	CA1863IR	0986048240	CA1909IR	0986049570	JA1798IR	0986080580	CA1904IR
0986046290	CA1853IR	0986048253	CA1592IR	0986049600	CA1671IR	0986080590	JA1809IR
0986046300	CA1775IR	0986048301	JA1900IR	0986049610	CA1697IR	0986080600	CA1985IR
0986046310	CA1861IR	0986048303	JA1900IR	0986049620	CA1400IR	0986080610	CA1869IR
0986046320	CA1846IR	0986048320	JA1899IR	0986049630	CA1641IR	0986080630	UA960
0986046330	CA1859IR	0986048323	JA1899IR	0986049640	CA1750IR	0986080640	JA1804IR
0986046340	CA1764IR	0986048343	JA1901IR	0986049650	CA1622IR	0986080650	CA1672IR
0986046351	JA1276IR	0986048350	CA2009IR	0986049660	CA1680IR	0986080660	CA1920IR
0986046361	JA983IR	0986048353	CA2009IR	0986049670	CA1864IR	0986080670	CA1647IR
0986046371	JA1406IR	0986048380	CA1919IR	0986049700	CA1589IR	0986080690	JA870IR
0986046381	JA989IR	0986048400	CA2001IR	0986049710	JA1611IR	0986080700	CA1737IR
0986046391	JA1165IR	0986048453	CA2032IR	0986049720	JA1717IR	0986080710	CA1975IR
0986046401	JA148IR	0986048530	CA1394IR	0986049730	JA1603IR	0986080720	CA1977IR
0986046411	JA1279IR	0986048541	CA1153IR	0986049740	CA1154IR	0986080730	CA1981IR
0986046421	JA678IR	0986048550	CA1859IR	0986049750	CA1649IR	0986080740	CA1983IR
0986046431	JA678IR	0986048611	CA1652IR	0986049760	CA1696IR	0986080750	CA1993IR
0986046440	CA1866IR	0986048630	CA1349IR	0986049780	CA1939IR	0986080760	CA1386IR
0986046450	CA254IR	0986048723	CA2068IR	0986049800	JA1602IR	0986080780	CA1642IR
0986046460	CA828IR	0986048743	CA2006IR	0986049810	CA1881IR	0986080800	CA2003IR
0986046480	CA1199IR	0986048771	CA1862IR	0986049820	CA1997IR	0986080820	CA1191IR
0986046511	CA1388IR	0986048781	CA1855IR	0986049830	CA850IR	0986080830	CA1380IR
0986046541	JA1710IR	0986048783	CA1855IR	0986049840	JA777	0986080840	JA1411IR
0986046550	CA1659IR	0986048791	CA1884IR	0986049850	JA1525IR	0986080850	CA1050IR
0986046560	CA1694IR	0986048793	CA1884IR	0986049860	JA1539IR	0986080860	JA1594IR
0986046570	CA1693IR	0986048820	CA1953IR	0986049870	JA1527IR	0986080870	CA1653IR
0986046580	CA1851IR	0986048823	CA1953IR	0986049880	JA1376IR	0986080880	JA1184IR
0986046590	CA1871IR	0986048843	CA2035IR	0986049890	CA1310IR	0986080890	CA1243IR
0986047150	CA1908IR	0986048891	CA1755IR	0986049900	JA684IR	0986080900	CA1306IR
0986047160	CA1237IR	0986048911	CA1681IR	0986049910	CA1640IR	0986080910	JA1618IR
0986047163	CA1237IR	0986048921	CA1757IR	0986049920	JA1711IR	0986080920	CA1578IR
0986047210	CA1831IR	0986048980	CA1677IR	0986049930	JA1419IR	0986080930	CA1771IR
0986047220	CA1867IR	0986048990	CA1838IR	0986049940	JA1522IR	0986080940	JA1537IR
0986047240	CA1774IR	0986049000	CA1952IR	0986049960	CA1978IR	0986080960	CA1976IR
0986047250	CA1446IR	0986049020	CA1940IR	0986049980	CA2034IR	0986080970	CA1921IR
0986047260	CA1636IR	0986049051	JA1600IR	0986080010	JA1535IR	0986080980	CA1934IR
0986047270	CA1882IR	0986049061	CA1643IR	0986080020	JA1518IR	0986081000	CA1949IR
0986047280	CA1748IR	0986049071	CA1834IR	0986080030	CA1781IR	0986081020	CA1832IR
0986047290	CA1581IR	0986049081	CA1766IR	0986080040	CA1873IR	0986081030	UA1620IR
0986047300	CA1748IR	0986049091	CA1741IR	0986080050	CA814IR	0986081040	CA1874IR
0986047310	CA1581IR	0986049101	CA1675IR	0986080090	CA1937IR	0986081050	JA1601IR
0986047320	CA1765IR	0986049111	CA1734IR	0986080110	CA1850IR	0986081060	CA1906IR
0986047330	CA1658IR	0986049121	CA1780IR	0986080120	JA1175IR	0986081070	CA1955IR
0986047340	CA1860IR	0986049131	CA1625IR	0986080130	JA1716IR	0986081090	CA1989IR
0986047350	CA1841IR	0986049141	CA1758IR	0986080140	CA1762IR	0986081120	CA1987IR
0986047360	CA1674IR	0986049151	CA1777IR	0986080160	JA1427IR	0986081140	CA1999IR
0986047370	CA1824IR	0986049161	CA1778IR	0986080170	JA672IR	0986081150	CA2010IR
0986047380	CA1988IR	0986049171	CA1865IR	0986080180	CA858IR	0986081180	CA1992IR
0986047383	CA1988IR	0986049181	CA1857IR	0986080190	CA1879IR	0986081200	JA1707
0986047390	CA1877IR	0986049191	JA1789IR	0986080200	CG52	0986081210	JA1723IR
0986047400	CA1825IR	0986049201	JA1715IR	0986080210	JA1790IR	0986081220	CA1957IR
0986047420	CA1870IR	0986049211	JA1800IR	0986080220	CA1484IR	0986081230	CA1912IR
0986047430	CA1847IR	0986049221	JA1721IR	0986080230	CA1474IR	0986081240	JA1614IR
0986047440	CA1853IR	0986049231	CA1558IR	0986080240	JA1727IR	0986081250	JA1606IR
0986047450	CA1749IR	0986049243	CA333IR	0986080250	JA877IR	0986081260	CA1760IR
0986047470	CA1861IR	0986049253	CA1035IR	0986080260	JA1130IR	0986081270	CA1662IR
0986047490	CA1840IR	0986049263	CA1751IR	0986080270	CA1814IR	0986081290	JA1596IR
0986047500	CA2028IR	0986049293	CA710IR	0986080280	CA1233IR	0986081300	JA1902
0986047530	CA1656IR	0986049303	CA854IR	0986080300	CA813IR	0986081310	CA1938IR
0986047540	CA1872IR	0986049311	CA2037IR	0986080310	CA1650IR	0986081340	CA1986IR
0986047550	CA1776IR	0986049320	CA1917IR	0986080320	JA1705	0986081350	CA1932IR
0986047573	CA1581IR	0986049370	CA1498IR	0986080330	CA1768IR	0986081440	JA990IR
0986047751	CA1196IR	0986049380	CA1455IR	0986080340	CA1772IR	0986084040	CA1874IR
0986047771	CA1218IR	0986049390	CA1626IR	0986080350	CA1905IR	9000042021	CS62
0986047820	CA1880IR	0986049400	CA1698IR	0986080380	CA1994IR	9000042021	CS62
0986047870	CA333IR	0986049410	CA1499IR	0986080390	CA1839IR	9000042027	CS62
0986047910	CA1928IR	0986049420	CA1084IR	0986080420	CA1959IR	9000042034	CS62
0986047920	CA1922IR	0986049430	CA1631IR	0986080430	JA1615IR	9000042057	CS294
0986047930	CA1968IR	0986049440	CA632IR	0986080440	CA1925IR	9000082009	CS62
0986047980	CA1819IR	0986049450	CA1767IR	0986080460	CA1942IR	9000082021	CS396
0986048000	CA1820IR	0986049460	CA1638IR	0986080470	CA1930IR	9000082039	CS368
0986048030	CA1743IR	0986049470	CA1396IR	0986080480	JA1895IR	9000082040	CS368
0986048040	CA1945IR	0986049490	JA1703IR	0986080490	CA1844IR	9000082043	CS323
0986048070	CA1916IR	0986049500	JA1709IR	0986080500	CA1875IR	9000082050	CS297
0986048100	CA1666IR	0986049510	JA1367IR	0986080520	JA1785IR	9000082051	CS323

O.E. NO.	HC-PARTS	O.E. NO.	HC-PARTS	O.E. NO.	HC-PARTS	O.E. NO.	HC-PARTS
<b>BOSCH <i>Continued</i></b>							
9000082059	CS297	9120080061	CA931R	9120334628	JA7571R	6033GB5009	JA1525IR
9000082061	CS285	9120080088	CA132IR	9120334631	JA1117IR	6333G3013B	CA1336IR
9000082081	CS396	9120080114	CA132IR	9120334632	JA1117IR	AL/EEF0.5/6	CS60
9000082082	CS368	9120080118	CA141IR	9120334633	JA1527IR	AL/EEF0.5/6L1	CS60
9000083054	CS186	9120080120	CA909IR	9120334634	JA1527IR	B001110043	CS612
9000083065	CS120	9120080139	CA909IR	9120334635	JA1421IR	B001110097	CS879
9000084008	CS546	9120080148	CA152IR	9120334635	JA8671R	B001111010	CS327
9000084018	CS710	9120143203	CA461R	9120334636	JA7571R	B001111158	CS516
9000084019	CS99	9120144017	CA841R	9120334636	JA7571R	B001111217	CS559
9000084024	CS99	9120144018	CA841R	9120334638	JA1527IR	B001111399	CS715
9000141015	CS126	9120144111	CA130IR	9120334640	JA7571R	B001116092	CS1114
9000141100	CS95	9120144114	CA130IR	9120334641	JA1527IR	B001126081	CS1165
9000141101	CS90	9120144118	CA130IR	9120334642	JA1603IR	B001260015	CS1112
9000141103	CS95	9120144119	CA130IR	9120335000	JA1162IR	B001860021	CS1274
9000141104	CS126	9120144201	CA129IR	9120335001	JA1162IR	B001860023	CS1274
9000141107	CS90	9120144202	CA129IR	9120335002	JA1525IR	B120402015	CA620IR
9000141108	CS141	9120144208	CA119IR	9120336000	JA9911R	B120416351	CA1639IR
9000141111	CS95	9120144209	CA119IR	9120450012	CA941R	B120501009	CA320IR
9000141112	CS95	9120144218	CA841R	9120450018	CA601R	B120516076	CA1445IR
9000141113	CS130	9120144222	CA611R	9120690291	CA337IR	B120600100	CA1393IR
9000142001	CS170	9120144228	CA307IR	9120690298	CA337IR	BNG4/24CR231	CS194
9000142002	CS142	9120144229	CA307IR	9123320007	CA736IR	BNG4/24CRS162	CS194
9000142003	CS306	9120144230	CA169IR	9123320012	CA1261IR	BNG4/24CRS163	CS194
9000143400	CS109	9120144231	CA169IR	9123320016	CA1139IR	BNG4/24CRS165	CS194
9000143406	CS188	9120144232	CA841R	9123369044	CA1044IR	BPD6/24AR9Z11	CS806
9000143408	CS188	9120144238	CA129IR	9127041200	CA298IR	EGD1/12AR37	CS140
9000143501	CS387	9120144239	CA129IR	9127041201	CA298IR	EJD3/12BR4	CS1121
9000143601	CS120	9120144240	CA307IR	9127041233	UA9311R	F000AL0101	CS1117
9000330922	CS91	9120144241	CA307IR	9127041241	UA9311R	F000AL0309	CS1125
9000330939	CS90	9120144242	CA176IR	9127041242	UA9311R	F000AL0310	CS1125
9000330948	CS90	9120144243	CA176IR	9129080088	CA132IR	F000AL0319	CS796
9000331201	JS1214	9120144244	CA173IR	0120469860/875	CA727IR	F000AL0320	CS1379
9000331203	JS1214	9120144245	CA173IR	0120469860/892	CA727IR	F000AL0321	CS1490
9000331406	JS568	9120144254	CA369IR	0120489369/370	CA520IR	F000LD0108	CA931R
9000331411	CS575	9120144255	CA369IR	0120489369/445	CA520IR	F002G10951	JA1172IR
9000331414	CS163	9120144256	CA332IR	01220AA000	CA1634IR	F002G20485	CS1334
9000331419	CS555	9120144258	CA332IR	01220AA0B0	CA1634IR	F004A94410	CS1289
9000331420	CS338	9120144261	CA512IR	01220AA0D0	CA1634IR	F005A00023	CA1197IR
9000331421	JS568	9120144262	CA512IR	01220AA0R0	CA1634IR	F005A00024	CA1198IR
9000331424	JS568	9120144265	CA369IR	01220AA1A0	CA1634IR	F005M00001	CS879
9000331428	JS936	9120144266	CA369IR	01220AA1H0	CA1632IR	F010LD0201	CA1086IR
9000331430	JS568	9120144267	CA317IR	01220AA1J0	CA1632IR	LJ/GG240/12/2400A	
9000333104	CS306	9120144268	CA317IR	01220AA1P0	CA1634IR	CG23K	
9000333106	CS306	9120144269	CA871R	01220AA2A0	CA1634IR	R007042024	CS62
9000333109	CS321	9120144270	CA871R	0986AR0761	JA1718IR		
9000333112	CS275	9120144277	CA375IR	0986B05008	CS1125	BRIGGS & STRATTON	
9000333114	CS317	9120144278	CA375IR	0986B05009	CS1125	390307	US850
9000333115	CS278	9120144279	CA313IR	0986JR0374	JS380	391423	US851
9000333116	CS278	9120144280	CA313IR	0986JR0383	JS670	392749	US851
9000333117	CS310	9120144283	CA224IR	0986JR0588	JA1803IR	394805	US851
9000333118	CS592	9120144284	CA224IR	0986JR0856	JA1728IR	394808	US852
9000333119	CS592	9120144285	CA378IR	0986JR1046	JS1094		
9000333121	JS380	9120144286	CA378IR	0986JR1128	CS1456	BUTEC	
9000333122	CS344	9120144287	CA586IR	0986JR1252	CS1436	850277	US1242
9000334101	CS166	9120144288	CA586IR	6004AA0018	CS1189	850461	US1241
9000334102	CS344	9120144289	CA629IR	6004AA3015	CS1247	850598	US1241
9000334103	JS394	9120144290	CA629IR	6033G2019B	CA1198IR	851606	UA968IR
9000451017	CS323	9120144295	CA372IR	6033G3020B	CA1049IR	854494	UA968IR
9000451024	CS323	9120144296	CA372IR	6033GB2009	CA1335IR	856766	US1245
9000692014	CS79	9120144302	CA549IR	6033GB3010	CA1505IR	857601	CA1194IR
9000692015	CS116	9120144303	CA549IR	6033GB3019	CA1593IR	857606	CA1193IR
9000692050	CS294	9120144605	JA7571R	6033GB3020	CA1049IR	857612	CA1193IR
9000692051	CS276	9120144606	JA7571R	6033GB3021	CA9071R	857623	CA1194IR
9000692062	CS115	9120144606	JA7571R	6033GB3022	CA1593IR	857626	CA1193IR
9000692069	JS325	9120144610	JA7571R	6033GB3023	CA1505IR	857633	CA1193IR
9000693013	CS132	9120144611	JA7571R	6033GB3027	CA1593IR	857638	CA1193IR
9000694029	CS618	9120144615	JA7571R	6033GB3033	CA1148IR	857645	CA1194IR
9004475300	CS19	9120144616	JA7571R	6033GB3034	CA1148IR	857663	US1244
9007042015	CS392	9120145002	CA227IR	6033GB3035	CA1744IR	857673	US1245
9007042016	CS392	9120334310	CA150IR	6033GB3047	CA333IR	858442	US864
9007042024	CS62	9120334311	CA373IR	6033GB3053	CA333IR	858450	US864
9007044002	CS186	9120334317	JA682IR	6033GB3054	CA1035IR	858506	US864
9007045009	CS990	9120334318	JA682IR	6033GB3055	CA333IR	858617	US1245
9007045016	JS759	9120334625	JA8671R	6033GB3083	CA1505IR	858693	CA1193IR
9007045018	CS1189	9120334626	JA1421IR	6033GB4009	JA1614IR	859022	CS989
9007045020	CS990	9120334626	JA8671R	6033GB4018	JA1603IR	859411	US1243
9120060027	CA1082IR	9120334627	JA7571R	6033GB4020	JA1527IR	859605	CA1193IR
9120060041	CA1198IR	9120334627	JA7571R	6033GB4021	JA1527IR	859820	CA333IR
9120061100	JA683IR	9120334628	JA7571R	6033GB5007	JA1525IR		

O.E. NO.	HC-PARTS	O.E. NO.	HC-PARTS	O.E. NO.	HC-PARTS	O.E. NO.	HC-PARTS
859839	US1243	1327111	CS696	CA45F12-Y18	CS697	3755413	UA926
859970	US1243	1327470	CS808	CA45F12-Y2	CS694	3755900	US812
860052	CA1193IR	1327471	CS808	CA45F12-Y3M	CS695	3780589	UA926
860508	CS191	1327480	CS808	CA45F12-Y4	CS696	3856713	UA926
860511	CS962	1327591	CS808	CA45F12-Y51	CS694	3874777	UA926
860512	CS699	1327620	CS808	CA45F12-Y57	CS696	4091950	US822
880704Z	CA1670IR	1327621	CS808	CA45F12-Y72	CS953	4091975	US812
A302413	UA968IR	1403010	CS1168	CA45F12-Y81	CS694	4111860	US822
A4024/15	UA968IR	1403010	CS1168	CA45F12-Y83	CS697	4145360	US822
GR45/2	US1245	1268600M	CA1193IR	CA45F24-2	CS700	4145568	US822
LNS4524	US1243	1320D161	CS696	CA45F24-47	CS700	4428082	UA951
LNS4524/6	US1243	1320D183	CS697	CA45F24-Y2	CS700	4557209	CS979
MS1	US1242	1320F022	CS694	CA45F24-Y29M	CS698	4557284	JS762
MS1/411AZ	US864	1320F027	CS694	CA45G12-16	CS696	4557301	UA960
MS3	US1241	1320F035	CS695	CA45G12-18	CS697	4557384	JS762
MS3/51	US1244	1320F036	CS695	CA45G12-2	CS694	4557432	UA1212
		1320F045	CS696	CA45G12-3	CS695	4557468	CS990
		1320F161	CS696	CA45G12-3M	CS695	4557709	JS942
CASE		1320F183	CS697	CA45G12-4	CS696	4609101	UA1619
2855914	CA1854IR ▲	1320F513	CS694	CA45G12-51	CS694	4609125	UA1619
1273112C91	JS895	1320F515	CS694	CA45G12-72	CS953	4609125	UA1619
A187873	CA1197IR	1320F720	CS953	CA45G12-83	CS697	4609320	UA1619
		1320F810	CS694	CA45G12-9	CS702	4609415	UA1215
CATERPILLAR		1320G027	CS694	CA45G24-2	CS700	4671084	JS762
0R3667	UA1114IR	1320G036	CS695	CA45H12-72	CS953	4686019	UA1214
0R3669	UA1114IR	1320G045	CS696	CA45H12-83	CS697	4686021	UA1213
100-5045	UA1114IR	1320G161	CS696	CA45H24-2	CS700	4686045	JS942
100-5046	UA1114IR	1320G183	CS697	S11512-1	CS696	4686098	JA1706
3E5381	JS930	1320G515	CS694	S11512-14	CS696	4686099	JA1707
3E7285	CA1197IR	1320G830	CS697	S11524-20X	CS808	4686107	CS1190
3T4586	US863	1320H720	CS953	S11524-23	CS808	4686109	JS942
6N1889	US823	1320H830	CS697	S11524-23X	CS808	4727036	UA1213
6T7002	JS899	1321F022	CS700	S11524-7	CS808	4727206	CA1478IR
7C2264	JS906	1321F292	CS698	S11524-7X	CS808	4727220	JA1706
8C4774	JS930	1321G022	CS700	S11524-8	CS808	4727221	JA1707
8T8619	JS906	1321H022	CS700	S115A12-1	CS696	4727325	JA1707
9G5584	US823	1327A011	CS694	S115A12-14	CS696	4727329	JA1707
9W3748	JS930	1327A111	CS696	S115A24-1	CS700	4793110	CS990
9X0341	CA1198IR	1327A411	CS700	S115A24-11M	CS698	4793692	CA2099 *
PX0341	CA1198IR	1327A470	CS808	S115A24-21	CS544	4793804	CS1189
		1327A490	CS349	S115A24-23	CS808	5206971	UA949
CAV		1327A501	CS698	S115A24-29	CS808	5206981	UA949
1268580	CA1193IR	1327A600	CS544	S115A24-7	CS808	5213053	UA949
1268590	CA1193IR	1327A620	CS808	S115A24-9	CS349	5213079	UA949
1268610	CA1193IR	AC203RA	CA1669IR	S115HD24-2	CS1168	5213540	UA956
1268650	CA1193IR	AC203RA	CA1670IR	S115HD24-2	CS1168	5213541	UA956
1268660	CA1193IR	AC5RS-24	CA1193IR	Z1320F045	CS696	5213762	UA956
1268690	CA1193IR	CA4512-14	CS696	Z1320F161	CS696	5213763	UA956
1286000	CA1669IR	CA4512-2	CS694	Z1320F183	CS697	5226135	UA956
1320015	CS694	CA4512-3	CS695	Z1320F515	CS694	5226200	UA950
1320023	CS694	CA4512-4	CS696	Z1320F720	CS953	5226432	UA951
1320027	CS694	CA4512-51	CS694	ZGS002	CS1168	5226444	CS979
1320029	CS694	CA4512-51A	CS694	ZGS003	CS1168	5227100	UA950
1320035	CS695	CA4512-57	CS696			5227248	JS762
1320036	CS695	CA4512-72	CS694	CHRYSLER		5227267	UA951
1320043	CS696	CA4524-2	CS700	616955	US873	5227342	CS979
1320045	CS696	CA4524-29M	CS698	2095150	US812	5227548	JS762
1320090	CS702	CA45C12-18	CS696	2098500	US812	5233007	CS979
1320092	CS702	CA45C12-51	CS694	2875560	US812	5233160	UA951
1320142	CS696	CA45C12-9	CS702	3438176	UA926	5233199	UA951
1320161	CS696	CA45D12-16	CS696	3438177	UA926	5233418	UA957
1320180	CS696	CA45D12-18	CS697	3438178	UA926	5233449	UA957
1320183	CS697	CA45D12-2	CS694	3438179	UA926	5233472	UA950
1320510	CS694	CA45D12-3	CS695	3514308	UA926	5233474	UA950
1320513	CS694	CA45D12-4	CS696	3621860	UA926	5233508	UA951
1320515	CS694	CA45D12-51	CS694	3621861	UA926	5233599	UA959
1320571	CS696	CA45D12-57	CS696	3621866	UA926	5233608	UA959
1320702	CS953	CA45D12-72	CS953	3621867	UA926	5233660	UA959
1321021	CS700	CA45D12-83	CS697	3656130	UA926	5233672	UA957
1321022	CS700	CA45D12-9	CS702	3656131	UA926	5233949	UA957
1321023	CS700	CA45D12-Y51	CS694	3656395	UA926	5233973	UA957
1321291	CS698	CA45D24-2	CS700	3656397	UA926	5234026	UA960
1321292	CS698	CA45F12-18	CS697	3656455	UA926	5234027	UA960
1321513	CS700	CA45F12-3	CS695	3656459	UA926	5234028	UA960
1321531	CS698	CA45F12-51A	CS694	3656570	UA926	5234029	UA960
1321532	CS698	CA45F12-72	CS953	3656575	US812	5234031	UA960
1321533	CS698	CA45F12-83	CS697	3656650	US812	5234032	UA960
1327010	CS696	CA45F12-9	CS702	3755250	US822	5234033	UA961
1327110	CS696	CA45F12-Y16	CS696	3755259	US812	5234509	JS942

O.E. NO.	HC-PARTS	O.E. NO.	HC-PARTS	O.E. NO.	HC-PARTS	O.E. NO.	HC-PARTS
<b>CHRYSLER <i>Continued</i></b>		<b>DAEWOO</b>		<b>DAIHATSU</b>			
5234648	JS762	219170	JA1600IR	27020-13010-000	JA131	28100-87603-000	JS916
5252539	UA957	219251	JA1600IR	27020-13110-000	JA139	28100-87606-000	JS1086
5256427	UA951	96221945	CA1745IR	27020-13140-000	JA139	28100-87708-000	JS376
33002709	JS1006	96252115	CA1745IR	27020-13160-000	JA139	28100-87709-000	JS661
38522303	CA1590IR	96258990	CA1672IR	27020-15022-000	JA138	28100-87710-000	JS386
53008647	UA960	96275481	CS1210	27020-22011-000	JA130	28100-87713-000	JS386
56005684	UA960	96289030	JA1600IR	27020-24061-000	JA131	28100-87715-000	JS657
56005685	UA960	96289030	JA1600IR	27020-24062-000	JA131	28100-87719-000	JS665
56005686	UA961	96289430	CS1422	27020-26021-000	JA131	28100-87721-000	JS386
56026851	CS353	96303556	CA1671IR	27020-27011-000	JA114	28100-87722-000	JS376
56027221	UA961	96314258	JA1600IR	27020-31051-000	JA130	28100-87729-000	JS657
56027317	JS1006	96380673	JA1600IR	27020-72030-000	JA144	28100-87730-000	JS657
56027904	CS1175	96404263	JA1600IR	27020-87102-000	JA130	28100-87731-000	JS657
56027912	UA960	96430344	CS1188	27020-87103-000	JA130	28100-87734-000	JS376
56027913	UA961	96430345	CS879	27020-87209-000	JA130	28100-97204	JS1297
56041012	JS1006	96450663	CS879	27020-87210-000	JA114	28100-97204-000	JS1297
56041013	CS1175	96467385	CS1210	27020-87212-000	JA114	28100-97214-000	CS1498
56041014	JS1006	96469960	CS1183	27020-87214-000	JA114	28100-97401-000	CS1498
04686045AB	CS1501	96497700	CS1210	27020-87216-000	JA118	28100-97402-000	CS1498
04686045AD	CS1502	96497702	CS1422	27020-87508-000	JA114		
04727313AC	CS1454	96518124	JA1600IR	27020-87510-000	JA114	<b>DELPHI</b>	
04727313AA	CS1454	96518887	CS1210	27020-87603-000	JA195	461	CA1253IR
04868429AC	CA2021	96566261	JA1600IR	27030-87601-000	JA195	219170	JA1600IR
04868429AD	CA2021	96567255	JA1600IR	27030-87602-000	JA195	219235	JA1600IR
04868429AD	CA2021	96567255	JA1600IR	27030-87603-000	JA195	219235	JA1600IR
04868430AB	CA2092	96567255	JA1600IR	27030-87603-000	JA195	219292	JA1600IR
04868430AC	CA2092	96569440	CS1210	27030-87605-000	JA1529	10480403	CA1677IR
04868430AD	CA2092	96618789	CS1210	27030-87706-000	JA190	10480404	CA1838IR
04868430AE	CA2092	96943428	CS1210	27030-87707-000	JA190	10480407	CA1677IR
04868430AF	CA2092	65.26201-7039	JS552	27040-64052-000	JA578IR	10480408	CA1838IR
04868860AA	CS1482			27040-64150-000	JA578IR	96380673	JA1600IR
05033125AB	CS1481	<b>DAF</b>		27060-87103-000	JA866IR	<b>DELCO → REMY</b>	
05033440AC	CS1460	289183	CS1129	27060-87104-000	JA1127IR	<b>DENSO</b>	
05033440AA	CS1460	365211	CS617	27060-87106-000	JA1121IR	0726801000	CS589
05033757AB	CA1763IR	371963	CA240IR	27060-87107-000	JA1128IR	021000-0140	JA144
05033757AA	CA1763IR	636247	CA240IR	27060-87108-000	JA1281IR	021000-0351	JA130
38522261F	JA1706	1201327	CS989	27060-87109-000	JA1281IR	021000-0430	JA157
38522264F	JA1707	1248660	CA1770IR	27060-87112-000	JA880IR	021000-0441	JA144
4686045AB	CS1501	1254010	CA1667IR	27060-87201-000	JA551IR	021000-0470	JA131
4686045AC	CS1501	1274480	CA333IR	27060-87202-000	JA551IR	021000-0812	JA130
4727313AC	CS1454	1284299	CA1751IR	27060-87211-000	JA1358IR	021000-0813	JA130
4727313AA	CS1454	1284775	CS1274	27060-87501-000	JA551IR	021000-0814	JA130
4727325AA	JA1707	1287890	CS1331	27060-87502-000	JA551IR	021000-1083	JA130
4727329AA	JA1707	1298995	CA1035IR	27060-87512-000	JA880IR	021000-1083	JA130
4793692AB	CA2099	1317220	CS1274	27060-87601-000	JA880IR	021000-1242	JA130
4794222AB	CA2099	1340893	CA1480IR	27060-87602-000	JA880IR	021000-1321	JA131
4794222AC	CA2099	1340895	CS388	27060-87603-000	JA1120IR	021000-1322	JA131
4794222AD	CA2099	1346162	CS1331	27060-87604-000	JA764IR	021000-1330	JA131
4794222AA	CA2099	1350515	CA333IR	27060-87605-000	JA1120IR	021000-1332	JA131
4868429AC	CA2021	1357210	CS1274	27060-87608-000	JA764IR	021000-1340	JA131
4868429AD	CA2021	1357212	CS1274	27060-87701-000	JA160IR	021000-1342	JA131
4868860AA	CS1482	1357591	CA333IR	27060-87704-000	JA160IR	021000-1343	JA131
5033054AB	JA1791	1357592	CA333IR	27060-87705-000	JA160IR	021000-1602	JA130
5033054AC	JA1791	1357593	CA1035IR	27060-87706-000	JA979IR	021000-1608	JA130
5033067AB	JS1316	1368327	CA1694IR	27060-87707-000	JA763IR	021000-1800	JA131
5033067AA	JS1316	1377860	CA1693IR	27060-87709-000	JA763IR	021000-1830	JA131
5033125AB	CS1481	1387383	CS1382	27060-87714-000	JA764IR	021000-1840	JA131
5033177AB	JA1791	1516445	CA1300IR	27060-87715-000	JA978IR	021000-1860	JA131
5033440AC	CS1460	1604246	CS1380	27060-87716-000	JA978IR	021000-1861	JA131
56005685AB	UA960	1626130	CA1917IR	27060-87717-000	JA978IR	021000-1870	JA131
56041012AB	JS1006	1649066	CA1939IR	27060-87719-000	JA1431IR	021000-1871	JA131
56041394AA	UA961	1667205	CS1380	27060-87720-000	JA1280IR	021000-1881	JA131
56041579AB	CS1507	1688625	CS1420	27060-87721-000	JA764IR	021000-1881	JA131
		1688720	CS1380	27060-87725-000	JA1280IR	021000-1970	JA131
<b>CITROËN → PEUGEOT</b>		1697022	CA1694IR	27060-97202-000	JA1609IR	021000-2470	JA137
<b>CUMMINS</b>		1697023	CA1693IR	27060-97203-000	JA1609IR	021000-2490	JA130
3056492	UA946IR	1697024	CA1693IR	27060-97705-000	JA160IR	021000-2500	JA130
3255439	CA333IR	1697321	CA1694IR	28100-13060-000	JS333	021000-2840	JA118
3282554	CA1198IR	1697322	CA1693IR	28100-15070-000	JS339	021000-2991	JA130
3916854	US845	1725900	CS1486	28100-72010-000	JS385	021000-3000	JA110
3918377	US857	1735788	CS1331	28100-72080-000	JS385	021000-3001	JA110
3920679	CA1197IR	1739935	CS1420	28100-87106-000	JS998	021000-3010	JA110
3926932	US857	1739936	CS1380	28100-87107-000	JS998	021000-3030	JA131
3935530	UA1620IR	1826121	CS1420	28100-87316-000	JS1005	021000-3040	JA130
		1843852	CS1420	28100-87401-000	JS1220	021000-3051	JA111
		1876369	CS1420	28100-87526-000	JS901	021000-3061	JA130
				28100-87548-000	JS901	021000-3180	JA131
				28100-87601-000	JS521	021000-3460	JA137
				28100-87602-000	JS1086		



O.E. NO.	HC-PARTS	O.E. NO.	HC-PARTS	O.E. NO.	HC-PARTS	O.E. NO.	HC-PARTS
021000-3500	JA131	021000-6643	JA137	021000-9700	JA176	028000-4270	JS335
021000-3540	JA110	021000-6660	JA176	021000-9770	JA153	028000-4330	JS335
021000-3541	JA131	021000-6661	JA176	021000-9851	JA676	028000-4331	JS335
021000-3600	JA131	021000-6670	JA138	021000-9930	JA676	028000-4332	JS335
021000-3610	JA131	021000-6671	JA138	021000-9980	JA982	028000-4340	JS383
021000-3620	JA131	021000-6691	JA134	02131-9261	CA2018IR	028000-4341	JS383
021000-3630	JA131	021000-6692	JA134	02131-9262	CA2018IR	028000-4343	JS383
021000-3640	JA131	021000-6710	JA137	028000-0197	JS336	028000-4440	JS335
021000-3641	JA131	021000-6711	JA137	028000-0370	JS335	028000-4490	JS335
021000-3650	JA176	021000-6712	JA137	028000-0430	JS337	028000-4491	JS335
021000-3660	JA131	021000-6732	JA137	028000-0960	JS735	028000-4500	JS331
021000-3671	JA131	021000-6771	JA140	▲ 028000-1010	JS336	028000-4512	JS669
021000-3690	JA131	021000-6772	JA140	▲ 028000-1011	JS336	028000-4550	JS315
021000-3700	JA131	021000-6800	JA138	028000-1370	JS337	028000-4600	JS333
021000-3710	JA131	021000-6861	JA130	028000-1850	JS330	028000-4601	JS333
021000-3720	JA131	021000-6980	JA872	028000-1970	JS336	028000-4630	JS331
021000-3721	JA131	021000-7200	JA111	028000-1971	JS336	028000-4631	JS331
021000-3760	JA131	021000-7250	JA118	028000-1972	JS336	028000-4640	JS331
021000-3780	JA131	021000-7260	JA131	028000-1973	JS336	028000-4650	JS333
021000-3790	JA131	021000-7540	JA157	028000-1975	JS336	028000-4651	JS333
021000-3830	JA137	021000-7550	JA157	028000-1976	JS336	028000-4680	JS333
021000-3840	JA137	021000-7570	JA149	028000-2000	JS335	028000-4681	JS333
021000-3950	JA137	021000-7910	JA138	028000-2001	JS335	028000-4690	JS333
021000-4271	JA791	021000-7911	JA138	028000-2150	JS330	028000-4691	JS333
021000-4510	JA791	021000-7920	JA131	028000-2151	JS330	028000-4700	JS333
021000-4550	JA118	021000-7931	JA131	028000-2240	JS330	028000-4710	JS333
021000-4570	JA130	021000-7932	JA131	028000-2241	JS330	028000-4750	JS335
021000-5011	JA131	021000-7940	JA131	028000-2360	JS337	028000-4810	JS336
021000-5020	JA131	021000-7970	JA131	028000-2361	JS337	028000-4811	JS336
021000-5030	JA131	021000-7971	JA131	028000-2363	JS337	028000-4812	JS336
021000-5040	JA131	021000-7980	JA134	028000-2364	JS337	028000-4980	JS310
021000-5046	JA131	021000-7990	JA176	028000-2570	JS335	028000-5040	JS931
021000-5050	JA131	021000-8011	JA131	028000-2571	JS335	028000-5200	CS181
021000-5051	JA157	▲ 021000-8020	JA131	028000-2572	JS335	028000-5201	CS181
021000-5060	JA131	021000-8021	JA131	028000-2660	JS335	028000-5210	CS181
021000-5070	JA131	021000-8030	JA131	028000-2661	JS335	028000-5240	JS315
021000-5080	JA131	021000-8040	JA137	▲ 028000-2662	JS335	028000-5290	JS330
021000-5081	JA137	021000-8090	JA139	028000-2665	JS335	028000-5300	JS736
021000-5110	JA131	021000-8120	JA130	▲ 028000-2680	JS335	028000-5330	JS338
021000-5111	JA131	021000-8130	JA118	028000-2681	JS335	028000-5331	JS338
021000-5130	JA131	021000-8140	JA118	028000-2682	JS335	028000-5332	JS338
021000-5131	JA131	021000-8210	JA137	028000-2682	JS335	028000-5332	JS338
021000-5141	JA131	021000-8220	JA134	028000-2930	JS331	028000-5333	JS338
021000-5150	JA131	021000-8221	JA134	028000-2931	JS331	028000-5334	JS338
021000-5160	JA131	021000-8221	JA134	028000-2932	JS331	028000-5335	JS338
021000-5160	JA131	021000-8230	JA138	028000-2933	JS331	028000-5360	JS390
021000-5170	JA131	▲ 021000-8231	JA138	028000-2970	JS372	028000-5400	CS78
021000-5180	JA131	021000-8250	JA139	028000-3005	JS335	028000-5401	CS78
021000-5190	JA144	021000-8260	JA687	028000-3006	JS336	028000-5410	CS78
021000-5230	JA137	021000-8261	JA687	028000-3051	JS331	028000-5430	JS310
021000-5240	JA131	021000-8262	JA687	028000-3052	JS331	028000-5470	JS310
021000-5250	JA137	021000-8270	JA144	028000-3290	JS931	028000-5530	JS656
021000-5280	JA131	021000-8271	JA144	028000-3291	JS931	028000-5581	JS392
021000-5290	JA131	021000-8290	JA687	028000-3292	JS931	028000-5620	JS656
021000-5450	JA130	▲ 021000-8310	JA144	028000-3360	JS932	028000-5720	JS360
021000-5490	JA130	021000-8311	JA144	028000-3500	JS673	028000-5730	JS1239
021000-5500	JA176	021000-8330	JA139	028000-3501	JS673	028000-5740	JS330
021000-5501	JA176	021000-8400	JA168	028000-3700	JS335	028000-5751	JS360
021000-5600	JA130	021000-8410	JA157	028000-3710	JS335	028000-5800	JS732
021000-5650	JA157	021000-8640	JA118	028000-3730	JS387	028000-5821	JS669
021000-5651	JA157	021000-8670	JA114	028000-3770	JS336	028000-5822	JS669
021000-5900	JA131	021000-8680	JA130	028000-3800	JS330	028000-5860	JS733
021000-5910	JA131	021000-8710	JA157	028000-3820	JS337	028000-5861	JS733
021000-5950	JA131	021000-8830	JA149	028000-3822	JS337	028000-5862	JS733
021000-5960	JA131	021000-8890	JA149	028000-3825	JS337	028000-5863	JS733
021000-6110	JA131	021000-8892	JA149	028000-3830	JS330	028000-5864	JS733
021000-6370	JA118	021000-8980	JA157	▲ 028000-3840	JS331	028000-5880	JS1012
021000-6411	JA114	▲ 021000-9040	JA157	028000-3841	JS331	028000-5900	JS316
021000-6420	JA172	021000-9050	JA168	028000-3842	JS331	028000-5910	JS371
021000-6510	JA131	021000-9051	JA168	028000-3920	JS331	028000-5911	JS371
021000-6600	JA157	▲ 021000-9080	JA157	028000-3950	JS335	028000-5912	JS371
021000-6610	JA137	021000-9091	JA157	028000-3960	JS335	028000-6000	JS388
021000-6611	JA137	021000-9100	JA168	028000-4010	JS315	028000-6001	JS388
021000-6612	JA137	021000-9120	JA157	028000-4011	JS315	028000-6030	JS314
021000-6630	JA137	021000-9130	JA157	▲ 028000-4030	JS333	028000-6031	JS314
021000-6631	JA137	▲ 021000-9150	JA157	▲ 028000-4031	JS333	028000-6041	JS314
021000-6632	JA137	021000-9260	JA139	028000-4032	JS333	028000-6050	JS347
021000-6640	JA137	021000-9510	JA130	028000-4042	JS333	028000-6140	JS676
021000-6641	JA137	021000-9521	JA110	▲ 028000-4050	JS333	028000-6200	JS746
021000-6642	JA137	021000-9561	JA130	028000-4090	JS323	028000-6201	JS746

O.E. NO.	HC-PARTS	O.E. NO.	HC-PARTS	O.E. NO.	HC-PARTS	O.E. NO.	HC-PARTS
<b>DENSO <i>Continued</i></b>							
028000-6202	JS746	028000-7462	JS673	028000-9580	JS356	100210-3780	JA1362
028000-6250	JS897	028000-7470	JS673	028000-9680	JS317	100210-3810	JA777
028000-6260	JS734	028000-7471	JS673	028000-9690	JS381	100210-3820	JA777
028000-6290	JS521	028000-7520	JS336	028000-9710	JS312	100210-3821	JA777
028000-6291	JS521	028000-7521	JS336	028000-9711	JS312	100210-3840	JA1270
028000-6292	JS521	028000-7530	JS335	028000-9720	JS317	100210-3871	JA1529
028000-6300	JS657	028000-7550	JS669	028000-9800	JS670	100210-7570	JA149
028000-6330	JS372	028000-7560	JS316	028000-9810	JS393	100211-0050	JA167IR
028000-6391	JS331	028000-7580	JS354	028000-9820	JS898	100211-0071	JA785IR
028000-6393	JS331	028000-7581	JS354	028000-9830	JS910	100211-0081	JA785IR
028000-6396	JS331	028000-7600	JS373	028000-9860	JS383	100211-0110	JA152IR
028000-6420	JS335	028000-7620	JS659	028000-9900	JS512	100211-0111	JA152IR
028000-6421	JS335	028000-7621	JS659	028000-9901	JS512	100211-0130	JA152IR
028000-6422	JS335	028000-7650	JS310	028000-9902	JS512	100211-0131	JA152IR
028000-6430	JS331	028000-7651	JS375	028000-9940	JS630	100211-0132	JA152IR
028000-6490	JS333	028000-7680	CS181	100210-0441	JA651	100211-0140	JA150IR
028000-6491	JS333	028000-7681	CS181	100210-0442	JA651	100211-0142	JA150IR
028000-6492	JS333	028000-7711	CS78	100210-0482	JA651	100211-0211	JA152IR
028000-6493	JS333	028000-7720	JS393	100210-0731	JA651	100211-0280	JA785IR
028000-6494	JS333	028000-7760	JS348	100210-1390	JA651	100211-0290	JA785IR
028000-6495	JS333	028000-7790	JS552	100210-1391	JA651	100211-0291	JA785IR
028000-6510	JS387	028000-7791	JS552	100210-1400	JA651	100211-0292	JA785IR
028000-6511	JS387	028000-7810	JS666	100210-1401	JA651	100211-0320	JA117IR
028000-6520	JS348	028000-7830	JS896	100210-1421	JA651	100211-0322	JA117IR
028000-6530	JS393	028000-7980	JS381	100210-1441	JA651	100211-0340	JA152IR
028000-6600	JS310	028000-7981	JS381	100210-1441	JA651	100211-0341	JA152IR
028000-6620	JS315	028000-7990	JS375	100210-1531	JA651	100211-0341	JA152IR
028000-6700	JS314	028000-8000	JS315	100210-1550	JA149	100211-0360	JA152IR
028000-6701	JS314	028000-8010	JS375	100210-1551	JA149	100211-0420	JA543IR ▲
028000-6720	JS347	028000-8010	JS375	100210-1552	JA149	100211-0421	JA543IR ▲
028000-6721	JS347	028000-8050	JS339	100210-1553	JA149	100211-0422	JA543IR ▲
028000-6790	JS338	028000-8060	JS382	100210-1555	JA149	100211-0440	JA543IR
028000-6801	JS335	028000-8070	JS392	100210-1571	JA149	100211-0540	JA167IR
028000-6810	JS335	028000-8071	JS392	100210-1572	JA149	100211-0550	JA167IR
028000-6811	JS335	028000-8320	JS730	100210-1573	JA149	100211-0560	JA167IR
028000-6812	JS335	028000-8321	JS730	100210-2120	JA800	100211-0580	JA543IR
028000-6813	JS335	028000-8370	JS663	100210-2130	JA800	100211-0581	JA543IR
028000-6820	JS336	028000-8371	JS663	100210-2220	JA195	100211-0660	JA167IR
028000-6821	JS336	028000-8380	JS926	100210-2221	JA195	100211-0790	JA785IR
028000-6822	JS336	028000-8400	JS929	100210-2250	JA676	100211-0790	JA785IR
028000-6823	JS336	028000-8430	JS675	100210-2251	JA676	100211-1000	JA161IR
028000-6870	JS392	028000-8440	JS371	100210-2290	JA982	100211-1001	JA161IR
028000-6880	JS392	028000-8451	JS377	100210-2290	JA982	100211-1010	JA161IR ▲
028000-6890	JS392	028000-8460	JS310	100210-2302	JA1125	100211-1011	JA161IR ▲
028000-6891	JS392	028000-8570	JS670	100210-2340	JA143	100211-1021	JA189IR ▲
028000-6892	JS392	028000-8580	JS373	100210-2343	JA143	100211-1040	JA142IR
028000-6910	JS392	028000-8581	JS373	100210-2350	JA676	100211-1041	JA142IR
028000-6960	JS339	028000-8590	JS393	100210-2570	JA676	100211-1041	JA142IR
028000-6961	JS339	028000-8620	JS391	100210-2600	JA193	100211-1060	JA189IR
028000-6962	JS339	028000-8670	JS315	100210-2620	JA145	100211-1061	JA189IR
028000-7000	JS552	028000-8690	JS375	100210-2660	JA193	100211-1080	JA177IR
028000-7001	JS552	028000-8700	JS375	100210-2700	JA193	100211-1081	JA177IR
028000-7002	JS552	028000-8730	JS387	100210-2710	JA190	100211-1090	JA657IR ▲
028000-7003	JS552	028000-8760	JS642	100210-2720	JA190	100211-1091	JA657IR ▲
028000-7004	JS552	028000-8761	JS642	100210-2730	JA145	100211-1140	JA189IR
028000-7091	JS333	028000-8762	JS642	100210-2750	JA193	100211-1141	JA189IR
028000-7092	JS333	028000-8770	JS375	100210-2760	JA196	100211-1141	JA189IR
028000-7093	JS333	028000-8780	JS393	100210-2760	JA196	100211-1150	JA657IR ▲
028000-7110	CS123	028000-8921	JS368	100210-2840	JA195	100211-1170	JA161IR
028000-7111	CS123	028000-8980	JS377	100210-2860	JA676	100211-1171	JA161IR
028000-7120	CS123	028000-9010	JS336	100210-2861	JA676	100211-1200	JA189IR
028000-7121	CS123	028000-9020	JS335	100210-2861	JA676	100211-1201	JA189IR
028000-7190	JS315	028000-9030	JS780	100210-2960	JA1124	100211-1201	JA189IR
028000-7191	JS315	028000-9070	JS382	100210-2980	JA1125	100211-1230	JA189IR
028000-7210	JS310	028000-9090	JS387	100210-2991	JA676	100211-1231	JA189IR
028000-7240	JS666	028000-9091	JS387	100210-3080	JA193	100211-1270	JA113IR
028000-7241	JS666	028000-9121	JS356	100210-3230	JA190	100211-1271	JA113IR
028000-7242	JS666	028000-9220	JS758	100210-3240	JA190	100211-1280	JA141IR
028000-7290	JS360	028000-9221	JS758	100210-3270	JA777	100211-1310	JA751IR ▲
028000-7320	JS312	028000-9260	JS385	100210-3280	JA195	100211-1321	JA142IR
028000-7321	JS312	028000-9261	JS385	100210-3280	JA195	100211-1321	JA142IR
028000-7370	JS642	028000-9270	JS669	100210-3350	JA777	100211-1330	JA697IR ▲
028000-7372	JS642	028000-9321	JS765	100210-3360	JA777	100211-1331	JA697IR ▲
028000-7373	JS642	028000-9380	JS527	100210-3381	JA656	100211-1341	JA142IR
028000-7390	JS312	028000-9470	JS901	100210-3400	JA777	100211-1350	JA752IR
028000-7392	JS312	028000-9490	JS376	100210-3410	JA656	100211-1351	JA752IR ▲
028000-7440	JS390	028000-9500	JS661	100210-3460	JA777	100211-1370	JA752IR ▲
028000-7460	JS673	028000-9501	JS661	100210-3470	JA656	100211-1371	JA752IR ▲
028000-7461	JS673	028000-9510	JS386	100210-3480	JA656	100211-1381	JA113IR
				100210-3580	JA777	100211-1400	JA160IR
				100210-3660	JA1270	100211-1401	JA160IR
				100210-3680	JA777	100211-1402	JA160IR
				100210-3720	JA195	100211-1410	JA188IR
				100210-3760	JA1270	100211-1411	JA188IR
				100210-3770	JA777	100211-1440	JA141IR

O.E. NO.	HC-PARTS	O.E. NO.	HC-PARTS	O.E. NO.	HC-PARTS	O.E. NO.	HC-PARTS
100211-1470	JA652IR	100211-3300	JA759IR	100211-6600	JA798IR ▲	100211-8440	JA882IR
100211-1550	JA188IR	100211-3310	JA772IR	100211-6640	JA763IR	100211-8490	JA1351IR
100211-1560	JA141IR	100211-3311	JA772IR	100211-6660	JA880IR	100211-8560	JA885IR
100211-1570	JA798IR	100211-3321	JA1164IR	100211-6720	JA798IR	100211-8590	JA783IR
100211-1571	JA798IR	100211-3352	JA552IR	100211-6730	JA880IR	100211-8610	JA1272IR
100211-1600	JA141IR	100211-3370	JA880IR	100211-6750	JA553IR ▲	100211-8611	JA1272IR
100211-1601	JA141IR	100211-3380	JA545IR	100211-6790	JA763IR	100211-8630	CA1069IR
100211-1610	JA551IR	100211-3401	JA142IR	100211-6800	JA160IR	100211-8631	CA1069IR
100211-1611	JA551IR	100211-3410	JA161IR ▲	100211-6801	JA160IR ▲	100211-8632	CA1069IR
100211-1620	JA553IR	100211-3500	JA142IR ▲	100211-6860	JA141IR ▲	100211-8700	JA1414IR
100211-1630	JA551IR	100211-3520	JA657IR ▲	100211-6920	JA866IR	100211-8710	JA1163IR
100211-1640	JA551IR	100211-3530	JA142IR	100211-6960	JA1170IR ▲	100211-8720	JA760IR
100211-1650	JA551IR	100211-3540	JA142IR ▲	100211-6961	JA1170IR ▲	100211-8780	JA760IR
100211-1661	JA971IR	100211-3560	JA142IR ▲	100211-6970	JA1170IR	100211-8860	JA1165IR
100211-1662	JA971IR	100211-3580	JA751IR	100211-6990	JA1120IR ▲	100211-8960	CA1096IR
100211-1670	JA551IR	100211-3590	JA753IR	100211-7000	JA552IR	100211-9190	JA1121IR
100211-1680	JA551IR	100211-3600	JA753IR	100211-7012	JA545IR	100211-9310	JA764IR
100211-2000	JA657IR ▲	100211-3610	JA142IR	100211-7040	JA161IR	100211-9320	JA978IR
100211-2001	JA657IR ▲	100211-3660	JA753IR	100211-7050	JA552IR	100211-9330	JA978IR
100211-2010	JA696IR ▲	100211-3680	JA657IR	100211-7060	JA546IR ▲	100211-9331	JA978IR
100211-2011	JA696IR	100211-3740	JA142IR ▲	100211-7061	JA546IR ▲	100211-9340	JA978IR
100211-2021	JA161IR	100211-3760	JA142IR	100211-7070	JA555IR	100211-9400	JA142IR ▲
100211-2030	JA1123IR	100211-3800	JA682IR	100211-7071	JA555IR	100211-9410	JA1128IR
100211-2031	JA1123IR	100211-3810	JA682IR	100211-7090	JA996IR	100211-9700	JA996IR ▲
100211-2040	JA161IR	100211-3850	JA751IR	100211-7100	JA996IR	100211-9710	JA142IR ▲
100211-2050	JA657IR	100211-3860	JA751IR	100211-7130	JA142IR	100211-9740	JA1273IR
100211-2070	JA996IR	100211-3870	JA753IR	100211-7140	JA996IR ▲	100211-9750	JA1280IR
100211-2071	JA996IR	100211-3880	JA753IR	100211-7160	JA161IR	100211-9760	JA980IR
100211-2080	JA657IR ▲	100211-3890	JA753IR	100211-7170	JA984IR	100211-9780	JA161IR
100211-2102	JA546IR	100211-3930	JA753IR	100211-7210	JA1289IR	100211-9800	JA161IR
100211-2110	JA657IR	100211-3980	JA1127IR	100211-7250	JA771IR	100211-9830	JA759IR
100211-2130	JA554IR	100211-4000	JA792IR	100211-7260	JA657IR ▲	100211-9840	JA1123IR
100211-2140	JA696IR	100211-4001	JA792IR	100211-7300	JA161IR ▲	100211-9880	JA1165IR
100211-2150	JA771IR	100211-4002	JA792IR	100211-7310	JA161IR ▲	100211-9970	JA759IR
100211-2151	JA771IR	100211-4003	JA792IR	100211-7320	JA1272IR	100211-9980	JA772IR
100211-2170	JA189IR	100211-4004	JA792IR	100211-7340	JA980IR	100213-0230	JA799IR
100211-2200	JA802IR	100211-4070	JA188IR	100211-7350	JA1280IR	100213-0231	JA799IR
100211-2201	JA802IR	100211-4080	JA160IR	100211-7370	JA984IR	100213-0250	JA799IR
100211-2231	JA697IR	100211-4120	JA160IR	100211-7430	JA142IR ▲	100213-0260	JA194IR
100211-2250	JA657IR ▲	100211-4140	JA1120IR	100211-7440	JA657IR	100213-0280	JA194IR
100211-2280	JA142IR	100211-4141	JA1120IR	100211-7450	JA546IR ▲	100213-0290	JA799IR
100211-2290	JA697IR	100211-4160	JA553IR	100211-7460	JA1164IR	100213-0300	JA194IR
100211-2300	JA142IR ▲	100211-4170	JA141IR	100211-7530	JA759IR	100213-0451	JA578IR
100211-2310	JA752IR	100211-4180	JA160IR	100211-7570	JA1123IR	100213-0520	JA1352IR
100211-2320	JA142IR	100211-4280	JA141IR	100211-7580	JA1354IR	100213-0610	JA194IR
100211-2370	JA189IR	100211-4290	JA141IR	100211-7590	JA1354IR	100213-0710	JA578IR
100211-2380	JA189IR	100211-4350	JA979IR	100211-7600	JA657IR	100213-0740	JA578IR
100211-2410	JA546IR	100211-4351	JA979IR	100211-7640	JA783IR	100213-0745	JA578IR
100211-2450	JA546IR	100211-4390	JA160IR	100211-7760	JA759IR	100213-0750	JA194IR
100211-2451	JA546IR	100211-4400	JA141IR	100211-7770	JA772IR	100213-0760	JA194IR
100211-2480	JA161IR ▲	100211-4410	JA553IR	100211-7780	JA783IR	100213-0790	JA799IR
100211-2500	JA546IR ▲	100211-4440	JA551IR	100211-7810	JA772IR	100213-0850	JA194IR
100211-2510	JA657IR	100211-4450	JA551IR	100211-7811	JA772IR	100213-0860	JA194IR
100211-2550	JA555IR	100211-4490	JA551IR	100211-7830	JA1294IR	100213-0941	JA881IR
100211-2830	JA885IR	100211-4520	JA551IR	100211-7840	JA1294IR	100213-0950	JA194IR
100211-2840	JA885IR	100211-4540	JA970IR	100211-7850	JA1296IR	100213-0960	JA194IR
100211-2860	JA885IR ▲	100211-4560	JA551IR	100211-7861	JA1351IR	100213-1011	JA881IR
100211-3040	JA161IR	100211-4620	JA1358IR	100211-7870	JA1289IR	100213-1030	JA750IR
100211-3050	JA142IR ▲	100211-4621	JA1358IR	100211-7910	JA783IR	100213-1040	JA750IR
100211-3060	JA161IR	100211-4650	JA551IR ▲	100211-8000	JA885IR ▲	100213-1120	JA571IR
100211-3070	JA161IR ▲	100211-4660	JA551IR	100211-8010	JA161IR ▲	100213-1130	JA881IR
100211-3090	JA142IR	100211-4670	JA551IR	100211-8030	JA552IR	100213-1140	JA881IR
100211-3091	JA142IR	100211-4680	JA551IR	100211-8031	JA552IR	100213-1180	JA799IR ▲
100211-3100	JA161IR	100211-4740	JA551IR	100211-8050	JA161IR	100213-1210	JA571IR
100211-3101	JA161IR	100211-5090	JA881IR	100211-8090	JA161IR	100213-1240	JA881IR
100211-3130	JA189IR	100211-5250	JA989IR	100211-8110	JA885IR ▲	100213-1260	JA578IR ▲
100211-3140	JA189IR ▲	100211-5730	JA880IR	100211-8130	JA161IR	100213-1300	JA799IR ▲
100211-3141	JA189IR ▲	100211-5800	JA785IR	100211-8150	JA1163IR	100213-1450	JA571IR
100211-3150	JA161IR	100211-6030	JA864IR	100211-8151	JA1163IR	100213-1500	JA571IR ▲
100211-3151	JA161IR	100211-6031	JA864IR	100211-8170	JA760IR	100213-1520	JA799IR ▲
100211-3160	JA1123IR	100211-6040	JA763IR	100211-8230	JA783IR	100213-1560	JA1132IR
100211-3170	JA657IR	100211-6050	JA864IR	100211-8240	JA885IR ▲	100213-1700	JA799IR
100211-3180	JA996IR	100211-6051	JA864IR	100211-8270	JA1414IR	100213-1730	JA1367IR
100211-3181	JA996IR	100211-6110	JA1417IR	100211-8330	JA783IR	100213-1740	JA1359IR
100211-3200	JA657IR	100211-6200	JA1118IR	100211-8340	JA783IR	100213-1770	JA1367IR
100211-3220	JA189IR	100211-6210	JA1118IR ▲	100211-8370	CA381IR	100213-1790	JA750IR
100211-3221	JA189IR	100211-6360	JA1417IR	100211-8380	JA882IR	100213-1900	JA989IR
100211-3240	JA142IR ▲	100211-6420	JA1616IR	100211-8392	JA1351IR	100213-1910	JA989IR
100211-3260	JA657IR	100211-6492	JA1616IR ▲	100211-8410	JA1295IR	100213-1911	JA989IR

O.E. NO.	HC-PARTS	O.E. NO.	HC-PARTS	O.E. NO.	HC-PARTS	O.E. NO.	HC-PARTS
<b>DENSO <i>Continued</i></b>							
100213-1920	JA1355IR	101211-0341	JA988IR	101211-7870	JA1724IR	102211-5050	JA1535IR
100213-2220	JA578IR ▲	101211-0342	JA988IR	101211-7871	JA1724IR	102211-5051	JA1535IR
100213-2272	JA1424IR	101211-0370	JA1431IR	101211-7872	JA1724IR	102211-5052	JA1535IR
100213-2320	JA1425IR	101211-0380	JA981IR	101211-7891	CA2073IR *	102211-5070	JA1293IR ▲
100213-2350	JA1367IR	101211-0430	JA1178IR	101211-7892	CA2073IR *	102211-5090	JA988IR
100213-2351	JA1367IR	101211-0431	JA1178IR	101211-9050	JA1134IR	102211-5150	JA1293IR ▲
100213-2470	JA1367IR	101211-0432	JA1178IR	101211-9180	JA1356IR	102211-5151	JA1293IR ▲
100213-2471	JA1367IR	101211-0521	JA1535IR	101211-9280	JA987IR	102211-5160	JA1293IR
100213-2530	JA1710IR	101211-0522	JA1535IR	101211-9360	JA1604IR	102211-5161	JA1293IR
100213-2540	JA1425IR	101211-0540	JA1536IR	101211-9500	JA987IR	102211-5200	JA1536IR ▲
100213-2580	JA1367IR	101211-0541	JA1536IR	101211-9510	JA1134IR	102211-5230	JA1612IR
100213-2630	JA1424IR	101211-0542	JA1536IR	101211-9520	JA1604IR	102211-5231	JA1612IR
100213-2790	JA1424IR	101211-0543	JA1536IR	101211-9570	JA1720IR	102211-5250	JA1722IR
100213-2920	JA1367IR	101211-0550	JA1293IR	101211-9670	JA1134IR	102211-5260	JA1793IR
100213-2940	JA1808IR	101211-0551	JA1293IR ▲	101211-9750	JA1719IR	102211-5280	JA1293IR
100213-2950	JA1808IR	101211-0560	JA598IR ▲	101211-9770	JA1719IR	102211-5300	JA1722IR ▲
100213-2980	JA1808IR	101211-0580	JA1369IR	101211-9920	CA2074IR *	102211-5360	CA2047IR
100213-2990	JA1808IR	101211-0581	JA1369IR	101211-9931	CA2075IR *	102211-5380	JA1793IR
100213-2991	JA1808IR	101211-0582	JA1369IR	101211-0500	CA1439IR	102211-5520	JA1293IR
100213-2993	JA1808IR	101211-0600	JA1428IR	102211-0670	JA1783IR	102211-5600	JA1796IR
101210-0160	CA1952IR	101211-0620	JA981IR ▲	102211-0750	JA1613IR	102211-5610	JA1293IR
101210-0161	CA1952IR	101211-0722	JA1293IR	102211-0770	JA1797IR	102211-5640	CA2047IR
101210-0162	CA1952IR	101211-0723	JA1293IR	102211-0780	JA1797IR	102211-5650	JA1793IR ▲
101210-0870	CA2048IR	101211-0740	JA988IR	102211-0981	CA2073IR *	102211-5660	JA1893IR
101210-0871	CA2048IR	101211-0741	JA988IR	102211-1070	JA1719IR	102211-5860	JA1536IR ▲
101210-0890	JA1894IR	101211-0851	JA981IR	102211-1071	JA1719IR	102211-5930	JA1793IR
101210-0891	JA1894IR	101211-0971	JA1410IR	102211-1200	JA987IR	102211-5940	JA1793IR
101210-0920	CA1989IR	101211-0972	JA1410IR	102211-1210	JA987IR	102211-8000	JA1809IR
101210-0921	CA1989IR	101211-1180	JA551IR	102211-1230	JA1134IR	102211-8010	JA1800IR
101210-0940	CA2046IR *	101211-2100	JA764IR	102211-1240	JA1134IR	102211-8030	CA1483IR
101210-0950	CA1955IR	101211-2120	JA798IR	102211-1340	JA1134IR	102211-8031	CA1483IR
101210-0951	CA1955IR	101211-2130	JA1274IR	102211-1360	JA1534IR	102211-8040	CA1340IR
101210-0960	CA1956IR	101211-2730	JA1609IR ▲	102211-1430	JA1356IR	102211-8041	CA1340IR
101210-0961	CA1956IR	101211-2731	JA1609IR ▲	102211-1450	JA1723IR	102211-8050	CA2093IR *
101210-0970	CA1987IR	101211-2750	JA1609IR	102211-1451	JA1723IR	102211-8051	CA2093IR *
101210-0971	CA1987IR	101211-2751	JA1609IR	102211-1460	JA1608IR	102211-8052	CA2093IR *
101210-0990	CA1995IR	101211-2841	JA160IR	102211-1461	JA1608IR	102211-8060	CA1475IR
101210-1080	CA1969IR	101211-3030	JA1274IR	102211-1471	JA1596IR	102211-8061	CA1475IR
101210-1081	CA1969IR	101211-3040	JA764IR ▲	102211-1650	JA1608IR	102211-8070	CA1475IR
101210-1090	CA2049IR *	101211-3050	JA1120IR	102211-1670	JA1714IR	102211-8071	CA1475IR
101210-1091	CA2049IR *	101211-3200	JA764IR	102211-1680	JA1517IR	102211-8080	CA1475IR
101210-1100	CA2050IR *	101211-3370	JA880IR	102211-1770	JA1787IR	102211-8081	CA1475IR
101210-1101	CA2050IR *	101211-3770	JA880IR	102211-1780	JA1720IR	102211-8081	CA1475IR
101210-1110	CA1855IR	101211-4160	JA981IR	102211-1910	JA1703IR	102211-8190	JA1809IR
101210-1120	CA1862IR	101211-4161	JA981IR	102211-1920	JA1703IR	102211-8200	JA1800IR
101210-1121	CA1862IR	101211-4240	JA1280IR	102211-1920	JA1703IR	102211-8220	CA1844IR
101210-1180	CA1855IR	101211-4370	JA1536IR	102211-1950	JA1794IR	102211-8230	CA1766IR
101210-1181	CA1855IR	101211-4420	JA981IR	102211-1951	JA1794IR	102211-8260	CA1885IR
101210-1190	CA1862IR	101211-4580	JA976IR	102211-1960	JA1595IR	102211-8270	CA1995IR
101210-1191	CA1862IR	101211-5010	JA1134IR	102211-2020	JA1703IR	102211-8280	CA1886IR
101210-1210	CA1856IR	101211-5020	JA976IR	102211-2120	JA1792IR	102211-8281	CA1886IR
101210-1211	CA1856IR	101211-5100	JA1166IR	102211-2180	JA1703IR	102211-8281	CA1886IR
101210-1380	CA2070IR *	101211-5110	JA1372IR	102211-2190	JA1293IR	102211-8310	CA1886IR ▲
101210-1381	CA2070IR *	101211-5120	JA1166IR	102211-2220	CA1676IR	102211-8351	CA1925IR
101210-1410	CA1949IR	101211-5130	JA1119IR	102211-2221	CA1676IR	102211-8352	CA1925IR
101210-1510	CA1558IR	101211-5150	JA988IR	102211-2222	CA1676IR	102211-8353	CA1925IR
101211-0030	JA772IR	101211-5150	JA988IR	102211-2223	CA1676IR	102211-8355	CA1925IR
101211-0033	JA772IR	101211-5170	JA1119IR	102211-2230	CA1869IR	102211-8400	CA1499IR
101211-0040	JA1178IR ▲	101211-5210	JA783IR ▲	102211-2231	CA1869IR	102211-8410	CA1665IR
101211-0050	JA988IR ▲	101211-5230	JA1134IR	102211-2232	CA1869IR	102211-8430	CA1766IR
101211-0051	JA988IR	101211-5240	JA976IR	102211-2233	CA1869IR	102211-8431	CA1766IR
101211-0052	JA988IR	101211-5260	JA1534IR	102211-2234	CA1869IR	102211-8440	CA1766IR
101211-0060	JA976IR	101211-5261	JA1534IR	102211-2250	JA1792IR	102211-8450	CA1742IR
101211-0061	JA976IR	101211-5280	JA1281IR	102211-2270	JA1720IR	102211-8460	CA1988IR
101211-0062	JA976IR	101211-5340	JA1280IR	102211-2290	JA1703IR	102211-8470	CA1742IR
101211-0070	JA981IR	101211-5410	JA1278IR	102211-2310	JA1796IR	102211-8471	CA1742IR
101211-0071	JA981IR	101211-5460	JA1418IR	102211-2310	JA1796IR	102211-8471	CA1742IR
101211-0072	JA981IR	101211-5490	JA1408IR	102211-2310	JA1796IR	102211-8480	CA1998IR
101211-0120	JA976IR	101211-5570	CA1822IR	102211-2310	JA1796IR	102211-8480	CA1998IR
101211-0151	JA1129IR	101211-5570	CA1822IR	102211-2430	JA1356IR	102211-8490	JA1605IR
101211-0170	JA981IR	101211-5700	JA1272IR	102211-2600	JA1803IR	102211-8500	JA1894IR
101211-0180	JA976IR	101211-5720	JA1369IR	102211-2760	CA1951IR *	102211-8560	CA2077IR *
101211-0181	JA976IR	101211-5780	JA1410IR	102211-2770	JA1892IR	102211-8570	CA1665IR
101211-0182	JA976IR	101211-5870	JA1163IR	102211-2780	JA1891IR	102211-8571	CA1665IR
101211-0220	JA1273IR	101211-5870	JA1163IR	102211-2780	JA1891IR	102211-8610	CA1855IR
101211-0230	JA1280IR	101211-5970	JA988IR	102211-2810	JA1796IR	102211-8611	CA1855IR
101211-0240	JA980IR	101211-7060	JA1371IR	102211-5001	JA1410IR	102211-8612	CA1855IR
101211-0270	JA1597IR	101211-7160	JA1371IR	102211-5002	JA1410IR	102211-8620	CA1934IR
101211-0340	JA988IR	101211-7370	CA2022IR	102211-5011	JA1612IR	102211-8622	CA1934IR
		101211-7400	JA1797IR	102211-5012	JA1612IR	102211-8630	CA1935IR
		101211-7410	JA1797IR	102211-5020	JA1293IR	102211-8640	CA1884IR
				102211-5021	JA1293IR	102211-8641	CA1884IR

O.E. NO.	HC-PARTS	O.E. NO.	HC-PARTS	O.E. NO.	HC-PARTS	O.E. NO.	HC-PARTS
102211-8642	CA1884IR	104210-5021	CA2016IR	121000-3520	JA1706	128000-1181	JS664
102211-8650	CA1885IR	104210-5140	CA2036IR *	121000-3521	JA1706	128000-1200	JS393
102211-8651	CA1885IR	104210-5150	CA1964IR	121000-3530	UA960	128000-1210	JS393
102211-8652	CA1885IR	104210-5151	CA1964IR	121000-3600	UA960	128000-1220	JS373
102211-8660	CA1890IR	104210-5290	CA2027IR	121000-3602	UA960	128000-1230	JS670
102211-8661	CA1890IR	104210-5350	CA2027IR	121000-3660	JA1706	128000-1240	JS316
102211-8662	CA1890IR	104210-5351	CA2027IR	121000-4000	UA959	128000-1241	JS316
102211-8680	CA2094IR *	104210-5370	CA2078IR *	121000-4010	UA959	128000-1250	JS669
102211-8681	CA2094IR *	104210-5440	CA2069IR *	121000-4030	UA959	128000-1251	JS669
102211-8691	CA2096IR *	104210-5710	CA1834IR	121000-4040	UA961	128000-1300	JS532
102211-8730	CA1978IR	104210-5760	CA1962IR	121000-4050	UA961	128000-1360	CS714
102211-8731	CA1978IR	104210-5770	CA1931IR	121000-4060	UA961	128000-1370	JS644
102211-8740	CA1949IR	104210-5790	CA1864IR	121000-4070	UA961	128000-1440	JS525
102211-8741	CA1949IR	104210-5800	CA1926IR	121000-4080	UA961	128000-1441	JS525
102211-9020	JA1787IR	104210-8020	JA1796IR	121000-4090	UA959	128000-1520	JS385
102211-9070	JA1794IR	104210-8021	JA1796IR	121000-4120	UA961	128000-1540	JS758
102211-9100	JA1794IR	104210-8140	JA1356IR	121000-4122	UA961	128000-1541	JS758
102211-9280	JA1894IR	104210-8160	CA2102IR *	121000-4130	UA961	128000-1570	JS761
102213-2993	JA1808IR	104210-8240	JA1796IR	121000-4150	UA961	128000-1571	JS761
104210-2320	CA2097IR *	104210-8241	JA1796IR	121000-4151	UA961	128000-1574	JS761
104210-2710	CA1834IR	104210-9010	JA1796IR	121000-4160	JA1707	128000-1610	JS317
104210-2730	CA1999IR	104210-9011	JA1796IR	121000-4161	JA1707	128000-1620	JS357
104210-2750	CA1931IR	104210-9230	JA1796IR	121000-4170	UA961	128000-1621	JS357
104210-2780	CA2016IR	104210-9340	JA1796IR	121000-4171	UA961	128000-1630	JS527
104210-3050	JA1721IR	121000-0013	JA143	121000-4300	UA961	128000-1790	JS655
104210-3051	JA1721IR	121000-0041	JA1125	121000-4301	UA961	128000-1861	JS387
104210-3052	JA1721IR	121000-0320	JA170	121000-4320	JA1707	128000-1862	JS387
104210-3060	JA1721IR	121000-0330	JA153 ▲	121000-4330	JA1707	128000-1863	JS387
104210-3170	CA1674IR	121000-0430	JA144	121000-4331	JA1707	128000-1890	JS558
104210-3171	CA1674IR	121000-0431	JA144	121000-5490	JA1362	128000-1900	JS534
104210-3240	CA1674IR	121000-0441	JA144	121000-7030	JA137	128000-1930	JS630
104210-3250	JA1721IR	121000-0451	JA140	121000-7050	JA144	128000-1950	JS630
104210-3251	JA1721IR	121000-0490	JA139	121000-7500	JA144	128000-2040	JS534
104210-3252	JA1721IR	121000-0561	JA114	121000-7560	JA131	128000-2050	JS317
104210-3290	JA1726IR	121000-0580	JA118	121000-8230	JA1270	128000-2060	JS317
104210-3291	JA1726IR	121000-0660	JA800	121020-0013	JA143	128000-2130	JS678
104210-3292	JA1726IR	121000-0670	JA676	128000-0040	JS365	128000-2131	JS678
104210-3293	JA1726IR	121000-0720	JA145	128000-0050	JS908	128000-2190	JS645
104210-3410	CA2069IR *	121000-0820	JA193	128000-0101	JS388	128000-2210	JS386
104210-3411	CA2069IR *	121000-0830	JA193	128000-0102	JS388	128000-2430	JS354
104210-3430	CA1950IR	121000-0840	JA190	128000-0111	JS1239	128000-2431	JS354
104210-3431	CA1950IR	121000-0850	JA190	128000-0120	JS356	128000-2540	JS393
104210-3511	CA1865IR	121000-0890	JA145	128000-0130	JS765	128000-2550	JS558
104210-3512	CA1865IR	121000-0920	JA118	128000-0140	JS896	128000-2551	JS558
104210-3513	CA1865IR	121000-0930	JA193	128000-0141	JS896	128000-2610	JS333
104210-3520	CA1834IR	121000-0950	JA196	128000-0170	JS734	128000-2611	JS333
104210-3521	CA1834IR	121000-1010	JA140	128000-0171	JS734	128000-2640	CS708
104210-3522	CA1834IR	121000-1011	JA140	128000-0220	JS385	128000-2660	CS562
104210-3523	CA1834IR	121000-1012	JA140	128000-0280	JS319	128000-2670	CS592
104210-3530	CA1926IR	121000-1290	JA194IR	128000-0281	JS319	128000-2680	JS760
104210-3531	CA1926IR	121000-1350	JA114	128000-0290	JS311	128000-2682	JS760
104210-3532	CA1926IR	121000-1380	JA157	128000-0300	JS645	128000-2790	CS592
104210-3560	CA1966IR *	121000-1480	JA195	128000-0350	JS558	128000-2800	JS558
104210-3630	CA1941IR	121000-1590	JA118	128000-0351	JS558	128000-2820	JS310
104210-3640	CA1999IR	121000-1720	JA1124	128000-0360	JS642	128000-2830	JS653
104210-3641	CA1999IR	121000-1730	JA118	128000-0370	JS310	128000-2860	JS512
104210-3710	CA1958IR	121000-1750	JA114	128000-0461	JS350	128000-2861	JS512
104210-3711	CA1958IR	121000-1770	JA1125	128000-0462	JS350	128000-2862	JS512
104210-3761	CA1864IR	121000-2030	JA131	128000-0570	JS1013	128000-3080	JS655
104210-3762	CA1864IR	121000-2110	JA131	128000-0590	JS899	128000-3081	JS655
104210-3780	JA1613IR	121000-2970	JA144	128000-0591	JS899	128000-3082	JS655
104210-3821	CA1931IR	121000-3000	UA957	128000-0600	JS512	128000-3090	JS631
104210-3911	CA1980IR *	121000-3100	UA957	128000-0620	JS764	128000-3091	JS631
104210-3980	JA1721IR	121000-3150	UA960	128000-0621	JS764	128000-3190	JS645
104210-3981	JA1721IR	121000-3300	UA957	128000-0622	JS764	128000-3340	JS385
104210-4022	CA1962IR	121000-3310	UA957	128000-0670	JS311	128000-3350	JS527
104210-4101	CA1964IR	121000-3330	UA957	128000-0690	JS557	128000-3380	JS665
104210-4102	CA1964IR	121000-3370	UA960	128000-0700	JS315	128000-3381	JS665
104210-4270	CA1674IR	121000-3380	UA960	128000-0710	JS1239	128000-3470	JS652
104210-4320	CA2016IR	121000-3390	UA960	128000-0720	JS732	128000-3471	JS652
104210-4521	CA1965IR *	121000-3400	UA960	128000-0930	JS377	128000-3472	JS652
104210-4640	CA1966IR *	121000-3410	UA960	128000-0960	JS552	128000-3480	JS632
104210-4660	CA1991IR *	121000-3420	UA960	128000-1040	JS900	128000-3481	JS632
104210-4730	JA1726IR	121000-3430	UA960	128000-1041	JS900	128000-3482	JS632
104210-4731	JA1726IR	121000-3450	UA960	128000-1060	JS735	128000-3500	JS762
104210-4732	JA1726IR	121000-3452	UA960	128000-1070	JS354	128000-3590	JS730
104210-4771	CA2029IR	121000-3460	UA960	128000-1151	JS909	128000-3621	JS901
104210-4860	CA1980IR *	121000-3470	UA960	128000-1152	JS909	128000-3641	JS387
104210-5020	CA2016IR	121000-3510	UA1215	128000-1180	JS664	128000-3662	JS901

O.E. NO.	HC-PARTS	O.E. NO.	HC-PARTS	O.E. NO.	HC-PARTS	O.E. NO.	HC-PARTS
<b>DENSO <i>Continued</i></b>							
128000-3730	CS609	128000-6750	JS1086	128000-9520	JS1082	228000-1530	JS908
128000-3740	CS592	128000-6780	JS916	128000-9540	JS311	228000-1531	JS908
128000-3741	CS592	128000-6810	JS392	128000-9550	JS377	228000-1540	CS592
128000-3810	JS386	128000-6811	JS392	128000-9580	JS392	228000-1550	JS998
128000-4030	JS758	128000-6830	JS392	128000-9581	JS392	228000-1590	JS1090
128000-4031	JS758	128000-6831	JS392	128000-9582	JS392	228000-1600	JS1021
128000-4060	JS630	128000-6832	JS392	128000-9590	JS642	228000-1601	JS1021
128000-4080	JS906	128000-6833	JS392	128000-9591	JS642	228000-1661	JS1090
128000-4201	JS387	128000-6970	JS532	128000-9592	JS642	228000-1710	JS560
128000-4230	CS592	128000-6990	JS533	128000-9710	JS632	228000-1780	JS1154
128000-4270	JS532	128000-7010	JS534	128000-9720	JS632	228000-2120	JS1089
128000-4390	JS641	128000-7030	JS910	128000-9730	JS669	228000-2121	JS1089
128000-4391	JS641	128000-7090	JS385	128000-9740	JS669	228000-2122	JS1089
128000-4420	JS560	128000-7100	JS527	128000-9860	JS902	228000-2123	JS1089
128000-4430	JS557	128000-7140	JS942	128000-9870	JS1085	228000-2124	JS1089
128000-4450	JS557	128000-7190	JS671	128000-9871	JS1085	228000-2220	JS657
128000-4480	JS760	128000-7191	JS671	128000-9872	JS1085	228000-2221	JS657
128000-4530	JS376	128000-7200	JS670	128000-9880	JS902	228000-2260	JS1151
128000-4531	JS376	128000-7280	JS761	128000-9950	JS730	228000-2261	JS1151
128000-4532	JS376	128000-7281	JS761	228000-0110	JS1239	228000-2360	JS1222
128000-4540	CS123	128000-7282	JS761	228000-0111	JS1239	228000-2500	JS913
128000-4570	JS533	128000-7283	JS761	228000-0200	JS774	228000-2570	JS1101
128000-4571	JS533	128000-7350	JS642	228000-0210	JS319	228000-2571	JS1101
128000-4660	JS552	128000-7353	JS642	228000-0211	JS319	228000-2572	JS1101
128000-4661	JS552	128000-7360	JS392	228000-0270	JS761	228000-2573	JS1101
128000-4880	JS557	128000-7361	JS392	228000-0311	JS560	228000-2573	JS1101
128000-4890	CS123	128000-7362	JS392	228000-0340	JS1082	228000-2610	JS1015
128000-4891	CS123	128000-7390	JS632	228000-0400	JS642	228000-2630	CS1065
128000-4900	JS676	128000-7460	JS1150	228000-0420	JS652	228000-2680	JS1089
128000-5080	JS319	128000-7500	JS762	228000-0440	JS527	228000-2682	JS1089
128000-5110	JS645	128000-7560	JS534	228000-0450	JS663	228000-2690	JS1089
128000-5230	JS311	128000-7561	JS534	228000-0460	JS774	228000-2740	JS1099
128000-5261	JS730	128000-7562	JS534	228000-0470	JS942	228000-2750	JS1099
128000-5350	JS774	128000-7600	CS1443	228000-0471	JS942	228000-2851	JS894
128000-5560	JS943	128000-7601	CS1443	228000-0472	JS942	228000-2853	JS894
128000-5561	JS943	128000-7602	CS1443	228000-0473	JS942	228000-2860	JS1134
128000-5581	JS1143	128000-7603	CS1443	228000-0570	JS1090	228000-2890	JS1144
128000-5630	JS534	128000-7604	CS1443	228000-0571	JS1090	228000-2900	JS918
128000-5650	JS376	128000-7680	JS1103	228000-0572	JS1090	228000-2940	JS1018
128000-5680	JS760	128000-7701	JS898	228000-0573	JS1090	228000-2960	JS1018
128000-5681	JS760	128000-7712	JS1022	228000-0574	JS1090	228000-2980	JS663
128000-5682	JS760	128000-7713	JS1022	228000-0575	JS1090	228000-3000	JS774
128000-5691	JS533	128000-7714	JS1022	228000-0640	JS1089	228000-3060	JS1144
128000-5700	JS563	128000-7920	JS392	228000-0662	JS678	228000-3080	JS761
128000-5730	JS930	128000-7921	JS392	228000-0691	JS780	228000-3280	JS1237
128000-5731	JS930	128000-7922	JS392	228000-0790	JS730	228000-3282	JS1237
128000-5732	JS930	128000-7923	JS392	228000-0791	JS730	228000-3283	JS1237
128000-5760	JS1005	128000-7991	JS632	228000-0800	JS730	228000-3330	JS912
128000-5780	JS560	128000-8030	JS762	228000-0820	JS1080	228000-3331	JS912
128000-5781	JS560	128000-8070	JS1019	228000-0821	JS1080	228000-3332	JS912
128000-5840	JS1103	128000-8130	JS933	228000-0822	JS1080	228000-3380	JS325
128000-5850	JS1082	128000-8200	JS894	228000-0823	JS1080	228000-3381	JS325
128000-5941	JS652	128000-8210	JS1084	228000-0830	JS913	228000-3620	CS1500
128000-5942	JS652	128000-8240	JS316	228000-0831	JS913	228000-3621	CS1500
128000-5950	JS632	128000-8241	JS316	228000-0832	JS913	228000-3622	CS1500
128000-5951	JS632	128000-8310	JS671	228000-0880	JS774	228000-3640	JS1088
128000-5952	JS632	128000-8311	JS671	228000-0890	JS560	228000-3641	JS1088
128000-5970	JS1222	128000-8312	JS671	228000-0900	JS1018	228000-3642	JS1088
128000-5971	JS1222	128000-8320	JS757	228000-0901	JS1018	228000-3780	JS1239
128000-5972	JS1222	128000-8321	JS757	228000-0902	JS1018	228000-3800	JS1239
128000-5973	JS1222	128000-8322	JS757	228000-0940	JS918	228000-3801	JS1239
128000-5980	JS557	128000-8323	JS757	228000-0941	JS918	228000-3802	JS1239
128000-6170	JS761	128000-8350	JS560	228000-0950	JS730	228000-3840	JS365
128000-6210	JS512	128000-8360	JS560	228000-0970	JS730	228000-3841	JS365
128000-6211	JS512	128000-8400	JS632	228000-0980	JS730	228000-3842	JS365
128000-6212	JS512	128000-8530	JS357	228000-0981	JS730	228000-3850	JS552
128000-6230	JS657	128000-8531	JS357	228000-0990	JS908	228000-3851	JS552
128000-6240	JS657	128000-8620	JS1021	228000-0991	JS908	228000-3852	JS552
128000-6280	JS896	128000-8621	JS1021	228000-1000	JS897	228000-3980	JS1314
128000-6300	JS657	128000-8650	CS592	228000-1020	JS734	228000-3981	JS1314
128000-6330	JS392	128000-8660	CS562	228000-1021	JS734	228000-4020	JS1023
128000-6340	JS917	128000-8670	CS708	228000-1022	JS734	228000-4210	CS1065
128000-6341	JS917	128000-8690	CS592	228000-1040	JS897	228000-4293	JS552
128000-6420	JS760	128000-8990	CS592	228000-1041	JS897	228000-4310	JS1133
128000-6421	JS760	128000-9220	JS998	228000-1070	JS896	228000-4320	JS1024
128000-6422	JS760	128000-9300	JS1082	228000-1080	JS734	228000-4370	JS669
128000-6640	JS734	128000-9330	JS315	228000-1100	JS1141	228000-4390	JS669
128000-6720	JS371	128000-9380	JS942	228000-1160	JS1019	228000-4391	JS669
128000-6721	JS371	128000-9470	JS1086	228000-1180	JS1314	228000-4392	JS669

O.E. NO.	HC-PARTS	O.E. NO.	HC-PARTS	O.E. NO.	HC-PARTS	O.E. NO.	HC-PARTS
228000-4640	JS512	228000-7671	JS730	428000-3090	CS1476	451058	CA169IR
228000-4641	JS512	228000-7680	CS1503	428000-3110	JS1155	451065	CA149IR
228000-4890	JS1215	228000-7681	CS1503	428000-3180	JS1369	451066	CA150IR
228000-4891	JS1215	228000-7710	JS1320	428000-3370	CS1506	451068	CA175IR
228000-4922	JS734	228000-7791	JS1229	428000-3372	CS1506	451074	CA374IR
228000-4960	JS1149	228000-7800	JS1321	428000-3460	CS1489	451076	CA224IR
228000-4961	JS1149	228000-7801	JS1321	428000-3470	CS1490	451078	CA332IR
228000-4970	JS1157	228000-8150	JS1089	428000-3471	CS1490	512008	CA172IR
228000-4971	JS1157	228000-8350	JS1299	428000-3472	CS1490	512010	CA173IR
228000-4972	JS1157	228000-8360	JS1223	428000-4500	JS1362	513008	CA71
228000-4980	JS1138	228000-8490	JS1215	428000-4550	CS1506	513009	CA164
228000-4981	JS1138	228000-8540	JS1233	428000-4600	CS1410	514005	CA176IR
228000-4982	JS1138	228000-8541	JS1233	428000-4810	JS1368	514006	CA174IR
228000-5020	JS1154	228000-8542	JS1233	428000-4920	JS1369	514007	CA228IR
228000-5021	JS1154	228000-8550	JS1224	428000-5000	CS1458	514010	CA149IR
228000-5022	JS1154	228000-8930	JS1310	428000-5001	CS1458	514011	CA371IR
228000-5023	JS1154	228000-9030	JS1089	428000-7710	JS1362	514013	CA173IR
228000-5300	JS1231	228000-9050	JS1090	428000-7830	CS1499	514014	CA119IR
228000-5301	JS1231	228000-9220	JS1088	428000-9370	JS1233	515010	CA148
228000-5302	JS1231	228000-9221	JS1088	DEUTZ-FAHR		515012	CA166
228000-5303	JS1231	228000-9232	CS1498	01182173	CA1433IR	515014	CA147
228000-5340	JS1155	228000-9270	JS1366	DODGE → CHRYSLER		516002	CA84IR
228000-5341	JS1155	228000-9530	JS1299	DUCELLIER		516003	CA81IR
228000-5342	JS1155	228000-9540	JS1308	6109	CS163	516004	CA356IR
228000-5382	JS552	228000-9580	JS1360	6127	CS109	516006	CA169IR
228000-5480	JS512	228000-9600	JS1302	6128	CS95	516008	CA169IR
228000-5481	JS512	228000-9680	CS1501	6136	CS94	516009	CA332IR
228000-5640	CS1383	228000-9872	CS1456	6155	CS151	516011	CA61IR
228000-5641	CS1383	421000-0021	CA2092	6172	CS95	516012	CA149IR
228000-5650	CS1447	421000-0022	CA2092	6180	CS107	516013	CA175IR
228000-5651	CS1447	421000-0023	CA2092	6185	CS94	516014	CA150IR
228000-5652	CS1447	421000-0024	CA2092	6187	CS95	516015	CA175IR
228000-5910	JS730	421000-0025	CA2092	6189	CS129	516016	CA229IR
228000-5920	JS912	421000-0026	CA2092	6190	CS129	516017	CA165IR
228000-5922	JS912	421000-0027	CA2092	6192	CS163	516020	CA170IR
228000-5980	JS1217	421000-0028	CA2092	6202	CS126	516021	CA374IR
228000-5981	JS1217	421000-0081	CA2021	6207	CS128	516023	CA288IR
228000-6120	JS1350	421000-0082	CA2021	6208	CS127	516024	CA165IR
228000-6121	JS1350	421000-0083	CA2021	6212	CS129	516025	CA170IR
228000-6122	JS1350	421000-0084	CA2021	6216	CS150	516026	CA178IR
228000-6170	JS1218	421000-0085	CA2021	6217	CS127	516027	CA60IR
228000-6172	JS1218	421000-0086	CA2021	6219	CS94	516030	CA332IR
228000-6173	JS1218	428000-0022	CS1499	6220	CS142	516032	CA307IR
228000-6270	JS1302	428000-0023	CS1499	6222	CS131	516035	CA268IR
228000-6271	JS1302	428000-0024	CS1499	6227	CS95	516037	CA512IR
228000-6272	JS1302	428000-0150	CS1476	6231	CS95	516038	CA372IR
228000-6273	JS1302	428000-0151	CS1476	6232	CS109	516040	CA84IR
228000-6280	JS1218	428000-0152	CS1476	6233	CS107	516041	CA356IR
228000-6281	JS1218	428000-0250	CS1484	6236	CS165	516042	CA332IR
228000-6283	JS1218	428000-0260	JS1154	6237	CS154	516044	CA373IR
228000-6430	JS901	428000-0290	JS1155	6238	CS154	516045	CA332IR
228000-6450	CS1455	428000-0500	JS1358	6239	CS165	516047	CA170IR
228000-6530	JS1228	428000-0570	JS1357	6244	CS93	516055	CA87IR
228000-6531	JS1228	428000-0660	CS1473	6245	CS93	516057	CA512IR
228000-6532	JS1228	428000-0670	CS1067	6246	CS131	516058	CA317IR
228000-6612	JS1089	428000-0680	JS1362	6247	CS142	516062	CA375IR
228000-6614	JS1089	428000-0700	JS1363	7527	CA114	516064	CA375IR
228000-6620	JS1220	428000-0701	JS1363	7532	CA112	532000	CS170
228000-6680	JS648	428000-0720	JS1135	7534	CA115	532002	CS95
228000-6730	JS1023	428000-0860	CS1498	7536	CA115	532003	CS169
228000-6750	JS1024	428000-0950	JS1364	7550	CA71	532004	CS169
228000-6840	JS1141	428000-0960	JS1364	7557	CA114	532008	CS170
228000-7130	JS671	428000-1280	JS1358	7575	CA114	532009	CS143
228000-7140	JS757	428000-1370	CS1447	7584	CA344	532010	CS95
228000-7141	JS757	428000-1371	CS1447	7586	CA106	532011	CS168
228000-7150	JS730	428000-1570	JS512	7591	CA164	532012	CS166
228000-7151	JS730	428000-1620	CS1342	7593	CA166	532014	CS142
228000-7160	JS512	428000-1630	JS1368	7595	CA117	532016	CS127
228000-7161	JS512	428000-1640	CS1260	7597	CA71	532017	CS95
228000-7210	JS1297	428000-1650	CS1283	8293	CS326	532018	CS143
228000-7220	CS1242	428000-1750	CS1413	8294	CS326	532020	CS150
228000-7240	CS1483	428000-1760	CS1412	433118	CA351IR	532021	CS94
228000-7241	CS1483	428000-1940	CS1468	451036	CA164	532023	CS94
228000-7242	CS1483	428000-1941	CS1468	451038	CA174IR	532027	CS344
228000-7550	CS1292	428000-2220	CS1502	451057	CA84IR	533000	CS184
228000-7581	JS1230	428000-2631	CS1448			533001	CS168
228000-7591	JS1236	428000-2632	CS1448			533002	CS129
228000-7640	CS1501	428000-2720	JS1357			533003	CS154
228000-7641	CS1501	428000-2730	JS1358			533004	CS154

O.E. NO.	HC-PARTS	O.E. NO.	HC-PARTS	O.E. NO.	HC-PARTS	O.E. NO.	HC-PARTS
<b>DUCELLIER <i>Continued</i></b>							
534002	CS180	EFEL		36576	DC1017	25-008	CS700
534003	CS93	02201	CS120	36676	DC1018	25-0080	CS1201
534004	CS130	03285	CS194			25-0083	CS947
534005	CS130	04667	CS194	ELMOT		25-0085	JS322
534007	CS130	06000	DC1011	3160200	CA822IR	25-0087	JS323
534009	CS165	6000	DC1011	3370000	CA120	25-0097	CS66
534023	CS321	06030	DC1012	274020.0	CA572IR	25-0100	CS148
534027	CS275	6030	DC1012	283020.1	CA254IR	25-0102	CS352
534028	CS275	06770	DC1013	A115-04	CA233IR	25-0104	JS932
534029	CS310	06860	CS564	A115-34B	CA233IR	25-0105	CS94
534031	CS310	07640	CS141	A115-43	CA127IR	25-0106	CS95
534032	CS315	08280	CS99	A115-45D	CA61IR	25-0108	CS170
534036	CS379	08780	CS99	A115-45F	CA61IR	25-0119	JS330
534039	CS326	10420	CS186	A115-45G	CA61IR	25-0121	JS335
534042	CS310	10430	CS103	A124N	CA120	25-0126	CS140
534043	CS310	10440	CS120	A125-45B	CA127IR	25-0127	CS140
534044	CS321	10460	CS120	A125-45C	CA350IR	25-0134	CS62
534045	CS168	10580	CA461R	A125-55E	CA893IR	25-0135	CS117
534046	CS352	10590	CA77IR	A125-55G	CA572IR	25-0137	CS531
534047	CS315	10610	CS195	A125-55T	CA893IR	25-0138	JS362
534048	CS355	10655	CS198	A125-65B	CA254IR	25-0142	CS705
534049	CS168	10890	CA212IR	A12M-42/12	CA741	25-0147	CS168
534050	CS352	10910	CA316IR	B76-0.5/12	CS308	25-0148	CS150
534053	CS371	11206	CS99	E100L-1.5/12	CS139	25-0149	CS151
534054	CS390	11360	CS186	E100N-1.5/12	CS367	25-0153	CS163
534055	CS390	11370	CS240	E80-1/12	CS711	25-0155	CS114
534056	CS393	11420	CS682	R10.08	CS530	25-0157	CS103
534057	CS310	11430	CS394	R100.02	CS367	25-0157	CS114
536001	CS165	11495	CA233IR	R100.03	CS139	25-0160	JS331
538002	CS155	11520	CS97	R11.02	CS799	25-0163	CS128
538005	CS365	11580	CS120	R11.04	CS1033	25-0170	CS131
538006	CS155	11640	CS103	R11B	CS799	25-0171	CS180
538501	CS200	11705	CA129IR	R11G	CS1033	25-0173	JS901
538502	CS201	11750	CS335	R11K	CS103	25-0176	CS165
581207	CA169IR	11830	CS188	R20.24	CS564	25-0177	CS1121
581208	CA303IR	11930	CS240	R20.42	CS198	25-0181	JS302
514011A	CA371IR	12070	CS289	R22.05	CS198	25-0188	CS188
514011B	CA371IR	12080	CS231	R22.07	CS526	25-0189	CS186
514011C	CA371IR	12590	CS544	R22.13	CS1040	25-0198	CS106
514011D	CA371IR	12950	CS506	R23.08	CS191	25-0199	CS115
516012B	CA149IR	12960	CS804	R23.10	CS544	25-0201	CS703
516012C	CA150IR	13000	CS188	R23.18	CS506	25-0203	CS957
516023B	CA288IR	13090	CS120	R76.02	CS692	25-0208	CS503
516053A	CA317IR	13140	CS269	R76A	CS692	25-0212	CS136
6202A	CS126	13460	CA252IR	R80.04	CS371	25-0213	CS185
6202B	CS126	13470	CA1435IR	R80C	CS1038	25-0214	CS155
6202C	CS126	13830	CA355IR	R80C1	CS1038	25-0214	CS382
6202D	CS126	13850	CA506IR	R80K	CS371	25-0220	CS398
6202F	CS126	13870	CA642IR			25-0221	CS140
6217A	CS127	14100	CS114	ELSTOCK		25-0224	CS273
6217B	CS127	14650	CS682	20-2041	CS709	25-0226	CS240
6217C	CS127	14660	CS230	25-0007	JS343	25-0227	CS395
6217D	CS127	14860	CS689	25-0013	CS19	25-0230	JS383
6217E	CS127	14940	CA642IR	25-0015	CS701	25-0232	CS503
6217F	CS127	14960	CA321IR	25-0016	CS694	25-0235	CS347
6217G	CS127	14965	CA345IR	25-0018	CS951	25-0236	JS333
6217H	CS127	14970	CA139IR	25-0019	CS18	25-0240	JS307
6231A	CS95	22201	CS194	25-0023	CS74	25-0241	CS523
6231B	CS95	22602	CS191	25-0025	CS126	25-0242	CS266
6231C	CS95	22604	CS544	25-0028	CS94	25-025	CS126
6231D	CS95	22606	CS506	25-0033	JS301	25-0253	CS382
6237A	CS154	22608	CS502	25-0036	JS300	25-0257	CS993
6237C	CS154	22622	CS506	25-0037	CS103	25-0259	CS138
6237D	CS154	22626	CS194	25-0040	CS109	25-0260	CS166
6237E	CS154	22701	CS198	25-0041	CS201	25-0262	CS1120
6237F	CS154	22703	CS526	25-0043	CS397	25-0265	CS609
6238A	CS154	22704	CS526	25-0046	CS141	25-0266	JS360
6238B	CS154	22714	CS1163	25-0048	CS90	25-0267	JS331
6238C	CS154	22715	CS688	25-0049	CS91	25-0271	CS286
6238D	CS154	22718	CS881	25-0058	CS21	25-0272	CS308
7527A	CA114	36368	DC1004	25-0060	CS200	25-0273	CS147
7527B	CA114	36383	DC1006	25-0064	CS200	25-0274	CS289
7527C	CA114	36384	DC1006	25-007	JS342	25-0275	CS718
7527D,E	CA114	36392	DC1004	25-0070	CS336	25-0276	JS558
7575D	CA114	36503	DC1005	25-0073	CS113	25-0280	CS337
7584A,B,C	CA344	36504	DC1007	25-0074	JS310	25-0282	CS103
7584D	CA166	36506	DC1005	25-0079	CS139	25-0285	JS931
7590C	CA84	36507	DC1007			25-0287	CS335
7590D	CA84	36549	DC1009			25-0288	CS316



O.E. NO.	HC-PARTS	O.E. NO.	HC-PARTS	O.E. NO.	HC-PARTS	O.E. NO.	HC-PARTS
25-0294	CS605	25-0466	JS344	25-1073	CS109	25-1202	JS734
25-0298	JS349	25-0466	JS769	25-1074	JS517	25-1204	JS650
25-0298	JS350	25-0467	JS752	25-1074	JS660	25-1205	JS319
25-0298	JS396	25-0468	CS306	25-1075	JS568	25-1205	JS645
25-0299	CS169	25-0471	JS382	25-1076	CS275	25-1206	JS631
25-0300	CS154	25-0471	JS391	25-1077	CS370	25-1207	JS638
25-0301	CS129	25-0472	CS682	25-1080	CS376	25-1208	JS669
25-0302	CS365	25-0474	CS603	25-1081	JS1145	25-1209	JS668
25-0303	CS143	25-0475	JS386	25-1082	CS297	25-1213	CS78
25-0307	JS388	25-0476	JS679	25-1083	JS734	25-1214	CS123
25-0308	CS156	25-0477	CS505	25-1084	JS675	25-1214	CS592
25-0314	CS162	25-0480	JS329	25-1085	JS895	25-1215	JS513
25-0315	CS604	25-0482	CS331	25-1086	CS783	25-1216	CS504
25-0319	CS95	25-0483	JS340	25-1087	JS673	25-1217	JS371
25-0321	JS392	25-0484	CS339	25-1089	CS1110	25-1220	CS518
25-0322	CS184	25-0486	JS676	25-1089	CS328	25-1222	JS633
25-0323	CS355	25-0489	CS350	25-1090	CS346	25-1222	JS663
25-0328	JS640	25-0492	JS522	25-1093	JS771	25-1223	US835
25-0334	CS693	25-0493	CS529	25-1096	JS353	25-1224	JS1014
25-0337	CS1173	25-0495	JS339	25-1097	JS678	25-1225	CS807
25-0338	CS363	25-0495	JS381	25-1099	JS394	25-1230	JS1092
25-0339	CS704	25-0497	JS365	25-1100	JS538	25-1231	JS665
25-0340	CS230	25-0498	JS389	25-1102	JS549	25-1232	JS319
25-0343	CS200	25-0499	JS355	25-1103	JS362	25-1232	JS645
25-0346	JS338	25-085	JS322	25-1106	JS552	25-1236	CS359
25-0353	CS130	25-087	JS323	25-1107	JS362	25-1239	JS648
25-0353	CS93	25-1003	CS1032	25-1114	JS1000	25-1241	JS654
25-0355	CS107	25-1006	CS371	25-1114	JS640	25-1242	CS1031
25-0356	CS959	25-1008	CS322	25-1115	JS302	25-1243	JS393
25-0358	CS131	25-1011	CS345	25-1117	JS319	25-1246	JS627
25-0362	CS607	25-1012	CS333	25-1117	JS645	25-1247	CS574
25-0370	CS162	25-1013	CS295	25-1118	CS503	25-1250	JS776
25-0371	CS18	25-1014	JS629	25-1120	CS334	25-1252	CS360
25-0373	CS1123	25-1015	CS344	25-1121	CS570	25-1253	JS316
25-0376	CS326	25-1016	JS317	25-1127	JS372	25-1254	CS390
25-0379	JS315	25-1017	JS358	25-1128	JS558	25-1254	CS581
25-0383	CS314	25-1017	JS662	25-1129	CS353	25-1255	CS715
25-0385	CS683	25-1018	CS381	25-1130	JS309	25-1256	CS541
25-0390	CS266	25-1019	CS366	25-1131	JS778	25-1258	JS557
25-0394	JS646	25-1019	CS580	25-1137	CS315	25-1261	JS380
25-0395	JS325	25-1022	CS948	25-1139	JS318	25-1262	JS661
25-0396	CS268	25-1023	CS378	25-1141	JS520	25-1263	CS368
25-0401	JS303	25-1025	JS521	25-1142	JS356	25-1264	CS576
25-0402	JS305	25-1026	CS341	25-1142	JS765	25-1265	JS628
25-0403	JS304	25-1028	CS390	25-1143	JS626	25-1268	CS795
25-0404	JS379	25-1028	CS581	25-1145	JS644	25-1269	CS329
25-0406	CS290	25-1029	CS623	25-1146	JS364	25-1275	JS632
25-0407	CS373	25-1030	CS994	25-1147	CS510	25-1276	JS651
25-0408	CS386	25-1033	CS348	25-1148	CS566	25-1278	CS1183
25-0409	CS327	25-1034	JS779	25-1149	JS373	25-1278	CS162
25-0411	CS338	25-1036	CS267	25-1150	JS731	25-1281	CS681
25-0413	CS550	25-1037	CS393	25-1155	CS535	25-1282	CS878
25-0416	JS670	25-1039	CS386	25-1157	JS674	25-1283	JS658
25-0418	JS663	25-1040	JS376	25-1158	JS637	25-1289	CS562
25-0423	JS731	25-1041	CS354	25-1159	JS635	25-1292	CS555
25-0425	CS272	25-1042	CS364	25-1160	JS636	25-1293	JS903
25-0427	CS185	25-1044	JS357	25-1164	JS730	25-1295	CS725
25-0428	CS299	25-1045	JS385	25-1165	JS660	25-1296	JS935
25-0429	CS369	25-1046	CS332	25-1166	JS560	25-1301	CS131
25-0430	CS944	25-1047	JS397	25-1167	JS772	25-1303	CS584
25-0431	CS321	25-1049	JS383	25-1169	CS702	25-1304	CS717
25-0432	CS706	25-1050	JS552	25-1171	CS330	25-1305	CS514
25-0434	JS344	25-1051	CS804	25-1172	CS721	25-1306	CS1046
25-0436	JS344	25-1052	JS512	25-1173	US833	25-1307	CS613
25-0439	JS342	25-1053	CS374	25-1177	JS306	25-1308	JS639
25-0443	JS363	25-1054	JS354	25-1178	CS550	25-1310	CS528
25-0446	JS365	25-1055	US838	25-1180	JS732	25-1311	CS598
25-0447	JS358	25-1056	US839	25-1182	CS500	25-1312	CS597
25-0448	CS548	25-1057	CS396	25-1184	CS536	25-1314	JS747
25-0449	JS312	25-1058	CS356	25-1188	CS531	25-1315	JS628
25-0450	JS306	25-1061	JS729	25-1191	CS561	25-1317	JS894
25-0453	CS310	25-1062	JS1239	25-1192	CS554	25-1318	JS1019
25-0455	CS263	25-1063	JS378	25-1193	JS632	25-1319	CS569
25-0456	CS340	25-1064	JS318	25-1194	CS343	25-1322	CS535
25-0457	CS298	25-1065	CS361	25-1195	CS351	25-1324	CS619
25-0458	JS359	25-1066	JS308	25-1197	JS634	25-1326	JS373
25-0459	JS677	25-1067	JS307	25-1198	CS566	25-1327	CS577
25-0462	CS783	25-1069	CS716	25-1199	CS551	25-1329	CS542
25-0465	CS572	25-1072	JS378	25-1201	JS330	25-1331	JS756

O.E. NO.	HC-PARTS	O.E. NO.	HC-PARTS	O.E. NO.	HC-PARTS	O.E. NO.	HC-PARTS
<b>ELSTOCK <i>Continued</i></b>							
25-1332	CS507	25-1496	JS895	25-2102	CS372	25-2244	JS1017
25-1334	CS592	25-1497	JS525	25-2106	CS988	25-2245	CS616
25-1335	JS759	25-1499	US877	25-2107	JS942	25-2246	CS984
25-1337	CS712	25-1522	JA1161R	25-2108	CS715	25-2247	JS1016
25-1338	CS991	25-155	CS103	25-2110	CS887	25-2249	CS622
25-1339	CS713	25-1558	CA320IR	25-2111	CS976	25-2250	JS1085
25-1340	JS667	25-1629	CA564IR	25-2112	CS1044	25-2251	CS787
25-1341	JS1095	25-181	JS302	25-2118	JS1149	25-2252	JS774
25-1342	JS734	25-2001	US832	25-2120	CS1042	25-2253	CS559
25-1343	JS769	25-2002	JS919	25-2122	JS1221	25-2254	CS792
25-1344	JS563	25-2003	CS963	25-2125	US1240	25-2255	US844
25-1345	JS520	25-2004	JS933	25-2127	JS734	25-2256	CS1063
25-1346	JS653	25-2005	JS770	25-2128	CS519	25-2257	CS1038
25-1347	JS534	25-2009	JS1000	25-2131	CS610	25-2258	JS760
25-1348	JS558	25-2009	JS640	25-2135	CS1076	25-2259	CS711
25-1349	JS891	25-2010	CS719	25-2136	JS1366	25-2260	CS782
25-1355	CS618	25-2011	CS973	25-2137	JS560	25-2262	CS964
25-1355	CS713	25-2012	CS790	25-2138	CS576	25-2263	CS990
25-1356	JS1018	25-2015	CS724	25-2139	CS794	25-2264	CS879
25-1356	JS1105	25-2016	CS687	25-2147	JS632	25-2265	CS1074
25-1357	CS328	25-2017	CS1177	25-2148	CS1053	25-2266	JS1314
25-1360	CS500	25-2018	JS893	25-2149	JS670	25-2267	JS1089
25-1361	CS599	25-2019	CS583	25-2150	JS1153	25-2269	JS940
25-1363	CS600	25-2021	CS974	25-2151	CS884	25-2270	CS1165
25-1364	CS685	25-2022	CS621	25-2153	JS1159	25-2271	JS527
25-1365	CS624	25-2023	CS375	25-2154	JS907	25-2275	CS1072
25-1369	JS1005	25-2025	JS1102	25-2155	CS1170	25-2281	JS765
25-1371	US843	25-2026	CS886	25-2157	CS554	25-2287	CS588
25-1373	JS754	25-2027	JS652	25-2158	CS1042	25-2288	US970
25-1376	JS1146	25-2028	JS762	25-2159	JS643	25-2289	JS1011
25-1377	CS620	25-2029	CS585	25-2165	CS615	25-2290	JS918
25-1380	JS1103	25-2031	CS1177	25-2166	CS1037	25-2291	US809
25-1390	JS745	25-2032	CS611	25-2167	CS801	25-2293	US822
25-1396	JS1151	25-2034	JS942	25-2168	JS664	25-2294	JS902
25-1396	JS648	25-2036	JS762	25-2169	JS1020	25-2294	US809
25-1397	JS763	25-2037	CS680	25-2172	JS781	25-2295	CS543
25-1398	JS671	25-2039	CS567	25-2174	CS1051	25-2305	CS961
25-1399	JS315	25-2040	CS1069	25-2177	CS980	25-2306	US859
25-1400	CS693	25-2041	CS376	25-2180	JS1156	25-2307	CS286
25-1402	JS936	25-2041	CS709	25-2181	CS709	25-2316	CS1071
25-1405	JS627	25-2042	JS1006	25-2182	JS902	25-2324	CS326
25-1406	JS916	25-2045	CS684	25-2183	US828	25-2328	CS888
25-1407	JS757	25-2046	CS1073	25-2185	CS1118	25-2329	JS652
25-1410	CS201	25-2048	CS960	25-2186	CS1065	25-2331	CS1132
25-1416	CS1032	25-2049	CS880	25-2187	CS977	25-2336	CS1210
25-1417	JS943	25-2050	CS1050	25-2190	JS1091	25-2337	CS1191
25-1420	CS1035	25-2051	CS975	25-2191	CS1057	25-2339	CS1044
25-1425	JS753	25-2052	CS784	25-2193	JS1136	25-2343	JS669
25-1427	JS670	25-2055	JS651	25-2194	JS730	25-2347	CS1340
25-1432	JS642	25-2056	JS1096	25-2195	CS1060	25-2348	CS1182
25-1434	CS612	25-2057	JS1000	25-2202	JS1103	25-2349	JS1351
25-1436	JS1012	25-2057	JS325	25-2203	CS524	25-235	CS188
25-1437	CS723	25-2057	JS640	25-2204	CS1047	25-2350	JS309
25-1439	CS278	25-2058	CS562	25-2205	CS1048	25-2354	CS1117
25-1441	CS358	25-2062	CS972	25-2206	CS1052	25-2355	CS978
25-1447	CS709	25-2064	JS939	25-2209	CS882	25-2356	JS1152
25-1448	CS798	25-2065	JS305	25-2210	CS883	25-2357	CS515
25-1450	US815	25-2066	JS1094	25-2211	JS1140	25-2358	CS1172
25-1451	JS556	25-2067	CS889	25-2215	CS181	25-2363	CS1114
25-1454	JS911	25-2068	JS890	25-2216	JS1104	25-2364	JS905
25-1456	JS649	25-2069	JS924	25-2218	JS1023	25-2370	CS1160
25-1458	JS672	25-2070	JS759	25-2220	CS986	25-2372	JS1147
25-1460	JS1100	25-2071	JS512	25-2221	CS791	25-2374	CS1064
25-1460	JS766	25-2072	CS1162	25-2222	CS727	25-2376	CS1181
25-1464	JS537	25-2073	JS1081	25-2223	JS1003	25-2380	JS1220
25-1467	JS773	25-2079	CS879	25-2224	JS1142	25-2381	JS1299
25-1469	JS358	25-2080	CS885	25-2225	CS1062	25-2383	JS917
25-1472	CS689	25-2081	CS981	25-2226	CS1205	25-2384	JS1303
25-1478	JS999	25-2082	JS1079	25-2227	CS992	25-2385	JS1297
25-1479	CS727	25-2084	CS971	25-2228	CS1033	25-2387	CS1174
25-1480	CS796	25-2088	JS1080	25-2229	CS1055	25-2393	CS1455
25-1482	US860	25-2089	JS897	25-2230	CS372	25-2394	JS1139
25-1484	JS627	25-2091	JS728	25-2231	CS789	25-2396	CS1266
25-1486	JS657	25-2092	JS377	25-2232	CS1109	25-2400	CS1390
25-1487	CS335	25-2094	JS737	25-2233	JS1097	25-2402	CS994
25-1489	CS1184	25-2096	JS1135	25-2234	JS1024	25-2404	JS1236
25-1491	JS1083	25-2097	JS941	25-2235	JS925	25-2409	JS927
25-1492	JS1086	25-2098	CS1075	25-2239	JS1101	25-2411	CS1203
25-1493	JS937	25-2101	CS788	25-2243	CS1119	25-2412	JS1313

O.E. NO.	HC-PARTS	O.E. NO.	HC-PARTS	O.E. NO.	HC-PARTS	O.E. NO.	HC-PARTS
25-2413	JS1015	25-3076	JS1235	25-3247	CS1254	25-3424	CS1460
25-2414	CS1078	25-3077	CS1241	25-3248	CS1247	25-3427	JS1309
25-2415	JS641	25-3081	CS327	25-3250	CS1289	25-3428	CS1426
25-2417	CS1171	25-3082	CS1192	25-3251	CS1283	25-3432	JS1363
25-2419	CS796	25-3083	CS581	25-3256	CS1405	25-3434	CS1377
25-2422	JS1233	25-3084	CS1177	25-3258	CS1257	25-3435	CS1456
25-2424	JS357	25-3085	CS1471	25-3263	CS1189	25-3436	JS1369
25-2427	CS395	25-3086	CS885	25-3264	CS1395	25-3438	JS1361
25-2429	CS1066	25-3087	CS1183	25-3267	JS1355	25-3440	CS1387
25-2430	JS1150	25-3088	CS1213	25-3268	JS1317	25-3446	CS1391
25-2431	CS511	25-3094	JS1224	25-3269	JS1296	25-3450	CS1417
25-2435	CS511	25-3096	CS1192	25-3270	CS1439	25-3451	CS1481
25-2436	JS1138	25-3098	CS1131	25-3271	CS1444	25-3452	CS1457
25-2439	JS1238	25-3100	CS1207	25-3273	CS1275	25-3454	CS1264
25-2440	CS694	25-3102	CS1075	25-3279	JS640	25-3457	CS1493
25-2442	JS1223	25-3104	CS1191	25-3280	CS1445	25-3458	CS1448
25-2446	JS1158	25-3105	JS1088	25-3283	CS1379	25-3460	CS1403
25-2447	JS1155	25-3106	CS1198	25-3286	CS1344	25-3463	CS1336
25-2450	CS1202	25-3107	CS1273	25-3289	CS1263	25-3465	CS1476
25-2451	CS1176	25-3109	CS1195	25-3294	CS1324	25-3466	CS1407
25-2456	JS380	25-3112	US877	25-3296	CS1329	25-3472	CS380
25-2460	CS987	25-3113	CS784	25-3297	CS1288	25-3475	JS1355
25-2462	CS1210	25-3115	CS684	25-3298	JS1316	25-3476	CS1415
25-2463	CS1245	25-3118	CS1211	25-3299	JS1315	25-3477	CS1433
25-2466	CS1246	25-3120	JS1216	25-3303	CS788	25-3479	CS1424
25-2467	CS575	25-3121	CS1440	25-3305	CS1436	25-3481	JS1365
25-2471	CS1188	25-3123	CS1130	25-3306	CS692	25-3482	CS1442
25-2472	JS1236	25-3125	CS1208	25-3309	CS1492	25-3483	CS1338
25-2473	CS1106	25-3126	CS882	25-3310	CS719	25-3484	JS1365
25-2474	CS1200	25-3127	JS643	25-3312	CS708	25-3486	CS1431
25-2477	JS1135	25-3129	CS1337	25-3321	JS1306	25-3489	CS1438
25-2480	JS1157	25-3135	CS680	25-3325	JS1353	25-3490	CS1449
25-2481	JS1350	25-3137	JS1093	25-3329	CS1172	25-3495	CS1402
25-2484	CS1272	25-3146	JS1310	25-3330	CS1332	25-3497	CS1419
25-2485	CS1197	25-3149	CS1196	25-3336	JS1352	25-3499	CS1435
25-2486	CS1113	25-3150	JS1298	25-3338	JS1357	25-3606	UA969
25-2487	CS1194	25-3152	CS1244	25-3339	JS1098	25-3650	JA1422IR
25-2489	CS1242	25-3153	JS1239	25-3342	CS1334	25-3885	CA2047IR
25-2490	CS594	25-3155	CS1336	25-3345	CS1377	25-394	JS646
25-2491	CS1396	25-3157	JS730	25-3347	CS1428	25-4000	JS737
25-2492	CS1115	25-3159	JS1230	25-3348	CS1347	25-4003	CS1398
25-2496	JS915	25-3161	CS1179	25-3354	JS1364	25-4005	CS1453
25-2499	CS1210	25-3163	US842	25-3356	JS1359	25-4007	CS1423
25-2504	JS1236	25-3164	JS1305	25-3357	CS606	25-4008	CS1488
25-2550	JS1085	25-3168	CS1271	25-3358	JS1349	25-4010	CS1342
25-3002	CS1045	25-3169	CS1250	25-3359	CS1446	25-4011	CS1454
25-3004	CS1190	25-3172	CS1252	25-3361	CS1054	25-4012	CS1395
25-3005	CS1500	25-3173	CS1477	25-3362	CS1068	25-4014	JS1368
25-3009	CS1111	25-3174	JS1225	25-3364	JS1358	25-4017	CS1505
25-3010	CS1207	25-3175	CS1212	25-3365	CS1411	25-4021	CS1271
25-3011	CS610	25-3178	JS647	25-3367	CS1392	25-4024	CS1401
25-3014	CS1498	25-3180	CS1258	25-3368	CS1394	25-4025	CS1425
25-3024	CS1187	25-3181	CS1326	25-3369	CS1393	25-4028	CS1482
25-3025	JS350	25-3182	CS1253	25-3371	JS1311	25-4037	CS322
25-3028	JS1320	25-3183	CS1204	25-3378	JS314	25-4042	CS1414
25-3030	CS1180	25-319	CS95	25-3379	CS1339	25-4049	CS1410
25-3031	CS879	25-3191	JS1305	25-3383	CS1454	25-4054	CS1487
25-3033	US1240	25-3192	JS999	25-3384	CS879	25-4055	JS1360
25-3034	CS1255	25-3197	JS913	25-3386	JS659	25-4059	CS1430
25-3036	JS896	25-3200	JS1304	25-3387	JS1319	25-4062	CS1450
25-3038	CS1055	25-3203	JS1300	25-3388	JS1155	25-4065	US1028
25-3039	JS1214	25-3205	JS1218	25-3389	JS1009	25-4071	JS1362
25-3040	CS793	25-3206	JS1302	25-339	CS240	25-4076	CS1509
25-3042	CS1186	25-3212	CS1264	25-3390	CS1341	25-4077	JS1231
25-3045	JS1321	25-3213	JS1295	25-3391	CS1409	25-4082	CS1329
25-3046	CS1249	25-3216	CS1343	25-3395	CS1389	25-410	CS367
25-3047	JS1008	25-3217	CS1322	25-3396	CS1406	25-4112	CS1478
25-3048	CS1290	25-3218	CS1286	25-3397	JS1367	25-4142	CS1504
25-3049	JS1016	25-3219	CS1293	25-3398	JS1318	25-4148	CS1480
25-3050	CS1125	25-3220	CS1323	25-3399	CS1416	25-472	CS682
25-3054	CS784	25-3221	CS1330	25-3401	CS331	25-5740	CA2058IR *
25-3055	CS796	25-3222	CS1294	25-3402	CS1427	25-6535	CA2094IR *
25-3061	JS1226	25-3223	CS1287	25-3404	JS1144	26-0011	CS83
25-3063	CS1209	25-3232	CS1291	25-3414	CS1421	26-0012	CS77
25-3065	CS1174	25-3233	JS349	25-3415	CS1384	26-0024	CS76
25-3068	JS1234	25-3237	JS1237	25-3417	CS1422	26-0054	CS78
25-3069	JS1356	25-3241	JS914	25-3420	CS1408	26-0055	CS86
25-3070	CS1260	25-3242	CS1175	25-3421	CS696	26-0068	CS69
25-3073	CS1193	25-3244	JS1227	25-3423	CS1346	26-0069	CS72

O.E. NO.	HC-PARTS	O.E. NO.	HC-PARTS	O.E. NO.	HC-PARTS	O.E. NO.	HC-PARTS
<b>ELSTOCK <i>Continued</i></b>							
26-0074	JS310	26-1313	CS559	27-0615	CA154	27-3820	JA1610
26-0077	JS315	26-1315	JS628	27-0616	CA93	27-3829	JA1283
26-0086	CS66	26-1319	CS569	27-0633	CA76	27-3830	JA1362
26-0088	CS66	26-1323	CS601	27-0654	CA117	27-3849	UA961
26-0099	CS70	26-1325	CS602	27-0655	CA283	27-3893	UA1214
26-0099	CS87	26-1352	CS282	27-0668	CA147	27-3895	JA1707
26-0101	CS80	26-1359	CS614	27-0671	CA88	27-3945	UA1215
26-0118	CS93	26-1362	CS300	27-0672	CA88	27-3963	CA1635IR
26-0152	CS79	26-1379	CS1166	27-0679	CA55	27-4696	CA1638IR
26-0164	CS116	26-1424	CS972	27-0682	JA172	27-4698	CA1638IR
26-0171	CS180	26-1434	CS612	27-0684	JA111	27-4798	JA1705
26-0205	CS385	26-1434	CS79	27-0690	JA131	27-4806	JA1598
26-0207	CS81	26-1438	CS547	27-0699	CA1911R	27-4813	CA1780IR
26-0215	CS140	26-1446	CS389	27-0708	CA1751R	27-4829	CA1778IR
26-0216	CS122	26-1453	CS508	27-0711	CA106	27-4830	CA1857IR
26-0217	CS123	26-1475	CS578	27-0713	CA38	27-4838	CA1777IR
26-0225	CS133	26-1494	JS758	27-0715	CA2331R	27-4847	CA1737IR
26-0229	JS336	26-2074	CS958	27-0723	CA961R	27-4850	CA2034IR
26-0236	JS333	26-2104	CS1041	27-0724	CA941R	27-4887	CA2092
26-0238	JS335	26-2133	US810	27-0730	CA7341R	27-4932	CA1865IR
26-0239	CS135	26-2145	CS965	27-0735	JA120	27-4933	CA1834IR
26-0244	CS132	26-2238	CS1067	27-0739	CA183	27-4948	CA2021
26-0284	CS591	26-2277	US830	27-0750	CA148	27-4956	CA1864IR
26-0304	CS280	26-2301	US818	27-0761	CA138	27-4968	CA1857IR
26-0306	CS587	26-2302	US810	27-0762	CA106	27-4991	JA1898
26-0308	CS156	26-2366	US969	27-0764	JA138	27-5525	CA1999IR
26-0310	JS372	26-2391	CS1258	27-0765	JA131	27-5526	CA1941IR
26-0311	CS622	26-3000	CS1265	27-0768	CA273	27-5527	CA1989IR
26-0314	CS162	26-3033	US1240	27-0769	CA104	27-5529	JA1902
26-0325	CS324	26-3040	CS793	27-0775	UA918	27-5533	JA1799
26-0360	JS327	26-3056	CS985	27-0782	CA148	27-5540	JA1409
26-0361	CS183	26-3135	CS1270	27-0798	JA686	27-5559	CA1972
26-0376	CS326	26-3147	CS1256	27-0821	JA139	27-5586	CA2014
26-0377	JS333	26-3167	US1240	27-0822	JA143	27-562	JA121
26-0378	CS81	26-3189	CS1270	27-0823	JA149	27-5625	CA1925IR
26-0384	CS324	26-3201	CS1328	27-0832	UA916	27-563	JA120
26-0386	CS268	26-3326	CS1473	27-0837	JA140	27-5651	CA2034IR
26-0392	CS119	26-3341	JS1098	27-0841	JA686	27-5658	CA1926IR
26-0393	CS285	26-3376	CS1067	27-0842	JA193	27-5681	CA1931IR
26-0394	JS646	26-360	JS327	27-0883	JA190	27-5734	JA1791
26-0395	JS325	26-395	JS640	27-0900	JA102	27-595	JA130
26-0397	CS311	26-415	CA17H	27-0919	JA195	27-596	JA130
26-0424	CS293	26-437	JS395	27-0926	UA917	27-600	CA101
26-0426	CS79	27-0501	JA119	27-0966	JA134	27-631	CS123
26-0435	CS292	27-0510	CA50	27-0970	JA144	27-655	CA283
26-0437	JS395	27-0513	CA112	27-0993	JA196	27-679	CA55
26-0455	CS263	27-0521	JA100	27-1512	JA681	27-769	CA104
26-0464	JS370	27-0522	JA101	27-1518	JA153	27-816	CA104
26-0474	CS603	27-0522	JA103	27-1519	CA147	28-0080	CS997
26-1000	CS311	27-0530	JA786	27-1523	JA170	28-0285	JS931
26-1001	CS276	27-0535	CA120	27-1538	JA155	28-0500	CA351R
26-1009	CS89	27-0536	CA461R	27-1552	CA292	28-0502	CA521R
26-1015	CS344	27-0537	CA45	27-1556	JA168	28-0505	CA17V
26-1016	JS317	27-0550	JA110	27-1556	JA168	28-0506	CA1411R
26-1020	CS323	27-0553	CA1901R	27-1618	JA872	28-0509	CA17H
26-1035	CS294	27-0554	CA2591R	27-1673	JA149	28-0510	CA1211R
26-1036	CS267	27-0559	JA157	27-1797	JA157	28-0511	CA5061R
26-1078	CS268	27-0560	CA131	27-1802	JA777	28-0512	CA3281R
26-1090	CS346	27-0562	JA121	27-1886	JA130	28-0513	CA1721R
26-1105	CS508	27-0563	JA120	27-1898	JA656	28-0514	CA1741R
26-1116	JS394	27-0565	CA37	27-1941	JA193	28-0516	CA2371R
26-1125	JS387	27-0565	CA62	27-1963	JA784	28-0519	CA6441R
26-1126	JS630	27-0566	CA62	27-1989	JA687	28-0522	JA1041R
26-1134	CS294	27-0567	CA118	27-2526	CA709	28-0523	CA7271R
26-1144	CS720	27-0567	CA118	27-2569	UA960	28-0527	CA23V
26-1161	CS528	27-0573	CA38	27-2571	UA957	28-0533	CA1201IR
26-1168	CS509	27-0577	CA42	27-2573	UA961	28-0534	CA1192IR
26-1175	CS377	27-0579	CA38	27-2576	UA959	28-0536	CA461R
26-1210	CS300	27-0580	CA148	27-2816	JA1409	28-0537	CA771R
26-1212	CS392	27-0585	CA71	27-2826	JA1529	28-0538	CA1191R
26-1238	CS357	27-0586	CA106	27-2853	JA1283	28-0543	CA17H
26-1238	CS685	27-0588	CA38	27-2974	JA144	28-0544	CA17V
26-1259	CS116	27-0594	CA84	27-3515	CA13401R	28-0548	CA2901R
26-1260	CS116	27-0595	JA130	27-3582	UA1212	28-0560	CA1311R
26-1280	CS515	27-0596	JA131	27-3603	UA960	28-0561	CA3391R
26-1282	CS878	27-0596	JA137	27-3609	UA951	28-0563	JA8841R
26-1285	CS181	27-0600	CA30	27-3641	JA656	28-0573	CA481R
26-1290	CS516	27-0601	CA100	27-3716	UA960	28-0574	CA18H
26-1305	CS514	27-0602	CA30	27-3787	CA14751R	28-0576	JA1051R
			CA89	27-3789	CA14831R		

O.E. NO.	HC-PARTS	O.E. NO.	HC-PARTS	O.E. NO.	HC-PARTS	O.E. NO.	HC-PARTS
28-0577	CA42IR	28-0763	JA165IR	28-0897	CA271IR	28-1507	CA525IR
28-0578	CA99IR	28-0768	CA238IR	28-0898	CA591IR	28-1508	JA575IR
28-0580	CA150IR	28-0772	CA366IR	28-0902	CA268IR	28-1510	CA316IR
28-0582	CA190IR	28-0773	CA316IR	28-0904	JA113IR	28-1511	JA173IR
28-0583	CA169IR	28-0777	JA770IR	28-0905	CA359IR	28-1513	CA126IR
28-0584	CA367IR	28-0790	CA199IR	28-0906	CA175IR	28-1514	CA616IR
28-0585	CA165IR	28-0794	CA293IR	28-0910	CA1192IR	28-1516	CA324IR
28-0594	CA84IR	28-0794	CA306IR	28-0912	JA151IR	28-1517	CA538IR
28-0596	JA152IR	28-0795	CA126IR	28-0913	CA362IR	28-1520	JA178IR
28-0598	CA22H	28-0797	CA128IR	28-0914	CA533IR	28-1521	JA775IR
28-0603	CA631IR	28-0798	JA565IR	28-0915	CA363IR	28-1522	JA116IR
28-0606	CA312IR	28-0799	CA264IR	28-0916	CA356IR	28-1524	JA553IR
28-0607	CA613IR	28-0800	JA142IR	28-0917	JA986IR	28-1527	JA862IR
28-0608	CA94IR	28-0801	CA291IR	28-0918	JA585IR	28-1529	JA171IR
28-0616	CA93IR	28-0802	CA294IR	28-0921	JA107IR	28-1530	JA164IR
28-0619	CA85IR	28-0804	CA351IR	28-0922	CA1029IR	28-1531	JA559IR
28-0627	CA176IR	28-0805	CA1387IR	28-0922	CA611IR	28-1532	JA198IR
28-0628	JA179IR	28-0805	CA704IR	28-0925	CA529IR	28-1533	JA555IR
28-0633	CA76IR	28-0807	JA105IR	28-0927	CA502IR	28-1534	JA158IR
28-0635	CA22H	28-0809	CA226IR	28-0928	CA626IR	28-1535	JA551IR
28-0637	CA15H	28-0809	CA305IR	28-0929	CA322IR	28-1536	JA802IR
28-0642	CA296IR	28-0813	CA371IR	28-0931	JA577IR	28-1537	JA692IR
28-0647	CA619IR	28-0815	CA314IR	28-0932	CA1072IR	28-1539	JA174IR
28-0650	CA18H	28-0817	CA235IR	28-0932	CA321IR	28-1540	JA554IR
28-0651	CA18V	28-0818	CA272IR	28-0933	CA522IR	28-1541	CA229IR
28-0654	CA235IR	28-0819	CA308IR	28-0934	JA141IR	28-1542	CA1387IR
28-0655	CA300IR	28-0820	CA315IR	28-0935	CA376IR	28-1543	JA766IR
28-0656	CA894IR	28-0825	UA943IR	28-0936	CA276IR	28-1544	JA576IR
28-0657	JA116IR	28-0826	JA697IR	28-0937	CA588IR	28-1546	CA549IR
28-0663	JA127IR	28-0827	JA183IR	28-0942	CA241IR	28-1547	CA524IR
28-0672	CA88	28-0827	JA779IR	28-0943	CA242IR	28-1551	CA338IR
28-0672	CA88IR	28-0828	CA592IR	28-0944	CA298IR	28-1553	UA943IR
28-0675	CA87IR	28-0830	JA180IR	28-0945	CA337IR	28-1555	JA184IR
28-0679	CA198IR	28-0831	JA661IR	28-0946	CA140IR	28-1557	JA174IR
28-0680	JA116IR	28-0833	JA179IR	28-0948	CA505IR	28-1558	CA320IR
28-0682	JA150IR	28-0834	JA146IR	28-0949	CA357IR	28-1560	JA188IR
28-0685	CA511IR	28-0834	JA159IR	28-0950	CA364IR	28-1561	JA552IR
28-0693	CA170IR	28-0835	CA42IR	28-0951	CA277IR	28-1562	CA272IR
28-0694	CA178IR	28-0836	JA148IR	28-0952	CA297IR	28-1563	CA163IR
28-0696	JA197IR	28-0838	JA128IR	28-0954	CA302IR	28-1563	CA244IR
28-0699	CA191IR	28-0839	JA181IR	28-0955	CA124IR	28-1566	JA675IR
28-0700	CA196IR	28-0840	JA167IR	28-0956	CA319IR	28-1567	CA625IR
28-0701	CA125IR	28-0842	JA799IR	28-0958	CA298IR	28-1568	JA668IR
28-0702	CA189IR	28-0843	CA225IR	28-0959	CA372IR	28-1569	JA599IR
28-0703	JA573IR	28-0845	JA1127IR	28-0961	JA192IR	28-1570	JA660IR
28-0705	CA579IR	28-0846	CA289IR	28-0962	JA765IR	28-1572	CA562IR
28-0706	CA173IR	28-0847	CA609IR	28-0963	JA163IR	28-1573	JA792IR
28-0708	CA175IR	28-0849	CA158IR	28-0964	JA191IR	28-1574	CA284IR
28-0709	CA229IR	28-0849	CA507IR	28-0965	JA165IR	28-1575	CA251IR
28-0715	CA233IR	28-0850	JA785IR	28-0967	JA669IR	28-1576	JA751IR
28-0716	JA146IR	28-0851	CA287IR	28-0968	JA160IR	28-1577	JA752IR
28-0717	CA1554IR	28-0852	JA161IR	28-0971	CA295IR	28-1579	JA161IR
28-0717	CA325IR	28-0853	JA194IR	28-0972	CA299IR	28-1583	CA381IR
28-0718	CA252IR	28-0854	CA139IR	28-0973	CA1387IR	28-1585	CA251IR
28-0719	JA807IR	28-0857	JA104IR	28-0974	CA225IR	28-1586	CA909IR
28-0720	CA127IR	28-0858	CA221IR	28-0975	JA578IR	28-1587	JA659IR
28-0723	CA96IR	28-0859	CA87IR	28-0976	JA771IR	28-1589	JA673IR
28-0724	CA94IR	28-0861	CA375IR	28-0977	JA182IR	28-1590	CA342IR
28-0725	CA61IR	28-0862	JA801IR	28-0978	JA129IR	28-1591	CA628IR
28-0726	CA60IR	28-0863	CA48IR	28-0979	JA531IR	28-1595	CA589IR
28-0727	CA126IR	28-0864	CA264IR	28-0980	CA380IR	28-1597	JA161IR
28-0730	CA734IR	28-0865	CA548IR	28-0981	CA1435IR	28-1598	JA575IR
28-0733	CA350IR	28-0867	CA110IR	28-0981	JA188IR	28-1599	CA150IR
28-0733	CA572IR	28-0868	CA110IR	28-0982	CA129IR	28-1600	JA175IR
28-0736	CA195IR	28-0869	CA321IR	28-0984	CA205IR	28-1602	CA707IR
28-0737	CA287IR	28-0870	CA345IR	28-0986	CA236IR	28-1603	CA323IR
28-0738	CA69IR	28-0871	CA312IR	28-0987	JA186IR	28-1604	CA322IR
28-0739	CA186IR	28-0874	CA369IR	28-0988	CA310IR	28-1605	CA165IR
28-0742	CA186IR	28-0877	CA307IR	28-0990	JA181IR	28-1607	CA335IR
28-0744	CA228IR	28-0879	JA662IR	28-0991	CA384IR	28-1610	CA711IR
28-0745	CA374IR	28-0880	JA162IR	28-0992	CA1028IR	28-1611	CA352IR
28-0747	CA813IR	28-0881	CA597IR	28-0992	CA311IR	28-1613	CA318IR
28-0748	CA163IR	28-0886	JA573IR	28-0996	CA350IR	28-1613	CA320IR
28-0751	CA303IR	28-0887	JA115IR	28-0997	CA320IR	28-1614	JA598IR
28-0754	CA224IR	28-0888	JA166IR	28-0998	CA358IR	28-1615	CA17H
28-0756	CA22H	28-0891	CA528IR	28-1276	JA657IR	28-1616	CA601IR
28-0757	CA347IR	28-0892	CA574IR	28-1500	JA185IR	28-1620	JA671IR
28-0759	CA207IR	28-0893	JA661IR	28-1502	CA313IR	28-1621	JA664IR
28-0760	CA125IR	28-0894	JA177IR	28-1503	JA971IR	28-1622	CA527IR

O.E. NO.	HC-PARTS	O.E. NO.	HC-PARTS	O.E. NO.	HC-PARTS	O.E. NO.	HC-PARTS
<b>ELSTOCK <i>Continued</i></b>							
28-1623	CA5871R	28-1720	JA8031R	28-1821	JA9761R	28-1959	CA3601R
28-1624	CA5561R	28-1722	JA6831R	28-1822	CA8991R	28-1960	JA14211R
28-1625	CA5211R	28-1723	JA6841R	28-1823	CA7311R	28-1960	JA8671R
28-1626	JA8641R	28-1724	CA3401R	28-1824	CA5261R	28-1961	JA6541R
28-1628	CA6271R	28-1725	JA5431R	28-1825	CA2631R	28-1962	CA7301R
28-1629	CA5641R	28-1726	JA8621R	28-1827	CA7141R	28-1964	UA9381R
28-1631	CA3781R	28-1727	JA1741R	28-1828	JA9741R	28-1966	CA13831R
28-1633	CA5961R	28-1728	CA5661R	28-1829	JA7731R	28-1967	JA6571R
28-1635	JA6941R	28-1729	CA3611R	28-1830	CA14331R	28-1969	CA8251R
28-1637	CA1981R	28-1730	CA5191R	28-1832	CA8931R	28-1970	CA6371R
28-1638	CA8111R	28-1731	JA7561R	28-1833	CA8291R	28-1971	JA11881R
28-1640	JA1471R	28-1732	JA6781R	28-1834	JA7761R	28-1973	CA6391R
28-1641	JA7641R	28-1733	CA2881R	28-1835	CA2381R	28-1974	CA10701R
28-1643	JA6821R	28-1734	CA3551R	28-1836	JA8681R	28-1977	CA10451R
28-1644	JA7531R	28-1735	CA2541R	28-1837	CA5571R	28-1978	CA1361R
28-1646	JA6531R	28-1736	CA7121R	28-1838	CA5701R	28-1979	UA9531R
28-1648	JA7591R	28-1738	CA8391R	28-1840	CA7251R	28-1980	JA11781R
28-1649	JA11231R	28-1740	CA5391R	28-1841	JA7721R	28-1981	CA5151R
28-1650	CA5161R	28-1742	CA10481R	28-1843	CA5641R	28-1982	JA14221R
28-1653	CA3321R	28-1743	JA7611R	28-1854	JA5431R	28-1982	JA6911R
28-1654	CA5341R	28-1746	JA7621R	28-1855	JA7981R	28-1983	JA9801R
28-1655	JA6661R	28-1747	JA7691R	28-1856	JA7671R	28-1984	JA8661R
28-1656	CA3521R	28-1748	JA6771R	28-1857	JA6521R	28-1986	JA7571R
28-1657	CA6011R	28-1749	JA8851R	28-1859	CA8971R	28-1987	CA3791R
28-1658	CA6301R	28-1750	JA13511R	28-1862	CA6101R	28-1991	CA3201R
28-1659	JA5711R	28-1753	JA11311R	28-1863	JA6581R	28-1992	CA8341R
28-1660	CA3701R	28-1754	CA3491R	28-1864	CA8201R	28-1993	CA9031R
28-1661	CA6171R	28-1756	JA7551R	28-1866	CA8471R	28-1994	JA6891R
28-1662	CA6181R	28-1757	JA8061R	28-1867	JA1611R	28-1995	JA8651R
28-1664	CA7131R	28-1759	CA3061R	28-1868	JA8821R	28-1997	JA5511R
28-1665	CA7151R	28-1760	JA7501R	28-1869	JA8761R	28-1998	CA5321R
28-1666	CA5671R	28-1760	JA8811R	28-1870	CA8611R	28-1999	CA3831R
28-1668	CA10881R	28-1761	JA1251R	28-1871	CA10531R	28-2500	CA10691R
28-1669	CA5691R	28-1763	JA7601R	28-1872	CA8311R	28-2501	CA10301R
28-1670	JA6671R	28-1764	CA6421R	28-1876	CA3521R	28-2501	CA7181R
28-1671	JA5521R	28-1765	CA5201R	28-1877	JA6821R	28-2502	CA10481R
28-1672	JA6651R	28-1766	CA5931R	28-1879	CA7381R	28-2503	CA6401R
28-1674	CA5101R	28-1767	CA5901R	28-1880	JA1091R	28-2504	CA8901R
28-1675	JA1711R	28-1768	CA7331R	28-1884	JA8851R	28-2505	JA12861R
28-1676	JA6521R	28-1770	JA5781R	28-1885	CA10291R	28-2508	JA13531R
28-1677	JA6851R	28-1771	CA9151R	28-1885	CA6111R	28-2509	CA8891R
28-1678	JA8651R	28-1772	CA5031R	28-1887	CA10461R	28-2511	JA11301R
28-1679	JA6701R	28-1773	CA5401R	28-1888	CA6131R	28-2512	JA12861R
28-1680	CA5131R	28-1774	CA5421R	28-1894	CA12421R	28-2514	CA10311R
28-1681	JA1751R	28-1775	CA5061R	28-1896	JA8631R	28-2514	CA7191R
28-1682	JA1091R	28-1776	CA5041R	28-1897	UA9301R	28-2515	CA8141R
28-1683	JA6951R	28-1777	CA5641R	28-1901	CA1861R	28-2516	CA8321R
28-1684	CA5841R	28-1778	CA5061R	28-1906	CA8501R	28-2517	JA1821R
28-1685	CA2841R	28-1779	JA8041R	28-1908	JA8711R	28-2518	CA8211R
28-1686	JA5521R	28-1780	JA11771R	28-1910	JA9951R	28-2519	JA7801R
28-1687	JA8691R	28-1781	JA7631R	28-1911	CA8961R	28-2520	CA2541R
28-1688	JA5991R	28-1783	CA13791R	28-1912	CA3771R	28-2522	JA11661R
28-1689	JA1291R	28-1784	JA8781R	28-1913	CA11031R	28-2523	JA9851R
28-1690	JA1741R	28-1785	JA7981R	28-1914	CA5151R	28-2525	CA12451R
28-1690	JA8041R	28-1786	CA8411R	28-1915	CA5321R	28-2527	JA11221R
28-1691	CA5171R	28-1787	CA5141R	28-1917	JA9741R	28-2528	JA1631R
28-1692	JA6961R	28-1788	JA8051R	28-1918	CA6341R	28-2529	JA8831R
28-1693	CA2681R	28-1790	CA5631R	28-1920	CA7401R	28-2531	CA12511R
28-1694	JA1611R	28-1792	CA5611R	28-1924	JA8741R	28-2532	UA9631R
28-1695	JA6971R	28-1793	JA7741R	28-1926	JA7541R	28-2533	JA9811R
28-1696	JA7931R	28-1794	JA1051R	28-1927	JA13601R	28-2536	JA13581R
28-1698	JA1161R	28-1795	JA7611R	28-1928	CA5861R	28-2537	JA11781R
28-1699	CA5911R	28-1796	JA7591R	28-1929	CA7361R	28-2538	CA10621R
28-1700	CA5411R	28-1798	JA7821R	28-1930	JA6981R	28-2540	JA9881R
28-1701	JA6741R	28-1799	CA5941R	28-1932	CA3731R	28-2541	JA14071R
28-1702	JA1291R	28-1803	CA7081R	28-1934	JA8801R	28-2542	CA8161R
28-1703	CA5141R	28-1805	JA6891R	28-1936	CA6221R	28-2543	CA5641R
28-1704	CA6051R	28-1807	JA9731R	28-1939	CA7321R	28-2546	CA9001R
28-1705	CA6321R	28-1808	JA9831R	28-1940	JA1851R	28-2547	JA14181R
28-1707	CA6061R	28-1809	JA1541R	28-1942	JA8811R	28-2549	JA8881R
28-1708	CA6351R	28-1810	JA7531R	28-1943	CA7001R	28-2550	CA10441R
28-1709	CA8381R	28-1812	JA8701R	28-1944	CA8371R	28-2551	CA10421R
28-1710	CA7161R	28-1813	JA7531R	28-1946	CA7421R	28-2552	JA7651R
28-1711	CA6071R	28-1814	JA6801R	28-1947	CA3021R	28-2553	CA2291R
28-1712	CA6331R	28-1816	CA7001R	28-1950	CA2551R	28-2554	JA13661R
28-1713	CA6341R	28-1817	CA8551R	28-1952	CA7431R	28-2555	JA7831R
28-1715	JA11691R	28-1818	CA5471R	28-1953	CA8331R	28-2557	CA5601R
28-1717	CA2291R	28-1819	CA5621R	28-1955	JA8791R	28-2558	CA9051R
28-1719	JA1291R	28-1820	CA8251R	28-1956	CA10621R	28-2560	CA7241R

O.E. NO.	HC-PARTS	O.E. NO.	HC-PARTS	O.E. NO.	HC-PARTS	O.E. NO.	HC-PARTS
28-2561	JA1284IR	28-2670	JA551IR	28-2786	JA873IR	28-2904	JA690IR
28-2562	JA995IR	28-2672	CA1032IR	28-2788	JA978IR	28-2906	JA1716IR
28-2565	JA1120IR	28-2673	CA851IR	28-2790	CA1301IR	28-2908	CA1299IR
28-2566	CA1347IR	28-2675	CA1079IR	28-2791	CA1093IR	28-2910	CA1473IR
28-2567	CA1034IR	28-2677	JA1165IR	28-2792	CA1629IR	28-2911	CA255IR
28-2568	JA1122IR	28-2679	CA1157IR	28-2794	CA1070IR	28-2913	CA840IR
28-2574	CA1197IR	28-2680	CA1203IR	28-2795	CA1065IR	28-2915	CA1561IR
28-2575	UA924IR	28-2681	JA655IR	28-2796	CA1563IR	28-2917	CA1324IR
28-2578	CA1381IR	28-2683	JA165IR	28-2798	CA1085IR	28-2918	CA826IR
28-2580	CA382IR	28-2684	JA663IR	28-2799	JA1375IR	28-2919	CA612IR
28-2581	JA1421IR	28-2685	CA1554IR	28-2800	JA1520IR	28-2920	CA1101IR
28-2581	JA867IR	28-2685	CA325IR	28-2801	CA1033IR	28-2923	CA1051IR
28-2584	JA761IR	28-2687	CA1052IR	28-2803	JA1119IR	28-2924	CA1055IR
28-2585	CA1064IR	28-2689	CA1066IR	28-2804	JA1184IR	28-2925	CA1155IR
28-2586	CA815IR	28-2690	CA638IR	28-2806	CA1147IR	28-2926	CA1145IR
28-2587	CA1089IR	28-2691	CA259IR	28-2807	JA1414IR	28-2927	CA1256IR
28-2588	CA1269IR	28-2694	JA109IR	28-2808	CA701IR	28-2928	CA1239IR
28-2589	CA1229IR	28-2697	CA1160IR	28-2809	JA682IR	28-2929	CA1304IR
28-2589	CA828IR	28-2699	CA1238IR	28-2812	JA1513IR	28-2931	CA830IR
28-2590	CA1063IR	28-2700	CA1196IR	28-2813	CA1141IR	28-2932	CA836IR
28-2590	CA1073IR	28-2701	CA706IR	28-2815	CA1398IR	28-2934	CA528IR
28-2591	CA1265IR	28-2702	CA535IR	28-2816	JA1409	28-2934	CA904IR
28-2592	CA1098IR	28-2703	CA1069IR	28-2817	CA1138IR	28-2935	CA895IR
28-2593	CA1040IR	28-2706	CA1084IR	28-2818	CA739IR	28-2938	JA1117IR
28-2594	CA1038IR	28-2707	CA1227IR	28-2821	CA126IR	28-2940	CA1198IR
28-2597	CA1095IR	28-2707	CA305IR	28-2823	JA1530IR	28-2941	JA979IR
28-2598	CA913IR	28-2708	JA1411IR	28-2825	CA1455IR	28-2945	CA819IR
28-2599	JA1417IR	28-2709	CA1221IR	28-2827	CA835IR	28-2946	CA1745IR
28-2600	CA827IR	28-2710	CA1107IR	28-2828	CA1230IR	28-2949	CA1073IR
28-2601	CA845IR	28-2711	CA1269IR	28-2829	JA1405IR	28-2950	CA1041IR
28-2602	CA641IR	28-2714	JA1369IR	28-2830	JA148IR	28-2951	CA1059IR
28-2605	JA987IR	28-2715	JA1413IR	28-2832	JA1426IR	28-2952	CA1027IR
28-2606	CA1060IR	28-2717	CA1154IR	28-2833	CA1231IR	28-2953	JA1126IR
28-2607	CA1036IR	28-2718	CA1204IR	28-2834	CA1260IR	28-2956	CA712IR
28-2608	CA608IR	28-2719	CA1161IR	28-2836	CA1447IR	28-2959	CA1107IR
28-2609	CA1075IR	28-2721	CA1208IR	28-2837	CA1246IR	28-2960	CA610IR
28-2614	JA1275IR	28-2722	CA828IR	28-2839	JA1357IR	28-2961	CA319IR
28-2615	CA649IR	28-2723	CA1216IR	28-2840	CA1256IR	28-2962	CA1226IR
28-2616	JA781IR	28-2724	CA1159IR	28-2841	CA1449IR	28-2963	CA1206IR
28-2617	CA852IR	28-2725	CA1219IR	28-2843	CA842IR	28-2964	CA1402IR
28-2618	JA975IR	28-2726	JA1367IR	28-2844	JA1271IR	28-2967	CA1241IR
28-2619	CA1244IR	28-2727	CA1218IR	28-2845	CA1258IR	28-2968	JA1364IR
28-2620	JA189IR	28-2728	CA1189IR	28-2848	JA1419IR	28-2970	CA1267IR
28-2621	CA1039IR	28-2729	CA896IR	28-2849	CA1318IR	28-2971	CA1329IR
28-2622	JA1183IR	28-2730	JA1181IR	28-2850	CA1057IR	28-2972	JA1704IR
28-2623	CA579IR	28-2731	CA711IR	28-2851	CA1139IR	28-2973	CA1142IR
28-2624	CA849IR	28-2732	CA1190IR	28-2855	UA947IR	28-2975	CA1482IR
28-2625	CA1137IR	28-2734	CA1153IR	28-2856	UA941IR	28-2976	JA598IR
28-2626	CA1822IR	28-2735	CA1154IR	28-2860	UA955IR	28-2978	JA769IR
28-2627	CA914IR	28-2736	JA1134IR	28-2861	JA994IR	28-2979	CA1378IR
28-2629	JA989IR	28-2738	CA1382IR	28-2862	CA1248IR	28-2980	JA1533IR
28-2630	CA1220IR	28-2739	CA1105IR	28-2863	CA1037IR	28-2981	CA1435IR
28-2631	CA1087IR	28-2744	CA1450IR	28-2864	CA1240IR	28-2982	JA970IR
28-2633	CA827IR	28-2745	CA516IR	28-2866	CA502IR	28-2984	CA1247IR
28-2634	JA1188IR	28-2746	CA647IR	28-2867	CA1144IR	28-2985	CA1446IR
28-2635	CA1071IR	28-2750	JA1534IR	28-2869	CA1253IR	28-2988	CA1512IR
28-2636	CA848IR	28-2751	CA1472IR	28-2872	JA1527IR	28-2990	CA1394IR
28-2637	CA1085IR	28-2753	CA1100IR	28-2873	JA1519IR	28-2991	CA1299IR
28-2641	JA1279IR	28-2754	CA627IR	28-2874	JA1516IR	28-2993	CA1383IR
28-2642	CA539IR	28-2755	CA1106IR	28-2876	JA1176IR	28-2994	CA1243IR
28-2646	JA1121IR	28-2757	JA1128IR	28-2878	JA1368IR	28-2995	CA1104IR
28-2647	JA1187IR	28-2759	JA1183IR	28-2879	JA1280IR	28-2996	CA1502IR
28-2648	CA1068IR	28-2761	JA1288IR	28-2880	CA1056IR	28-2998	JA1515IR
28-2650	CA1507IR	28-2763	CA1229IR	28-2882	CA1043IR	28-2999	CA1651IR
28-2652	JA1162IR	28-2769	CA1300IR	28-2885	CA1494IR	28-3001	JA1416IR
28-2653	CA1146IR	28-2770	CA535IR	28-2887	JA1702IR	28-3002	CA1671IR
28-2654	JA1182IR	28-2771	CA729IR	28-2888	CA829IR	28-3003	CA1031IR
28-2655	JA1366IR	28-2772	JA1172IR	28-2888	CA912IR	28-3003	CA719IR
28-2656	JA1363IR	28-2773	JA1273IR	28-2889	CA1323IR	28-3004	CA1140IR
28-2657	JA1374IR	28-2774	JA1167IR	28-2890	JA1528IR	28-3005	CA1233IR
28-2658	CA1152IR	28-2777	CA1228IR	28-2892	CA1317IR	28-3007	CA1672IR
28-2660	CA844IR	28-2778	CA846IR	28-2893	CA1044IR	28-3009	CA1143IR
28-2661	CA1320IR	28-2780	JA1272IR	28-2894	CA1685IR	28-3009	CA829IR
28-2662	CA1217IR	28-2781	CA1031IR	28-2896	JA1174IR	28-3010	CA1136IR
28-2663	CA1057IR	28-2781	CA719IR	28-2898	CA1626IR	28-3011	CA1150IR
28-2664	CA1076IR	28-2782	JA1133IR	28-2899	CA1254IR	28-3012	CA1151IR
28-2665	JA657IR	28-2783	CA1209IR	28-2900	JA1523IR	28-3014	CA1200IR
28-2666	JA1179IR	28-2783	CA1395IR	28-2901	JA1287IR	28-3016	CA902IR
28-2667	CA1096IR	28-2784	CA603IR	28-2902	UA942IR	28-3017	CA1551IR

O.E. NO.	HC-PARTS	O.E. NO.	HC-PARTS	O.E. NO.	HC-PARTS	O.E. NO.	HC-PARTS
<b>ELSTOCK <i>Continued</i></b>							
28-3519	CA3051R	28-3657	CA1391IR	28-3795	JA1802IR	28-3929	JA1795IR
28-3523	CA1255IR	28-3658	JA1161R	28-3796	CA1849IR	28-3931	CA1580IR
28-3524	CA1556IR	28-3660	CA1470IR	28-3798	CA1495IR	28-3933	JA678IR
28-3525	CA1943IR *	28-3660	CA1628IR	28-3800	JA1411IR	28-3935	JA1415IR
28-3525	JA1293IR	28-3661	JA689IR	28-3803	CA1564IR	28-3936	CA1577IR
28-3526	CA1099IR	28-3668	CA1500IR	28-3806	JA1604IR	28-3938	CA1628IR
28-3528	CA1216IR	28-3669	CA1544IR	28-3807	CA1557IR	28-3940	CA1748IR
28-3529	CA646IR	28-3670	CA1492IR	28-3810	JA1522IR	28-3944	CA1575IR
28-3530	CA720IR	28-3672	JA1293IR	28-3811	JA1609IR	28-3947	JA1722IR
28-3533	CA1306IR	28-3676	JA770IR	28-3814	CA1639IR	28-3948	CA1319IR
28-3534	CA1344IR	28-3677	CA1492IR	28-3816	CA1499IR	28-3949	CA1589IR
28-3535	CA1501IR	28-3679	JA992IR	28-3818	JA1611IR	28-3950	CA1322IR
28-3536	JA1376IR	28-3680	CA1845IR	28-3822	JA1532IR	28-3951	CA1576IR
28-3538	JA1376IR	28-3682	JA1420IR	28-3823	JA166IR	28-3952	CA1207IR
28-3539	CA1328IR	28-3683	CA836IR	28-3828	CA1207IR	28-3953	CA1688IR
28-3540	JA688IR	28-3685	JA1424IR	28-3831	JA1522IR	28-3955	CA1307IR
28-3541	JA1123IR	28-3686	CA1503IR	28-3835	JA1616IR	28-3956	JA1356IR
28-3542	JA1134IR	28-3689	CA1491IR	28-3836	UA964IR	28-3957	JA1166IR
28-3543	JA1276IR	28-3690	JA1129IR	28-3837	CA1553IR	28-3958	JA1715IR
28-3544	JA1164IR	28-3691	CA1477IR	28-3838	JA1595IR	28-3961	CA1386IR
28-3545	JA1173IR	28-3693	JA1713IR	28-3839	JA1521IR	28-3963	CA1635IR
28-3546	JA1281IR	28-3694	CA1439IR	28-3840	CA1634IR	28-3965	CA1637IR
28-3547	JA990IR	28-3695	CA1496IR	28-3841	JA1605IR	28-3968	JA1536IR
28-3548	JA1180IR	28-3698	CA1403IR	28-3843	CA1493IR	28-3970	CA1622IR
28-3549	CA1570IR	28-3699	CA1333IR	28-3846	JA1517IR	28-3971	CA564IR
28-3550	JA1601IR	28-3701	CA1305IR	28-3847	CA1634IR	28-3972	JA1787IR
28-3551	JA1361IR	28-3702	CA1572IR	28-3850	JA1372IR	28-3974	CA1771IR
28-3553	CA1380IR	28-3703	CA1591IR	28-3851	CA1559IR	28-3977	CA817IR
28-3555	CA1543IR	28-3705	CA1541IR	28-3852	JA1717IR	28-3979	JA1410IR
28-3557	UA925IR	28-3706	CA1225IR	28-3853	CA1549IR	28-3982	CA1333IR
28-3559	CA1380IR	28-3707	CA1041IR	28-3855	JA1274IR	28-3989	CA1586IR
28-3560	CA701IR	28-3709	CA1644IR	28-3856	JA1169IR	28-3991	JA787IR
28-3561	CA1061IR	28-3711	JA1365IR	28-3857	CA1303IR	28-3992	CA1250IR
28-3562	CA648IR	28-3712	CA1441IR	28-3858	JA1185IR	28-3995	CA1474IR
28-3563	CA636IR	28-3714	JA160IR	28-3859	JA1711IR	28-4500	CA1631IR
28-3565	CA1300IR	28-3715	CA1302IR	28-3862	CA1982IR	28-4501	JA1723IR
28-3566	CA1191IR	28-3717	JA1295IR	28-3863	CA1622IR	28-4504	JA1607IR
28-3569	CA1300IR	28-3718	CA1062IR	28-3865	CA1546IR	28-4505	JA1596IR
28-3571	CA1084IR	28-3720	CA1481IR	28-3866	JA1600IR	28-4506	CA1308IR
28-3572	JA870IR	28-3721	JA1518IR	28-3867	CA1342IR	28-4507	CA1500IR
28-3573	CA1629IR	28-3723	JA1377IR	28-3868	CA1664IR	28-4509	CA1677IR
28-3579	CA818IR	28-3724	CA1540IR	28-3869	JA1793IR	28-4510	CA1339IR
28-3580	CA1199IR	28-3725	CA1440IR	28-3870	CA1756IR	28-4511	JA1594IR
28-3584	UA1538IR	28-3727	CA1343IR	28-3871	JA1794IR	28-4512	CA1584IR
28-3587	UA1109IR	28-3729	CA1082IR	28-3872	CA1545IR	28-4514	JA1294IR
28-3588	UA940IR	28-3730	CA700IR	28-3873	CA1653IR	28-4515	CA1640IR
28-3590	CA324IR	28-3733	JA1425IR	28-3875	CA1639IR	28-4516	JA1523IR
28-3592	CA1401IR	28-3734	CA1392IR	28-3876	CA1746IR	28-4521	CA1548IR
28-3599	CA1262IR	28-3735	CA1139IR	28-3877	CA1298IR	28-4522	CA1223IR
28-3601	CA1436IR	28-3737	CA1471IR	28-3878	CA1451IR	28-4524	CA1331IR
28-3612	CA645IR	28-3738	CA1434IR	28-3879	CA521IR	28-4525	CA1546IR
28-3615	CA645IR	28-3740	CA1488IR	28-3882	JA1710IR	28-4527	CA1189IR
28-3620	JA774IR	28-3742	CA700IR	28-3887	CA1588IR	28-4528	JA1783IR
28-3621	CA1232IR	28-3743	CA646IR	28-3888	CA1581IR	28-4531	CA1845IR
28-3623	JA783IR	28-3744	CA1630IR	28-3890	CA1332IR	28-4532	CA306IR
28-3624	CA1091IR	28-3745	JA1603IR	28-3891	CA1627IR	28-4534	CA1845IR
28-3625	JA1599IR	28-3746	CA1207IR	28-3894	CA2074IR *	28-4537	CA1689IR
28-3626	CA1490IR	28-3748	CA1350IR	28-3898	JA1412IR	28-4539	CA1830IR
28-3630	CA1445IR	28-3749	CA1571IR	28-3899	JA1271IR	28-4540	CA1444IR
28-3631	JA1536IR	28-3750	CA1558IR	28-3900	CA1759IR	28-4542	CA2083IR *
28-3632	CA1268IR	28-3751	CA564IR	28-3903	CA1567IR	28-4544	CA1641IR
28-3634	CA1585IR	28-3752	CA1509IR	28-3905	CA1566IR	28-4545	JA1708IR
28-3636	CA1249IR	28-3753	CA1349IR	28-3906	JA1417IR	28-4547	CA1592IR
28-3637	CA1443IR	28-3754	CA1397IR	28-3908	CA1312IR	28-4548	CA1634IR
28-3638	JA1430IR	28-3755	CA1572IR	28-3909	JA1802IR	28-4551	UA935IR
28-3639	CA1750IR	28-3756	CA1325IR	28-3910	JA1371IR	28-4553	CA1813IR
28-3640	CA1252IR	28-3757	CA1330IR	28-3911	CA645IR	28-4555	CA1641IR
28-3642	JA1126IR	28-3760	CA1504IR	28-3912	JA1802IR	28-4556	CA1754IR
28-3644	CA1587IR	28-3761	CA1442IR	28-3914	CA1560IR	28-4562	JA1605IR
28-3645	CA1478IR	28-3768	CA1485IR	28-3917	CA1568IR	28-4566	CA1256IR
28-3646	UA945IR	28-3770	CA1395IR	28-3918	CA1316IR	28-4567	CA1577IR
28-3647	CA1223IR	28-3772	CA1932IR	28-3919	CA1394IR	28-4570	CA1648IR
28-3648	CA1637IR	28-3774	CA1306IR	28-3921	CA1489IR	28-4571	JA1527IR
28-3649	CA826IR	28-3776	CA1322IR	28-3922	CA1641IR	28-4573	CA1074IR
28-3650	JA1422IR	28-3778	CA1090IR	28-3923	CA1590IR	28-4576	CA1582IR
28-3651	CA1508IR	28-3783	JA1801IR	28-3924	CA1573IR	28-4579	CA1647IR
28-3654	CA1735IR	28-3784	CA1542IR	28-3925	JA551IR	28-4580	JA1597IR
28-3655	CA1484IR	28-3792	CA1338IR	28-3926	CA1578IR	28-4582	JA1788IR
28-3656	UA939IR	28-3794	CA1511IR	28-3928	CA1569IR	28-4586	CA1206IR



O.E. NO.	HC-PARTS	O.E. NO.	HC-PARTS	O.E. NO.	HC-PARTS	O.E. NO.	HC-PARTS
28-4587	CA1206IR	28-4728	CA1764IR	28-4886	CA1877IR	28-5554	CA1867IR
28-4590	CA846IR	28-4729	CA1773IR	28-4888	JA1897IR	28-5560	CA1890IR
28-4596	CA1662IR	28-4731	CA1675IR	28-4889	CA1766IR	28-5561	CA1965IR *
28-4597	JA1718IR	28-4732	CA1755IR	28-4893	JA1608IR	28-5562	CA1996IR
28-4598	CA1774IR	28-4733	CA1811IR	28-4900	JA1406IR	28-5564	CA1921IR
28-4600	CA1583IR	28-4734	CA1769IR	28-4902	JA1796IR	28-5565	JA1798IR
28-4601	CA1698IR	28-4735	CA1389IR	28-4903	CA1963IR	28-5567	CA1970IR
28-4602	JA1790IR	28-4736	CA836IR	28-4905	CA717IR	28-5568	CA1943IR *
28-4603	CA1643IR	28-4737	CA1756IR	28-4907	JA1800IR	28-5570	CA1904IR
28-4605	CA291IR	28-4738	CA1334IR	28-4908	JA1804IR	28-5571	CA2004IR
28-4606	CA1646IR	28-4740	CA1332IR	28-4909	CA1862IR	28-5572	CA1940IR
28-4608	CA1077IR	28-4745	JA1808IR	28-4910	JA1893IR	28-5575	CA2009IR
28-4610	CA1661IR	28-4746	CA1766IR	28-4911	CA1755IR	28-5579	CA2052IR
28-4611	CA1541IR	28-4751	JA1803IR	28-4912	CA1388IR	28-5581	CA1954IR
28-4612	CA1621IR	28-4768	JA1727IR	28-4914	CA1856IR	28-5583	CA1953IR
28-4613	CA1199IR	28-4769	CA1437IR	28-4917	CA1742IR	28-5584	CA1953IR
28-4614	CA1645IR	28-4771	CA1446IR	28-4919	CA1814IR	28-5585	CA1980IR *
28-4616	CA1677IR	28-4773	CA1782IR	28-4921	CA1862IR	28-5588	CA1933IR
28-4616	CA1838IR	28-4774	CA1837IR	28-4922	JA1891IR	28-5590	CA1968IR
28-4618	CA1681IR	28-4775	CA1489IR	28-4923	JA1899IR	28-5591	CA1928IR
28-4620	JA694IR	28-4776	CA1776IR	28-4925	CA1884IR	28-5592	CA1922IR
28-4621	CA1632IR	28-4777	CA1765IR	28-4926	CA1995IR	28-5593	CA1919IR
28-4621WH	CA1632IR	28-4780	CA1676IR	28-4927	CA1885IR	28-5599	JA1903IR
28-4622	CA1641IR	28-4781	JA1721IR	28-4928	CA2084IR *	28-5613	JA1797IR
28-4624	CA1680IR	28-4787	CA1622IR	28-4929	CA1199IR	28-5615	JA987IR
28-4625	CA1854IR	28-4788	CA1761IR	28-4930	CA1642IR	28-5616	CA1923IR
28-4627	CA1547IR	28-4789	CA1665IR	28-4935	CA1855IR	28-5618	CA1840IR
28-4628	CA1652IR	28-4791	CA1665IR	28-4936	CA1860IR	28-5619	CA1952IR
28-4629	CA1562IR	28-4792	JA1806IR	28-4937	CA1860IR	28-5620	CA1969IR
28-4630	CA1548IR	28-4795	JA1617IR	28-4939	JA1785IR	28-5621	CA2025IR
28-4631	JA1612IR	28-4797	CA1983IR	28-4941	CA1833IR	28-5622	CA2044IR *
28-4632	CA1760IR	28-4799	JA1896IR	28-4942	CA1747IR	28-5623	CA1949IR
28-4633	CA1627IR	28-4800	JA1805IR	28-4943	CA1658IR	28-5632	JA884IR
28-4634	CA1679IR	28-4801	CA1741IR	28-4945	CA1859IR	28-5632	CA1689IR
28-4637	JA1522IR	28-4805	CA1753IR	28-4946	CA2059IR *	28-5637	CA1906IR
28-4639	CA1743IR	28-4807	JA1784IR	28-4953	UA1538IR	28-5640	CA1958IR
28-4640	JA1612IR	28-4809	CA1951IR *	28-4954	JA1423IR	28-5641	CA2038IR
28-4641	CA1673IR	28-4810	JA1796IR	28-4958	CA1832IR	28-5643	CA1991IR *
28-4642	CA1636IR	28-4811	CA1763IR	28-4959	CA1964IR	28-5645	CA1860IR
28-4643	JA1607IR	28-4812	CA1905IR	28-4961	CA1908IR	28-5648	CA1959IR
28-4644	CA1828IR	28-4814	JA1789IR	28-4963	CA1909IR	28-5650	JA1901IR
28-4645	CA1779IR	28-4816	CA1819IR	28-4965	JA1895IR	28-5653	CA1141IR
28-4648	CA1698IR	28-4818	CA1678IR	28-4971	CA1587IR	28-5655	CA1945IR
28-4649	CA1684IR	28-4820	CA1855IR	28-4972	CA2081IR *	28-5656	CA1994IR
28-4650	CA1400IR	28-4821	JA1795IR	28-4973	CA1920IR	28-5657	CA1881IR
28-4652	JA1613IR	28-4823	JA1606IR	28-4976	JA1892IR	28-5659	CA1938IR
28-4653	CA2022IR	28-4828	CA1696IR	28-4978	CA1836IR	28-5663	CA1927IR
28-4665	CA1839IR	28-4829	CA1778IR	28-4984	CA2037IR	28-5664	CA2091IR *
28-4668	JA1703IR	28-4833	CA1658IR	28-4987	CA1743IR	28-5665	CA1872IR
28-4669	CA1591IR	28-4835	CA1660IR	28-4988	CA1827IR	28-5666	CA2067IR *
28-4674	CA1848IR	28-4836	CA1774IR	28-4989	CA2082IR *	28-5667	CA2018IR
28-4675	CA1556IR	28-4837	CA1654IR	28-4992	JA1899IR	28-5668	JA1600IR
28-4676	CA1345IR	28-4840	JA1716IR	28-4994	JA1431IR	28-5673	CA1913IR
28-4679	JA1792IR	28-4842	CA1700IR	28-4998	CA1866IR	28-5674	CA1886IR
28-4681	CA1835IR	28-4843	CA1683IR	28-4998	CA1866IR	28-5675	CA1915IR
28-4684	JA1602IR	28-4844	CA1701IR	28-536	CA46IR	28-5676	CA1955IR
28-4686	CA1056IR	28-4846	CA1625IR	28-5501	CA1876IR	28-5677	CA1956IR
28-4688	CA1655IR	28-4848	CA1749IR	28-5502	CA1873IR	28-5678	CA1987IR
28-4689	CA1781IR	28-4849	CA1825IR	28-5503	CA1874IR	28-5678	CA1987IR
28-4693	CA564IR	28-4851	CA1767IR	28-5505	CA1470IR	28-5680	CA1935IR
28-4695	CA1861IR	28-4852	CA1768IR	28-5506	CA1337IR	28-5683	CA2055IR
28-4697	CA1861IR	28-4853	JA1712IR	28-5507	CA1872IR	28-5684	CA1978IR
28-4699	JA1615IR	28-4854	JA1724IR	28-5508	CA1757IR	28-5685	CA2023IR
28-4700	CA1761IR	28-4855	JA1725IR	28-5509	CA1875IR	28-5687	CA1652IR
28-4701	CA1673IR	28-4856	JA1726IR	28-5510	CA1762IR	28-5688	CA1639IR
28-4702	CA1674IR	28-4856	JA1726IR	28-5515	CA2024IR	28-5692	CA1879IR
28-4704	CA1850IR	28-4857	JA1728IR	28-5520	JA1894IR	28-5694	CA2062IR *
28-4705	JA1720IR	28-4861	CA1818IR	28-5521	CA1869IR	28-5696	CA2016IR
28-4706	JA1709IR	28-4862	CA1810IR	28-5522	CA1868IR	28-5698	CA1888IR
28-4707	CA1733IR	28-4863	CA1821IR	28-5524	JA1798IR	28-5699	CA1841IR
28-4710	CA1820IR	28-4864	CA1815IR	28-5528	CA1985IR	28-5703	CA1879IR
28-4712	CA1321IR	28-4865	CA1817IR	28-5530	CA1882IR	28-5706	CA2017IR
28-4713	CA1729IR	28-4866	CA1752IR	28-5532	CA1946IR	28-5707	CA1998IR
28-4715	CA1858IR	28-4868	CA1732IR	28-5536	CA1395IR	28-5708	CA2010IR
28-4716	CA1740IR	28-4869	CA1510IR	28-5538	JA1711IR	28-5710	CA1967IR
28-4722	CA1730IR	28-4870	CA1937IR	28-5543	CA1632IR	28-5711	CA1977IR
28-4725	CA1846IR	28-4874	CA1863IR	28-5544	CA1829IR	28-5712	CA2041IR
28-4726	JA1606IR	28-4875	CA1827IR	28-5545	CA1912IR	28-5715	CA1498IR
28-4727	CA1775IR	28-4876	CA1824IR	28-5547	CA2077IR *	28-5716	CA1499IR
		28-4884	CA1823IR	28-5548	CA1966IR *	28-5717	CA1687IR

O.E. NO.	HC-PARTS	O.E. NO.	HC-PARTS	O.E. NO.	HC-PARTS	O.E. NO.	HC-PARTS
<b>ELSTOCK <i>Continued</i></b>							
28-5718	CA1665IR	45-0327	CS710	45-3259	CS1383	48-1667	CA898IR
28-5720	CA2057IR	45-0345	CS231	45-3261	CS1292	48-1745	CA187IR
28-5721	CA2068IR *	45-0354	CS726	45-3262	CS1284	48-1758	CA858IR
28-5727	JA1353IR	45-0381	CS121	45-3272	CS1168	48-1782	CA550IR
28-5731	CA2028IR	45-0398	CS232	45-3281	CS1269	48-1782	CA748IR
28-5733	CA1930IR *	45-0399	CS1040	45-3302	CS1112	48-1801	CA1438IR
28-5738	CA1303IR	45-0412	CS983	45-3331	CS1243	48-1826	CA853IR
28-5740	CA2058IR *	45-0412	CS608	45-3332	CS1267	48-1845	JA977IR
28-5744	CA1832IR	45-0422	CS391	45-3349	CS1474	48-1893	CA240IR
28-5758	CA1916IR	45-0445	JS999	45-3350	CS1382	48-1904	CA222IR
28-5760	CA1303IR	45-0469	CS983	45-3352	CS506	48-1905	CA1035IR
28-5767	CA1975IR	45-0470	CS1127	45-3353	CS1268	48-1919	CA334IR
28-5768	CA1782IR	45-0473	CS983	45-3392	CS698	48-1921	CA341IR
28-5769	CA1981IR	45-0476	JS748	45-3400	CS1333	48-1922	CA568IR
28-5773	CA2089IR	45-0478	JS904	45-3429	CS1164	48-1931	UA1114IR
28-5778	CA2043IR	45-0479	CS881	45-3439	CS1380	48-1935	JA1170IR
28-5779	CA1979IR	45-0488	CS506	45-3443	CS1399	48-2563	CA907IR
28-5780	CA1918IR	45-0496	JS761	45-3444	CS1400	48-2583	JA1524IR
28-5781	CA1911IR	45-1005	JS540	45-3445	CS1388	48-2603	CA1296IR
28-5784	CA2036IR *	45-1060	JS666	45-3461	CS1278	48-2613	CA1049IR
28-5788	CA1910IR	45-1091	CS269	45-3468	CS1451	48-2639	CA1148IR
28-5790	CA1675IR	45-1095	JS777	45-3494	CS1386	48-2698	CA327IR
28-5791	CA2089IR *	45-1101	JS553	45-4013	CS1420	48-2740	UA948IR
28-5792	CA1056IR	45-1123	CS526	45-4073	CS1432	48-2742	CA1448IR
28-5796	CA1974IR	45-1154	CS595	45-4135	CS1495	48-2743	UA948IR
28-5797	CA1986IR	45-1196	CS797	45-469	CS983	48-2842	CA1667IR
28-5799	CA1929IR *	45-1227	CS349	47-0590	CA75	48-2851	CA1310IR
28-5800	CA1942IR *	45-1245	CS983	47-0644	CA78	48-2852	CA1310IR
28-5801	CA1974IR	45-1267	US823	47-0649	CA184	48-2859	CA1237IR
28-5824	CA1889IR	45-1274	CS383	47-0660	CA180	48-2922	CA1050IR
28-5826	CA2053IR	45-1297	CS617	47-0661	CA134	48-2937	CA1593IR
28-5866	CA2102IR *	45-1298	CS501	47-0665	CA184	48-2955	CA1770IR
28-5876	CA2048IR	45-1300	CS805	47-0666	CA187IR	48-2992	UA946IR
28-5877	CA2060IR *	45-1302	CS544	47-0673	JA651	48-3531	JA1118IR
28-5881	CA2059IR *	45-1320	CS608	47-0734	CA180	48-3674	CA1336IR
28-5905	CA2049IR *	45-1330	JS1087	47-0884	JA1125	48-3687	CA1593IR
28-5916	CA2086IR *	45-1354	CS1443	47-0895	CA721	48-3692	UA929IR
28-5924	CA2050IR *	45-1358	CS1167	47-0896	CA721	48-3728	CA1049IR
28-5975	CA2087IR *	45-1366	CS699	47-0920	JA676	48-3764	CA857IR
28-6536	CA2101IR *	45-1368	CS502	47-1509	JA1124	48-3771	CA1505IR
28-663	JA125IR	45-1370	CS384	47-1559	JA800	48-3780	CA1193IR
28-693	CA165IR	45-1372	JS655	47-1606	JA982	48-3785	JA1428IR
28-715	CA233IR	45-1392	JS746	47-2748	JA676	48-3844	CA1193IR
28-809	CA96IR	45-1428	CS194	48-0529	CA501IR	48-3984	CA1663IR
28-946	CA367IR	45-1429	CS120	48-0541	CA212IR	48-4552	CA1633IR
28-950	CA302IR	45-1430	CS546	48-0590	CA130IR	48-4557	CA1633IR
28-965	JA165IR	45-1431	CS388	48-0591	CA227IR	48-4563	CA2040IR
29-0503	CG50	45-1445	CS688	48-0591	CA749IR	48-4636	CA1666IR
29-0520	CG52	45-1462	JS733	48-0644	CA132IR	48-4667	CA1666IR
29-0547	CG58	45-1477	CS120	48-0659	CA334IR	48-4778	CA1666IR
29-0599	CG23K	45-2044	CS808	48-0666	CA187IR	48-4793	CA1624IR
29-0612	CG19	45-2130	CS1039	48-0697	CA705IR	48-4832	CA1650IR
29-0614	CG17	45-2138	JS1021	48-0710	JA1427IR	48-4834	CA1659IR
29-0617	CG23K	45-2175	CS1331	48-0734	CA341IR	48-4845	CA1694IR
38-2836	CA1447IR	45-2178	CS1061	48-0741	CA854IR	48-4859	CA1699IR
45-0030	CS195	45-2184	CS191	48-0780	CA368IR	48-4860	CA1812IR
45-0091	CS194	45-2188	CS1129	48-0808	JA187IR	48-4867	CA1739IR
45-0113	CS97	45-2196	JS930	48-0848	CA500IR	48-4918	CA1853IR
45-0114	CS98	45-2201	CS1169	48-0856	JA1352IR	48-4951	CA1851IR
45-0122	CS101	45-2214	JS1010	48-0878	CA333IR	48-4979	CA1842IR
45-0123	CS955	45-2237	CS1163	48-0889	JA672IR	48-4985	CA1738IR
45-0133	CS99	45-2240	CS989	48-0901	CA558IR	48-4993	CA1883IR
45-0150	CS121	45-2308	CS595	48-0909	CA710IR	48-4999	CA1870IR
45-0174	CS120	45-2332	JS1010	48-0930	JA796IR	48-5500	CA1871IR
45-0178	CS388	45-2377	CS198	48-0985	JA972IR	48-5519	CA1393IR
45-0179	CS387	45-2452	CS1199	48-0995	CA240IR	48-5534	CA1693IR
45-0180	CS546	45-2455	CS1161	48-1501	CA857IR	48-5549	CA1880IR
45-0184	CS383	45-2459	CS502	48-1501	CA858IR	48-5610	UA1620IR
45-0185	CS198	45-2482	JS1217	48-1548	CA748IR	48-5646	CA1947IR *
45-0190	CS198	45-2488	CS1164	48-1550	CA722IR	48-5686	CA1049IR
45-0195	JS656	45-3020	CS1279	48-1592	CA326IR	48-5700	CA1744IR
45-0197	CS99	45-3052	CS1261	48-1593	CA1235IR	48-5728	CA1880IR
45-0200	CS99	45-3067	CS1285	48-1593	CA823IR	48-5751	CA2039IR
45-0219	CS530	45-3097	CS1248	48-1596	CA227IR	48-5795	CA1997IR
45-0228	CS394	45-3103	CS1243	48-1596	CA749IR	48-666	CA568IR
45-0252	CS232	45-3138	CS1128	48-1619	JA1171IR	48-741	CA187IR
45-0254	CS195	45-3154	CS797	48-1627	JA984IR	65-0132	CS61
45-0291	CS191	45-3184	CS1348	48-1632	CA705IR	FEMSA	
45-0313	CS121	45-3199	CS1464	48-1634	CA518IR	ALB12-117	CA131

O.E. NO.	HC-PARTS	O.E. NO.	HC-PARTS	O.E. NO.	HC-PARTS	O.E. NO.	HC-PARTS
ALB40-68	CA120	MTS12-22	CS91	4395134	CA1271R	4744841	CS231
ALB40-86	CA120	MTS12-23	CS141	4401806	CS90	4745930	CS230
ALD12N-53	CA112	MTS12-23S	CS141	4412878	CS133	4750583	CA3161R
ALG12-20	CA71	MTS12-29	CS90	4412894	CS289	4752403	CS231
ALG12N-28	CA114	MTS12-39	CS90	4418109	CA1271R	4755111	CS394
ALN12-1	CA112	MTS12-42	CS90	4419109	CA1271R	4757192	CA3261R
ALO12X-2	CA166	MTS12-47	CS147	4419794	CA1271R	4757193	CA3261R
ALP12-17	CA1741R	MTS12-48	CS90	4424346	CA1291R	4757194	CA3261R
ALP12N-12	CA1901R	MTS12-51	CS95	4424962	CA2331R	4763995	CS232
ALP12N-14	CA811R	MTS12P-19	CS91	4434083	CA1271R	4765931	CA3551R
ALP12N-20	CA3071R	MTV12-8	CS130	4434084	CA2521R	4765933	CA3551R
ALP12N-24	CA3071R			4435660	CS133	4765934	CA3551R
ALP12NR-19	CA1491R	FENDT		4436732	CS91	4782802	CS564
ALP12NR-25	CA1491R	F135902060010	CS550	4443494	CS396	4782803	CS526
ALP12X-17	CA1741R	G345900011010	CA12421R	4448694	CS289	4784745	CS502
ALS12-81	CA1311R	G515900010100	CA14801R	4451759	CA3071R	4784747	CS502
ALS12N-1	CA611R	X830060020	CA12421R	4456152	CA3071R	4786913	CA2121R
ALS12N-24	CA1191R	X830060022	CA12421R	4458618	CA3071R	4787668	CA3551R
ALS12N-25	CA1261R	X830100001	CS114	4469985	CS275	4787671	CA3551R
ALS12N-47	CA841R	X830100009	CS550	4469986	CS275	4799364	CA6421R
ALS12N-51	CA1261R			4469987	CS275	4807373	CS572
ALS12N-53	CA611R	FER		4470118	CS275	4807374	CS230
ALS12N-54	CA1261R	131290039	CS369	4470266	CA2541R	4807375	CS240
ALS12N-55	CA1191R	131290079	CS369	4470377	CS285	4807376	CS682
ALS12N-56	CA1191R	131290080	CS369	4470378	CS285	4807377	CS231
ALS12N-62	CA611R	131290081	CS369	4470411	CA1191R	4807378	CS232
ALS12N-63	CA611R	131290099	CS369	4474714	CS147	4807379	CS394
ALS12N-75	CA2261R	131290100	CS602	4474715	CS147	4808498	CA2551R
ALS12N-82	CA2951R	FIAT		4474729	CA771R	4808500	CA6421R
ALS12X-26	CA1701R	992235	CA2521R	4474746	CS139	4808502	CA6421R
ALS12X-28	CA1781R	4052100	CA131	4474747	CS139	4808503	CA3161R
ALS12X-65	CA2881R	4109803	CS397	4474750	CS139	4808505	CA3161R
ALS12X-67	CA2681R	4111220	CS397	4474752	CA771R	4808506	CA3551R
ALS12X-76	CA1701R	4112049	CS397	4474804	CS141	4808507	CA6421R
ALS12X-77	CA2881R	4122049	CS397	4474805	CS141	4808510	CA3551R
ALT12N-11	CA15H	4142222	CS141	4474812	CA46	4808511	CA3551R
ALT12N-14	CA15H	4152101	CA120	4474815	CA45	4808517	CA3551R
ALT12N-19	CA461R	4162785	CS397	4474816	CA45	4808518	CA3551R
ALT12N-2	CA15H	4166213	CA120	4474851	CS308	4808519	CA2121R
ALT12N-39	CA15H	4172004	CS232	4474852	CS308	4808526	CA2121R
ALT12N-43	CA1721R	4172113	CS240	4474903	CA120	4808528	CA2121R
ALT12X-28	CA1721R	4174626	CA120	4474904	CA120	4844266	CA3261R
DNL12-22	CG50	4179626	CS564	4474917	CS363	4856056	CS230
DNL12E-42	CG52	4187587	CS232	4474918	CS363	4998353	CA771R
MOA12-10	CS122	4198226	CS141	4475266	CA771R	5101645	CA771R
MOA12-13	CS150	4198227	CS141	4475268	CA771R	5111319	CS795
MOA12-8	CS150	4198600	CS91	4475303	CA120	5895028	CA8901R
MOB12-1	CS127	4198601	CS91	4478678	CA1291R	5895033	CA11531R
MOB12-2	CS127	4220995	CS397	4699704	CS232	5920974	CA1291R
MOC12-13	CS143	4222697	CA131	4701920	CS232	5933930	CS286
MOC12-2	CS129	4224325	CA45	4702248	CS240	5943452	CA1291R
MOC12-4	CS93	4229113	CS90	4706008	CS394	5947366	CA3071R
MOC12-9	CS261	4229114	CS90	4711700	CA2551R	5947376	CA3071R
MOC12X-5	CS165	4231016	CS232	4715786	CA2121R	5955501	CA1271R
MOK12-1	CS123	4231018	CS232	4716026	CS394	5955503	CA2541R
MOS12-10	CS156	4232191	CS232	4716062	CS394	5955504	CA2541R
MTA12-13	CS397	4257063	CA45	4717871	CA2121R	5955557	CA5061R
MTA12-14	CS95	4257074	CA45	4719664	CS230	5958394	CA2521R
MTA12-19	CS95	4257771	CA45	4721587	CA2551R	5958395	CA2521R
MTA12-19M	CS95	4269114	CS232	4721589	CA3161R	5958565	CA5061R
MTA12-3	CS397	4274815	CA45	4721591	CA3161R	5959702	CS275
MTA12-30	CS126	4275283	CA45	4721592	CA3161R	5960289	CA5061R
MTA12-37	CS95	4275285	CA45	4721890	CA2121R	5960292	CA1291R
MTA12-39	CS90	4275286	CA45	4722724	CA2121R	5962647	CA1291R
MTA12-39M	CS90	4287971	CS308	4728682	CS572	5967595	CA2521R
MTA12-40	CS166	4287972	CS308	4731839	CA3161R	5967596	CA2521R
MTA12-41	CS397	4288328	CS308	4732241	CS564	5967965	CA1271R
MTA12-43	CS95	4325179	CA45	4732242	CS526	5968605	CS285
MTA12-8	CS93	4329019	CA120	4735444	CS232	5972197	CA1291R
MTA12P-15	CS95	4376714	CA2331R	4737754	CS232	5972684	CS90
MTA12P-19	CS95	4382200	CA1191R	4737756	CS394	5973034	CA3071R
MTA12P-30	CS94	4383593	CA461R	4738563	CA2121R	5973035	CA3071R
MTA12P-7	CS94	4384014	CA461R	4738569	CA2121R	5976915	CA1291R
MTC252-7	CS695	4386883	CA1191R	4738570	CA2121R	5984563	CS376
MTC25-27	CS700	4392459	CS133	4738571	CA2121R	5985182	CS504
MTD12-14	CS139	4392461	CS286	4738772	CA2121R	5985265	CS351
MTD12-18	CS385	4392831	CA1191R	4738775	CA2121R	5990470	CS147
MTS12-1	CS141	4395131	CA2521R	4741669	CS289	5991832	CS393
MTS12-10	CS95			4741699	CS289	5992153	CA5061R
MTS12-21	CS141						

O.E. NO.	HC-PARTS	O.E. NO.	HC-PARTS	O.E. NO.	HC-PARTS	O.E. NO.	HC-PARTS
<b>FIAT <i>Continued</i></b>							
5992155	CA5061R	7713061	CA7001R	46231671	CA12161R	46430721	CS1037
5996771	CS286	7713140	CA8511R	46231680	CA771R	46430784	CS1045
5997309	CS374	7713141	CA8511R	46231682	CA2541R	46431502	CS1043
5999868	CA3501R	7716196	CS709	46231684	CA2521R	46431710	CA5061R
5999869	CA3501R	7716197	CS584	46231687	CA2521R	46431712	CA6441R
5999906	CS371	7716198	CS364	46231689	CA2541R	46432262	CS1125
6081165	CA10551R	7716766	CS1059	46231691	CA5961R	46432301	CS1038
6706931	CS231	7716767	CS709	46231692	CA13491R	46432411	CA11961R
7501995	CS396	7717875	CA5041R	46231696	CA13501R	46434037	CS800
7533231	CS692	7719428	CA8221R	46231698	CA11961R	46434931	CA13481R
7533853	CA2521R	7719541	CS711	46231705	CA12201R	46436507	CA11541R
7541401	CA5061R	7726946	CS554	46231721	CA5961R	46437412	CA13491R
7541569	CS514	7727484	CS514	46231722	CA11901R	46437413	CA13501R
7541775	CA9091R	7727487	CS351	46231723	CA1501R	46437520	CS1212
7541823	CA2521R	7727534	CS615	46231724	CA12161R	46439036	CA14511R
7546342	CA3071R	7733966	CS285	46231725	CA1191R	46439700	CS1037
7546343	CA3071R	7735162	CS963	46231740	CA5061R	46442777	CA11991R
7546639	CA5041R	7737262	CS1038	46231750	CA3511R	46445094	CA5061R
7547660	CA3511R	7740560	CS232	46231751	CA1291R	46445096	CA5061R
7547791	CA2541R	7762899	CA12331R	46231755	CA1291R	46445100	CA5961R
7552284	CA14351R	7765558	CA2521R	46231760	CA14351R	46445103	CA6011R
7552382	CA6011R	7769840	CA11991R	46231761	CA3511R	46445658	CA12231R
7552459	CA1271R	7770210	CS1037	46231762	CA6011R	46445660	CA11891R
7554832	CA5061R	7772459	CS796	46231786	CA3161R	46446292	CA14351R
7554833	CA5061R	7772462	CS883	46231787	CA10391R	46448433	CA13131R
7555131	CS275	7773812	CS975	46305329	CA12231R	46448434	CA12161R
7564668	CS289	7774480	CA7121R	46401068	CS1052	46451529	CS1191
7565832	CA5721R	7774481	CA7121R	46404424	CA12181R	46451895	CS1124
7575565	CA5041R	7779820	CA11531R	46406469	CS584	46454211	CS1042
7575998	CA1291R	7779821	CA11541R	46406471	CS584	46463250	CS1124
7580192	CS374	7781075	CA12081R	46406472	CS584	46464276	CA10841R
7580206	CA1271R	7782187	CA14521R	46406938	CS1170	46465475	CS1125
7580207	CA2521R	7782314	CA12231R	46406973	CS1042	46468696	CS1053
7580575	CS510	7783714	CS1043	46406974	CS1195	46472225	CA8931R
7581975	CA9091R	7785449	CS796	46407644	CA8901R	46472226	CA14371R
7587118	CS286	7785949	CS800	46407646	CA11531R	46473784	CS1045
7588791	CA2541R	7796598	CS796	46407647	CA11541R	46475793	CS975
7588942	CS514	7796599	CS1076	46407648	CA11961R	46475794	CS1043
7589005	CS554	7799248	CS1076	46407649	CA20631R	46478945	CS1045
7589151	CS554	8122161	CS383	46412678	CA11601R	46516740	CA13501R
7589411	CS393	8823932	CS346	46412679	CA11901R	46518059	CS796
7589435	CS351	42498212	CS394	46412681	CA12161R	46521851	CA11991R
7589547	CS285	46208436	CS1109	46413021	CA12221R	46522234	CS1212
7589655	CS285	46231500	CS1038	46414610	CS992	46528046	CA8511R
7597118	CS286	46231503	CS308	46414831	CS585	46530060	CA8901R
7608589	CS376	46231504	CS90	46416343	CA11541R	46530261	CA16471R
7612952	CS371	46231505	CS90	46417006	CS975	46531437	CS1191
7621040	CS371	46231508	CS308	46419297	CA8901R	46532168	CA11991R
7626281	CS584	46231510	CS371	46419321	CA11961R	46532667	CA14851R
7629272	CA6011R	46231511	CS963	46419322	CA14531R	46532668	CA14711R
7631385	CA6441R	46231525	CS91	46419332	CS981	46532669	CA16481R
7634024	CA7271R	46231526	CS147	46419392	CS981	46540293	CA10841R
7634026	CA7001R	46231527	CS133	46420106	CS1195	46540294	CA11611R
7636428	CA8511R	46231528	CS133	46420960	CA8901R	46542889	CA17661R
7636431	CA8511R	46231529	CS133	46420961	CA11541R	46543023	CA17531R
7641975	CA7271R	46231530	CS396	46420962	CA12201R	46544329	CA15581R
7642261	CS709	46231535	CS285	46420963	CA12191R	46548654	CS1192
7646189	CA5061R	46231540	CS285	46420965	CA10841R	46554402	CA18441R
7651070	CA5961R	46231550	CS393	46420966	CA11991R	46554404	CA17421R
7651812	CA14351R	46231575	CS275	46423006	CA12341R	46554405	CA18301R
7658554	CS504	46231576	CS184	46425518	CA11991R	46554407	CS1037
7658555	CS351	46231592	CS514	46428729	CA11901R	46559015	CA11531R
7666135	CS510	46231600	CS364	46428730	CA12161R	46736968	CA20591R
7666528	CS285	46231601	CS374	46428731	CA11601R	46740242	CS1192
7668314	CS615	46231602	CS1059	46428733	CA12201R	46740243	CA11891R
7668988	CS1038	46231603	CS286	46428734	CA12211R	46748349	CS1213
7679933	CS1195	46231604	CS504	46429594	CS796	46748350	CS1213
7680619	CS709	46231605	CS286	46430110	CA12581R	46748351	CS1335
7689341	CA7001R	46231610	CS351	46430111	CA15651R	46748353	CA16981R
7692102	CS1037	46231640	CS289	46430112	CA13481R	46748357	CA17421R
7697864	CA5061R	46231642	CS510	46430524	CA11531R	46758240	CS1198
7697867	CA12341R	46231644	CS554	46430525	CA20631R	46758242	CA20601R
7699408	CA6441R	46231650	CA8931R	46430526	CA11581R	46758245	CA13501R
7701840	CA6011R	46231655	CA3071R	46430527	CA11601R	46758246	CA19981R
7702242	CA5961R	46231657	CA3501R	46430528	CA11591R	46763529	CS1192
7702245	CA5961R	46231658	CA8511R	46430529	CA12161R	46763530	CS1125
7702247	CA8341R	46231659	CA3501R	46430530	CA13111R	46763532	CA12161R
7704356	CA8931R	46231660	CA3501R	46430531	CA12161R	46763533	CA16971R
7711092	CA8931R	46231670	CA11601R	46430533	CA11891R	46763534	CA16971R

O.E. NO.	HC-PARTS	O.E. NO.	HC-PARTS	O.E. NO.	HC-PARTS	O.E. NO.	HC-PARTS
46765835	CA1208IR	51787196	CA2070IR *	71716607	CA1442IR	77347410	CA851IR
46765836	CA1223IR	51787208	CA1855IR	71716608	CA1496IR	77347411	CA350IR
46765837	CA1189IR	51787209	CA1862IR	71716609	CA1564IR	77367410	CA127IR
46765838	CA1558IR	51788658	CA1969IR	71716671	CA1509IR	77367411	CA252IR
46765839	CS1125	51793678	CA2050IR *	71718905	CA1564IR	77387430	CS133
46765842	CA1349IR	51805799	CA1855IR	71719595	CS1177	77398430	CS285
46769369	CA1223IR	51805800	CA1862IR	71719596	CS712	77412430	CS504
46774413	CA1199IR	51805803	CA1856IR	71719597	CS570	77418430	CS363
46774415	CS975	51812501	CS1379	71719598	CS373	77425430	CS376
46774416	CS1043	51832950	CS1379	71719599	CS373	77445430	CS232
46774417	CS800	51832952	CS1379	71719600	CS594	77452430	CS351
46774420	CA1160IR	51832954	CS1264	71719601	CS1177	77503410	CA506IR
46774430	CA1697IR	51832956	CS1213	71719602	CS373	77510410	CA119IR
46782213	CA1558IR	51832958	CS1449	71719603	CS373	77510411	CA119IR
46782218	CA1696IR	51832959	CS1053	71719604	CS1177	77510430	CS275
46782219	CA1743IR	51833880	CS1192	71719605	CS373	77515410	CA255IR
46791692	CS1053	51854901	CA2049IR *	71719606	CS342	77515411	CA316IR
46796553	CS1125	51854902	CA2050IR *	71719607	CS1244	77515430	CS289
46800152	CS1345	51854905	CA1856IR	71719608	CS594	77550430	CS396
46800154	CS800	51854909	CA1855IR	71719609	CS594	77603430	CS285
46800158	CA1843IR	51854910	CA1862IR	71719943	CA1509IR	77612410	CA150IR
46800159	CS1335	51854915	CA1862IR	71719944	CA1646IR	77671430	CS351
46809068	CA1698IR	51859037	CA1766IR	71721156	CA1154IR	77679430	CS554
46813058	CS1379	51859038	CA1742IR	71721512	CA1698IR	77716430	CS184
46813059	CA1647IR ▲	51859041	CA2070IR *	71722353	CS1326	82301308	CS184
46813061	CA1471IR	51859042	CA1886IR	71728811	CS594	82374412	CS184
46813062	CA1743IR	51859043	CA2094IR *	71732307	CA1761IR	88205005	CS572
46813064	CS1379	51859044	CA2096IR *	71733552	CA1761IR	88206020	CA212IR
46816029	CA1844IR	51859053	CA1558IR	71739718	CS519	95681447	CS1421
46816031	CA1153IR ▲	51859058	CA2048IR	71739864	CS1257	98490185	CA1039IR
46816033	CA2061IR *	51880229	CS1346	71746669	CS1335	98490186	CA1157IR
46816793	CS1379	51890631	CS1379	71746673	CA1995IR	130019808	CS973
46816971	CS1345	55185076	CA1862IR	71782363	CS594	468235460	CA1856IR
46816973	CS1379	55192482	CS1264	71786195	CA1879IR	500345767	CA2037IR
46821681	CS1213	55193355	CS1379	71789529	CS1389	500345767	CA2037IR
46823540	CA2062IR *	55193356	CS1379	71792597	CS1264	500362607	CA1835IR
46823543	CS1264	55193407	CS1213	71794530	CS1264	500371244	CA1643IR
46823546	CA1856IR	55195029	CS1335	73501591	CA1995IR	504033459	CA1781IR
46823547	CA1862IR	55195030	CS1192	73503235	CA1885IR	504057813	CA1913IR
46823548	CS1346	55195211	CS1264	74878160	CA233IR	504280010	CA2090IR *
46830212	CS1212	55195967	CS1434	75019950	CS396	504280012	CA2089IR *
46832123	CA1648IR ▲	55196400	CS796	75891510	CS554	517723250	CS1379
46835093	CS1345	55201771	CS1125	76221040	CS371	551952110	CS1045
46835094	CS1345	55204116	CS1346	77025410	CA233IR	703009641	CA1856IR
46835095	CA1934IR	55204116	CS1346	77028550	CA255IR	130019808	CS973
46841963	CA1471IR	55352105	CS1291	77028560	CS230	1319121080	CS566
46841966	CA1648IR	55353237	CS1334	77050262	CS394	131955080	CS1109
46843091	CA1766IR	55353257	CS1334	77050550	CA212IR	1320921080	CS1177
46843092	CS1125	55561503	CS1334	77050562	CS394	1323248080	CA836IR ▲
46843093	CA1844IR	55779086	CS1449	77080561	CS231	1323249080	CA836IR
50012833	CA129IR	60512847	CS585	77110410	CA307IR	1329201080	CS1198
50232991	CS333	60512969	CS611	77110411	CA307IR	1331329080	CS1109
50500728	CA2016IR	60562020	CA1107IR ▲	77129430	CS397	1332419080	CS1177
51700670	CA1886IR ▲	60583572	CA1061IR	77138410	CA120	1342792080	CS594
51700675	CA1886IR	60585343	CS585	77145410	CA77IR	1347058080	CS1389
51709131	CA1742IR	60588395	CA1102IR	77145430	CS91	1349920080	CS1449
51709132	CA1998IR	60611990	CA1061IR	77161410	CA46IR	1473638080	CS885
51709133	CA1766IR	60620761	CS1042	77168430	CS147	1475489080	CS885
51709133	CA1766IR	60627810	CA1102IR	77175410	CA46IR	9603503580	CS1177
51714791	CA1742IR	60652354	CA1492IR	77175430	CS90	9603503680	CS712
51714792	CA1998IR	60812535	CA1223IR	77176410	CA46IR	9609313280	CS581
51714794	CA1766IR	60812814	CA1216IR	77201430	CS90	9610601580	CA825IR
51718499	CA1855IR	60812988	CA1313IR	77206430	CS141	9611366880	CA1086IR
51718502	CA2094IR *	60812989	CA1159IR	77211411	CA119IR	9612259680	CA637IR
51727333	CA2096IR *	60813210	CA1492IR	77218430	CS141	9613015980	CS566
51727338	CA2048IR	60813458	CS1124	77235410	CA351IR	9613230280	CS566
51734825	CA2016IR	60816045	CA1558IR	77235430	CS364	9616862980	CA825IR
51742335	CA1743IR	60816046	CA1223IR	77250410	CA77IR	9617842980	CA1043IR
51754152	CA1882IR	60816557	CA1558IR	77274850	CS585	9619310280	CS566
51754153	CA1833IR	60817002	CS1264	77276430	CS308	9619333080	CA825IR
51764265	CA2049IR *	60817038	CA1743IR	77276431	CS308	9621791480	CA1509IR
51772325	CS1379	61227993	CS710	77305410	CA350IR	9622410680	CA1646IR
51776205	CS1213	63604238	CA1492IR	77305430	CS371	9624291480	CS1177
51779086	CS1449	71716554	CS566	77320410	CA252IR	9625382580	CS566
51782321	CS1264	71716562	CS594	77323410	CA129IR	9625382680	CS594
51784845	CA1862IR	71716563	CS594	77323430	CS374	9625382780	CS1177
51784846	CA1934IR	71716564	CS1177	77337430	CS286	9629473280	CS715
51784847	CA1856IR	71716565	CS594	77340410	CA129IR	9631318680	CA825IR
51787165	CA2089IR *	71716600	CA638IR	77340411	CA129IR	9635659580	CS1326

O.E. NO.	HC-PARTS	O.E. NO.	HC-PARTS	O.E. NO.	HC-PARTS	O.E. NO.	HC-PARTS
<b>FIAT <i>Continued</i></b>							
9635659780	CS1326	1073049	CA1085IR	1209193	CS1426	1416234	CS960
9637185880	CA1392IR	1073093	CS613	1211891	CA1638IR	▲ 1420871	CA1919IR
9637813680	CS1260	1073108	CS977	1214371	CS1245	1425016	CA1968IR
9638275480	CA1589IR	1073771	CA1482IR	1215762	CA2093IR	*	1426014
9639396480	CA1674IR	1074633	CA1083IR	1215766	CA1475IR	1429688	CA1857IR
9639846780	CS1326	1076005	CA1260IR	1218885	CS1246	1429689	CA1857IR
9645865080	CA1388IR	1076141	CS961	1219711	CA1475IR	1436602	CA1737IR
9646065480	CA1761IR	1079312	CA1475IR	1221059	CA1475IR	1436603	CA1780IR
9646068880	CA1674IR	1085273	CS961	1229258	CA1865IR	1438288	CS72
9649611280	CA1879IR	1085875	CA1482IR	1229259	CA1834IR	1438561	CS86
9649611280	CA1879IR	1086299	CA1317IR	1229421	CA1857IR	1449615	CS1245
9649611380	CA1499IR	1087280	CS1058	1229424	CA1758IR	1450644	CA1758IR
9655249280	CA1086IR	1088304	CA1474IR	1229425	CS613	1450653	CS1245
9658144680	CA1928IR	1088649	CS1050	1229427	CS1341	1451865	CA1993IR
9658144780	CS1421	1090085	CA1340IR	1231963	CS1377	1458640	CA2000IR
9659918080	CA1928IR	1090424	CA1034IR	1233234	CS1341	1464564	CA1989IR
9661544880	CA1920IR	1092115	CS1050	1233277	CS1426	1464755	CA2034IR
		1092116	CS960	1237323	CS1050	1464756	CA1777IR
<b>FORD</b>		1092117	CS986	1250901	CS790	1464779	CA1638IR
0018882	CS960	1093245	CA1552IR	1251700	CS1403	1464782	CA1635IR
1001869	CA1217IR	1093471	CS977	1253624	CA1394IR	1464784	CA1857IR
1005308	CA305IR	1097304	CA1483IR	1253808	CS1408	1464785	CA1857IR
1005351	CA325IR	1097305	CA1340IR	1254222	CS1341	1464788	CA1777IR
1005370	CA1690IR	1098747	CA1474IR	1255711	CA1834IR	1465010	CS1246
1005391	CA1692IR	1100711	CA1446IR	1255712	CA1865IR	1465115	CS1377
1007765	CS974	1100712	CA1394IR	1256552	CA1864IR	1465173	CA1857IR
1008795	CS592	1104931	CA1316IR	1300504	CS1403	1469391	CA1923IR
1008836	CS592	1104965	CS1107	1301377	CA1475IR	1469712	CS1341
1008838	CS330	1104987	CA1034IR	1301496	CA1483IR	1469714	CA2044IR
1011330	CS960	1105310	CS977	1301511	CA1340IR	1469721	CS1377
1011331	CS1050	1107444	CA1083IR	1301530	CA1475IR	1473072	CS1050
1012257	CA1508IR	1107446	CA1217IR	1302007	CA1941IR	1476964	CS69
1012463	CA1076IR	1110413	CA1836IR	1303447	CA1777IR	1477482	CS1403
1015821	CA1217IR	1111210	CS1181	1305962	CA1925IR	1477737	CA1865IR
1015822	CA1137IR	1116389	CS1050	1306851	CA2093IR	*	1477738
1017500	CA1317IR	1117829	CA1772IR	1307487	CA1475IR	1477740	CA1999IR
1018818	CA1089IR	1118212	CS1390	1307578	CS1050	1477856	CA1777IR
1018872	CA1137IR	1118336	CS613	1309581	CS1289	1477859	CA1777IR
1018882	CS960	1120211	CA1638IR	1322573	CA1925IR	1477971	CA1857IR
1018883	CS1050	1120213	CA1635IR	1322879	CA1926IR	1477972	CA1857IR
1019077	CA1032IR	1120214	CS1246	1325943	CS1402	1477973	CS1336
1021198	CA854IR	1120215	CS1245	1342191	CA2093IR	*	1478119
1021397	CA1034IR	1122105	CA1649IR	1344589	CS1404	1478129	CS1402
1024508	CS977	1122238	CA1474IR	1345314	CS1336	1478187	CA1857IR
1024864	CA1034IR	1124015	CA1638IR	▲ 1350459	CS1275	1478228	CA1737IR
1025547	CA1145IR	1126051	CA1475IR	1351989	CS1377	1478281	CA1780IR
1027772	CS971	1126499	CA2093IR	*	CA1999IR	1478331	CS1107
1027928	CS977	1126987	CS613	1352858	CA1962IR	1478608	CA1638IR
1030151	CS986	1127350	CA1552IR	1353886	CA1962IR	1479818	CA2034IR
1031134	CA1034IR	1128296	CA1760IR	1361258	CA1340IR	1480550	CS1408
1031896	CA736IR	1131820	CA1638IR	▲ 1361259	CA1925IR	1483817	CS1275
1031898	CA1089IR	1133994	CS1396	1365666	CS790	1485512	CA259IR
1032139	CA1217IR	1135454	CA1145IR	1366473	CS1402	1485513	CA190IR
1032140	CA1137IR	1136152	CA1217IR	1366986	CS1403	1485514	CA190IR
1032333	CA1145IR	1140110	CS1245	1367529	CS961	1485762	CA1778IR
1032652	CA1034IR	1140111	CS1246	1368970	CS1341	1486810	CA1993IR
1032666	CS789	1140135	CA1777IR	1368974	CS1275	1496231	CA1989IR
1035755	CA1316IR	1140136	CA1778IR	1372737	CA1922IR	1502880	CS1275
1036244	CA1087IR	1140138	CA1737IR	1372739	CS1421	1504563	CA17H
1045390	CA1137IR	1140139	CA1780IR	1373810	CS1107	1506299	CA2091IR
1053656	CA1083IR	1140694	CA1635IR	1374049	CS1398	1506300	CA1970IR
1057652	CS1107	1140696	CA1638IR	1376305	CS1377	1507007	CA190IR
1057654	CS1058	1140757	CS1275	1376501	CA1970IR	1510642	CA98
1057661	CS961	1140760	CS1050	1379699	CA1923IR	1511220	CA1925IR
1057793	CA1034IR	1144182	CA1475IR	1379702	CS1403	1516027	CS69
1058429	CS613	1144185	CA2093IR	*	CS1430	1525794	CS1403
1058821	CA1085IR	1144505	CS1275	1385378	CS1421	1525795	CS1430
1059179	CS977	1145715	CA2034IR	1385784	CS1377	1529431	CS1377
1059564	CS974	1147432	CS1181	1386127	CS1426	1530298	CA1926IR
1061267	CS613	1149703	CS1289	1387062	CS1245	1530299	CA1864IR
1061458	CS1107	1151212	CA1638IR	1387091	CS1429	1535268	CS1050
1063999	CS1050	1151213	CA1635IR	1387092	CS1408	1535437	CA1742IR
1064000	CS1050	1151214	CA1475IR	1387927	CA1970IR	1537179	CA17H
1066407	CA1217IR	1151216	CS790	1388002	CA1923IR	1539686	CS1050
1067622	CS971	1151641	CS1245	1388569	CS961	1539703	CS78
1071383	CA1217IR	1151642	CS961	1404791	CA1928IR	1541002	CS1245
1071418	CA1137IR	1188206	CA1763IR	1404792	CA1922IR	1541451	CA1967IR
1072156	CS1062	1197912	CS1426	1416205	CS592	1542468	CS1379
1072455	CA1230IR	1205240	CS961	1416231	CS1050	1543764	CA1962IR

O.E. NO.	HC-PARTS	O.E. NO.	HC-PARTS	O.E. NO.	HC-PARTS	O.E. NO.	HC-PARTS
1545138	CA1777IR	5003624	CS69	7046493	CA1447IR	2S6T10300CC	CA1737IR
1551240	CS1245	5003639	CS86	7066376	CA1034IR	2S6T10300CD	CA1737IR
1552432	CS1245	5003897	CA17H	7081782	CA1071IR	2S6T10300DB	CA1780IR
1553520	CA94IR	5003898	CA96IR	7085852	CS330	2S6T10300DC	CA1780IR
1553523	CA96IR	5003902	CA96IR	7118750	CA1032IR	2S6T10300DD	CA1780IR
1553526	CA259IR	5003903	CA96IR	7177333	CS1107	2S6T10300DE	CA1780IR
1553627	CA190IR	5007077	CA226IR	7203201	CA736IR	2S6T10300FA	CA2034IR
1564725	CS1408	5008989	CA305IR	7203211	CS620	2S6T10300FB	CA2034IR
1564732	CS1289	5010556	CA18V	7239483	CS1065	2S6T10300FC	CA2034IR
1567033	CS1379	5010557	CA126IR	7275999	CA738IR	2S6T10300AA	CA1777IR
1568699	CS72	5021973	CA311IR	7276000	CA739IR	2S6U11000CA	CS1050
1569099	CA61IR	5024754	CA1046IR	7276001	CA1032IR	2S6U11000CB	CS1050
1570611	CS1404	5025160	CA563IR	7302659	CA1031IR	2S6U11000CC	CS1050
1571101	CA61IR	5026096	CA305IR	7302659	CA719IR	2S6U11000DA	CS1289
1571105	CS78	5026099	CA1692IR	7308194	CA731IR	2S6U11000DB	CS1289
1571389	CA96IR	5026102	CA1690IR	7308195	CA1034IR	2S6U11000DC	CS1289
1572736	CA1928IR	5026113	CA325IR	7312901	CA1085IR	2S6U11000EA	CS1275
1574338	CS1421	5026489	CS722	7355509	CA1037IR	2S6U11000EB	CS1275
1575034	CS1050	5026490	CS786	7361230	CA1142IR	2S6U11000EC	CS1275
1580265	CA1763IR	5026491	CS786	7361233	CA1143IR	2S6U11000ED	CS1275
1581843	CA1928IR	5026497	CS977	7387707	CA1324IR	2S6U11000EE	CS1275
1581844	CA1922IR	5026712	CS787	7387708	CA1149IR	2S7T11000AB	CS961
1592234	CA1780IR	5026713	CS787	7387709	CA1076IR	2S7T11000AC	CS961
1610118	CA305IR	5026721	CA1029IR	81866002	CS1126	2S7T11000AD	CS961
1633079	CA1931IR	5026721	CA611IR	82005342	CS1126	2S7T11000DA	CS1245
1638243	CS328	5026727	CA311IR	82013922	CS1126	2S7T11000DB	CS1245
1659058	CA560IR	5027117	CS329	1C1T10300AB	CA1636IR	2S7T11000DC	CS1245
1668894	CA719IR	5027131	CS592	1C1T10300AD	CA1636IR	2S7T11000AA	CS961
1669558	CS1421	5027805	CS685	1C1T10300AE	CA1636IR	2T1411000BA	CS1336
1670812	CS1275	5027810	CA1031IR	1C1T10300AF	CA1636IR	2T1411000BB	CS1336
1671515	CS1050	5027845	CA560IR	1M211000AA	CS789	2T1411000BC	CS1336
1671579	CS1408	5027848	CA1031IR	1M5T10300BA	CA1475IR	2T1411000CB	CS1336
1673521	CA1742IR	5027848	CA719IR	1M5T10300BB	CA1475IR	2T1411000CC	CS1336
1685794	CA2044IR	5029143	CS1058	1M5T10300BC	CA1475IR	2T1U10300AB	CA1857IR
1698214	CA2044IR	5029902	CA719IR	1M5T10300BD	CA1475IR	2T1U10300AC	CA1857IR
1709189	CS1421	5029923	CA717IR	1S4U11000AB	CS1396	2T1U10300AD	CA1857IR
1712779	CA1928IR	5030239	CS1065	1S4U11000AA	CS1396	2T1U10300AE	CA1857IR
1728770	CS1408	5030343	CA1085IR	1S7T10300BA	CA1638IR	2T1U10300AF	CA1857IR
1732742	CS1050	5030468	CA731IR	1S7T10300BB	CA1638IR	2T1U10300AG	CA1857IR
1734633	CS1275	5030656	CA1037IR	1S7T10300BC	CA1638IR	2T1U10300AH	CA1857IR
1747021	CA1928IR	5030668	CA311IR	1S7T10300BD	CA1638IR	2T1U10300AK	CA1857IR
3238665	US837	5128966	CA1857IR	1S7T10300BE	CA1638IR	2T1U10300AL	CA1857IR
3242283	US819	5128967	CA1857IR	1S7T10300CA	CA1635IR	2T1U10300AM	CA1857IR
3395460	JA1353IR	5190803	CA1778IR	1S7T10300CB	CA1635IR	2T1U10300BB	CA1857IR
3395461	JA806IR	5752791	US837	1S7T10300CC	CA1635IR	2T1U10300BC	CA1857IR
3465426	JA755IR	6021771	CA190IR	1S7T10300CD	CA1635IR	2T1U10300BD	CA1857IR
3601014	JA1530IR	6021775	CA96IR	1S7T10300CE	CA1635IR	2T1U10300BE	CA1857IR
3601369	JS1352	6029039	CS123	1S7T10300CF	CA1635IR	2T1U10300CA	CA1857IR
3852582	US1028	6033117	CA96IR	1S7T10300DA	CA1638IR	2T1U10300CB	CA1857IR
4022225	CS1107	6136946	CA305IR	1S7T10300DB	CA1638IR	▲ 2T1U10300CC	CA1857IR
4022225	CS790	6157876	CS329	1S7T10300DC	CA1638IR	▲ 2T1U10300CD	CA1857IR
4033064	CS1336	6157877	CS330	1S7T10300DD	CA1638IR	▲ 2T1U10300CE	CA1857IR
4069776	CA1639IR	6159682	CA306IR	1S7T10300DE	CA1638IR	2T1U10300CF	CA1857IR
4078768	CS1245	6160440	CS337	1S7T10300DF	CA1638IR	2T1U10300CG	CA1857IR
4098414	CA1639IR	6164752	CS562	1S7U11000AB	CS1246	3M2110300BA	CA1394IR
4112235	CA1636IR	6170284	CS181	1S7U11000AC	CS1246	3M2110300AA	CA1446IR
4332279	CA1639IR	6173461	CA312IR	1S7U11000AD	CS1246	3M5T10300KA	CA1962IR
4344538	JA1530IR	6199412	CA739IR	1S7U11000AE	CS1246	3M5T10300KB	CA1962IR
4348654	JS1352	6199415	CS724	1S7U11000AF	CS1246	3M5T10300KC	CA1962IR
4362258	CA1779IR	6504726	CS330	1S7U11000AG	CS1246	3M5T10300LA	CA1926IR
4371000	CA1857IR	6565322	CS786	1S7U11000BA	CS1245	3M5T10300LB	CA1926IR
4371001	CA1857IR	6565323	CS787	1S7U11000BB	CS1245	3M5T10300LC	CA1926IR
4374447	CA1857IR	6593477	CA1030IR	1S7U11000BC	CS1245	3M5T10300LD	CA1926IR
4374448	CA1857IR	6593477	CA718IR	1S7U11000AA	CS1246	3M5T10300NB	CA1931IR
4392207	CA1636IR	6647475	CA739IR	1X4U11000AA	CS961	3M5T10300NC	CA1931IR
4394204	CA1857IR	6694981	CA717IR	2C1T10300AB	CA1636IR	3M5T10300PB	CA1865IR
4424968	CS1336	6729337	CA1034IR	2C1T10300BA	CA1779IR	3M5T10300PC	CA1865IR
4443760	CS1336	6775699	CS719	2C1T10300BB	CA1779IR	3M5T10300PD	CA1865IR
4461712	CA1779IR	6775703	CS1107	2C1T10300AA	CA1636IR	3M5T10300QE	CA1966IR
4509615	CS1245	6775704	CS1058	2C3U10300BB	CA1639IR	3M5T10300SD	CA1966IR
4520765	CS1245	6816674	CS592	2M5T10300AB	CA1475IR	3M5T10300VB	CA1864IR
4529404	CS1245	6816676	CS685	2M5T10300AC	CA1475IR	3M5T10300VC	CA1864IR
4531025	CA1857IR	6816678	CS724	2M5T10300AD	CA1475IR	3M5T10300VD	CA1864IR
4531026	CA1857IR	6917885	CA731IR	2S6T10300AB	CA1777IR	3M5T10300YB	CA1834IR
4587107	CS1403	6994100	CS562	2S6T10300AC	CA1777IR	3M5T10300YC	CA1834IR
4635595	CS1403	7003146	CS341	2S6T10300BA	CA1778IR	3M5T10300YD	CA1834IR
4727857	CS1403	7012883	CS1066	2S6T10300BB	CA1778IR	3M5T11000AB	CS1403
4742541	CS1245	7041784	CS961	2S6T10300BC	CA1778IR	3M5T11000AC	CS1403
5003623	CS72	7046492	CA1447IR	2S6T10300CB	CA1737IR	3M5T11000AD	CS1403

O.E. NO.	HC-PARTS	O.E. NO.	HC-PARTS	O.E. NO.	HC-PARTS	O.E. NO.	HC-PARTS
<b>FORD Continued</b>							
3M5T11000AE.....	CS1403	6G9N11000BB.....	CS1429	79AB11000AB.....	CS181	864F10300FE.....	CA1028IR
3M5T11000CB.....	CS1341	6G9N11000EB.....	CS1408	79AB11000BB.....	CS78	864F10300FE.....	CA3111IR
3M5T11000CC.....	CS1341	6G9N11000EC.....	CS1408	79AB11000BC.....	CS78	864F10K359FC.....	CA1028IR
3M5T11000CD.....	CS1341	6G9N11000FA.....	CS1377	79AB11000BO.....	CS78	864F10K359FC.....	CA3111IR
3M5T11000CE.....	CS1341	6G9N11000GC.....	CS1377	79FB11000AB.....	CS122	864F10K359FD.....	CA1028IR
3M5T11000CF.....	CS1341	6G9N11000JA.....	CS1430	79FB11000AC.....	CS123	864F10K359FD.....	CA3111IR
3M5T11000DB.....	CS1377	6G9N11000JB.....	CS1430	79FB11000AA.....	CS122	864F10K359FE.....	CA1028IR
3M5T11000DC.....	CS1377	6G9N11000KB.....	CS1271	7G9N10300CA.....	CA2044IR	864F10K359FE.....	CA3111IR
3M5T11000EA.....	CS1398	6G9N11000AA.....	CS1403	7G9N10300CC.....	CA2044IR	864FX10K359FE.....	CA3111IR
3N1110300AB.....	CA1925IR	6L8T11000AA.....	CS961	7G9N10300EA.....	CA2000IR	86AB10300AB.....	CA1227IR
3N1110300AC.....	CA1925IR	6M2110346CA.....	CA1763IR	7G9N11000AB.....	CS1050	86AB10300ABA.....	CA961R
3N1110300AD.....	CA1925IR	6M3410300AB.....	JA1530IR	7G9N11000AC.....	CS1050	86AB10300ACA.....	CA961R
3N1110300AE.....	CA1925IR	6M5T10300SA.....	CA1967IR	7H1211002AB.....	CS1421	86AB10300DA.....	CA17V
3N1110300AF.....	CA1925IR	6S4T11000AA.....	CS1403	80BB10300DB.....	CA1901R	86AB10300DB.....	CA3051R
3S5T110300AB.....	CA1758IR	70GB11000BA.....	CS72	80BB10300EA.....	CA601R	86AB10300EB.....	CA1227IR
3S5T10300AA.....	CA1758IR	715F11000MA.....	CS337	81AB10300ABA.....	CA1261R	86AB10300NA.....	CA3251R
3S6T10300AB.....	CA1777IR	71AB11001BA.....	CS18	81AB10300BA.....	CA961R	86AB10300NB.....	CA1554IR
3S6T10300AC.....	CA1777IR	71BB10300EA.....	CA2591R	81AB10300CA.....	CA961R	86AB10300NB.....	CA3251R
3S6T10300AD.....	CA1777IR	71BB10300EB.....	CA941R	81AB10300YA.....	CA611R	86AB10300AA.....	CA3051R
3S6T10300AA.....	CA1777IR	71BB10300FA.....	CA1901R	81AB10300AAA.....	CA611R	86AB10300AAA.....	CA5601R
3S7T11000AB.....	CS1426	71BB10300FB.....	CA1901R	81AB11000AB.....	CS123	86AB11000BA.....	CS123
3S7T11000AC.....	CS1426	71BB11000BA.....	CS86	81AB11000BA.....	CS278	86AB11000DA.....	CS278
3S7T11000AD.....	CS1426	71BB11000DA.....	CS78	81AB11000BO.....	CS78	86AB11000FA.....	CS592
3S7T11000AA.....	CS1426	71BB11000E2A.....	CS181	81AB11000CA.....	CS278	86AB11000HA.....	CS123
4M5T10300KB.....	CA1941IR	71BB11000E2B.....	CS181	81AB11000DB.....	CS123	86AB11000JA.....	CS592
4M5T10300LB.....	CA1989IR	71BB11000LB.....	CS69	81AB11000EA.....	CS123	86AB11000KA.....	CS278
4M5T10300LC.....	CA1989IR	71BB11000AA.....	CS72	81AB11000EB.....	CS123	86AB11000RA.....	CS592
4M5T10300UB.....	CA1999IR	71BT10346EA.....	CA941R	81AB11000FA.....	CS123	86AB11000SA.....	CS592
4M5T10300UC.....	CA1999IR	71EB11000BA.....	CS72	81AB11000FB.....	CS123	86AB11000TA.....	CS592
4M5T11000AB.....	CS1402	71EB11000CA.....	CS69	81AB11000GB.....	CS123	86AB11000VA.....	CS592
4M5T11000AC.....	CS1402	71YB11000AA.....	CS200	81AB11000AA.....	CS123	86AX10300AB.....	CA3051R
4M5T11000CA.....	CS1404	71ZB11001AB.....	CS21	81BB10300CA.....	CA2261R	86AX10300ADA.....	CA3061R
4M5T11000CB.....	CS1404	72GB10300LA.....	CA1901R	81BB10300EA.....	CA941R	86AX10300DB.....	CA1227IR
4M5T11000FA.....	CS1377	72GB10300LB.....	CA1901R	81BB11000AA.....	CS685	86AX10300DB.....	CA3051R
4M5T11000FB.....	CS1377	72GB10300MA.....	CA941R	82BB10300GA.....	CA3061R	86BB10300MB.....	CA3251R
4M5T11000FC.....	CS1377	72GB10300MB.....	CA941R	82DB11000EA.....	CS697	86BB10300DB.....	CA17V
4M5T11000FD.....	CS1377	72GB10300NA.....	CA961R	82DB11000FA.....	CS349	86BB11000NA.....	CS708
4M5T11000KB.....	CS1408	72GB10300RA.....	CA961R	82FB10300BB.....	CA3051R	86BB11000SA.....	CS562
4M5T11000KC.....	CS1408	73AB11000AA.....	CS78	82FB10300EA.....	CA3051R	86FB10300AA.....	CA3061R
4M5T11000KD.....	CS1408	73BB11000B2A.....	CS181	82GB11000BA.....	CS181	86GB11000EA.....	CS78
4M5T11000KE.....	CS1408	73GB11000BA.....	CS78	82GB11000CA.....	CS78	86GB11000GA.....	CS329
4M5T11000AA.....	CS1402	74DB10436A.....	CA17H	82GB11000EA.....	CS69	86GB11000JB.....	CS328
4S4T11000AA.....	CS1403	74EB10300HB.....	CA961R	835F11000AC.....	CS337	86GB11000AA.....	CS78
4S5T10300AB.....	CA1993IR	755F11000BB.....	CS337	835F11000BB.....	CS337	86VB10300AA.....	CA6001R
4S5T10300AA.....	CA1993IR	75AB10300LA.....	CA611R	835F11000AA.....	CS337	870G10300AA.....	CA3061R
4S6911000AA.....	CS1289	75AB10300MA.....	CA601R	835FX11000BB.....	CS337	873F10300AA.....	CA5641R
4X4U11000AB.....	CS961	75AB10300NA.....	CA611R	83BB10300HA.....	CA3051R	873F10300AA.....	CA1261R
4X4U11000AA.....	CS961	75AB11000A2A.....	CS78	83BB11000AB.....	CS78	87BB10300BA.....	CA3051R
5L8T11000AC.....	CS961	75AB11000A2B.....	CS78	83BB11000BA.....	CS181	87BB11000CA.....	CS562
5S4T11000AA.....	CS1403	75AB11000B2A.....	CS78	83BB11000BB.....	CS181	87BB11000DA.....	CS609
69BB11000OB.....	CS721	75EB10300EA.....	CA961R	83BB11000DA.....	CS181	87BB11000EB.....	CS562
69EB10002CA.....	CG50	76AB11000AA.....	CS78	83BB11000EA.....	CS181	87BB11000EC.....	CS562
69EB10300DB.....	CA2591R	76BB10300ED.....	CA17H	83BB11000EB.....	CS181	87BB11000FA.....	CS609
69EB10346AD.....	CA15H	76BB10300GA.....	CA611R	83BB11000FA.....	CS78	87BB11000GA.....	CS562
69EB11000DA.....	CS69	76BB10300HA.....	CA601R	83BB11000FB.....	CS78	87BB11000JB.....	CS330
6C1T10300BA.....	CA1928IR	76BB10300JA.....	CA961R	83FB11000AA.....	CS123	87BB11000AA.....	CS708
6C1T10300BB.....	CA1928IR	76BB10300KA.....	CA941R	84AB10300MA.....	CA3061R	87GB11000BA.....	CS78
6C1T10300BC.....	CA1928IR	76BB11000AD.....	CS86	84AB10300MB.....	CA3061R	87GB11000CA.....	CS329
6C1T10300BD.....	CA1928IR	76BB11000AA.....	CS86	84AB10300AA.....	CA3061R	87GB11000CB.....	CS329
6C1T10300CA.....	CA1922IR	76EB11000AA.....	CS72	84AU11001B.....	CS323	87GB11000AA.....	CS708
6C1T10300CB.....	CA1922IR	77BB11000AA.....	CS69	84AU11001D.....	CS323	87GX11000AA.....	CS181
6C1T10300CC.....	CA1922IR	77FB10300FA.....	CA15H	84BU10300AB.....	CA2931R	87VB11000BA.....	CS785
6C1T10300CD.....	CA1922IR	77FB10300FB.....	CA15H	84BX10300AB.....	CA2931R	87VB11000AA.....	CS181
6C1T11000AB.....	CS1421	77FB10300GA.....	CA611R	84FB10300NA.....	CA611R	884F10K359AB.....	CA6111R
6C1T11000AC.....	CS1421	77FB10300GB.....	CA611R	84FB10300AA.....	CA3061R	886B11000AA.....	CS343
6C1T11000AD.....	CS1421	77FB10300GC.....	CA611R	85AB11000BA.....	CS592	88BB10300HA.....	CA5941R
6C1T11000AE.....	CS1421	77FB10300GD.....	CA611R	85BB10300DA.....	CA3051R	88BB10300HB.....	CA5941R
6C1T11000AF.....	CS1421	77FB10300KA.....	CA1261R	85BB11000AB.....	CS359	88BB11000BA.....	CS625
6G9N10300ABA.....	CA1923IR	77FB11000BA.....	CS123	85BB11000AA.....	CS359	88BX10300GB.....	CA5941R
6G9N10300ABB.....	CA1923IR	77FB11000CA.....	CS122	85FB10300BA.....	CA961R	88GB11000AA.....	CS343
6G9N10300ABC.....	CA1923IR	77FB11000EA.....	CS122	85GB11000BA.....	CS330	894F10300BA.....	CA6111R
6G9N10300HD.....	CA1968IR	78AB11000CA.....	CS78	85GB11000CA.....	CS714	894FX10300BA.....	CA6111R
6G9N10300JB.....	CA20011R	78FB10300BA.....	CA1261R	85GB11000DA.....	CS1110	894X10300AE.....	CA7191R
6G9N10300JD.....	CA20011R	78FB10300BB.....	CA1261R	85GB11000EA.....	CS86	894X10300BA.....	CA1029IR
6G9N10300UD.....	CA1919IR	78FB10300BC.....	CA1261R	85GB11000FA.....	CS181	894X10300BA.....	CA6111R
6G9N10300XA.....	CA1970IR	78GB10300HA.....	CA601R	85GX10300GA.....	CA2991R	89AB10300GA.....	CA961R
6G9N10300XB.....	CA1970IR	78GB10300JA.....	CA941R	85GX11000DA.....	CS1110	89AB11000BA.....	CS341
6G9N10300XC.....	CA1970IR	78VB11000DA.....	CS324	864F10300EA.....	CA3061R	89AB11000AA.....	CS341
6G9N11000AB.....	CS1403	795F11000CA.....	CS337	864F10300FD.....	CA1028IR	89AX10300EA.....	CA1690IR



O.E. NO.	HC-PARTS	O.E. NO.	HC-PARTS	O.E. NO.	HC-PARTS	O.E. NO.	HC-PARTS
89BB10300HA	CA562IR	91BB11000MA	CS722	94GB10K359AC	CA719IR ▲	96FB11000MB	CS971
89BB10300HB	CA562IR	91BB11000AA	CS562	94VB10300AB	CA1447IR	96FB11000MC	CS971
89BB10300JB	CA562IR	91BX11000FA	CS562	94VB10300BA	CA1447IR	96FB11000MD	CS971
89BB10300MB	CA1692IR	91BX11000JA	CS329	94VB10300BB	CA1447IR	96FB11000ME	CS971
89BB10300AA	CA1686IR ▲	91BX11000KA	CS625	94VB10300AA	CA1447IR	96FF10300DB	CA1217IR
89BB11000AB	CS541	91BX11000LA	CS541	954F10300AA	CA719IR	96FF10300DC	CA1217IR
89BB11000CA	CS722	91BX11000MA	CS722	954F10K300AB	CA1031IR	96MF10300DB	CA1137IR
89BB11000DA	CS721	91BX11000NB	CS721	954F10K300AA	CA719IR ▲	96MF10300DC	CA1137IR
89BB11000DB	CS721	91FF10300JA	CA856IR	954F10K359AB	CA1031IR	97AB10300AB	CA1217IR
89BB11000DC	CS721	91FF10300JB	CA856IR	954F10K359AB	CA719IR	97AB10300AC	CA1217IR
89BX10300HB	CA562IR	91FF10300TA	CA717IR	954F10300DB	CA1037IR	97AB10300AD	CA1217IR
89BX10300KC	CA563IR	91FF10300VA	CA717IR ▲	95AB10300DC	CA1037IR	97AB10300AD	CA1217IR
89BX10300LB	CA1692IR	91FX10300VA	CA717IR ▲	95FB10300AA	CA1508IR	97AB10300AE	CA1217IR
89BX10300NC	CA563IR	91GB11000AB	CS328	95FB11000BB	CS971	97AB10300AA	CA1217IR
89FB11000CA	CS592	91GX11000AB	CS328	95FB11000BC	CS971	97BB11000BA	CA1034IR
89FB11000AA	CS592	91VB10300AB	CA1447IR	95FB11000BD	CS971	97BB10300BB	CA1034IR
89FF10300AB	CA561IR	924F10300AB	CA1031IR	95FB11000BD	CS971	97BB10300BC	CA1034IR
89FF10300AC	CA561IR	924F10300AB	CA719IR	95FB11000BG	CS971	97BB10300BD	CA1034IR
89FF10300CC	CA584IR	924F10300AA	CA719IR	95FF10300AB	CA1083IR	97BB11000B3D	CS1396
89FF10300CD	CA584IR	924F10K359AB	CA1031IR	95FF10300AC	CA1083IR	97BB11000B3D	CS613
89FF10300CE	CA584IR	924F10K359AB	CA719IR	95FF10300AD	CA1083IR	97BB11000BB	CS613
89FF10300EB	CA717IR	924FX10K359AA	CA719IR	95FF10300AA	CA1083IR	97BB11000BC	CS613
89FF10300EC	CA717IR ▲	924X10300AB	CA1031IR	95GB10300DA	CA1071IR	97BB11000BD	CS613
89FF10300JA	CA717IR	924X10300AB	CA1031IR	95GB10300EB	CA1071IR	97KB10300AB	CA1145IR
89FF10300JB	CA717IR	924X10300AC	CA719IR	95GB10300KA	CA1071IR	97KB10300AA	CA1145IR
89FF10300JC	CA717IR	92AB10300DC	CA738IR	95GB10300LA	CA1085IR	97KB11000AB	CS986
89FX10300CD	CA584IR	92AB10300DD	CA738IR	95GB10300LB	CA1085IR	97KB11000AC	CS986
89FX10300EB	CA717IR	92AB10300FA	CA738IR	95GB10300MA	CA1085IR	97MF10300AB	CA1137IR
89FX10300JA	CA717IR	92AB10300FB	CA738IR	95GB10300MB	CA1085IR	97MF10300AA	CA1137IR
89VB11000AA	CS972	92AB10300GC	CA739IR	95GB11000CA	CS562	97VB11000AB	CS977
89VX11000AA	CS324	92AB10300JA	CA739IR	95GB11000DA	CS1066	97VB11000AA	CS977
8M5T10300YA	CA1834IR	92AB10300JB	CA739IR	95GB11000EA	CS330	97VW10300EA	CA1260IR
8V2110300AB	CA2091IR *	92AB11000CA	CS592	95GB11000FA	CS562	97VW11000BA	CS789
8V2110300BB	CA1970IR	92AB11000FA	CS685	95GX11000EA	CS330	97VW11000AA	CS974
8V2111000AC	CS1275	92AB11000FB	CS685	95VB10300BB	CA1230IR	98AB10300DC	CA1483IR
8V2111000AD	CS1275	92AB11000GA	CS724	95VB10300BC	CA1230IR	98AB10300DD	CA1483IR
8V2111000AE	CS1275	92AB11000GB	CS724	95VW10300AB	CA1324IR	98AB10300DE	CA1483IR
8V2111000BB	CS1050	92AB11000HA	CS341	95VW10300ABA	CA1089IR	98AB10300DF	CA1483IR
8V2111000BC	CS1050	92AB11000HB	CS341	95VW10300AC	CA1324IR	98AB10300DG	CA1483IR
8V2111000BD	CS1050	92AB11000JA	CS724	95VW10300BAA	CA827IR ▲	98AB10300DH	CA1483IR
8V2111000BE	CS1050	92AB11000KA	CS592	95VW10300CA	CA1149IR	98AB10300DJ	CA1483IR
90OX11000BA	CS609	92AB11000AA	CS724	95VW10300CC	CA1076IR	98AB10300DC	CA1340IR
914F10300AA	CA1030IR	92AX11000HB	CS341	95VW10300EB	CA1076IR	98AB10300GD	CA1340IR
914F10300AA	CA718IR	92AX11000JA	CS592	95VW10300EC	CA1076IR	98AB10300GE	CA1340IR
914F10K359AA	CA718IR	92BB11000AA	CS562	95VW10300FA	CA827IR ▲	98AB10300GF	CA1340IR
91AB10300SA	CA738IR	92FB10300FB	CA738IR	95VW10300KA	CA1142IR	98AB10300GG	CA1340IR
91AB11000AB	CS685	92JA10300AA	JA1416IR	95VW10300KB	CA1142IR	98AB10300GH	CA1340IR
91AB11000BA	CS592	92VB10300AB	CA1046IR	95VW10300NA	CA736IR	98AB10300GJ	CA1340IR
91AB11000BJ	CS592	92VB10300BB	CA1046IR	95VW10300PA	CA1341IR	98AB10300GK	CA1340IR
91AB11000CA	CS592	92VB11000AB	CS972	95VW10300RA	CA736IR	98AB10300GL	CA1340IR
91AB11000CB	CS592	92VB11000BA	CS785	95VW10300SA	CA1143IR	98AB10300GM	CA1340IR
91AB11000DA	CS592	92VB11000AA	CS972	95VW10300AA	CA1324IR	98AB10300JA	CA1475IR
91AB11000EA	CS592	93BB10300AE	CA731IR	95VW10300AAA	CA736IR	98AB10300JB	CA1475IR
91AB11000EB	CS341	93BB10300AG	CA731IR	95VW11000BC	CS1062	98AB10300JC	CA1475IR
91AB11000FB	CS341	93BB10300CE	CA731IR	95VW11000CB	CS974	98AB10300JD	CA1475IR
91AB11000GA	CS341	93BB10300FC	CA1034IR	95VW11000DA	CS620	98AB10300JE	CA1475IR
91AB11000HA	CS613	93BB10300FD	CA1034IR	95VW11000EB	CS789	98AB10300JF	CA1475IR
91AB11000HB	CS613	93BB10300FE	CA1034IR	95VW11000EC	CS789	98AB10300JG	CA1475IR
91AB11000IA	CS592	93BB10300FF	CA1034IR	95VW11000GA	CS789	98AB11000AC	CS613
91AB11000JA	CS592	93BB10300FG	CA1034IR	96BB10300BA	CA1316IR	98AB11000AD	CS1396
91AB11000JB	CS592	93BB11000AB	CS719	96BB10300BB	CA1316IR	98AB11000AD	CS613
91AB11000KA	CS592	93BB11000BB	CS1070	96BB10300BE	CA1316IR	98AB11000AD1	CS613
91AB11000KB	CS592	93BB11000CA	CS790	96BB11000A4B	CS1107	98AB11000BB	CS1050
91AB11000LA	CS592	93BB11000CB	CS790	96BB11000AB	CS1107	98AB11000BC	CS1050
91AB11000PA	CS341	93BB11000DB	CS790	96BB11000AC	CS1107	98AB11000BD	CS1050
91AX10300TA	CA1691IR	93BB11000HB	CS1107	96BB11000AA	CS1107	98AB11000CB	CS1050
91AX11000HA	CS613	93BB11000HC	CS1107	96BB10300AB	CA1552IR	98AB11000CC	CS1050
91AX11000HB	CS613	93BB11000JB	CS1058	96FB10300DC	CA1087IR	98AB11000CD	CS1050
91AX11000JA	CS592	93BB11000JC	CS1058	96FB10300DD	CA1087IR	98BB10300BC	CA1482IR
91AX11000JB	CS592	93BB11000KA	CS961	96FB10300DE	CA1087IR	98BB10300BD	CA1482IR
91AX11000KB	CS592	93BB11000KB	CS961	96FB10300EA	CA1552IR	98BB10300BE	CA1482IR
91BB11000BA	CS708	93BB11000KC	CS961	96FB11000CC	CS960	98MF10300CA	CA1474IR
91BB11000DA	CS562	93BB11000KD	CS961	96FB11000CB	CS1050	98MF10300CB	CA1474IR
91BB11000FA	CS562	93BB11000AA	CS719	96FB11000KC	CS1050	98MF10300CC	CA1474IR
91BB11000HA	CS330	94AB10300BA	CA1032IR	96FB11000KB	CS1050	98VB10K359BA	CA1317IR
91BB11000HB	CS330	94FB10300AB	CA1032IR	96FB11000LD	CS960	98VB10K359BB	CA1317IR
91BB11000JA	CS329	94GB10300BB	CA1031IR ▲	96FB11000LC	CS960	98VB10K359BC	CA1317IR
91BB11000KA	CS625	94GB10300BB	CA719IR ▲	96FB11000LD	CS960	98VB11000AB	CS977
91BB11000LA	CS541	94GB10K359AC	CA1031IR ▲	96FB11000MA	CS971	98VB11000B1A	CS977

O.E. NO.	HC-PARTS	O.E. NO.	HC-PARTS	O.E. NO.	HC-PARTS	O.E. NO.	HC-PARTS
<b>FORD Continued</b>							
98VB11000B3A.....	<b>CS977</b>	D2AF11001EA.....	<b>US1027</b>	D7VZ10346A.....	<b>UA928</b>	F0TU10300EA.....	<b>UA1210IR</b>
98VB11000B3B.....	<b>CS977</b>	D2AF11001JA.....	<b>US816</b>	D7ZF10300BA.....	<b>UA928</b>	F0TZ11002B.....	<b>US1028</b>
98VB11000AA.....	<b>CS977</b>	D2AF11001AA.....	<b>US816</b>	D7ZF10300CA.....	<b>UA928</b>	F17U10300AA.....	<b>UA9621R</b>
98VW10300BA.....	<b>CA1570IR</b>	D2FF11001AB.....	<b>US817</b>	D80F11001AA.....	<b>US814</b>	F1PU10300CA.....	<b>UA9621R</b>
98VW10300CA.....	<b>CA1446IR</b>	D2SF10300AB.....	<b>UA927</b>	D8BF10300BA.....	<b>UA927</b>	F1TZ10346C.....	<b>UA9621R</b>
98VW10300EA.....	<b>CA1394IR</b>	D2SF10300AA.....	<b>UA927</b>	D8BF10300DA.....	<b>UA969</b>	F2NN10B376AA.....	<b>CA8911R</b>
9S5110346BA.....	<b>CA1742IR</b>	D2TF11001AA.....	<b>US870</b>	D8BF10346AA.....	<b>UA927</b>	F2TU10300AF.....	<b>UA9631R</b>
9S5110346BB.....	<b>CA1742IR</b>	D2VF11001AA.....	<b>US1027</b>	D8BZ10346AA.....	<b>UA927</b>	F32Z11002B.....	<b>JS747</b>
9S511000AB.....	<b>CS1379</b>	D2ZF11001AA.....	<b>US628</b>	D8VF10300BA.....	<b>UA928</b>	F37U10300AA.....	<b>UA9631R</b>
9S511000AA.....	<b>CS1379</b>	D30F10300BA.....	<b>UA927</b>	D8VF10300AA.....	<b>UA927</b>	F3TU11000AA.....	<b>US845</b>
AC1T10300BA.....	<b>CA1928IR</b>	D30F10300CA.....	<b>UA927</b>	D8ZF10300BA.....	<b>UA927</b>	F3UU10300AE.....	<b>UA9631R</b>
AC1T10300BB.....	<b>CA1928IR</b>	D30F10300DA.....	<b>UA927</b>	D8ZF10300CA.....	<b>UA927</b>	F3UU10300AF.....	<b>UA9631R</b>
AV6N10300HA.....	<b>CA2044IR</b> *	D30F10300AA.....	<b>UA969</b>	D90F10300AA.....	<b>UA969</b>	F57U10300AA.....	<b>UA9621R</b>
C20F11001A.....	<b>US628</b>	D30Z11002A.....	<b>US1027</b>	D9AF10300AA.....	<b>UA927</b>	F5RU10300BB.....	<b>CA1316IR</b>
C20F11001D.....	<b>US628</b>	D32F10300BA.....	<b>UA927</b>	D9AF10300BA.....	<b>UA927</b>	F2TU10300BC.....	<b>CA1316IR</b>
C20F11001E.....	<b>US628</b>	D32F10300AA.....	<b>UA969</b>	D9BZ10346A.....	<b>UA927</b>	F5UU10300BA.....	<b>UA9631R</b>
C20Z11001A.....	<b>US628</b>	D3TF11001DA.....	<b>US1027</b>	D9BZ10346C.....	<b>UA969</b>	F67U10300BA.....	<b>UA9621R</b>
C20Z11002A.....	<b>US628</b>	D3VF10300A.....	<b>UA928</b>	D9DF10300AA.....	<b>UA969</b>	F67U10300AA.....	<b>UA9621R</b>
C2VF11002A.....	<b>US628</b>	D3VF10300AB.....	<b>UA928</b>	D9HT10300EA.....	<b>UA927</b>	F7U10300AA.....	<b>CA1316IR</b>
C2VY11002A.....	<b>US628</b>	D3VF10300BA.....	<b>UA928</b>	D9SF10300AA.....	<b>UA927</b>	F6UU10300EA.....	<b>UA9631R</b>
C30F11001A.....	<b>US628</b>	D3VF10300AA.....	<b>UA928</b>	D9UF10300BA.....	<b>UA927</b>	F77U10300BA.....	<b>UA9621R</b>
C30F11001B.....	<b>US628</b>	D3VF10346A.....	<b>UA928</b>	D9VY10346A.....	<b>UA927</b>	F7CU10300AB.....	<b>UA9621R</b>
C30Z11002B.....	<b>US628</b>	D3VF10346BA.....	<b>UA928</b>	D9ZF10300BA.....	<b>UA969</b>	F7U11000AA.....	<b>JS1096</b>
C30Z11002C.....	<b>US870</b>	D3VY10346A.....	<b>UA928</b>	D9ZF10300AA.....	<b>UA927</b>	F8RU10300BA.....	<b>CA1839IR</b>
C40F11001A.....	<b>US628</b>	D40F10300FA.....	<b>UA927</b>	E0SF10300AA.....	<b>UA927</b>	F8RU11000AA.....	<b>JS1352</b>
C40F11001B.....	<b>US628</b>	D40Z11002A.....	<b>US628</b>	E0TF10300AA.....	<b>UA927</b>	F91BB11000MA.....	<b>CS722</b>
C4TF11001B.....	<b>US870</b>	D42F10300BA.....	<b>UA927</b>	E12F10300FA.....	<b>UA927</b>	R2S7T11000DB.....	<b>CS1245</b>
C4TZ11002B.....	<b>US870</b>	D42F11001AB.....	<b>US817</b>	E18F10300BA.....	<b>UA969</b>	R72GB10346NA.....	<b>CA961R</b>
C4VF11001A.....	<b>US870</b>	D42F11001BA.....	<b>US817</b>	E1AF11001BA.....	<b>US814</b>	R835X11000AC.....	<b>CS337</b>
C4VY11002A.....	<b>US870</b>	D4AF11001AA.....	<b>US1027</b>	E1AF11002B.....	<b>US814</b>	R86AX10300AB.....	<b>CA3051R</b>
C4ZF11001A.....	<b>US628</b>	D4AZ11002A.....	<b>US1027</b>	E1EF10300HA.....	<b>UA927</b>	R86AX10300MB.....	<b>CA3251R</b>
C5AF11001A.....	<b>US870</b>	D4TZ11002D.....	<b>US813</b>	E1GF10300DA.....	<b>UA927</b>	R86AX10300MB.....	<b>CA3251R</b>
C5TZ11001A.....	<b>US813</b>	D50F10300AA.....	<b>UA969</b>	E1TF10300AA.....	<b>UA927</b>	R86AX10300AAA.....	<b>CA5601R</b>
C5TZ11002A.....	<b>US813</b>	D50F11001AA.....	<b>US628</b>	E1ZF10300FA.....	<b>UA927</b>	R87BB11000DA.....	<b>CS609</b>
C6AF11001A.....	<b>US870</b>	D5AF10300CA.....	<b>UA927</b>	E27F10300BA.....	<b>UA927</b>	R88BX11000BA.....	<b>CS625</b>
C6VF11001A.....	<b>US870</b>	D5AF10300FA.....	<b>UA927</b>	E2SF11001AA.....	<b>US814</b>	R894X10300AA.....	<b>CA3111R</b>
C6VY11002A.....	<b>US870</b>	D5AF11001AB.....	<b>US1027</b>	E2SF11002AA.....	<b>US814</b>	R89FF10300CD.....	<b>CA5841R</b>
C70F11001A.....	<b>US870</b>	D5AF11001EA.....	<b>US816</b>	E3TF10300AB.....	<b>UA969</b>	R89FF10300CE.....	<b>CA5841R</b>
C7AF11001A.....	<b>US870</b>	D5AZ11002C.....	<b>US816</b>	E6SF10300EA.....	<b>UA927</b>	R89FF10300EC.....	<b>CA7171R</b>
C7AF11001B.....	<b>US814</b>	D5FF11001AA.....	<b>US628</b>	E79F10300BA.....	<b>UA1210IR</b>	R89FX10300BA.....	<b>CA6111R</b>
C7AF11001C.....	<b>US870</b>	D5OF10300BA.....	<b>UA928</b>	E7AF10300AD.....	<b>UA1210IR</b>	R89FX10300CD.....	<b>CA5841R</b>
C7AF11001E.....	<b>US870</b>	D5OF11001BA.....	<b>US628</b>	E7DF10300EB.....	<b>UA928</b>	R89FX10300GB.....	<b>CA5611R</b>
C7AF11001F.....	<b>US813</b>	D5OF11001AA.....	<b>US628</b>	E7PF10346LA.....	<b>UA1210IR</b>	R89FX10300AA.....	<b>CA1028IR</b>
C7TF11001A.....	<b>US870</b>	D5TF10300AA.....	<b>UA927</b>	E7PF10346MA.....	<b>UA1210IR</b>	R89FX10300AA.....	<b>CA3111R</b>
C7ZF11001A.....	<b>US813</b>	D5TF11001C.....	<b>US1027</b>	E7PF10346ZA.....	<b>UA1210IR</b>	R924X10300AB.....	<b>CA7191R</b>
C8AF11001A.....	<b>US870</b>	D5TF11001DA.....	<b>US813</b>	E7PZ10346C.....	<b>UA1210IR</b>	R92AX11000JB.....	<b>CS592</b>
C8VF11001A.....	<b>US1027</b>	D5TF11001AA.....	<b>US813</b>	E7SF10300FA.....	<b>UA1210IR</b>	R93BB11000AG.....	<b>CA7311R</b>
C8VF11002A.....	<b>US1027</b>	D5ZF10300AA.....	<b>UA928</b>	E7SF10300HA.....	<b>UA1210IR</b>	R93BB11000AC.....	<b>CS1107</b>
C8VY11002A.....	<b>US1027</b>	D60F11001AA.....	<b>US628</b>	E7SF10300MA.....	<b>UA1210IR</b>	R93BB11000JB.....	<b>CS1058</b>
C8VY11002C.....	<b>US1027</b>	D60F11002A.....	<b>US628</b>	E7TF10300NA.....	<b>UA928</b>	R93BB11000JC.....	<b>CS1058</b>
C9AF11001A.....	<b>US1027</b>	D60F11002AA.....	<b>US628</b>	E7ZF10300BA.....	<b>UA1210IR</b>	R93BB11000K.....	<b>CS961</b>
C9AF11001B.....	<b>US870</b>	D6BF11001BA.....	<b>US870</b>	E7ZF10300EA.....	<b>UA1210IR</b>	R93BB11000KD.....	<b>CS961</b>
D0AF11001A.....	<b>US870</b>	D6DF11002B.....	<b>US870</b>	E7ZF10300FA.....	<b>UA1210IR</b>	R94AB10300BA.....	<b>CA1032IR</b>
D0AF11001B.....	<b>US628</b>	D6TF11001BA.....	<b>US870</b>	E83Z10346A.....	<b>JA1168IR</b>	R954F10300AA.....	<b>CA1031IR</b>
D0AF11001C.....	<b>US813</b>	D6TF11001DA.....	<b>US837</b>	E8DF10300CA.....	<b>UA928</b>	R954F10300AA.....	<b>CA7191R</b>
D0AF11001E.....	<b>US870</b>	D6TF11001AA.....	<b>US870</b>	E8DF10300DA.....	<b>UA928</b>	R95AB10300DB.....	<b>CA1037IR</b>
D0HF10300DA.....	<b>UA927</b>	D6TZ11002A.....	<b>US870</b>	E8DF10300DE.....	<b>UA928</b>	R95FF10300AC.....	<b>CA1083IR</b>
D0SF10300A.....	<b>UA927</b>	D6TZ11002B.....	<b>US870</b>	E8DZ10346A.....	<b>JA1168IR</b>	R95GB10300MA.....	<b>CA1085IR</b>
D0TF11001A.....	<b>US870</b>	D70F10300BA.....	<b>UA928</b>	E8SF10300BA.....	<b>UA927</b>	R95GB10300MB.....	<b>CA1085IR</b>
D0VF11000A.....	<b>US1027</b>	D70F10300CA.....	<b>UA969</b>	E8TF11000AA.....	<b>US845</b>	R95GX11000EA.....	<b>CS330</b>
D0VF11001A.....	<b>US1027</b>	D70F10300DA.....	<b>UA969</b>	E98F11000BA.....	<b>US866</b>	R95VW10300BB.....	<b>CA1230IR</b>
D0ZF11001A.....	<b>US870</b>	D70F10300EA.....	<b>UA969</b>	E98F11000AA.....	<b>US866</b>	R95VW10300ABA.....	<b>CA1089IR</b>
D12F11001AB.....	<b>US817</b>	D70F10300AA.....	<b>UA969</b>	E99F10300AB.....	<b>UA1210IR</b>	R95VW10300AC.....	<b>CA1324IR</b>
D12F11001AA.....	<b>US817</b>	D70F10346BA.....	<b>UA969</b>	E99F10300BA.....	<b>UA1210IR</b>	R95VW10300CC.....	<b>CA1149IR</b>
D1AF11001A.....	<b>US816</b>	D70F10346AA.....	<b>UA969</b>	E9DF10300DA.....	<b>UA928</b>	R95VW10300KB.....	<b>CA1142IR</b>
D1AF11001AA.....	<b>US816</b>	D7AF10300CA.....	<b>UA927</b>	E9PF10346DA.....	<b>UA928</b>	R95VW10300NA.....	<b>CA7361R</b>
D1AZ11002A.....	<b>US816</b>	D7AF10300DA.....	<b>UA927</b>	E9SF10300BA.....	<b>UA1210IR</b>	R96BB10300BA.....	<b>CA1316IR</b>
D1FF11001AA.....	<b>US817</b>	D7AF10300EA.....	<b>UA927</b>	E9SF11000AB.....	<b>US866</b>	R96FB10300DD.....	<b>CA1087IR</b>
D1FZ11002A.....	<b>US817</b>	D7AF10300FA.....	<b>UA927</b>	E9SF11000BA.....	<b>US866</b>	R96FB11000KC.....	<b>CS1050</b>
D20F10300CA.....	<b>UA927</b>	D7AF10300GA.....	<b>UA927</b>	E9SF11000AA.....	<b>US866</b>	R96FB11000LC.....	<b>CS960</b>
D20F10300EB.....	<b>UA927</b>	D7AF10300HC.....	<b>UA927</b>	E9SZ11002A.....	<b>US866</b>	R96FB11000LD.....	<b>CS960</b>
D20F11001BA.....	<b>US870</b>	D7AF10300KA.....	<b>UA927</b>	E9SZ11002B.....	<b>US866</b>	R96MF10300DC.....	<b>CA1137IR</b>
D20F11001AA.....	<b>US870</b>	D7AF10300LA.....	<b>UA927</b>	E9UF10300BA.....	<b>UA1210IR</b>	R97AB10300AD.....	<b>CA1217IR</b>
D22F10300BA.....	<b>UA927</b>	D7AF10300AA.....	<b>UA927</b>	F07F10300AA.....	<b>UA9621R</b>	R97AB10300AE.....	<b>CA1217IR</b>
D22F11001AB.....	<b>US817</b>	D7AZ10346A.....	<b>UA927</b>	F07U10300AB.....	<b>UA9621R</b>	R97KB10300AA.....	<b>CA1145IR</b>
D22F11001AA.....	<b>US817</b>	D7AZ10346B.....	<b>UA927</b>	F07U10300AC.....	<b>UA9621R</b>	R97MF10300AA.....	<b>CA1137IR</b>
D2AF11001BA.....	<b>US870</b>	D7EF10300BA.....	<b>UA969</b>	F07U10300AA.....	<b>UA9621R</b>	R98VB11000B1A.....	<b>CS977</b>
D2AF11001CA.....	<b>US628</b>	D7NN10300B.....	<b>UA918</b>	F07U11000BA.....	<b>US1028</b>	RV87VG10300AB.....	<b>CA6501R</b>
D2AF11001DA.....	<b>US813</b>	D7VF10346AA.....	<b>UA928</b>	F0NN10B376BB.....	<b>CA8911R</b>	RV87VX10300AB.....	<b>CA6501R</b>

O.E. NO.	HC-PARTS	O.E. NO.	HC-PARTS	O.E. NO.	HC-PARTS	O.E. NO.	HC-PARTS
RV90BB11000BA	CS786	HAB170103	JA576IR	8EA726011-001	CS170	8EA726096-001	CS348
RV90BX11000BA	CS787	HAB170140	JA877IR	8EA726012-001	CS18	8EA726097-001	CS349
RV90BX11000AA	CS786	HAB170144	JA575IR	8EA726013-001	CS180	8EA726098-001	CS350
RV91BX10300AA	CA1686IR	HAB175120	JA671IR	8EA726014-001	CS181	8EA726099-001	CS351
RV94GB10300BB	CA719IR	HAB175160	JA888IR	8EA726016-001	CS183	8EA726100-001	CS352
RYC1U11000AF	CS1245	HAB175200	JA879IR	8EA726017-001	CS184	8EA726101-001	CS353
U88VG10K359AA	CA611IR	HAB175241	JA973IR	8EA726018-001	CS185	8EA726102-001	CS354
V84FB11000BA	CS278	HAB175241N	JA973IR	8EA726019-001	CS186	8EA726103-001	CS355
V84FB11000AA	CS278	HAB180101	JA755IR	8EA726020-001	CS188	8EA726104-001	CS356
V87VG10300AB	CA650IR	HAB190120	JA684IR	8EA726021-001	CS19	8EA726105-001	CS357
V87VG10300AA	CA650IR	HAB190140	JA994IR	8EA726022-001	CS191	8EA726106-001	CS358
V89AB10300AA	CA560IR	HAD155500	JA180IR	8EA726023-001	CS194	8EA726107-001	CS359
V90BB11000AB	CS786	HAD165500	JA585IR	8EA726024-001	CS195	8EA726108-001	CS360
V90BB11000BA	CS787	HAD165500	JA585IR	8EA726025-001	CS198	8EA726109-001	CS361
V90BB11000BB	CS787	HAD165504	JA674IR	8EA726026-001	CS200	8EA726110-001	CS362
V90BB11000AA	CS786	HAD165520	JA1366IR	8EA726027-001	CS201	8EA726111-001	CS363
V90BX11000BA	CS787	HSC107100	JS350	8EA726028-001	CS21	8EA726112-001	CS364
V90BX11000AA	CS786	HSC108100	JS633	8EA726029-001	CS230	8EA726113-001	CS365
V94GB10K359AC	CA719IR	HSC109120	JS643	8EA726030-001	CS231	8EA726114-001	CS366
V94GB11000AC	CS1065	HSG120500	JS344	8EA726031-001	CS232	8EA726115-001	CS367
V95GB11000AA	CS1065	HSG120510	JS903	8EA726032-001	CS240	8EA726116-001	CS368
XM3410300BA	JA1530IR	HSG232500	JS553	8EA726034-001	CS263	8EA726117-001	CS369
XM3410300AA	JA1530IR	HSP112110	JS628	8EA726035-001	CS266	8EA726118-001	CS370
XM3411002CA	JS1352	HSP112130	JS1004	8EA726036-001	CS267	8EA726119-001	CS371
XR8310300BA	CA2073IR	HSP112140	JS781	8EA726037-001	CS268	8EA726120-001	CS372
XR8310300BC	CA2073IR	HSP112150	JS922	8EA726038-001	CS269	8EA726121-001	CS373
XS7U11000C3A	CS1107	HSP112160	JS923	8EA726040-001	CS272	8EA726122-001	CS374
XS7U11000C4A	CS1107			8EA726043-001	CS275	8EA726123-001	CS375
XS7U11000C4A1	CS1107	HATZ		8EA726044-001	CS276	8EA726124-001	CS376
XS7U11000CB	CS1107	40000610	CS995	8EA726045-001	CS278	8EA726125-001	CS377
XS7U11000CC	CS1107	50353420	CS1340	8EA726046-001	CS280	8EA726126-001	CS378
YC1T10300BC	CA1639IR			8EA726047-001	CS282	8EA726127-001	CS379
YC1T10300BD	CA1639IR	HELLA		8EA726048-001	CS285	8EA726128-001	CS380
YC1T10300BE	CA1639IR	8EA725961-001	CS101	8EA726049-001	CS286	8EA726129-001	CS381
YC1T10300BG	CA1639IR	8EA725962-001	CS103	8EA726050-001	CS289	8EA726130-001	CS382
YC1T10300BH	CA1639IR	8EA725963-001	CS106	8EA726051-001	CS290	8EA726131-001	CS383
YC1T10300BJ	CA1639IR	8EA725964-001	CS107	8EA726052-001	CS292	8EA726132-001	CS384
YC1U10300BB	CA1639IR	8EA725965-001	CS109	8EA726053-001	CS293	8EA726133-001	CS385
YC1U10300DA	CA1639IR	8EA725966-001	CS113	8EA726054-001	CS294	8EA726134-001	CS386
YC1U10300DB	CA1639IR	8EA725967-001	CS114	8EA726055-001	CS295	8EA726135-001	CS387
YC1U10300DC	CA1639IR	8EA725968-001	CS115	8EA726056-001	CS297	8EA726136-001	CS388
YC1U10300DE	CA1639IR	8EA725969-001	CS116	8EA726057-001	CS298	8EA726137-001	CS389
YC1U10300EA	CA1779IR	8EA725970-001	CS117	8EA726058-001	CS299	8EA726138-001	CS390
YC1U11000AB	CS1245	8EA725972-001	CS119	8EA726059-001	CS300	8EA726139-001	CS391
YC1U11000AC	CS1245	8EA725973-001	CS120	8EA726061-001	CS306	8EA726139-021	CS1443
YC1U11000AD	CS1245	8EA725974-001	CS121	8EA726062-001	CS308	8EA726140-001	CS392
YC1U11000AE	CS1245	8EA725975-001	CS122	8EA726063-001	CS310	8EA726141-001	CS393
YC1U11000AF	CS1245	8EA725976-001	CS123	8EA726064-001	CS311	8EA726142-001	CS394
YC1U11000AG	CS1245	8EA725977-001	CS124	8EA726065-001	CS314	8EA726143-001	CS395
YM2110300CA	CA1763IR	8EA725978-001	CS126	8EA726066-001	CS315	8EA726144-001	CS396
YM2110300AA	CA1836IR	8EA725979-001	CS127	8EA726067-001	CS316	8EA726145-001	CS397
YM2111000BA	CS1181	8EA725980-001	CS128	8EA726068-001	CS317	8EA726146-001	CS398
YM2111000BB	CS1181	8EA725981-001	CS129	8EA726069-001	CS321	8EA726148-001	CS500
YM2111000GA	CS1390	8EA725982-001	CS130	8EA726070-001	CS322	8EA726149-001	CS501
YS4D10300AB	CA2093IR	8EA725983-001	CS131	8EA726071-001	CS323	8EA726150-001	CS502
YS4D10300AC	CA2093IR	8EA725984-001	CS132	8EA726072-001	CS324	8EA726151-001	CS503
YS4D10300AE	CA2093IR	8EA725985-001	CS133	8EA726073-001	CS325	8EA726152-001	CS504
YS4D10300AG	CA2093IR	8EA725986-001	CS135	8EA726074-001	CS326	8EA726153-001	CS505
YS4D10300AA	CA2093IR	8EA725987-001	CS136	8EA726075-001	CS327	8EA726155-001	CS507
YS4U11000AB	CS1050	8EA725988-001	CS138	8EA726076-001	CS328	8EA726156-001	CS508
YS4U11000BA	CS1050	8EA725989-001	CS139	8EA726077-001	CS329	8EA726157-001	CS509
YS4U11000BB	CS1050	8EA725990-001	CS140	8EA726078-001	CS330	8EA726158-001	CS510
YS4U11000DA	CS790	8EA725991-001	CS141	8EA726079-001	CS331	8EA726159-001	CS511
YS4U11000DB	CS790	8EA725992-001	CS142	8EA726080-001	CS332	8EA726160-001	CS514
YS4U11000DC	CS790	8EA725993-001	CS143	8EA726081-001	CS333	8EA726161-001	CS515
YS4U11000DD	CS790	8EA725995-001	CS147	8EA726082-001	CS334	8EA726162-001	CS516
YS4U11000AA	CS1050	8EA725996-001	CS148	8EA726083-001	CS335	8EA726163-001	CS518
YS6110300BF	CA1649IR	8EA725998-001	CS150	8EA726084-001	CS336	8EA726164-001	CS519
YS6110300CA	CA1760IR	8EA725999-001	CS151	8EA726085-001	CS337	8EA726165-001	CS523
YS6110300CC	CA1760IR	8EA726000-001	CS152	8EA726086-001	CS338	8EA726166-001	CS524
YS6110300DB	CA1772IR	8EA726002-001	CS154	8EA726087-001	CS339	8EA726167-001	CS526
		8EA726003-001	CS155	8EA726088-001	CS340	8EA726168-001	CS528
HALLA		8EA726004-001	CS156	8EA726089-001	CS341	8EA726169-001	CS529
HAB111100	JA995IR	8EA726005-001	CS162	8EA726090-001	CS342	8EA726170-001	CS530
HAB145104	JA129IR	8EA726006-001	CS163	8EA726091-001	CS343	8EA726171-001	CS531
HAB155122	JA667IR	8EA726007-001	CS165	8EA726092-001	CS344	8EA726172-001	CS535
HAB160100	JA694IR	8EA726008-001	CS166	8EA726093-001	CS345	8EA726173-001	CS536
HAB160102	JA805IR	8EA726009-001	CS168	8EA726094-001	CS346	8EA726174-001	CS541
HAB165100	JA688IR	8EA726010-001	CS169	8EA726095-001	CS347	8EA726175-001	CS542

O.E. NO.	HC-PARTS	O.E. NO.	HC-PARTS	O.E. NO.	HC-PARTS	O.E. NO.	HC-PARTS
<b>HELLA <i>Continued</i></b>							
8EA726176-001	CS543	8EA726405-001	JS308	8EA726495-001	JS527	8EA730211-001	CS695
8EA726177-001	CS544	8EA726406-001	JS309	8EA726496-001	JS532	8EA730212-001	CS696
8EA726178-001	CS545	8EA726407-001	JS310	8EA726497-001	JS533	8EA730213-001	CS697
8EA726179-001	CS546	8EA726408-001	JS311	8EA726498-001	JS534	8EA730214-001	CS698
8EA726180-001	CS547	8EA726409-001	JS312	8EA726499-001	JS537	8EA730215-001	CS699
8EA726181-001	CS548	8EA726411-001	JS314	8EA726500-001	JS538	8EA730216-001	CS700
8EA726182-001	CS550	8EA726412-001	JS315	8EA726501-001	JS539	8EA730217-001	CS701
8EA726183-001	CS551	8EA726413-001	JS316	8EA726502-001	JS540	8EA730218-001	CS702
8EA726184-001	CS554	8EA726414-001	JS317	8EA726503-001	JS549	8EA730219-001	CS703
8EA726185-001	CS555	8EA726415-001	JS318	8EA726504-001	JS552	8EA730220-001	CS704
8EA726186-001	CS559	8EA726416-001	JS319	8EA726505-001	JS553	8EA730222-001	CS706
8EA726187-001	CS561	8EA726418-001	JS322	8EA726506-001	JS556	8EA730223-001	CS707
8EA726188-001	CS562	8EA726419-001	JS323	8EA726507-001	JS557	8EA730224-001	CS708
8EA726189-001	CS564	8EA726421-001	JS325	8EA726508-001	JS558	8EA730225-001	CS709
8EA726190-001	CS565	8EA726422-001	JS327	8EA726509-001	JS560	8EA730226-001	CS710
8EA726191-001	CS566	8EA726423-001	JS329	8EA726510-001	JS563	8EA730227-001	CS711
8EA726192-001	CS567	8EA726424-001	JS330	8EA726511-001	JS568	8EA730228-001	CS712
8EA726193-001	CS569	8EA726425-001	JS331	8EA726512-001	JS626	8EA730229-001	CS713
8EA726194-001	CS570	8EA726426-001	JS333	8EA726513-001	JS627	8EA730231-001	JS643
8EA726196-001	CS572	8EA726428-001	JS335	8EA726514-001	JS628	8EA730232-001	JS644
8EA726197-001	CS573	8EA726429-001	JS336	8EA726515-001	JS629	8EA730233-001	JS645
8EA726198-001	CS574	8EA726430-001	JS337	8EA726516-001	JS630	8EA730234-001	JS646
8EA726199-001	CS575	8EA726431-001	JS338	8EA726517-001	JS631	8EA730235-001	JS647
8EA726200-001	CS576	8EA726432-001	JS339	8EA726518-001	JS632	8EA730236-001	JS648
8EA726201-001	CS577	8EA726433-001	JS340	8EA726519-001	JS633	8EA730237-001	JS649
8EA726202-001	CS578	8EA726434-001	JS342	8EA726520-001	JS634	8EA730238-001	JS650
8EA726203-001	CS579	8EA726435-001	JS343	8EA726522-001	JS636	8EA730239-001	JS651
8EA726204-001	CS580	8EA726436-001	JS344	8EA726523-001	JS637	8EA730240-001	JS652
8EA726205-001	CS581	8EA726437-001	JS345	8EA726524-001	JS638	8EA730241-001	JS653
8EA726207-001	CS583	8EA726439-001	JS347	8EA726525-001	JS639	8EA730242-001	JS654
8EA726208-001	CS584	8EA726440-001	JS348	8EA726540-001	US628	8EA730243-001	JS655
8EA726209-001	CS585	8EA726441-001	JS349	8EA726542-001	US647	8EA730244-001	JS656
8EA726211-001	CS587	8EA726442-001	JS350	8EA726543-001	US811	8EA730245-001	JS657
8EA726212-001	CS588	8EA726443-001	JS351	8EA726544-001	US818	8EA730246-001	JS658
8EA726213-001	CS589	8EA726445-001	JS353	8EA726545-001	US877	8EA730247-001	JS659
8EA726214-001	CS590	8EA726446-001	JS354	8EA726545-001	US969	8EA730248-001	JS660
8EA726215-001	CS591	8EA726447-001	JS355	8EA726550-001	JS640	8EA730249-001	JS661
8EA726216-001	CS592	8EA726448-001	JS356	8EA726551-001	JS641	8EA730250-001	JS662
8EA726218-001	CS594	8EA726449-001	JS357	8EA726552-001	JS642	8EA730251-001	JS663
8EA726219-001	CS595	8EA726450-001	JS358	8EA730171-001	CS601	8EA730252-001	JS664
8EA726221-001	CS597	8EA726451-001	JS359	8EA730172-001	CS602	8EA730253-001	JS665
8EA726222-001	CS598	8EA726452-001	JS360	8EA730173-001	CS603	8EA730254-001	JS666
8EA726223-001	CS599	8EA726453-001	JS362	8EA730174-001	CS604	8EA730255-001	JS667
8EA726224-001	CS60	8EA726454-001	JS363	8EA730175-001	CS605	8EA730256-001	JS668
8EA726225-001	CS600	8EA726455-001	JS364	8EA730176-001	CS606	8EA730257-001	JS669
8EA726226-001	CS61	8EA726456-001	JS365	8EA730177-001	CS607	8EA730258-001	JS670
8EA726227-001	CS62	8EA726458-001	JS370	8EA730178-001	CS608	8EA730259-001	JS671
8EA726229-001	CS66	8EA726459-001	JS371	8EA730179-001	CS609	8EA730260-001	JS672
8EA726231-001	CS69	8EA726460-001	JS372	8EA730180-001	CS610	8EA730261-001	JS673
8EA726232-001	CS70	8EA726461-001	JS373	8EA730181-001	CS611	8EA730262-001	JS674
8EA726233-001	CS72	8EA726463-001	JS375	8EA730182-001	CS612	8EA730263-001	JS675
8EA726234-001	CS74	8EA726464-001	JS376	8EA730183-001	CS613	8EA730264-001	JS676
8EA726236-001	CS76	8EA726465-001	JS377	8EA730184-001	CS614	8EA730265-001	JS677
8EA726237-001	CS77	8EA726466-001	JS378	8EA730185-001	CS615	8EA730266-001	JS678
8EA726238-001	CS78	8EA726467-001	JS379	8EA730186-001	CS616	8EA730267-001	JS679
8EA726239-001	CS79	8EA726468-001	JS380	8EA730187-001	CS617	8EA730268-001	JS728
8EA726240-001	CS80	8EA726469-001	JS381	8EA730188-001	CS618	8EA730269-001	JS729
8EA726241-001	CS81	8EA726470-001	JS382	8EA730189-001	CS619	8EA730270-001	JS730
8EA726242-001	CS83	8EA726471-001	JS383	8EA730190-001	CS620	8EA730271-001	JS731
8EA726243-001	CS86	8EA726473-001	JS385	8EA730191-001	CS621	8EA730272-001	JS732
8EA726244-001	CS87	8EA726474-001	JS386	8EA730192-001	CS622	8EA730274-001	JS733
8EA726245-001	CS89	8EA726475-001	JS387	8EA730193-001	CS623	8EA730275-001	JS734
8EA726246-001	CS90	8EA726476-001	JS388	8EA730194-001	CS624	8EA730276-001	JS735
8EA726247-001	CS91	8EA726477-001	JS389	8EA730195-001	CS625	8EA730277-001	JS736
8EA726249-001	CS93	8EA726479-001	JS391	8EA730196-001	CS680	8EA730278-001	JS737
8EA726250-001	CS94	8EA726480-001	JS392	8EA730197-001	CS681	8EA730279-001	JS738
8EA726251-001	CS95	8EA726481-001	JS393	8EA730198-001	CS682	8EA730280-001	JS739
8EA726252-001	CS96	8EA726482-001	JS394	8EA730199-001	CS683	8EA730281-001	JS740
8EA726253-001	CS97	8EA726483-001	JS395	8EA730200-001	CS684	8EA730282-001	JS741
8EA726254-001	CS98	8EA726484-001	JS396	8EA730201-001	CS685	8EA730283-001	JS742
8EA726255-001	CS99	8EA726485-001	JS397	8EA730202-001	CS686	8EA730284-001	JS743
8EA726397-001	JS300	8EA726487-001	JS399	8EA730203-001	CS687	8EA730285-001	JS744
8EA726398-001	JS301	8EA726488-001	JS512	8EA730204-001	CS688	8EA730286-001	JS745
8EA726399-001	JS302	8EA726489-001	JS513	8EA730205-001	CS689	8EA730287-001	JS746
8EA726400-001	JS303	8EA726490-001	JS517	8EA730206-001	CS690	8EA730288-001	JS748
8EA726401-001	JS304	8EA726491-001	JS520	8EA730207-001	CS691	8EA730289-001	JS749
8EA726402-001	JS305	8EA726492-001	JS521	8EA730208-001	CS692	8EA730290-001	JS750
8EA726403-001	JS306	8EA726493-001	JS522	8EA730209-001	CS693	8EA730291-001	JS751
8EA726404-001	JS307	8EA726494-001	JS525	8EA730210-001	CS694	8EA730292-001	US809

O.E. NO.	HC-PARTS	O.E. NO.	HC-PARTS	O.E. NO.	HC-PARTS	O.E. NO.	HC-PARTS
8EA730293-001	US810	8EA731788-001	JS753	8EA732889-001	CS802	8EA737184-001	CS984
8EA730294-001	US812	8EA731789-001	JS754	8EA732890-001	CS803	8EA737185-001	CS985
8EA730295-001	US813	8EA731790-001	JS755	8EA732891-001	CS804	8EA737186-001	JS941
8EA730296-001	US814	8EA731791-001	JS756	8EA732892-001	CS805	8EA737187-001	JS942
8EA730297-001	US815	8EA731792-001	JS757	8EA732893-001	CS806	8EA737188-001	JS943
8EA730298-001	US816	8EA731793-001	JS758	8EA732894-001	CS807	8EA737189-001	JS998
8EA730299-001	US817	8EA731794-001	JS759	8EA732895-001	CS808	8EA737190-001	JS999
8EA730300-001	US819	8EA731795-001	JS760	8EA737081-001	CS882	8EA737191-001	JS1000
8EA730301-001	US821	8EA731796-001	JS761	8EA737082-001	CS883	8EA737235-001	CS986
8EA730302-001	US822	8EA731797-001	JS762	8EA737083-001	CS884	8EA737236-001	CS987
8EA730303-001	US823	8EA731798-001	JS763	8EA737084-001	CS885	8EA737237-001	CS988
8EA730304-001	US824	8EA731799-001	JS764	8EA737085-001	CS886	8EA737238-001	CS989
8EA730305-001	US825	8EA731800-001	JS765	8EA737086-001	CS887	8EA737239-001	CS990
8EA730306-001	US826	8EA731801-001	JS766	8EA737087-001	CS888	8EA737240-001	CS991
8EA730307-001	US827	8EA731802-001	JS767	8EA737088-001	CS889	8EA737241-001	CS992
8EA730308-001	US828	8EA731803-001	JS768	8EA737089-001	CS944	8EA737242-001	CS993
8EA730309-001	US830	8EA731804-001	JS769	8EA737091-001	CS946	8EA737243-001	CS994
8EA730310-001	US832	8EA731805-001	JS770	8EA737092-001	CS947	8EA737244-001	CS995
8EA730311-001	US833	8EA731806-001	JS771	8EA737093-001	CS948	8EA737245-001	CS996
8EA730313-001	US835	8EA731807-001	JS772	8EA737094-001	CS949	8EA737246-001	CS997
8EA730315-001	US837	8EA731808-001	JS773	8EA737095-001	CS950	8EA737247-001	CS1030
8EA730316-001	US838	8EA731809-001	JS774	8EA737096-001	CS951	8EA737248-001	CS1031
8EA730317-001	US839	8EA731810-001	JS775	8EA737097-001	CS952	8EA737249-001	CS1032
8EA730318-001	US840	8EA732651-001	CS796	8EA737098-001	CS953	8EA737250-001	CS1033
8EA730319-001	US842	8EA732652-001	CS797	8EA737099-001	CS954	8EA737251-001	CS1034
8EA730320-001	US843	8EA732653-001	CS798	8EA737100-001	CS955	8EA737252-001	CS1035
8EA730321-001	US844	8EA732654-001	CS799	8EA737102-001	CS956	8EA737253-001	CS1036
8EA730322-001	US845	8EA732655-001	CS800	8EA737103-001	CS957	8EA737254-001	CS1037
8EA730323-001	US847	8EA732656-001	CS801	8EA737104-001	CS958	8EA737255-001	JS1001
8EA730324-001	US848	8EA732657-001	CS878	8EA737105-001	CS959	8EA737257-001	JS1003
8EA730325-001	US849	8EA732658-001	CS879	8EA737106-001	CS960	8EA737258-001	JS1004
8EA730326-001	US850	8EA732659-001	CS880	8EA737107-001	CS961	8EA737259-001	JS1005
8EA730327-001	US851	8EA732660-001	CS881	8EA737108-001	CS962	8EA737260-001	JS1006
8EA730328-001	US852	8EA732661-001	JS776	8EA737109-001	CS963	8EA737261-001	JS1007
8EA730329-001	US853	8EA732662-001	JS777	8EA737110-001	CS964	8EA737262-001	JS1008
8EA730330-001	US854	8EA732663-001	JS778	8EA737111-001	CS965	8EA737263-001	JS1009
8EA730331-001	US855	8EA732664-001	JS779	8EA737112-001	CS971	8EA737264-001	JS1010
8EA730333-001	DC1011	8EA732665-001	JS780	8EA737113-001	JS912	8EA737265-001	JS1011
8EA730334-001	DC1012	8EA732666-001	JS781	8EA737114-001	JS913	8EA737266-001	JS1012
8EA730335-001	DC1013	8EA732667-001	JS890	8EA737115-001	JS914	8EA737267-001	JS1013
8EA730337-001	DC1000	8EA732668-001	JS891	8EA737116-001	JS915	8EA737268-001	JS1014
8EA730338-001	DC1001	8EA732669-001	JS893	8EA737117-001	JS916	8EA737269-001	US969
8EA730339-001	DC1002	8EA732670-001	JS894	8EA737118-001	JS917	8EA737271-001	US1025
8EA730340-001	DC1003	8EA732671-001	JS895	8EA737119-001	JS918	8EA737272-001	US1026
8EA730341-001	DC1004	8EA732672-001	JS896	8EA737120-001	JS919	8EA737273-001	CS1038
8EA730342-001	DC1006	8EA732673-001	JS897	8EA737121-001	JS920	8EA737274-001	CS1039
8EA730343-001	DC1005	8EA732674-001	JS898	8EA737123-001	JS922	8EA737288-001	CS1040
8EA730344-001	DC1007	8EA732675-001	JS899	8EA737124-001	JS923	8EA737289-001	JS1015
8EA730345-001	DC1008	8EA732676-001	JS900	8EA737125-001	JS924	8EA737290-001	CS1041
8EA730346-001	DC1009	8EA732677-001	JS901	8EA737126-001	JS925	8EA737291-001	CS1042
8EA731759-001	CS715	8EA732678-001	JS902	8EA737127-001	JS926	8EA737292-001	CS1043
8EA731760-001	CS716	8EA732679-001	US856	8EA737128-001	JS927	8EA737293-001	CS1044
8EA731761-001	CS717	8EA732680-001	US857	8EA737129-001	JS928	8EA737294-001	CS1045
8EA731762-001	CS718	8EA732681-001	US858	8EA737130-001	JS929	8EA737300-001	CS1046
8EA731763-001	CS719	8EA732682-001	US859	8EA737131-001	JS930	8EA737306-001	CS1047
8EA731764-001	CS720	8EA732683-001	US860	8EA737132-001	JS931	8EA737312-001	CS1048
8EA731765-001	CS721	8EA732685-001	US862	8EA737133-001	JS932	8EA737313-001	JS1016
8EA731766-001	CS722	8EA732845-001	JS892	8EA737134-001	JS933	8EA737314-001	CS1049
8EA731767-001	CS723	8EA732846-001	JS903	8EA737135-001	JS934	8EA737317-001	JS1017
8EA731768-001	CS724	8EA732847-001	JS904	8EA737136-001	JS935	8EA737318-001	CS1050
8EA731769-001	CS725	8EA732848-001	JS905	8EA737137-001	JS936	8EA737319-001	CS1051
8EA731770-001	CS726	8EA732849-001	JS906	8EA737138-001	US966	8EA737320-001	JS1018
8EA731771-001	CS727	8EA732850-001	JS907	8EA737140-001	US968	8EA737322-001	JS1019
8EA731772-001	CS782	8EA732851-001	JS908	8EA737145-001	CS972	8EA737326-001	JS1020
8EA731773-001	CS783	8EA732852-001	JS909	8EA737146-001	CS973	8EA737330-001	US869
8EA731774-001	CS784	8EA732853-001	JS910	8EA737147-001	CS974	8EA737331-001	US870
8EA731775-001	CS785	8EA732854-001	JS911	8EA737148-001	CS975	8EA737332-001	US871
8EA731776-001	CS786	8EA732855-001	US863	8EA737149-001	CS976	8EA737333-001	US872
8EA731777-001	CS787	8EA732856-001	US864	8EA737150-001	CS977	8EA737334-001	US873
8EA731778-001	CS788	8EA732857-001	US865	8EA737151-001	CS981	8EA737335-001	US874
8EA731779-001	CS789	8EA732858-001	US866	8EA737152-001	JS937	8EA737336-001	US875
8EA731780-001	CS790	8EA732859-001	US867	8EA737153-001	JS938	8EA737337-001	US876
8EA731781-001	CS791	8EA732860-001	US868	8EA737154-001	JS939	8EA737338-001	CS1052
8EA731782-001	CS792	8EA732861-001	US967	8EA737155-001	JS940	8EA737340-001	CS1053
8EA731783-001	CS793	8EA732862-001	DC1014	8EA737179-001	CS978	8EA737341-001	CS1054
8EA731784-001	CS794	8EA732863-001	DC1017	8EA737180-001	CS979	8EA737342-001	CS1055
8EA731785-001	CS795	8EA732864-001	DC1016	8EA737181-001	CS980	8EA737345-001	JS1021
8EA731786-001	JS747	8EA732865-001	DC1017	8EA737182-001	CS982	8EA737346-001	JS1022
8EA731787-001	JS752	8EA732866-001	DC1018	8EA737183-001	CS983	8EA737348-001	CS1056

O.E. NO.	HC-PARTS	O.E. NO.	HC-PARTS	O.E. NO.	HC-PARTS	O.E. NO.	HC-PARTS
<b>HELLA <i>Continued</i></b>							
8EA737351-001	CS1057	8EA737594-001	JS1140	8EA737869-001	JS1219	8EA738080-001	CS1275
8EA737356-001	JS1023	8EA737605-001	JS1141	8EA737870-001	JS1220	8EA738081-001	CS1276
8EA737357-001	JS1024	8EA737608-001	JS1142	8EA737876-001	CS1204	8EA738089-001	CS1277
8EA737358-001	CS1058	8EA737609-001	CS1125	8EA737878-001	CS1205	8EA738091-001	CS1278
8EA737361-001	JS1079	8EA737614-001	JS1143	8EA737880-001	CS1206	8EA738092-001	CS1279
8EA737362-001	JS1080	8EA737621-001	CS1126	8EA737881-001	JS1221	8EA738095-001	JS1302
8EA737373-001	CS1059	8EA737622-001	CS1127	8EA737882-001	CS1207	8EA738098-001	CS1280
8EA737376-001	CS1060	8EA737623-001	CS1128	8EA737891-001	CS1208	8EA738101-001	JS1303
8EA737385-001	JS1081	8EA737627-001	CS1129	8EA737892-001	CS1209	8EA738105-001	JS1304
8EA737389-001	JS1082	8EA737628-001	JS1144	8EA737893-001	CS1210	8EA738107-001	CS1281
8EA737403-001	CS1061	8EA737629-001	CS1130	8EA737899-001	JS1222	8EA738108-001	CS1282
8EA737406-001	CS1062	8EA737637-001	CS1131	8EA737900-001	CS1211	8EA738110-001	CS1283
8EA737407-001	CS1063	8EA737640-001	CS1132	8EA737901-001	CS1212	8EA738111-001	CS1284
8EA737408-001	CS1064	8EA737656-001	CS1160	8EA737904-001	US1029	8EA738113-001	CS1285
8EA737409-001	CS1065	8EA737659-001	CS1161	8EA737905-001	CS1213	8EA738119-001	CS1286
8EA737410-001	CS1066	8EA737660-001	CS1162	8EA737906-001	CS1241	8EA738120-001	CS1287
8EA737411-001	JS1083	8EA737676-001	CS1163	8EA737911-001	CS1242	8EA738127-001	CS1288
8EA737412-001	JS1084	8EA737677-001	CS1164	8EA737912-001	CS1243	8EA738132-001	CS1289
8EA737413-001	JS1085	8EA737680-001	CS1165	8EA737914-001	JS1223	8EA738135-001	CS1290
8EA737415-001	JS1086	8EA737681-001	JS1145	8EA737915-001	CS1244	8EA738136-001	JS1305
8EA737416-001	JS1087	8EA737682-001	CS1166	8EA737919-001	CS1245	8EA738138-001	JS1306
8EA737417-001	CS1067	8EA737683-001	CS1167	8EA737920-001	CS1246	8EA738139-001	JS1307
8EA737419-001	JS1088	8EA737686-001	CS1168	8EA737921-001	CS1247	8EA738142-001	JS1308
8EA737420-001	JS1089	8EA737692-001	CS1169	8EA737934-001	JS1224	8EA738149-001	JS1309
8EA737421-001	CS1068	8EA737693-001	JS1146	8EA737936-001	CS1248	8EA738151-001	CS1291
8EA737422-001	JS1090	8EA737696-001	JS1147	8EA737940-001	CS1249	8EA738152-001	CS1292
8EA737424-001	JS1091	8EA737699-001	JS1148	8EA737942-001	JS1225	8EA738154-001	JS1310
8EA737443-001	CS1069	8EA737700-001	JS1149	8EA737943-001	JS1226	8EA738156-001	CS1293
8EA737446-001	CS1070	8EA737701-001	JS1150	8EA737948-001	JS1227	8EA738157-001	CS1294
8EA737454-001	JS1092	8EA737702-001	JS1151	8EA737949-001	JS1228	8EA738158-001	CS1322
8EA737460-001	CS1071	8EA737703-001	CS1170	8EA737951-001	JS1229	8EA738165-001	CS1323
8EA737463-001	JS1093	8EA737706-001	CS1171	8EA737953-001	CS1250	8EA738166-001	CS1324
8EA737464-001	JS1094	8EA737708-001	CS1172	8EA737958-001	CS1251	8EA738167-001	JS1311
8EA737465-001	JS1095	8EA737709-001	UA1215	8EA737959-001	US1240	8EA738168-001	JS1312
8EA737467-001	CS1072	8EA737711-001	JS1154	8EA737960-001	CS1252	8EA738169-001	JS1313
8EA737468-001	US1027	8EA737722-001	CS1173	8EA737962-001	JS1230	8EA738171-001	JS1314
8EA737474-001	CS1073	8EA737725-001	CS1174	8EA737963-001	JS1231	8EA738173-001	CS1325
8EA737476-001	JS1096	8EA737729-001	CS1175	8EA737966-001	JS1232	8EA738174-001	CS1326
8EA737477-001	JS1097	8EA737730-001	JS1152	8EA737967-001	CS1253	8EA738180-001	JS1315
8EA737478-001	JS1098	8EA737741-001	JS1153	8EA737971-001	JS1233	8EA738181-001	CS1327
8EA737479-001	CS1074	8EA737742-001	CS1176	8EA737972-001	CS1254	8EA738184-001	CS1328
8EA737480-001	JS1099	8EA737744-001	JS1154	8EA737973-001	JS1234	8EA738198-001	CS1329
8EA737484-001	JS1100	8EA737751-001	CS1177	8EA737977-001	CS1255	8EA738199-001	CS1330
8EA737485-001	JS1101	8EA737755-001	CS1178	8EA737979-001	CS1256	8EA738209-001	JS1316
8EA737486-001	JS1102	8EA737760-001	JS1155	8EA737988-001	CS1257	8EA738212-001	CS1331
8EA737487-001	JS1103	8EA737763-001	CS1179	8EA737991-001	JS1235	8EA738223-001	CS1333
8EA737488-001	CS1075	8EA737765-001	CS1180	8EA737999-001	CS1258	8EA738232-001	CS1334
8EA737491-001	CS1076	8EA737766-001	JS1156	8EA738002-001	JS1236	8EA738237-001	JS1321
8EA737494-001	CS1077	8EA737767-001	CS1181	8EA738005-001	JS1237	8EA738239-001	JS1349
8EA737497-001	CS1078	8EA737773-001	CS1182	8EA738007-001	JS1238	8EA738240-001	CS1335
8EA737504-001	CS1106	8EA737775-001	JS1157	8EA738013-001	CS1259	8EA738242-001	CS1337
8EA737506-001	CS1107	8EA737790-001	CS1183	8EA738016-001	CS1260	8EA738244-001	CS1339
8EA737508-001	JS1104	8EA737792-001	CS1184	8EA738022-001	CS1261	8EA738251-001	CS1342
8EA737510-001	JS1105	8EA737793-001	CS1185	8EA738023-001	CS1262	8EA738254-001	CS1343
8EA737512-001	JS1133	8EA737794-001	JS1158	8EA738024-001	CS1263	8EA738255-001	CS1344
8EA737514-001	JS1134	8EA737797-001	CS1186	8EA738026-001	CS1264	8EA738258 -921	CS1394
8EA737517-001	CS1108	8EA737802-001	CS1187	8EA738027-001	CS1265	8EA738258-001	CS1341
8EA737526-001	CS1109	8EA737806-001	JS1159	8EA738028-001	CS1266	8EA738258-011	CS1347
8EA737530-001	US1028	8EA737807-001	JS1214	8EA738029-001	CS1267	8EA738258-021	CS1378
8EA737532-001	CS1110	8EA737815-001	CS1188	8EA738030-001	CS1268	8EA738258-031	CS1387
8EA737537-001	CS1111	8EA737816-001	CS1189	8EA738032-001	JS1239	8EA738258-041	CS1338
8EA737540-001	CS1112	8EA737817-001	CS1190	8EA738034-001	JS1295	8EA738258-051	CS1340
8EA737543-001	JS1135	8EA737818-001	JS1215	8EA738038-001	CS1269	8EA738258-061	CS1376
8EA737545-001	JS1136	8EA737820-001	CS1191	8EA738039-001	JS1296	8EA738258-081	CS1382
8EA737550-001	CS1113	8EA737823-001	CS1192	8EA738040-001	JS1297	8EA738258-091	CS1341
8EA737557-001	CS1114	8EA737830-001	CS1193	8EA738042-001	JS1298	8EA738258-101	CS1379
8EA737559-001	JS1137	8EA737831-001	JS1216	8EA738043-001	JS1299	8EA738258-111	CS1383
8EA737567-001	CS1115	8EA737834-001	CS1194	8EA738050-001	CS1270	8EA738258-121	JS1319
8EA737571-001	CS1116	8EA737842-001	CS1195	8EA738052-001	JS1300	8EA738258-131	JS1355
8EA737575-001	CS1117	8EA737843-001	JS1217	8EA738056-001	CS1271	8EA738258-141	JS1357
8EA737578-001	CS1118	8EA737850-001	CS1196	8EA738060-001	CS1272	8EA738258-151	CS1389
8EA737579-001	CS1119	8EA737852-001	CS1197	8EA738061-001	CS1273	8EA738258-161	CS1390
8EA737582-001	CS1120	8EA737853-001	CS1198	8EA738062-001	JS1301	8EA738258-171	CS1392
8EA737583-001	CS1121	8EA737854-001	CS1199	8EA738069-001	CS1274	8EA738258-181	JS1352
8EA737584-001	CS1122	8EA737856-001	CS1200	8EA738074-001	US1241	8EA738258-191	CS1384
8EA737585-001	CS1123	8EA737859-001	CS1201	8EA738075-001	US1242	8EA738258-201	CS1336
8EA737586-001	JS1138	8EA737864-001	CS1202	8EA738076-001	US1243	8EA738258-211	CS1385
8EA737587-001	CS1124	8EA737865-001	JS1218	8EA738077-001	US1244	8EA738258-221	JS1356
8EA737588-001	JS1139	8EA737867-001	CS1203	8EA738078-001	US1245	8EA738258-231	CS1332

O.E. NO.	HC-PARTS	O.E. NO.	HC-PARTS	O.E. NO.	HC-PARTS	O.E. NO.	HC-PARTS
8EA738258-241	JS1318	8EL725574-001	CA120	8EL725670-001	CA2511R	8EL725757-001	CA3531R
8EA738258-251	JS1353	8EL725575-001	CA1211R	8EL725671-001	CA2521R	8EL725758-001	CA3541R
8EA738258-261	CS1345	8EL725578-001	CA1241R	8EL725672-001	CA2541R	8EL725759-001	CA3551R
8EA738258-271	CS1346	8EL725579-001	CA1251R	8EL725673-001	CA2551R	8EL725760-001	CA3561R
8EA738258-281	CS1377	8EL725580-001	CA1261R	8EL725674-001	CA2591R	8EL725761-001	CA3571R
8EA738258-291	CS1386	8EL725581-001	CA1271R	8EL725675-001	CA2631R	8EL725762-001	CA3581R
8EA738258-301	CS1391	8EL725582-001	CA1281R	8EL725676-001	CA2641R	8EL725763-001	CA3591R
8EA738258-311	CS1396	8EL725583-001	CA1291R	8EL725677-001	CA2681R	8EL725764-001	CA3601R
8EA738258-311	CS613	8EL725584-001	CA1301R	8EL725679-001	CA2711R	8EL725765-001	CA3611R
8EA738258-321	JS1317	8EL725585-001	CA131	8EL725680-001	CA2721R	8EL725766-001	CA3621R
8EA738258-331	JS1320	8EL725586-001	CA1311R	8EL725681-001	CA273	8EL725767-001	CA3631R
8EA738258-341	JS1359	8EL725587-001	CA1321R	8EL725682-001	CA2761R	8EL725768-001	CA3641R
8EA738258-351	JS1361	8EL725588-001	CA134	8EL725683-001	CA2771R	8EL725770-001	CA3661R
8EA738258-361	CS1348	8EL725589-001	CA1361R	8EL725686-001	CA283	8EL725771-001	CA3671R
8EA738258-371	CS1380	8EL725591-001	CA1391R	8EL725687-001	CA2841R	8EL725772-001	CA3681R
8EA738258-381	CS1388	8EL725592-001	CA1401R	8EL725688-001	CA2871R	8EL725773-001	CA3691R
8EA738258-391	JS1350	8EL725593-001	CA1411R	8EL725689-001	CA2881R	8EL725774-001	CA37
8EA738258-401	JS1358	8EL725597-001	CA147	8EL725690-001	CA2891R	8EL725775-001	CA3701R
8EA738258-411	JS1360	8EL725598-001	CA148	8EL725691-001	CA2901R	8EL725776-001	CA3711R
8EA738258-421	JS1362	8EL725599-001	CA1491R	8EL725692-001	CA2911R	8EL725777-001	CA3721R
8EA738258-431	JS1363	8EL725600-001	CA1501R	8EL725693-001	CA292	8EL725778-001	CA3731R
8EA738258-441	JS1366	8EL725602-001	CA1521R	8EL725694-001	CA2931R	8EL725779-001	CA3741R
8EA738258-451	CS1398	8EL725603-001	CA154	8EL725695-001	CA2941R	8EL725780-001	CA3751R
8EA738258-461	CS1401	8EL725604-001	CA1551R	8EL725696-001	CA2951R	8EL725781-001	CA3761R
8EA738258-471	CS1404	8EL725605-001	CA1581R	8EL725697-001	CA2961R	8EL725782-001	CA3771R
8EA738258-481	CS1405	8EL725606-001	CA15H	8EL725698-001	CA2971R	8EL725783-001	CA3781R
8EA738258-491	CS1406	8EL725607-001	CA1631R	8EL725699-001	CA2981R	8EL725784-001	CA3791R
8EA738258-501	CS1407	8EL725608-001	CA164	8EL725700-001	CA2991R	8EL725785-001	CA38
8EA738258-511	CS1408	8EL725609-001	CA1651R	8EL725701-001	CA30	8EL725786-001	CA3801R
8EA738258-521	JS1364	8EL725610-001	CA166	8EL725702-001	CA3001R	8EL725787-001	CA3811R
8EA738258-531	JS1365	8EL725611-001	CA1691R	8EL725703-001	CA3011R	8EL725788-001	CA3821R
8EA738258-541	CS1393	8EL725612-001	CA1701R	8EL725704-001	CA3021R	8EL725789-001	CA3831R
8EA738258-551	CS1402	8EL725614-001	CA1721R	8EL725705-001	CA3031R	8EL725790-001	CA3841R
8EA738258-561	CS1403	8EL725615-001	CA1731R	8EL725706-001	CA304	8EL725792-001	CA42
8EA738258-571	CS1409	8EL725616-001	CA1741R	8EL725707-001	CA3051R	8EL725793-001	CA421R
8EA738258-581	CS1410	8EL725617-001	CA1751R	8EL725708-001	CA3061R	8EL725794-001	CA45
8EA738258-591	CS1411	8EL725618-001	CA1761R	8EL725709-001	CA3071R	8EL725796-001	CA461R
8EA738258-601	CS1412	8EL725619-001	CA1781R	8EL725710-001	CA3081R	8EL725797-001	CA481R
8EA738258-611	CS1415	8EL725620-001	CA17H	8EL725712-001	CA3101R	8EL725798-001	CA48
8EA738258-621	JS1354	8EL725621-001	CA17V	8EL725713-001	CA10281R	8EL725799-001	CA5001R
8EA738258-631	CS1395	8EL725622-001	CA180	8EL725713-001	CA3111R	8EL725800-001	CA5011R
8EA738258-641	CS1413	8EL725623-001	CA183	8EL725714-001	CA3121R	8EL725801-001	CA5021R
8EA738258-651	CS1420	8EL725624-001	CA184	8EL725715-001	CA3131R	8EL725802-001	CA5031R
8EA738258-661	CS1422	8EL725625-001	CA1861R	8EL725716-001	CA3141R	8EL725803-001	CA5041R
8EA738258-671	CS1417	8EL725626-001	CA1871R	8EL725717-001	CA3151R	8EL725804-001	CA5051R
8EA738258-681	CS1424	8EL725627-001	CA1891R	8EL725718-001	CA3161R	8EL725805-001	CA5061R
8EA738258-691	CS1435	8EL725628-001	CA18H	8EL725719-001	CA3171R	8EL725808-001	CA5091R
8EA738258-701	JS1367	8EL725629-001	CA18V	8EL725720-001	CA3181R	8EL725809-001	CA5101R
8EA738258-711	CS1423	8EL725630-001	CA1901R	8EL725721-001	CA3191R	8EL725810-001	CA5111R
8EA738258-721	CS1397	8EL725631-001	CA1911R	8EL725722-001	CA3201R	8EL725811-001	CA5121R
8EA738258-731	CS1399	8EL725632-001	CA1921R	8EL725723-001	CA3211R	8EL725812-001	CA5131R
8EA738258-741	CS1419	8EL725633-001	CA1951R	8EL725724-001	CA3221R	8EL725813-001	CA5141R
8EA738258-751	CS1440	8EL725634-001	CA1961R	8EL725725-001	CA3231R	8EL725814-001	CA5151R
8EA738258-761	CS1438	8EL725635-001	CA1981R	8EL725726-001	CA3241R	8EL725815-001	CA5161R
8EA738258-771	CS1436	8EL725636-001	CA1991R	8EL725727-001	CA3251R	8EL725816-001	CA5171R
8EA738258-781	CS1441	8EL725637-001	CA2051R	8EL725728-001	CA3261R	8EL725817-001	CA5181R
8EA738258-791	CS1445	8EL725639-001	CA2071R	8EL725729-001	CA3271R	8EL725818-001	CA5191R
8EA738258-801	CS1446	8EL725640-001	CA2121R	8EL725730-001	CA3281R	8EL725819-001	CA521R
8EA738258-811	CS1450	8EL725641-001	CA22H	8EL725731-001	CA3291R	8EL725820-001	CA5201R
8EA738258-821	CS1416	8EL725643-001	CA2211R	8EL725734-001	CA3311R	8EL725821-001	CA5211R
8EA738258-831	CS1400	8EL725644-001	CA2221R	8EL725735-001	CA3321R	8EL725822-001	CA5221R
8EA738258-841	CS1421	8EL725646-001	CA2241R	8EL725736-001	CA3331R	8EL725824-001	CA5241R
8EA738258-861	CS1447	8EL725647-001	CA2251R	8EL725737-001	CA3341R	8EL725825-001	CA5251R
8EA738258-871	CS1426	8EL725648-001	CA2261R	8EL725738-001	CA3351R	8EL725826-001	CA5261R
8EA738258-891	CS1449	8EL725649-001	CA2271R	8EL725740-001	CA3371R	8EL725827-001	CA5271R
8EA738258-901	CS1453	8EL725650-001	CA2281R	8EL725741-001	CA3381R	8EL725829-001	CA5291R
8EA738258-931	CS1464	8EL725651-001	CA2291R	8EL725742-001	CA3391R	8EL725830-001	CA5301R
8EA738258-941	CS1467	8EL725652-001	CG19	8EL725743-001	CA3401R	8EL725831-001	CA5321R
8EA749553-001	CS1381	8EL725653-001	CA23V	8EL725744-001	CA3411R	8EL725832-001	CA5331R
8EL725560-001	CA100	8EL725657-001	CA2331R	8EL725745-001	CA3421R	8EL725833-001	CA5341R
8EL725563-001	CA104	8EL725659-001	CA2351R	8EL725746-001	CA3431R	8EL725834-001	CA5351R
8EL725564-001	CA106	8EL725660-001	CA2361R	8EL725747-001	CA344	8EL725835-001	CA5351R
8EL725566-001	CA1101R	8EL725661-001	CA2371R	8EL725748-001	CA3451R	8EL725836-001	CA5371R
8EL725568-001	CA112	8EL725662-001	CA2381R	8EL725750-001	CA3471R	8EL725837-001	CA5381R
8EL725569-001	CA114	8EL725663-001	CA2401R	8EL725752-001	CA3491R	8EL725838-001	CA5391R
8EL725570-001	CA115	8EL725664-001	CA2411R	8EL725753-001	CA351R	8EL725839-001	CA5401R
8EL725571-001	CA117	8EL725665-001	CA2421R	8EL725754-001	CA3501R	8EL725840-001	CA5411R
8EL725572-001	CA118	8EL725666-001	CA2441R	8EL725755-001	CA3511R	8EL725841-001	CA5421R
8EL725573-001	CA1191R	8EL725667-001	CA2461R	8EL725756-001	CA3521R	8EL725842-001	CA5471R

O.E. NO.	HC-PARTS	O.E. NO.	HC-PARTS	O.E. NO.	HC-PARTS	O.E. NO.	HC-PARTS
<b>HELLA <i>Continued</i></b>							
8EL725843-001	CA5481R	8EL725924-001	CA6401R	8EL726305-001	JA1591R	8EL726386-001	JA6711R
8EL725844-001	CA5491R	8EL725925-001	CA6411R	8EL726306-001	JA1601R	8EL726387-001	JA6721R
8EL725845-001	CA551R	8EL725926-001	CA6421R	8EL726307-001	JA1611R	8EL726388-001	JA6731R
8EL725846-001	CA5501R	8EL725927-001	CA6431R	8EL726308-001	JA1621R	8EL726389-001	JA6741R
8EL725847-001	CA5561R	8EL725928-001	CA6441R	8EL726309-001	JA1631R	8EL726390-001	JA6751R
8EL725848-001	CA5571R	8EL725929-001	CA6451R	8EL726310-001	JA1641R	8EL726392-001	JA6771R
8EL725849-001	CA5631R	8EL725930-001	CA6461R	8EL726311-001	JA1651R	8EL726393-001	JA6781R
8EL725851-001	CA5601R	8EL725931-001	CA6471R	8EL726312-001	JA1661R	8EL726395-001	JA6801R
8EL725852-001	CA5611R	8EL725932-001	CA6481R	8EL726313-001	JA1671R	8EL726396-001	JA681
8EL725853-001	CA5621R	8EL725933-001	CA6491R	8EL726314-001	JA168	8EL726527-001	CG16
8EL725854-001	CA5631R	8EL725935-001	CA691R	8EL726315-001	JA170	8EL726528-001	CG17
8EL725855-001	CA5641R	8EL725936-001	CA70	8EL726316-001	JA1711R	8EL726529-001	CG23K
8EL725856-001	CA5661R	8EL725937-001	CA71	8EL726317-001	JA172	8EL726530-001	CG50
8EL725857-001	CA5671R	8EL725941-001	CA75	8EL726318-001	JA1731R	8EL726531-001	CG52
8EL725858-001	CA5681R	8EL725942-001	CA76	8EL726319-001	JA1741R	8EL726532-001	CG58
8EL725859-001	CA5691R	8EL725943-001	CA761R	8EL726320-001	JA1751R	8EL726539-001	UA9431R
8EL725860-001	CA5701R	8EL725944-001	CA771R	8EL726321-001	JA176	8EL726546-001	CA6501R
8EL725861-001	CA5721R	8EL725945-001	CA78	8EL726322-001	JA1771R	8EL726547-001	CA7001R
8EL725862-001	CA5741R	8EL725947-001	CA811R	8EL726323-001	JA1781R	8EL726548-001	CA7011R
8EL725863-001	CA5791R	8EL725948-001	CA84	8EL726324-001	JA1791R	8EL726549-001	JA6821R
8EL725864-001	CA5801R	8EL725949-001	CA841R	8EL726325-001	JA1801R	8EL730000-001	CA7021R
8EL725865-001	CA5811R	8EL725950-001	CA851R	8EL726326-001	JA1811R	8EL730001-001	CA7031R
8EL725866-001	CA5821R	8EL725951-001	CA871R	8EL726327-001	JA1821R	8EL730002-001	CA7041R
8EL725867-001	CA5831R	8EL725952-001	CA88	8EL726328-001	JA1831R	8EL730003-001	CA7051R
8EL725868-001	CA5841R	8EL725953-001	CA881R	8EL726329-001	JA1841R	8EL730004-001	CA7061R
8EL725869-001	CA5861R	8EL725954-001	CA89	8EL726330-001	JA1851R	8EL730005-001	CA7071R
8EL725870-001	CA5871R	8EL725955-001	CA93	8EL726331-001	JA1861R	8EL730006-001	CA7081R
8EL725871-001	CA5881R	8EL725956-001	CA931R	8EL726332-001	JA1871R	8EL730007-001	CA709
8EL725872-001	CA5891R	8EL725957-001	CA941R	8EL726333-001	JA1881R	8EL730008-001	CA7101R
8EL725873-001	CA5901R	8EL725958-001	CA961R	8EL726334-001	JA1891R	8EL730009-001	CA7111R
8EL725874-001	CA5911R	8EL725960-001	CA991R	8EL726335-001	JA190	8EL730010-001	CA7121R
8EL725875-001	CA5921R	8EL726079-001	CS331	8EL726336-001	JA1911R	8EL730011-001	CA7131R
8EL725876-001	CA5931R	8EL726256-001	JA100	8EL726337-001	JA1921R	8EL730012-001	CA7141R
8EL725877-001	CA5941R	8EL726257-001	JA101	8EL726338-001	JA193	8EL730013-001	CA7151R
8EL725878-001	CA5951R	8EL726258-001	JA102	8EL726339-001	JA1941R	8EL730014-001	CA7161R
8EL725879-001	CA5961R	8EL726259-001	JA103	8EL726340-001	JA195	8EL730015-001	CA7171R
8EL725880-001	CA5971R	8EL726260-001	JA1041R	8EL726341-001	JA196	8EL730016-001	CA10301R
8EL725881-001	CA601R	8EL726261-001	JA1051R	8EL726342-001	JA1971R	8EL730016-001	CA7181R
8EL725882-001	CA6001R	8EL726262-001	JA1071R	8EL726343-001	JA1981R	8EL730017-001	CA10311R
8EL725883-001	CA6011R	8EL726263-001	JA1081R	8EL726344-001	JA1991R	8EL730017-001	CA7191R
8EL725884-001	CA6021R	8EL726264-001	JA1091R	8EL726345-001	JA5311R	8EL730018-001	CA7201R
8EL725885-001	CA6031R	8EL726265-001	JA110	8EL726346-001	JA5431R	8EL730019-001	CA721
8EL725886-001	CA6041R	8EL726266-001	JA111	8EL726349-001	JA5461R	8EL730020-001	CA7221R
8EL725887-001	CA6051R	8EL726268-001	JA1131R	8EL726350-001	JA5511R	8EL730021-001	CA7231R
8EL725888-001	CA6061R	8EL726269-001	JA114	8EL726351-001	JA5521R	8EL730022-001	CA7241R
8EL725889-001	CA6071R	8EL726270-001	JA1151R	8EL726352-001	JA5531R	8EL730023-001	CA7251R
8EL725890-001	CA6081R	8EL726271-001	JA1161R	8EL726353-001	JA5541R	8EL730024-001	CA7261R
8EL725891-001	CA6091R	8EL726272-001	JA1171R	8EL726354-001	JA5551R	8EL730025-001	CA7271R
8EL725892-001	CA611R	8EL726273-001	JA118	8EL726355-001	JA5591R	8EL730026-001	CA7281R
8EL725893-001	CA6101R	8EL726274-001	JA119	8EL726356-001	JA5651R	8EL730027-001	CA7291R
8EL725894-001	CA10291R	8EL726275-001	JA120	8EL726357-001	JA5711R	8EL730028-001	CA7301R
8EL725894-001	CA6111R	8EL726276-001	JA121	8EL726358-001	JA5731R	8EL730029-001	CA7311R
8EL725895-001	CA6121R	8EL726277-001	JA1251R	8EL726359-001	JA5751R	8EL730030-001	CA7321R
8EL725896-001	CA6131R	8EL726278-001	JA1271R	8EL726360-001	JA5761R	8EL730031-001	CA7331R
8EL725897-001	CA6141R	8EL726279-001	JA1281R	8EL726361-001	JA5771R	8EL730032-001	CA7341R
8EL725898-001	CA6151R	8EL726280-001	JA1291R	8EL726362-001	JA5781R	8EL730033-001	CA7351R
8EL725899-001	CA6161R	8EL726281-001	JA130	8EL726363-001	JA5851R	8EL730034-001	CA7361R
8EL725900-001	CA6171R	8EL726282-001	JA131	8EL726364-001	JA5981R	8EL730035-001	CA7371R
8EL725901-001	CA6181R	8EL726283-001	JA134	8EL726365-001	JA5991R	8EL730036-001	CA7381R
8EL725902-001	CA6191R	8EL726284-001	JA137	8EL726366-001	JA651	8EL730037-001	CA7391R
8EL725903-001	CA62	8EL726285-001	JA138	8EL726367-001	JA6521R	8EL730038-001	CA7401R
8EL725906-001	CA6221R	8EL726286-001	JA139	8EL726368-001	JA6531R	8EL730039-001	CA741
8EL725907-001	CA6231R	8EL726287-001	JA140	8EL726369-001	JA6541R	8EL730040-001	CA7421R
8EL725908-001	CA624	8EL726288-001	JA1411R	8EL726370-001	JA6551R	8EL730041-001	CA7431R
8EL725909-001	CA6251R	8EL726289-001	JA1421R	8EL726371-001	JA656	8EL730042-001	CA7441R
8EL725910-001	CA6261R	8EL726290-001	JA143	8EL726372-001	JA6571R	8EL730044-001	CA746
8EL725911-001	CA6271R	8EL726291-001	JA144	8EL726373-001	JA6581R	8EL730046-001	CA5501R
8EL725912-001	CA6281R	8EL726293-001	JA1461R	8EL726374-001	JA6591R	8EL730046-001	CA7481R
8EL725913-001	CA6291R	8EL726294-001	JA1471R	8EL726375-001	JA6601R	8EL730047-001	CA2271R
8EL725914-001	CA6301R	8EL726295-001	JA1481R	8EL726376-001	JA6611R	8EL730047-001	CA7491R
8EL725915-001	CA6311R	8EL726296-001	JA149	8EL726377-001	JA6621R	8EL730048-001	CA8081R
8EL725916-001	CA6321R	8EL726297-001	JA1501R	8EL726378-001	JA6631R	8EL730049-001	CA8091R
8EL725917-001	CA6331R	8EL726298-001	JA1511R	8EL726379-001	JA6641R	8EL730050-001	CA8101R
8EL725918-001	CA6341R	8EL726299-001	JA1521R	8EL726380-001	JA6651R	8EL730051-001	CA8111R
8EL725919-001	CA6351R	8EL726300-001	JA153	8EL726381-001	JA6661R	8EL730053-001	CA8131R
8EL725920-001	CA6361R	8EL726301-001	JA1541R	8EL726382-001	JA6671R	8EL730054-001	CA8141R
8EL725921-001	CA6371R	8EL726302-001	JA155	8EL726383-001	JA6681R	8EL730055-001	CA8151R
8EL725922-001	CA6381R	8EL726303-001	JA157	8EL726384-001	JA6691R	8EL730056-001	CA8161R
8EL725923-001	CA6391R	8EL726304-001	JA1581R	8EL726385-001	JA6701R	8EL730057-001	CA8171R



O.E. NO.	HC-PARTS	O.E. NO.	HC-PARTS	O.E. NO.	HC-PARTS	O.E. NO.	HC-PARTS
8EL730058-001	CA818IR	8EL730143-001	UA927	8EL731739-001	JA798IR	8EL732744-001	UA957
8EL730059-001	CA819IR	8EL730144-001	UA928	8EL731740-001	JA799IR	8EL732745-001	UA958IR
8EL730060-001	CA820IR	8EL730145-001	UA929IR	8EL731741-001	JA800	8EL732746-001	UA959
8EL730061-001	CA821IR	8EL730146-001	UA930IR	8EL731742-001	JA801IR	8EL732747-001	UA960
8EL730062-001	CA822IR	8EL730147-001	UA931IR	8EL731743-001	JA802IR	8EL732748-001	UA961
8EL730063-001	CA823IR	8EL730148-001	UA932	8EL731744-001	JA803IR	8EL732749-001	UA962IR
8EL730064-001	CA824IR	8EL730149-001	UA933IR	8EL731745-001	JA804IR	8EL732750-001	UA963IR
8EL730065-001	JA676	8EL730150-001	UA934IR	8EL731746-001	JA805IR	8EL732751-001	UA964IR
8EL730066-001	JA683IR	8EL730151-001	UA935IR	8EL731747-001	JA806IR	8EL732752-001	UA965IR
8EL730067-001	JA684IR	8EL730152-001	UA936IR	8EL731748-001	JA807IR	8EL732753-001	UA966IR
8EL730068-001	JA685IR	8EL730153-001	UA937IR	8EL731749-001	JA862IR	8EL732875-001	JA977IR
8EL730069-001	JA686	8EL730154-001	UA938IR	8EL731750-001	JA863IR	8EL732868-001	JA978IR
8EL730070-001	JA687	8EL730155-001	UA939IR	8EL731751-001	JA864IR	8EL732869-001	JA979IR
8EL730071-001	JA688IR	8EL730156-001	UA940IR	8EL731752-001	JA865IR	8EL732870-001	JA980IR
8EL730072-001	JA689IR	8EL730157-001	UA941IR	8EL731753-001	JA866IR	8EL732871-001	CA1046IR
8EL730073-001	JA690IR	8EL730158-001	UA942IR	8EL731754-001	JA867IR	8EL732872-001	CA1047IR
8EL730074-001	JA691IR	8EL730159-001	UA943IR	8EL731755-001	JA868IR	8EL732873-001	CA1048IR
8EL730075-001	JA692IR	8EL730160-001	UA944IR	8EL731756-001	JA869IR	8EL732874-001	CA1049IR
8EL730076-001	JA693IR	8EL730161-001	UA945IR	8EL731757-001	JA870IR	8EL732875-001	CA1050IR
8EL730077-001	JA694IR	8EL730163-001	UA947IR	8EL731758-001	JA871IR	8EL732876-001	UA967IR
8EL730078-001	JA695IR	8EL730164-001	UA948IR	8EL732688-001	CA905IR	8EL732900-001	CA1045IR
8EL730079-001	JA696IR	8EL730165-001	UA949	8EL732689-001	CA906IR	8EL737001-001	CA1051IR
8EL730084-001	JA697IR	8EL730166-001	UA950	8EL732690-001	CA907IR	8EL737002-001	CA1052IR
8EL730081-001	JA698IR	8EL730167-001	UA951	8EL732691-001	CA908IR	8EL737003-001	CA1053IR
8EL730082-001	JA699IR	8EL730168-001	UA952IR	8EL732692-001	CA909IR	8EL737004-001	CA1054IR
8EL730083-001	JA750IR	8EL730169-001	UA953IR	8EL732693-001	CA910IR	8EL737005-001	CA1055IR
8EL730084-001	JA751IR	8EL730170-001	UA954	8EL732694-001	CA298IR	8EL737006-001	CA1056IR
8EL730085-001	JA752IR	8EL731686-001	CA825IR	8EL732695-001	CA912IR	8EL737007-001	CA1057IR
8EL730086-001	JA753IR	8EL731687-001	CA826IR	8EL732696-001	CA913IR	8EL737008-001	CA1058IR
8EL730087-001	JA754IR	8EL731688-001	CA827IR	8EL732697-001	CA914IR	8EL737009-001	CA1059IR
8EL730088-001	JA755IR	8EL731689-001	CA828IR	8EL732698-001	CA915IR	8EL737010-001	CA1060IR
8EL730089-001	JA756IR	8EL731690-001	CA829IR	8EL732699-001	CA1027IR	8EL737011-001	CA1061IR
8EL730090-001	JA757IR	8EL731691-001	CA830IR	8EL732700-001	CA1028IR	8EL737012-001	CA1063IR
8EL730091-001	JA758IR	8EL731692-001	CA831IR	8EL732700-001	CA311IR	8EL737013-001	CA1064IR
8EL730092-001	JA759IR	8EL731693-001	CA832IR	8EL732701-001	CA1029IR	8EL737014-001	CA1065IR
8EL730093-001	JA760IR	8EL731694-001	CA833IR	8EL732701-001	CA611IR	8EL737015-001	CA1066IR
8EL730094-001	JA761IR	8EL731695-001	CA834IR	8EL732702-001	CA1030IR	8EL737016-001	CA1067IR
8EL730096-001	JA762IR	8EL731696-001	CA835IR	8EL732702-001	CA718IR	8EL737017-001	CA1068IR
8EL730097-001	JA763IR	8EL731697-001	CA836IR	8EL732703-001	CA1031IR	8EL737018-001	CA1069IR
8EL730098-001	JA764IR	8EL731699-001	CA838IR	8EL732703-001	CA719IR	8EL737019-001	CA1070IR
8EL730099-001	JA765IR	8EL731700-001	CA839IR	8EL732704-001	CA1032IR	8EL737020-001	CA1071IR
8EL730100-001	JA766IR	8EL731701-001	CA840IR	8EL732705-001	CA1033IR	8EL737021-001	CA1072IR
8EL730101-001	JA767IR	8EL731702-001	CA841IR	8EL732706-001	CA1034IR	8EL737022-001	CA1073IR
8EL730102-001	JA768IR	8EL731703-001	CA842IR	8EL732707-001	CA1035IR	8EL737023-001	CA1074IR
8EL730103-001	JA769IR	8EL731704-001	CA843IR	8EL732708-001	CA1036IR	8EL737024-001	CA1075IR
8EL730104-001	JA770IR	8EL731705-001	CA844IR	8EL732709-001	CA1037IR	8EL737025-001	CA1076IR
8EL730105-001	JA771IR	8EL731706-001	CA845IR	8EL732710-001	CA1038IR	8EL737026-001	CA1077IR
8EL730106-001	JA772IR	8EL731707-001	CA846IR	8EL732711-001	CA1039IR	8EL737027-001	CA1078IR
8EL730107-001	JA773IR	8EL731708-001	CA847IR	8EL732712-001	CA1040IR	8EL737028-001	CA1079IR
8EL730108-001	JA774IR	8EL731709-001	CA848IR	8EL732713-001	CA1041IR	8EL737029-001	CA1080IR
8EL730109-001	JA775IR	8EL731710-001	CA849IR	8EL732714-001	CA1042IR	8EL737030-001	CA1081IR
8EL730110-001	JA776IR	8EL731711-001	CA850IR	8EL732715-001	CA1043IR	8EL737031-001	CA1082IR
8EL730111-001	JA777	8EL731712-001	CA851IR	8EL732716-001	CA1044IR	8EL737032-001	CA1083IR
8EL730112-001	JA778IR	8EL731713-001	CA852IR	8EL732717-001	CA1062IR	8EL737033-001	CA1084IR
8EL730113-001	JA779IR	8EL731714-001	CA853IR	8EL732718-001	JA872	8EL737034-001	CA1085IR
8EL730114-001	JA780IR	8EL731715-001	CA854IR	8EL732719-001	JA873IR	8EL737035-001	CA1086IR
8EL730116-001	JA782IR	8EL731716-001	CA855IR	8EL732720-001	JA874IR	8EL737036-001	CA1087IR
8EL730117-001	JA783IR	8EL731717-001	CA856IR	8EL732722-001	JA876IR	8EL737037-001	CA1088IR
8EL730118-001	JA784	8EL731718-001	CA857IR	8EL732723-001	JA877IR	8EL737038-001	CA1089IR
8EL730119-001	JA785IR	8EL731719-001	CA858IR	8EL732724-001	JA878IR	8EL737039-001	CA1090IR
8EL730121-001	JA787IR	8EL731720-001	CA859IR	8EL732725-001	JA879IR	8EL737040-001	CA1091IR
8EL730122-001	JA788	8EL731721-001	CA860IR	8EL732726-001	JA880IR	8EL737041-001	CA1092IR
8EL730123-001	JA789IR	8EL731722-001	CA861IR	8EL732727-001	JA881IR	8EL737042-001	CA1093IR
8EL730124-001	JA790IR	8EL731723-001	CA889IR	8EL732728-001	JA882IR	8EL737043-001	CA1094IR
8EL730126-001	JA792IR	8EL731724-001	CA890IR	8EL732729-001	JA883IR	8EL737044-001	CA1095IR
8EL730127-001	JA793IR	8EL731725-001	CA891IR	8EL732730-001	JA884IR	8EL737045-001	CA1096IR
8EL730129-001	JA795IR	8EL731726-001	CA892IR	8EL732731-001	JA885IR	8EL737046-001	CA1097IR
8EL730130-001	JA796IR	8EL731727-001	CA893IR	8EL732732-001	JA886IR	8EL737047-001	CA1098IR
8EL730132-001	UA916	8EL731728-001	CA894IR	8EL732733-001	JA887IR	8EL737048-001	CA1099IR
8EL730133-001	UA917	8EL731729-001	CA895IR	8EL732734-001	JA888IR	8EL737049-001	CA1100IR
8EL730134-001	UA918	8EL731730-001	CA896IR	8EL732735-001	JA970IR	8EL737050-001	CA1101IR
8EL730135-001	UA919IR	8EL731731-001	CA897IR	8EL732736-001	JA971IR	8EL737051-001	CA1103IR
8EL730136-001	UA920IR	8EL731732-001	CA898IR	8EL732737-001	JA972IR	8EL737052-001	CA1104IR
8EL730137-001	UA921IR	8EL731733-001	CA899IR	8EL732738-001	JA973IR	8EL737053-001	CA1105IR
8EL730138-001	UA922	8EL731734-001	CA900IR	8EL732739-001	JA974IR	8EL737054-001	CA1106IR
8EL730139-001	UA923IR	8EL731735-001	CA901IR	8EL732740-001	JA975IR	8EL737055-001	CA1107IR
8EL730140-001	UA924IR	8EL731736-001	CA902IR	8EL732741-001	JA976IR	8EL737056-001	JA981IR
8EL730141-001	UA925IR	8EL731737-001	CA903IR	8EL732742-001	UA955IR	8EL737057-001	JA982
8EL730142-001	UA926	8EL731738-001	CA904IR	8EL732743-001	UA956	8EL737058-001	JA983IR

O.E. NO.	HC-PARTS	O.E. NO.	HC-PARTS	O.E. NO.	HC-PARTS	O.E. NO.	HC-PARTS
<b>HELLA <i>Continued</i></b>							
8EL737059-001	JA984IR	8EL737224-001	JA1169IR	8EL737386-001	CA1250IR	8EL737515-001	CA1334IR
8EL737060-001	JA985IR	8EL737225-001	JA1170IR	8EL737387-001	JA1274IR	8EL737516-001	CA1335IR
8EL737061-001	JA986IR	8EL737226-001	JA1171IR	8EL737388-001	JA1275IR	8EL737518-001	CA1336IR
8EL737062-001	JA987IR	8EL737227-001	UA1110IR	8EL737390-001	JA1276IR	8EL737519-001	JA1353IR
8EL737063-001	JA988IR	8EL737228-001	UA1111IR	8EL737391-001	JA1277IR	8EL737520-001	CA1337IR
8EL737064-001	JA989IR	8EL737229-001	UA1112IR	8EL737392-001	JA1278IR	8EL737521-001	CA1338IR
8EL737065-001	JA990IR	8EL737230-001	UA1113IR	8EL737393-001	JA1279IR	8EL737522-001	JA1354IR
8EL737066-001	JA991IR	8EL737232-001	UA1115IR	8EL737394-001	JA1280IR	8EL737523-001	JA1355IR
8EL737067-001	JA992IR	8EL737233-001	UA1210IR	8EL737395-001	JA1281IR	8EL737524-001	JA1356IR
8EL737068-001	JA994IR	8EL737234-001	UA1211	8EL737396-001	JA1282IR	8EL737525-001	JA1357IR
8EL737069-001	JA995IR	8EL737275-001	CA1201IR	8EL737397-001	CA1251IR	8EL737527-001	CA1339IR
8EL737070-001	JA996IR	8EL737276-001	CA1202IR	8EL737398-001	CA1252IR	8EL737528-001	JA1358IR
8EL737071-001	JA1116IR	8EL737277-001	CA1203IR	8EL737399-001	CA1253IR	8EL737529-001	CA1340IR
8EL737072-001	JA1117IR	8EL737278-001	CA1204IR	8EL737400-001	CA1254IR	8EL737531-001	JA1359IR
8EL737073-001	JA1118IR	8EL737280-001	CA1206IR	8EL737401-001	CA1255IR	8EL737533-001	CA1360IR
8EL737074-001	JA1119IR	8EL737281-001	CA1207IR	8EL737402-001	CA1256IR	8EL737534-001	JA1361IR
8EL737075-001	JA1120IR	8EL737282-001	CA1208IR	8EL737404-001	CA1257IR	8EL737535-001	CA1341IR
8EL737076-001	JA1121IR	8EL737283-001	CA1209IR	8EL737405-001	CA1258IR	8EL737536-001	JA1362
8EL737077-001	JA1122IR	8EL737284-001	CA1216IR	8EL737414-001	JA1283	8EL737538-001	CA1342IR
8EL737078-001	UA968IR	8EL737285-001	CA1217IR	8EL737418-001	CA1259IR	8EL737539-001	CA1343IR
8EL737079-001	UA969	8EL737286-001	CA1218IR	8EL737423-001	CA1260IR	8EL737541-001	CA1344IR
8EL737080-001	UA1108IR	8EL737287-001	CA1219IR	8EL737425-001	CA1261IR	8EL737542-001	CA1345IR
8EL737142-001	CA1136IR	8EL737295-001	CA1220IR	8EL737426-001	JA1284IR	8EL737544-001	CA1346IR
8EL737143-001	JA1123IR	8EL737296-001	CA1221IR	8EL737428-001	JA1286IR	8EL737546-001	CA1347IR
8EL737144-001	JA1124	8EL737297-001	CA1222IR	8EL737429-001	CA1262IR	8EL737547-001	JA1363IR
8EL737156-001	CA1102IR	8EL737298-001	CA1223IR	8EL737432-001	CA1265IR	8EL737548-001	JA1364IR
8EL737157-001	CA1137IR	8EL737299-001	CA1224IR	8EL737433-001	CA1266IR	8EL737549-001	CA1348IR
8EL737158-001	CA1138IR	8EL737301-001	JA1172IR	8EL737434-001	CA1267IR	8EL737551-001	CA1349IR
8EL737159-001	CA1139IR	8EL737302-001	CA1225IR	8EL737435-001	CA1268IR	8EL737552-001	CA1350IR
8EL737160-001	CA1140IR	8EL737303-001	JA165IR	8EL737436-001	CA1269IR	8EL737553-001	JA1365IR
8EL737161-001	CA1141IR	8EL737304-001	JA1173IR	8EL737437-001	CA1297IR	8EL737554-001	CA1378IR
8EL737162-001	CA1142IR	8EL737305-001	CA1226IR	8EL737438-001	CA1298IR	8EL737555-001	CA1379IR
8EL737163-001	CA1143IR	8EL737307-001	CA1227IR	8EL737439-001	CA1299IR	8EL737556-001	JA1366IR
8EL737164-001	CA1144IR	8EL737307-001	CA305IR	8EL737440-001	CA1300IR	8EL737558-001	JA1367IR
8EL737165-001	JA1125	8EL737308-001	JA1174IR	8EL737441-001	CA1301IR	8EL737560-001	CA1380IR
8EL737166-001	JA1126IR	8EL737309-001	CA1228IR	8EL737442-001	CA1302IR	8EL737561-001	CA1381IR
8EL737167-001	JA1127IR	8EL737310-001	CA1229IR	8EL737444-001	CA1303IR	8EL737562-001	CA1382IR
8EL737168-001	JA1128IR	8EL737311-001	JA1175IR	8EL737445-001	CA1304IR	8EL737563-001	CA1383IR
8EL737169-001	JA1130IR	8EL737315-001	JA1176IR	8EL737447-001	CA1305IR	8EL737564-001	CA1384IR
8EL737170-001	JA1131IR	8EL737316-001	JA1177IR	8EL737448-001	CA1306IR	8EL737565-001	CA1385IR
8EL737171-001	JA1132IR	8EL737321-001	JA1178IR	8EL737449-001	CA1307IR	8EL737566-001	CA1386IR
8EL737172-001	JA1133IR	8EL737323-001	JA1179IR	8EL737450-001	CA1308IR	8EL737568-001	JA1368IR
8EL737173-001	JA1134IR	8EL737324-001	JA1180IR	8EL737451-001	CA1309IR	8EL737569-001	JA1369IR
8EL737174-001	JA1162IR	8EL737325-001	JA1181IR	8EL737452-001	CA1310IR	8EL737570-001	JA1370IR
8EL737175-001	JA1163IR	8EL737327-001	JA1182IR	8EL737453-001	CA1311IR	8EL737572-001	CA1387IR
8EL737176-001	JA1164IR	8EL737328-001	JA1183IR	8EL737455-001	CA1312IR	8EL737573-001	CA1388IR
8EL737177-001	JA1165IR	8EL737329-001	JA1129IR	8EL737456-001	JA1287IR	8EL737574-001	JA1371IR
8EL737178-001	UA1109IR	8EL737339-001	JA1184IR	8EL737457-001	CA1313IR	8EL737576-001	CA1389IR
8EL737192-001	CA1145IR	8EL737343-001	CA1230IR	8EL737458-001	JA1288IR	8EL737577-001	CA1390IR
8EL737193-001	CA1146IR	8EL737344-001	CA1231IR	8EL737459-001	CA1314IR	8EL737580-001	CA1391IR
8EL737194-001	CA1147IR	8EL737347-001	CA1232IR	8EL737461-001	CA1315IR	8EL737581-001	JA1372IR
8EL737195-001	CA1148IR	8EL737349-001	UA1212	8EL737462-001	JA1289IR	8EL737589-001	JA1373IR
8EL737196-001	CA1149IR	8EL737350-001	UA1213	8EL737466-001	JA1290IR	8EL737590-001	CA1392IR
8EL737197-001	CA1150IR	8EL737352-001	JA1185IR	8EL737469-001	CA1316IR	8EL737591-001	CA1393IR
8EL737198-001	CA1151IR	8EL737353-001	JA1186IR	8EL737470-001	CA1317IR	8EL737592-001	JA1374IR
8EL737199-001	CA1152IR	8EL737354-001	JA1187IR	8EL737471-001	JA1291IR	8EL737593-001	CA1394IR
8EL737200-001	CA1153IR	8EL737355-001	JA1188IR	8EL737472-001	JA1292IR	8EL737595-001	CA1395IR
8EL737201-001	CA1154IR	8EL737359-001	CA1233IR	8EL737473-001	JA1293IR	8EL737596-001	JA1375IR
8EL737202-001	CA1155IR	8EL737360-001	CA1234IR	8EL737475-001	CA1318IR	8EL737597-001	JA1376IR
8EL737203-001	CA1156IR	8EL737363-001	CA1235IR	8EL737481-001	JA1294IR	8EL737598-001	CA1396IR
8EL737204-001	CA1157IR	8EL737364-001	CA1236IR	8EL737482-001	JA1295IR	8EL737599-001	CA1397IR
8EL737205-001	CA1158IR	8EL737365-001	CA1237IR	8EL737483-001	JA1296IR	8EL737600-001	CA1398IR
8EL737206-001	CA1159IR	8EL737366-001	CA1238IR	8EL737489-001	CA1319IR	8EL737601-001	CA1399IR
8EL737207-001	CA1160IR	8EL737367-001	CA1239IR	8EL737490-001	CA1320IR	8EL737602-001	JA1377IR
8EL737208-001	CA1161IR	8EL737368-001	CA1240IR	8EL737492-001	CA1321IR	8EL737603-001	CA1400IR
8EL737209-001	CA1189IR	8EL737369-001	CA1241IR	8EL737493-001	CA1322IR	8EL737604-001	JA1405IR
8EL737210-001	CA1190IR	8EL737370-001	UA1214	8EL737495-001	JA1351IR	8EL737606-001	CA1401IR
8EL737211-001	CA1191IR	8EL737371-001	CA1242IR	8EL737496-001	CA1323IR	8EL737607-001	CA1402IR
8EL737212-001	CA1192IR	8EL737372-001	CA1243IR	8EL737498-001	CA1324IR	8EL737610-001	JA1406IR
8EL737213-001	CA1193IR	8EL737374-001	JA1270	8EL737499-001	CA1325IR	8EL737611-001	CA1403IR
8EL737214-001	CA1194IR	8EL737375-001	JA1271IR	8EL737500-001	CA1326IR	8EL737612-001	JA1407IR
8EL737216-001	CA1196IR	8EL737377-001	CA1244IR	8EL737501-001	CA1327IR	8EL737613-001	CA384IR
8EL737217-001	CA1197IR	8EL737378-001	CA1245IR	8EL737502-001	CA1328IR	8EL737616-001	JA1408IR
8EL737218-001	CA1198IR	8EL737379-001	CA1246IR	8EL737503-001	CA1329IR	8EL737617-001	CA1433IR
8EL737219-001	CA1199IR	8EL737380-001	CA1247IR	8EL737505-001	JA1352IR	8EL737618-001	CA1434IR
8EL737220-001	CA1200IR	8EL737381-001	CA1248IR	8EL737507-001	CA1330IR	8EL737619-001	CA1435IR
8EL737221-001	JA1166IR	8EL737382-001	CA827IR	8EL737509-001	CA1331IR	8EL737620-001	JA1409
8EL737222-001	JA1167IR	8EL737383-001	JA1272IR	8EL737511-001	CA1332IR	8EL737624-001	JA1410IR
8EL737223-001	JA1168IR	8EL737384-001	JA1273IR	8EL737513-001	CA1333IR	8EL737625-001	JA1411IR

O.E. NO.	HC-PARTS	O.E. NO.	HC-PARTS	O.E. NO.	HC-PARTS	O.E. NO.	HC-PARTS
8EL737626-001.....	CA1436IR	8EL737728-001.....	JA1431IR	8EL737844-001.....	CA1572IR	8EL737974-001.....	JA1614IR
8EL737630-001.....	JA1412IR	8EL737731-001.....	CA1491IR	8EL737845-001.....	CA1573IR	8EL737975-001.....	CA1655IR
8EL737631-001.....	JA1413IR	8EL737736-001.....	JA1513IR	8EL737846-001.....	CA1574IR	8EL737976-001.....	CA1656IR
8EL737632-001.....	CA1437IR	8EL737737-001.....	JA1514IR	8EL737847-001.....	CA1575IR	8EL737978-001.....	CA1657IR
8EL737633-001.....	CA1438IR	8EL737738-001.....	CA1492IR	8EL737848-001.....	CA1576IR	8EL737980-001.....	CA1658IR
8EL737634-001.....	CA1439IR	8EL737739-001.....	CA1493IR	8EL737849-001.....	CA1577IR	8EL737981-001.....	CA1659IR
8EL737635-001.....	CA1440IR	8EL737740-001.....	CA1494IR	8EL737851-001.....	JA1537IR	8EL737982-001.....	CA1660IR
8EL737636-001.....	JA1414IR	8EL737743-001.....	JA1515IR	8EL737855-001.....	CA1578IR	8EL737983-001.....	CA1661IR
8EL737638-001.....	CA1441IR	8EL737745-001.....	CA1495IR	8EL737857-001.....	CA1579IR	8EL737984-001.....	CA1662IR
8EL737639-001.....	CA1442IR	8EL737746-001.....	CA1496IR	8EL737858-001.....	UA1538IR	8EL737985-001.....	CA1663IR
8EL737641-001.....	CA1443IR	8EL737747-001.....	CA1497IR	8EL737860-001.....	CA1580IR	8EL737986-001.....	CA1664IR
8EL737642-001.....	CA1444IR	8EL737748-001.....	CA1498IR	8EL737861-001.....	CA1581IR	8EL737987-001.....	CA1665IR
8EL737643-001.....	CA1445IR	8EL737749-001.....	CA1499IR	8EL737862-001.....	CA1582IR	8EL737989-001.....	CA1666IR
8EL737644-001.....	CA1446IR	8EL737750-001.....	CA1500IR	8EL737863-001.....	CA1583IR	8EL737990-001.....	JA1615IR
8EL737645-001.....	CA1447IR	8EL737752-001.....	JA1516IR	8EL737866-001.....	CA1584IR	8EL737992-001.....	CA1667IR
8EL737646-001.....	CA1496IR	8EL737753-001.....	CA1501IR	8EL737868-001.....	CA1585IR	8EL737993-001.....	JA1616IR
8EL737646-001.....	JA1415IR	8EL737754-001.....	CA1502IR	8EL737871-001.....	CA1586IR	8EL737994-001.....	CA1668IR
8EL737647-001.....	CA1448IR	8EL737756-001.....	CA1503IR	8EL737872-001.....	CA1587IR	8EL737995-001.....	CA1669IR
8EL737647-001.....	CA1497IR	8EL737757-001.....	CA1504IR	8EL737873-001.....	CA1588IR	8EL737996-001.....	CA1670IR
8EL737648-001.....	CA1449IR	8EL737758-001.....	CA1505IR	8EL737874-001.....	CA1589IR	8EL737997-001.....	CA1671IR
8EL737648-001.....	CA1498IR	8EL737759-001.....	CA1506IR	8EL737875-001.....	CA1590IR	8EL737998-001.....	CA1672IR
8EL737649-001.....	CA1499IR	8EL737761-001.....	CA1507IR	8EL737877-001.....	JA1539IR	8EL738001-001.....	CA1673IR
8EL737649-001.....	JA1416IR	8EL737762-001.....	CA1508IR	8EL737879-001.....	JA1594IR	8EL738003-001.....	CA1674IR
8EL737650-001.....	JA1417IR	8EL737764-001.....	JA1517IR	8EL737883-001.....	JA1595IR	8EL738004-001.....	UA1620IR
8EL737651-001.....	CA1450IR	8EL737768-001.....	CA1509IR	8EL737884-001.....	JA1596IR	8EL738006-001.....	CA1675IR
8EL737652-001.....	JA1418IR	8EL737769-001.....	CA1510IR	8EL737885-001.....	CA1591IR	8EL738008-001.....	CA1676IR
8EL737653-001.....	CA1451IR	8EL737770-001.....	CA1511IR	8EL737886-001.....	CA1592IR	8EL738009-001.....	CA1677IR
8EL737654-001.....	CA1452IR	8EL737771-001.....	CA1512IR	8EL737887-001.....	CA1593IR	8EL738010-001.....	CA1678IR
8EL737655-001.....	CA1453IR	8EL737772-001.....	JA1518IR	8EL737888-001.....	CA1621IR	8EL738011-001.....	CA1679IR
8EL737657-001.....	CA1454IR	8EL737774-001.....	JA1519IR	8EL737889-001.....	CA1622IR	8EL738012-001.....	CA1680IR
8EL737658-001.....	CA1455IR	8EL737776-001.....	JA1520IR	8EL737890-001.....	CA1623IR	8EL738014-001.....	CA1681IR
8EL737661-001.....	CA1456IR	8EL737777-001.....	CA1540IR	8EL737894-001.....	CA1624IR	8EL738015-001.....	CA1682IR
8EL737662-001.....	CA1457IR	8EL737778-001.....	CA1541IR	8EL737895-001.....	CA1625IR	8EL738017-001.....	JA1617IR
8EL737663-001.....	CA1458IR	8EL737779-001.....	CA1542IR	8EL737896-001.....	CA1626IR	8EL738018-001.....	JA1618IR
8EL737664-001.....	CA1459IR	8EL737780-001.....	CA1543IR	8EL737897-001.....	JA1597IR	8EL738019-001.....	CA1683IR
8EL737665-001.....	CA1460IR	8EL737781-001.....	CA1544IR	8EL737898-001.....	JA1598	8EL738020-001.....	CA1684IR
8EL737666-001.....	CA1461IR	8EL737782-001.....	CA1545IR	8EL737902-001.....	CA1627IR	8EL738021-001.....	CA1685IR
8EL737667-001.....	CA1462IR	8EL737783-001.....	CA1546IR	8EL737903-001.....	CA1628IR	8EL738025-001.....	CA1686IR
8EL737668-001.....	CA1463IR	8EL737784-001.....	CA1547IR	8EL737907-001.....	CA1629IR	8EL738031-001.....	JA1702IR
8EL737669-001.....	CA1464IR	8EL737785-001.....	CA1548IR	8EL737908-001.....	JA1599IR	8EL738033-001.....	JA1703IR
8EL737670-001.....	CA1465IR	8EL737786-001.....	CA1549IR	8EL737909-001.....	CA1630IR	8EL738035-001.....	CA1687IR
8EL737671-001.....	CA1466IR	8EL737787-001.....	CA1550IR	8EL737910-001.....	CA1631IR	8EL738036-001.....	CA1688IR
8EL737672-001.....	CA1467IR	8EL737788-001.....	CA1551IR	8EL737913-001.....	CA1632IR	8EL738037-001.....	JA1704IR
8EL737673-001.....	CA1468IR	8EL737789-001.....	CA1552IR	8EL737916-001.....	CA1633IR	8EL738041-001.....	CA1689IR
8EL737674-001.....	CA1469IR	8EL737791-001.....	CA1553IR	8EL737917-001.....	JA1600IR	8EL738044-001.....	JA1705
8EL737675-001.....	JA1419IR	8EL737795-001.....	JA1521IR	8EL737918-001.....	JA1601IR	8EL738045-001.....	JA1706
8EL737678-001.....	CA1470IR	8EL737796-001.....	JA1522IR	8EL737922-001.....	JA1602IR	8EL738046-001.....	JA1707
8EL737679-001.....	CA1471IR	8EL737798-001.....	JA1523IR	8EL737923-001.....	JA1603IR	8EL738047-001.....	CA1690IR
8EL737684-001.....	CA1472IR	8EL737799-001.....	JA1524IR	8EL737924-001.....	JA1604IR	8EL738048-001.....	CA1691IR
8EL737685-001.....	CA1473IR	8EL737800-001.....	JA1525IR	8EL737925-001.....	CA1634IR	8EL738049-001.....	CA1692IR
8EL737687-001.....	JA1420IR	8EL737801-001.....	CA1554IR	8EL737926-001.....	CA1635IR	8EL738051-001.....	JA1613IR
8EL737688-001.....	CA1474IR	8EL737803-001.....	JA1526IR	8EL737927-001.....	CA1636IR	8EL738053-001.....	CA1693IR
8EL737689-001.....	CA1475IR	8EL737804-001.....	CA1555IR	8EL737928-001.....	CA1637IR	8EL738054-001.....	CA1694IR
8EL737690-001.....	CA1591IR	8EL737805-001.....	JA1527IR	8EL737929-001.....	CA1638IR	8EL738055-001.....	CA1695IR
8EL737691-001.....	CA1477IR	8EL737808-001.....	CA1556IR	8EL737930-001.....	CA1639IR	8EL738057-001.....	CA1696IR
8EL737694-001.....	JA1421IR	8EL737809-001.....	JA1528IR	8EL737931-001.....	CA1640IR	8EL738058-001.....	CA1697IR
8EL737695-001.....	CA1478IR	8EL737810-001.....	JA1529	8EL737932-001.....	CA1641IR	8EL738059-001.....	CA1698IR
8EL737697-001.....	JA1422IR	8EL737811-001.....	CA1557IR	8EL737933-001.....	CA1642IR	8EL738063-001.....	CA1699IR
8EL737698-001.....	CA1479IR	8EL737812-001.....	CA1558IR	8EL737935-001.....	CA1643IR	8EL738064-001.....	CA1700IR
8EL737704-001.....	CA1480IR	8EL737813-001.....	CA1559IR	8EL737937-001.....	CA1644IR	8EL738065-001.....	CA1701IR
8EL737705-001.....	JA1423IR	8EL737814-001.....	CA1560IR	8EL737938-001.....	CA1645IR	8EL738066-001.....	CA1729IR
8EL737707-001.....	CA1481IR	8EL737819-001.....	JA1530IR	8EL737939-001.....	JA1605IR	8EL738067-001.....	CA1730IR
8EL737709-001.....	UA1215	8EL737821-001.....	CA1561IR	8EL737941-001.....	JA1606IR	8EL738068-001.....	CA1731IR
8EL737710-001.....	CA1482IR	8EL737822-001.....	CA1562IR	8EL737944-001.....	JA1607IR	8EL738070-001.....	CA1732IR
8EL737711-001.....	CA1483IR	8EL737824-001.....	CA1563IR	8EL737945-001.....	JA1608IR	8EL738071-001.....	CA1733IR
8EL737712-001.....	CA1484IR	8EL737825-001.....	CA1564IR	8EL737946-001.....	CA1646IR	8EL738072-001.....	JA1708IR
8EL737713-001.....	CA1485IR	8EL737826-001.....	JA1531IR	8EL737947-001.....	CA1647IR	8EL738073-001.....	JA1709IR
8EL737714-001.....	CA1486IR	8EL737827-001.....	JA1532IR	8EL737950-001.....	JA1609IR	8EL738079-001.....	JA1710IR
8EL737715-001.....	CA1487IR	8EL737828-001.....	JA1533IR	8EL737952-001.....	UA1619	8EL738082-001.....	CA1734IR
8EL737716-001.....	CA1488IR	8EL737829-001.....	CA1565IR	8EL737954-001.....	JA1610	8EL738083-001.....	CA1735IR
8EL737717-001.....	JA1424IR	8EL737832-001.....	CA1566IR	8EL737955-001.....	JA1611IR	8EL738084-001.....	CA1736IR
8EL737718-001.....	JA1425IR	8EL737833-001.....	CA1567IR	8EL737956-001.....	CA1648IR	8EL738085-001.....	CA1737IR
8EL737719-001.....	JA1426IR	8EL737835-001.....	CA1568IR	8EL737957-001.....	CA1649IR	8EL738086-001.....	JA1711IR
8EL737720-001.....	JA1427IR	8EL737836-001.....	CA1569IR	8EL737961-001.....	JA1612IR	8EL738087-001.....	JA1712IR
8EL737721-001.....	JA1428IR	8EL737837-001.....	JA1534IR	8EL737964-001.....	CA1650IR	8EL738088-001.....	JA1713IR
8EL737723-001.....	JA1429IR	8EL737838-001.....	JA1535IR	8EL737965-001.....	CA1651IR	8EL738090-001.....	CA1738IR
8EL737724-001.....	CA1489IR	8EL737839-001.....	JA1536IR	8EL737968-001.....	CA1652IR	8EL738093-001.....	CA1739IR
8EL737726-001.....	JA1430IR	8EL737840-001.....	CA1570IR	8EL737969-001.....	CA1653IR	8EL738094-001.....	JA1740IR
8EL737727-001.....	CA1490IR	8EL737841-001.....	CA1571IR	8EL737970-001.....	CA1654IR	8EL738096-001.....	CA1741IR

O.E. NO.	HC-PARTS	O.E. NO.	HC-PARTS	O.E. NO.	HC-PARTS	O.E. NO.	HC-PARTS
<b>HELLA <i>Continued</i></b>				<b>HITACHI</b>			
8EL738097-001	JA1714IR	8EL738211-031	CA1856IR	8EL738211-841	JA1900IR	LR1100-501	JA1370IR
8EL738099-001	CA1742IR	8EL738211-041	CA1869IR	8EL738211-851	CA1918IR	LR1100-501B	JA1370IR
8EL738100-001	CA1743IR	8EL738211-051	CA1872IR	8EL738211-861	CA1927IR	LR1100-502	JA1521IR
8EL738102-001	JA1715IR	8EL738211-061	JA1805IR	8EL738211-871	CA1936IR	LR1100-502B	JA1521IR
8EL738103-001	JA1716IR	8EL738211-071	JA1809IR	8EL738211-881	CA1944IR	LR1100-502C	JA1521IR
8EL738104-001	JA1717IR	8EL738211-081	CA1855IR	8EL738211-891	CA1975IR	LR1100-502D	JA1521IR
8EL738106-001	JA1718IR	8EL738211-091	CA1859IR	8EL738211-901	CA1976IR	LR1100-502E	JA1521IR
8EL738109-001	JA1719IR	8EL738211-101	CA1861IR	8EL738211-911	CA1977IR	LR1100-502F	JA1521IR
8EL738112-001	CA1744IR	8EL738211-111	CA1851IR	8EL738211-921	CA1919IR	LR1100-502G	JA1521IR
8EL738114-001	CA1745IR	8EL738211-121	CA1853IR	8EL738211-931	CA1925IR	LR1100-502H	JA1521IR
8EL738115-001	CA1746IR	8EL738211-131	CA1854IR	8EL738211-941	CA1963IR	LR1100-502J	JA1521IR
8EL738116-001	CA1747IR	8EL738211-141	CA1860IR	8EL738211-951	CA1967IR	LR1100-502K	JA1521IR
8EL738117-001	CA1748IR	8EL738211-151	CA1862IR	8EL738211-961	CA1945IR	LR1100-502L	JA1521IR
8EL738118-001	JA1720IR	8EL738211-161	JA1797IR	8EL738211-971	CA1923IR	LR1100-502M	JA1521IR
8EL738121-001	CA1749IR	8EL738211-171	JA1807IR	8EL738211-981	CA1878IR	LR1100-502N	JA1521IR
8EL738122-001	CA1750IR	8EL738211-181	JA1897IR	8EL738212-011	CA1960IR	LR1100-503	JA1901IR
8EL738123-001	CA1751IR	8EL738211-191	CA1841IR	8EL738212-021	CA1978IR	LR1100-503A	JA1901IR
8EL738124-001	JA1721IR	8EL738211-201	CA1846IR	8EL738212-031	CA1906IR	LR1100-503B	JA1901IR
8EL738125-001	CA1752IR	8EL738211-211	CA1848IR	8EL738212-041	CA1968IR	LR1100-503C	JA1901IR
8EL738126-001	CA1753IR	8EL738211-221	CA1850IR	8EL738212-051	CA1989IR	LR1100-503E	JA1901IR
8EL738128-001	CA1754IR	8EL738211-231	CA1863IR	8EL738212-071	CA1921IR	LR1100-503F	JA1901IR
8EL738129-001	CA1755IR	8EL738211-241	CA1868IR	8EL738212-081	CA1956IR	LR1100-504C	JA1521IR
8EL738130-001	CA1756IR	8EL738211-251	CA1870IR	8EL738212-091	CA1959IR	LR1100-504E	JA1521IR
8EL738131-001	CA1757IR	8EL738211-261	CA1871IR	8EL738212-101	CA1974IR	LR1100-505	JA1521IR
8EL738133-001	JA1722IR	8EL738211-271	CA1876IR	8EL738212-111	CA1981IR	LR1100-505B	JA1521IR
8EL738134-001	CA1758IR	8EL738211-281	JA1803IR	8EL738212-121	CA1985IR	LR1100-505E	JA1521IR
8EL738137-001	JA1723IR	8EL738211-291	JA1804IR	8EL738212-131	CA1928IR	LR1100-507	JA1899IR
8EL738140-001	CA1759IR	8EL738211-301	JA1894IR	8EL738212-141	CA1922IR	LR1100-507B	JA1899IR
8EL738141-001	CA1760IR	8EL738211-311	JA1895IR	8EL738212-151	CA1957IR	LR1100-507C	JA1899IR
8EL738143-001	JA1724IR	8EL738211-321	CA1830IR	8EL738212-161	CA1973IR	LR1100-508	JA1899IR
8EL738144-001	CA1761IR	8EL738211-331	CA1834IR	8EL738212-171	CA1988IR	LR1100-508B	JA1899IR
8EL738145-001	JA1725IR	8EL738211-341	CA1839IR	8EL738212-181	CA1992IR	LR1100-508C	JA1899IR
8EL738146-001	JA1726IR	8EL738211-351	CA1840IR	8EL738212-191	CA1994IR	LR1100-508E	JA1899IR
8EL738147-001	CA1762IR	8EL738211-361	CA1845IR	8EL738212-191	CA2045IR	LR1100-508F	JA1899IR
8EL738148-001	CA1763IR	8EL738211-371	JA1806IR	8EL738212-201	CA1996IR	LR1100-703	JA1357IR
8EL738150-001	JA1727IR	8EL738211-381	CA1857IR	8EL738212-211	CA1993IR	LR1100-703B	JA1357IR
8EL738153-001	JA1728IR	8EL738211-391	CA1867IR	8EL738212-221	CA1926IR	LR1100-711	JA1357IR
8EL738155-001	JA1783IR	8EL738211-401	CA1842IR	8EL738212-231	CA1934IR	LR1100-711B	JA1357IR
8EL738159-001	CA1764IR	8EL738211-411	CA1866IR	8EL738212-241	CA1972	LR1100-724	JA1611IR
8EL738160-001	CA1765IR	8EL738211-421	CA1873IR	8EL738212-251	CA2002IR	LR1100-724B	JA1611IR
8EL738161-001	CA1766IR	8EL738211-431	CA1874IR	8EL738212-261	CA2003IR	LR1100-725	JA1357IR
8EL738162-001	CA1767IR	8EL738211-441	CA1875IR	8EL738212-271	CA2009IR	LR1100-725B	JA1357IR
8EL738163-001	CA1768IR	8EL738211-451	JA1808IR	8EL738212-291	CA1997IR	LR1100-725C	JA1357IR
8EL738164-001	CA1769IR	8EL738211-461	JA1896IR	8EL738212-311	CA2034IR	LR1110-502	JA1900IR
8EL738170-001	CA1770IR	8EL738211-471	JA1898	8EL738212-371	CA1940IR	LR1110-502B	JA1900IR
8EL738172-001	CA1771IR	8EL738211-481	CA1858IR	8EL738212-381	CA1953IR	LR1110-502C	JA1900IR
8EL738175-001	JA1784IR	8EL738211-491	CA1864IR	8EL738212-391	CA2006IR	LR1110-502F	JA1900IR
8EL738176-001	JA1785IR	8EL738211-501	CA1865IR	8EL738212-411	CA2011IR	LR1110-503	JA1900IR
8EL738177-001	JA1786IR	8EL738211-511	JA1796IR	8EL738212-421	CA2024IR	LR1110-503B	JA1900IR
8EL738178-001	CA1772IR	8EL738211-521	JA1891IR	8EL738212-431	CA2028IR	LR1110-503C	JA1900IR
8EL738179-001	JA1787IR	8EL738211-531	JA1892IR	8EL738212-441	CA1970IR	LR1110-503E	JA1900IR
8EL738182-001	CA1773IR	8EL738211-541	JA1893IR	8EL738212-451	CA2007IR	LR1110-503F	JA1900IR
8EL738183-001	CA1774IR	8EL738211-551	CA1877IR	8EL738213-001	CA1823IR	LR1110-705	JA990IR
8EL738185-001	CA1775IR	8EL738211-561	CA1879IR	8EL738214-001	CA1824IR	LR1110-705B	JA990IR
8EL738186-001	CA1776IR	8EL738211-571	CA1880IR	8EL738215-001	JA1791	LR1110-709	JA990IR
8EL738187-001	CA1777IR	8EL738211-581	CA1882IR	8EL738217-001	CA1825IR	LR1110-709B	JA990IR
8EL738188-001	CA1778IR	8EL738211-591	JA1899IR	8EL738218-001	CA1826IR	LR1110-713	JA1712IR
8EL738189-001	CA1779IR	8EL738211-601	JA1901IR	8EL738221-001	CA1827IR	LR1110-713B	JA1712IR
8EL738190-001	CA1780IR	8EL738211-611	CA1883IR	8EL738224-001	CA1828IR	LR1110-713C	JA1712IR
8EL738191-001	CA1781IR	8EL738211-621	CA1884IR	8EL738225-001	JA1793IR	LR1110-713V	JA1712IR
8EL738192-001	CA1782IR	8EL738211-631	CA1885IR	8EL738226-001	JA1794IR	LR1110-717	JA1712IR
8EL738193-001	CA1810IR	8EL738211-641	CA1886IR	8EL738229-001	JA1795IR	LR1110-717B	JA1712IR
8EL738194-001	CA1811IR	8EL738211-651	CA1887IR	8EL738231-001	CA1831IR	LR1110-720	JA990IR
8EL738195-001	CA1812IR	8EL738211-661	CA1890IR	8EL738235-001	CA1832IR	LR1110-723	JA990IR
8EL738196-001	CA1813IR	8EL738211-671	CA1904IR	8EL738238-001	JA1798IR	LR1110-723B	JA990IR
8EL738197-001	CA1814IR	8EL738211-681	CA1905IR	8EL738245-001	CA1833IR	LR1110-723C	JA990IR
8EL738199-001	CA1815IR	8EL738211-691	CA1910IR	8EL738247-001	JA1800IR	LR1110-723E	JA990IR
8EL738201-001	CA1729IR	8EL738211-701	CA1912IR	8EL738252-001	JA1801IR	LR1120-701	CA1394IR
8EL738202-001	CA1817IR	8EL738211-711	JA1902	8EL738253-001	CA1835IR	LR1130-702	CA2082IR
8EL738203-001	CA1818IR	8EL738211-721	CA1881IR	8EL738256-001	JA1802IR	LR1130-702B	CA2082IR
8EL738204-001	CA1819IR	8EL738211-731	CA1913IR	8EL738257-001	CA1836IR	LR1130-702C	CA2082IR
8EL738205-001	CA1820IR	8EL738211-751	JA1792IR	8EL748558-001	CA1837IR	LR135-105	JA116IR
8EL738206-001	CA1821IR	8EL738211-761	CA1908IR	8EL749554-001	CA1843IR	LR135-107	JA105IR
8EL738207-001	JA1788IR	8EL738211-771	CA1915IR	8EL749555-001	CA1844IR	LR135-115	JA116IR
8EL738208-001	JA1789IR	8EL738211-781	CA1917IR	8EL749556-001	CA1849IR	LR135-116	JA116IR
8EL738210-001	JA1790IR	8EL738211-801	CA1933IR	8EL749557-001	CA1852IR	LR135-118	JA116IR
8EL738211-001	CA1822IR	8EL738211-811	CA1937IR	8EL749558-001	CA1837IR	LR135-124	JA116IR
8EL738211-011	CA1829IR	8EL738211-821	CA1938IR	8EL749559-001	CA1838IR	LR135-126	JA116IR
8EL738211-021	CA1847IR	8EL738211-831	CA1939IR				

O.E. NO.	HC-PARTS	O.E. NO.	HC-PARTS	O.E. NO.	HC-PARTS	O.E. NO.	HC-PARTS		
LR135-127	JA116IR	▲	LR150-206	JA862IR	LR155-409	JA577IR	LR160-727C	JA1423IR	
LR135-128	JA116IR		LR150-211	JA862IR	LR155-410	JA577IR	LR160-728	JA1516IR	
LR135-58	JA116IR		LR150-211B	JA862IR	LR155-410B	JA577IR	LR160-728B	JA1516IR	
LR135-58B	JA116IR		LR150-212	JA862IR	LR155-410BA	JA577IR	LR160-728C	JA1516IR	
LR135-61	JA105IR		LR150-30	JA125IR	LR155-410F	JA577IR	LR160-728E	JA1516IR	
LR135-61B	JA105IR		LR150-30B	JA125IR	LR155-414	JA577IR	LR160-728F	JA1516IR	
LR135-70	JA105IR		LR150-31	JA104IR	LR155-414F	JA577IR	LR160-77	JA158IR	
LR135-74	JA116IR		LR150-35	JA104IR	LR155-418B	JA680IR	LR160-78	JA158IR	
LR135-74B	JA116IR		LR150-36	JA104IR	LR155-419B	JA680IR	LR160-78B	JA158IR	
LR135-86	JA116IR		LR150-401	JA573IR	LR155-420	JA577IR	▲	LR160-82	JA198IR
LR135-86B	JA116IR		LR150-401C	JA573IR	LR160-104	JA107IR	LR160-82B	JA198IR	
LR135-86C	JA116IR		LR150-402	JA573IR	LR160-105	JA158IR	LR160-84	JA198IR	
LR135-86F	JA116IR		LR150-402C	JA573IR	LR160-107	JA779IR	LR160-84B	JA198IR	
LR135-95	JA116IR		LR150-410	JA577IR	LR160-107B	JA779IR	LR160-93	JA107IR	
LR135-95B	JA116IR		LR150-410B	JA577IR	LR160-108	JA183IR	LR160-96	JA183IR	
LR140-119	JA565IR		LR150-410C	JA577IR	LR160-108B	JA183IR	LR160-96B	JA183IR	
LR140-119C	JA565IR		LR150-410CA	JA577IR	LR160-109C	JA887IR	LR160-96C	JA183IR	
LR140-128	JA171IR		LR150-410F	JA577IR	LR160-113	JA107IR	LR160-97B	JA669IR	
LR140-130B	JA565IR		LR150-410G	JA577IR	LR160-120	JA158IR	LR160-97C	JA669IR	
LR140-130P	JA565IR		LR150-419	JA577IR	LR160-121	JA158IR	LR165-704	JA695IR	
LR140-132	JA105IR		LR150-419B	JA577IR	LR160-124	JA158IR	LR165-704B	JA695IR	
LR140-136	JA171IR	▲	LR150-419BA	JA577IR	LR160-125	JA107IR	LR165-707	JA653IR	
LR140-402	JA565IR		LR150-419F	JA577IR	LR160-130	JA158IR	▲	LR165-707B	JA653IR
LR140-402	JA565IR		LR150-421	JA761IR	LR160-131	JA765IR	LR165-708	JA974IR	
LR140-410	JA801IR		LR150-421C	JA761IR	LR160-137	JA109IR	LR165-708B	JA974IR	
LR140-410B	JA801IR		LR150-428E	JA660IR	LR160-138	JA109IR	LR165-708C	JA974IR	
LR140-410BA	JA801IR		LR150-428S	JA660IR	LR160-140	JA754IR	LR165-709	JA694IR	
LR140-410F	JA801IR		LR150-428T	JA660IR	LR160-144	JA669IR	LR165-709B	JA694IR	
LR140-410G	JA801IR		LR150-430C	JA185IR	LR160-154	JA754IR	LR165-711	JA1182IR	
LR140-411	JA801IR		LR150-430S	JA185IR	LR160-166	JA108IR	LR165-711B	JA1182IR	
LR140-411B	JA801IR		LR150-430T	JA185IR	LR160-168	JA754IR	▲	LR165-714	JA1790IR
LR140-411BA	JA801IR		LR150-431	JA680IR	LR160-401	JA181IR	LR170-02	JA807IR	
LR140-411F	JA801IR		LR150-432	JA680IR	LR160-401C	JA181IR	LR170-02B	JA807IR	
LR140-411G	JA801IR		LR150-434	JA761IR	LR160-412	JA180IR	LR170-14	JA107IR	
LR140-415	JA186IR		LR150-434B	JA761IR	LR160-412B	JA180IR	LR170-22	JA776IR	
LR140-415B	JA186IR		LR150-435	JA185IR	LR160-412F	JA180IR	LR170-402	JA758IR	
LR140-423	JA801IR		LR150-435T	JA185IR	LR160-412G	JA180IR	LR170-402B	JA758IR	
LR140-423F	JA801IR		LR150-438	JA680IR	LR160-414	JA765IR	▲	LR170-402C	JA758IR
LR140-423G	JA801IR		LR150-438B	JA680IR	LR160-417	JA765IR	LR170-402C	JA758IR	
LR140-429B	JA801IR	▲	LR150-439	JA680IR	LR160-42	JA108IR	LR170-402E	JA758IR	
LR140-701	JA652IR		LR150-439B	JA680IR	LR160-421B	JA1291IR	▲	LR170-402F	JA758IR
LR140-703	JA652IR		LR150-441	JA761IR	LR160-421C	JA1291IR	▲	LR170-404	JA182IR
LR140-705	JA652IR		LR150-441C	JA761IR	LR160-421E	JA1291IR	LR170-404B	JA182IR	
LR145-701	JA652IR		LR150-441E	JA761IR	LR160-422B	JA662IR	LR170-404C	JA182IR	
LR145-701B	JA652IR		LR150-442	JA761IR	LR160-426	JA780IR	LR170-405	JA184IR	
LR145-701C	JA652IR		LR150-443S	JA660IR	LR160-426E	JA780IR	LR170-406	JA773IR	
LR145-701E	JA652IR	▲	LR150-443T	JA660IR	LR160-426S	JA780IR	LR170-406B	JA773IR	
LR145-701F	JA652IR		LR150-444B	JA761IR	LR160-426T	JA780IR	LR170-406C	JA773IR	
LR145-701GA	JA652IR		LR150-448	JA761IR	LR160-427	JA780IR	LR170-406F	JA773IR	
LR145-701GB	JA652IR		LR150-449B	JA761IR	LR160-427C	JA780IR	LR170-407	JA678IR	
LR145-710	JA652IR		LR150-449C	JA761IR	LR160-427S	JA780IR	LR170-407E	JA678IR	
LR150-101B	JA104IR		LR150-450B	JA577IR	▲	LR160-427T	JA780IR	LR170-407S	JA678IR
LR150-111	JA197IR		LR150-453	JA761IR	LR160-42B	JA108IR	LR170-407T	JA678IR	
LR150-125	JA104IR		LR150-453B	JA761IR	LR160-440	JA180IR	LR170-408C	JA678IR	
LR150-125B	JA104IR		LR150-52	JA104IR	LR160-440F	JA180IR	LR170-408S	JA678IR	
LR150-135	JA655IR		LR150-53	JA104IR	LR160-441	JA180IR	LR170-408T	JA678IR	
LR150-135E	JA655IR		LR150-64	JA197IR	LR160-441F	JA180IR	LR170-411	JA673IR	
LR150-136B	JA661IR		LR150-79	JA162IR	LR160-446	JA873IR	LR170-411B	JA673IR	
LR150-136C	JA661IR		LR150-79B	JA162IR	LR160-446B	JA873IR	LR170-411C	JA673IR	
LR150-136E	JA661IR		LR150-79C	JA162IR	LR160-446C	JA873IR	LR170-411D	JA673IR	
LR150-147B	JA655IR		LR150-79S	JA162IR	LR160-446E	JA873IR	LR170-411E	JA673IR	
LR150-147C	JA655IR		LR150-98	JA104IR	LR160-449	JA180IR	▲	LR170-411F	JA673IR
LR150-151	JA197IR		LR150-98B	JA104IR	LR160-450	JA180IR	▲	LR170-411P	JA673IR
LR150-151B	JA197IR		LR150-98E	JA104IR	LR160-451D	JA1801IR	LR170-414	JA773IR	
LR150-162	JA655IR		LR150-99	JA104IR	LR160-452D	JA1801IR	LR170-415	JA874IR	
LR150-165	JA884IR	◆	LR150-99B	JA104IR	LR160-67	JA779IR	▲	LR170-415B	JA874IR
LR150-189	CA306IR		LR155-15	JA109IR	LR160-67B	JA779IR	▲	LR170-415C	JA874IR
LR150-190	CA704IR		LR155-15C	JA109IR	LR160-67C	JA779IR	▲	LR170-417B	JA769IR
LR150-191	CA704IR		LR155-16B	JA162IR	LR160-67E	JA779IR	▲	LR170-417C	JA769IR
LR150-192	JA655IR		LR155-16P	JA162IR	LR160-67G	JA779IR	▲	LR170-417E	JA769IR
LR150-199	JA197IR		LR155-18	JA109IR	LR160-67H	JA779IR	▲	LR170-417F	JA769IR
LR150-200	JA109IR		LR155-20	JA986IR	LR160-707	JA165IR	LR170-419	JA871IR	
LR150-200	JA197IR		LR155-20B	JA986IR	LR160-708	JA165IR	▲	LR170-419B	JA871IR
LR150-201	JA661IR		LR155-23	JA197IR	LR160-709	JA165IR	LR170-420	JA863IR	
LR150-201B	JA661IR		LR155-25	JA197IR	▲	LR160-710	JA778IR	LR170-420B	JA863IR
LR150-202	JA862IR		LR155-29	JA986IR	▲	LR160-715	JA163IR	LR170-421	JA182IR
LR150-204	JA862IR		LR155-407C	JA577IR	LR160-724	JA1363IR	LR170-421B	JA182IR	
LR150-205	JA661IR		LR155-407CA	JA577IR	LR160-727	JA1423IR	LR170-422	JA871IR	
LR150-205B	JA661IR		LR155-408	JA162IR	LR160-727B	JA1423IR	LR170-424B	JA758IR	

O.E. NO.	HC-PARTS	O.E. NO.	HC-PARTS	O.E. NO.	HC-PARTS	O.E. NO.	HC-PARTS
<b>HITACHI <i>Continued</i></b>							
LR170-427	JA863IR	LR180-749B	JA1702IR	LT150-10B	JA103	S114-172E	JS303
LR170-427B	JA863IR	LR180-749C	JA1702IR	LT150-113	JA119	S114-173	JS303
LR170-427BA	JA863IR	LR180-749E	JA1702IR	LT150-113B	JA119	S114-173B	JS303
LR170-427C	JA863IR	LR180-762	JA1607IR	LT150-114B	JA119	S114-173E	JS303
LR170-502B	JA769IR	LR180-762B	JA1607IR	LT150-12	JA101	S114-173F	JS303
LR170-502C	JA769IR	LR180-762C	JA1607IR	LT150-120	JA119	S114-174	JS302
LR170-502P	JA769IR	LR180-766	JA1409	LT150-122	JA103	S114-180	JS307
LR170-502Q	JA769IR	LR180-768	JA1607IR	LT150-123	JA103	S114-180B	JS307
LR170-504B	JA769IR	LR185-701	JA1713IR	LT150-125	JA103	S114-180E	JS307
LR170-505	JA1172IR	LR185-701B	JA1713IR	LT150-13	JA103	S114-180F	JS307
LR170-505B	JA1172IR	LR185-701C	JA1713IR	LT150-154	JA681	S114-180G	JS307
LR170-509C	JA1526IR	LR185-701E	JA1713IR	LT150-16	JA101	S114-181	JS307
LR170-509E	JA1526IR	LR185-701H	JA1713IR	LT150-17	JA101	S114-184	JS905
LR170-509F	JA1526IR	LR185-702	JA1713IR	LT150-18	JA103	S114-202	JS549
LR170-509G	JA1526IR	LR185-702C	JA1713IR	LT150-187	JA103	S114-208	JS755
LR170-509H	JA1526IR	LR190-704	JA767IR	LT150-188	JA103	S114-210	JS310
LR170-511	JA1172IR	LR190-709	JA767IR	LT150-19	JA103	S114-211	JS310
LR170-511B	JA1172IR	LR190-709B	JA767IR	LT150-195	JA681	S114-227	JS310
LR170-701	JA691IR	LR190-711	JA767IR	LT150-196	JA681	S114-232	JS370
LR170-701B	JA691IR	LR190-711F	JA767IR	LT150-21	JA119	S114-232A	JS370
LR170-701E	JA691IR	LR190-711G	JA767IR	LT150-22	JA103	S114-235	JS729
LR170-702	JA1422IR	LR190-719	JA975IR	LT150-22B	JA103	S114-235A	JS729
LR170-702B	JA1422IR	LR190-719B	JA975IR	LT150-23	JA101	S114-235B	JS729
LR170-715	JA166IR	LR190-734	JA1528IR	LT150-23B	JA101	S114-237	JS370
LR170-715B	JA166IR	LR190-734B	JA1528IR	LT150-24	JA101	S114-240	JS307
LR170-716	JA166IR	LR190-734C	JA1528IR	LT150-24B	JA101	S114-244	JS731
LR170-716B	JA166IR	LR190-734E	JA1528IR	LT150-25	JA103	S114-244	JS310
LR170-717	JA781IR	LR190-734G	JA1528IR	LT150-26	JA103	S114-247	JS549
LR170-732	JA698IR	LR190-734H	JA1528IR	LT150-26B	JA103	S114-247A	JS549
LR170-732B	JA698IR	LR190-747	JA1606IR	LT150-40	JA686	S114-247B	JS549
LR170-732C	JA698IR	LR190-752	JA1602IR	LT150-45	JA101	S114-247C	JS549
LR170-734	JA1122IR	LR190-752B	JA1602IR	LT150-46	JA101	S114-249	JS347
LR170-734B	JA1122IR	LR190-752C	JA1602IR	LT150-47	JA101	S114-254B	JS306
LR170-738	JA974IR	LR190-752H	JA1602IR	LT150-48	JA103	S114-254D	JS306
LR170-738	JA974IR	LR225-403	JA187IR	LT150-49	JA103	S114-255A	JS308
LR170-738B	JA974IR	LR225-408B	JA1171IR	LT150-54	JA119	S114-257	JS731
LR170-738B	JA974IR	LR225-408C	JA1171IR	LT150-57	JA686	S114-257G	JS731
LR170-738C	JA974IR	LR225-408E	JA1171IR	LT150-59	JA101	S114-258C	JS306
LR170-738E	JA974IR	LR225-409E	JA1171IR	LT150-62	JA119	S114-268	JS306
LR170-739	JA1122IR	LR225-65	JA187IR	LT150-72	JA119	S114-269	JS310
LR170-739B	JA1122IR	LR225-65B	JA187IR	LT155-08	JA686	S114-271	JS549
LR170-740	JA1420IR	LR225-65C	JA187IR	LT155-08B	JA686	S114-272	JS347
LR170-740B	JA1420IR	LR225-65E	JA187IR	LT160-23B	JA101	S114-290	JS353
LR170-741	JA1406IR	LR225-65P	JA187IR	S108-63	JS310	S114-290A	JS353
LR170-746	JA1182IR	LR225-67P	JA187IR	S108-89	JS310	S114-290B	JS353
LR170-746B	JA1182IR	LR235-402	JA672IR	S114-103	JS302	S114-293	JS358
LR170-746C	JA1182IR	LT125-02	JA102	S114-121	JS303	S114-295	JS307
LR170-746E	JA1182IR	LT125-05	JA102	S114-122	JS303	S114-295A	JS307
LR170-746F	JA1182IR	LT130-72	JA100	S114-126M	JS307	S114-295B	JS307
LR170-746G	JA1182IR	LT130-81	JA100	S114-139	JS307	S114-296A	JS308
LR170-746J	JA1182IR	LT130-89	JA786	S114-140	JS310	S114-297	CS132
LR170-746K	JA1182IR	LT135-13	JA100	S114-141	JS310	S114-301	JS307
LR170-746M	JA1182IR	LT135-13B	JA100	S114-146	JS731	S114-303	JS1145
LR170-748B	JA1182IR	LT135-19	JA100	S114-149	JS310	S114-303A	JS1145
LR170-750	JA1182IR	LT135-20	JA100	S114-151	JS340	S114-305	JS310
LR170-750B	JA1182IR	LT135-22	JA100	S114-152	JS301	S114-315	JS305
LR170-750C	JA1182IR	LT135-24	JA100	S114-155	JS301	S114-316	JS305
LR170-756	CA2079IR	LT135-30	JA100	S114-160	JS755	S114-317	JS556
LR170-756B	CA2079IR	LT135-35	JA100	S114-160A	JS300	S114-317A	JS556
LR170-758	JA1283	LT135-35B	JA100	S114-160B	JS300	S114-317B	JS556
LR170-764	JA1610	LT135-35C	JA100	S114-160D	JS300	S114-318	JS556
LR170-768	JA1790IR	LT135-36C	JA100	S114-160E	JS300	S114-318A	JS556
LR180-501	JA1290IR	LT135-54	JA100	S114-160F	JS300	S114-319	JS304
LR180-501B	JA1290IR	LT135-68	JA100	S114-160G	JS300	S114-320	JS304
LR180-501C	JA1290IR	LT135-69	JA100	S114-160H	JS300	S114-320A	JS304
LR180-504	JA1290IR	LT135-73	JA784	S114-161	JS301	S114-322	JS649
LR180-710B	JA1186IR	LT135-73B	JA784	S114-161B	JS301	S114-322A	JS649
LR180-725	JA762IR	LT140-106	JA686	S114-161E	JS301	S114-340	JS375
LR180-725C	JA762IR	LT140-106B	JA686	S114-161F	JS301	S114-341	JS375
LR180-725E	JA762IR	LT140-106C	JA686	S114-163	JS755	S114-344	JS306
LR180-735	JA1374IR	LT140-106E	JA686	S114-163B	JS755	S114-345	JS364
LR180-735B	JA1374IR	LT140-107C	JA686	S114-163E	JS300	S114-345A	JS364
LR180-736B	JA1292IR	LT140-107E	JA686	S114-163F	JS755	S114-345B	JS364
LR180-737B	JA762IR	LT145-42	JA103	S114-164	JS340	S114-348	JS303
LR180-737C	JA762IR	LT150-03	JA101	S114-164A	JS340	S114-348A	JS303
LR180-741	JA1287IR	LT150-04	JA103	S114-170B	JS302	S114-349A	JS731
LR180-741B	JA1287IR	LT150-05	JA101	S114-170E	JS302	S114-349B	JS731
LR180-741H	JA1287IR	LT150-05B	JA101	S114-172A	JS303	S114-350	JS375
LR180-749	JA1702IR	LT150-10	JA101	S114-172D	JS303	S114-351	JS375

O.E. NO.	HC-PARTS	O.E. NO.	HC-PARTS	O.E. NO.	HC-PARTS	O.E. NO.	HC-PARTS
S114-357	JS389	S114-526	JS893	S114-901A	JS1367	S13-33A	JS679
S114-357A	JS389	S114-526A	JS893	S114-902	CS1418	S13-33B	JS679
S114-357B	JS389	S114-526B	JS893	S114-902A	CS1418	S13-38A	JS359
S114-357C	JS389	S114-528	JS1104	S114-903	CS1192	S13-38B	JS359
S114-362	JS558	S114-528A	JS1104	S114-903A	CS1192	S13-45A	JS359
S114-362A	JS558	S114-530	JS766	S114-905	CS1379	S13-45B	JS359
S114-363	JS310	S114-533	JS766	S114-906	CS1379	S13-49A	JS358
S114-364	JS305	S114-534	JS766	S114-907	CS1257	S13-502	JS650
S114-367	JS358	S114-535	JS759	S114-907A	CS1257	S13-502A	JS650
S114-374B	JS668	S114-550	JS633	S114-91	JS343	S13-514	JS999
S114-377	JS771	S114-550A	JS633	S114-922	CS1418	S13-531	JS1001
S114-381	JS737	S114-553	CS294	S114-925	JS1158	S13-550	CS1390
S114-385	JS778	S114-553A	CS294	S114-925A	JS1158	S13-556	CS1491
S114-389A	JS309	S114-554	CS293	S114-938	CS1379	S13-556A	CS1491
S114-390A	JS309	S114-554A	CS293	S114-943	CS1379	S13-62	JS629
S114-391A	JS378	S114-556	JS557	S114-943A	CS1379	S13-62A	JS629
S114-393	JS513	S114-556A	JS557	S114-949	CS1192	S13-62B	JS629
S114-393A	JS513	S114-557	JS557	S12-19	JS379	S13-64	JS363
S114-395	JS345	S114-557A	JS557	S12-19C	JS379	S13-66	JS662
S114-396	JS311	S114-566	JS311	S12-19K	JS379	S13-66A	JS662
S114-402	JS305	S114-568	JS305	S12-41A	JS677	S13-73	CS201
S114-403B	JS668	S114-569	JS759	S12-59	JS677	S13-74	CS201
S114-418	JS557	S114-570	JS672	S12-63	JS379	S13-81	JS397
S114-419	JS557	S114-570A	JS672	S12-63A	JS379	S13-82B	JS552
S114-419A	JS557	S114-570B	JS672	S12-63B	JS379	S13-83	JS629
S114-424	JS557	S114-570C	JS672	S12-63C	JS379	S13-84	JS767
S114-424A	JS557	S114-614	JS311	S12-68	JS379	S13-84B	JS767
S114-427	JS307	S114-630	JS759	S12-68B	JS379	S13-89	JS776
S114-429	JS1008	S114-653	JS1356	S12-68D	JS379	S13-89A	JS776
S114-429A	JS1008	S114-653A	JS1356	S12-77A	JS1232	S13-89B	JS776
S114-432A	JS1148	S114-653B	JS1356	S12-84	CS693	S13-89C	JS776
S114-440	JS520	S114-700A	JS914	S12-85	CS109	S13-89D	JS776
S114-441A	JS775	S114-701	JS914	S12-87	CS109	S13-91	CS386
S114-441B	JS775	S114-701A	JS914	S13-06A	JS679	S13-91A	CS386
S114-443A	JS1356	S114-705	JS890	S13-101	JS650	S13-92A	JS522
S114-452	JS1148	S114-705A	JS890	S13-102	JS650	S14-03	JS999
S114-452A	JS1148	S114-705B	JS890	S13-104	JS522	S14-203	JS639
S114-453	JS638	S114-705C	JS890	S13-105	JS539	S14-205	JS660
S114-454	JS638	S114-705D	JS890	S13-105A	JS539	S14-205A	JS660
S114-456	JS1148	S114-750	JS766	S13-106	JS660	S14-210	JS999
S114-456A	JS1148	S114-758	JS672	S13-106A	JS660	S14-210A	JS999
S114-458	JS668	S114-762	JS890	S13-106B	JS660	S24-03A	JS748
S114-459	JS308	S114-762A	JS890	S13-106C	JS660	S24-03B	JS748
S114-460	JS1148	S114-762B	JS890	S13-106E	JS660	S24-03C	JS748
S114-460A	JS1148	S114-766	JS766	S13-107	JS517	S24-13	JS748
S114-460B	JS1148	S114-766A	JS766	S13-107A	JS517	S25-103	JS746
S114-461	JS754	S114-767	JS766	S13-112	JS639	S25-110G	JS1087
S114-461A	JS754	S114-769	JS759	S13-112A	JS639	S25-110K	JS1087
S114-461B	JS754	S114-769A	JS759	S13-114	JS639	S25-110M	JS1087
S114-464	JS1148	S114-775	JS672	S13-114A	JS639	S25-131	JS399
S114-464A	JS1148	S114-775A	JS672	S13-121	JS629	S25-131A	JS399
S114-471	JS1093	S114-800	JS1100	S13-122	JS1159	S25-155C	JS399
S114-471A	JS1093	S114-800A	JS1100	S13-126	JS1159	S25-155D	JS399
S114-472A	JS1093	S114-800B	JS1100	S13-127	JS660	S25-156	JS540
S114-473	JS651	S114-801A	JS924	S13-127A	JS660	S25-164	JS1087
S114-475	JS520	S114-801B	JS924	S13-127C	JS660	S25-164A	JS1087
S114-475A	JS520	S114-801C	JS924	S13-131	JS1001	S25-64	JS904
S114-480	JS651	S114-801D	JS924	S13-207C	JS776	S25-64E	JS904
S114-480A	JS651	S114-802A	JS1100	S13-210B	JS999		
S114-480B	JS651	S114-804A	JS1137	S13-210C	JS999		
S114-481	JS753	S114-806	JS1137	S13-212	JS660	HONDA	
S114-481A	JS753	S114-806A	JS1137	S13-213	JS660	31100-634-004	JA110
S114-482	JS1093	S114-808	JS1091	S13-250	CS1390	31100-634-014	JA110
S114-483	JS731	S114-808A	JS1091	S13-27	JS679	31100-634-024	JA110
S114-483A	JS731	S114-808B	JS1091	S13-27A	JS679	31100-634-040	JA110
S114-486	JS520	S114-827	JS890	S13-28	JS679	31100-634-045	JA110
S114-501	CS282	S114-829	JS1158	S13-289	JS776	31100-634-811	JA111
S114-501A	CS282	S114-829A	JS1158	S13-289A	JS776	31100-657-004	JA110
S114-505	JS751	S114-829B	JS1158	S13-302	JS650	31100-671-004	JA157
S114-509	JS654	S114-844	JS1306	S13-302A	JS650	31100-671-014	JA157
S114-516	JS938	S114-850	JS941	S13-302B	JS650	31100-671-024	JA157
S114-516A	JS938	S114-850A	JS941	S13-305	JS539	31100-673-831	JA157
S114-517	JS763	S114-850B	JS941	S13-305A	JS539	31100-689-004	JA157
S114-517C	JS763	S114-850C	JS941	S13-321	JS629	31100-689-014	JA157
S114-519A	JS937	S114-850D	JS941	S13-322	JS1159	31100-689-910	JA157
S114-520A	JS766	S114-850E	JS941	S13-326	JS1159	31100-P01-0031	JA1280IR
S114-520B	JS766	S114-869	JS1158	S13-327	JS660	31100-P01-013	JA1280IR
S114-523	JS627	S114-871	JS1225	S13-327A	JS1159	31100-P01-0132	JA1280IR
S114-525A	JS937	S114-875	CS1477	S13-331	JS1001	31100-P01-G01	JA1273IR
						31100-P04-G01	JA980IR

O.E. NO.	HC-PARTS	O.E. NO.	HC-PARTS	O.E. NO.	HC-PARTS	O.E. NO.	HC-PARTS
<b>HONDA Continued</b>							
31100-P04-G03	JA980IR	31100-PJ0-662	JA696IR	31200-689-661	JS314	31200-PD2-306	JS356
31100-P04-G034	JA980IR	31100-PJ0-663	JA696IR	31200-689-662	JS315	31200-PD2-661	JS314
31100-P04-G05	JA980IR	31100-PK1-001	JA759IR	31200-P01-003	JS319	31200-PD2-6612	JS765
31100-P05-C04	JA980IR	31100-PK1-0147	JA759IR	31200-P01-005	JS1022	31200-PD2-662	JS356
31100-P0A-AA010	JA1408IR	31100-PK2-003	JA772IR	31200-P03-005	JS1022	31200-PD6-006	JS356
31100-P1K-E03	JA1405IR	31100-PK2-0031	JA772IR	31200-P03-005	JS1022	31200-PDA-E020	JS1216
31100-P1K-E05	JA1405IR	31100-PK2-004	JA772IR	31200-P06-L03	JS311	31200-PDA-E03	JS1216
31100-P2E-A01	JA1514IR	31100-PK2-014	JA759IR	31200-P0A-0031	JS1151	31200-PDA-E030	JS1216
31100-P2E-A02	JA1514IR	31100-PK2-0146	JA772IR	31200-P0A-0032	JS1151	31200-PDA-E53	JS1147
31100-P2E-G01	JA1520IR	31100-PK3-A020	JA772IR	31200-P1J-E01	JS1147	31200-PDA-S010	JS1216
31100-P2E-G02	JA1520IR	31100-PLM-A01	JA1727IR	31200-P1J-E010	JS1147	31200-PE0-003	JS311
31100-P2J-004	JA1520IR	31100-PLM-A02	JA1727IR	31200-P1J-E03	JS1147	31200-PE0-013	JS311
31100-P45-901	JA1129IR	31100-PLZ-D00	JA1521IR	31200-P1J-S010	JS1147	31200-PE0-015	JS311
31100-P45-G01	JA1129IR	31100-PM2-B03	JA751IR	31200-P1K-E01	JS1152	31200-PE0-461	JS319
31100-P45-G04	JA1426IR	31100-PM4-0030	JA751IR	31200-P29-G02	JS319	31200-PE0-661	JS319
31100-P5M-G01	JA1719IR	31100-PM4-Q02	JA751IR	31200-P29-902	JS319	31200-PE0-662	JS319
31100-P5N-G01	JA1719IR	31100-PM4-Y0030	JA751IR	31200-P29-903	JS319	31200-PE0-663	JS319
31100-P72-0032	JA1278IR	31100-PM5-A01	JA753IR	31200-P2A-003	JS1215	31200-PE0-664	JS319
31100-P7A-G02	JA1520IR	31100-PM5-A010	JA753IR	31200-P2A-004	JS319	31200-PE0-665	JS319
31100-P7F-00331	JA1720IR	31100-PM5-A070	JA753IR	31200-P2A-014	JS319	31200-PE0-901	JS311
31100-PA0-663	JA157	31100-PM5-X03	JA753IR	31200-P2C-004	JS319	31200-PE0-902	JS311
31100-PA1-741	JA168	31100-PM8-A010	JA753IR	31200-P30-005	JS1083	31200-PE1-670	JS645
31100-PA1-742	JA168	31100-PNA-004	JA1728IR	31200-P3T-J01	CS1455	31200-PE1-671	JS645
31100-PA1-744	JA168	31100-PNC-004	JA1728IR	31200-P45-G01	JS648	31200-PE1-672	JS645
31100-PA1-745	JA168	31100-PND-004	JA1728IR	31200-P45-G11	JS648	31200-PE1-673	JS645
31100-PA5-900	JA157	31100-PP2-E02	JA751IR	31200-P45-G11	JS648	31200-PE1-674	JS645
31100-PA6-004	JA157	31100-PP4-E03	JA992IR	31200-P45-S01	JS648	31200-PEL-004	JS1309
31100-PA6-014	JA157	31100-PR3-0030	JA1272IR	31200-P5K-004	JS1151	31200-PEO-661	JS319
31100-PA6-901	JA157	31100-PR5-0030	JA980IR	31200-P5M-004	JS1150	31200-PG6-004	JS319
31100-PB1-004	JA157	31100-PR6-003	JA1280IR	31200-P5M-014	JS1150	31200-PG6-034	JS319
31100-PB1-014	JA157	31100-PT2-003	JA1163IR	31200-P5T-G00	JS1314	31200-PG6-663	JS319
31100-PB2-004	JA157	31100-PT3-A01	JA1163IR	31200-PA0-005	JS310	31200-PG6-673	JS319
31100-PB2-971	JA157	31100-PT3-A511M	JA1163IR	31200-PA0-006	JS310	31200-PG6-911	JS645
31100-PC0-9230	JA751IR	31100-PT3-Q01	JA760IR	31200-PA0-016	JS310	31200-PG6-914	JS645
31100-PC1-004	JA153	31100-PTO-B91	JA1129IR	31200-PA5-671	JS315	31200-PG6-915	JS645
31100-PC1-020	JA153	31100-PW1-G01	JA753IR	31200-PA2-663	JS356	31200-PG6-916	JS645
31100-PC1-071	JA153	31100-PWA-004	JA1897IR	31200-PA4-912	JS315	31200-PGA-E30M5	JS1216
31100-PC1-971	JA153	31100-RB0-004	CA2080IR	31200-PA5-004	JS375	31200-PH1-760	JS356
31100-PC6-004	JA170	31100-RBD-E01	CA1980IR	31200-PA5-911	JS375	31200-PH3-006	JS626
31100-PCX-J012	JA1787IR	31100-RBD-E02	CA1980IR	31200-PA5-912	JS375	31200-PH3-951	JS626
31100-PD2-004	JA177IR	31100-RJH-004	JA1727IR	31200-PA5-913	JS375	31200-PH3-953	JS626
31100-PD2-005	JA177IR	31100-RJJ-004	JA1728IR	31200-PA5-921	JS315	31200-PH4-S12	JS626
31100-PD2-014	JA177IR	31100-RNA-A01	CA1981IR	31200-PA6-005	JS375	31200-PH7-006	JS653
31100-PD2-024	JA177IR	31100-RSH-004	JA1897IR	31200-PA6-661	JS315	31200-PH7-661	JS653
31100-PD2-970	JA177IR	31100-RSR-E01	CA1980IR	31200-PB1-932	JS315	31200-PK2-306	JS626
31100-PD2-973	JA177IR	31100-RTA-003	JA1726IR	31200-PB1-933	JS315	31200-PK2-953	JS626
31100-PD6-014	JA696IR	31100-RTA-023	JA1980IR	31200-PB1-934	JS310	31200-PK2-955	JS626
31100-PDA-E01	JA1415IR	31100-RZP-G01	CA2078IR	31200-PB1-935	JS310	31200-PK2-S02	JS626
31100-PE0-003	JA113IR	31100-RAA-A01	JA1726IR	31200-PB2-003	JS356	31200-PLC-T01	JS1360
31100-PE0-004	JA113IR	31100-RAA-A040	JA1726IR	31200-PB2-006	JS315	31200-PLC-T011M	JS1360
31100-PE0-013	JA113IR	31100-RAA-A05	JA1726IR	31200-PB2-014	JS315	31200-PLZ-D00	JS1158
31100-PE0-014	JA113IR	31200-634-005	JS310	31200-PB2-016	JS315	31200-PM1-005	JS319
31100-PE0-020	JA113IR	31200-634-670	JS310	31200-PC0-004	JS375	31200-PM3-003	JS319
31100-PE0-023	JA113IR	31200-634-671	JS310	31200-PC0-015	JS375	31200-PM3-0032	JS319
31100-PE0-024	JA113IR	31200-634-810	JS310	31200-PC1-001	JS375	31200-PM3-004	JS319
31100-PE0-034	JA113IR	31200-634-811	JS310	31200-PC1-004	JS375	31200-PM3-005	JS645
31100-PE0-044	JA113IR	31200-657-004	JS315	31200-PC1-005	JS375	31200-PM3-101	JS319
31100-PE0-924	JA113IR	31200-657-005	JS310	31200-PC2-004	JS315	31200-PM3-J02	JS1022
31100-PE8-601	JA157	31200-657-010	JS315	31200-PC2-014	JS315	31200-PM3-J021	JS1022
31100-PEC-J71	JA1514IR	31200-657-015	JS310	31200-PC2-661	JS314	31200-PM5-L02	JS311
31100-PEJ-004	JA1514IR	31200-657-016	JS310	31200-PC2-662	JS314	31200-PM7-005	JS645
31100-PEL-E01	JA1720IR	31200-657-025	JS310	31200-PC2-671	JS315	31200-PM7-306	JS645
31100-PEM-G01	JA1720IR	31200-657-671	JS315	31200-PC5-004	JS375	31200-PMH-G01	JS1353
31100-PG6-013	JA752IR	31200-671-005	JS310	31200-PC5-015	JS375	31200-PMH-G010M5	JS1353
31100-PG7-003	JA752IR	31200-671-671	JS315	31200-PC5-024	JS314	31200-PNE-G01	CS1456
31100-PG7-013	JA752IR	31200-673-005	JS310	31200-PC5-892	JS315	31200-PO1-005	JS319
31100-PG7-023	JA752IR	31200-673-015	JS310	31200-PC6-003	JS356	31200-PR3-004	JS1017
31100-PG7-033	JA752IR	31200-676-600	JS347	31200-PC6-0033	JS356	31200-PT0-003	JS1150
31100-PH1-004	JA771IR	31200-676-601	JS314	31200-PC6-661	JS356	31200-PT0-0031	JS1150
31100-PH1-014	JA771IR	31200-676-602	JS347	31200-PC6-6615	JS765	31200-PT0-005	JS648
31100-PH1-024	JA771IR	31200-676-603	JS347	31200-PC6-662	JS765	31200-PT1-PO3	JS648
31100-PH1-0242	JA771IR	31200-676-604	JS347	31200-PC6-663	JS314	31200-PT1-T03	JS648
31100-PH2-J010M	JA771IR	31200-676-605	JS347	31200-PC6-664	JS765	31200-PWA-G01	JS1364
31100-PH3-013	JA554IR	31200-679-004	JS310	31200-PCA-003	JS648	31200-PWA-G51	JS1364
31100-PH3-0243	JA554IR	31200-679-0053	JS310	31200-PD2-003	JS356	31200-RBD-E01	CS1427
31100-PH7-0040	JA555IR	31200-679-0441	JS310	31200-PD2-0031	JS356	31200-RNA-A01	CS1458
31100-PH7-024	JA555IR	31200-679-814	JS310	31200-PD2-006	JS356	31200-RSH-E01	CS1489
31100-PJ0-306	JA696IR	31200-689-006	JS314	31200-PD2-0130	JS356	31200-RSR-E01	CS1457
31100-PJ0-661	JA696IR	31200-689-016	JS314	31200-PD2-016	JS356	38760-634-811	JA111



O.E. NO.	HC-PARTS	O.E. NO.	HC-PARTS	O.E. NO.	HC-PARTS	O.E. NO.	HC-PARTS
AHGA01	JA751IR	CSC91	CA1980IR *	11.130.253	CS335	11.130.711	CS109
AHGA02	JA751IR	CSD73	JA1726IR	11.130.254	CS718	11.130.716	CS594
AHGA03	JA753IR	CSD86	CA1980IR *	11.130.266	CS162	11.130.717	CS719
AHGA17	JA980IR	CSD89	CA1980IR *	11.130.300	CS188	11.130.722	CS295
AHGA18	JA980IR	CSF37	CA2078IR *	11.130.321	CS91	11.130.723	CS713
AHGA24	JA1514IR	DDLD9	JS1215	11.130.322	CS240	11.130.724	CS615
AHGA25	JA1520IR	DDVD3	JS1215	11.130.328	CS390	11.130.728	CS1112
AHGA26	JA1520IR	DDVDH	JS1360	11.130.334	CS116	11.130.729	CS608
AHGA35	JA1514IR	DDVDT	JS1364	11.130.338	CS326	11.130.730	CS1243
AHGA38	JA1520IR	DDVDU	JS1364	11.130.339	CS120	11.130.763	CS796
AHGA44	JA1514IR	DFLEA	JS311	11.130.346	CS310	11.130.766	CS726
AHGA45	JA1520IR	DR4FD	JS315	11.130.351	CS261	11.130.769	CS337
AHGA50	JA1727IR	DR4FM	JS315	11.130.352	CS263	11.130.777	CS389
AHGA51	JA1727IR	DR4R2	JS375	11.130.366	CS682	11.130.787	CS542
AHGA53	JA1728IR	DR4R6	JS319	11.130.373	CS201	11.130.790	CS310
AHGA55	JA1728IR	DR4U2	JS1150	11.130.375	CS129	11.130.819	CS395
AHGA56	JA1897IR	DRD18	JS314	11.130.378	CS315	11.130.841	CS1130
AHGA61	JA1728IR	DRDF3	JS356	11.130.386	CS201	11.130.845	CS614
AHGA64	JA1727IR	DRDFE	JS319	11.130.392	CS536	11.130.860	JS931
AHGA65	JA1728IR	DRDIV	JS356	11.130.395	CS355	11.130.872	CS201
AHGA67	CA1981IR	DRLF0	JS319	11.130.398	CS390	11.130.885	CS188
AHGA69	JA1897IR	DRLF1	JS315	11.130.399	CS188	11.130.886	CS188
AHGA77	CA2080IR *	DS4R5	CS1458	11.130.403	CS240	11.130.889	CS503
CHA08	JA113IR	DS4RC	CS1458	11.130.404	CS293	11.130.898	CS718
CHA12	JA751IR	DSDEC	CS1455	11.130.407	CS120	11.130.910	CS358
CHA16	JA752IR	DSDH6	CS1456	11.130.408	CS109	11.130.911	CS624
CHA16	JA752IR	DV4DA	CS1489	11.130.409	CS704	11.130.912	CS616
CHA18	JA752IR ▲	DX4R4	JS1022	11.130.410	CS240	11.130.913	CS574
CHA19	JA113IR	DXK14	JS1151	11.130.411	CS201	11.130.944	CS608
CHA32	JA752IR	MHG020	CS1427	11.130.412	CS186	11.130.956	CS310
CHA33	JA113IR	MHG023	CS1427	11.130.414	CS944	11.130.957	CS784
CHA48	JA751IR	MHG025	CS1457	11.130.417	CS1182	11.130.963	CS123
CHA49	JA751IR	PEO014	JA113IR	11.130.421	CS796	11.130.964	CS91
CHA50	JA753IR	PEO034	JA113IR	11.130.431	CS168	11.130.965	CS390
CHA51	JA753IR			11.130.483	CS123	11.130.966	CS162
CHA57	JA753IR	ISKRA		11.130.484	CS103	11.130.967	CS90
CHA84	JA753IR	11.130.007	CS126	11.130.490	CS394	11.130.972	CS705
CIK46	JA555IR	11.130.010	CS120	11.130.491	CS530	11.130.996	CS1212
CIK4-6	JA555IR	11.130.026	CS103	11.130.492	CS232	11.130.997	CS1045
CJK09	JA177IR	11.130.029	CS150	11.130.500	CS230	11.131.027	CS1126
CJK22	JA696IR	11.130.034	CS94	11.130.505	CS332	11.131.038	CS106
CJK35	JA696IR	11.130.041	CS191	11.130.509	CS201	11.131.054	CS1062
CJK36	JA771IR	11.130.074	CS109	11.130.519	CS91	11.131.055	CS974
CJK46	JA555IR	11.130.076	CS201	11.130.520	CS1032	11.131.056	CS801
CJK87	JA759IR	11.130.084	CS166	11.130.526	CS703	11.131.057	CS1287
CJK88	JA772IR	11.130.085	CS166	11.130.529	CS390	11.131.065	CS1123
CJN33	JA771IR	11.130.102	CS505	11.130.532	CS689	11.131.070	CS703
CJN40	JA1272IR	11.130.117	CS114	11.130.534	CS395	11.131.085	CS595
CJN42	JA980IR	11.130.123	CS230	11.130.537	CS269	11.131.086	CS1261
CJN61	JA759IR	11.130.124	CS394	11.130.556	CS390	11.131.088	CS1057
CJN84	JA759IR	11.130.127	CS240	11.130.558	CS322	11.131.137	CS1119
CJN85	JA772IR	11.130.140	CS240	11.130.567	CS887	11.131.143	CS269
CJN89	JA772IR	11.130.141	CS530	11.130.569	CS395	11.131.144	CS595
CJP16	JA1163IR	11.130.146	CS231	11.130.579	CS200	11.131.177	CS269
CJP18	JA760IR	11.130.151	CS530	11.130.580	CS162	11.131.232	CS594
CJP18	JA760IR	11.130.162	CS95	11.130.582	CS310	11.131.236	CS595
CJP28	JA1414IR	11.130.166	CS505	11.130.586	CS90	11.131.297	CS976
CJP62	JA1272IR	11.130.179	CS944	11.130.590	CS321	11.131.430	CS1126
CJP79	JA760IR	11.130.193	CS315	11.130.593	CS332	11.131.476	CS1198
CJQ18	JA1273IR	11.130.194	CS109	11.130.596	CS607	11.131.477	CS885
CJQ19	JA1280IR	11.130.198	CS704	11.130.598	CS608	11.131.622	CS519
CJQ20	JA980IR	11.130.199	CS240	11.130.600	CS261	11.131.705	CS1126
CJQ58	JA1129IR	11.130.200	CS201	11.130.618	CS795	11.131.754	CS1130
CJS42	JA1278IR	11.130.201	CS335	11.130.619	CS398	11.131.769	CS1130
CJS50	JA1408IR	11.130.203	CS572	11.130.624	CS200	11.131.928	CS807
CJS88	JA1163IR	11.130.208	CS310	11.130.626	CS595	11.139.008	CS951
CJU75	JA1719IR	11.130.210	CS79	11.130.629	CS201	11.139.012	CS121
CJU77	JA1719IR	11.130.216	CS231	11.130.642	CS373	11.139.013	CS384
CJV07	JA1719IR	11.130.217	CS95	11.130.646	CS684	11.139.020	CS526
CJV77	JA1787IR	11.130.218	CS142	11.130.647	CS341	11.139.022	CS881
CJV78	JA1720IR	11.130.219	CS90	11.130.651	CS372	11.139.025	CS617
CJX27	JA1720IR	11.130.225	CS232	11.130.661	CS371	11.139.028	CS99
CKA27	JA153	11.130.229	CS186	11.130.664	CS1069	11.139.029	CS699
CKA29	JA170	11.130.230	CS120	11.130.669	CS550	11.139.030	CS688
CKA30	JA153 ▲	11.130.233	CS326	11.130.673	CS530	11.139.032	CS198
CKZ29	JA144	11.130.234	CS95	11.130.695	CS1069	11.139.077	CS955
CPB04	JA168	11.130.244	CS321	11.130.697	CS682	11.139.107	CS962
CPB18	JA157	11.130.245	CS129	11.130.704	CS503	11.139.163	CS1274
CSC29	JA1726IR	11.130.246	CS168	11.130.706	CS1173	11.139.164	CS1061



O.E. NO.	HC-PARTS	O.E. NO.	HC-PARTS	O.E. NO.	HC-PARTS	O.E. NO.	HC-PARTS		
AZE2165	CS976	◆	AZJ0404	CS109	AZJ3542	CS231	IA0675	CA1629IR	
AZE2169	JS1158	◆	AZJ0405	CS201	AZJ3544	CS109	IA0705	CA333IR	
AZE2188	CS1193	◆	AZJ3105	CS201	AZJ3546	CS232	◆	IA0709	CA854IR
AZE2189	CS1245	◆	AZJ3107	CS188	◆	AZJ3548	CS186	IA0723	CA743IR
AZE2204	CS1053	◆	AZJ3110	CS240	AZJ3549	CS120	◆	IA0732	CA345IR
AZE2206	CS1044	◆	AZJ3113	CS120	AZJ3556	CS335	◆	IA0744	CA833IR
AZE2226	CS1245	◆	AZJ3115	CS704	AZJ3557	CS718	◆	IA0746	CA857IR
AZE2502	CS1182	◆	AZJ3116	CS240	AZJ3567	CS188	◆	IA0754	CA825IR
AZE2507	CS322	◆	AZJ3117	CS201	AZJ3582	CS240	◆	IA0763	CA557IR
AZE2512	CS332	◆	AZJ3118	CS186	AZJ3589	CS120	◆	IA0767	CA607IR
AZE2521	CS373	◆	AZJ3119	CS944	AZJ3590	CS128	◆	IA0784	CA734IR
AZE2522	CS684	◆	AZJ3128	CS103	AZJ3591	CS314	◆	IA0789	CA705IR
AZE2523	CS341	◆	AZJ3131	CS394	AZJ3594	CS682	◆	IA0811	CA650IR
AZE2525	CS372	◆	AZJ3132	CS530	AZJ3598	CS201	◆	IA0824	CA717IR
AZE2534	CS594	◆	AZJ3133	CS232	◆	AZK5112	CS951	IA0832	CA1201IR
AZE2537	CS713	◆	AZJ3137	CS230	AZK5168	CS951	◆	IA0873	CA1050IR
AZE2578	CS624	◆	AZJ3144	CS201	AZK5172	CS121	◆	IA0875	CA1198IR
AZE2580	CS574	◆	AZJ3148	CS1032	AZK5173	CS384	◆	IA0889	CA733IR
AZE2623	CS1062	◆	AZJ3151	CS703	AZK5179	CS526	◆	IA0890	CA717IR
AZE2624	CS974	◆	AZJ3156	CS689	AZK5181	CS881	◆	IA0895	CA1236IR
AZE2625	CS801	◆	AZJ3158	CS395	AZK5184	CS617	◆	IA0990	CA740IR
AZE2626	CS1287	◆	AZJ3160	CS269	AZK5187	CS99	◆	IA0993	CA738IR
AZE2634	CS1119	◆	AZJ3169	CS103	◆	AZK5188	CS699	IA1005	CA1062IR
AZE2665	CS988	◆	AZJ3177	CS1184	◆	AZK5189	CS688	IA1006	CA1301IR
AZE3502	CS505	◆	AZJ3179	CS887	◆	AZK5191	CS198	IA1009	CA1138IR
AZE3506	CS95	◆	AZJ3181	CS395	◆	AZK5401	CS191	IA1013	CA1090IR
AZE3508	CS505	◆	AZJ3182	CS200	◆	AZK5431	CS955	IA1018	CA1379IR
AZE3512	CS95	◆	AZJ3187	CS607	◆	AZK5456	CS962	IA1019	CA187IR
AZE3513	CS142	◆	AZJ3188	CS608	◆	AZK5545	CS191	IA1039	CA1238IR
AZE3514	CS90	◆	AZJ3195	CS795	◆	IA0021	CA112	IA1040	CA1043IR
AZE3517	CS95	◆	AZJ3196	CS398	◆	IA0037	CA77IR	IA1041	CA1152IR
AZE3559	CS321	◆	AZJ3198	CS200	◆	IA0055	CA212IR	IA1043	CA1300IR
AZE4101	CS977	◆	AZJ3199	CS595	◆	IA0062	CA603IR	IA1045	CA827IR
AZE4102	CS613	◆	AZJ3203	CS201	◆	IA0067	CA17H	IA1057	CA1480IR
AZE4112	CS885	◆	AZJ3216	CS1069	◆	IA0067	CA359IR	IA1064	CA1297IR
AZE4140	CS576	◆	AZJ3218	CS550	◆	IA0069	CA341IR	IA1065	CA1228IR
AZE4142	CS973	◆	AZJ3222	CS530	◆	IA0075	CA212IR	IA1081	CA1433IR
AZE4527	CS331	◆	AZJ3231	CS391	◆	IA0094	CA288IR	IA1085	CA1057IR
AZE4562	CS977	◆	AZJ3234	CS944	◆	IA0095	CA1387IR	IA1094	CA1770IR
AZE4564	CS370	◆	AZJ3236	CS1069	◆	IA0096	CA76IR	IA1095	CA1493IR
AZE4635	JS769	◆	AZJ3237	CS682	◆	IA0097	CA186IR	IA1096	CA1667IR
AZE6513	CS1198	◆	AZJ3242	CS503	◆	IA0116	CA76IR	IA1101	CA1624IR
AZE6514	CS885	◆	AZJ3244	CS1173	◆	IA0122	CA376IR	IA1102	CA1659IR
AZF3509	CS315	◆	AZJ3248	CS109	◆	IA0145	CA505IR	IA1103	CA1237IR
AZF3512	CS310	◆	AZJ3263	CS97	◆	IA0201	CA187IR	IA1104	CA1236IR
AZF3513	CS79	◆	AZJ3277	CS726	◆	IA0208	CA169IR	IA1106	CA1237IR
AZF3515	CS326	◆	AZJ3279	CS337	◆	IA0211	CA319IR	IA1108	CA1206IR
AZF3517	CS321	◆	AZJ3283	CS395	◆	IA0215	CA235IR	IA1110	CA1299IR
AZF3518	CS129	◆	AZJ3297	JS931	◆	IA0220	CA139IR	IA1117	CA1831IR
AZF3519	CS168	◆	AZJ3305	CS201	◆	IA0242	CA255IR	IA1127	CA1049IR
AZF3524	CS293	◆	AZJ3311	CS188	◆	IA0258	CA350IR	IA1128	CA1402IR
AZF3527	CS116	◆	AZJ3312	CS188	◆	IA0294	CA316IR	IA1137	CA1623IR
AZF3528	CS326	◆	AZJ3314	CS503	◆	IA0297	CA352IR	IA1142	CA1502IR
AZF3531	CS310	◆	AZJ3320	CS718	◆	IA0328	CA355IR	IA1144	CA1436IR
AZF3533	CS261	◆	AZJ3347	CS705	◆	IA0329	CA355IR	IA1145	CA1504IR
AZF3534	CS263	◆	AZJ3364	CS106	◆	IA0331	CA1435IR	IA1146	CA1446IR
AZF3542	CS232	◆	AZJ3369	CS703	◆	IA0332	CA506IR	IA1147	CA1378IR
AZF3543	CS129	◆	AZJ3374	CS595	◆	IA0336	CA316IR	IA1148	CA1542IR
AZF3545	CS315	◆	AZJ3375	CS1261	◆	IA0360	CA187IR	IA1150	CA907IR
AZF3547	CS536	◆	AZJ3387	CS269	◆	IA0393	CA241IR	IA1153	CA1335IR
AZF3549	CS355	◆	AZJ3388	CS595	◆	IA0404	CA294IR	IA1158	CA1564IR
AZF3552	CS168	◆	AZJ3393	CS269	◆	IA0440	CA1347IR	IA1163	CA1394IR
AZF3555	CS332	◆	AZJ3404	CS595	◆	IA0445	CA87IR	IA1164	CA1782IR
AZF3558	CS310	◆	AZJ3448	CS1274	◆	IA0476	CA378IR	IA1191	CA828IR
AZF3559	CS321	◆	AZJ3450	CS1061	◆	IA0498	CA1472IR	IA1204	CA1085IR
AZF3560	CS261	◆	AZJ3508	CS114	◆	IA0507	CA616IR	IA1222	CA1646IR
AZF4115	CS1126	◆	AZJ3514	CS230	◆	IA0514	CA709	IA1223	CA1499IR
AZF4183	CS1126	◆	AZJ3516	CS240	◆	IA0519	CA824IR	IA1228	CA1677IR
AZF4194	CS1130	◆	AZJ3517	CS240	◆	IA0522	CA333IR	IA1244	CA1509IR
AZF4197	CS1130	◆	AZJ3518	CS530	◆	IA0529	CA619IR	IA1246	CA1248IR
AZF4507	CS1112	◆	AZJ3520	CS231	◆	IA0530	CA259IR	IA1252	CA1486IR
AZF4508	CS608	◆	AZJ3522	CS530	◆	IA0536	CA602IR	IA1253	CA829IR
AZF4509	CS1243	◆	AZJ3525	CS944	◆	IA0544	CA207IR	IA1254	CA1226IR
AZF4514	CS1130	◆	AZJ3531	CS109	◆	IA0554	CA649IR	IA1255	CA1486IR
AZF4521	CS395	◆	AZJ3534	CS704	◆	IA0555	CA326IR	IA1260	CA1838IR
AZF4527	CS608	◆	AZJ3535	CS240	◆	IA0564	CA189IR	IA1269	CA1229IR
AZF4539	CS1126	◆	AZJ3536	CS201	◆	IA0585	CA642IR	IA1304	CA1560IR
AZF4542	CS1123	◆	AZJ3537	CS335	◆	IA0595	CA1197IR	IA1305	CA1567IR
AZJ0402	CS103	◆	AZJ3538	CS572	◆	IA0632	CA87IR	IA1306	CA1815IR

O.E. NO.	HC-PARTS	O.E. NO.	HC-PARTS	O.E. NO.	HC-PARTS	O.E. NO.	HC-PARTS
<b>ISKRA <i>Continued</i></b>							
IA1307	CA1588IR	IS0647	CS341	IS9031	CS1167	AAG1111	CA17H ◆
IA1330	CA1824IR	IS0664	CS550	IS9032	CS198	AAG1130	CA77IR
IA1339	CA1541IR	IS0669	CS550	IS9045	CS1163	AAG1301	CA76IR
IA1340	CA1496IR	IS0695	CS1069	IS9059	CS1284	AAG1307	CA603IR
IA1341	CA1589IR	IS0705	CS511	IS9068	CS955	AAG1310	CA613IR
IA1348	CA1198IR	IS0706	CS1173	IS9083	CS956	AAG1311	CA76IR
IA1412	CA1984IR	IS0711	CS109	IS9096	CS962	AAG1315	CA76IR
IA1414	CA1762IR	IS0716	CS715	IS9124	CS1163	AAG1328	CA76IR
IA1416	CA1572IR	IS0722	CS295	IS9141	CS950	AAG1338	CA616IR
IA1418	CA1627IR	IS0723	CS713	IS9142	CS1077	AAG1341	CA616IR
IA1430	CA1761IR	IS0726	CS188	IS9143	CS1333	AAK1102	CA136IR
IA1432	CA1813IR	IS0728	CS1381	IS9144	CS1269	AAK1105	CA136IR
IA1434	CA1661IR	IS0729	CS1267	IS9144	CS1463	AAK1107	CA568IR
IA1435	CA1674IR	IS0730	CS1243	IS9145	CS1199	AAK1109	CA341IR ◆
IA1436	CA1827IR	IS0732	CS995	IS9146	CS1169	AAK1110	CA212IR ◆
IA1437	CA1814IR	IS0743	CS97	IS9147	CS1274	AAK1111	CA359IR ◆
IA1439	CA1645IR	IS0763	CS796	IS9148	CS1061	AAK1114	CA96IR
IA9003	JA863IR	IS0766	CS726	IS9149	CS1274	AAK1116	CA255IR ▲
IA9005	CA1146IR	IS0772	CS358	IS9300	JS651	AAK1118	CA85IR
IA9006	CA1034IR	IS0773	CS624	IS9305	CS331	AAK1119	CA52IR
IA9014	JA769IR	IS0775	CS619	IS9307	CS1075	AAK1122	CA140IR
IA9015	JA1172IR	IS0776	CS616	IS9310	CS585	AAK1123	CA127IR
IA9017	CA1317IR	IS0777	CS389	IS9311	CS725	AAK1125	CA187IR
IA9018	JA871IR	IS0787	CS542	IS9312	CS620	AAK1128	CA307IR ◆
IA9020	CA1053IR	IS0790	CS310	IS9313	US1240	AAK1129	CA288IR
IA9026	CA1483IR	IS0811	CS783	IS9317	JS1091	AAK1130	CA186IR
IA9027	CA1649IR	IS0841	CS1130	IS9319	JS517	AAK1131	CA99IR
IA9028	CA1340IR	IS0844	CS574	IS9327	CS880	AAK1134	CA222IR ◆
IA9405	CA645IR	IS0845	CS614	IS9330	CS374	AAK1135	CA316IR ◆
IA9407	CA853IR	IS0854	CS618	IS9331	CS977	AAK1137	CA125IR
IA9408	CA1035IR	IS0889	CS503	IS9332	CS613	AAK1139	CA136IR
IA9411	CA1148IR	IS0896	CS623	IS9333	CS370	AAK1140	CA376IR
IA9412	CA1593IR	IS0957	CS784	IS9334	JS1158	AAK1143	CA706IR
IA9413	CA1505IR	IS0996	CS1212	IS9335	CS1160	AAK1144	CA85IR
IA9414	CA333IR	IS1016	CS1126	IS9403	CS681	AAK1145	CA246IR
IA9418	CA1556IR	IS1018	CS106	IS9404	CS581	AAK1146	CA69IR
IA9419	CA227IR	IS1024	CS879	IS9409	CS618	AAK1148	CA293IR
IA9420	CA550IR	IS1029	CS1261	IS9409	CS713	AAK1150	CA505IR
IA9423	CA1336IR	IS1040	CS1062	IS9412	CS294	AAK1152	CA87IR ◆
IA9424	CA1473IR	IS1041	CS974	IS9414	CS886	AAK1153	CA187IR
IA9425	CA1481IR	IS1042	CS801	IS9416	CS784	AAK1157	CA87IR ◆
IA9426	CA1581IR	IS1043	CS1287	IS9417	CS1193	AAK1163	CA252IR
IA9429	CA1593IR	IS1046	CS1032	IS9418	CS1245	AAK1165	CA235IR
IA9430	CA255IR	IS1047	CS1057	IS9421	CS979	AAK1167	CA341IR ◆
IA9432	CA1438IR	IS1075	CS594	IS9422	CS1036	AAK1170	CA375IR ◆
IA9433	CA569IR	IS1078	CS1077	IS9423	CS1445	AAK1171	CA127IR
IA9438	CA115	IS1094	CS1119	IS9424	CS1249	AAK1173	CA254IR
IA9439	CA1633IR	IS1101	CS1471	IS9426	CS1053	AAK1175	CA351IR ◆
IA9440	CA2040IR	IS1169	CS1248	IS9427	CS1188	AAK1176	CA169IR
IA9442	CA1035IR	IS1170	CS566	IS9428	CS1044	AAK1177	CA264IR
IA9443	CA1593IR	IS1174	CS519	IS9430	CS360	AAK1179	CA319IR ◆
IA9444	CA1505IR	IS1175	CS1050	IS9431	CS1294	AAK1181	CA99IR
IA9445	CA1593IR	IS1179	US863	IS9432	CS988	AAK1183	CA139IR
IAJ0039	CA2018IR	IS1190	CS1061	IS9433	CS62	AAK1198	CA505IR
IS0193	CS95	IS1216	CS581	IS9434	CS576	AAK1209	CA212IR ◆
IS0201	CS335	IS1263	CS572	IS9435	CS386	AAK1228	CA709 ◆
IS0203	CS572	IS1264	CS1268	IS9436	CS973	AAK1309	CA187IR ◆
IS0216	CS231	IS1265	CS1257	IS9437	CS1201	AAK1312	CA1433IR
IS0320	CS694	IS1269	CS1198	IS9438	CS1118	AAK1324	CA226IR ◆
IS0334	CS116	IS1279	CS807	IS9440	CS1253	AAK1326	CA305IR ▲
IS0352	CS263	IS1285	CS1405	IS9441	CS1174	AAK1329	CA305IR ◆
IS0407	CS120	IS1286	CS1334	IS9442	CS1276	AAK1333	CA564IR ◆
IS0408	CS109	IS1296	CS1279	IS9450	CS1389	AAK1339	CA717IR
IS0417	CS1182	IS9002	CS383	ISJ0001	JS349	AAK1344	CA1330IR
IS0490	CS394	IS9007	CS951	ISJ0002	JS380	AAK1347	CA333IR ◆
IS0505	CS332	IS9009	CS194	ISJ0003	JS525	AAK1352	CA341IR
IS0520	CS1032	IS9011	CS121	ISJ0004	JS305	AAK1358	CA96IR ▲
IS0532	CS689	IS9012	CS121	ISJ0005	JS766	AAK1363	CA1197IR ◆
IS0537	CS269	IS9013	CS384	ISJ0006	JS923	AAK1367	CA333IR ◆
IS0558	CS322	IS9017	CS1031	ISJ0007	JS637	AAK1368	CA854IR ◆
IS0565	CS1184	IS9019	CS502	ISJ0008	JS319	AAK1369	CA500IR ◆
IS0569	CS395	IS9020	CS526	ISJ0009	JS1141	AAK1378	CA340IR ◆
IS0597	CS983	IS9021	CS564	ISJ0010	JS770	AAK1380	CA564IR ▲
IS0598	CS608	IS9022	CS881	ZB4-12/06-9	CS126	◆ AAK1383	CA857IR
IS0600	CS261	IS9025	CS617	AAG0402	CA77IR	▲ AAK1388	CA306IR ◆
IS0600	CS70	IS9026	CS506	AAG0403	CA77IR	▲ AAK1811	CA1433IR ◆
IS0632	CS1032	IS9028	CS99	AAG0702	CA112	AAK1815	CA1198IR
IS0642	CS373	IS9029	CS699	AAG1101	CA46IR	AAK3117	CA130IR
IS0646	CS684	IS9030	CS688	AAG1104	CA77IR	▲ AAK3122	CA717IR

O.E. NO.	HC-PARTS		O.E. NO.	HC-PARTS	O.E. NO.	HC-PARTS	O.E. NO.	HC-PARTS		
AAK3124	CA717IR	▲	AAK4518	CA316IR	◆	AAK5543	CA1446IR	◆	8941475492	JS776
AAK3128	CA548IR		AAK4519	CA305IR	◆	AAK5544	CA1378IR	◆	8941492490	JS767
AAK3129	CA548IR		AAK4521	CA650IR		AAK5547	CA1502IR	◆	8941503960	JA681
AAK3130	CA513IR	◆	AAK4523	CA564IR	◆	AAK5553	CA1564IR	◆	8941503970	JA681
AAK3132	CA517IR		AAK4524	CA305IR	◆	AAK5573	CA1317IR	◆	8941566710	JS534
AAK3133	CA353IR		AAK4525	CA517IR		AAK5574	JA1521IR		8941566720	JA697IR
AAK3134	CA516IR	◆	AAK4526	CA325IR	◆	AAK5580	CA1085IR	◆	8941723260	JA697IR
AAK3142	JA863IR	◆	AAK4528	CA353IR		AAK5585	CA1646IR	◆	8941699520	JA862IR
AAK3161	JA863IR	◆	AAK4529	CA509IR	◆	AAK5717	CA1049IR	◆	8941717780	JA116IR
AAK3301	CA1201IR	◆	AAK4530	CA642IR		AAK5723	CA1581IR	◆	8941720940	JA862IR
AAK3318	CA501IR	◆	AAK4531	CA702IR	◆	AAN0112	CA1505IR	◆	8942113500	JS534
AAK3320	CA564IR	◆	AAK4532	CA561IR		AAN3107	CA853IR	◆	8941725860	JA546IR
AAK3330	CA1197IR	◆	AAK4542	CA533IR		AAN3108	CA1035IR	◆	8942044380	JS549
AAK3332	CA500IR	◆	AAK4544	CA375IR	◆	AAN3110	CA1148IR		8942060810	JA100
AAK3333	CA743IR	◆	AAK4552	CA254IR	▲	AAN3111	CA1593IR	◆	8942113500	JA157
AAK3334	CA857IR		AAK4554	CA1387IR		AAN3112	CA1505IR		8942160641	JS354
AAK3369	CA564IR	◆	AAK4556	CA851IR	◆	AAN5115	CA1045IR		8942160642	JS354
AAK3505	CA367IR		AAK4557	CA601IR		AAN5122	CA1831IR		8942313070	JA543IR
AAK3510	CA319IR	◆	AAK4558	CA596IR	▲	AAN5131	CA1057IR	◆	8942320811	JA543IR
AAK3511	CA237IR		AAK4559	CA596IR		AAN5133	CA1300IR	◆	8942320812	JA543IR
AAK3515	CA359IR	◆	AAK4562	CA506IR	◆	AAN5136	CA1480IR	◆	8942340650	JS549
AAK3520	CA87IR		AAK4564	CA717IR		AAN5171	CA907IR	◆	8942387580	JS629
AAK3525	CA87IR		AAK4567	CA306IR		AAN5178	CA1394IR		8942416302	JA655IR
AAK3528	CA294IR	◆	AAK4569	CA851IR	▲	AAN5322	CA1509IR	◆	8942442982	JA655IR
AAK3529	CA252IR		AAK4571	CA345IR	◆	AAN5533	CA1509IR	◆	8942510881	JS532
AAK3538	CA252IR		AAK4575	CA650IR		AAN5772	CA1509IR	◆	8942549221	JS748
AAK3542	CA520IR		AAK4578	CA345IR	▲	AAN7101	CA1677IR		8943325811	JA874IR
AAK3543	CA242IR		AAK4588	CA849IR	◆	AAN7112	CA1838IR		8943325812	JA874IR
AAK3544	CA242IR		AAK4591	CA705IR	◆	AAT1302	CA1236IR		8943325860	JS753
AAK3548	CA87IR	◆	AAK4598	CA564IR	◆	AAT1303	CA824IR		8943334380	JS748
AAK3553	CA706IR		AAK4599	CA650IR		AAT1305	CA1659IR		8943377970	JS532
AAK3557	CA222IR	◆	AAK4831	CA1198IR		AAT1306	CA1236IR		8943446930	JS534
AAK3560	CA316IR	◆	AAK4858	CA643IR	◆	AAT1308	CA1236IR		8943718330	JS534
AAK3564	CA212IR	◆	AAK5102	CA1347IR		AAT1318	CA1237IR		8943719331	JS534
AAK3565	CA224IR		AAK5105	CA1472IR		AAT1336	CA1659IR		8944320590	JA761IR
AAK3568	CA378IR		AAK5108	CA638IR	◆	AAT1340	CA1237IR		8943820591	JA761IR
AAK3573	CA88IR	◆	AAK5114	CA1629IR					8943820600	JA761IR
AAK3577	CA310IR		AAK5118	CA1629IR		ISUZU			8943863280	JS651
AAK3579	CA358IR	◆	AAK5127	CA833IR	◆	1811001891	JS746		8943876530	JS999
AAK3583	CA574IR	◆	AAK5131	CA825IR	◆	5811000800	JS679		8944017932	JA661IR
AAK3585	CA141IR		AAK5136	CA638IR	◆	5811000801	JS679		8944046360	JA862IR
AAK3590	CA96IR	◆	AAK5165	CA1198IR		5811001111	JS679		8944050440	JA661IR
AAK3591	CA372IR	◆	AAK5169	CA733IR	◆	5811001112	JS679		8944050442	JA661IR
AAK3594	CA529IR		AAK5171	CA736IR		5811001662	JS552		8944086740	JA546IR
AAK3595	CA602IR		AAK5186	CA1065IR	◆	5811001663	JS552		8944119072	JA862IR
AAK3822	CA1433IR	◆	AAK5198	CA740IR		5811001664	JS552		8944119082	JA862IR
AAK4106	CA906IR		AAK5301	CA856IR	◆	5811001830	JS552		8944121420	JS354
AAK4118	CA312IR		AAK5302	CA738IR	◆	5811001920	JS778		8944121421	JS354
AAK4128	CA131IR	◆	AAK5305	CA1044IR	◆	5811001921	JS778		8944139970	JA697IR
AAK4131	CA352IR	◆	AAK5306	CA1062IR	◆	5812001631	JA130		8944195191	JA761IR
AAK4133	CA264IR		AAK5307	CA1301IR	◆	5812001641	JA130		8944237560	JA116IR
AAK4135	CA96IR	◆	AAK5308	CA1090IR	◆	5812003161	JA661IR		8944299772	JS776
AAK4138	CA255IR	◆	AAK5312	CA1138IR	◆	5812003162	JA661IR		8944299780	JS767
AAK4139	CA306IR	◆	AAK5315	CA1629IR	◆	5812003163	JA661IR		8944299990	JA546IR
AAK4140	CA316IR	◆	AAK5319	CA724IR	◆	5812003380	JA116IR		8944299991	JA546IR
AAK4141	CA87IR	◆	AAK5322	CA1209IR	◆	5812003381	JA116IR		8944339120	JS639
AAK4143	CA99IR		AAK5326	CA1379IR	◆	5812003411	JA116IR		8944339121	JS639
AAK4151	CA355IR	▲	AAK5329	CA1043IR	◆	5812003470	JA884IR		8944410870	JS533
AAK4155	CA355IR	▲	AAK5332	CA1152IR	◆	8411155670	JS629		8944410871	JS533
AAK4157	CA139IR		AAK5349	CA1297IR	◆	8933004180	CS1036		8944479540	JS533
AAK4158	CA506IR		AAK5350	CA1228IR	◆	8941150670	JS629		8944489590	JS552
AAK4160	CA601IR		AAK5359	CA1086IR	◆	8941155650	JS353		8944489591	JS552
AAK4162	CA316IR	◆	AAK5360	CA1086IR	◆	8941155670	JS629		8944490540	JA680IR
AAK4168	CA357IR	◆	AAK5363	CA1629IR		8941155671	JS629		8944490542	JA680IR
AAK4170	CA355IR	▲	AAK5376	CA501IR	◆	8941155672	JS629		8944497820	JS532
AAK4174	CA893IR		AAK5380	CA827IR	◆	8941224884	JA761IR		8944521343	JA680IR
AAK4176	CA355IR		AAK5382	CA1062IR	◆	8941271840	JA101		8944527390	JA680IR
AAK4177	CA350IR		AAK5391	CA1062IR	◆	8941271850	JA103	▲	8944527392	JA680IR
AAK4179	CA187IR		AAK5501	CA1044IR	◆	8941271860	JA103		8944527403	JA680IR
AAK4183	CA170IR		AAK5502	CA736IR	◆	8941313560	JS354		8944532120	JS552
AAK4189	CA294IR	◆	AAK5503	CA1253IR	◆	8941313562	JS354		8944541880	JA1120IR
AAK4192	CA207IR	◆	AAK5505	CA1034IR	◆	8941313572	JA546IR		8944541881	JA1120IR
AAK4195	CA241IR		AAK5510	CA1103IR	◆	8941333381	JS1008		8944548911	JS651
AAK4320	CA1433IR	◆	AAK5512	CA1317IR	◆	8941364480	JS629		8944604170	JS639
AAK4351	CA1242IR	◆	AAK5513	CA1053IR	◆	8941364481	JS629		8944604171	JS639
AAK4506	CA649IR	◆	AAK5517	CA1049IR	◆	8941364482	JS629		8944692460	JS534
AAK4509	CA341IR	◆	AAK5521	CA1036IR	◆	8941365070	JS679		8944694961	JS629
AAK4513	CA341IR	◆	AAK5535	CA1053IR	◆	8941369970	JA543IR		8944694963	JS629
AAK4515	CA574IR	◆	AAK5542	CA1504IR	◆	8941373452	JA697IR	▲	8944719961	JA673IR

O.E. NO.	HC-PARTS	O.E. NO.	HC-PARTS	O.E. NO.	HC-PARTS	O.E. NO.	HC-PARTS
<b>ISUZU Continued</b>							
8944719963	JA673IR	8973638322	JA1900IR	500317453	CA1557IR	AT23401	CS395
8944719964	JA673IR	8973638323	JA1900IR	500325137	CS1248	AT330320	CA1853IR
8944723300	JA1171IR	8973638330	JA1900IR ▲	500325146	CS682	AZ23575	CA734IR
8944740192	JA545IR	8973695070	JA1899IR	500331736	CA2040IR	AZ28516	CA522IR
8944839180	JS651	8973695071	JA1899IR	500332014	CA1237IR	AZ31316	CA915IR
8947183310	JS534	8973695072	JA1899IR	500333269	CS572	RE13722	JS931
8970298630	JS1010	8973695080	JA1899IR ▲	500333271	CS240	RE185213	CA1984IR
8970377241	JA761IR	8973695081	JA1899IR ▲	500335719	CA1679IR	RE41875	JS931
8970417900	JA863IR	8973860620	JS1158	500338953	CS572	RE43266	JS1222
8970423250	JA871IR	8980147430	JS1158	500345767	CA2037IR	RE44140	JA864IR
8970430640	JA871IR	8980147431	JS1158	500345767	CA2037IR	RE46608	JA1616IR
8970447790	JA673IR	8980311541	CA2010IR	500362607	CA1835IR	RE503226	CS1376
8970626410	JA1290IR	8980311551	CA2017IR	500371244	CA1643IR	RE54416	JS1222
8970716110	JA873IR	8980428720	CA2010IR	504009977	CA1700IR	RE69704	JS1228
8970730460	JA871IR	8980542550	JA1521IR	504009978	CA1837IR		
8970739241	JA761IR	8980564390	JA1900IR	504010576	CA1684IR ▲	KHD	
8970746110	JA873IR	8980564410	JA1899IR	504021528	CA1667IR	1162510	CS707
8970887070	JA652IR	8980564430	JA1901IR	504025884	CS1383	01174645	CS384
8971125490	JS639	8980568670	JA1521IR	504028095	CA1633IR	1177063	CA1433IR
8971128650	JS552	9822007630	JA100	504033459	CA1781IR	1178511	CA1035IR
8971128651	JS552	9822007700	JA101	504042667	CS1432	1178607	CA1433IR
8971128652	JS552	9822007760	JA103	504057813	CA1913IR	1179319	CS887
8971131180	JA863IR	89804287200	CA2010IR	504060771	CA1198IR	1180040	CA1667IR
8971131181	JA863IR	1-81100141-1	JS746	504065776	CA2040IR	1180180	CS1185
8971137700	JA761IR			504071135	CA1854IR ▲	1180804	CS530
8971177690	JS753	IVECO		504086888	CS1203	1180805	CS887
8971177700	JS651	1177063	CA1433IR	504087183	CA1915IR	1180928	CS1130
8971185420	JS776	1178607	CA1433IR	504109413	CA1633IR ▲	1181976	CS1130
8971333690	JS941	2994100	CS1203	504114396	CA1633IR	1182027	CA1831IR
8971333691	JS941	2995104	CS1248	504114397	CA1633IR	01182153	CA702IR
8971333692	JS941	2995138	CS1383	504201467	CS1203	01182691	CA1831IR
8971338540	JA1290IR	2995980	CA1633IR	504225815	CA1854IR ▲	01182759	CS1496
8971347620	JA873IR	2995986	CS1268	504280010	CA2090IR *	01182961	CA1433IR
8971348660	JA1290IR	2995988	CS1292	504280012	CA2089IR *	01183235	CS1130
8971353432	JS552	4719664	CS230	504286394	CA2040IR	01183455	CA1433IR
8971366880	JS639	4744841	CS231	504349338	CA1633IR	98417208	CA212IR
8971370090	JA761IR	4782801	CS121	1300198080	CS973	01180928KZ	CS1130
8971463383	JS999	4807375	CS240	1305709080	CA1258IR	01180995KZ	CS1185
8971478510	JA873IR	4839041	CS1163	1315060080	CA1258IR	01182233KZ	CS1130
8971502000	JA1172IR	4854185	CS1261	1320921080	CS1177	1180928KZ	CS1130
8971502001	JA1172IR	4892318	CA1699IR	1332419080	CS1177	1182233KZ	CS1130
8971502010	JA1370IR	4892320	CA1812IR	9612259680	CA637IR		
8971502030	JS941	4892338	CS1268	9617842980	CA1043IR		
8971502040	JS1091	7552459	CA127IR			KIA	
8971502041	JS1091	7702247	CA834IR ▲	JCB		0B6S818400	JS1000
8971502042	JS1091	7713140	CA851IR	714-26100	CA1494IR	0K01118300	JA1537IR
8971777690	JS753	7719428	CA822IR	714-32300	CA1085IR	0K01118300B	JA1537IR
8971839130	JS776	7733966	CS285	714-35600	CS1471	0K01118300C	JA1537IR
8971876540	JA761IR	8029647	CS1198	714-40005	CS994	0K01118300D	JA1537IR
8971876550	JA873IR	42498145	CS394			0K01218300	JA1537IR
8971876570	JA761IR	42498148	CS502	JOHN DEERE		0K05418300	JA1795IR
8971891122	JA1526IR	42498678	CS1118	AL110504	CS395	0K05418300A	JA1795IR ▲
8971891123	JA1526IR	51787164	CA2090IR	AL111675	CA1062IR ▲	0K05418300A	JA1795IR ▲
8971891124	JA1526IR	51787165	CA2089IR	AL111676	CA1493IR	0K05418300B	JA1795IR ▲
8971891125	JA1526IR	69502571	CS1203	AL114092	CA1062IR ▲	0K05418300B	JA1795IR ▲
8971891126	JA1526IR	93828721	CS1118	AL114093	CA1493IR	0K05418300B	JA1795IR
8971891133	JA1521IR	98417133	CA1448IR	AL119537	CA1831IR	0K05418300C	JA1795IR
8971891134	JA1521IR	98417134	CA1448IR	AL28516	CA522IR	0K05418300C	JA1795IR
8971891135	JA1521IR	98417208	CA212IR	AL35998	CA522IR	0K19T18300A	JA1786IR
8971891136	JA1521IR	98417209	CA212IR	AL3846201	CA1433IR	0K20118300B	JA877IR
8971891137	JA1521IR	98419035	CA1336IR	AL41247	CS706	0K24018300	JA694IR
8971891138	JA1521IR	98424452	CA1438IR	AL60033	CA847IR	0K24018400	JS640
8971891139	JA1521IR	98424453	CA1438IR	AL62690	CS706	0K24118300	JA877IR
8971891180	JS1158	98424739	CA1438IR	AL67175	CA1027IR	0K24118400	JS640
8971891181	JS1158	98424748	CA1438IR	AL67176	CA1027IR	0K24118400A	JS640
8972105050	JS999	98449163	CA1438IR	AL78689	CA1068IR	0K29T18300	JA1786IR
8972236530	JS999	99432760	CS1383	AL78692	CA1027IR	0K2A218300	JA877IR
8972410210	JA1172IR	99451752	CA1556IR	AL81154	CS1205	0K30A18400	CS1099
8972553901	JS999	99451753	CS1118	AL81437	CA847IR	0K30C18300	JA1785IR
8972873923	JA1521IR	99454112	CA1336IR	AL81438	CA1068IR	0K30D18300	JA1785IR
8972873924	JA1521IR	99457074	CA1849IR	AM34248	US848	0K32618400	JS1098
8973234370	JS999	99473468	CA1556IR	AM37869	US848	0K55218300B	JA1539IR
8973261800	JA1521IR	99475009	CA1556IR ▲	AM878176	JS1356	0K55218400	JS1298
8973261801	JA1521IR	99477271	CA2040IR	AM878813	JS1356	0K55218400A	JS1298
8973551980	JA1901IR	99486046	CS1292	AN193461	JA785IR	0K55318300B	JA1539IR
8973551981	JA1901IR	131955508	CS1109	AR62401	CA734IR	0K55418300	JA1539IR ▲
8973551982	JA1901IR	500307724	CS1203	AR70436	CS395	0K55518300	JA1539IR ▲
8973638320	JA1900IR	500314723	CA1556IR	AR77254	JS931	0K71118400	JS365
8973638321	JA1900IR	500315943	CA1633IR				

O.E. NO.	HC-PARTS	O.E. NO.	HC-PARTS	O.E. NO.	HC-PARTS	O.E. NO.	HC-PARTS
OK71118400A.....	<b>JS365</b>	36100-42350.....	<b>JS1351</b>	37300-38710.....	<b>JA1718IR</b>	KB30818400.....	<b>JS1098</b>
OK71F18400B.....	<b>JS365</b>	36100-47600.....	<b>JS770</b>	37300-41010.....	<b>JA972IR</b>	KK13718300.....	<b>JA1276IR</b>
OK74018300G.....	<b>JA1795IR ▲</b>	36100-47650.....	<b>JS892</b>	37300-42010.....	<b>JA972IR</b>	KK13718300B.....	<b>JA1276IR</b>
OK74018300G.....	<b>JA1795IR ▲</b>	36100-4A000.....	<b>JS1355</b>	37300-42017.....	<b>JA1366IR ◆</b>	KK33318300.....	<b>JA173IR</b>
OK74018300H.....	<b>JA1795IR ▲</b>	36100-4A010.....	<b>JS1355</b>	37300-42114.....	<b>JA1366IR</b>	KK33918300.....	<b>JA1276IR</b>
OK90018400.....	<b>JS1000</b>	36100-4A010.....	<b>JS1355</b>	37300-42200.....	<b>JA585IR</b>	KK37018300.....	<b>JA694IR</b>
OK90018400.....	<b>JS640</b>	36100-4X210.....	<b>CS1446</b>	37300-42202.....	<b>JA585IR</b>	KK37018400A.....	<b>JS633</b>
OK90018400B.....	<b>JS640</b>	36100-4X211.....	<b>CS1446</b>	37300-42203.....	<b>JA1366IR</b>	KK40118400.....	<b>JS633</b>
OK95618400.....	<b>JS637</b>	37030-32130.....	<b>JA875IR</b>	37300-42204.....	<b>JA1366IR</b>	KKY0218400.....	<b>JS633</b>
OK9A118300.....	<b>JA1786IR</b>	37300-02503.....	<b>JA1715IR</b>	37300-42206.....	<b>JA1366IR</b>	KY0218400.....	<b>JS663</b>
OK9A218300.....	<b>JA1786IR ▲</b>	37300-02550.....	<b>JA1798IR</b>	37300-42203.....	<b>JA1366IR ◆</b>	MB30118400C.....	<b>JS633</b>
OK9B018300.....	<b>JA1784IR</b>	37300-02551.....	<b>JA1798IR ▲</b>	37300-42354.....	<b>JA1518IR</b>	MB35918400A.....	<b>JS1000</b>
OK9B118300.....	<b>JA1784IR</b>	37300-21013.....	<b>JA666IR</b>	37300-42355.....	<b>JA1518IR</b>	OB6S818400.....	<b>JS1000</b>
OK9B218300.....	<b>JA1784IR ▲</b>	37300-21030.....	<b>JA146IR</b>	37300-42356.....	<b>JA1518IR</b>	OK01118300.....	<b>JA1537IR</b>
OK9B318300.....	<b>JA1784IR ▲</b>	37300-21320.....	<b>JA146IR</b>	37300-42357.....	<b>JA1518IR</b>	OK01118300B.....	<b>JA1537IR</b>
OR20118300K.....	<b>JA180IR</b>	37300-21350.....	<b>JA146IR</b>	37300-42358.....	<b>JA1518IR</b>	OK01118300C.....	<b>JA1537IR</b>
OR20118400.....	<b>JS365</b>	37300-22011.....	<b>JA879IR</b>	37300-42359.....	<b>JA1518IR</b>	OK01118300D.....	<b>JA1537IR</b>
OR20118400B.....	<b>JS365</b>	37300-22020.....	<b>JA879IR</b>	37300-42360.....	<b>JA1518IR</b>	OK01218300.....	<b>JA1537IR</b>
36100-02511.....	<b>JS1303</b>	37300-22020.....	<b>JA879IR</b>	37300-42452.....	<b>JA1711IR</b>	OK05418300.....	<b>JA1795IR</b>
36100-02550.....	<b>JS1303</b>	37300-22023.....	<b>JA879IR</b>	37300-42452.....	<b>JA1711IR</b>	OK05418300.....	<b>JA1795IR ▲</b>
36100-02555.....	<b>JS1303</b>	37300-22200.....	<b>JA994IR</b>	37300-42454.....	<b>JA1711IR</b>	OK05418300A.....	<b>JA1795IR ▲</b>
36100-02560.....	<b>JS1303</b>	37300-22200.....	<b>JA994IR</b>	37300-42454.....	<b>JA1711IR</b>	OK05418300B.....	<b>JA1795IR ▲</b>
36100-11110.....	<b>JS396</b>	37300-22600.....	<b>JA1788IR</b>	37300-42455.....	<b>JA1711IR</b>	OK05418300B.....	<b>JA1795IR ▲</b>
36100-11120.....	<b>JS396</b>	37300-22650.....	<b>JA1789IR</b>	37300-42456.....	<b>JA1711IR</b>	OK05418300C.....	<b>JA1795IR ▲</b>
36100-11130.....	<b>JS396</b>	37300-22650.....	<b>JA1789IR</b>	37300-42457.....	<b>JA1711IR</b>	OK05418300C.....	<b>JA1795IR</b>
36100-11140.....	<b>JS396</b>	37300-23600.....	<b>JA1789IR</b>	37300-42458.....	<b>JA1711IR</b>	OK05418300C.....	<b>JA1795IR</b>
36100-11150.....	<b>JS396</b>	37300-23650.....	<b>CA1927IR</b>	37300-42459.....	<b>JA1711IR</b>	OK20118300.....	<b>JA877IR</b>
36100-21740.....	<b>JS349</b>	37300-24010.....	<b>JA688IR</b>	37300-42470.....	<b>JA1711IR</b>	OK20118300B.....	<b>JA877IR</b>
36100-21770.....	<b>JS643</b>	37300-24510.....	<b>JA689IR</b>	37300-42471.....	<b>JA1711IR</b>	OK24018300.....	<b>JA694IR</b>
36100-22000.....	<b>JS349</b>	37300-24511.....	<b>JA689IR</b>	37300-42472.....	<b>JA1711IR ▲</b>	OK24018400.....	<b>JS640</b>
36100-22800.....	<b>JS1311</b>	37300-27010.....	<b>JA1708IR</b>	37300-42473.....	<b>JA1711IR ▲</b>	OK24118300.....	<b>JA877IR</b>
36100-22805.....	<b>JS1311</b>	37300-27011.....	<b>JA1708IR</b>	37300-42502.....	<b>JA1618IR ▲</b>	OK24118400.....	<b>JS640</b>
36100-22805.....	<b>JS1311</b>	37300-27012.....	<b>JA1708IR</b>	37300-42502.....	<b>JA1618IR ▲</b>	OK24118400A.....	<b>JS640</b>
36100-22850.....	<b>JS1312</b>	37300-27013.....	<b>JA1708IR</b>	37300-42542.....	<b>JA1716IR</b>	OK29T18300.....	<b>JA1786IR</b>
36100-22855.....	<b>JS1312</b>	37300-27020.....	<b>CA2018IR</b>	37300-42542.....	<b>JA1716IR</b>	OK29T18300A.....	<b>JA1786IR</b>
36100-23000.....	<b>JS922</b>	37300-27021.....	<b>CA2018IR</b>	37300-42620.....	<b>JA1618IR ▲</b>	OK2A218300.....	<b>JA877IR</b>
36100-23050.....	<b>JS922</b>	37300-27030.....	<b>JA1708IR</b>	37300-42620.....	<b>JA1618IR ▲</b>	OK30A18400.....	<b>JS1098</b>
36100-23060.....	<b>JS922</b>	37300-27031.....	<b>JA1708IR</b>	37300-42621.....	<b>JA1618IR</b>	OK30C18300.....	<b>JA1785IR</b>
36100-23065.....	<b>JS922</b>	37300-27502.....	<b>JA1808IR</b>	37300-42621.....	<b>JA1618IR</b>	OK30D18300.....	<b>JA1785IR</b>
36100-23070.....	<b>JS1370</b>	37300-27503.....	<b>JA1808IR</b>	37300-42622.....	<b>JA1618IR</b>	OK32618400.....	<b>JS1098</b>
36100-23100.....	<b>JS923</b>	37300-27600.....	<b>JA1808IR</b>	37300-42622.....	<b>JA1618IR</b>	OK55218300B.....	<b>JA1539IR</b>
36100-23150.....	<b>JS923</b>	37300-27601.....	<b>JA1808IR</b>	37300-42750.....	<b>JA983IR</b>	OK55218400.....	<b>JS1298</b>
36100-23160.....	<b>JS923</b>	37300-27602.....	<b>JA1808IR</b>	37300-42804.....	<b>JA1366IR</b>	OK55218400A.....	<b>JS1298</b>
36100-23161.....	<b>JS923</b>	37300-29000.....	<b>CA1065IR</b>	37300-42860.....	<b>JA1717IR</b>	OK55318300A.....	<b>JA1539IR</b>
36100-23165.....	<b>JS923</b>	37300-29000.....	<b>CA1065IR</b>	37300-42870.....	<b>JA1717IR</b>	OK55318300B.....	<b>JA1539IR</b>
36100-23170.....	<b>CS1433</b>	37300-2A010.....	<b>CA1938IR</b>	37300-42871.....	<b>JA1717IR</b>	OK55418300.....	<b>JA1539IR ▲</b>
36100-23171.....	<b>CS1433</b>	37300-2A100.....	<b>CA1906IR</b>	37300-428Q0.....	<b>JA1366IR</b>	OK55518300.....	<b>JA1539IR ▲</b>
36100-26800.....	<b>JS1311</b>	37300-2A110.....	<b>CA1906IR</b>	37300-42Q10.....	<b>JA1366IR</b>	OK71118400.....	<b>JS365</b>
36100-27000.....	<b>JS1234</b>	37300-2A500.....	<b>CA1906IR</b>	37300-43800.....	<b>JA888IR ▲</b>	OK71118400A.....	<b>JS365</b>
36100-27010.....	<b>JS1234</b>	37300-2B101.....	<b>CA2020IR</b>	37300-43850.....	<b>JA870IR ▲</b>	OK71118400C.....	<b>JS365</b>
36100-27011.....	<b>JS1234</b>	37300-2B200.....	<b>CA2020IR</b>	37300-43860.....	<b>JA870IR ▲</b>	OK71F18400B.....	<b>JS365</b>
36100-27510.....	<b>JS1349</b>	37300-32131.....	<b>JA888IR</b>	37300-47400.....	<b>JA1618IR</b>	OK74018300G.....	<b>JA1795IR ▲</b>
36100-27700.....	<b>CS1441</b>	37300-32510.....	<b>JA690IR</b>	37300-47400.....	<b>JA1618IR</b>	OK74018300G.....	<b>JA1795IR ▲</b>
36100-29000.....	<b>CS1177</b>	37300-32511.....	<b>JA690IR</b>	37300-47450.....	<b>JA1618IR</b>	OK74018300H.....	<b>JA1795IR ▲</b>
36100-2A000.....	<b>JS1365</b>	37300-32520.....	<b>JA690IR</b>	37300-47451.....	<b>JA1618IR</b>	OK90018400.....	<b>JS1000</b>
36100-2A100.....	<b>JS1365</b>	37300-32530.....	<b>JA690IR</b>	37300-47451.....	<b>JA1618IR</b>	OK90018400.....	<b>JS640</b>
36100-2B020.....	<b>CS1462</b>	37300-32800.....	<b>JA684IR</b>	37300-47451.....	<b>JA1618IR</b>	OK90018400B.....	<b>JS640</b>
36100-2B100.....	<b>CS1465</b>	37300-33010.....	<b>JA671IR</b>	37300-47500.....	<b>JA1716IR</b>	OK90018400C.....	<b>JS640</b>
36100-2B200.....	<b>CS1465</b>	37300-33013.....	<b>JA671IR</b>	37300-47501.....	<b>JA1716IR ▲</b>	OK95618400.....	<b>JS637</b>
36100-2X000.....	<b>JS1098</b>	37300-33030.....	<b>JA671IR</b>	37300-4A001.....	<b>JA1804IR</b>	OK9A118300.....	<b>JA1786IR</b>
36100-2Y100.....	<b>JS640</b>	37300-33100.....	<b>JA684IR</b>	37300-4A002.....	<b>JA1804IR</b>	OK9A218300.....	<b>JA1786IR ▲</b>
36100-32510.....	<b>JS628</b>	37300-33100.....	<b>JA684IR</b>	37300-4A003.....	<b>JA1804IR</b>	OK9B018300.....	<b>JA1784IR</b>
36100-32630.....	<b>JS628</b>	37300-33101.....	<b>JA684IR</b>	37300-4A110.....	<b>JA1804IR</b>	OK9B118300.....	<b>JA1784IR</b>
36100-32630.....	<b>JS628</b>	37300-33101.....	<b>JA684IR</b>	37300-4A110.....	<b>JA1804IR</b>	OK9B218300.....	<b>JA1784IR ▲</b>
36100-32640.....	<b>JS1004</b>	37300-33103.....	<b>JA684IR</b>	37300-4A111.....	<b>JA1804IR</b>	OK9B318300.....	<b>JA1784IR ▲</b>
36100-33000.....	<b>JS922</b>	37300-33103.....	<b>JA684IR</b>	37300-4A112.....	<b>JA1804IR</b>	OK9B018300.....	<b>JA1784IR</b>
36100-35010.....	<b>JS358</b>	37300-33103.....	<b>JA684IR</b>	37300-4X000.....	<b>JA1709IR</b>	OR20118300K.....	<b>JA180IR</b>
36100-35050.....	<b>JS658</b>	37300-35010.....	<b>JA683IR</b>	37300-4X001.....	<b>JA1709IR</b>		
36100-35510.....	<b>JS781</b>	37300-35020.....	<b>JA683IR</b>	37300-4X002.....	<b>JA1709IR</b>	KOMATSU	
36100-35900.....	<b>JS658</b>	37300-35560.....	<b>JA995IR</b>	37300-4X003.....	<b>JA1709IR</b>	155-216-3011.....	<b>JS734</b>
36100-37210.....	<b>CS1492</b>	37300-35570.....	<b>JA995IR ▲</b>	37300-4X200.....	<b>JA1539IR</b>	600-813-1721.....	<b>JS745</b>
36100-38050.....	<b>JS1313</b>	37300-35571.....	<b>JA995IR</b>	37300-4X220.....	<b>JA1539IR ▲</b>	600-813-3142.....	<b>JS741</b>
36100-38090.....	<b>JS1304</b>	37300-35573.....	<b>JA995IR</b>	37300-4X500.....	<b>JA1709IR</b>	600-813-3143.....	<b>JS741</b>
36100-38090.....	<b>JS1304</b>	37300-36030.....	<b>JA870IR</b>	37300-4X501.....	<b>JA1709IR</b>	600-813-3390.....	<b>JS934</b>
36100-42010.....	<b>JS344</b>	37300-37250.....	<b>CA2088IR *</b>	37300-4X502.....	<b>JA1709IR</b>	600-813-3660.....	<b>JS740</b>
36100-42011.....	<b>JS344</b>	37300-37800.....	<b>JA1903IR</b>	37300-4X503.....	<b>JA1709IR</b>	600-821-6190.....	<b>JA790IR</b>
36100-42050.....	<b>JS769</b>	37300-38310.....	<b>JA1522IR</b>	K20118300A.....	<b>JA877IR</b>	600-821-8160.....	<b>JA788</b>
36100-42050.....	<b>JS769</b>	37300-38400.....	<b>JA1807IR</b>	K62018300.....	<b>JA875IR ▲</b>		
36100-42250.....	<b>JS1351</b>	37300-38700.....	<b>JA1718IR</b>	KB30318400.....	<b>JS1098</b>		

O.E. NO.	HC-PARTS	O.E. NO.	HC-PARTS	O.E. NO.	HC-PARTS	O.E. NO.	HC-PARTS
KUBOTA		2108-3701010.....	CA295IR	23598.....	CA17H	23721.....	CA18H
15231-63015.....	JS673	2108-3708010.....	CS332	23600.....	CA17V	23724.....	CA15H
15231-63016.....	JS673	2108-3708010-6.....	CS332	23602.....	CA17H	23725.....	CA17V
15401-63012.....	JS734	2110-3701010.....	CA1347IR	23603.....	CA17H	23726.....	CA17H
15425-63012.....	JS780	2110-3708010.....	CS1182	23605.....	CA17H	23728.....	CA15H
15461-63010.....	JS734	21120-3701010-09.....	CA1347IR	23606.....	CA17H	23729.....	CA17V
15461-63011.....	JS734	2112-3701010.....	CA1347IR	23609.....	CA17V	23730.....	CA17H
15461-63011.....	JS734	2112-3701010-08.....	CA1347IR	23610.....	CA17H	23731.....	CA17H
15461-63012.....	JS734	21213-3708010.....	CS139	23611.....	CA17V	23734.....	CA17H
15461-63013.....	JS734	21214-3701010.....	CA1472IR ▲	23612.....	CA17H	23735.....	CA17H
15461-63014.....	JS734	21214-3701010.....	CA1472IR ▲	23614.....	CA15H	23736.....	CA17V
15461-63015.....	JS734	2121-43701010.....	CA1472IR	23619.....	CA17V	23737.....	CA18H
15504-63010.....	JS730	221-3701000.....	CA131	23620.....	CA15H	23738.....	CA18V
15504-63011.....	JS730	221-3708000.....	CS139	23623.....	CA15H	23739.....	CA290IR
15504-63012.....	JS730	222-3701005.....	CA131IR	23624.....	CA17V	23740.....	CA290IR
15511-63011.....	JS734	222-3701010.....	CA131IR	23625.....	CA17H	23741.....	CA15H
15521-63010.....	JS734	224-370701.....	CA295IR	23626.....	CA17V	23742.....	CA17H
15521-63012.....	JS734	224-373701.....	CA295IR	23627.....	CA17H	23743.....	CA17H
15601-63012.....	JS897	3101-3708000.....	CS139	23629.....	CA17V	23745.....	CA17H
15621-63014.....	JS897	CT221128.....	CS139	23630.....	CA15H	23747.....	CA17H
15641-63013.....	JS734	CT22112B.....	CS139	23632.....	CA17V	23748.....	CA17H
15852-63012.....	JS394	CT2213708000.....	CS139	23634.....	CA15H	23750.....	CA17H
16231-64011.....	JA551IR	F22112B42A.....	CA131	23635.....	CA17H	23751.....	CA18H
16241-64011.....	JA551IR	KAT22112642.....	CA131	23636.....	CA15H	23753.....	CA17H
16241-64012.....	JA551IR	KAT3K29.3708.....	CS332	23637.....	CA15H	23754.....	CA17V
16285-63011.....	JS730	KAT3K35.3708.....	CS139	23640.....	CA17H	23755.....	CA17H
16540-64011.....	JA657IR ▲	KAT3KCT221126.....	CS139	23642.....	CA17H	23756.....	CA18H
16611-63012.....	JS908	KAT3KT2214B.....	CA131IR	23643.....	CA17H	23758.....	CA18V
16611-63013.....	JS908	L211A14B.....	CA131	23644.....	CA17V	23759.....	CA18H
16612-63011.....	JS730	T2223701010.....	CA295IR	23645.....	CA17V	23760.....	CA18V
16612-63012.....	JS730			23646.....	CA17V	23761.....	CA17H
16661-63013.....	JS678	LANDROVER ➔ ROVER GROUP		23647.....	CA17H	23762.....	CA17H
16695-63012.....	JS730			23648.....	CA17H	23765.....	CA18H
17298-63013.....	JS734	LUCAS		23649.....	CA17H	23766.....	CA18H
17341-63011.....	JS734	22258.....	CG50	23650.....	CA17H	23767.....	CA18H
17341-63013.....	JS734	22700.....	CG50	23651.....	CA17H	23768.....	CA18V
17356-64012.....	JA160IR ▲	22703.....	CG52	23652.....	CA17V	23769.....	CA17H
17369-64011.....	JA160IR	22704.....	CG50	23653.....	CA17V	23771.....	CA18H
17381-63012.....	JS734	22705.....	CG50	23654.....	CA17V	23773.....	CA17V
17381-63014.....	JS897	22715.....	CG50	23655.....	CA17V	23774.....	CA17H
17381-63015.....	JS897	22717.....	CG50	23656.....	CA17V	23775.....	CA17V
17594-63012.....	JS730	22719.....	CG52	23658.....	CA17H	23777.....	CA17H
19013-63011.....	JS896	22733.....	CG52	23659.....	CA17V	23778.....	CA17H
19202-63011.....	JS896	22742.....	CG50	23660.....	CA17H	23779.....	CA18H
19269-63011.....	JS908	22747.....	CG50	23661.....	CA15H	23782.....	CA17H
19269-63013.....	JS908	22748.....	CG50	23662.....	CA17H	23783.....	CA22H
19400-63011.....	JS730	22756.....	CG58	23664.....	CA17H	23793.....	CA17V
19420-63012.....	JS730	22758.....	CG58	23665.....	CA17V	23794.....	CA17V
19821-63011.....	JS896	22761.....	CG58	23668.....	CA15H	23795.....	CA17H
37560-63011.....	JS730	22762.....	CG58	23673.....	CA18V	23796.....	CA17H
37560-63012.....	JS730	22764.....	CG58	23674.....	CA17H	23797.....	CA17H
3A011-74012.....	JA551IR	22765.....	CG50	23676.....	CA15H	23799.....	CA15H
66436-64011.....	JA551IR	22767.....	CG50	23678.....	CA17H	23800.....	CA17V
67980-31151.....	JS730	22775.....	CG50	23679.....	CA17H	23801.....	CA17V
		22780.....	CG52	23685.....	CA17H	23802.....	CA17H
		22785.....	CG50	23691.....	CA18H	23804.....	CA17H
		22788.....	CG52	23692.....	CA18V	23805.....	CA17H
LADA		22789.....	CG50	23693.....	CA18H	23806.....	CA18H
293708.....	CS332	22791.....	CG52	23695.....	CA17H	23807.....	CA290IR
37.3701.....	CA295IR	23544.....	CA15H	23697.....	CA290IR	23808.....	CA18H
3708000.....	CS139	23548.....	CA17H	23699.....	CA15H	23809.....	CA18V
4233708.....	CS139	23562.....	CA15H	23700.....	CA17H	23810.....	CA18V
4243708.....	CS332	23565.....	CA17H	23701.....	CA17V	23811.....	CA18H
4253708.....	CS139	23566.....	CA17H	23702.....	CA18V	23814.....	CA290IR
4263708.....	CS332	23568.....	CA17V	23703.....	CA17H	23816.....	CA17H
4302.3771.....	CA1347IR	23569.....	CA17H	23704.....	CA17V	23818.....	CA17V
5102.3771.....	CA1347IR	23570.....	CA17H	23706.....	CA15H	23819.....	CA17V
5702.3708.....	CS1182	23573.....	CA17H	23707.....	CA17V	23820.....	CA17V
5712.3708.....	CS332	23575.....	CA15H	23708.....	CA17H	23822.....	CA17H
5722.3708.....	CS139	23581.....	CA15H	23709.....	CA18H	23822.....	CA17V
9412.3701.....	CA1472IR ▲	23583.....	CA17V	23711.....	CA17H	23823.....	CA17H
9412.3701.....	CA1472IR ▲	23584.....	CA17H	23712.....	CA17V	23824.....	CA17V
2100-3708000.....	CS139	23585.....	CA17V	23713.....	CA17H	23825.....	CA17H
2101-3701000.....	CA131	23590.....	CA15H	23714.....	CA15H	23827.....	CA15H
2101-3701005.....	CA131	23591.....	CA17V	23715.....	CA17H	23828.....	CA18V
2101-3701010.....	CA131	23592.....	CA17V	23716.....	CA17H	23830.....	CA290IR
2101-3708000.....	CS139	23593.....	CA17H	23717.....	CA17H	23831.....	CA15H
2101-3710000.....	CA131	23595.....	CA17H	23718.....	CA17H	23835.....	CA23V
2103-12VIP54.....	CS332	23597.....	CA15H	23719.....	CA18H	23837.....	CA17H
2105-3701010.....	CA131IR						



O.E. NO.	HC-PARTS	O.E. NO.	HC-PARTS	O.E. NO.	HC-PARTS	O.E. NO.	HC-PARTS
23839	CA18H	24098	CA96IR	24291	CA1346IR	25350	CS116
23840	CA17H	24102	CA626IR	24293	CA1031IR	25351	CS116
23844	CA17H	24108	CA15H	24293	CA719IR	25355	CS364
23845	CA17H	24112	CA126IR	24294	CA564IR	25356	CS181
23847	CA17H	24114	CA60IR	24296	CA600IR	25357	CS78
23848	CA18H	24118	CA94IR	24297	CA627IR	25368	CS181
23851	CA17H	24119	CA306IR	24298	CA305IR	25375	CS720
23852	CA17V	24123	CA613IR	24299	CA1050IR	25383	CS123
23855	CA17H	24124	CA704IR	24316	CA1030IR	25387	CS720
23856	CA17V	24128	CA96IR	24316	CA718IR	25397	CS278
23857	CA18V	24133	CA17V	24318	CA629IR	25400	CS708
23860	CA18V	24134	CA18H	24322	CA1494IR	25411	CS720
23862	CA22H	24136	CA226IR	24329	CA1100IR ▲	25648	CS78
23865	CA613IR	24139	CA127IR	24330	CA1252IR ▲	25681	CS587
23872	CA18V	24142	CA626IR	24344	CA1651IR ▲	25684	CS591
23878	CA17H	24144	CA17V	24374	CA1031IR	25696	CS587
23880	CA613IR	24145	CA306IR ▲	24374	CA719IR	25728	CS324
23882	CA22H	24149	CA94IR	24380	CA627IR	25735	CS72
23886	CA22H	24150	CA626IR	24387	CA564IR	25742	CS591
23888	CA35IR	24156	CA306IR	24390	CA627IR	25755	CS588
23889	CA17H	24157	CA600IR	24450	CA1494IR	25756	CS588
23895	CA22H	24158	CA564IR	25016	CS19	26009	CS786
23902	CA22H	24161	CA627IR	25022	CS19	26125	CS603
23909	CA15H	24165	CA96IR	25024	CS19	26126	CS603
23912	CA17V	24169	CA306IR	25041	CS19	26145	CS109
23915	CA15H	24171	CA76IR	25061	CS19	26148	CS693
23918	CA17H	24176	CA626IR	25062	CS19	26154	CS109
23920	CA17H	24177	CA306IR	25063	CS19	26156	CS603
23924	CA18H	24179	CA17H	25065	CS19	26163	CS603
23928	CA18V	24181	CA18H	25071	CS19	26165	CS603
23929	CA126IR	24182	CA18V	25075	CS18	26166	CS109
23932	CA22H	24185	CA18V	25079	CS19	26167	CS109
23933	CA22H	24186	CA707IR	25083	CS18	26173	CS705
23941	CA94IR	24188	CA1028IR	25085	CS19	26173	CS705
23957	CA22H	24188	CA311IR	25087	CS19	26180	CS591
23962	CA17H	24198	CA629IR	25088	CS19	26186	CS109
23963	CA17V	24199	CA126IR	25089	CS18	26196	CS693
23967	CA628IR	24200	CA306IR	25097	CS19	26200	CS109
23980	CA127IR	24201	CA626IR	25105	CS18	26211	CS200
23983	CA126IR	24203	CA127IR	25112	CS18	26213	CS200
23984	CA18V	24206	CA325IR	25118	CS21	26219	CS107
23985	CA18H	24208	CA600IR	25118	CS21	26220	CS109
23987	CA172IR	24209	CA564IR	25138	CS19	26227	CS200
23988	CA172IR	24211	CA290IR	25147	CS18	26233	CS109
23989	CA15H	24214	CA252IR	25149	CS19	26256	CS997
23993	CA290IR	24215	CA305IR	25150	CS21	26259	CS997
23995	CA22H	24216	CA594IR	25201	CS19	26264	CS109
23996	CA96IR	24217	CA560IR	25204	CS78	26265	CS336
24014	CA290IR	24220	CA325IR	25206	CS181	26267	CS587
24022	CA613IR	24221	CA560IR	25208	CS78	26271	CS107
24023	CA17V	24223	CA650IR	25238	CS18	26273	CS1032
24024	CA18H	24228	CA627IR	25239	CS19	26274	CS201
24026	CA17H	24230	CA1029IR	25242	CS21	26278	CS705
24028	CA18V	24230	CA611IR	25249	CS78	26281	CS946
24031	CA22H	24231	CA650IR	25250	CS181	26283	CS693
24033	CA704IR	24233	CA325IR	25255	CS181	26284	CS604
24037	CA126IR	24235	CA564IR ▲	25257	CS62	26286	CS949
24041	CA307IR	24236	CA707IR ▲	25270	CS78	26291	CS200
24048	CA17V	24240	CA582IR	25271	CS78	26294	CS703
24049	CA312IR	24241	CA627IR	25272	CS78	26295	CS948
24051	CA15H	24242	CA564IR	25276	CS181	26311	CS336
24052	CA17H	24246	CA725IR	25277	CS181	26312	CS345
24054	CA22H	24248	CA707IR ▲	25281	CS181	26316	CS200
24058	CA15H	24249	CA305IR	25282	CS69	26321	CS997
24061	CA17H	24250	CA707IR	25286	CS62	26323	CS201
24062	CA259IR	24256	CA725IR	25288	CS181	26329	CS200
24065	CA18H	24257	CA562IR	25289	CS78	26330	CS200
24066	CA18V	24260	CA561IR	25290	CS324	26336	CS106
24067	CA96IR	24262	CA306IR	25290	CS708	26338	CS200
24072	CA290IR	24264	CA1029IR	25292	CS261	26339	CS200
24079	CA290IR	24264	CA611IR	25326	CS123	26341	CS336
24082	CA17H	24271	CA584IR	25331	CS181	26342	CS604
24087	CA613IR	24273	CA726IR	25332	CS123	26345	CS201
24089	CA96IR	24274	CA1330IR	25335	CS78	26349	CS701
24090	CA22H	24276	CA600IR	25338	CS123	26351	CS200
24091	CA628IR	24277	CA305IR	25339	CS368	26352	CS200
24093	CA628IR	24286	JA756IR	25344	CS123	26355	CS337
24094	CA15H	24289	CA306IR	25345	CS18	26356	CS337
24095	CA17H	24290	CA627IR	25349	CS116	26357	CS703

O.E. NO.	HC-PARTS	O.E. NO.	HC-PARTS	O.E. NO.	HC-PARTS	O.E. NO.	HC-PARTS
<b>LUCAS <i>Continued</i></b>							
26358	CS948	26823	CS786	27510	CS201	54022198	CA560IR
26360	CS336	26824	CS787	27511	CS336	54022200	CA564IR
26365	CS1032	26827	CS625	27512	CS604	54022211	CA305IR
26366	CS201	26829	CS625	27515	CS201	54022212	CA600IR
26369	CS703	26830	CS786	27518	CS703	54022213	CA306IR
26371	CS947	26831	CS786	27522	CS1032	54022218	CA306IR
26373	CS603	26832	CS787	27528	CS987	54022219	CA600IR
26374	CS948	26833	CS787	27533	CS623	54022224	CA650IR
26379	CS987	26834	JS627	27539	CS201	54022225	CA1384IR
26386	CS266	26835	CS1270	27540	CS1032	54022226	CA600IR
26388	CS337	26836	CS786	27541	CS994	54022227	CA306IR
26391	CS109	26837	CS787	27543	CS701	54022228	CA629IR
26395	CS200	26841	JS627	27553	CS345	54022232	CA717IR
26398	CS623	26845	JS627	27554	CS336	54022234	CA306IR
26400	CS947	26847	CS1270	27564	CS889	54022235	CA627IR
26407	CS337	26913	CS341	27565	CS994	54022236	CA325IR
26410	CS201	26921	CS722	27567	CS337	54022238	CA564IR
26411	CS1032	26929	CS722	27568	CS994	54022241	CA126IR
26412	CS109	26935	CS341	27569	CS200	54022242	CA564IR
26413	CS107	26936	CS722	27570	CS703	54022243	CA126IR
26414	CS994	26938	CS722	27571	CS1032	54022244	CA564IR
26416	CS701	26941	CS341	27572	CS201	54022247	CA650IR
26417	CS186	26942	CS341	27575	CS106	54022251	CA560IR
26428	CS106	26943	CS1037	27577	CS337	54022262	CA564IR
26430	CS345	26945	CS1037	27578	CS201	54022265	CA629IR
26431	CS336	26946	CS1037	27580	CS1032	54022266	CA306IR
26587	CS592	27002	CS562	27582	CS1032	54022275	CA560IR
26600	CS592	27004	CS790	27583	CS201	54022280	CA600IR
26601	CS592	27005	CS592	27584	CS1032	54022281	CA560IR
26602	CS528	27006	CS592	27585	CS703	54022286	CA564IR
26604	CS116	27008	CS123	27586	CS106	54022290	CA717IR
26605	CS609	27014	CS592	27587	CS604	54022295	CA600IR
26607	CS579	27016	CS609	27588	CS703	54022301	CA1029IR
26614	CS691	27022	JS672	27590	CS994	54022301	CA611IR
26616	CS609	27026	CS691	27592	CS703	54022305	CA584IR
26618	CS528	27029	CS116	27593	CS1032	54022306	CA564IR
26619	CS691	27034	CS610	27594	CS201	54022307	CA584IR
26622	CS691	27043	JS672	27595	CS889	54022310	CA725IR
26624	CS123	27045	CS579	27596	CS703	54022312	CA560IR
26626	CS708	27047	JS672	27598	CS994	54022313	CA561IR
26628	CS562	27048	CS708	27599	CS994	54022314	CA717IR
26647	CS116	27061	CS691	27601	CS623	54022317	CA560IR
26648	CS785	27400	CS128	27602	CS994	54022318	CA594IR
26649	CS181	27401	CS230	27604	CS106	54022322	CA562IR
26655	CS785	27408	CS109	27606	CS201	54022323	CA1692IR
26656	CS181	27409	CS109	27608	CS994	54022330	CA717IR
26657	CS181	27411	CS946	27614	CS200	54022335	CA305IR
26660	CS610	27413	CS705	27626	CS994	54022336	CA726IR
26667	JS672	27415	CS946	27627	CS994	54022337	CA1330IR
26678	CS592	27417	CS693	26921046	CA18H	54022341	CA305IR
26679	CS592	27419	CS949	54021757	CA127IR	54022349	CA600IR
26680	CS562	27421	CS109	54021917	CA17H	54022351	CA1029IR
26681	CS609	27425	CS590	54021918	CA17H	54022351	CA611IR
26686	CS785	27430	CS795	54021919	CA126IR	54022353	CA305IR
26689	CS724	27431	CS947	54021921	CA96IR	54022373	CA1028IR
26690	CS610	27432	CS109	54021955	CA306IR	54022373	CA311IR
26692	CS579	27440	CS704	54021985	CA17V	54022374	CA1029IR
26693	CS610	27446	CS997	54021988	CA17H	54022374	CA611IR
26694	CS610	27454	CS128	54022011	CA17V	54022375	JA756IR
26695	CS790	27455	CS314	54022053	CA305IR	54022378	CA1046IR
26696	CS579	27460	CS590	54022057	CA600IR	54022382	CA564IR
26699	CS609	27463	CS705	54022128	CA306IR	54022383	CA564IR
26702	CS579	27464	CS946	54022130	CA1028IR	54022384	CA600IR
26715	JS378	27468	CS997	54022130	CA311IR	54022385	CA306IR
26717	CS579	27469	CS109	54022142	CA305IR	54022389	CA306IR
26722	CS579	27470	CS109	54022147	CA126IR	54022390	CA627IR
26801	CS589	27474	CS109	54022148	CA306IR	54022391	CA564IR
26804	CS1056	27476	CS949	54022154	CA127IR	54022392	CA306IR
26805	CS625	27478	CS693	54022158	CA325IR	54022393	CA627IR
26806	CS625	27479	CS946	54022160	CA1227IR	54022394	CA1031IR
26807	CS625	27480	CS109	54022160	CA305IR	54022394	CA719IR
26809	CS786	27486	CS693	54022164	CA600IR	54022395	CA564IR
26810	CS787	27487	CS946	54022167	CA1384IR	54022396	CA1031IR
26812	CS1270	27488	CS109	54022171	CA252IR	54022396	CA719IR
26813	JS627	27500	CS200	54022182	CA305IR	54022398	CA1494IR
26814	JS891	27501	CS337	54022187	CA560IR	54022400	CA584IR
26815	CS786	27502	CS703	54022195	CA1384IR	54022402	CA650IR
26816	CS786	27506	CS703	54022196	CA629IR	54022410	CA306IR
26820	CS625	27508	CS106	54022197	CA325IR	54022414	CA600IR

O.E. NO.	HC-PARTS	O.E. NO.	HC-PARTS	O.E. NO.	HC-PARTS	O.E. NO.	HC-PARTS
54022415	CA1050IR	54022569	CA311IR	54055205	CA584IR	LRA00109	CA290IR
54022419	CA1554IR	54022570	CA560IR	61920107	CA18H	LRA00110	CA110IR
54022419	CA325IR	54022572	CA126IR	61924050	CS103	LRA00112	CA35IR
54022420	CA254IR	54022574	CA1508IR	22703K	CG52	LRA00113	CA17V
54022425	CA1030IR	54022575	CA1031IR	22703M	CG52	LRA00118	CA18V
54022425	CA718IR	54022575	CA719IR	22704H	CG50	LRA00122	CA290IR
54022426	CA600IR	54022578	CA1050IR	22704L	CG50	LRA00123	CA115
54022428	CA564IR	54022579	CA564IR	22704Q	CG50	LRA00129	CA18H
54022429	CA1030IR	54022580	CA1494IR	22705F	CG50	LRA00131	CA22H
54022429	CA718IR	54022581	CA306IR	22705L	CG50	LRA00133	CA71
54022431	CA1384IR	54022582	CA1029IR	22715E	CG50	LRA00136	CA89
54022432	CA1384IR	54022582	CA611IR	22715K	CG50	LRA00137	CA120
54022437	CA1494IR	54022583	CA1031IR	22719H	CG52	LRA00142	JA130
54022439	CA564IR	54022583	CA719IR	22719J	CG52	LRA00147	CA18V
54022443	CA891IR	54022584	CA560IR	22733E	CG52	LRA00152	CA325IR
54022445	CA600IR	54022585	CA717IR	22733J	CG52	LRA00154	CA93
54022449	CA650IR	54022586	CA306IR	22762E	CG58	LRA00154	CA93IR
54022450	CA584IR	54022588	CA1031IR	22765B	CG50	LRA00159	CA114
54022453	CA1100IR	54022588	CA719IR	24157D	CA600IR	LRA00160	CA88
54022454	CA1252IR	54022589	CA650IR	24157F	CA600IR	LRA00162	CA131
54022458	CA600IR	54022590	CA600IR	25281B	CS181	LRA00167	JA131
54022459	CA1191IR	54022591	CA627IR	26025007A	CS994	LRA00175	JA131
54022464	CA1437IR	54022593	CA306IR	26025009B	CS703	LRA00178	JA110
54022468	CA1651IR	54022595	CA561IR	26284E	CS604	LRA00190	CA1435IR
54022474	CA560IR	54022597	CA584IR	26391A	CS109	LRA00193	CA119IR
54022481	CA725IR	54022598	CA305IR	26428A	CS106	LRA00194	CA154
54022483	CA564IR	54022600	CA562IR	26430A	CS345	LRA00199	CA77IR
54022487	CA1380IR	54022602	CA717IR	26430D	CS345	LRA00203	CA71
54022495	CA1031IR	54022603	CA325IR	26925155A	CS200	LRA00205	JA101
54022495	CA719IR	54022604	CA1554IR	26925159A	JS512	LRA00208	CA48IR
54022498	CA1191IR	54022604	CA325IR	26925159B	JS512	LRA00220	CA23V
54022510	CA627IR	54022608	JA756IR	26925159E	JS512	LRA00226	CA126IR
54022512	CA1028IR	54022610	CA1031IR	26925193A	CS201	LRA00226	CA18H
54022512	CA311IR	54022610	CA719IR	26925196A	CS994	LRA00227	JA100
54022513	CA611IR	54022611	CA560IR	26925196B	CS994	LRA00228	CA126IR
54022514	CA717IR	54022613	CA717IR	27469A	CS109	LRA00230	CA61IR
54022515	CA1028IR	54022614	CA560IR	27470A	CS109	LRA00232	CA235IR
54022515	CA311IR	54022615	CA1031IR	27627B	CS994	LRA00233	CA84
54022516	CA1029IR	54022615	CA719IR	LEA0005	CA190IR	LRA00233	CA84IR
54022516	CA611IR	54022616	CA564IR	LEA0098	CA126IR	LRA00234	CA166
54022518	CA650IR	54022617	CA650IR	LEA0222	JA1523IR	LRA00246	CA96IR
54022520	CA717IR	54022619	CA1050IR	LEA0462	CA2034IR	LRA00247	CA94IR
54022521	CA1230IR	54022620	CA126IR	LEA0468	JA1376IR	LRA00249	JA101
54022527	CA1379IR	54022625	CA600IR	LEA0470	JA551IR	LRA00249	JA103
54022528	CA1494IR	54022626	CA561IR	LEA0478	CA1192IR	LRA00251	JA104IR
54022529	CA1494IR	54022638	CA564IR	LEA0493	CA1761IR	LRA00255	CA106
54022530	CA1494IR	54022639	CA1346IR	LEA0527	CA1242IR	LRA00258	JA151IR
54022531	CA564IR	54022642	CA564IR	LEA0538	CA1811IR	LRA00259	JA172
54022532	CA1494IR	54022646	CA627IR	LEA0539	CA1588IR	LRA00261	JA172
54022536	CA1346IR	54022647	CA1346IR	LEA0540	CA1553IR	LRA00263	JA150IR
54022537	CA1031IR	54022651	CA564IR	LEA0545	JA1899IR	LRA00264	JA150IR
54022537	CA719IR	54022652	CA560IR	LEA0548	CA2040IR	LRA00264	JA199IR
54022538	CA1028IR	54022653	JA756IR	LEA0553	JA1789IR	LRA00265	JA121
54022538	CA311IR	54022654	JA756IR	LEA0565	CA300IR	LRA00266	JA157
54022539	CA1029IR	54022656	CA564IR	LEA0569	CA1153IR	LRA00267	CA172IR
54022539	CA611IR	54022662	JA756IR	LEA0573	CA1818IR	LRA00269	CA119IR
54022543	CA1380IR	54022663	CA627IR	LEA0576	CA238IR	LRA00270	CA127IR
54022547	CA1031IR	54022664	JA756IR	LEA0588	CA1103IR	LRA00271	CA46IR
54022547	CA719IR	54022665	CA1508IR	LEA0590	CA212IR	LRA00272	CA42IR
54022549	CA1085IR	54022668	CA305IR	LEA0591	CA1475IR	LRA00273	CA15H
54022553	CA564IR	54022669	CA1230IR	LEA0592	JA1712IR	LRA00274	CA190IR
54022554	CA564IR	54022686	CA600IR	LEA0593	CA355IR	LRA00275	CA126IR
54022555	CA1031IR	54022689	CA1031IR	LEA0610	CA316IR	LRA00277	CA312IR
54022555	CA719IR	54022689	CA719IR	LEA0610	CA642IR	LRA00280	CA81IR
54022556	CA1029IR	54022695	CA305IR	LEA0612	CA642IR	LRA00281	CA84IR
54022556	CA611IR	54022700	CA650IR	LES0009	CS703	LRA00285	CA165IR
54022557	CA1031IR	54022701	CA584IR	LES0021	CS1032	LRA00286	CA169IR
54022557	CA719IR	54022708	CA1031IR	LES0202	US857	LRA00287	CA178IR
54022558	CA1029IR	54022708	CA719IR	LES0232	JS1365	LRA00289	CA332IR
54022558	CA611IR	54022711	CA1050IR	LES0246	CS1329	LRA00290	CA170IR
54022559	CA584IR	54022716	CA560IR	LES0255	CS1338	LRA00292	CA85IR
54022560	CA1494IR	54022740	CA305IR	LES0264	CS1062	LRA00296	CA124IR
54022561	CA1494IR	54022744	CA305IR	LES0281	JS730	LRA00300	CA140IR
54022564	CA1031IR	54022746	CA1494IR	LRA00100	CA17H	LRA00300	CA52IR
54022564	CA719IR	54022747	CA650IR	LRA00101	CA17V	LRA00301	CA140IR
54022565	CA1031IR	54022751	CA1494IR	LRA00102	CA15H	LRA00301	CA52IR
54022565	CA719IR	54022752	CA564IR	LRA00103	CA18H	LRA00304	CA229IR
54022568	CA1379IR	54022754	CA650IR	LRA00105	CA18V	LRA00306	JA170
54022569	CA1028IR	54022803	CA305IR	LRA00106	CA17H	LRA00307	CA119IR

O.E. NO.	HC-PARTS	O.E. NO.	HC-PARTS	O.E. NO.	HC-PARTS	O.E. NO.	HC-PARTS
<b>LUCAS <i>Continued</i></b>							
LRA00311	JA807IR	LRA00489	JA147IR	LRA00595	CA129IR	LRA00734	CA357IR
LRA00313	CA99IR	LRA00489	JA663IR	LRA00596	CA254IR	LRA00736	CA296IR
LRA00316	CA228IR	LRA00490	JA154IR	LRA00597	CA129IR	LRA00737	CA297IR
LRA00322	CA198IR	LRA00491	CA268IR	LRA00597	CA1435IR	LRA00742	CA141IR
LRA00327	CA271IR	LRA00495	CA628IR	LRA00598	CA351IR	LRA00743	CA276IR
LRA00328	CA300IR	LRA00496	CA560IR	LRA00599	CA363IR	LRA00745	CA528IR
LRA00330	JA141IR	LRA00498	CA192IR	LRA00602	CA1384IR	LRA00746	CA591IR
LRA00336	CA199IR	LRA00499	JA148IR	LRA00603	CA252IR	LRA00747	CA272IR
LRA00342	JA137	LRA00501	JA148IR	LRA00604	CA1554IR	LRA00748	CA358IR
LRA00344	JA161IR	LRA00504	JA153	LRA00604	CA325IR	LRA00749	CA591IR
LRA00346	CA128IR	LRA00506	CA264IR	LRA00606	CA322IR	LRA00751	CA1055IR
LRA00348	JA104IR	LRA00506	CA508IR	LRA00607	CA305IR	LRA00752	CA355IR
LRA00348	JA125IR	LRA00507	CA289IR	LRA00607	CA96IR	LRA00753	CA506IR
LRA00349	JA198IR	LRA00510	CA526IR	LRA00609	JA543IR	LRA00755	JA191IR
LRA00351	JA177IR	LRA00511	JA157	LRA00610	JA655IR	LRA00756	JA192IR
LRA00356	CA18H	LRA00513	JA157	LRA00611	CA616IR	LRA00757	JA174IR
LRA00357	CA17V	LRA00514	CA506IR	LRA00612	CA134	LRA00759	JA667IR
LRA00358	CA18V	LRA00515	CA378IR	LRA00613	CA184	LRA00760	JA865IR
LRA00359	CA126IR	LRA00516	CA594IR	LRA00615	CA320IR	LRA00762	CA313IR
LRA00360	CA22H	LRA00517	CA560IR	LRA00616	CA251IR	LRA00764	CA532IR
LRA00361	CA613IR	LRA00518	CA562IR	LRA00617	CA339IR	LRA00765	CA359IR
LRA00364	JA168	LRA00520	CA1692IR	LRA00618	CA186IR	LRA00766	CA557IR
LRA00369	JA107IR	LRA00520	CA562IR	LRA00619	CA140IR	LRA00767	CA370IR
LRA00370	JA151IR	LRA00521	CA584IR	LRA00621	CA522IR	LRA00768	CA315IR
LRA00371	JA175IR	LRA00522	CA1330IR	LRA00622	CA152IR	LRA00769	CA369IR
LRA00374	CA293IR	LRA00523	JA118	LRA00623	CA186IR	LRA00770	CA535IR
LRA00375	CA96IR	LRA00527	JA756IR	LRA00624	CA327IR	LRA00774	CA354IR
LRA00376	CA226IR	LRA00530	CA725IR	LRA00625	CA222IR	LRA00776	JA164IR
LRA00376	CA305IR	LRA00532	CA600IR	LRA00628	CA139IR	LRA00777	CA375IR
LRA00378	CA356IR	LRA00533	CA295IR	LRA00640	CA96IR	LRA00778	CA372IR
LRA00384	CA626IR	LRA00534	JA176	LRA00653	CA629IR	LRA00779	CA255IR
LRA00385	CA75	LRA00536	JA171IR	LRA00679	JA139	LRA00780	CA1028IR
LRA00386	CA132IR	LRA00540	JA119	LRA00680	JA162IR	LRA00780	CA311IR
LRA00386	CA78	LRA00542	JA753IR	LRA00681	JA573IR	LRA00781	CA505IR
LRA00392	CA96IR	LRA00543	JA160IR	LRA00682	JA765IR	LRA00783	CA337IR
LRA00393	CA173IR	LRA00544	JA195	LRA00683	JA183IR	LRA00786	CA514IR
LRA00394	JA163IR	LRA00545	JA751IR	LRA00684	JA127IR	LRA00787	CA198IR
LRA00397	CA549IR	LRA00546	JA752IR	LRA00685	JA116IR	LRA00788	CA376IR
LRA00398	CA225IR	LRA00547	JA173IR	LRA00687	JA140	LRA00789	JA576IR
LRA00399	JA127IR	LRA00548	JA182IR	LRA00688	JA141IR	LRA00790	JA575IR
LRA00401	JA128IR	LRA00549	JA188IR	LRA00689	JA142IR	LRA00796	JA166IR
LRA00402	JA125IR	LRA00550	JA552IR	LRA00690	JA143	LRA00800	CA283
LRA00405	CA127IR	LRA00551	JA196	LRA00691	JA144	LRA00805	CA328IR
LRA00408	JA131	LRA00552	JA799IR	LRA00693	CA582IR	LRA00807	CA163IR
LRA00422	CA207IR	LRA00553	JA152IR	LRA00693	CA627IR	LRA00808	CA224IR
LRA00430	CA273	LRA00556	JA678IR	LRA00695	CA350IR	LRA00812	CA121IR
LRA00433	CA88IR	LRA00557	JA555IR	LRA00696	CA298IR	LRA00814	JA687
LRA00434	CA238IR	LRA00558	CA572IR	LRA00698	CA314IR	LRA00816	CA173IR
LRA00435	CA271IR	LRA00559	CA644IR	LRA00700	JA129IR	LRA00817	CA174IR
LRA00437	CA141IR	LRA00561	CA343IR	LRA00702	JA129IR	LRA00818	CA175IR
LRA00443	CA158IR	LRA00562	CA588IR	LRA00703	JA115IR	LRA00819	CA514IR
LRA00444	CA264IR	LRA00563	CA342IR	LRA00704	JA766IR	LRA00821	CA69IR
LRA00445	CA291IR	LRA00564	JA167IR	LRA00705	JA666IR	LRA00823	CA87IR
LRA00446	CA371IR	LRA00565	CA527IR	LRA00706	JA585IR	LRA00827	CA233IR
LRA00447	CA361IR	LRA00566	CA838IR	LRA00707	JA598IR	LRA00832	CA307IR
LRA00448	CA288IR	LRA00567	CA589IR	LRA00708	JA770IR	LRA00833	CA255IR
LRA00452	JA158IR	LRA00568	JA134	LRA00709	JA670IR	LRA00836	CA516IR
LRA00453	CA363IR	LRA00569	CA519IR	LRA00710	JA179IR	LRA00839	CA212IR
LRA00455	CA524IR	LRA00570	JA138	LRA00711	JA179IR	LRA00844	CA190IR
LRA00456	CA129IR	LRA00571	JA114	LRA00712	CA316IR	LRA00863	CA42IR
LRA00458	CA612IR	LRA00572	JA659IR	LRA00713	CA251IR	LRA00864	CA176IR
LRA00459	CA506IR	LRA00573	JA658IR	LRA00714	CA251IR	LRA00867	CA149IR
LRA00460	CA600IR	LRA00574	JA109IR	LRA00715	CA503IR	LRA00868	CA150IR
LRA00461	CA1346IR	LRA00574	JA197IR	LRA00717	CA345IR	LRA00870	CA308IR
LRA00461	CA564IR	LRA00575	JA653IR	LRA00718	CA263IR	LRA00871	CA517IR
LRA00462	CA306IR	LRA00577	JA138	LRA00719	CA345IR	LRA00879	CA268IR
LRA00463	CA627IR	LRA00580	CA643IR	LRA00720	CA321IR	LRA00880	CA352IR
LRA00465	CA512IR	LRA00581	CA372IR	LRA00721	CA321IR	LRA00885	CA509IR
LRA00469	CA306IR	LRA00582	CA312IR	LRA00722	CA321IR	LRA00886	CA353IR
LRA00471	CA294IR	LRA00583	CA18H	LRA00723	CA335IR	LRA00887	CA320IR
LRA00473	CA373IR	LRA00583	CA18V	LRA00724	CA284IR	LRA00887	CA842IR
LRA00474	CA500IR	LRA00584	CA76IR	LRA00726	CA592IR	LRA00890	CA136IR
LRA00474	CA857IR	LRA00585	CA317IR	LRA00727	CA310IR	LRA00891	CA140IR
LRA00474	CA858IR	LRA00588	JA113IR	LRA00728	CA566IR	LRA00894	CA237IR
LRA00481	JA163IR	LRA00589	CA131IR	LRA00729	CA567IR	LRA00897	CA320IR
LRA00483	JA778IR	LRA00590	CA303IR	LRA00730	CA242IR	LRA00898	JA680IR
LRA00484	JA165IR	LRA00592	CA329IR	LRA00731	CA910IR	LRA00899	CA617IR
LRA00485	JA1422IR	LRA00593	CA229IR	LRA00732	CA241IR	LRA00901	CA618IR
LRA00488	JA159IR	LRA00594	CA534IR	LRA00733	CA277IR	LRA00902	JA120

O.E. NO.	HC-PARTS	O.E. NO.	HC-PARTS	O.E. NO.	HC-PARTS	O.E. NO.	HC-PARTS
LRA00910	CA316IR	LRA01070	JA193	LRA01299	JA787IR	LRA01455	JA866IR
LRA00912	CA316IR	LRA01076	JA102	LRA01300	CA909IR	LRA01457	JA575IR
LRA00913	CA771R	LRA01087	CA292	LRA01303	CA707IR	LRA01460	CA903IR
LRA00917	CA511IR	LRA01091	JA872	LRA01304	CA323IR	LRA01464	JA551IR
LRA00918	CA141IR	LRA01096	JA777	LRA01306	JA671IR	LRA01465	CA383IR
LRA00920	CA183	LRA01098	JA101	LRA01307	CA556IR	LRA01467	CA1048IR
LRA00922	CA180	LRA01099	JA130	LRA01308	JA864IR	LRA01468	JA1286IR
LRA00924	CA341IR	LRA01115	JA777	LRA01309	JA694IR	LRA01469	JA551IR
LRA00925	CA187IR	LRA01117	CA709	LRA01313	JA764IR	LRA01470	JA1353IR
LRA00926	CA130IR	LRA01122	JA1409	LRA01315	JA759IR	LRA01471	JA1130IR
LRA00926	CA155IR	LRA01123	UA1213	LRA01320	JA571IR	LRA01473	JA1286IR
LRA00927	CA334IR	LRA01124	JA1283	LRA01324	JA109IR	LRA01474	CA369IR
LRA00929	CA355IR	LRA01125	UA961	LRA01325	JA695IR	LRA01475	CA1031IR
LRA00931	CA118	LRA01129	UA1212	LRA01327	JA696IR	LRA01475	CA719IR
LRA00932	CA635IR	LRA01131	UA927	LRA01328	CA268IR	LRA01477	CA832IR
LRA00933	CA838IR	LRA01135	UA951	LRA01329	JA793IR	LRA01479	JA780IR
LRA00934	JA680IR	LRA01136	JA656	LRA01331	JA116IR	LRA01481	JA1166IR
LRA00935	CA1050IR	LRA01142	JA1610	LRA01332	CA591IR	LRA01483	CA1245IR
LRA00936	CA501IR	LRA01143	JA1283	LRA01333	CA541IR	LRA01485	JA883IR
LRA00938	CA326IR	LRA01144	JA1362	LRA01336	CA605IR	LRA01486	CA1251IR
LRA00939	JA673IR	LRA01146	UA1214	LRA01337	CA716IR	LRA01487	UA963IR
LRA00940	CA1029IR	LRA01147	JA1707	LRA01338	CA634IR	LRA01488	CA700IR
LRA00940	CA611IR	LRA01149	UA1215	LRA01339	JA1169IR	LRA01489	JA1358IR
LRA00942	CA538IR	LRA01150	CA1635IR	LRA01340	CA229IR	LRA01490	CA1062IR
LRA00943	CA539IR	LRA01151	JA1706	LRA01344	JA803IR	LRA01492	CA900IR
LRA00943	CA547IR	LRA01155	CA1638IR	LRA01346	CA340IR	LRA01493	JA1418IR
LRA00944	CA587IR	LRA01166	JA1705	LRA01349	CA361IR	LRA01495	JA888IR
LRA00946	CA556IR	LRA01168	JA1598	LRA01350	JA678IR	LRA01496	JA765IR
LRA00947	JA771IR	LRA01169	CA1780IR	LRA01352	CA355IR	LRA01498	CA229IR
LRA00948	JA554IR	LRA01171	CA1857IR	LRA01353	CA712IR	LRA01499	JA1366IR
LRA00949	JA652IR	LRA01172	CA1737IR	LRA01354	CA839IR	LRA01501	JA1284IR
LRA00950	JA171IR	LRA01175	CA244IR	LRA01355	CA1259IR	LRA01502	JA995IR
LRA00951	CA384IR	LRA01176	JA104IR	LRA01356	CA1048IR	LRA01504	JA1120IR
LRA00952	CA381IR	LRA01178	CA1201IR	LRA01359	JA677IR	LRA01505	CA1347IR
LRA00953	CA711IR	LRA01179	CA1192IR	LRA01362	JA1351IR	LRA01507	JA1416IR
LRA00954	JA190	LRA01190	CA317IR	LRA01363	JA1131IR	LRA01508	UA967IR
LRA00955	JA751IR	LRA01191	JA116IR	LRA01364	JA760IR	LRA01509	UA924IR
LRA00956	JA1272IR	LRA01194	CA178IR	LRA01365	CA593IR	LRA01514	JA761IR
LRA00957	JA622IR	LRA01196	CA579IR	LRA01366	CA590IR	LRA01516	CA815IR
LRA00958	CA564IR	LRA01197	CA229IR	LRA01367	JA578IR	LRA01517	CA1269IR
LRA00959	CA1387IR	LRA01198	JA807IR	LRA01369	CA540IR	LRA01518	CA1063IR
LRA00960	CA731IR	LRA01199	CA734IR	LRA01370	CA542IR	LRA01519	CA1265IR
LRA00964	CA1387IR	LRA01202	CA374IR	LRA01371	JA804IR	LRA01520	CA1040IR
LRA00966	CA574IR	LRA01203	CA813IR	LRA01372	JA1177IR	LRA01523	JA1417IR
LRA00967	CA650IR	LRA01209	CA238IR	LRA01375	JA878IR	LRA01524	CA827IR
LRA00968	CA516IR	LRA01212	JA770IR	LRA01376	CA841IR	LRA01525	UA923IR
LRA00969	CA366IR	LRA01215	JA565IR	LRA01378	JA759IR	LRA01526	CA1060IR
LRA00971	CA568IR	LRA01218	JA105IR	LRA01379	CA594IR	LRA01529	JA1275IR
LRA00972	CA518IR	LRA01227	JA799IR	LRA01381	CA708IR	LRA01530	CA549IR
LRA00973	CA333IR	LRA01228	JA1127IR	LRA01382	JA973IR	LRA01531	JA781IR
LRA00974	CA1224IR	LRA01229	JA785IR	LRA01383	JA983IR	LRA01533	JA1183IR
LRA00975	CA642IR	LRA01230	JA194IR	LRA01385	JA753IR	LRA01535	CA579IR
LRA00976	CA710IR	LRA01232	CA87IR	LRA01387	JA870IR	LRA01536	CA1822IR
LRA00977	CA333IR	LRA01234	JA662IR	LRA01393	CA547IR	LRA01539	CA1222IR
LRA00978	CA240IR	LRA01236	JA162IR	LRA01394	CA899IR	LRA01544	JA1121IR
LRA00980	CA196IR	LRA01244	CA96IR	LRA01395	JA773IR	LRA01547	CA1196IR
LRA00981	CA125IR	LRA01245	JA761IR	LRA01397	CA1433IR	LRA01550	JA1363IR
LRA00982	CA192IR	LRA01246	CA1192IR	LRA01399	JA776IR	LRA01551	JA1374IR
LRA00983	CA139IR	LRA01247	CA363IR	LRA01404	JA767IR	LRA01553	CA844IR
LRA00984	CA221IR	LRA01248	JA986IR	LRA01405	JA652IR	LRA01554	CA1320IR
LRA00986	CA236IR	LRA01251	CA502IR	LRA01407	JA882IR	LRA01555	JA657IR
LRA00987	CA205IR	LRA01252	JA577IR	LRA01408	JA876IR	LRA01556	JA1179IR
LRA00988	CA287IR	LRA01256	JA669IR	LRA01414	CA1046IR	LRA01563	JA655IR
LRA00989	CA87IR	LRA01259	JA578IR	LRA01422	CA186IR	LRA01571	CA1238IR
LRA00990	CA195IR	LRA01262	JA531IR	LRA01425	JA871IR	LRA01572	CA1084IR
LRA00992	CA367IR	LRA01263	CA380IR	LRA01426	JA995IR	LRA01573	JA1411IR
LRA00994	CA139IR	LRA01265	JA186IR	LRA01428	CA532IR	LRA01574	CA1221IR
LRA00998	CA252IR	LRA01269	JA657IR	LRA01430	JA874IR	LRA01575	CA1107IR
LRA01002	CA50	LRA01273	JA178IR	LRA01432	JA754IR	LRA01576	CA583IR
LRA01006	JA786	LRA01276	JA553IR	LRA01433	JA1360IR	LRA01578	JA1413IR
LRA01032	CA283	LRA01279	JA158IR	LRA01436	JA881IR	LRA01580	CA1204IR
LRA01040	CA166	LRA01280	JA802IR	LRA01438	CA700IR	LRA01581	CA1161IR
LRA01041	CA166	LRA01282	CA229IR	LRA01441	UA939IR	LRA01582	CA1216IR
LRA01044	CA120	LRA01285	UA943IR	LRA01442	CA743IR	LRA01583	CA1219IR
LRA01058	UA918	LRA01287	JA174IR	LRA01446	JA657IR	LRA01585	CA1218IR
LRA01062	JA686	LRA01290	JA675IR	LRA01447	CA825IR	LRA01586	CA1189IR
LRA01066	JA149	LRA01292	CA625IR	LRA01448	CA639IR	LRA01587	CA896IR
LRA01068	UA916	LRA01293	JA668IR	LRA01450	CA837IR	LRA01588	JA1181IR
LRA01069	JA686	LRA01295	JA660IR	LRA01453	CA515IR	LRA01591	JA1134IR

O.E. NO.	HC-PARTS	O.E. NO.	HC-PARTS	O.E. NO.	HC-PARTS	O.E. NO.	HC-PARTS
<b>LUCAS <i>Continued</i></b>							
LRA01592	CA1507IR	LRA01714	JA1537IR	LRA01838	CA1492IR	LRA01959	JA1274IR
LRA01593	CA1382IR	LRA01715	JA769IR	LRA01839	JA992IR	LRA01960	JA1169IR
LRA01594	CA1105IR	LRA01717	JA1533IR	LRA01840	CA1845IR	LRA01961	JA1711IR
LRA01596	CA1311IR	LRA01719	JA970IR	LRA01841	JA1420IR	LRA01965	CA1982IR
LRA01597	JA178IR	LRA01720	CA1247IR	LRA01842	CA1503IR	LRA01966	CA1622IR
LRA01598	JA1534IR	LRA01721	CA1261IR	LRA01843	CA1491IR	LRA01968	CA1546IR
LRA01599	CA1472IR	LRA01722	CA1435IR	LRA01844	CA1477IR	LRA01969	CA1664IR
LRA01600	CA833IR	LRA01723	CA1299IR	LRA01845	JA1713IR	LRA01970	CA1756IR
LRA01601	JA1128IR	LRA01724	CA1383IR	LRA01846	CA1439IR	LRA01971	JA1794IR
LRA01602	JA577IR	LRA01725	CA1104IR	LRA01848	CA1403IR	LRA01972	CA1545IR
LRA01605	UA967IR	LRA01726	JA1515IR	LRA01849	CA1333IR	LRA01973	CA1653IR
LRA01606	CA1300IR	LRA01727	UA967IR	LRA01850	JA1515IR	LRA01975	CA1746IR
LRA01608	JA1167IR	LRA01728	JA1416IR	LRA01851	CA1390IR	LRA01976	CA1298IR
LRA01609	UA1113IR	LRA01730	CA1233IR	LRA01852	CA1225IR	LRA01977	CA1451IR
LRA01611	CA846IR	LRA01732	CA1672IR	LRA01853	CA1041IR	LRA01983	CA1639IR
LRA01614	JA1133IR	LRA01734	CA1158IR	LRA01855	JA1365IR	LRA01984	CA2047IR
LRA01616	CA603IR	LRA01735	CA902IR	LRA01856	CA1441IR	LRA01987	CA1588IR
LRA01621	JA978IR	LRA01736	CA1551IR	LRA01858	CA1302IR	LRA01989	CA1332IR
LRA01623	CA1301IR	LRA01739	JA1293IR	LRA01859	JA1295IR	LRA01990	CA1627IR
LRA01624	CA1629IR	LRA01740	CA1099IR	LRA01860	CA1062IR	LRA01992	JA1163IR
LRA01625	CA1452IR	LRA01741	CA1080IR	LRA01861	CA1481IR	LRA01994	JA1412IR
LRA01626	CA602IR	LRA01742	CA1216IR	LRA01862	JA1518IR	LRA01995	JA1271IR
LRA01627	CA1033IR	LRA01744	CA720IR	LRA01864	CA1565IR	LRA01996	CA1759IR
LRA01631	JA1414IR	LRA01745	CA1306IR	LRA01865	CA1540IR	LRA01997	CA1567IR
LRA01633	JA1513IR	LRA01746	JA1376IR	LRA01866	CA1486IR	LRA01998	CA1566IR
LRA01634	CA1141IR	LRA01748	CA1328IR	LRA01867	CA1082IR	LRA01999	JA1417IR
LRA01635	CA1097IR	LRA01749	JA1123IR	LRA01868	CA700IR	LRA02000	CA1734IR
LRA01638	JA1530IR	LRA01750	JA1134IR	LRA01872	CA1392IR	LRA02001	CA1312IR
LRA01639	CA254IR	LRA01751	JA1276IR	LRA01873	CA1139IR	LRA02002	JA1802IR
LRA01640	CA835IR	LRA01752	JA1164IR	LRA01874	CA1471IR	LRA02004	JA1371IR
LRA01641	JA576IR	LRA01753	JA1173IR	LRA01877	CA700IR	LRA02005	CA645IR
LRA01642	CA1231IR	LRA01754	JA1281IR	LRA01878	CA1081IR	LRA02006	JA1802IR
LRA01643	JA1357IR	LRA01756	CA1570IR	LRA01880	JA1603IR	LRA02009	CA1506IR
LRA01644	CA1256IR	LRA01757	JA1361IR	LRA01882	CA1207IR	LRA02010	CA1388IR
LRA01645	CA1449IR	LRA01759	CA1543IR	LRA01885	CA1350IR	LRA02011	CA1394IR
LRA01648	JA1419IR	LRA01760	JA769IR	LRA01886	CA1571IR	LRA02012	CA1506IR
LRA01650	JA774IR	LRA01762	UA925IR	LRA01887	CA1558IR	LRA02013	CA1489IR
LRA01651	UA947IR	LRA01763	CA1061IR	LRA01888	CA564IR	LRA02014	CA1590IR
LRA01653	CA328IR	LRA01764	CA648IR	LRA01889	CA1349IR	LRA02015	CA1573IR
LRA01657	CA502IR	LRA01765	CA636IR	LRA01890	CA1397IR	LRA02016	JA551IR
LRA01658	CA1054IR	LRA01767	CA1300IR	LRA01891	CA1572IR	LRA02017	CA1578IR
LRA01661	JA1519IR	LRA01768	JA697IR	LRA01895	JA1514IR	LRA02018	CA1555IR
LRA01662	JA1516IR	LRA01769	CA1300IR	LRA01896	JA1293IR	LRA02019	JA1795IR
LRA01665	JA1368IR	LRA01771	CA1084IR	LRA01898	CA1485IR	LRA02024	JA1415IR
LRA01666	JA1280IR	LRA01772	JA870IR	LRA01901	CA1306IR	LRA02025	CA1577IR
LRA01668	CA1335IR	LRA01773	CA1629IR	LRA01902	CA1090IR	LRA02026	UA947IR
LRA01669	CA1494IR	LRA01774	CA1309IR	LRA01903	CA646IR	LRA02027	CA1748IR
LRA01670	JA1702IR	LRA01775	CA1107IR	LRA01906	JA1801IR	LRA02032	CA1319IR
LRA01671	CA912IR	LRA01778	CA818IR	LRA01908	JA1531IR	LRA02033	CA1322IR
LRA01672	CA1323IR	LRA01779	CA1199IR	LRA01911	CA1338IR	LRA02035	CA1688IR
LRA01674	CA1685IR	LRA01781	UA1538IR	LRA01912	CA1511IR	LRA02036	CA1307IR
LRA01675	CA1254IR	LRA01782	UA1109IR	LRA01913	JA1802IR	LRA02038	JA1166IR
LRA01676	JA1523IR	LRA01783	UA940IR	LRA01915	CA1849IR	LRA02039	JA1715IR
LRA01677	JA1287IR	LRA01785	CA1401IR	LRA01916	CA1495IR	LRA02044	JA1536IR
LRA01678	UA942IR	LRA01794	UA962IR	LRA01917	UA933IR	LRA02046	CA1622IR
LRA01680	JA1525IR	LRA01796	CA645IR	LRA01918	JA1411IR	LRA02047	CA564IR
LRA01682	JA1716IR	LRA01799	CA645IR	LRA01919	CA1480IR	LRA02048	JA1787IR
LRA01683	CA556IR	LRA01804	JA774IR	LRA01921	JA1604IR	LRA02049	CA1771IR
LRA01684	CA1299IR	LRA01805	CA1232IR	LRA01922	CA1557IR	LRA02052	CA817IR
LRA01685	CA1473IR	LRA01807	JA783IR	LRA01924	JA1522IR	LRA02053	JA1410IR
LRA01686	JA1292IR	LRA01808	CA1091IR	LRA01925	JA1609IR	LRA02055	CA1333IR
LRA01687	CA840IR	LRA01811	CA1036IR	LRA01928	CA1779IR	LRA02058	JA1356IR
LRA01689	CA1561IR	LRA01812	CA1445IR	LRA01929	UA938IR	LRA02059	CA1661IR
LRA01691	CA723IR	LRA01813	JA1536IR	LRA01930	CA1499IR	LRA02060	CA1586IR
LRA01692	CA830IR	LRA01814	CA1268IR	LRA01932	JA1532IR	LRA02062	JA787IR
LRA01694	CA895IR	LRA01815	CA1585IR	LRA01933	JA166IR	LRA02067	JA1373IR
LRA01695	CA1454IR	LRA01816	JA1535IR	LRA01938	CA1207IR	LRA02070	JA1596IR
LRA01697	JA1170IR	LRA01817	CA1443IR	LRA01939	JA1522IR	LRA02072	JA1618IR
LRA01698	JA979IR	LRA01818	JA1430IR	LRA01943	JA1616IR	LRA02073	CA1677IR
LRA01699	JA1132IR	LRA01819	CA1750IR	LRA01944	UA964IR	LRA02074	CA1339IR
LRA01702	CA1059IR	LRA01820	CA1587IR	LRA01945	JA1595IR	LRA02075	JA1594IR
LRA01704	CA712IR	LRA01823	CA1637IR	LRA01947	CA1634IR	LRA02076	CA1584IR
LRA01705	CA1077IR	LRA01824	CA1735IR	LRA01949	CA1493IR	LRA02078	JA1294IR
LRA01707	CA1107IR	LRA01826	JA116IR	LRA01951	JA1517IR	LRA02079	JA1523IR
LRA01709	CA1206IR	LRA01827	JA165IR	LRA01952	CA1634IR	LRA02083	CA1223IR
LRA01710	CA1402IR	LRA01832	CA1107IR	LRA01953	CA1634IR	LRA02085	CA1331IR
LRA01711	CA1058IR	LRA01833	CA1500IR	LRA01954	JA1372IR	LRA02089	JA1783IR
LRA01712	JA1364IR	LRA01834	CA1492IR	LRA01955	CA1559IR	LRA02090	UA923IR
LRA01713	JA1704IR	LRA01836	JA1293IR	LRA01956	JA1717IR	LRA02091	CA1845IR

O.E. NO.	HC-PARTS	O.E. NO.	HC-PARTS	O.E. NO.	HC-PARTS	O.E. NO.	HC-PARTS
LRA02092	CA306IR	LRA02227	CA1673IR	LRA02348	CA2034IR	LRA02559	CA1963IR
LRA02094	CA1845IR	LRA02228	CA1674IR	LRA02349	CA1767IR	LRA02562	CA1777IR
LRA02095	CA1732IR	LRA02229	CA1850IR	LRA02350	CA1768IR	LRA02564	CA125IR
LRA02096	CA1302IR	LRA02230	JA1720IR	LRA02351	JA1712IR	LRA02565	CA905IR
LRA02097	CA1689IR	LRA02231	JA1709IR	LRA02352	JA1724IR	LRA02566	JA1807IR
LRA02099	CA1830IR	LRA02232	CA1733IR	LRA02353	JA1725IR	LRA02569	CA99IR
LRA02100	CA1444IR	LRA02234	CA1831IR	LRA02354	JA1726IR	LRA02570	CA93
LRA02104	JA1708IR	LRA02235	CA1820IR	LRA02355	JA1728IR	LRA02573	CA88
LRA02105	CA1697IR	LRA02237	CA1321IR	LRA02357	CA1818IR	LRA02577	JA130
LRA02106	CA1592IR	LRA02238	CA1729IR	LRA02358	CA1810IR	LRA02579	JA144
LRA02107	CA1634IR	LRA02240	CA1858IR	LRA02360	CA1815IR	LRA02581	CA644IR
LRA02108	CA1634IR	LRA02241	CA1740IR	LRA02361	CA1817IR	LRA02582	CA727IR
LRA02111	UA935IR	LRA02242	CA1740IR	LRA02362	CA1752IR	LRA02583	CA190IR
LRA02112	CA1813IR	LRA02245	CA1730IR	LRA02363	CA1732IR	LRA02584	CA367IR
LRA02113	CA1333IR	LRA02247	CA1846IR	LRA02364	CA1937IR	LRA02587	CA619IR
LRA02114	CA1641IR	LRA02248	JA1606IR	LRA02367	CA1863IR	LRA02588	CA894IR
LRA02115	CA1754IR	LRA02249	CA1775IR	LRA02368	CA1827IR	LRA02589	JA116IR
LRA02120	CA1256IR	LRA02250	CA1764IR	LRA02369	CA1824IR	LRA02591	JA146IR
LRA02121	CA1070IR	LRA02251	CA1773IR	LRA02373	CA1854IR	LRA02592	CA186IR
LRA02123	JA757IR	LRA02253	CA1675IR	LRA02374	JA754IR	LRA02593	CA163IR
LRA02125	CA1648IR	LRA02254	CA1755IR	LRA02375	CA1447IR	LRA02596	CA315IR
LRA02126	JA1527IR	LRA02255	CA1811IR	LRA02392	JA1125	LRA02598	JA161IR
LRA02129	CA1074IR	LRA02256	CA1769IR	LRA02403	JA982	LRA02600	CA597IR
LRA02130	CA1582IR	LRA02257	CA1389IR	LRA02415	CA501IR	LRA02601	CA735IR
LRA02133	CA1647IR	LRA02258	CA836IR	LRA02421	JA1427IR	LRA02603	CA362IR
LRA02134	JA1597IR	LRA02260	CA1334IR	LRA02423	CA368IR	LRA02604	JA585IR
LRA02136	JA1788IR	LRA02261	CA1584IR	LRA02424	JA187IR	LRA02608	CA302IR
LRA02137	UA937IR	LRA02262	CA1332IR	LRA02427	JA1352IR	LRA02609	CA298IR
LRA02138	CA1480IR	LRA02263	CA1654IR	LRA02429	CA744IR	LRA02611	CA384IR
LRA02139	CA1206IR	LRA02265	JA1808IR	LRA02431	JA672IR	LRA02613	CA320IR
LRA02140	CA1206IR	LRA02266	CA1766IR	LRA02434	CA558IR	LRA02614	JA185IR
LRA02142	CA1497IR	LRA02270	JA1803IR	LRA02437	JA796IR	LRA02615	JA971IR
LRA02143	CA846IR	LRA02287	JA1727IR	LRA02438	JA972IR	LRA02616	JA551IR
LRA02145	CA1623IR	LRA02288	CA1437IR	LRA02447	JA984IR	LRA02618	JA775IR
LRA02148	CA1662IR	LRA02289	CA1446IR	LRA02448	CA705IR	LRA02620	JA164IR
LRA02149	CA1774IR	LRA02291	CA1782IR	LRA02449	CA898IR	LRA02621	CA1387IR
LRA02150	JA1539IR	LRA02292	CA1837IR	LRA02454	JA977IR	LRA02622	JA766IR
LRA02151	CA1698IR	LRA02293	CA1489IR	LRA02460	CA334IR	LRA02623	JA184IR
LRA02152	JA1790IR	LRA02294	CA1776IR	LRA02469	CA1438IR	LRA02624	CA272IR
LRA02153	CA1643IR	LRA02295	CA1765IR	LRA02470	CA907IR	LRA02626	JA996IR
LRA02155	CA291IR	LRA02297	CA1676IR	LRA02471	JA1524IR	LRA02627	JA575IR
LRA02160	CA1645IR	LRA02298	JA1721IR	LRA02473	JA1296IR	LRA02631	CA601IR
LRA02162	CA1838IR	LRA02299	CA1622IR	LRA02474	CA1049IR	LRA02632	CA521IR
LRA02164	CA1681IR	LRA02300	CA1761IR	LRA02475	CA1148IR	LRA02633	CA198IR
LRA02167	CA1632IR	LRA02301	CA1665IR	LRA02478	CA327IR	LRA02634	JA147IR
LRA02168	CA1632IR	LRA02303	CA1665IR	LRA02479	UA948IR	LRA02635	CA713IR
LRA02169	CA1641IR	LRA02304	JA1806IR	LRA02481	CA1236IR	LRA02636	JA552IR
LRA02171	CA1680IR	LRA02306	JA1617IR	LRA02482	CA702IR	LRA02637	JA171IR
LRA02172	CA1854IR	LRA02308	CA1983IR	LRA02486	CA1310IR	LRA02638	CA284IR
LRA02174	CA1652IR	LRA02309	JA1896IR	LRA02487	CA1770IR	LRA02640	JA699IR
LRA02175	CA1562IR	LRA02310	JA1805IR	LRA02488	CA1770IR	LRA02642	JA697IR
LRA02177	CA1679IR	LRA02311	CA1741IR	LRA02489	CA1336IR	LRA02643	CA632IR
LRA02180	CA1743IR	LRA02313	CA1753IR	LRA02490	UA946IR	LRA02644	CA610IR
LRA02181	JA1612IR	LRA02314	JA1784IR	LRA02491	JA1118IR	LRA02645	CA633IR
LRA02182	CA1673IR	LRA02315	CA1656IR	LRA02501	CA1049IR	LRA02646	JA684IR
LRA02182	CA1988IR	LRA02316	CA1951IR	LRA02502	CA1456IR	LRA02647	CA324IR
LRA02183	CA1636IR	LRA02317	JA1796IR	LRA02503	CA857IR	LRA02649	CA349IR
LRA02185	CA1828IR	LRA02318	CA1763IR	LRA02504	CA1505IR	LRA02650	JA750IR
LRA02186	CA1698IR	LRA02319	CA1905IR	LRA02507	JA1428IR	LRA02652	CA506IR
LRA02187	CA1684IR	LRA02320	JA1789IR	LRA02511	CA1193IR	LRA02653	CA506IR
LRA02188	CA1400IR	LRA02321	CA1819IR	LRA02512	CA1695IR	LRA02654	JA805IR
LRA02189	JA1613IR	LRA02323	CA1678IR	LRA02513	CA1663IR	LRA02655	JA774IR
LRA02190	CA2022IR	LRA02325	CA1855IR	LRA02515	CA1574IR	LRA02656	JA761IR
LRA02201	CA1839IR	LRA02326	JA1795IR	LRA02518	CA2040IR	LRA02659	CA714IR
LRA02203	JA1703IR	LRA02331	CA1696IR	LRA02522	CA1666IR	LRA02660	JA974IR
LRA02204	CA1591IR	LRA02332	CA1778IR	LRA02523	CA1666IR	LRA02663	JA798IR
LRA02205	JA1271IR	LRA02334	CA1658IR	LRA02528	CA1666IR	LRA02664	CA897IR
LRA02206	CA1848IR	LRA02335	CA1660IR	LRA02529	CA1624IR	LRA02666	CA355IR
LRA02207	CA1556IR	LRA02336	CA1774IR	LRA02532	CA1650IR	LRA02668	JA682IR
LRA02210	JA1792IR	LRA02337	CA1654IR	LRA02534	CA1694IR	LRA02670	JA109IR
LRA02212	CA1835IR	LRA02338	CA1777IR	LRA02535	CA1699IR	LRA02672	CA1242IR
LRA02213	CA521IR	LRA02340	JA1716IR	LRA02536	CA1812IR	LRA02675	CA586IR
LRA02215	JA1602IR	LRA02342	CA1700IR	LRA02537	CA1739IR	LRA02676	CA622IR
LRA02218	CA1781IR	LRA02343	CA1683IR	LRA02540	CA1823IR	LRA02677	CA732IR
LRA02222	CA564IR	LRA02344	CA1701IR	LRA02542	CA1877IR	LRA02678	CA360IR
LRA02223	CA1861IR	LRA02345	CA1625IR	LRA02544	JA1897IR	LRA02679	JA867IR
LRA02224	CA1861IR	LRA02346	CA1749IR	LRA02545	CA1766IR	LRA02680	JA654IR
LRA02225	JA1615IR	LRA02347	CA1825IR	LRA02556	JA1406IR	LRA02681	CA379IR
LRA02226	CA1761IR	LRA02348	CA1758IR	LRA02558	JA1796IR	LRA02682	CA1030IR

O.E. NO.	HC-PARTS	O.E. NO.	HC-PARTS	O.E. NO.	HC-PARTS	O.E. NO.	HC-PARTS
<b>LUCAS <i>Continued</i></b>							
LRA02682	CA7181R	LRA02793	JA18931R	LRA02919	JA1799	LRA03074	CA10491R
LRA02683	JA1821R	LRA02794	CA17551R	LRA02920	CA16931R	LRA03075	CA16521R
LRA02686	JA8771R	LRA02795	CA13881R	LRA02922	CA13951R	LRA03076	CA16391R
LRA02688	CA8471R	LRA02797	CA18561R	LRA02923	JA17111R	LRA03080	CA18791R
LRA02689	CA10441R	LRA02800	CA17421R	LRA02925	JA1409	LRA03082	CA20621R *
LRA02690	CA7261R	LRA02804	CA18621R	LRA02928	CA16321R	LRA03084	CA20161R
LRA02691	CA16861R	LRA02805	JA18911R	LRA02930	CA18291R	LRA03086	CA18881R
LRA02693	JA14211R	LRA02806	JA18991R	LRA02931	CA19121R	LRA03087	CA18411R
LRA02696	JA11881R	LRA02807	CA18841R	LRA02933	CA20771R *	LRA03088	CA17441R
LRA02697	CA5391R	LRA02808	CA19951R	LRA02933	JA17981R	LRA03091	CA18791R
LRA02698	CA10681R	LRA02809	CA18851R	LRA02934	CA19661R *	LRA03094	CA20171R
LRA02699	CA15071R	LRA02810	CA20841R *	LRA02935	CA18801R	LRA03095	CA19981R
LRA02700	CA10571R	LRA02811	CA11991R	LRA02940	CA18671R	LRA03096	CA20101R
LRA02701	JA1651R	LRA02812	CA16421R	LRA02945	CA1972	LRA03098	CA19671R
LRA02705	CA10691R	LRA02813	JA15391R	LRA02946	CA18901R	LRA03099	CA19771R
LRA02706	CA12691R	LRA02814	CA18651R	LRA02947	CA19651R *	LRA03100	CA20411R
LRA02708	CA8281R	LRA02815	CA18341R	LRA02948	CA19961R	LRA03103	CA14981R
LRA02709	CA11591R	LRA02817	CA18551R	LRA02950	CA19211R	LRA03104	CA14991R
LRA02710	JA13671R	LRA02818	CA18601R	LRA02951	JA17981R	LRA03105	CA16871R
LRA02711	CA11901R	LRA02819	CA18601R	LRA02953	CA19701R	LRA03106	CA16651R
LRA02712	CA14501R	LRA02821	JA17851R	LRA02954	CA19431R *	LRA03108	CA20571R
LRA02713	CA6471R	LRA02823	CA18331R	LRA02956	CA19041R	LRA03109	CA20681R *
LRA02714	JA11831R	LRA02824	CA17471R	LRA02957	CA20041R	LRA03115	JA13531R
LRA02715	JA12881R	LRA02825	CA16581R	LRA02958	CA19401R	LRA03116	CA18801R
LRA02716	CA10311R	LRA02827	CA18591R	LRA02961	CA20091R	LRA03119	CA20281R
LRA02716	CA7191R	LRA02828	CA20591R *	LRA02965	CA20521R	LRA03121	CA19301R *
LRA02717	JA11841R	LRA02830	CA2021 *	LRA02967	CA19541R	LRA03122	JA1791
LRA02718	CA7011R	LRA02833	CA18511R	LRA02969	CA19531R	LRA03126	CA19711R
LRA02719	JA6821R	LRA02834	JA6831R	LRA02970	CA19531R	LRA03127	JA19001R
LRA02720	CA1261R	LRA02835	UA15381R	LRA02972	CA2014	LRA03128	CA20581R *
LRA02721	JA1481R	LRA02836	JA14231R	LRA02974	CA19331R	LRA03132	CA18321R
LRA02722	CA1261R	LRA02837	CA18141R	LRA02976	CA19681R	LRA03139	CA20391R
LRA02723	CA8421R	LRA02839	CA18641R	LRA02977	CA19281R	LRA03145	CA16651R
LRA02724	CA10561R	LRA02842	CA18321R	LRA02978	CA19221R	LRA03146	CA19161R
LRA02726	JA6901R	LRA02843	CA19641R	LRA02979	CA19191R	LRA03148	CA13031R
LRA02727	CA2551R	LRA02845	CA19081R	LRA02985	JA19031R	LRA03155	CA19751R
LRA02728	CA8261R	LRA02847	CA19091R	LRA02997	UA16201R	LRA03156	CA17821R
LRA02729	CA10551R	LRA02849	JA18951R	LRA02999	JA16001R	LRA03157	CA19811R
LRA02730	CA8921R	LRA02852	CA18571R	LRA03000	JA17971R	LRA03161	CA20291R
LRA02731	CA11981R	LRA02853	CA18571R	LRA03002	JA9871R	LRA03166	CA20431R
LRA02732	CA10731R	LRA02855	CA15871R	LRA03003	CA19231R	LRA03167	CA19791R
LRA02733	CA10411R	LRA02856	CA20811R *	LRA03005	CA18401R	LRA03168	CA19181R
LRA02734	CA6101R	LRA02857	CA19201R	LRA03006	CA19521R	LRA03169	CA19111R
LRA02735	CA12411R	LRA02860	JA18921R	LRA03007	CA19691R	LRA03172	CA20361R *
LRA02736	CA8971R	LRA02862	CA18361R	LRA03009	CA20441R *	LRA03176	CA19101R
LRA02737	CA11421R	LRA02863	CA18421R	LRA03010	CA19491R	LRA03178	CA16751R
LRA02738	CA10311R	LRA02868	CA20371R	LRA03013	CA19251R	LRA03179	CA20891R *
LRA02738	CA7191R	LRA02869	CA17381R	LRA03020	CA16891R	LRA03180	CA10561R
LRA02739	CA11431R	LRA02871	CA17431R	LRA03025	CA19061R	LRA03183	CA19971R
LRA02740	CA5211R	LRA02872	CA18271R	LRA03028	CA19581R	LRA03184	CA19741R
LRA02741	JA13761R	LRA02873	CA20821R *	LRA03031	CA19911R *	LRA03185	CA19861R
LRA02743	JA11801R	LRA02875	JA1898	LRA03033	CA18601R	LRA03187	CA19291R *
LRA02744	JA16011R	LRA02876	JA18991R	LRA03034	CA19471R *	LRA03188	CA19421R *
LRA02745	CA7011R	LRA02877	CA18831R	LRA03036	CA19591R	LRA03189	CA19741R
LRA02746	CA3241R	LRA02881	CA18661R	LRA03038	JA19011R	LRA03193	CA19931R
LRA02747	CA12621R	LRA02882	CA18701R	LRA03039	CA20341R	LRA03252	CA16651R
LRA02751	CA16281R	LRA02883	CA18711R	LRA03041	CA11411R	LRA03254	CA21021R *
LRA02752	JA6891R	LRA02884	CA18761R	LRA03043	CA18721R	LRA03264	CA20481R
LRA02753	JA7701R	LRA02885	CA18731R	LRA03044	CA19451R	LRA03265	CA20601R *
LRA02755	JA14241R	LRA02886	CA18741R	LRA03045	CA19941R	LRA03304	CA20861R *
LRA02756	CA15411R	LRA02889	CA14701R	LRA03046	CA18811R	LRA03312	CA20501R *
LRA02758	CA16441R	LRA02890	CA18721R	LRA03047	CA19261R	LRA03363	CA20871R *
LRA02760	JA16051R	LRA02891	CA17571R	LRA03048	CA19381R	LRA03408	CA20721R *
LRA02761	JA11851R	LRA02892	CA18751R	LRA03052	CA19271R	LRA03423	CA20941R *
LRA02762	CA5601R	LRA02893	CA17621R	LRA03053	CA20911R *	LRA03424	CA21011R *
LRA02764	CA13861R	LRA02897	CA16341R	LRA03054	CA20671R *	LRA03463	CA6271R
LRA02765	CA14741R	LRA02901	CA20241R	LRA03055	CA20181R	LRB00100	CA14381R
LRA02770	CA16551R	LRA02905	CA13931R	LRA03056	JA16001R	LRB00100	CA5581R
LRA02771	CA15101R	LRA02906	JA18941R	LRA03061	CA19131R	LRB00101	CA5501R
LRA02776	CA7481R	LRA02907	CA18691R	LRA03062	CA18861R	LRB00101	CA7481R
LRA02778	CA3411R	LRA02908	CA18681R	LRA03063	CA19151R	LRB00102	CA2401R
LRA02779	CA15931R	LRA02910	JA17981R	LRA03064	CA19551R	LRB00103	CA3761R
LRA02781	CA7171R	LRA02911	CA19991R	LRA03065	CA19561R	LRB00104	CA2271R
LRA02783	JA18001R	LRA02912	CA19411R	LRA03066	CA19871R	LRB00104	CA7491R
LRA02784	CA13251R	LRA02913	CA19891R	LRA03068	CA19351R	LRB00105	CA3341R
LRA02786	JA5981R	LRA02914	CA19851R	LRA03069	CA19311R	LRB00106	CA1871R
LRA02789	CA3061R	LRA02915	JA1902	LRA03071	CA20551R	LRB00118	CA3021R
LRA02791	JA18041R	LRA02916	CA18821R	LRA03072	CA19781R	LRB00119	CA5251R
LRA02792	CA18621R	LRA02918	CA19461R	LRA03073	CA20231R	LRB00120	CA6091R



O.E. NO.	HC-PARTS	O.E. NO.	HC-PARTS	O.E. NO.	HC-PARTS	O.E. NO.	HC-PARTS
LRB00121	CA520IR	LRB00200	CA845IR	LRB00289	CA914IR	LRB00385	CA1089IR
LRB00122	CA561IR	LRB00201	JA1129IR	LRB00290	CA1494IR	LRB00386	CA1267IR
LRB00123	CA636IR	LRB00202	CA1036IR	LRB00292	CA1258IR	LRB00387	CA1240IR
LRB00124	CA563IR	LRB00203	CA896IR	LRB00293	CA915IR	LRB00389	CA1260IR
LRB00125	JA682IR	LRB00204	CA913IR	LRB00294	CA847IR	LRB00390	CA1249IR
LRB00126	CA738IR	LRB00205	JA806IR	LRB00295	CA1228IR	LRB00391	CA1144IR
LRB00127	CA513IR	LRB00206	CA715IR	LRB00296	CA1229IR	LRB00392	CA1256IR
LRB00128	CA560IR	LRB00207	CA1191IR	LRB00297	CA1039IR	LRB00393	CA1591IR
LRB00129	CA319IR	LRB00208	CA1137IR	LRB00298	CA1157IR	LRB00395	CA1243IR
LRB00130	JA974IR	LRB00209	CA324IR	LRB00299	JA1370IR	LRB00396	CA1298IR
LRB00131	CA513IR	LRB00210	JA976IR	LRB00301	CA1209IR	LRB00397	CA1484IR
LRB00132	CA647IR	LRB00211	JA981IR	LRB00303	JA1172IR	LRB00398	CA1344IR
LRB00133	CA822IR	LRB00212	JA988IR	LRB00305	CA1197IR	LRB00399	CA1345IR
LRB00134	CA238IR	LRB00213	JA783IR	LRB00306	CA858IR	LRB00400	CA1304IR
LRB00135	CA853IR	LRB00214	CA1154IR	LRB00307	CA299IR	LRB00401	CA1444IR
LRB00136	CA734IR	LRB00215	CA1153IR	LRB00308	JA1367IR	LRB00402	CA1250IR
LRB00137	CA1035IR	LRB00216	CA1084IR	LRB00309	JA869IR	LRB00403	CA1200IR
LRB00138	CA854IR	LRB00217	CA1062IR	LRB00310	CA1336IR	LRB00404	CA1391IR
LRB00139	CA187IR	LRB00218	CA1057IR	LRB00312	CA1043IR	LRB00405	CA1440IR
LRB00140	CA721	LRB00219	CA1088IR	LRB00313	JA180IR	LRB00406	CA1473IR
LRB00141	CA705IR	LRB00220	JA975IR	LRB00314	CA1487IR	LRB00407	CA1490IR
LRB00143	CA825IR	LRB00221	CA1318IR	LRB00315	JA1162IR	LRB00408	CA1501IR
LRB00144	CA733IR	LRB00222	CA615IR	LRB00316	CA849IR	LRB00409	CA1326IR
LRB00145	CA827IR	LRB00223	CA1037IR	LRB00317	CA1327IR	LRB00410	JA987IR
LRB00146	CA740IR	LRB00224	CA1087IR	LRB00318	CA570IR	LRB00411	JA1599IR
LRB00147	CA736IR	LRB00225	JA674IR	LRB00319	CA1051IR	LRB00412	JA1377IR
LRB00148	CA890IR	LRB00226	JA1174IR	LRB00320	CA1103IR	LRB00413	JA877IR
LRB00149	CA861IR	LRB00227	JA1175IR	LRB00323	CA1036IR	LRB00414	JA1279IR
LRB00150	CA1034IR	LRB00228	CA606IR	LRB00324	CA816IR	LRB00415	JA1405IR
LRB00151	JA599IR	LRB00230	JA879IR	LRB00325	CA821IR	LRB00416	CA2074IR *
LRB00152	JA689IR	LRB00231	JA688IR	LRB00326	CA851IR	LRB00418	CA1223IR
LRB00153	JA664IR	LRB00232	JA994IR	LRB00327	CA1196IR	LRB00419	CA1343IR
LRB00154	JA863IR	LRB00233	JA685IR	LRB00328	CA1160IR	LRB00420	CA1434IR
LRB00155	JA755IR	LRB00234	JA683IR	LRB00329	CA1220IR	LRB00421	CA1344IR
LRB00156	JA161IR	LRB00235	JA878IR	LRB00330	CA1190IR	LRB00422	CA737IR
LRB00157	JA805IR	LRB00236	JA1183IR	LRB00332	CA1152IR	LRB00423	CA1208IR
LRB00158	CA717IR	LRB00237	JA1376IR	LRB00333	CA1052IR	LRB00424	CA1102IR
LRB00159	CA717IR	LRB00238	JA1188IR	LRB00334	CA1156IR	LRB00426	CA1147IR
LRB00160	CA1030IR	LRB00241	JA750IR	LRB00335	CA1583IR	LRB00427	CA1398IR
LRB00160	CA718IR	LRB00242	JA1165IR	LRB00336	JA1119IR	LRB00428	CA1563IR
LRB00161	CA1031IR	LRB00243	CA1217IR	LRB00337	JA1178IR	LRB00429	CA1246IR
LRB00161	CA719IR	LRB00244	CA1077IR	LRB00338	JA1407IR	LRB00430	CA1248IR
LRB00162	CA1101IR	LRB00245	CA1078IR	LRB00339	JA1176IR	LRB00431	JA1600IR
LRB00163	CA1100IR	LRB00246	CA1079IR	LRB00340	JA782IR	LRB00433	CA1671IR
LRB00164	CA1066IR	LRB00247	CA848IR	LRB00341	JA678IR	LRB00434	CA1745IR
LRB00165	CA1146IR	LRB00249	CA1396IR	LRB00342	JA185IR	LRB00435	CA1651IR
LRB00166	CA1045IR	LRB00250	CA1386IR	LRB00343	JA1431IR	LRB00436	CA1442IR
LRB00166	CA861IR	LRB00251	CA852IR	LRB00344	JA551IR	LRB00437	CA1496IR
LRB00167	CA515IR	LRB00252	CA829IR	LRB00345	CA1136IR	LRB00438	CA1564IR
LRB00168	CA908IR	LRB00253	CA1093IR	LRB00346	CA1075IR	LRB00439	CA1646IR
LRB00169	CA1244IR	LRB00254	CA1139IR	LRB00347	CA1455IR	LRB00440	JA1273IR
LRB00170	JA868IR	LRB00255	CA1070IR	LRB00348	CA850IR	LRB00441	JA1520IR
LRB00171	JA665IR	LRB00256	JA1117IR	LRB00349	CA1138IR	LRB00442	JA880IR
LRB00172	CA738IR	LRB00257	JA1424IR	LRB00353	CA1092IR	LRB00443	CA1639IR
LRB00173	CA739IR	LRB00258	JA1425IR	LRB00357	CA1340IR	LRB00444	CA1636IR
LRB00174	CA1032IR	LRB00259	CA607IR	LRB00358	CA1483IR	LRB00446	JA1526IR
LRB00175	CA828IR	LRB00260	CA1083IR	LRB00359	CA1475IR	LRB00447	CA1305IR
LRB00176	CA610IR	LRB00261	CA1150IR	LRB00360	CA1324IR	LRB00448	CA1640IR
LRB00178	CA596IR	LRB00262	JA1290IR	LRB00361	CA1149IR	LRB00449	CA1641IR
LRB00180	CA820IR	LRB00265	JA1369IR	LRB00362	CA1076IR	LRB00451	CA1509IR
LRB00181	CA730IR	LRB00266	JA1182IR	LRB00363	CA1142IR	LRB00452	CA1553IR
LRB00182	CA533IR	LRB00267	JA697IR	LRB00364	CA1071IR	LRB00453	CA1087IR
LRB00183	CA637IR	LRB00268	JA698IR	LRB00365	JA991IR	LRB00453	CA1145IR
LRB00184	CA638IR	LRB00270	CA1265IR	LRB00366	CA1380IR	LRB00454	CA1474IR
LRB00185	CA1095IR	LRB00271	CA1316IR	LRB00369	JA1710IR	LRB00455	CA1760IR
LRB00186	CA1038IR	LRB00272	JA987IR	LRB00370	CA1488IR	LRB00456	CA1649IR
LRB00187	CA889IR	LRB00273	CA640IR	LRB00371	JA1426IR	LRB00457	CA1482IR
LRB00188	CA893IR	LRB00274	JA980IR	LRB00372	CA855IR	LRB00458	CA1342IR
LRB00189	CA630IR	LRB00276	JA1529	LRB00373	CA837IR	LRB00459	JA1607IR
LRB00190	CA826IR	LRB00277	CA1064IR	LRB00374	CA1140IR	LRB00460	CA1628IR
LRB00191	CA859IR	LRB00278	CA1106IR	LRB00375	CA1096IR	LRB00461	CA896IR
LRB00192	CA833IR	LRB00279	CA608IR	LRB00376	CA1056IR	LRB00462	CA1309IR
LRB00193	CA1044IR	LRB00280	CA1065IR	LRB00377	CA1069IR	LRB00463	CA1303IR
LRB00194	JA769IR	LRB00281	CA1098IR	LRB00378	CA1556IR	LRB00464	CA1322IR
LRB00195	CA724IR	LRB00282	CA836IR	LRB00380	CA1203IR	LRB00465	CA819IR
LRB00196	CA1053IR	LRB00285	CA1252IR	LRB00381	CA1317IR	LRB00466	JA1424IR
LRB00197	CA569IR	LRB00286	CA1230IR	LRB00382	CA1329IR	LRB00467	CA1576IR
LRB00198	CA856IR	LRB00287	CA1085IR	LRB00383	CA1257IR	LRB00468	JA1723IR
LRB00199	JA761IR	LRB00288	CA1085IR	LRB00384	CA1337IR	LRB00470	CA1631IR

O.E. NO.	HC-PARTS	O.E. NO.	HC-PARTS	O.E. NO.	HC-PARTS	O.E. NO.	HC-PARTS
<b>LUCAS <i>Continued</i></b>							
LRB00471	JA1722IR	LR500173	CS201	LR500356	CS162	LR500503	CS310
LRB00473	CA1502IR	LR500178	CS129	LR500364	JS300	LR500505	CS310
LRB00474	CA1446IR	LR500178	CS352	LR500366	CS278	LR500507	JS392
LRB00475	CA1394IR	LR500180	CS141	LR500367	JS399	LR500511	JS317
LRB00476	CA1547IR	LR500182	CS240	LR500370	CS115	LR500512	JS315
LRB00477	CA1548IR	LR500183	CS93	LR500372	CS347	LR500514	JS387
LRB00478	CA1504IR	LR500185	CS1075	LR500375	CS336	LR500515	JS349
LRB00479	CA1568IR	LR500188	JS302	LR500376	CS124	LR500515	JS350
LRB00480	CA1560IR	LR500189	CS603	LR500379	JS318	LR500516	JS349
LRB00481	CA1542IR	LR500190	CS109	LR500383	CS338	LR500517	JS395
LRB00482	CA1297IR	LR500192	CS90	LR500385	JS335	LR500518	JS327
LRB00483	CA1239IR	LR500195	CS703	LR500386	CS276	LR500521	CS297
LRB00484	CA1255IR	LR500196	CS587	LR500387	CS136	LR500522	CS282
LRB00485	CA1436IR	LR500202	CS308	LR500388	CS135	LR500523	CS340
LRB00486	CA1378IR	LR500203	CS94	LR500390	JS347	LR500525	CS588
LRB00487	JA1521IR	LR500206	CS77	LR500391	JS649	LR500526	CS393
LRB00488	CA1100IR	LR500208	CS83	LR500392	JS304	LR500527	CS364
LRB00489	CA1508IR	LR500209	CS261	LR500394	JS556	LR500528	CS295
LRB00490	JA1126IR	LR500212	CS200	LR500395	JS306	LR500529	CS379
LRB00492	CA1580IR	LR500214	JS310	LR500396	JS329	LR500530	CS385
LRB00493	CA1569IR	LR500215	CS107	LR500397	JS375	LR500531	CS338
LRB00494	CA1589IR	LR500217	JS330	LR500400	JS305	LR500533	CS317
LRB00497	CA1638IR	LR500226	JS335	LR500401	CS116	LR500534	CS188
LRB00499	JA1606IR	LR500227	JS303	LR500408	JS308	LR500536	CS691
LRB00500	JA1611IR	LR500229	CS292	LR500409	CS263	LR500538	CS116
LRB00501	JA1528IR	LR500231	CS126	LR500410	CS142	LR500539	CS579
LRB00502	CA1498IR	LR500231	CS94	LR500417	JS327	LR500540	CS116
LRB00503	CA1637IR	LR500232	CS201	LR500418	CS314	LR500541	CS528
LRB00504	CA1544IR	LR500233	CS687	LR500419	CS185	LR500542	CS364
LRB00505	CA1621IR	LR500234	CS1038	LR500429	JS651	LR500543	CS708
LRB00507	CA1572IR	LR500240	CS106	LR500430	CS321	LR500544	CS592
LRB00509	CA1575IR	LR500248	CS151	LR500435	CS186	LR500545	JS311
LRB00510	JA1608IR	LR500249	JS301	LR500437	CS272	LR500546	JS354
LRB00511	CA1626IR	LR500250	JS336	LR500438	JS771	LR500547	JS629
LRB00512	CA1549IR	LR500255	CS89	LR500439	JS344	LR500548	JS935
LRB00513	JA1605IR	LR500256	CS95	LR500440	CS720	LR500552	CS987
LRB00514	CA1257IR	LR500259	CS79	LR500443	CS368	LR500553	CS623
LRB00515	CA1581IR	LR500260	CS72	LR500445	CS363	LR500557	JS325
LRB00518	CA1541IR	LR500261	CS947	LR500446	CS275	LR500558	CS294
LRB00638	CA1668IR	LR500262	CS131	LR500447	CS275	LR500559	CS298
LRD00100	CG50	LR500266	JS333	LR500448	CS286	LR500560	CS294
LRD00101	CG52	LR500268	CS116	LR500450	CS396	LR500562	CS508
LRD00103	CG58	LR500269	CS266	LR500451	CS90	LR500563	CS268
LRD00109	CG19	LR500275	CS184	LR500452	CS529	LR500564	CS299
LRD00115	CG17	LR500279	JS331	LR500453	CS286	LR500565	CS395
LRD00116	CG16	LR500286	CS139	LR500455	CS325	LR500568	CS550
LRD00155	CG23K	LR500287	CS117	LR500456	CS156	LR500569	CS804
LRD00156	CG23K	LR500291	CS142	LR500458	CS355	LR500570	CS503
LR500101	CS19	LR500295	CS150	LR500459	CS326	LR500574	CS590
LR500102	CS18	LR500298	CS181	LR500460	CS317	LR500578	CS341
LR500103	CS21	LR500301	CS1032	LR500462	CS366	LR500580	JS337
LR500107	CS336	LR500302	CS701	LR500463	CS315	LR500582	CS95
LR500109	CS181	LR500304	CS337	LR500465	CS354	LR500589	CS344
LR500110	CS181	LR500308	CS165	LR500465	CS575	LR500591	CS376
LR500110	CS86	LR500309	CS170	LR500466	CS316	LR500592	CS390
LR500113	CS200	LR500310	CS169	LR500467	CS306	LR500593	CS275
LR500115	CS200	LR500319	JS307	LR500469	JS513	LR500598	CS306
LR500121	CS95	LR500320	JS343	LR500470	JS378	LR500599	JS312
LR500124	CS693	LR500322	JS303	LR500471	JS309	LR500600	JS381
LR500125	JS300	LR500323	CS130	LR500473	JS349	LR500601	JS345
LR500127	CS19	LR500324	CS123	LR500474	JS355	LR500604	JS373
LR500129	CS200	LR500328	CS155	LR500475	CS342	LR500605	JS380
LR500133	CS62	LR500329	CS168	LR500476	CS373	LR500606	JS331
LR500135	CS72	LR500330	CS163	LR500478	CS290	LR500607	JS316
LR500137	CS948	LR500331	CS128	LR500478	CS322	LR500608	JS388
LR500139	CS997	LR500332	CS154	LR500479	CS339	LR500609	JS385
LR500141	CS91	LR500333	CS321	LR500480	JS310	LR500610	JS377
LR500144	CS78	LR500334	JS351	LR500484	CS345	LR500611	CS331
LR500146	CS86	LR500336	JS342	LR500485	JS360	LR500612	CS579
LR500147	CS604	LR500338	JS322	LR500486	JS372	LR500613	CS1056
LR500148	CS127	LR500341	CS133	LR500490	JS330	LR500614	CS371
LR500150	CS397	LR500342	CS147	LR500491	JS372	LR500615	JS552
LR500151	CS200	LR500343	CS18	LR500492	CS561	LR500617	JS769
LR500155	CS949	LR500344	CS278	LR500493	JS338	LR500620	CS336
LR500156	CS591	LR500345	CS324	LR500495	JS360	LR500621	CS328
LR500157	CS705	LR500350	CS132	LR500496	JS371	LR500624	JS325
LR500163	CS613	LR500351	CS74	LR500499	CS359	LR500625	JS365
LR500168	CS86	LR500352	CS119	LR500500	JS674	LR500626	JS365
LR500170	CS946	LR500353	CS183	LR500502	JS379	LR500627	JS1000

O.E. NO.	HC-PARTS	O.E. NO.	HC-PARTS	O.E. NO.	HC-PARTS	O.E. NO.	HC-PARTS
LRS00627	JS640	LRS00736	CS972	LRS00860	CS710	LRS00993	CS1058
LRS00628	JS646	LRS00737	CS581	LRS00861	CS383	LRS00994	CS878
LRS00631	CS607	LRS00738	JS651	LRS00865	CS565	LRS00995	JS760
LRS00632	CS550	LRS00741	JS642	LRS00867	CS66	LRS00996	CS280
LRS00633	CS608	LRS00742	CS585	LRS00871	CS80	LRS00997	CS681
LRS00639	CS1173	LRS00743	CS554	LRS00874	CS362	LRS00999	CS791
LRS00640	CS983	LRS00744	CS576	LRS00875	CS154	LRS01012	JS932
LRS00641	CS983	LRS00745	CS625	LRS00878	CS98	LRS01019	CS531
LRS00644	CS1127	LRS00746	CS121	LRS00883	CS544	LRS01020	JS362
LRS00647	CS622	LRS00747	CS269	LRS00884	JS628	LRS01024	CS151
LRS00648	CS297	LRS00749	CS566	LRS00885	JS637	LRS01025	CS163
LRS00649	CS378	LRS00750	CS516	LRS00886	JS1146	LRS01032	CS957
LRS00650	CS361	LRS00751	CS594	LRS00887	JS648	LRS01035	CS799
LRS00651	CS278	LRS00752	JS626	LRS00888	JS1022	LRS01040	JS307
LRS00653	CS330	LRS00754	CS524	LRS00889	JS998	LRS01044	CS993
LRS00654	CS329	LRS00755	CS790	LRS00890	CS500	LRS01046	CS138
LRS00655	CS327	LRS00756	CS592	LRS00891	CS788	LRS01047	CS166
LRS00656	CS360	LRS00757	CS592	LRS00892	CS880	LRS01053	CS718
LRS00657	CS322	LRS00758	CS562	LRS00893	CS599	LRS01057	CS114
LRS00658	CS356	LRS00759	CS609	LRS00894	CS723	LRS01058	JS931
LRS00659	CS508	LRS00760	CS330	LRS00895	CS574	LRS01060	CS605
LRS00660	CS346	LRS00761	CS293	LRS00896	JS770	LRS01062	CS365
LRS00661	CS386	LRS00762	CS114	LRS00897	JS652	LRS01069	CS1173
LRS00662	CS358	LRS00764	CS881	LRS00898	CS519	LRS01070	CS363
LRS00663	CS351	LRS00765	CS595	LRS00899	CS610	LRS01071	CS697
LRS00664	CS504	LRS00766	CS617	LRS00903	JS323	LRS01075	CS1123
LRS00665	CS374	LRS00767	CS699	LRS00911	CS334	LRS01078	JS552
LRS00666	CS717	LRS00768	JS525	LRS00913	CS79	LRS01082	CS367
LRS00669	JS538	LRS00769	JS357	LRS00915	CS132	LRS01083	CS550
LRS00671	CS581	LRS00778	CS564	LRS00916	CS185	LRS01089	CS706
LRS00672	CS398	LRS00781	CS713	LRS00917	CS268	LRS01094	JS358
LRS00673	CS337	LRS00782	JS557	LRS00918	CS311	LRS01096	CS129
LRS00675	CS592	LRS00783	CS548	LRS00919	CS77	LRS01098	JS677
LRS00676	CS343	LRS00784	CS616	LRS00920	CS113	LRS01100	CS783
LRS00677	JS664	LRS00785	CS618	LRS00921	CS103	LRS01102	JS752
LRS00678	JS641	LRS00785	CS713	LRS00922	CS191	LRS01103	CS682
LRS00680	CS509	LRS00786	JS359	LRS00923	CS530	LRS01104	JS386
LRS00681	CS569	LRS00787	CS541	LRS00925	CS1443	LRS01105	JS679
LRS00682	CS392	LRS00788	CS357	LRS00925	CS391	LRS01108	JS676
LRS00683	CS372	LRS00788	CS685	LRS00928	CS99	LRS01111	JS522
LRS00684	JS628	LRS00789	JS633	LRS00929	CS101	LRS01113	JS365
LRS00688	JS640	LRS00790	CS683	LRS00930	CS97	LRS01119	JS779
LRS00689	JS563	LRS00791	CS619	LRS00932	CS335	LRS01120	JS731
LRS00692	JS356	LRS00792	CS551	LRS00934	CS333	LRS01122	US839
LRS00692	JS765	LRS00793	JS759	LRS00940	CS370	LRS01124	JS729
LRS00693	JS549	LRS00794	US811	LRS00944	CS795	LRS01125	JS1239
LRS00695	JS382	LRS00795	CS711	LRS00945	CS546	LRS01128	JS1145
LRS00696	JS663	LRS00796	CS726	LRS00946	CS232	LRS01129	JS734
LRS00697	CS536	LRS00799	CS688	LRS00949	CS995	LRS01131	JS895
LRS00698	CS348	LRS00801	CS180	LRS00960	CS501	LRS01132	CS783
LRS00704	JS672	LRS00806	CS74	LRS00961	CS387	LRS01133	JS673
LRS00706	CS889	LRS00808	CS119	LRS00962	CS388	LRS01136	JS353
LRS00707	CS609	LRS00810	CS166	LRS00963	CS377	LRS01137	JS678
LRS00708	CS610	LRS00814	CS81	LRS00964	CS598	LRS01139	JS394
LRS00709	CS589	LRS00816	CS188	LRS00965	CS960	LRS01140	JS362
LRS00710	JS627	LRS00817	CS194	LRS00966	CS789	LRS01143	JS362
LRS00711	JS891	LRS00818	CS120	LRS00967	JS1366	LRS01148	JS1232
LRS00712	CS722	LRS00819	CS198	LRS00967	JS671	LRS01150	JS1000
LRS00714	CS332	LRS00823	CS195	LRS00968	CS703	LRS01150	JS640
LRS00715	CS535	LRS00824	CS194	LRS00969	CS994	LRS01151	JS302
LRS00718	JS653	LRS00825	CS198	LRS00970	CS709	LRS01153	JS778
LRS00719	JS319	LRS00826	CS308	LRS00971	CS725	LRS01156	CS315
LRS00719	JS645	LRS00827	CS285	LRS00972	CS611	LRS01159	JS520
LRS00720	JS376	LRS00828	CS289	LRS00973	JS539	LRS01160	CS510
LRS00721	JS521	LRS00835	CS365	LRS00974	JS941	LRS01161	CS566
LRS00722	JS512	LRS00837	CS232	LRS00975	JS305	LRS01162	JS731
LRS00723	JS560	LRS00838	CS230	LRS00976	CS977	LRS01169	JS730
LRS00724	JS644	LRS00838	CS689	LRS00977	CS974	LRS01170	JS660
LRS00725	JS389	LRS00839	CS231	LRS00978	CS971	LRS01172	CS721
LRS00726	JS632	LRS00841	CS394	LRS00979	JS1004	LRS01173	US833
LRS00727	JS517	LRS00843	CS194	LRS00981	CS382	LRS01174	CS799
LRS00728	CS1201	LRS00845	CS526	LRS00984	CS380	LRS01176	JS732
LRS00729	CS389	LRS00847	CS240	LRS00985	CS1167	LRS01178	CS995
LRS00730	CS542	LRS00849	JS753	LRS00986	CS502	LRS01179	CS531
LRS00731	CS559	LRS00850	CS572	LRS00987	CS887	LRS01181	JS634
LRS00732	CS724	LRS00854	CS122	LRS00989	CS796	LRS01184	JS650
LRS00733	CS341	LRS00857	CS69	LRS00990	CS612	LRS01185	JS668
LRS00734	CS785	LRS00858	CS69	LRS00991	CS350	LRS01188	US835
LRS00735	CS684	LRS00860	CS506	LRS00992	CS719	LRS01189	JS1014

O.E. NO.	HC-PARTS	O.E. NO.	HC-PARTS	O.E. NO.	HC-PARTS	O.E. NO.	HC-PARTS
<b>LUCAS <i>Continued</i></b>							
LR01193	JS665	LR01362	JS926	LR01511	JS1084	LR01657	JS1300
LR01196	JS654	LR01363	JS1103	LR01512	JS906	LR01659	JS1218
LR01197	CS1031	LR01364	CS1052	LR01514	JS1157	LR01660	JS1302
LR01198	JS776	LR01365	CS707	LR01516	CS1272	LR01666	CS1264
LR01204	CS1030	LR01366	CS882	LR01517	CS1113	LR01667	JS1295
LR01211	CS584	LR01367	JS1140	LR01518	CS1194	LR01670	CS1343
LR01212	CS1046	LR01370	JS1104	LR01519	CS1115	LR01671	CS1322
LR01214	JS1019	LR01373	JS1003	LR01522	JS915	LR01672	CS1286
LR01216	CS535	LR01375	CS1033	LR01525	CS1210	LR01673	CS1293
LR01217	JS373	LR01376	JS925	LR01527	CS1190	LR01674	CS1323
LR01218	JS756	LR01378	JS1101	LR01537	CS784	LR01676	CS1294
LR01220	JS759	LR01381	JS1017	LR01540	CS1187	LR01677	CS1287
LR01222	CS712	LR01382	CS378	LR01542	JS1320	LR01684	JS1229
LR01223	CS991	LR01383	CS787	LR01545	CS1255	LR01686	CS1291
LR01224	JS1095	LR01384	US844	LR01547	JS897	LR01689	JS1237
LR01225	JS734	LR01385	CS782	LR01548	CS1055	LR01693	JS914
LR01226	JS520	LR01386	CS1074	LR01551	JS1321	LR01695	JS1227
LR01227	JS558	LR01387	JS929	LR01552	CS1249	LR01698	CS1247
LR01230	US843	LR01388	JS940	LR01553	JS1008	LR01700	CS1289
LR01232	CS620	LR01389	CS1165	LR01554	CS1290	LR01701	CS1283
LR01234	JS1103	LR01390	JS527	LR01555	JS1016	LR01702	CS1281
LR01237	JS745	LR01393	JS533	LR01556	CS1125	LR01703	CS1247
LR01238	JS1151	LR01394	CS1072	LR01559	CS784	LR01706	CS1405
LR01238	JS648	LR01398	US810	LR01563	CS1376	LR01708	CS1189
LR01239	JS936	LR01400	CS786	LR01564	CS1209	LR01709	CS1395
LR01246	CS1032	LR01401	US970	LR01566	CS1174	LR01712	JS1355
LR01250	CS1035	LR01402	JS1011	LR01566	CS1276	LR01713	JS1317
LR01253	JS670	LR01403	US809	LR01567	JS1234	LR01714	JS1296
LR01254	JS1011	LR01405	US812	LR01568	JS1356	LR01715	CS1439
LR01256	JS1012	LR01408	US845	LR01569	CS1260	LR01716	CS1444
LR01261	JS911	LR01412	US859	LR01571	CS1193	LR01717	CS1275
LR01265	JS766	LR01414	JS1154	LR01574	JS1235	LR01723	JS640
LR01268	JS773	LR01417	CS1071	LR01575	CS1241	LR01724	CS1445
LR01274	US860	LR01418	US866	LR01578	CS1192	LR01726	CS1379
LR01275	US858	LR01422	CS1185	LR01579	CS1177	LR01729	CS1344
LR01280	JS1086	LR01426	JS735	LR01580	CS1471	LR01732	CS1263
LR01281	JS937	LR01427	CS888	LR01581	CS885	LR01733	JS1151
LR01283	JS895	LR01430	CS1210	LR01582	CS1213	LR01735	CS1324
LR01286	US832	LR01431	CS1191	LR01586	CS1192	LR01737	CS1329
LR01287	JS933	LR01434	CS1340	LR01587	CS1131	LR01738	CS1288
LR01291	CS583	LR01436	JS1351	LR01591	JS1088	LR01739	JS1316
LR01293	JS767	LR01437	CS978	LR01592	CS1198	LR01740	JS1315
LR01294	JS1102	LR01438	JS1152	LR01593	CS1273	LR01743	JS1312
LR01295	JS762	LR01439	CS515	LR01594	CS1195	LR01744	CS1436
LR01297	JS942	LR01442	JS905	LR01595	US877	LR01745	CS1492
LR01298	JS762	LR01446	JS1147	LR01596	CS784	LR01753	JS1306
LR01300	CS1069	LR01448	CS1064	LR01599	CS1211	LR01756	JS1353
LR01302	CS1073	LR01451	JS1220	LR01601	JS1216	LR01757	CS66
LR01304	CS784	LR01452	JS1299	LR01602	CS1440	LR01764	CS323
LR01306	JS1096	LR01453	JS1303	LR01605	CS1208	LR01766	CS300
LR01309	JS1094	LR01454	JS1297	LR01606	CS882	LR01767	CS514
LR01310	JS924	LR01457	CS1185	LR01607	JS643	LR01768	JS628
LR01312	JS1239	LR01459	CS1455	LR01610	CS1282	LR01771	CS300
LR01316	JS780	LR01460	JS1139	LR01621	JS1310	LR01774	CS578
LR01317	JS931	LR01461	CS1206	LR01622	CS1205	LR01776	CS958
LR01318	JS897	LR01462	CS1266	LR01623	JS1298	LR01777	CS1041
LR01319	JS728	LR01464	US867	LR01624	CS201	LR01779	CS965
LR01321	JS737	LR01465	CS1390	LR01625	CS1244	LR01780	CS615
LR01322	CS1126	LR01468	JS1009	LR01626	JS1239	LR01781	US830
LR01323	CS979	LR01470	JS927	LR01627	CS1336	LR01785	US810
LR01324	JS942	LR01471	CS1203	LR01630	JS1230	LR01788	US969
LR01326	CS337	LR01472	JS1313	LR01632	CS1179	LR01789	CS1258
LR01327	US840	LR01473	JS1015	LR01634	US842	LR01791	CS1265
LR01328	JS1221	LR01474	CS1125	LR01635	JS1305	LR01792	CS1395
LR01335	CS1076	LR01475	CS1171	LR01637	CS1126	LR01794	US1240
LR01336	CS794	LR01478	JS928	LR01638	CS1271	LR01795	CS985
LR01340	JS632	LR01479	JS1233	LR01639	CS1250	LR01797	US832
LR01343	JS1159	LR01481	JS357	LR01640	CS1252	LR01799	CS1256
LR01344	JS907	LR01483	JS1143	LR01641	CS1477	LR01800	US1240
LR01345	CS1170	LR01484	CS395	LR01642	JS1225	LR01801	CS1328
LR01348	JS643	LR01486	CS511	LR01644	JS647	LR01802	CS700
LR01351	JS1352	LR01489	JS1138	LR01646	CS1258	LR01806	CS194
LR01352	JS938	LR01491	JS1141	LR01647	CS1204	LR01807	CS955
LR01354	JS1020	LR01492	JS1238	LR01648	CS519	LR01811	JS656
LR01356	JS781	LR01493	CS694	LR01650	CS353	LR01812	CS955
LR01357	CS1051	LR01499	CS1202	LR01651	JS1305	LR01829	US827
LR01359	US828	LR01507	CS1246	LR01652	JS999	LR01833	CS1127
LR01360	JS909	LR01509	JS1236	LR01655	JS1304	LR01835	JS904
LR01361	JS1136	LR01510	CS1106	LR01656	JS1313	LR01840	JS666

O.E. NO.	HC-PARTS	O.E. NO.	HC-PARTS	O.E. NO.	HC-PARTS	O.E. NO.	HC-PARTS
LRSo1842	JS777	LRSo2036	JS534	LRSo2133	CS614	LRSo2267	JS1361
LRSo1843	JS553	LRSo2037	CS328	LRSo2134	CS1166	LRSo2268	CS1380
LRSo1849	CS349	LRSo2038	CS500	LRSo2135	CS547	LRSo2269	CS1387
LRSo1859	CS805	LRSo2039	CS600	LRSo2136	CS389	LRSo2272	CS1399
LRSo1861	JS1087	LRSo2040	CS685	LRSo2138	CS514	LRSo2273	CS1400
LRSo1862	CS384	LRSo2041	JS1005	LRSo2139	CS1078	LRSo2274	CS1388
LRSo1863	JS655	LRSo2042	JS1001	LRSo2141	CS546	LRSo2275	CS1391
LRSo1881	JS733	LRSo2043	JS763	LRSo2143	CS99	LRSo2279	CS1417
LRSo1890	CS698	LRSo2045	CS693	LRSo2144	CS232	LRSo2280	CS1481
LRSo1891	CS962	LRSo2046	JS627	LRSo2146	CS121	LRSo2281	CS1457
LRSo1892	CS1039	LRSo2047	JS916	LRSo2149	CS506	LRSo2283	CS1264
LRSo1893	JS1021	LRSo2052	JS1137	LRSo2151	CS383	LRSo2286	CS1493
LRSo1896	CS1331	LRSo2053	JS657	LRSo2152	CS608	LRSo2287	CS1448
LRSo1897	CS1061	LRSo2054	JS919	LRSo2153	CS1443	LRSo2289	CS1403
LRSo1899	CS1129	LRSo2055	JS1000	LRSo2154	CS120	LRSo2290	CS1278
LRSo1903	CS1169	LRSo2055	JS640	LRSo2155	CS191	LRSo2292	CS1336
LRSo1905	JS1010	LRSo2056	JS893	LRSo2156	CS502	LRSo2295	CS1276
LRSo1906	CS1163	LRSo2058	JS652	LRSo2157	CS1279	LRSo2295	CS1407
LRSo1907	CS1077	LRSo2059	CS585	LRSo2158	CS1112	LRSo2297	CS1451
LRSo1908	CS595	LRSo2060	CS709	LRSo2160	JS1352	LRSo2298	CS1412
LRSo1910	JS1010	LRSo2061	CS562	LRSo2162	JS1097	LRSo2299	CS1413
LRSo1925	JS1354	LRSo2062	CS972	LRSo2164	JS1357	LRSo2303	JS1355
LRSo1929	CS1199	LRSo2064	CS1162	LRSo2165	JS1098	LRSo2304	CS1415
LRSo1930	CS1161	LRSo2065	JS394	LRSo2167	JS1098	LRSo2305	CS1433
LRSo1932	CS1178	LRSo2066	JS1080	LRSo2168	CS1334	LRSo2307	CS1424
LRSo1934	JS1217	LRSo2068	JS920	LRSo2171	CS1377	LRSo2309	JS1365
LRSo1937	CS1261	LRSo2069	JS1366	LRSo2173	CS1428	LRSo2310	CS1442
LRSo1938	CS1274	LRSo2070	JS560	LRSo2174	CS1347	LRSo2311	CS1338
LRSo1942	CS1248	LRSo2071	CS1053	LRSo2175	CS1474	LRSo2312	JS1365
LRSo1943	CS1243	LRSo2072	JS670	LRSo2178	CS506	LRSo2314	CS1431
LRSo1946	US827	LRSo2073	CS884	LRSo2181	JS1364	LRSo2317	CS1438
LRSo1948	CS1128	LRSo2074	CS554	LRSo2183	JS1359	LRSo2318	CS1449
LRSo1949	CS797	LRSo2075	CS709	LRSo2184	CS606	LRSo2322	CS1386
LRSo1950	CS1348	LRSo2078	CS727	LRSo2186	JS1349	LRSo2323	CS1402
LRSo1954	CS1464	LRSo2080	JS1307	LRSo2187	CS1446	LRSo2325	CS1419
LRSo1957	CS1383	LRSo2081	JS1085	LRSo2189	CS1054	LRSo2327	CS1435
LRSo1958	CS1292	LRSo2082	JS774	LRSo2190	JS340	LRSo2328	JS737
LRSo1959	CS1284	LRSo2083	CS559	LRSo2191	CS1068	LRSo2331	CS1398
LRSo1960	CS1168	LRSo2084	CS879	LRSo2193	JS1358	LRSo2333	CS1453
LRSo1961	CS1269	LRSo2085	JS1089	LRSo2194	CS1411	LRSo2335	CS1423
LRSo1964	CS1473	LRSo2087	JS902	LRSo2196	CS1392	LRSo2336	CS1488
LRSo1965	JS1358	LRSo2088	CS543	LRSo2197	CS1394	LRSo2338	CS1342
LRSo1966	JS1366	LRSo2089	CS286	LRSo2198	CS1393	LRSo2339	CS1454
LRSo1967	CS1172	LRSo2090	CS326	LRSo2200	JS1311	LRSo2340	CS1395
LRSo1968	CS1332	LRSo2091	CS1044	LRSo2205	CS1067	LRSo2341	CS1420
LRSo1970	CS1243	LRSo2092	JS309	LRSo2207	JS314	LRSo2342	JS1368
LRSo1972	CS1267	LRSo2094	JS917	LRSo2208	CS1339	LRSo2345	CS1505
LRSo1974	CS198	LRSo2095	CS796	LRSo2212	CS1454	LRSo2349	CS1271
LRSo1976	CS572	LRSo2096	JS1150	LRSo2213	CS879	LRSo2352	CS1401
LRSo1983	CS140	LRSo2097	JS380	LRSo2215	JS659	LRSo2353	CS1425
LRSo1985	CS503	LRSo2098	CS575	LRSo2216	JS1319	LRSo2356	CS1482
LRSo1987	CS140	LRSo2099	JS1135	LRSo2217	JS1155	LRSo2365	CS322
LRSo1988	CS503	LRSo2100	CS594	LRSo2218	JS1009	LRSo2370	CS1414
LRSo1990	CS523	LRSo2102	CS589	LRSo2219	CS1341	LRSo2374	CS1447
LRSo1993	CS591	LRSo2104	CS796	LRSo2220	CS1409	LRSo2377	CS1410
LRSo1996	CS342	LRSo2105	CS327	LRSo2223	CS1389	LRSo2380	JS1308
LRSo2000	CS162	LRSo2106	CS581	LRSo2224	CS1406	LRSo2382	CS1487
LRSo2001	JS670	LRSo2107	CS1183	LRSo2225	JS1318	LRSo2383	JS1360
LRSo2003	CS548	LRSo2108	CS684	LRSo2226	CS1416	LRSo2387	CS1430
LRSo2007	CS267	LRSo2109	CS680	LRSo2227	CS1333	LRSo2390	CS1450
LRSo2008	CS386	LRSo2110	JS1219	LRSo2228	CS331	LRSo2393	US1028
LRSo2010	JS307	LRSo2111	CS1059	LRSo2230	CS1427	LRSo2399	JS1362
LRSo2011	CS716	LRSo2112	CS1326	LRSo2231	JS1367	LRSo2401	CS1432
LRSo2013	CS275	LRSo2113	JS913	LRSo2233	JS1144	LRSo2404	CS1509
LRSo2014	CS570	LRSo2114	JS349	LRSo2242	CS335	LRSo2410	CS1329
LRSo2017	CS353	LRSo2115	CS1257	LRSo2243	CS1421	LRSo2476	CS1480
LRSo2018	JS364	LRSo2116	CS788	LRSo2244	CS1384	LRT00100	JS658
LRSo2019	CS535	LRSo2117	CS719	LRSo2246	CS1422	LRT00101	CS886
LRSo2022	JS631	LRSo2120	JS335	LRSo2249	CS1408	LRT00102	CS1175
LRSo2024	CS78	LRSo2121	CS690	LRSo2250	CS696	LRT00103	JS1006
LRSo2025	CS518	LRSo2122	CS622	LRSo2252	CS1346	LRT00104	JS568
LRSo2026	JS1092	LRSo2125	CS268	LRSo2253	CS1460	LRT00105	JS1314
LRSo2027	JS645	LRSo2126	CS79	LRSo2256	JS1309	LRT00106	JS1214
LRSo2028	CS360	LRSo2127	CS292	LRSo2257	CS1426	LRT00107	CS879
LRSo2029	JS661	LRSo2128	JS646	LRSo2258	CS1164	LRT00108	CS885
LRSo2030	JS632	LRSo2129	JS394	LRSo2261	JS1363	LRT00110	CS798
LRSo2031	CS555	LRSo2130	CS357	LRSo2263	CS1377	LRT00111	JS747
LRSo2033	CS597	LRSo2131	CS528	LRSo2264	CS1456	LRT00114	JS639
LRSo2034	CS577	LRSo2132	CS559	LRSo2265	JS1369	LRT00115	CS802

O.E. NO.	HC-PARTS	O.E. NO.	HC-PARTS	O.E. NO.	HC-PARTS	O.E. NO.	HC-PARTS
LUCAS <i>Continued</i>							
LRT00116.....	CS680	LRT00204.....	JS922	50246416.....	CS350	63111043.....	CS1075
LRT00117.....	CS961	LRT00205.....	CS1117	50246532.....	CS536	63112003.....	CS1037
LRT00118.....	JS894	LRT00206.....	JS1226	50246648.....	CS975	063112003.....	CS1037
LRT00119.....	CS1067	LRT00207.....	CS610	054022379.....	CA582IR	63113001.....	CS1265
LRT00120.....	JS890	LRT00208.....	CS1253	054022474.....	CA560IR	63113002.....	CS1045
LRT00121.....	CS727	LRT00212.....	JS1023	054022599.....	CA594IR	63113003.....	CS1212
LRT00123.....	JS1149	LRT00213.....	JS1024	054022600.....	CA562IR	063113003.....	CS1212
LRT00124.....	CS684	LRT00214.....	JS1018	054022601.....	CA1692IR	63114008.....	CS1124
LRT00125.....	JS1016	LRT00215.....	JS1223	054022602.....	CA717IR	63114010.....	CS1124
LRT00125.....	JS1079	LRT00216.....	JS1224	054022628.....	CA306IR	063114010.....	CS1124
LRT00126.....	CS542	LRT00217.....	CS1114	054022636.....	CA600IR	63114014.....	CS1109
LRT00127.....	JS902	LRT00218.....	CS1181	054022638.....	CA627IR	063114014.....	CS1109
LRT00128.....	CS621	LRT00219.....	CS1047	054022639.....	CA1346IR	63114017.....	CS1171
LRT00129.....	JS918	LRT00220.....	CS1197	054022639.....	CA564IR	63191001.....	JS1156
LRT00130.....	CS1065	LRT00221.....	CS1200	054022640.....	CA627IR	63191007.....	CS1206
LRT00131.....	JS1091	LRT00222.....	JS999	054022642.....	CA564IR	063191007.....	CS1206
LRT00132.....	CS973	LRT00223.....	CS1188	054022643.....	CA600IR	63192000.....	JS1142
LRT00133.....	CS801	LRT00224.....	JS1158	054022646.....	CA627IR	063192000.....	JS1142
LRT00134.....	CS1044	LRT00225.....	CS1112	054022647.....	CA1346IR	63193001.....	CS1265
LRT00135.....	CS989	LRT00226.....	CS1048	054022649.....	CA564IR	63201000.....	CS308
LRT00136.....	CS689	LRT00227.....	CS793	054022652.....	CA560IR	63201004.....	CS308
LRT00137.....	CS120	LRT00228.....	CS792	054022656.....	CA1494IR	63201005.....	CS308
LRT00138.....	CS1118	LRT00229.....	CS990	54022720.....	CA1031IR	63201100.....	CS308
LRT00139.....	CS976	LRT00234.....	CS1254	54022720.....	CA719IR	63216703.....	CS394
LRT00140.....	CS982	LRT00235.....	CS1179	63101000.....	CS1068	63216725.....	CS232
LRT00141.....	CS964	LRT00236.....	CS1186	63101002.....	CS796	63216726.....	CS232
LRT00142.....	CS1055	LRT00237.....	CS1174	63101003.....	CS1125	63216727.....	CS232
LRT00143.....	CS1057	LRT00240.....	CS1207	63101007.....	CS1206	63216731.....	CS232
LRT00144.....	CS963	LRT00242.....	CS1337	63101008.....	CS1125	63216740.....	CS394
LRT00145.....	CS800	LRT00243.....	CS1176	63101015.....	CS1192	63216741.....	CS394
LRT00146.....	CS981	LRT00244.....	JS1236	63101018.....	CS1192	63216747.....	CS232
LRT00147.....	CS975	LRT00250.....	CS1132	063101018.....	CS1192	63216748.....	CS232
LRT00148.....	CS1042	LRT00251.....	CS1196	63101021.....	CS1379	63216800.....	CS240
LRT00149.....	CS992	LRT00600.....	CS695	63101022.....	CS1125	63216814.....	CS335
LRT00150.....	CS1037	LRT00601.....	CS696	63101023.....	CS1125	63216815.....	CS333
LRT00154.....	JS1142	LRT00602.....	CS702	63102000.....	JS1142	63216825.....	CS240
LRT00155.....	JS1156	LRT00603.....	CS696	63102003.....	CS981	63216826.....	CS240
LRT00156.....	JS667	LRT00604.....	CS697	063102003.....	CS981	63216827.....	CS240
LRT00157.....	JS540	LRT00605.....	CS694	63102004.....	CS1068	63216831.....	CS240
LRT00158.....	JS901	LRT00608.....	CS953	63102007.....	CS796	063216831.....	CS240
LRT00159.....	CS372	LRT00609.....	CS697	63102008.....	CS800	63216851.....	CS333
LRT00160.....	CS588	LRT00610.....	CS700	63102018.....	CS1192	063216851.....	CS333
LRT00161.....	CS515	LRT00613.....	CS349	63102018.....	CS1192	63216874.....	CS240
LRT00163.....	CS1396	LRT00614.....	CS698	63102020.....	CS1192	63216876.....	CS335
LRT00165.....	CS986	LRT00616.....	CS953	63102020.....	CS1192	063216876.....	CS335
LRT00166.....	CS1066	LRT00618.....	CS695	063102020.....	CS1192	63216884.....	CS335
LRT00167.....	CS1050	LRT00642.....	CS696	63102021.....	CS1125	063216884.....	CS335
LRT00168.....	JS939	NAB300.....	CA1459IR	63102021.....	CS1125	63216896.....	CS682
LRT00169.....	CS1049	NAB301.....	CA1460IR	063102021.....	CS1125	63217106.....	CS996
LRT00170.....	CS378	NAB302.....	CA1461IR	63102022.....	CS1379	63217126.....	CS572
LRT00172.....	CS988	NAB303.....	CA1462IR	063102022.....	CS1379	63217126.....	CS572
LRT00173.....	CS1063	NAB304.....	CA1463IR	63103002.....	CS975	63217147.....	CS230
LRT00174.....	CS1060	NAB305.....	CA1464IR	063103002.....	CS975	063217148.....	CS230
LRT00175.....	CS519	NAB306.....	CA1465IR	63103003.....	CS1043	063217154.....	CS289
LRT00176.....	CS337	NAB307.....	CA1466IR	63103007.....	CS975	63217163.....	CS996
LRT00177.....	CS1062	NAB900.....	CA1457IR	63103008.....	CS1043	63217201.....	CS231
LRT00178.....	CS1119	NAB900M.....	CA1550IR	63103015.....	CS1192	63217225.....	CS231
LRT00179.....	CS974	NAB901.....	CA1468IR	63103019.....	JS512	63217226.....	CS231
LRT00181.....	JS912	NAB902.....	CA1467IR	63103022.....	CS975	63220505.....	CS166
LRT00182.....	JS1135	NAB903.....	CA1458IR	063103022.....	CS975	63220536.....	CS380
LRT00183.....	JS1083	NAB904.....	CA1479IR	63103023.....	CS1043	63220537.....	CS90
LRT00184.....	JS1350	NAB905.....	CA1469IR	63103024.....	CS1192	63220538.....	CS147
LRT00185.....	CS1124			63103024.....	CS1192	63220700.....	CS141
LRT00186.....	CS1270	MAGNETI MARELLI		63103025.....	CS800	63220701.....	CS91
LRT00187.....	CS1160	MAR5009.....	CA617IR	63103031.....	CS1379	63220703.....	CS90
LRT00188.....	CS1109	MAR5029.....	CA730IR	63111000.....	CS1195	63220704.....	CS147
LRT00189.....	CS1210	MAR5032.....	CA1098IR	63111001.....	JS1156	63220705.....	CS141
LRT00190.....	CS879	MAR5043.....	CA1039IR	63111005.....	CS1042	63220706.....	CS363
LRT00191.....	CS519	MAR5161.....	CA640IR	63111006.....	CS1067	63220721.....	CS91
LRT00194.....	CS681	MAR5164.....	CA716IR	63111007.....	CS1042	63220724.....	CS147
LRT00195.....	CS611	MAR5651.....	CA1442IR	63111008.....	CS1191	63220734.....	CS147
LRT00196.....	CS1180	MAR5713.....	CA1080IR	63111010.....	CS1191	63220741.....	CS91
LRT00197.....	CS1111	MAR6003.....	CA533IR	63111016.....	CS1191	63220743.....	CS90
LRT00198.....	CS796	MAR6200.....	CA1079IR	63111017.....	CS1043	63220901.....	CS396
LRT00199.....	CS1045	MAR6223.....	CA1065IR	63111018.....	CS1191	063220931.....	CS396
LRT00200.....	CS1212	MAR7076.....	CA1444IR	63111019.....	CS1191	63221300.....	CS133
LRT00201.....	CS715	MAR7511.....	JA1172IR	63111023.....	CS1075	63221302.....	CS131
LRT00202.....	CS1245	06322908.....	CS141	63111036.....	CS1191	63221303.....	CS180
LRT00203.....	JS923	50246218.....	CS282	63111037.....	CS1191		

O.E. NO.	HC-PARTS	O.E. NO.	HC-PARTS	O.E. NO.	HC-PARTS	O.E. NO.	HC-PARTS
63221304	CS77	63222936	CS796	063280044	CS1379	63307430	CA129IR
63221305	CS293	63223031	CS536	063280045	CS1346	63307431	CA252IR
63221308	CS184	63223033	CS536	063280046	CS1379	63307503	CA351IR
63221330	CS133	63223034	CS711	063280048	JS1362	63307506	CA316IR
063221330	CS133	63223035	CS536	063280050	JS1302	63307526	CA316IR
63221333	CS180	63223039	CS788	063280051	JS1080	63307604	CA254IR
063221333	CS180	63223085	CS883	063280052	JS1088	63307801	CA506IR
63221400	CS275	063223085	CS883	063280057	CS1499	63307802	CA355IR
63221401	CS285	063223101	CS536	063280059	JS1369	63307805	CA709
63221403	CS275	63223101	CS975	63280071	CS1473	63308300	CA212IR
63221404	CS379	063223101	CS975	063280072	CS1413	63308701	CA307IR
63221408	CS334	63223103	CS610	063280090	CS1342	063310508	CA1643IR
63221431	CS285	63223104	CS610	63280901	JS1311	063310509	CA1444IR
063221431	CS285	63223106	JS1142	063280901	JS1311	63320001	CA350IR
63221433	CS275	63223108	CS1052	063280902	JS1312	63320002	CA307IR
063221433	CS275	063223108	CS1052	63291405	CS310	63320003	CA1435IR
63221437	CS77	63223109	CS1076	63293039	CS788	63320004	CA252IR
63221500	CS368	63223182	CS579	063293103	CS610	63320005	CA127IR
63221530	CS368	63223200	CS796	63293537	CS1067	63320006	CA127IR
63221532	CS529	63223203	CS286	63293538	CS971	63320007	CA1435IR
63221533	CS364	63223236	CS286	063293538	CS971	63320008	CA1435IR
63221534	CS168	63223237	CS286	063296842	CS511	63320010	CA351IR
63221535	CS293	63223303	CS883	63300506	CA45	63320012	CA363IR
63221538	CS393	63223304	JS901	63300515	CA233IR	63320013	CA601IR
63221539	CS393	63223330	CS286	63300521	CA45	63320016	CA254IR
63221630	CS717	63223332	CS286	63300802	CA77IR	63320018	CA506IR
63221632	CS275	63223430	CS364	63300900	CA77IR	63320020	CA601IR
63221637	CS536	063223430	CS364	63300901	CA77IR	63320021	CA255IR
63221639	CS393	63223431	CS584	63300902	CA46IR	63320022	CA641IR
63221731	CS393	63223432	CS514	63300905	CA233IR	63320023	CA316IR
63221800	CS371	63223433	CS377	63300920	CA77IR	63320024	CA642IR
63221801	CS376	63223434	CS282	63300921	CA77IR	63320025	CA212IR
63221830	CS371	63223435	CS516	63303191	CA120	63320026	CA506IR
63221831	CS376	63223436	CS584	63303502	CA307IR	63320028	CA252IR
63221832	CS344	063223436	CS584	63303581	CA129IR	63320030	CA351IR
063221832	CS344	63223438	CS725	63303610	CA252IR	63320031	CA1435IR
63221834	CS963	63223530	CS584	63303701	CA307IR	63320032	CA506IR
063221834	CS963	063223530	CS584	63303702	CA127IR	63320034	CA572IR
63221890	CS371	63223531	CS584	63303703	CA307IR	63320035	CA254IR
63221892	CS344	063223531	CS584	63303780	CA119IR	63320037	CA631IR
63222000	CS504	63223532	CS965	63304800	CA120	63320040	CA851IR
63222001	CS351	63223536	CS1191	63305100	CA119IR	63320042	CA506IR
63222005	CS1171	63223537	CS1067	63305101	CA127IR	63320044	CA506IR
63222030	CS504	63223538	CS971	63305130	CA119IR	63320045	CA504IR
63222031	CS351	63223538	CS971	63305131	CA127IR	63320046	CA506IR
63222034	CS554	63223639	CS1195	63305206	CA255IR	63320047	CA252IR
063222034	CS554	63223730	CS1042	63305236	CA255IR	63320048	CA596IR
63222035	CS378	63224580	CS232	63305401	CA252IR	63320049	CA355IR
63222036	CS376	63224600	CS240	63305404	CA129IR	63320053	CA1435IR
63222038	CS709	063226722	CS579	63305506	CA316IR	63320055	CA834IR
63222039	CS351	063226836	CS786	63305526	CA316IR	63320056	CA252IR
63222130	CS504	063226837	CS787	63305606	CA316IR	63320058	CA623IR
63222131	CS992	063226842	CS1056	63305690	CA363IR	63320060	CA212IR
63222133	CS376	063226845	JS627	63305700	CA235IR	63320073	CA252IR
63222134	CS709	063227034	CS610	063305720	CA235IR	63320082	CA596IR
63222135	CS709	063227413	CS705	63305722	CA124IR	63320083	CA596IR
63222136	CS351	063227421	CS109	63305800	CA300IR	63320091	CA822IR
63222138	CS554	063227460	CS590	63305801	CA506IR	63320094	CA893IR
63222204	CS1170	063227486	CS693	63305802	CA355IR	63320100	CA316IR
063222204	CS1170	063227502	CS703	63306000	CA212IR	63320105	CA506IR
63222206	CS992	063227528	CS987	63306300	CA212IR	63320111	CA851IR
63222405	CS139	063227543	CS701	63306301	CA212IR	63320112	CA129IR
63222408	CS139	063227593	CS1032	63306302	CA212IR	63320121	CA506IR
63222438	CS139	063227601	CS623	63306701	CA307IR	63320122	CA851IR
63222506	CS139	63230001	CS610	63307100	CA119IR	63320124	CA1849IR
63222831	CS536	063280005	CS1107	63307101	CA127IR	63320125	CA1435IR
63222836	CS1038	063280010	CS1050	63307105	CA127IR	63320126	CA601IR
63222837	CS1038	063280021	CS1275	63307106	CA307IR	63320127	CA1435IR
63222888	CS796	063280022	CS1245	63307108	CA307IR	63320128	CA129IR
63222889	CS796	063280023	CS1246	63307131	CA127IR	63320129	CA506IR
63222897	CS1038	063280027	CS1403	63307206	CA255IR	63320130	CA252IR
63222900	CS800	063280028	CS1402	63307207	CA255IR	63320132	CA596IR
63222901	CS1043	063280029	CS1341	63307208	CA255IR	63320137	CA1849IR
63222904	CS981	063280031	CA1426	63307400	CA129IR	63320140	CA851IR
63222905	CS1038	063280032	CS961	63307401	CA252IR	63320141	CA129IR
063222905	CS1038	063280034	CS1336	63307402	CA363IR	63320277	CA1221IR
63222908	CS1038	063280036	CS1377	63307405	CA129IR	63320289	CA1380IR
63222909	CS1076	63280042	CS1379	63307406	CA351IR	63320305	CA1348IR
063222909	CS1076	063280042	CS1379	63307407	CA129IR	63320309	CA1100IR

O.E. NO.	HC-PARTS	O.E. NO.	HC-PARTS	O.E. NO.	HC-PARTS	O.E. NO.	HC-PARTS
<b>MAGNETI MARELLI <i>Continued</i></b>							
63320310	CA1252IR	063321165	CA893IR	63321348	JA1175IR	63321620	CA1565IR
63320315	CA1380IR	63321170	CA889IR	63321349	CA1208IR	63321620	CA1565IR
63320317	CA1651IR	063321173	CA851IR	63321351	CA1100IR	63321625	CA1196IR
63320333	CA1189IR	63321173	CA851IR	63321352	CA1252IR	63321626	CA1349IR
63320511	CA1084IR	63321178	CA317IR	63321353	CA1380IR	63321626	CA1349IR
63321000	CA350IR	63321180	CA316IR	63321355	CA1189IR	63321629	CA1350IR
063321000	CA350IR	063321191	CA1435IR	63321355	CA1216IR	63321629	CA1350IR
63321001	CA307IR	63321197	CA129IR	63321356	JA1174IR	63321631	CA1453IR
63321003	CA252IR	63321198	CA572IR	63321358	CA1191IR	63321636	CA1488IR
63321005	CA252IR	63321199	CA601IR	63321361	CA1258IR	63321640	CA1313IR
63321006	CA127IR	063321199	CA601IR	63321362	CA1084IR	63321641	CA618IR
63321008	CA129IR	63321200	CA890IR	63321367	CA1084IR	63321658	CA1625IR
063321011	CA129IR	63321200	CA890IR	63321389	CA1218IR	63321658	CA1734IR
63321011	CA1435IR	63321200	CA890IR	63321391	CA1348IR	63321660	CA1084IR
63321015	CA351IR	63321200	CA890IR	063321391	CA1348IR	63321661	CA1084IR
63321017	CA601IR	63321200	CA890IR	63321395	CA1233IR	63321666	CA1083IR
63321021	CA355IR	63321204	CA1084IR	63321398	CA1218IR	63321669	CA1217IR
063321021	CA355IR	63321205	CA1258IR	63321402	CA1222IR	63321671	CA1305IR
63321022	CA355IR	63321227	CA1199IR	063321402	CA1222IR	63321678	CA1483IR
63321023	CA254IR	63321229	CA1348IR	63321405	CA1348IR	63321679	CA1340IR
063321023	CA254IR	63321231	CA1233IR	63321409	CA1435IR	63321691	CA1217IR
63321028	CA1435IR	063321231	CA1233IR	063321409	CA1435IR	63321692	JA1174IR
63321031	CA355IR	63321232	CA1223IR	63321412	CA1311IR	63321693	JA1175IR
63321036	CA255IR	63321233	CA890IR	63321418	CA1223IR	63321695	CA1083IR
63321037	CA255IR	63321234	CA1153IR	63321419	CA1189IR	63321702	CA1625IR
063321039	CA641IR	63321235	CA1154IR	63321421	CA1230IR	63321702	CA1734IR
63321039	CA641IR	63321237	CA1199IR	63321422	CA1085IR	63321704	JA1174IR
63321041	CA316IR	63321238	CA1318IR	63321423	CA1216IR	63321705	JA1175IR
63321042	CA642IR	63321239	CA1487IR	63321424	CA1849IR	63321711	CA1649IR
63321044	CA642IR	63321239	CA1487IR	63321425	CA1083IR	63321712	CA890IR
063321044	CA642IR	63321241	CA1208IR	63321426	CA1451IR	63321713	CA1647IR
63321045	CA212IR	63321243	CA1380IR	63321434	CA1651IR	63321715	CA1350IR
63321050	CA212IR	63321244	CA1217IR	63321436	CA1189IR	063321715	CA1350IR
63321055	CA212IR	63321245	CA1311IR	63321453	CA1199IR	63321718	CA1766IR
63321056	CA506IR	63321246	CA1208IR	63321458	CA1849IR	63321723	CA715IR
63321057	CA317IR	63321251	CA1084IR	63321461	CA1437IR	63321724	CA1217IR
63321059	CA313IR	63321252	CA1196IR	63321465	CA1085IR	63321727	CA1488IR
063321060	CA351IR	63321253	CA1219IR	63321473	CA1085IR	63321729	CA1743IR
63321061	CA129IR	63321257	CA1083IR	63321485	CA1199IR	63321730	CA1217IR
63321062	CA506IR	63321270	CA890IR	63321488	CA851IR	63321733	CA1498IR
63321067	CA572IR	63321275	CA1084IR	063321488	CA851IR	63321734	CA1499IR
63321068	CA254IR	63321276	CA1258IR	63321489	CA1199IR	63321740	CA1641IR
063321068	CA254IR	63321277	CA1158IR	63321491	CA1753IR	63321741	CA1640IR
63321071	CA1435IR	63321278	CA1160IR	63321493	CA129IR	63321746	CA1475IR
63321080	CA1435IR	63321280	CA1153IR	63321497	CA1558IR	63321747	CA1153IR
63321081	CA317IR	63321281	CA1154IR	63321501	CA1558IR	63321758	CA1760IR
63321082	CA851IR	63321282	CA1084IR	63321503	CA1849IR	63321760	CA2059IR
63321083	CA375IR	63321283	CA1196IR	63321506	CA1189IR	063321761	CA1830IR
63321086	CA506IR	63321285	CA1379IR	63321507	CA1698IR	63321761	CA1844IR
063321088	CA504IR	63321286	CA2063IR	63321510	CA834IR	63321763	CA1830IR
63321091	CA596IR	63321287	CA1159IR	63321600	CA890IR	063321763	CA1830IR
63321096	CA506IR	63321291	CA1565IR	63321600	CA890IR	63321765	CA1742IR
063321096	CA506IR	63321292	CA2063IR	63321600	CA890IR	63321770	CA618IR
63321099	CA355IR	63321295	CA1220IR	63321600	CA890IR	63321771	CA1305IR
63321103	CA1435IR	63321299	CA1222IR	63321600	CA890IR	63321772	CA715IR
63321105	CA586IR	63321300	CA1154IR	063321600	CA890IR	63321775	CA1742IR
063321112	CA1435IR	63321302	CA1161IR	63321601	CA2063IR	63321776	CA1998IR
63321112	CA1435IR	63321310	CA1223IR	63321602	CA1153IR	63321778	CA1772IR
63321114	CA375IR	63321311	CA1160IR	63321603	CA1154IR	63321779	CA2060IR
63321115	CA212IR	63321312	CA1190IR	63321604	CA1154IR	63321782	CA1350IR
63321120	CA1435IR	63321313	CA1216IR	63321604	CA1154IR	63321788	CA1349IR
63321123	CA601IR	63321315	CA1311IR	063321604	CA1154IR	63321792	CA1199IR
63321136	CA851IR	63321316	CA1216IR	63321605	CA890IR	63321800	CA1208IR
63321146	CA355IR	63321321	CA1337IR	63321606	CA1220IR	063321800	CA1208IR
63321149	CA596IR	63321324	CA1085IR	063321606	CA1220IR	63321801	CA1223IR
63321151	CA834IR	63321328	CA1221IR	63321607	CA1220IR	63321802	CA1216IR
63321152	CA506IR	063321328	CA1221IR	063321607	CA1220IR	063321802	CA1216IR
63321153	CA506IR	63321329	CA1221IR	63321609	CA1196IR	63321803	CA1189IR
63321154	CA252IR	63321330	CA1159IR	63321610	CA1158IR	63321804	CA1558IR
063321154	CA252IR	63321331	CA1199IR	063321610	CA1158IR	63321805	CA1697IR
63321156	CA596IR	63321332	CA1199IR	63321611	CA1160IR	63321806	CA1697IR
063321156	CA596IR	63321333	CA1252IR	63321612	CA1159IR	63321809	CA1160IR
63321157	CA596IR	63321340	CA1219IR	63321613	CA1190IR	63321810	CA1159IR
063321157	CA596IR	63321343	CA1085IR	63321614	CA1160IR	063321810	CA1159IR
63321159	CA822IR	63321344	CA1085IR	63321615	CA1084IR	63321819	CA1697IR
63321160	CA822IR	63321345	CA1230IR	063321615	CA1084IR	063321819	CA1697IR
63321161	CA212IR	63321346	CA1379IR	63321616	CA1084IR	63321823	CA1475IR
63321163	CA212IR	063321346	CA1379IR	63321617	CA1258IR	63321826	CA1558IR
63321165	CA893IR	63321347	CA1230IR	63321618	CA1161IR	63321826	CA1558IR



O.E. NO.	HC-PARTS	O.E. NO.	HC-PARTS	O.E. NO.	HC-PARTS	O.E. NO.	HC-PARTS
063321826	CA1558IR	063341758	CA1760IR	63377494	CA1934IR	063536250	CA1701IR
63321829	CA1665IR	63341770	CA618IR	063377494	CA1934IR	0633200021	CA255IR
63321833	CA1696IR	063341770	CA618IR	063377495	CA1935IR	943101000	CS1068
063321833	CA1696IR	63341778	CA1772IR	063377496	CA2046IR *	943102004	CS1068
63321836	CA1743IR	063341778	CA1772IR	063380001	CA2034IR	943114010	CS1124
063321836	CA1743IR	63341896	CA1625IR	063380002	CA1777IR	943151434	CS392
063321839	CA1160IR	063358061	CA1862IR	063380004	CA1635IR	943192000	JS1142
63321848	CA1843IR	063358062	CA1856IR	063380005	CA1638IR	943201005	CS308
63321858	CA1753IR	63362003	CA45	063380006	CA1638IR	943216876	CS335
063321858	CA1753IR	63362004	CA45	063380007	CA1779IR	943217163	CS996
63321859	CA1698IR	63362006	CA45	063380008	CA1857IR	943220535	CS166
63321862	CA2062IR *	63377001	CA1844IR	063380009	CA1857IR	943221003	CA252IR
063321862	CA2062IR *	063377002	CA1766IR	063380010	CA1857IR	943221020	CA355IR
63321867	CA1647IR ▲	63377004	CA1885IR	063388505	CA1039IR	943221333	CS180
63321869	CA1844IR	063377004	CA1885IR	63395575	CA1435IR	943221334	CS77
63321870	CA1153IR ▲	63377005	CA1995IR	063520003	CS1379	943221430	CS275
63321872	CA2061IR *	063377005	CA1995IR	063521060	CS1241	943221434	CS184
63321896	CA1625IR	63377006	CA1766IR	063521071	CS880	943221534	CS168
63321897	CA1625IR	063377006	CA1766IR	063521084	CS594	943221535	CS293
63321898	CA1475IR	63377007	CA1998IR	063522235	CS572	943221535	CS79
63321940	CA1995IR	063377007	CA1998IR	063522602	CS1188	943221670	CS298
063324198	CA629IR	63377008	CA1766IR	063522603	JS770	943221834	CS963
063324199	CA126IR	063377008	CA1766IR	063522605	JS1311	943222034	CS554
063324220	CA325IR	63377009	CA1998IR	063522606	JS1098	943222138	CS554
063324242	CA564IR	063377009	CA1998IR	063522607	CS1210	943222204	CS1170
063324256	CA725IR	063377010	CA1742IR	063522609	JS1234	943222206	CS992
063324273	CA726IR	63377011	CA1886IR	063522611	JS1303	943222909	CS1076
063324274	CA1330IR	063377011	CA1886IR	063522612	CS879	943223108	CS1052
063324276	CA600IR	63377013	CA1742IR	063522614	JS365	943223430	CS584
063324277	CA305IR	063377013	CA1742IR	063522615	JS1298	943223435	CS516
063324318	CA1384IR	63377015	CA2016IR	063522616	CS1446	943223436	CS584
063324374	CA1031IR	63377300	CA1681IR	063522617	JS628	943223438	CS725
063324374	CA719IR	063377401	CA1483IR	063522619	JS1304	943223730	CS1042
063324387	CA564IR	63377402	CA1340IR	063522621	JS923	943241016	JS365
63340004	CA1191IR	063377402	CA1340IR	063522622	JS1234	943241028	JS389
063340007	CA1651IR	63377404	CA1475IR	063522623	JS344	943241031	JS1214
63341238	CA1318IR	063377404	CA1475IR	063522626	CS1433	943241044	JS652
063341238	CA1318IR	063377407	CA1925IR	063522628	JS1355	943241046	JS317
63341239	CA1487IR	63377409	CA1483IR	063522629	CS1422	943241048	JS357
063341239	CA1487IR	063377409	CA1483IR	063523623	CS114	943241050	JS563
63341240	CA1380IR	63377410	CA1340IR	063523673	CS186	943241056	JS371
63341243	CA1380IR	063377410	CA1340IR	063523803	CS1291	943241058	JS1021
063341243	CA1380IR	63377412	CA1475IR	063532601	JA1709IR	943241063	JS631
63341244	CA1217IR	063377412	CA1475IR	063532602	JA1789IR	943241071	JS318
63341321	CA1337IR	63377413	CA1475IR	063532603	JA1716IR	943241074	JS336
63341333	CA1252IR	063377413	CA1475IR	063532604	JA1618IR	943241092	JS388
063341333	CA1252IR	063377414	CA1475IR	063532607	JA1785IR	943241100	JS376
63341343	CA1085IR	63377416	CA1834IR	063532608	JA1518IR	943241102	JS512
063341343	CA1085IR	063377416	CA1834IR	063532609	JA1711IR	943241107	JS651
63341344	CA1085IR	63377418	CA1999IR	063532610	JA1537IR	943241124	JS628
063341344	CA1085IR	063377418	CA1999IR	063532611	JA994IR	943250108	CS76
63341345	CA1230IR	63377420	CA1931IR	063532612	JA1798IR	943251008	CS76
063341345	CA1230IR	063377420	CA1931IR	063532613	JA1715IR	943251048	CS66
63341351	CA1100IR	63377421	CA1989IR	063532614	JA879IR	943251052	CS126
063341351	CA1100IR	63377423	CA1955IR	063532615	JA671IR	943251052	CS94
63341352	CA1252IR	63377424	CA1956IR	063532619	JA1276IR	943251054	CS315
63341353	CA1380IR ▲	063377424	CA1956IR	063532620	JA1600IR	943251054	CS95
63341358	CA1337IR	63377425	CA1987IR	063532621	JA1795IR	943251056	CS143
63341434	CA1651IR	063377425	CA1987IR	063532622	JA1708IR	943251056	CS321
63341636	CA1488IR	063377426	CA1969IR	063532623	JA684IR	943251057	CS170
63341641	CA618IR	063377427	JA1783IR	063532624	JA1709IR	943251059	CS338
63341658	CA1734IR	063377428	JA1703IR	063532625	JA1618IR	943251061	CS80
63341666	CA1083IR	063377429	CA2047IR	063532627	JA1804IR	943251072	CS126
63341678	CA1483IR	063377431	JA1703IR	063532628	JA1798IR	943251072	CS94
63341679	CA1340IR	063377432	JA1703IR	063532629	JA1600IR	943251074	CS130
63341695	CA1083IR	063377433	JA1797IR	063532636	CA1671IR	943251085	CS273
63341702	CA1734IR	063377434	JA1792IR	63332637	CA1745IR	943251103	CS381
63341704	JA1174IR	063377435	JA1613IR	063532637	CA1745IR	943251107	CS310
63341711	CA1649IR	063377436	JA1134IR	063533155	CA1556IR	943251109	CS326
063341711	CA1649IR	063377438	JA1794IR	063533200	CA1557IR	943251110	CS355
63341723	CA715IR	063377440	JA1517IR	063533350	CA618IR	943251111	CS306
63341727	CA1488IR	063377442	JA1793IR	063533479	CA1053IR	943251116	CS366
63341730	CA1217IR	063377480	CA2077IR *	063534690	CA1336IR	943251127	CS342
63341730	CA1217IR	63377490	CA1885IR	063534699	CA333IR	943251136	CS390
63341733	CA1498IR	63377491	CA1890IR	063534890	CA305IR	943251139	CS372
063341734	CA1499IR	063377491	CA1890IR	063534892	CA306IR	943251144	CS373
063341740	CA1641IR	63377492	CA1884IR	063534897	CA341IR	943251225	CS598
63341746	CA1475IR	63377493	CA1855IR	063535250	CA1837IR	943251226	CS599
63341758	CA1760IR	063377493	CA1855IR	063535550	CA1699IR	943251268	CS585

O.E. NO.	HC-PARTS	O.E. NO.	HC-PARTS	O.E. NO.	HC-PARTS	O.E. NO.	HC-PARTS
<b>MAGNETI MARELLI <i>Continued</i></b>							
943251275	CS1059	943321607	CA1220IR	943356728	CA221IR	054022474010	CA560IR
943251300	CS370	943321610	CA1158IR	943356729	CA139IR	054022602010	CA717IR
943251301	CS300	943321615	CA1084IR	943356740	CA367IR	054022642010	CA564IR
943251302	CS576	943321617	CA1258IR	943356749	CA251IR	054022646010	CA627IR
943251305	CS684	943321620	CA1565IR	943356766	CA1433IR	054022654010	JA756IR
943251322	CS559	943321631	CA1453IR	943356789	CA733IR	054022656010	CA1494IR
943251323	CS624	943321661	CA1084IR	943356797	CA298IR	054022664010	JA756IR
943251324	CS606	943321715	CA1350IR	943356797	CA911IR	054022693010	CA1508IR
943251328	CS723	943322584	CA560IR	943356809	CA321IR	063101015010	CS796
943251340	CS880	943341238	CA1318IR	943356811	CA335IR	063102003010	CS981
943251401	CS365	943341243	CA1380IR	943356814	CA357IR	063102008010	CS800
943251403	CS129	943341343	CA1085IR	943356816	CA296IR	063102022010	CS1379
943251403	CS352	943341345	CA1230IR	943356817	CA297IR	063103022010	CS975
943251408	CS81	943341351	CA1100IR	943356818	CA320IR	063103023010	CS1043
943251408	CS83	943346003	CA533IR	943356850	CA1448IR	063111017010	CS1213
943251416	CS548	943346139	CA1101IR	943356859	CA569IR	063112003010	CS1037
943251417	CS569	943354063	JA194IR	943356859	CA727IR	063113003010	CS1212
943251418	CS509	943354076	CA1444IR	943356960	CA716IR	063114014010	CS1109
943251420	CS577	943355151	CA1442IR	943356964	CA825IR	063219007010	CS1206
943251426	CS389	943356001	CA52IR	943356974	CA1098IR	063193001010	CS1265
943251428	CS266	943356054	CA96IR	943357708	CA130IR	063216851010	CS333
943251436	CS683	943356090	CA124IR	943357708	CA155IR	063216884010	CS335
943251437	CS574	943356098	CA141IR	943357716	CA187IR	063222034010	CS554
943251439	CS1183	943356115	CA112	943358062	CA1856IR	063222136010	CS351
943251439	CS535	943356115	CA115	943377011	CA1886IR	063222138010	CS554
943251442	CS580	943356122	CA174IR	943377491	CA1890IR	063222204010	CS1170
943251443	CS716	943356125	CA291IR	943377492	CA1884IR	063226801010	CS589
943251446	CS268	943356133	CA169IR	943377492	CA2049IR	063226836010	CS786
943251449	CS794	943356134	CA81IR	944280101	CS70	063227009010	CS708
943251458	CS330	943356134	CA84IR	944280123	CS326	063227035010	CS610
943251459	CS357	943356136	CA150IR	944280124	CS268	063219007010	CS1270
943251459	CS685	943356142	CA175IR	944280154	CS574	063227045010	CS579
943251485	CS119	943356145	CA172IR	944280156	CS585	063227487010	CS946
943251486	CS83	943356173	CA371IR	944280157	CS561	063227587010	CS604
943251488	CS566	943356183	CA294IR	944280181	CS1172	063228021010	CS1275
943251501	CS386	943356184	CA268IR	944280190	CS610	063280022010	CS1245
943251534	CS334	943356197	CA372IR	944280192	CS684	063280023010	CS1246
943251606	CS123	943356202	CA359IR	944280195	CS1249	063280027010	CS1403
943251613	CS162	943356206	CA345IR	944280205	JS1230	063280028010	CA1402
943251624	CS116	943356211	CA352IR	944280206	JS1154	063280029010	CS1341
943251651	CS311	943356211	CA517IR	944280213	CS1410	063280031010	CS1426
943251652	CS185	943356214	CA369IR	944280218	CS1421	063280032010	CS961
943251655	CS295	943356215	CA557IR	944280526	JS657	063280034010	CS1336
943251663	CS294	943356216	CA241IR	944280555	CS691	063280036010	CS1377
943251664	CS1162	943356217	CA276IR	944280557	CS610	063280042010	CS1379
943251669	CS282	943356219	CA375IR	944280558	JS648	063280044010	CS1379
943251674	CS268	943356231	CA749IR	944280709	CS1210	063280045010	CS1346
943251675	CS299	943356267	CA1224IR	944280721	CS1476	063280046010	CS1379
943251683	CS507	943356329	CA1039IR	944280721	JS1302	063280048010	JS1362
943251686	CS297	943356380	CA316IR	944288162	CS1201	063280050010	JS1302
943251697	CS356	943356406	CA525IR	944390300	CG19	063280051010	JS1080
943251815	CS724	943356408	CA516IR	944390306	CA139IR	063280052010	JS1088
943252046	CS194	943356445	CA136IR	944390307	CA139IR	063280057010	CS1499
943252187	CS198	943356446	CA140IR	944390311	CA93	063280059010	JS1369
943252190	CS506	943356450	CA125IR	944390311	CA93IR	063280071010	CS1473
943252204	CS103	943356454	CA60IR	944390315	CA140IR	063280110010	CS1283
943252205	CS530	943356465	CA87IR	944390316	CA259IR	063280901010	JS1311
943252206	CS186	943356502	CA99IR	944390320	CA176IR	063280902010	JS1312
943252223	CS188	943356512	CA826IR	944390322	CA175IR	063293039010	CS788
943252241	CS1031	943356539	CA861IR	944390337	CA241IR	063293538010	CS971
943252299	CS887	943356544	CA511IR	944390340	CA335IR	063296842010	CS511
943252690	CS1163	943356554	CA1053IR	944390341	CA566IR	063310508010	CA1643IR
943252858	CS510	943356555	CA199IR	944390362	CA717IR	063310509010	CA1444IR
943253233	CS691	943356563	CA524IR	944390377	CA735IR	063320060010	CA212IR
943253239	CS1211	943356567	CA639IR	944390378	CA556IR	063321159010	CA822IR
943253242	CS961	943356604	CA320IR	944390382	CA724IR	063321165010	CA893IR
943254033	CS1060	943356608	CA521IR	944390424	CA1575IR	063321328010	CA1221IR
943293541	CS1260	943356645	CA631IR	944390424	CA1576IR	063321340010	CA1219IR
943293542	CS684	943356646	CA593IR	944390447	CA1100IR	063321402010	CA1222IR
943293544	CS1174	943356653	CA540IR	944390450	CA1584IR	063321485010	CA1199IR
943307805	CA709	943356659	CA353IR	944390456	JA1607IR	063321493010	CA129IR
943311420	JA1521IR	943356659	CA514IR	944390474	CA1840IR	063321606010	CA1220IR
943321000	CA350IR	943356663	CA322IR	944390475	CA1656IR	063321607010	CA1220IR
943321083	CA375IR	943356665	CA378IR	944390479	CA1928IR	063321610010	CA1158IR
943321328	CA1221IR	943356678	CA302IR	944390483	CA1919IR	063321617010	CA1258IR
943321346	CA1379IR	943356681	CA588IR	944390662	CA1252IR	063321625010	CA1196IR
943321391	CA1348IR	943356701	CA128IR	944390901	CA2059IR	063321715010	CA1350IR
943321398	CA1218IR	943356709	CA186IR	944390904	CA1953IR	063321760010	CA2059IR
943321604	CA1154IR	943356723	CA238IR	944399379	CA229IR	063321761010	CA1830IR

O.E. NO.	HC-PARTS	O.E. NO.	HC-PARTS	O.E. NO.	HC-PARTS	O.E. NO.	HC-PARTS
063321763010	CA1830IR	063377493010	CA1855IR	063522300090	CS682	063534699820	CA333IR
063321765010	CA1742IR	063377494010	CA1934IR	063522310030	CS1279	063534882530	CA1448IR
063321767010	CA1998IR	063377495010	CA1935IR	063522310160	CS1268	063534890930	CA305IR
063321800010	CA1208IR	063377496010	CA2046IR *	063522310290	CS1267	063534892520	CA306IR
063321802010	CA1216IR	063380001010	CA2034IR	063522310330	CS1112	063534893260	CA345IR
063321803010	CA1189IR	063380002010	CA1777IR	063522602010	CS1188	063534897070	CA341IR
063321809010	CA1160IR	063380004010	CA1635IR	063522603010	JS770	063535150200	CA1260IR
063321826010	CA1558IR	063380005010	CA1638IR	063522605010	JS1311	063535150440	CA1679IR
063321833010	CA1696IR	063380006010	CA1638IR	063522606010	JS1098	063535250200	CA1837IR
063321836010	CA1743IR	063380007010	CA1779IR	063522607010	CS1210	063535255010	CA1663IR
063321839010	CA1160IR	063380008010	CA1857IR	063522609010	JS1234	063535500500	CA1699IR
063321854010	CA1199IR	063380009010	CA1857IR	063522611010	JS1303	063536250020	CA1701IR
063321858010	CA1753IR	063380010010	CA1857IR	063522612010	CS879	063536550050	CA1812IR
063321862010	CA2062IR *	063388505010	CA1039IR	063522614010	JS365	063536550080	CA1883IR
063321863010	CA1886IR	063520003200	CS1379	063522615010	JS1298	943201005010	CS308
063321863010	CA2060IR *	063521060140	CS1241	063522616010	CS1446	943220535010	CS166
063324145010	CA306IR	063521070220	CS619	063522617010	JS628	943220746010	CS363
063324231010	CA650IR	063521070470	CS681	063522619010	JS1304	943221332010	CS131
0633411730010	CA1318IR	063521070620	CS807	063522621010	JS923	9432210334010	CS77
063341333010	CA1252IR	063521070630	CS566	063522623010	JS344	943221534010	CS168
063341343010	CA1085IR	063521070660	CS1053	063522626010	CS1433	943223034010	CS711
063341351010	CA1191IR	063521070680	CS612	063522628010	JS1355	943223435010	CS516
063341353010	CA1380IR	063521070730	CS612	063522629010	CS1422	943223438010	CS725
063341658010	CA1734IR	063521070780	JS737	063523620730	CS289	943241007010	JS534
063341704010	JA1174IR	063521070910	CS1213	063523623050	CS114	943241008010	CS611
063341705010	JA665IR	063521070970	CS1213	063523673030	CS186	943241015010	JS365
063341730010	CA1217IR	063521071030	CS880	063523680010	CS530	943241016010	JS365
063341734010	CA1499IR	063521074030	CS1075	063523680820	CS1261	943241024010	JS378
063341740010	CA1640IR	063521074080	CS1257	063523683010	CS97	943241025010	JS520
063341741010	CA1640IR	063521074110	CS1053	063523683090	CS120	943241026010	JS304
063341770010	CA618IR	063521074270	CS1394	063523803010	CS1291	943241033010	JS1214
063341896010	CA1625IR	063521074370	CS1334	063524160020	CS191	943241033010	CS878
063358061010	CA1862IR	063521074420	CS1067	063524160110	CS502	943241035010	CS372
063358062010	CA1856IR	063521074920	CS1257	063524160520	CS502	943241036010	CS561
063377002010	CA1766IR	063521081760	CS715	063524160780	CS191	943241037010	JS557
063377004010	CA1885IR	063521081800	CS784	063532250200	CA2024IR	943241040010	JS630
063377005010	CA1995IR	063521082020	CS1264	063532250220	CA1257IR	943241046010	JS317
063377006010	CA1766IR	063521082040	CS1212	063532601010	JA1709IR	943241056010	JS371
063377008010	CA1766IR	063521082170	CS1172	063532602010	JA1789IR	943241058010	JS1021
063377009010	CA1998IR	063521084000	CS594	063532603010	JA1716IR	943241061010	CS600
063377010010	CA1742IR	063521090180	CS1037	063532604010	JA1618IR	943241063010	JS631
063377011010	CA1886IR	063521090350	CS1471	063532607010	JA1785IR	943241064010	JS1018
063377013010	CA1742IR	063521090680	CS976	063532608010	JA1518IR	943241070010	JS399
063377015010	CA2016IR	063521092500	CS1044	063532609010	JA1711IR	943241071010	JS318
063377016010	CA2048IR	063521092680	CS1335	063532610010	JA1537IR	943241088010	CS588
063377017010	CA2049IR *	063521093070	CS1203	063532611010	JA994IR	943241092010	JS388
063377018010	CA2050IR *	063521101040	CS341	063532612010	JA1798IR	943241100010	JS376
063377019010	CA1862IR	063521101060	CS624	063532613010	JA1715IR	943241102010	JS512
063377021010	CA1855IR	063521101250	CS1059	063532614010	JA879IR	943241104010	JS632
063377022010	CA1862IR	063521101380	CS624	063532615010	JA671IR	943241124010	JS628
063377031010	CA2096IR *	063521120380	CS618	063532619010	JA1276IR	943241167010	CS802
063377301010	CA1665IR	063521120410	CS581	063532620010	JA1600IR	943251050010	CS95
063377406010	CA1475IR	063521120440	CS788	063532621010	JA1795IR	943251054010	CS95
063377409010	CA1483IR	063521130060	CS796	063532622010	JA1708IR	943251064010	CS280
063377410010	CA1340IR	063521130070	CS723	063532623010	JA684IR	943251075010	CS128
063377412010	CA1475IR	063521204000	CS1282	063532624010	JA1709IR	943251085010	CS273
063377413010	CA1475IR	063521204060	CS1330	063532625010	JA1618IR	943251111010	CS306
063377414010	CA1475IR	063521204080	CS1324	063532627010	JA1804IR	943251113010	CS575
063377416010	CA1834IR	063521204100	CS1322	063532628010	JA1798IR	943251116010	CS366
063377418010	CA1999IR	063521210160	CS1197	063532629010	JA1600IR	943251122010	CS314
063377420010	CA1931IR	063521210260	CS1119	063532636010	CA1671IR	943251139010	CS372
063377423010	CA1955IR	063521210280	CS1062	063532637010	CA1745IR	943251165010	CS62
063377424010	CA1956IR	063521210300	CS1063	063533100530	CA1037IR	943251220010	CS69
063377425010	CA1987IR	063521214020	CS1347	063533100540	CA1087IR	943251225010	CS598
063377426010	CA1969IR	063521214080	CS1294	063533155000	CA1556IR	943251227010	CS531
063377427010	JA1783IR	063521214120	CS1409	063533200010	CA1557IR	943251266010	CS585
063377428010	JA1703IR	063521230120	CS1293	063533250010	CA1446IR	943251268010	CS585
063377429010	CA2047IR	063521230140	CS1323	063533250130	CA1542IR	943251269010	CS83
063377431010	JA1703IR	063521230160	CS1286	063533250580	CA1471IR	943251301010	CS300
063377432010	JA1703IR	063521230180	CS1393	063533250590	CA1648IR	943251302010	CS576
063377433010	JA1797IR	063521240200	CS1208	063533251000	CA1779IR	943251322010	CS559
063377434010	JA1792IR	063521240220	CS988	063533251220	CA1915IR	943251323010	CS624
063377435010	JA1613IR	063521240260	CS988	063533350070	CA618IR	943251324010	CS606
063377436010	JA1134IR	063521250350	CS1287	063533479010	CA1053IR	943251327010	CS619
063377438010	JA1794IR	063521250420	CS974	063534150120	CA1648IR	943251328010	CS723
063377440010	JA1517IR	063521250480	CS1181	063534150230	CA1748IR	943251330010	CS620
063377442010	JA1793IR	063522187740	CS1118	063534681240	CA1438IR	943251334010	CS879
063377491010	CA1890IR	063522230240	CS1203	063534681400	CA1456IR	943251338010	CS721
063377492010	CA1884IR	063522235040	CS572	063534690480	CA1336IR	943251401010	CS365

O.E. NO.	HC-PARTS	O.E. NO.	HC-PARTS	O.E. NO.	HC-PARTS	O.E. NO.	HC-PARTS
<b>MAGNETI MARELLI <i>Continued</i></b>							
943251418010	CS509	943253106010	CS976	943346067010	JA1711R	943355098010	CA1503IR
943251420010	CS577	943253107010	CS988	943346129010	CA721	943355105010	CA1033IR
943251421010	CS573	943253108010	CS974	943346130010	CA705IR	943355108010	CA1204IR
943251423010	CS326	943253114010	CS879	943346137010	JA755IR	943355109010	CA1228IR
943251424010	CS686	943253118010	CS1114	943346139010	CA1101IR	943355110010	CA1248IR
943251426010	CS389	943253119010	CS1119	943346148010	CA739IR	943355115010	CA1543IR
943251427010	CS117	943253133010	CS792	943346154010	CA1095IR	943355116010	CA1075IR
943251428010	CS266	943253135010	CS1046	943346158010	JA769IR	943355117010	CA1226IR
943251431010	CS392	943253136010	CS1048	943346160010	JA761IR	943355118010	CA1297IR
943251433010	CS500	943253140010	CS1051	943346196010	JA750IR	943355119010	JA1134IR
943251436010	CS683	943253141010	CS1072	943346198010	CA1077IR	943355120010	CA1262IR
943251437010	CS574	943253143010	CS1196	943346208010	CA607IR	943355123010	CA1096IR
943251441010	CS524	943253144010	CS1132	943346214010	JA697IR	943355126010	JA1599IR
943251442010	CS580	943253145010	CS1041	943346215010	JA698IR	943355127010	JA1377IR
943251443010	CS716	943253148010	CS1202	943346223010	CA1065IR	943355128010	CA1299IR
943251445010	CS81	943253149010	CS594	943354003010	JA994IR	943355129010	CA1402IR
943251446010	CS268	943253151010	CS1188	943354007010	JA674IR	943355130010	CA1492IR
943251449010	CS794	943253154010	CS1181	943354010010	JA981IR	943355132010	CA1449IR
943251450010	CS583	943253155010	CS1060	943354039010	JA1182IR	943355133010	CA1579IR
943251460010	CS562	943253156010	CS1047	943354058010	JA989IR	943355135010	CA1481IR
943251462010	CS562	943253157010	CS1197	943354062010	JA196	943355139010	CA1394IR
943251464010	CS578	943253158010	CS1067	943354063010	JA194IR	943355144010	CA1509IR
943251485010	CS119	943253159010	CS1176	943354064010	JA1536IR	943355147010	CA1485IR
943251487010	CS973	943253160010	CS1200	943354075010	CA1304IR	943355148010	CA1486IR
943251534010	CS334	943253170010	JS1024	943354076010	CA1444IR	943355149010	CA1343IR
943251549010	CS622	943253171010	CS1179	943354083010	CA1322IR	943355150010	CA1434IR
943251569010	CS699	943253173010	JS300	943354097010	CA1267IR	943355151010	CA1442IR
943251574010	CS1118	943253175010	JS650	943354099010	CA1152IR	943355158010	CA1547IR
943251609010	CS183	943253177010	JS775	943354103010	CA1231IR	943355162010	CA1581IR
943251617010	CS132	943253188010	JS560	943354108010	JA1176IR	943355163010	CA1501IR
943251625010	CS74	943253198010	JS637	943354163010	CA1151IR	943355164010	CA1470IR
943251628010	CS276	943253200010	JS356	943354163010	CA1152IR	943355169010	JA1361IR
943251644010	CS263	943253202010	JS645	943354181010	JA976IR	943355170010	JA769IR
943251650010	CS268	943253206010	JS1083	943354182010	JA1134IR	943355177010	JA666IR
943251651010	CS311	943253211010	JS318	943355001010	CA1071IR	943355180010	JA598IR
943251655010	CS295	943253214010	JS1095	943355002010	CA1149IR	943355183010	JA973IR
943251669010	CS282	943253215010	JS781	943355003010	CA1076IR	943355187010	JA1526IR
943251670010	CS298	943253226010	JS380	943355004010	CA1399IR	943355193010	CA634IR
943251674010	CS268	943253235010	CS798	943355004010	CA828IR	943355194010	CA1338IR
943251683010	CS507	943253239010	CS1211	943355005010	CA1037IR	943355195010	CA1137IR
943251698010	CS508	943253242010	CS961	943355010010	CA1245IR	943355196010	CA1484IR
943251699010	CS346	943253266010	CS1198	943355012010	CA1106IR	943355203010	JA658IR
943251833010	CS514	943254007010	JS760	943355015010	CA1146IR	943355204010	CA1750IR
943251856010	CS374	943254008010	JS1015	943355016010	CA1145IR	943355213010	CA1080IR
943251871010	CS692	943254018010	CS542	943355019010	CA1247IR	943355224010	CA1572IR
943251893010	JS354	943254024010	JS383	943355020010	CA1059IR	943355230010	CA1553IR
943251915010	CS784	943254027010	JS666	943355021010	CA1320IR	943355232010	CA1456IR
943251919010	CS782	943254040010	JS774	943355022010	CA1040IR	943355233010	CA1456IR
943251920010	CS885	943254043010	CS684	943355025010	CA1239IR	943356102010	CA1060IR
943251921010	CS791	943254050010	CS1044	943355027010	CA1403IR	943356106010	CA526IR
943251926010	CS964	943254066010	JS540	943355028010	CA1268IR	943356109010	CA605IR
943252012010	CS194	943254075010	JS339	943355029010	JA1364IR	943356116010	CA174IR
943252045010	CS951	943254076010	JS659	943355030010	CA1249IR	943356122010	CA174IR
943252064010	CS502	943254078010	JS377	943355031010	CA1255IR	943356142010	CA175IR
943252065010	CS1261	943254084010	JS1085	943355035010	CA1240IR	943356145010	CA172IR
943252129010	CS194	943289180010	CS977	943355037010	CA1241IR	943356158010	CA361IR
943252189010	CS383	943293541010	CS1260	943355039010	CA1144IR	943356192010	CA534IR
943252201010	CS120	943293542010	CS684	943355045010	CA1140IR	943356201010	CA246IR
943252204010	CS103	943293544010	CS1174	943355049010	CA1391IR	943356202010	CA359IR
943252212010	CS99	943311220010	JA1172IR	943355051010	CA1591IR	943356205010	CA322IR
943252213010	CS101	943311230010	JA863IR	943355052010	CA1260IR	943356205010	CA332IR
943252216010	CS398	943311380010	JA769IR	943355054010	CA1327IR	943356210010	CA284IR
943252231010	CS121	943311390010	CA1317IR	943355055010	CA1200IR	943356213010	CA315IR
943252233010	CS783	943311420010	JA1521IR	943355056010	CA1250IR	943356214010	CA369IR
943252235010	CS120	943321083010	CA375IR	943355057010	CA1099IR	943356216010	CA241IR
943252240010	CS349	943321170010	CA889IR	943355059010	CA1502IR	943356218010	CA566IR
943252242010	CS198	943321604010	CA1154IR	943355060010	CA1446IR	943356224010	CA184
943252244010	CS186	943321715010	CA1350IR	943355061010	CA1378IR	943356225010	CA184
943252249010	CS595	943322584010	CA560IR	943355062010	CA1436IR	943356226010	CA1236IR
943252254010	CS617	943324348010	CA1305IR	943355064010	CA1333IR	943356230010	CA366IR
943252273010	CS607	943341239010	CA1487IR	943355079010	CA1057IR	943356246010	CA853IR
943252278010	CS387	943346006010	JA153	943355083010	CA900IR	943356248010	CA710IR
943252283010	CS605	943346008010	JA177IR	943355087010	CA1301IR	943356259010	CA187IR
943252284010	CS269	943346016010	JA695IR	943355088010	CA1300IR	943356268010	CA839IR
943252290010	CS388	943346018010	JA138	943355089010	CA1299IR	943356308010	CA196IR
943252294010	CS198	943346027010	CA195IR	943355090010	CA1563IR	943356310010	CA737IR
943252690010	CS1163	943346037010	CA1093IR	943355093010	CA1259IR	943356315010	CA17H
943253102010	CS1050	943346052010	JA752IR	943355095010	CA1138IR	943356325010	CA817IR
943253105010	CS684	943346056010	JA107IR	943355097010	CA1325IR	943356329010	CA1039IR

O.E. NO.	HC-PARTS	O.E. NO.	HC-PARTS	O.E. NO.	HC-PARTS	O.E. NO.	HC-PARTS
943356331010	CA1107IR	943356965010	CA715IR	944280145800	CS500	944280180300	CS1196
943356334010	CA254IR	943356966010	CA1203IR	944280145900	CS542	944280180400	CS1119
943356391010	CA1157IR	943356971010	CA830IR	944280146000	CS330	944280180500	CS1132
943356408010	CA516IR	943356973010	CA836IR	944280146800	CS794	944280181800	CS1172
943356446010	CA140IR	943356974010	CA1098IR	944280147000	CS374	944280182100	CS322
943356468010	CA118	943356979010	CA821IR	944280147110	CS90	944280182600	CS372
943356498010	CA93	943356980010	CA815IR	944280148000	CS396	944280182700	CS1202
943356498010	CA93IR	943356981010	CA535IR	944280148100	CS559	944280183100	CS594
943356506010	CA724IR	943356982010	CA632IR	944280148200	CS559	944280183400	CS1074
943356512010	CA826IR	943356996010	CA720IR	944280148300	CS683	944280183500	CS1188
943356517010	CA846IR	943356999010	CA556IR	944280148400	CS377	944280183600	CS1179
943356521010	CA902IR	943357258010	CA240IR	944280148900	CS515	944280183800	CS1165
943356525010	CA841IR	943357556010	CA75	944280149000	CS516	944280184000	CS1060
943356538010	CA320IR	943357765010	CA341IR	944280149400	CS583	944280184300	CS1197
943356544010	CA511IR	943357775010	CA801IR	944280149500	CS332	944280184500	CS1212
943356553010	CA1066IR	943357800010	CA702IR	944280150500	CS577	944280184800	JS1236
943356557010	CA1032IR	943357801010	CA1336IR	944280152000	CS562	944280185000	CS1200
943356560010	CA380IR	943358062010	CA1856IR	944280154700	CS574	944280185110	CS978
943356561010	CA526IR	943377011010	CA1886IR	944280155510	CS692	944280185410	JS1147
943356563010	CA524IR	943377491010	CA1890IR	944280155600	CS687	944280185510	JS1152
943356566010	CA618IR	943377492010	CA1884IR	944280156000	CS585	944280185610	CS886
943356568010	CA1086IR	943377492010	CA2049IR	944280157010	CS561	944280185710	CS1117
943356575010	CA1102IR	944280100300	CS162	944280159100	CS709	944280185810	CS1060
943356577010	CA1155IR	944280100700	CS61	944280159300	CS554	944280185910	CS681
943356582010	JA753IR	944280102000	CS352	944280159700	CS713	944280186110	CS1055
943356591010	JA1172IR	944280102500	CS263	944280161300	CS551	944280186210	JS1142
943356592010	JA142IR	944280102900	CS275	944280162400	CS624	944280186300	JS1226
943356602010	CA141IR	944280103100	CS310	944280162500	CS888	944280186800	JS1135
943356603010	CA320IR	944280103400	CS131	944280162800	CS727	944280186900	JS1024
943356612010	CA287IR	944280103600	CS115	944280162900	CS618	944280187010	JS1024
943356619010	CA263IR	944280104300	CS156	944280162900	CS713	944280187700	CS1179
943356627010	CA645IR	944280104400	CS133	944280163000	CS619	944280188400	CS1254
943356632010	CA96IR	944280104700	CS298	944280163100	CS616	944280188500	CS1075
943356638010	CA324IR	944280105300	CS62	944280163200	CS723	944280188600	CS1255
943356640010	CA299IR	944280105800	CS117	944280163400	CS599	944280188700	CS1272
943356641010	CA592IR	944280106000	CS361	944280163800	CS1075	944280188800	CS1213
943356644010	CA567IR	944280106300	CS119	944280164010	CS681	944280188900	CS1256
943356645010	CA631IR	944280106500	CS292	944280165300	CS566	944280189000	CS1335
943356649010	CA251IR	944280108500	CS81	944280165600	CS878	944280189100	CS1271
943356651010	CA541IR	944280108800	CS286	944280166600	CS680	944280189300	CS1194
943356652010	CA539IR	944280108900	CS268	944280167000	CS620	944280189400	CS1187
943356653010	CA540IR	944280109100	CS185	944280167110	CS791	944280189600	CS1198
943356656010	CA503IR	944280109500	CS337	944280167400	JS1214	944280190300	CS610
943356661010	CA198IR	944280110300	CS128	944280167500	CS597	944280192710	CS684
943356663010	CA322IR	944280110800	CS289	944280167800	CS725	944280195000	CS1249
943356677010	CA537IR	944280111100	CS314	944280167900	CS788	944280198700	CS1257
943356680010	CA342IR	944280111500	CS188	944280168600	CS802	944280198900	CS1343
943356683010	CA528IR	944280117310	CS126	944280168700	CS1037	944280199200	CS1253
943356686010	CA272IR	944280117410	CS95	944280168800	CS879	944280199700	CS1247
943356691010	CA289IR	944280118310	CS315	944280168900	CS372	944280202200	CS1324
943356697010	CA706IR	944280118410	CS397	944280169000	CS1059	944280202300	CS1347
943356698010	CA165IR	944280118710	CS91	944280169100	CS585	944280202400	CS1294
943356708010	CA186IR	944280118910	CS90	944280169200	CS792	944280202500	CS1293
943356734010	CA236IR	944280119210	CS147	944280169500	CS885	944280202600	CS1323
943356735010	CA205IR	944280119410	CS308	944280169610	CS711	944280202700	CS1405
943356743010	CA271IR	944280123400	CS326	944280169800	CS974	944280202800	CS1286
943356749010	CA251IR	944280124100	CS268	944280170100	CS782	944280202900	CS1330
943356766010	CA340IR	944280126050	CS618	944280170200	CS973	944280203000	CS1393
943356791010	CA134	944280130100	CS327	944280170300	CS796	944280203200	CS1397
943356799010	CA731IR	944280130500	CS295	944280170410	CS1038	944280203300	CS1322
943356808010	CA321IR	944280130800	CS322	944280170700	CS960	944280203500	CS1283
943356814010	CA357IR	944280131200	CS326	944280171100	CS1067	944280205510	JS1230
943356849010	CA1438IR	944280131400	CS386	944280171310	CS964	944280206010	JS1154
943356859010	CA569IR	944280131500	CS360	944280171800	CS1048	944280207210	JS1235
943356899010	CA909IR	944280131600	CS346	944280171900	CS1113	944280207800	CS1282
943356903010	CA295IR	944280132100	CS306	944280173610	CS882	944280208600	CS1398
943356919010	CA640IR	944280133600	CS329	944280173810	CS684	944280208900	CS1413
943356922010	JA140	944280134000	CS376	944280174200	CS976	944280210100	CS1475
943356943010	CA617IR	944280134100	CS350	944280174500	CS988	944280210300	CS1179
943356945010	CA896IR	944280136000	CS389	944280174600	CS974	944280212100	CS1394
943356946010	CA1038IR	944280136100	CS372	944280174700	CS1055	944280212200	CS1392
943356947010	CA827IR	944280136200	CS393	944280174800	CS1051	944280212400	CS1334
943356954010	CA1265IR	944280136300	CS504	944280175000	JS1135	944280213600	CS1410
943356956010	CA818IR	944280136400	CS351	944280177810	CS981	944280218100	CS1421
943356957010	CA845IR	944280138310	CS573	944280178300	CS1062	944280521270	JS650
943356958010	CA1251IR	944280138500	CS390	944280178900	CS1072	944280521580	JS890
943356960010	CA716IR	944280138610	CS317	944280179200	CS879	944280521610	JS1104
943356962010	CA914IR	944280139100	CS576	944280180100	CS519	944280521620	JS754
943356963010	CA913IR	944280139400	CS371	944280180200	CS1114	944280521650	JS1094

O.E. NO.	HC-PARTS	O.E. NO.	HC-PARTS	O.E. NO.	HC-PARTS	O.E. NO.	HC-PARTS
<b>MAGNETI MARELLI <i>Continued</i></b>							
944280521660	JS924	944280800610	CS1171	944390322410	CA175IR	944390390000	CA1092IR
944280521680	JS1100	944280800620	CS1174	944390327410	CA288IR	944390390100	CA827IR
944280521700	JS1219	944280800640	CS1125	944390327900	CA294IR	944390390300	CA1142IR
944280521780	JS1225	944280800680	CS879	944390332900	CA321IR	944390390800	CA1143IR
944280521820	JS1306	944280800740	JS1149	944390337600	CA241IR	944390391800	CA1069IR
944280521890	JS1295	944280800780	JS923	944390338300	CA306IR	944390392000	CA1245IR
944280522060	JS336	944280800840	CS1064	944390338600	CA306IR	944390392200	CA1106IR
944280522120	JS383	944280800850	CS1160	944390339000	CA310IR	944390392300	CA1066IR
944280522200	JS377	944280800880	CS1445	944390339100	CA567IR	944390392400	CA1045IR
944280522260	JS392	944280800900	CS1390	944390339800	CA150IR	944390392800	CA908IR
944280522420	JS382	944280800910	CS1078	944390340200	CA335IR	944390393000	CA1043IR
944280522430	JS377	944280800920	CS1208	944390341200	CA566IR	944390393210	CA822IR
944280522570	JS655	944280800930	CS1213	944390344700	CA325IR	944390393500	CA1301IR
944280522580	JS652	944280800940	CS1245	944390344800	CA254IR	944390393700	CA1300IR
944280522590	JS632	944280800960	CS1241	944390345000	CA242IR	944390393900	CA1299IR
944280522650	JS560	944280800970	CS1242	944390345300	CA505IR	944390394200	CA1563IR
944280522700	JS1080	944280801070	CS1204	944390346600	CA507IR	944390394310	CA845IR
944280522760	JS1021	944280801080	CS1207	944390347810	CA378IR	944390394500	CA844IR
944280522770	JS918	944280801100	CS1289	944390348110	CA372IR	944390394810	CA1042IR
944280522790	JS357	944280801110	CS1247	944390348310	CA359IR	944390395010	CA893IR
944280522820	JS918	944280801120	CS1327	944390348610	CA314IR	944390395100	CA1087IR
944280522860	JS1088	944280801130	CS1346	944390356300	CA355IR	944390395400	CA852IR
944280522940	JS902	944280801140	CS1379	944390356700	CA342IR	944390395500	CA1093IR
944280523160	JS365	944280801170	CS1329	944390357100	CA727IR	944390395700	CA1146IR
944280523170	JS365	944280801180	CS1246	944390357300	CA541IR	944390396300	CA1073IR
944280523220	JS325	944280801190	CS1389	944390357500	CA540IR	944390396600	CA1138IR
944280523350	JS1146	944280801300	CS1273	944390357700	CA569IR	944390397000	CA1145IR
944280524100	JS645	944280801330	JS1321	944390358000	CA630IR	944390397300	CA1503IR
944280524190	JS1083	944280801340	CS1336	944390360410	CA560IR	944390397400	CA1044IR
944280524240	JS319	944280801370	CS1193	944390360710	CA584IR	944390397500	CA1395IR
944280524480	JS1360	944280801410	CS1270	944390360710	CA854IR	944390398310	CA1247IR
944280525030	JS318	944280801450	JS1223	944390361000	CA594IR	944390398510	CA913IR
944280525200	JS769	944280801460	JS1224	944390361910	CA717IR	944390399210	CA832IR
944280525200	JS892	944280801480	CS1275	944390362110	CA717IR	944390399310	CA1086IR
944280525240	JS781	944280801640	JS1141	944390365610	CA650IR	944390399510	CA633IR
944280525350	JS1139	944280801700	JS1004	944390365910	CA311IR	944390399910	CA1059IR
944280526120	JS657	944280801730	CS1384	944390366510	CA351IR	944390400010	CA896IR
944280527090	JS558	944280801790	CS1260	944390366900	CA738IR	944390400110	CA1320IR
944280527130	JS1366	944280801800	CS1276	944390367500	CA506IR	944390400210	CA836IR
944280527130	JS671	944280801810	CS1076	944390368310	CA587IR	944390400310	CA535IR
944280527140	JS1366	944280801840	CS1281	944390368910	CA533IR	944390400510	CA535IR
944280528040	JS512	944280801860	CS1332	944390369010	CA643IR	944390400610	CA1040IR
944280528050	JS380	944280801880	CS1291	944390369300	CA909IR	944390400710	CA914IR
944280528100	JS512	944280801890	CS1252	944390369650	CA1455IR	944390400810	CA1036IR
944280528120	JS380	944280801910	CS1265	944390371100	CA739IR	944390400910	CA716IR
944280528150	CS373	944280801920	CS1446	944390371300	CA596IR	944390401410	CA819IR
944280529020	JS549	944280801930	CS1344	944390371400	CA506IR	944390401700	CA1090IR
944280551130	JS1150	944280801940	CS1338	944390371600	CA596IR	944390401800	CA1209IR
944280551840	JS1350	944280801950	CS1054	944390372100	JA757IR	944390402110	CA1065IR
944280555360	CS691	944280801960	JS1305	944390372810	CA640IR	944390402210	CA1152IR
944280556120	CS579	944280801980	CS1391	944390372910	CA524IR	944390402410	CA1080IR
944280556770	JS664	944280802020	CS1379	944390373010	CA526IR	944390403000	JA1176IR
944280557080	CS610	944280802060	JS1320	944390377910	CA735IR	944390403100	CA1207IR
944280558870	JS648	944280802090	CS1332	944390378010	CA556IR	944390403200	CA1239IR
944280703000	JS1298	944280802100	CS1291	944390380300	CA731IR	944390403300	CA1228IR
944280703020	JS1098	944280802110	CS1288	944390380900	CA318IR	944390403400	CA1139IR
944280705010	JS922	944280802120	CS1439	944390381300	CA826IR	944390403500	CA1248IR
944280705030	JS1303	944280802140	CS1339	944390381600	CA1044IR	944390403600	CA1229IR
944280705040	JS1304	944280802160	CS1341	944390381700	CA1062IR	944390404100	CA1102IR
944280705060	JS1313	944280802170	JS1367	944390381900	CA515IR	944390404300	CA1231IR
944280709060	CS1210	944280802180	CS1415	944390382300	CA724IR	944390406000	CA1403IR
944280721000	CS1476	944280802220	JS1234	944390383000	CA700IR	944390406210	CA1221IR
944280721000	JS1302	944280802290	JS1216	944390383200	CA902IR	944390406510	CA1220IR
944280800050	CS1266	944280802380	CS1377	944390383400	CA841IR	944390406610	CA1158IR
944280800100	JS753	944288136500	CS370	944390383800	CA740IR	944390406710	CA1160IR
944280800180	JS1091	944288162100	CS1201	944390386410	CA894IR	944390406910	CA1190IR
944280800190	CS798	944390300500	CG19	944390386500	CA1032IR	944390408400	CA1268IR
944280800220	CS1109	944390306200	CA139IR	944390386710	CA1324IR	944390408500	JA1364IR
944280800310	CS575	944390307500	CA139IR	944390386800	CA1149IR	944390408600	CA1249IR
944280800390	CS1170	944390309400	CA127IR	944390386900	CA1076IR	944390408700	CA1267IR
944280800430	CS975	944390309800	CA129IR	944390387300	CA618IR	944390408800	CA1255IR
944280800460	CS1206	944390309900	CA308IR	944390387400	CA637IR	944390408900	CA1543IR
944280800490	CS788	944390311200	CA93	944390388210	CA606IR	944390409000	CA1075IR
944280800500	JS1158	944390311200	CA93IR	944390388410	CA889IR	944390409300	CA1226IR
944280800510	CS1211	944390315200	CA140IR	944390388610	CA605IR	944390409400	CA1240IR
944280800520	CS1191	944390316800	CA259IR	944390388810	CA818IR	944390409600	JA1134IR
944280800550	CS1124	944390320500	CA176IR	944390389200	JA991IR	944390409700	CA1262IR
944280800570	CS961	944390321210	CA131	944390389600	CA826IR	944390409800	CA1452IR
944280800600	CS1125	944390321510	CA46IR	944390389900	CA1037IR	944390410000	CA1107IR

O.E. NO.	HC-PARTS	O.E. NO.	HC-PARTS	O.E. NO.	HC-PARTS	O.E. NO.	HC-PARTS
944390410100	CA1144IR	944390427200	CA1544IR	944390472700	CA1882IR	944390900400	CA1340IR
944390410600	CA1480IR	944390427600	CA1648IR	944390472800	CA1748IR	944390900410	CA1217IR
944390411000	CA1096IR	944390427800	CA1223IR	944390473000	CA1748IR	944390900460	CA1317IR
944390411200	CA1299IR	944390427900	CA1636IR	944390473100	CA1581IR	944390900470	JA994IR
944390411400	CA1445IR	944390428100	CA1644IR	944390473200	CA1765IR	944390900480	JA1290IR
944390411500	CA1443IR	944390428300	CA1541IR	944390473300	CA1658IR	944390900590	CA1107IR
944390411600	JA987IR	944390428400	CA1673IR	944390473500	CA1841IR	944390900680	JA1174IR
944390411800	JA1377IR	944390428610	JA1520IR	944390473900	CA1877IR	944390900690	CA1318IR
944390411900	CA1569IR	944390430310	JA1134IR	944390474900	CA1840IR	944390900700	JA1183IR
944390412000	CA1140IR	944390436500	CA1489IR	944390475300	CA1656IR	944390900710	CA1154IR
944390412200	CA1299IR	944390436700	CA1776IR	944390479100	CA1928IR	944390900720	CA1342IR
944390412300	CA1402IR	944390439000	CA1481IR	944390483800	CA1919IR	944390900750	CA1390IR
944390412700	CA1440IR	944390439100	CA1630IR	944390510000	CA1396IR	944390900760	CA1483IR
944390412800	CA1492IR	944390439600	CA1561IR	944390510010	CA1386IR	944390900770	CA1475IR
944390412900	CA1591IR	944390440300	CA1577IR	944390510500	JA187IR	944390900780	CA1051IR
944390413100	CA1560IR	944390443100	CA1664IR	944390511370	JA754IR	944390900820	CA1316IR
944390413200	CA1300IR	944390443200	CA1759IR	944390511410	JA672IR	944390900830	CA634IR
944390413300	CA1327IR	944390443300	CA1588IR	944390511470	JA1122IR	944390900860	CA1625IR
944390413510	CA1079IR	944390443400	CA1545IR	944390511510	JA756IR	944390900880	CA1397IR
944390413610	CA1449IR	944390443700	CA1500IR	944390511540	JA868IR	944390900910	JA1162IR
944390413710	CA1200IR	944390443900	CA1567IR	944390511550	JA665IR	944390900920	CA1196IR
944390413810	CA1039IR	944390444100	CA1658IR	944390511560	JA974IR	944390900950	CA1338IR
944390414010	CA1052IR	944390444300	CA1730IR	944390511590	JA769IR	944390900960	CA1348IR
944390414110	CA1077IR	944390444400	CA1582IR	944390511600	JA185IR	944390900970	CA1587IR
944390414210	CA1078IR	944390444600	CA1678IR	944390511620	JA1182IR	944390900980	CA1137IR
944390414310	CA1250IR	944390444700	CA1746IR	944390511630	JA975IR	944390900990	CA1349IR
944390414510	CA1150IR	944390444800	CA1813IR	944390511670	JA1287IR	944390901010	CA1484IR
944390414800	CA1502IR	944390445400	CA1546IR	944390511690	JA1374IR	944390901050	CA1222IR
944390414900	CA1446IR	944390445500	CA1321IR	944390511730	JA769IR	944390901060	CA1555IR
944390415000	CA1378IR	944390447410	CA1100IR	944390511790	JA1528IR	944390901070	JA1175IR
944390415100	CA1436IR	944390448500	CA1540IR	944390511900	JA677IR	944390901090	CA1750IR
944390415200	CA1845IR	944390448800	CA1552IR	944390511930	JA1602IR	944390901130	CA1447IR
944390415900	CA1481IR	944390449000	CA1673IR	944390512060	JA176	944390901160	CA1400IR
944390416500	CA1206IR	944390449100	CA1769IR	944390512710	JA783IR	944390901200	CA1626IR
944390417300	CA1439IR	944390449600	CA1326IR	944390512740	JA142IR	944390901210	JA879IR
944390417400	CA1439IR	944390450310	CA1584IR	944390512830	JA777	944390901240	JA1515IR
944390417500	CA1632IR	944390451010	CA1645IR	944390512880	JA988IR	944390901260	CA1631IR
944390417600	CA1634IR	944390451910	CA1312IR	944390512910	JA1295IR	944390901270	CA1101IR
944390418100	CA1591IR	944390452110	CA1392IR	944390512920	JA1119IR	944390901280	CA1199IR
944390418200	CA1329IR	944390453000	CA1729IR	944390512940	JA1410IR	944390901300	CA1473IR
944390418300	CA1257IR	944390453100	CA1815IR	944390512970	JA1536IR	944390901320	CA1061IR
944390418500	CA1628IR	944390453200	CA1817IR	944390512980	JA1535IR	944390901380	CA1474IR
944390419000	CA1549IR	944390453300	CA1818IR	944390514230	JA980IR	944390901390	CA1546IR
944390419100	CA1504IR	944390453400	CA1782IR	944390514240	JA753IR	944390901430	CA2024IR
944390419200	CA1542IR	944390453500	CA1912IR	944390514250	JA1514IR	944390901450	CA1488IR
944390419300	CA1509IR	944390453600	CA1763IR	944390515120	JA148IR	944390901480	CA1302IR
944390419500	CA1482IR	944390453700	CA1779IR	944390515300	JA598IR	944390901510	CA1756IR
944390419900	JA1415IR	944390453800	CA1752IR	944390515540	JA689IR	944390901520	CA1306IR
944390420000	CA1471IR	944390453900	CA1810IR	944390515640	JA1522IR	944390901540	JA867IR
944390420100	CA1485IR	944390454200	CA1701IR	944390515650	JA1522IR	944390901570	CA1671IR
944390420200	CA1486IR	944390454810	JA1520IR	944390515660	JA1533IR	944390901600	CA1559IR
944390420310	CA1343IR	944390456710	JA1607IR	944390515720	JA1805IR	944390901650	JA1594IR
944390420410	CA1434IR	944390457010	JA1607IR	944390518050	JA171IR	944390901670	JA1368IR
944390420710	CA1442IR	944390457910	JA1293IR	944390518080	JA798IR	944390901690	CA1661IR
944390420810	CA1496IR	944390458210	JA1595IR	944390518120	JA1356IR	944390901720	CA1640IR
944390420910	CA1564IR	944390458610	JA1517IR	944390518130	JA1293IR	944390901730	CA1734IR
944390421010	CA1344IR	944390458910	JA1410IR	944390518150	JA1430IR	944390901740	CA1820IR
944390421210	CA1333IR	944390460100	CA1570IR	944390518160	JA1293IR	944390901750	CA1652IR
944390421310	CA1345IR	944390460500	CA1587IR	944390605020	JA870IR	944390901760	CA1635IR
944390421410	CA1303IR	944390460700	CA1729IR	944390605030	JA1716IR	944390901770	CA1638IR
944390421510	CA1322IR	944390460900	CA1743IR	944390605100	JA1788IR	944390901780	JA1608IR
944390421710	CA1157IR	944390461000	CA1512IR	944390605110	JA1718IR	944390901880	CA1766IR
944390421810	CA1444IR	944390461100	JA1894IR	944390605140	JA1715IR	944390901900	CA2059IR
944390421910	CA1304IR	944390461300	CA1773IR	944390609080	JA1600IR	944390901910	CA1742IR
944390422010	CA1309IR	944390461400	CA1833IR	944390621060	JA1794IR	944390901930	CA1688IR
944390422210	CA607IR	944390461600	CA1754IR	944390621080	JA1722IR	944390901940	CA1766IR
944390422310	CA1060IR	944390461800	CA1811IR	944390662850	CA1252IR	944390901950	CA1855IR
944390425400	CA1623IR	944390461900	CA1683IR	944390664130	CA1487IR	944390901960	CA1862IR
944390425500	CA1689IR	944390462100	CA1837IR	944390900040	CA1512IR	944390901970	CA1643IR
944390425600	CA1656IR	944390462200	CA1825IR	944390900050	JA1526IR	944390901980	CA1781IR
944390425700	CA1872IR	944390462300	CA1828IR	944390900060	JA1521IR	944390902010	CA1208IR
944390426000	CA1511IR	944390462500	CA1824IR	944390900070	JA863IR	944390902050	CA1767IR
944390426100	CA1547IR	944390462700	CA1660IR	944390900100	CA1472IR	944390902060	CA1995IR
944390426200	CA1568IR	944390462800	CA1863IR	944390900140	CA1034IR	944390902100	CA1856IR
944390426300	CA1566IR	944390463000	CA1775IR	944390900160	JA1172IR	944390902130	CA1879IR
944390426600	JA1605IR	944390463200	CA1846IR	944390900170	JA1370IR	944390902140	CA1688IR
944390426900	CA1075IR	944390463300	CA1859IR	944390900270	CA1230IR	944390902150	CA1830IR
944390427000	CA1441IR	944390463400	CA1764IR	944390900280	CA1253IR	944390902180	CA1350IR
944390427100	CA1548IR	944390472200	CA1867IR	944390900310	CA1258IR	944390902200	CA2037IR

O.E. NO.	HC-PARTS	O.E. NO.	HC-PARTS	O.E. NO.	HC-PARTS	O.E. NO.	HC-PARTS
<b>MAGNETI MARELLI <i>Continued</i></b>							
944390902230	CA1857IR	944390904190	CA1778IR	MAN7005	CA1995IR	MSN219	CS240
944390902240	CA1350IR	944390904200	CA1506IR	MAN7007	CA1998IR	MSN224	CS682
944390902250	CA1680IR	944390904210	JA1615IR	MAN7009	CA1998IR	MSN227	CS572
944390902320	CA1760IR	944390904220	CA2044IR *	MAN7011	CA1886IR	MSN229	CS230
944390902330	CA1649IR	944390904230	JA1798IR	MAN7015	CA2016IR	MSN237	CS231
944390902390	CA1646IR	944390904240	JA1804IR	MAN7016	CA2048IR	MSN242	CS689
944390902400	CA1777IR	944390904250	CA2058IR *	MAN7017	CA2049IR *	MSN2616	CS1446
944390902420	CA1922IR	944390904260	CA1959IR	MAN7018	CA2050IR *	MSN2626	CS1433
944390902480	CA1642IR	944390904270	CA2057IR	MAN7019	CA1862IR	MSN290	CS90
944390902510	CA1832IR	944390904280	CA1904IR	MAN7021	CA1855IR	MSN294	CS91
944390902520	CA1780IR	944390904290	CA2043IR	MAN7022	CA1862IR	MSN303	CS275
944390902550	CA1758IR	944390904310	CA1874IR	MAN7031	CA2096IR *	MSN320	CS378
944390902690	JA1425IR	944390904320	CA1931IR	MAN7300	CA1681IR	MSN332	CS393
944390902710	CA1380IR	944390904330	CA1926IR	MAN7402	CA1340IR	MSN402	CS1125
944390902770	JA1710IR	944390904440	JA1618IR	MAN7407	CA1925IR	MSN520	CS285
944390903020	CA1651IR	944390904460	CA1888IR	MAN7410	CA1340IR	MSN521	CS232
944390903030	JA1376IR	944390904470	CA1920IR	MAN7412	CA1475IR	MSN540	CS1032
944390903040	CA1191IR	944390904510	JA1717IR	MAN7413	CA1475IR	MSN614	CS335
944390903170	CA1757IR	944390904570	JA1895IR	MAN7416	CA1834IR	MSN621	CS1076
944390903180	CA1768IR	944390904580	CA1887IR	MAN7418	CA1999IR	MSN625	CS1076
944390903200	CA1325IR	944390904590	CA2038IR	MAN7420	CA1931IR	MSN634	CS1037
944390903210	CA1653IR	944390904620	JA1803IR	MAN7421	CA1989IR	MSN642	CS1067
944390903220	CA1998IR	944390904640	CA1772IR	MAN7423	CA1955IR	MSN800	CS1206
944390903230	CA1641IR	944390904650	CA1829IR	MAN7424	CA1956IR	MSN8059	JS1369
944390903240	CA1884IR	944390904660	JA1808IR	MAN7425	CA1987IR	MSN8072	CS1413
944390903250	CA2045IR	944390904670	CA1864IR	MAN7480	CA2077IR *	MSN808	CS1265
944390903260	CA1890IR	944390904710	CA1921IR	MAN7490	CA1885IR	MSN8110	CS1283
944390903280	CA1199IR	944390904800	JA1891IR	MAN7491	CA1890IR	MSN829	CS1192
944390903300	CA1499IR	944390904810	CA1952IR	MAN7492	CA1884IR	MSN882	JS1311
944390903310	CA1622IR	944399379110	CA229IR	MAN7493	CA1855IR	MSN927	CS800
944390903340	CA1697IR	944399425200	CA1489IR	MAN7494	CA1934IR	MSR2033	CS1060
944390903360	JA1899IR	944399425300	CA1489IR	MAN7495	CA1935IR	MSR308	CS168
944390903370	CA1946IR	30000A	CS610	MAN786	CA1379IR	MSR342	CS95
944390903380	CA1911IR	30001A	CS610	MAN807	CA1084IR	MSR343	CS126
944390903400	CA1256IR	30002A	CS610	MAN833	CA1083IR	MSR343	CS94
944390903410	JA1703IR	30003A	CS610	MAN938	CA1217IR	MSR350	CS1166
944390903420	CA1923IR	63321711B	CA1649IR	MAR1142	JA1521IR	MSR364	CS310
944390903450	CA1676IR	63321730A	CA1217IR	MAR410	CA229IR	MSR365	CS326
944390903470	CA1737IR	63321730B	CA1217IR	MAR469	CA525IR	MSR377	CS342
944390903480	JA1727IR	E100-1.3/12V8	CS139	MAR473	CA136IR	MSR379	CS372
944390903490	JA1606IR	E76-0.5/12S-V9	CS397	MAR480	CA87IR	MSR381	CS1177
944390903530	JA1725IR	E84-0.8/12V1	CS91	MAR572	CA347IR	MSR381	CS373
944390903540	JA1708IR	E84-0.8/12V3	CS90	MAR942	CA833IR	MSR393	CS352
944390903550	CA1675IR	E84-0.8/12V4	CS147	MAR950	CA1054IR	MSR407	CS326
944390903560	CA1774IR	E84-0.8/12V5	CS141	MAR955	CA861IR	MSR409	CS389
944390903570	CA1970IR	M125M3-Z9(3/12)	CS240	MAR959	CA1053IR	MSR419	CS574
944390903590	CA1865IR	MAN1038	CA1751IR	MAR963	CA524IR	MSR425	CS716
944390903600	JA1806IR	MAN1102	CA1216IR	MAR965	CA838IR	MSR435	CS310
944390903610	CA1104IR	MAN1104	CA1208IR	MAR966	CA618IR	MSR459	CS162
944390903620	CA1307IR	MAN1116	CA1753IR	MAR967	CA639IR	MSR463	CS116
944390903630	CA1905IR	MAN1125	CA2059IR *	MSN157	JS627	MSR470	CS347
944390903640	JA1712IR	MAN1128	CA1696IR	MSN2009	CS1203	MSR476	CS263
944390903650	JA1724IR	MAN1155	CA1772IR	MSN2025	CS1044	MSR483	CS295
944390903700	CA1872IR	MAN1156	CA2060IR *	MSN2028	CS624	MSR484	CS341
944390903720	CA1879IR	MAN1162	CA2062IR *	MSN2042	CS1279	MSR486	CS322
944390903730	CA1622IR	MAN1163	CA1641IR	MSN2069	CS1053	MSR490	CS1162
944390903740	CA1873IR	MAN1165	CA618IR	MSN2071	CS612	MSR511	CS358
944390903760	JA1790IR	MAN1170	CA1625IR	MSN2072	CS1213	MSR514	CS332
944390903770	CA2000IR	MAN1171	CA1830IR	MSN2077	CS1394	MSR516	CS188
944390903790	CA1937IR	MAN2005	CA618IR	MSN2078	CS1334	MSR5301	CS712
944390903800	CA1578IR	MAN2006	CA1438IR	MSN2081	CS1172	MSR5313	CS1057
944390903810	CA2034IR	MAN2025	CA2040IR	MSN2088	CS624	MSR5439	CS1211
944390903850	JA1612IR	MAN2027	CA2024IR	MSN2093	CS1282	MSR5442	CS961
944390903870	CA1682IR	MAN2028	CA1779IR	MSN2094	CS1330	MSR665	CS338
944390903890	CA1675IR	MAN2030	CA1679IR	MSN2095	CS1324	MSR676	CS616
944390903900	CA1756IR	MAN2036	CA1257IR	MSN2097	CS1197	MSR677	CS713
944390903910	CA1814IR	MAN2037	CA1446IR	MSN2098	CS1119	MSR680	CS194
944390903930	CA1976IR	MAN2040	CA1648IR	MSN2101	CS1347	MSR683	CS103
944390903940	CA1653IR	MAN2041	CA1915IR	MSN2102	CS1294	MSR697	CS103
944390903950	JA1709IR	MAN2042	CA1648IR	MSN2103	CS1409	MSR699	CS186
944390903980	CA1982IR	MAN2043	CA1748IR	MSN2104	CS1293	MSR700	CS97
944390904010	CA1953IR	MAN2045	CA1812IR	MSN2105	CS1323	MSR701	CS1474
944390904040	CA1755IR	MAN2637	CA1745IR	MSN2106	CS1286	MSR705	CS501
944390904070	JA1721IR	MAN2801	CA1053IR	MSN2107	CS1393	MSR707	CS114
944390904080	CA1964IR	MAN306	CA375IR	MSN2109	CS988	MSR727	CS120
944390904090	CA832IR	MAN349	CA1435IR	MSN2113	CS1181	MSR733	CS395
944390904100	CA1823IR	MAN382	CA893IR	MSN2116	CS1379	MSR734	CS607
944390904120	CA1933IR	MAN7001	CA1844IR	MSN215	CS232	MSR737	CS1173
944390904130	JA1893IR	MAN7004	CA1885IR	MSN215	CS232	MSR742	CS269





O.E. NO.	HC-PARTS	O.E. NO.	HC-PARTS	O.E. NO.	HC-PARTS	O.E. NO.	HC-PARTS
<b>MAZDA Continued</b>							
2936-18-300	JA121 ▲	B675-18-300D	JA173IR	F811-18-300G	JA191IR	JE16-18-400B	JS635
3919-18-300	JA121	B676-18-400	JS1000	F820-18-300	JA191IR	JE26-18-400	JS635
3936-18-300	JA121	B676-18-400A	JS1000	F850-18-400	JS325	JE27-18-300	JA1277IR
4095-18-300	JA125IR	B676-18-400B	JS1000	F851-18-300	JA116IR	JE27-18-400B	JS768
4130-18-300	JA125IR	B6BF-18-300	JA1188IR	F8B1-18-300	JA575IR	JE28-18-300	JA1416IR
4780-18-400	JS907	B6BF-18-300D	JA1188IR	F8B1-18-300B	JA575IR	JE34-18-300A	JA1416IR
4828-18-300	JA116IR	B6DK-18-400	JS325	F8B1-18-300B	JA575IR	JF01-18-400A	JS768
4840-18-400	JS1011	B6S8-18-400	JS1000	F8B1-18-300C	JA575IR	JF01-18-400B	JS768
4892-18-300	JA121	B6S8-18-400A	JS1000	F8B1-18-300D	JA575IR	JF01-18-400C	JS768
4893-18-400	JS674	BJ01-18-300	JA129IR	F8B1-18-400	JS640	JF07-18-300	JA1277IR
4894-18-300	JA121	BP02-18-300	JA599IR	F8B1-18-400A	JS640	K621-18-400	JS903
8028-18-300	JA121	BP4W-18-300C	JA1283	F8B7-18-300	JA575IR	K711-18-400C	JS365
8042-18-300	JA120	BP6D-18-300A	JA1409	FA05-18-400	JS325	K801-18-300	JA806IR
8086-18-300	JA120	BPD3-18-300	JA1353IR	FE01-18-300	JA128IR	K801-18-300B	JA806IR
8088-18-400	JS327	BPD4-18-400	JS1136	FE05-18-300	JA128IR	K801-18-300C	JA806IR
8131-18-400	JS646	BPD4-18-400A	JS1136	FE05-18-400	JS325	K801-18-300D	JA806IR
8173-18-300	JA884IR	BPE8-18-300	JA1188IR	FE1H-18-400	JS637	K801-18-400	JS756
8218-18-400	JS327	BPE9-18-300	JA1188IR	FE2K-18-300	JA128IR	K805-18-400	JS747
8222-18-400	JS327	BPE9-18-300A	JA1188IR	FE50-18-400	JS325	KG21-18-400	JS903
8318-18-300	JA121	C201-18-300	CA1737IR	FE5A-18-400	JS640	KL06-18-400	JS756
8341-18-300	JA884IR	C401-18-300	CA1780IR	FE5A-18-400A	JS640	KL11-18-300D	JA806IR
8356-18-300	JA125IR	C601-18-400	CS1050	FE65-18-300	JA174IR	KL36-18-400	JS919
8492-18-300	JA125IR	C601-18-400A	CS1050	FE65-18-300A	JA174IR	KL36-18-400B	JS1097
8505-18-400	JS1000	D272-10-346A	JA121	FE65-18-300B	JA174IR	L327-18-400	CS1436
8574-18-300	JA125IR	D306-18-400	JS395	FE68-18-300	JA174IR	L3P9-18-300A	CA2014
8599-18-400	JS903	D401-18-300	JA116IR	FE79-18-300	JA174IR	L3P9-18-300B	CA2014
8871-18-300	JA120	D429-18-300	JA125IR	FE79-18-300B	JA174IR	L3P9-18-300C	CA2014
8936-18-400	JS646	D47Z-18-300	JA121	FE79-18-300E	JA174IR	L3P9-18-300D	CA2014
8937-18-400	JS395	D501-18-300	JA116IR	FE79-18-400	JS325	L813-18-300	JA1705
8964-18-400	JS327	D501-18-400	JS646	FE85-18-300	JA531IR	L813-18-400	JS1317
AM15-18-400	JS628	D502-18-400	JS646	FEB1-18-300	JA174IR	LF18-18-300	JA1705 ▲
AM21-18-300	JA151IR	D505-18-400	JS646	FEG1-18-300	JA191IR	LF1F-18-300	JA1902
B101-18-300	JA129IR	D505-18-400B	JS646	FEG7-18-300	JA191IR	LF50-18-300	JA1902
B101-18-300B	JA129IR	D530-18-400	JS646	FEH1-18-300	JA191IR	LF50-18-300A	JA1902
B101-18-400	JS633	E116-18-300	JA129IR	FEHE-18-300	JA985IR	LFG1-18-400	CS1493
B101-18-400B	JS633	E301-18-300	JA127IR	FEHE-18-300A	JA985IR	LFY8-18-300	JA1705 ▲
B113-18-300	JA803IR	E301-18-400	JS325	FEJM-18-300	JA1286IR ▲	N221-18-300	JA104IR
B115-18-300	JA803IR	E302-18-300	JA795IR	FEN8-18-300	JA191IR	N222-18-300	JA125IR
B301-18-400	JS633	E303-18-300	JA127IR	FESE-18-400	JS674	N245-18-300	JA174IR
B303-18-400	JS1098	E331-18-300	JA127IR	FEV4-18-300	JA174IR	N249-18-300	JA531IR
B315-18-400	JS640	E331-18-300A	JA127IR	FFSC-18-400	JS674	N318-18-300	JA804IR
B33M-18-300A	JA1610	E356-18-300	JA129IR	FFSC-18-400A	JS674	N320-18-300	JA804IR
B34P-18-300A	JA1283 ▲	E356-18-400	JS640	FFSN-18-400	JS674	N326-18-300	JA804IR
B361-18-300G	JA699IR	E356-48-400B	JS1000	FP13-18-400	JS1096	N326-18-400	JS752
B366-18-300	JA599IR	E357-18-300	JA129IR	FP34-18-300	JA1409	N337-18-300	JA804IR
B366-18-300E	JA599IR	E357-18-400	JS640	FP34-18-300A	JA1409	N344-18-300	JA804IR
B366-18-300F	JA599IR	E563-18-300	JA127IR	FP34-18-300B	JA1409	N350-18-300	JA1177IR
B366-18-300H	JA699IR	E568-18-300	JA127IR	FP34-18-400A	JS1096	N350-18-300B	JA1177IR
B3C7-18-300	JA694IR	E5A1-18-300	JA127IR	FP50-18-400	CS1479	N370-18-300	JA1177IR
B3D1-18-300	JA694IR	E5D3-18-300	JA129IR	FPG6-18-300	JA1409	PE24-73-1100	JS640
B505-18-400	JS1000	E5D4-18-300	JA129IR	FS05-18-300	JA755IR	PN11-18-300	JA178IR
B593-18-400	JS1000	E611-18-300	JA129IR	FS05-18-300C	JA755IR	PN11-18-400	JS538
B5D8-18-300A	JA1283	F210-18-300	JA559IR	FS05-18-400	JS637	PN12-18-400	JS634
B601-18-300	JA129IR	F210-18-400A	JS640	FS05-18-400A	JS637	PN16-18-300	JA178IR
B603-18-300	JA129IR	F214-18-400	JS636	FS11-18-300	JA1353IR ▲	PN22-18-300	JA178IR
B610-18-300	JA129IR	F214-18-400C	JS636	FS11-18-300A	JA1353IR ▲	PN22-18-400	JS538
B612-18-300	JA129IR	F225-18-300	JA575IR	FS1E-18-300B	JA1598	PN23-18-400	JS634
B612-18-300B	JA129IR	F240-18-400	JS640	FS1E-18-300C	JA1598	PN26-18-300	JA178IR
B617-18-300	JA129IR	F268-18-300	JA1286IR	FS64-18-300	JA755IR	PN40-18-300	JA668IR
B61P-18-300	JA805IR	F285-18-300	JA575IR	G502-18-300A	JA1416IR	PN40-18-400	JS647
B61P-18-300D	JA599IR	F285-18-300C	JA575IR	G601-18-400	JS940	PN40-18-400B	JS647
B61P-18-300E	JA805IR	F290-18-300	JA575IR	G602-18-400B	JS940	PN54-18-300	JA668IR
B61P-18-300F	JA805IR	F2D4-18-400	JS637	G615-18-300	JA1286IR	R201-18-300	JA577IR
B61P-18-400	JS640	F2D4-18-400A	JS637	GE01-18-300	JA116IR	R201-18-300A	JA577IR
B61R-18-400	JS1146	F2E8-18-300	JA1416IR	H612-18-300	JA116IR	R201-18-300B	JA577IR
B61R-18-400A	JS1146	F2J4-18-300B	JA985IR	H834-18-300	JA125IR	R201-18-300C	JA577IR
B61V-18-300	JA599IR	F2JU-18-300A	JA985IR	HE19-18-300	JA125IR	R201-18-300D	JA577IR
B61V-18-300C	JA599IR	F505-18-400	JS637	HE19-18-400	JS327	R201-18-300E	JA577IR
B61V-18-300D	JA599IR	F601-18-300	JA128IR	HE20-18-400	JS327	R201-18-400	JS365
B630-18-400	JS640	F601-18-400	JS325	HE21-18-300	JA125IR	R201-18-400	JS365
B630-18-400A	JS325	F621-18-300	JA191IR	HE26-18-300	JA125IR	R201-18-400A	JS365
B64J-18-300A	JA805IR	F650-18-300	JA531IR	HE41-18-300	JA125IR	R201-18-400A	JS365
B64J-18-300B	JA805IR	F651-18-300	JA531IR	HE45-18-300	JA884IR	R201-18-400B	JS365
B655-18-300	JA129IR	F802-18-400	JS640	HE65-18-400	JS327	R202-18-300	JA577IR
B658-18-400	JS640	F805-18-300	JA531IR	HE66-18-400	JS327	R202-18-300E	JA577IR
B66S-18-300	JA877IR	F805-18-400	JS325	JE01-18-300	JA174IR	R206-18-300	JA801IR
B66S-18-300C	JA877IR	F806-18-400	JS325	JE01-18-400	JS635	R213-18-300	JA180IR
B675-18-300	JA173IR	F807-18-300	JA128IR	JE15-18-300	JA1416IR	R213-18-300B	JA180IR
B675-18-300A	JA173IR	F811-18-300	JA191IR	JE16-18-400	JS635	R213-18-300C	JA180IR

O.E. NO.	HC-PARTS	O.E. NO.	HC-PARTS	O.E. NO.	HC-PARTS	O.E. NO.	HC-PARTS
R229-18-300	JA675IR	Z599-18-300C	JA1283	0031517901	CS583	0051516601	CS1044
R231-18-300	JA675IR	Z599-18-300D	JA1283	0031518601	CS120	0051517301	CS1075
R231-18-300B	JA675IR	Z599-18-300E	JA1283	0031518701	CS186	0051517401	CS1172
R264-18-300	JA577IR	Z5A1-18-300	JA1283	0031518801	CS120	0051517701	CS1072
R269-18-300	JA801IR	ZJ01-18-300	JA1898	0031519801	CS331	0051519701	CS1112
R282-18-300	JA180IR	ZJ01-18-400	JS1361	0031540502	CA37	0051540402	CA184
R286-18-300	JA180IR	ZJ01-18-400A	JS1361	0031541002	CA62	0051541102	CA184
R286-18-300A	JA180IR	ZJ38-18-300	CA2042	0031543302	CA183	0051542902	CA152IR
R286-18-300B	JA180IR	ZJ38-18-400	CS1469	0031543902	CA118	0051543102	CA187IR
R2D3-18-300A	JA577IR	ZM39-18-300	JA1799	0031546102	CA70	0051543202	CA502IR
R2M3-18-300	JA1801IR	AA30G-18-400	JS640	0041510901	CS555	0051543302	CA186IR
R2M3-18-300A	JA1801IR			0041512001	CS576	0051543402	CA333IR
R2M4-18-300A	JA1801IR	MERCEDES BENZ		0041512101	CS794	0051545102	CA187IR
RF01-18-300	JA577IR	0001500550	CA1634IR	0041512201	CS186	0051545202	CA186IR
RF01-18-400	JS365	0001500650	CA1634IR	0041513001	CS794	0051545802	CA87IR
RF03-18-300	JA179IR	0001501650	CA1677IR	0041513501	CS331	0051546002	CA186IR
RF09-18-300	JA577IR	0001501750	CA1838IR	0041513601	CS576	0051546302	CA195IR
RF11-18-300	JA179IR	0001501950	CA1634IR	0041513701	CS583	0051546602	CA195IR
RF11-18-300C	JA179IR	0001502050	CA1634IR	0041514401	CS331	0051546702	CA87IR
RF11-18-300F	JA179IR	0001502250	CA1634IR	0041514501	CS360	0051547402	CA87IR
RF11-18-300G	JA179IR	0001502450	CA1677IR	0041514601	CS327	0051547502	CA87IR
RF11-18-300H	JA179IR	0001502550	CA1838IR	0041515601	CS331	0051547602	CA87IR
RF1G-18-300B	JA1515IR	0001502850	CA1634IR	0041515901	CS120	0051547702	CA87IR
RF1H-18-400	JS1238	0001512801	CS198	0041516001	CS191	0051547802	CA87IR
RF1S-18-300	JA1515IR	0011512901	CS710	0041516101	CS198	0051547902	CA87IR
RF30-18-300	JA577IR	0011513901	CS195	0041516201	CS1381	0051548102	CA595IR
RF30-18-300B	JA577IR	0011514101	CS194	0041516301	CS1162	0051548202	CA132IR
RF31-18-300	JA801IR	0011514801	CS81	0041516401	CS327	0051548302	CA187IR
RF35-18-300	JA179IR	0011516201	CS188	0041516501	CS360	0051548502	CA187IR
RF5C-18-300	JA1896IR	0011516401	CS113	0041516601	CS794	0051549502	CA287IR
RF5C-18-400	JS1296	0011516901	CS1075	0041516701	CS1162	0051549802	CA195IR
RF71-18-300	JA883IR	0011517701	CS81	0041516901	CS1075	0061510301	CS1117
RF71-18-300E	JA883IR	0011519401	CS186	0041517001	CS360	0061510501	CS1249
RF71-18-300H	JA883IR	0011519601	CS120	0041517101	CS1162	0061510601	CS1072
RF79-18-300	JA576IR	0011519701	CS198	0041517301	CS120	0061511001	CS1414
RF7J-18-300A	CA1972	0011546801	CS81	0041517901	CS331	0061511501	CS1463
RF85-18-300	JA576IR	0021506901	CS188	0041518101	CS327	0061512101	CS1381
RF8G-18-300	CA2071	0021510201	CS198	0041518401	CS1112	0061512201	CS1112
RF8G-18-300A	CA2071	0021510701	CS120	0041518501	CS1117	0061512501	CS1410
RF92-18-300	JA576IR	0021510801	CS81	0041518601	CS1279	0061512701	CS576
RF92-18-300C	JA576IR	0021511501	CS81	0041518701	CS789	0061513201	CS331
RFB3-18-300	JA180IR	0021512601	CS113	0041518901	CS1044	0061513701	CS1249
RFB3-18-300A	JA180IR	0021513001	CS188	0041519201	CS1044	0061514101	CS1072
RFG1-18-300	JA876IR	0021513101	CS81	0041519401	CS1077	0061514201	CS1072
RFG1-18-300A	JA876IR	0021514301	CS311	0041519501	CS1168	0061514601	CS1410
RFG1-18-300B	JA876IR	0021515301	CS191	0041519501	CS1168	0061516101	CS1072
RFG7-18-300	JA1282IR	0021515701	CS605	0041519701	CS1044	0061516901	CS1463
RFG7-18-300B	JA1282IR	0021516401	CS113	0041541802	CA87IR	0061517401	CS1410
RFJ5-18-300	JA1430IR	0021516901	CS188	0041542002	CA87IR	0061540502	CA287IR
RFJ5-18-300B	JA1430IR	0021517101	CS81	0041544402	CA69IR	0061540602	CA287IR
RFL1-18-400	JS365	0021518501	CS194	0041544602	CA69IR	0061541502	CA195IR
S210-18-400	JS903	0021519301	CS268	0041545902	CA87IR	0061541602	CA339IR
S211-18-400	JS903	0021519401	CS186	0041547402	CA87IR	0061541702	CA341IR
WL02-18-400A	JS1352	0021519701	CS311	0041548602	CA184	0061542002	CA287IR
WL11-18-300	JA1513IR	0021519801	CS311	0041548702	CA184	0061542102	CA823IR
WL11-18-300A	JA1513IR	0021543802	CA62	0041549502	CA184	0061542402	CA186IR
WL21-18-300	JA1530IR	0021544002	CA62	0051510601	CS1075	0061543002	CA87IR
WL81-18-300	CA1839IR	0031510001	CS268	0051510701	CS1206	0061543902	CA595IR
WL81-18-400	JS1352	0031510401	CS120	0051511101	CS1117	0061544002	CA595IR
WL91-18-300	JA1530IR	0031510501	CS186	0051511301	CS1044	0061544202	CA287IR
WL91-18-400	JS1352	0031510701	CS188	0051511601	CS1172	0061544302	CA287IR
WLAA-18-300A	JA1530IR	0031510801	CS120	0051512001	CS1112	0061546102	CA287IR
Y401-18-300	CA1777IR	0031511101	CS188	0051512101	CS1117	0061546402	CA263IR
Y401-18-400	CS1275	0031511401	CS605	0051512201	CS1381	0061546502	CA263IR
Y401-18-400A	CS1275	0031511801	CS120	0051512601	CS1206	0061546702	CA187IR
Y402-18-300	CA1778IR	0031511901	CS81	0051512701	CS191	0061547302	CA263IR
Y405-18-300	CA2091IR	0031512001	CS716	0051512801	CS198	0061548702	CA321IR
Y405-18-400	CS1275	0031512801	CS327	0051512901	CS1202	0061548802	CA321IR
Y405-18-400A	CS1275	0031512901	CS331	0051513401	CS1075	0061548902	CA321IR
Y406-18-300	CA1970IR	0031513801	CS268	0051513601	CS1075	0071518901	CS1044
Y601-18-300	CA1865IR	0031514501	CS191	0051513801	CS1241	0071519201	CS1044
Y601-18-300A	CA1865IR	0031515001	CS360	0051513901	CS1283	0071540602	CA263IR
Y601-18-300B	CA1865IR	0031515401	CS188	0051514001	CS1283	0071541202	CA87IR
Y601-18-400A	CS1341	0031515701	CS194	0051514601	CS1075	0071542102	CA187IR
Y601-18-400B	CS1341	0031516001	CS194	0051514701	CS1117	0071542302	CA186IR
Y601-18-400C	CS1341	0031516401	CS191	0051515001	CS1269	0071542402	CA568IR
Z505-18-300A	JA1188IR	0031516601	CS195	0051515301	CS1075	0071542702	CA333IR
Z599-18-300	JA1283	0031517301	CS186	0051516401	CS1463	0071542802	CA824IR
Z599-18-300A	JA1283	0031517401	CS120	0051516501	CS1249	0071543302	CA321IR

O.E. NO.	HC-PARTS	O.E. NO.	HC-PARTS	O.E. NO.	HC-PARTS	O.E. NO.	HC-PARTS
<b>MERCEDES BENZ</b> <i>Continued</i>							
0071543402	CA3211R	0101541502	CA14801R	0121544302	CA13901R	A0001501950	CA16341R ▲
0071544002	CA5681R	0101541602	CA14801R	0121544402	CA13901R	A0001502050	CA16341R
0071544802	CA3211R	0101542002	CA3333R	0121544502	CA13421R	A0001502250	CA16341R ▲
0071545202	CA3211R	0101542102	CA11431R	0121544602	CA16301R	A0001502450	CA16771R
0071545302	CA3451R	0101542902	CA18451R	0121545402	CA14811R	A0001502550	CA18381R
0071545402	CA3451R	0101543202	CA13001R	0121545902	CA17011R	A0001502850	CA16341R
0071545502	CA3451R	0101543802	CA13421R	0121546702	CA17391R	A0001512801	CS198
0071545602	CA3451R	0101543902	CA13901R	0121546802	CA16661R	A0011512901	CS710
0071545802	CA2631R	0101544002	CA10571R	0121549802	CA17641R	A0011513901	CS195
0071546002	CA3211R	0101544602	CA10441R	0131540002	CA18591R	A0011514101	CS194
0071546102	CA3211R	0101544702	CA10621R	0131541002	CA18461R	A0011514801	CS81
0071546702	CA3351R	0101544802	CA13951R	0131541302	CA16301R	A0011516201	CS188
0071546802	CA3351R	0101544902	CA10901R	0131541502	CA14811R	A0011516401	CS113
0071549202	CA10351R	0101545102	CA10571R	0131541702	CA14891R	A0011516901	CS1075
0071549902	CA10351R	0101545202	CA10571R	0131542102	CA18401R	A0011517701	CS81
0081541102	CA17351R	0101545402	CA10621R	0131542802	CA16661R	A0011519401	CS186
0081542902	CA7231R	0101545502	CA10441R	0131543202	CA16301R	A0011519601	CS120
0081543002	CA7141R	0101545902	CA14811R	0131543602	CA14891R	A0011519701	CS198
0081543102	CA5681R	0101546402	CA13951R ▲	0131544202	CA17391R	A0011546801	CS81
0081544002	CA6451R ▲	0101546502	CA12991R ▲	0131544302	CA17391R	A0021506901	CS188
0081544202	CA6451R ▲	0101546802	CA12061R ▲	0131546802	CA20721R *	A0021510201	CS198
0081544302	CA6451R	0101547102	CA12061R	0131547102	CA15051R	A0021510701	CS120
0081544802	CA7231R	0101547402	CA12541R	0131547802	CA16661R	A0021510801	CS81
0081544902	CA7141R	0101547502	CA13001R	0131547902	CA17391R	A0021511501	CS81
0081545202	CA7241R	0101547802	CA18451R	0131548002	CA16561R	A0021512601	CS113
0081547402	CA6461R ▲	0101548102	CA13001R	0131548102	CA18721R	A0021513001	CS188
0081547602	CA2631R	0101548302	CA18451R	0131548202	CA17761R	A0021513101	CS81
0081547802	CA12361R	0101548902	CA15051R	0131549002	CA20321R	A0021514301	CS311
0081548302	CA10811R ▲	0101549002	CA15931R	0141540702	CA18591R	A0021515301	CS191
0081548402	CA10811R ▲	0101549102	CA15931R	0141545302	CA16661R	A0021515701	CS605
0081548702	CA3451R	0101549202	CA15051R	1121510001	CS1072	A00215156401	CS113
0081548902	CA3211R	0101549402	CA12991R	1121540202	CA18721R ▲	A0021516901	CS188
0081549202	CA6461R	0101549502	CA14891R	1321510001	CS1452	A0021517101	CS81
0081549602	CA8331R	0101549602	CA14811R	1321540001	CA20121R	A0021518501	CS194
0081549702	CA7241R	0101549802	CA15001R	1351510101	JS1359	A0021519301	CS268
0091540102	CA10441R	0101549902	CA10441R	1351540202	JA18951R	A0021519401	CS186
0091540202	CA10441R	0111540002	CA13951R	1371500550	CA16341R ▲	A0021519701	CS311
0091540602	CA8541R	0111540302	CA13011R	1371500950	CA16341R ▲	A0021519801	CS311
0091540702	CA3331R	0111540402	CA10621R	1601540101	CA16251R	A0021543802	CA62
0091540802	CA8241R	0111540502	CA10901R	1601540201	CA16251R	A0021544002	CA62
0091541502	CA8541R	0111540602	CA14891R	1601540301	CA17341R	A0031510001	CS268
0091541702	CA6461R ▲	0111540702	CA13001R	1601540401	CA17341R	A0031510401	CS120
0091541902	CA10811R	0111540802	CA12991R	1601540501	CA17341R	A0031510501	CS186
0091542502	CA19241R	0111540902	CA14811R	1601540601	CA17341R	A0031510701	CS188
0091542902	CA13011R	0111541002	CA18451R	1611543402	CA10571R	A0031510801	CS120
0091543002	CA10621R	0111542702	CA16561R	1661510001	CS1384	A0031511101	CS188
0091543102	CA15631R	0111543202	CA14911R	1661510101	CS1338	A0031511401	CS605
0091543302	CA12091R ▲	0111543502	CA13421R	1661511001	CS1338	A0031511801	CS120
0091543402	CA8541R	0111545002	CA12361R	2661540602	CA18741R	A0031511901	CS81
0091543602	CA14771R	0111545602	CA13421R	2661540802	CA18751R	A0031512001	CS716
0091543702	CA14771R	0111546202	CA16561R	2661540902	CA18741R	A0031512801	CS327
0091544002	CA7241R	0111546402	CA18721R	2661541302	CA18741R	A0031512901	CS331
0091544102	CA8331R	0111546802	CA16891R	2711540802	CA17521R	A0031513801	CS268
0091544202	CA7241R	0111547002	CA16301R	2711540902	CA17521R	A0031514501	CS191
0091544302	CA10571R	0111547202	CA16891R	2711541002	CA17751R	A0031515001	CS360
0091545102	CA12061R ▲	0111547802	CA14811R	2721540002	CA19081R	A0031515401	CS188
0091545602	CA12061R	0111548002	CA20241R	3661502350	CA8541R	A0031515701	CS194
0091545802	CA10621R	0111548202	CA13901R	4571510301	CS1333	A0031516001	CS194
0091545802	CA10621R	0111548402	CA16231R	6401540102	CA18731R	A0031516401	CS191
0091545902	CA10441R	0111548602	CA16661R	6401540202	CA18731R	A0031516601	CS195
0091546002	CA13001R	0111548702	CA17391R	6401540302	CA18731R	A0031517301	CS186
0091546702	CA12061R ▲	0111548902	CA15051R	6401540402	CA18731R	A0031517401	CS120
0091547202	CA16591R	0111549102	CA18721R	6401540502	CA18731R	A0031517901	CS583
0091547602	CA15001R	0111549202	CA20761R *	6421540502	CA20551R	A0031518601	CS120
0091547702	CA16591R	0111549302	CA16231R	6461540102	CA20381R	A0031518701	CS186
0091548802	CA14771R	0121540002	CA20761R *	6461540802	CA20531R	A0031518801	CS120
0091549302	CA10571R	0121540302	CA17321R ▲	6461541102	CA20381R	A0031518901	CS331
0091549702	CA15931R	0121540402	CA16661R	6469060000	CS1485	A0031540502	CA37
0091549802	CA15931R	0121540502	CA17391R	6601510101	CS1241	A0031541002	CA62
0091549902	CA15051R	0121540902	CA17321R	6601540902	CA20241R	A0031543302	CA183
0101540002	CA15051R	0121541002	CA16661R	6681540102	CA16801R	A0031543902	CA118
0101540102	CA12991R	0121541102	CA17391R	6681540202	CA16801R	A0031546102	CA70
0101540202	CA13001R	0121541302	CA17761R	6681540302	CA16801R	A0041510901	CS555
0101540302	CA12541R	0121541402	CA18311R	0001477V006	CS1241	A0041512001	CS576
0101540402	CA15711R	0121541502	CA16301R	0003188V006	CS1206	A0041512101	CS794
0101540502	CA12991R	0121541702	CA16301R	A0001500550	CA16341R	A0041512201	CS186
0101540602	CA10811R	0121542002	CA14891R	A0001500650	CA16341R	A0041513001	CS794
0101540802	CA12091R	0121542202	CA14891R	A0001501650	CA16771R	A0041513501	CS331
0101541202	CA10811R	0121542402	CA14811R	A0001501750	CA18381R	A0041513601	CS576

O.E. NO.	HC-PARTS	O.E. NO.	HC-PARTS	O.E. NO.	HC-PARTS	O.E. NO.	HC-PARTS
A0041513701	CS583	A0051547402	CA87IR	A0081544202	CA645IR	A0101547102	CA1206IR
A0041514401	CS331	A0051547502	CA87IR	A0081544302	CA645IR	A0101547402	CA1254IR
A0041514501	CS360	A0051547602	CA87IR	A0081544802	CA723IR	A0101547502	CA1300IR
A0041514601	CS327	A0051547702	CA87IR	A0081544902	CA714IR	A0101547802	CA1845IR
A0041515601	CS331	A0051547802	CA87IR	A0081545202	CA724IR	A0101548102	CA1300IR
A0041515901	CS120	A0051547902	CA87IR	A0081547402	CA646IR	A0101548302	CA1845IR
A0041516001	CS191	A0051548102	CA595IR	A0081547602	CA263IR	A0101548902	CA1505IR
A0041516101	CS198	A0051548202	CA132IR	A0081547802	CA1236IR	A0101549002	CA1593IR
A0041516201	CS1381	A0051548302	CA187IR	A0081548302	CA1081IR	A0101549102	CA1593IR
A0041516301	CS1162	A0051548502	CA187IR	A0081548402	CA1081IR	A0101549202	CA1505IR
A0041516401	CS327	A0051549502	CA287IR	A0081548702	CA345IR	A0101549402	CA1299IR
A0041516501	CS360	A0051549802	CA195IR	A0081549202	CA646IR	A0101549502	CA1489IR
A0041516601	CS794	A0061510301	CS1117	A0081549602	CA833IR	A0101549602	CA1481IR
A0041516701	CS1162	A0061510501	CS1249	A0081549702	CA724IR	A0101549802	CA1500IR
A0041516901	CS1075	A0061510601	CS1072	A0091540102	CA1044IR	A0101549902	CA1044IR
A0041517001	CS360	A0061511001	CS1414	A0091540202	CA1044IR	A0111540002	CA1395IR
A0041517101	CS1162	A0061511501	CS1463	A0091540602	CA854IR	A0111540302	CA1301IR
A0041517301	CS120	A0061512101	CS1381	A0091540702	CA333IR	A0111540402	CA1062IR
A0041517901	CS331	A0061512201	CS1112	A0091540802	CA824IR	A0111540502	CA1090IR
A0041518101	CS327	A0061512501	CS1410	A0091541502	CA854IR	A0111540602	CA1489IR
A0041518401	CS1112	A0061512701	CS576	A0091541702	CA646IR	A0111540702	CA1300IR
A0041518501	CS1117	A0061513701	CS1249	A0091541902	CA1081IR	A0111540802	CA1299IR
A0041518601	CS1279	A0061514101	CS1072	A0091542502	CA1924IR	A0111540902	CA1481IR
A0041518701	CS789	A0061514201	CS1072	A0091542902	CA1301IR	A0111541002	CA1845IR
A0041518901	CS1044	A0061514601	CS1410	A0091543002	CA1062IR	A0111542702	CA1656IR
A0041519201	CS1044	A0061516101	CS1072	A0091543102	CA1563IR	A0111543202	CA1491IR
A0041519401	CS1077	A0061516901	CS1463	A0091543302	CA1209IR	A0111543502	CA1342IR
A0041519501	CS1168	A0061517401	CS1410	A0091543402	CA854IR	A0111545002	CA1236IR
A0041519501	CS1168	A0061540502	CA287IR	A0091543602	CA1477IR	A0111545602	CA1342IR
A0041519701	CS1044	A0061540602	CA287IR	A0091543702	CA1477IR	A0111546202	CA1656IR
A0041541802	CA87IR	A0061541502	CA195IR	A0091544002	CA724IR	A0111546402	CA1872IR
A0041542002	CA87IR	A0061541602	CA339IR	A0091544102	CA833IR	A0111546802	CA1689IR
A0041544402	CA69IR	A0061541702	CA341IR	A0091544202	CA724IR	A0111547002	CA1630IR
A0041544602	CA69IR	A0061542002	CA287IR	A0091544302	CA1057IR	A0111547202	CA1689IR
A0041545902	CA87IR	A0061542102	CA823IR	A0091545102	CA1206IR	A0111547802	CA1481IR
A0041547402	CA87IR	A0061542402	CA186IR	A0091545602	CA1206IR	A0111548002	CA2024IR
A0041548602	CA184	A0061543002	CA87IR	A0091545802	CA1062IR	A0111548202	CA1390IR
A0041548702	CA184	A0061543902	CA595IR	A0091545802	CA1062IR	A0111548402	CA1623IR
A0041549502	CA184	A0061544002	CA595IR	A0091545902	CA1044IR	A0111548602	CA1666IR
A0051510601	CS1075	A0061544202	CA287IR	A0091546002	CA1300IR	A0111548702	CA1739IR
A0051510701	CS1206	A0061544302	CA287IR	A0091546702	CA1206IR	A0111548902	CA1505IR
A0051511101	CS1117	A0061546102	CA287IR	A0091547202	CA1659IR	A0111549102	CA1872IR
A0051511301	CS1044	A0061546402	CA263IR	A0091547602	CA1500IR	A0111549202	CA2076IR
A0051511601	CS1172	A0061546502	CA263IR	A0091547702	CA1659IR	A0111549302	CA1623IR
A0051512001	CS1112	A0061546702	CA187IR	A0091548802	CA1477IR	A0121540002	CA2076IR
A0051512101	CS1117	A0061547302	CA263IR	A0091549302	CA1057IR	A0121540302	CA1732IR
A0051512201	CS1381	A0061548702	CA321IR	A0091549702	CA1593IR	A0121540402	CA1666IR
A0051512601	CS1206	A0061548802	CA321IR	A0091549802	CA1593IR	A0121540502	CA1739IR
A0051512701	CS191	A0061548902	CA321IR	A0091549902	CA1505IR	A0121540902	CA1732IR
A0051512801	CS198	A0071518901	CS1044	A0101540002	CA1505IR	A0121541002	CA1666IR
A0051512901	CS1202	A0071519201	CS1044	A0101540102	CA1299IR	A0121541102	CA1739IR
A0051513401	CS1075	A0071540602	CA263IR	A0101540202	CA1300IR	A0121541302	CA1776IR
A0051513601	CS1075	A0071541202	CA87IR	A0101540302	CA1254IR	A0121541402	CA1831IR
A0051513801	CS1241	A0071542102	CA187IR	A0101540402	CA1571IR	A0121541502	CA1481IR
A0051513901	CS1283	A0071542302	CA186IR	A0101540502	CA1299IR	A0121541702	CA1630IR
A0051514001	CS1283	A0071542402	CA568IR	A0101540602	CA1081IR	A0121542002	CA1489IR
A0051514601	CS1075	A0071542702	CA333IR	A0101540802	CA1209IR	A0121542202	CA1489IR
A0051515001	CS1269	A0071542802	CA824IR	A0101541202	CA1081IR	A0121542402	CA1481IR
A0051515301	CS1075	A0071543302	CA321IR	A0101541502	CA1480IR	A0121544302	CA1390IR
A0051516401	CS1463	A0071543402	CA321IR	A0101541602	CA1480IR	A0121544402	CA1390IR
A0051516501	CS1249	A0071544002	CA568IR	A0101542002	CA333IR	A0121544502	CA1342IR
A0051516601	CS1044	A0071544802	CA321IR	A0101542102	CA1143IR	A0121544602	CA1630IR
A0051517401	CS1172	A0071545202	CA321IR	A0101542902	CA1845IR	A0121545402	CA1481IR
A0051517701	CS1072	A0071545302	CA345IR	A0101543202	CA1300IR	A0121545902	CA1701IR
A0051519701	CS1112	A0071545402	CA345IR	A0101543802	CA1342IR	A0121546702	CA1739IR
A0051540402	CA184	A0071545502	CA345IR	A0101543902	CA1390IR	A0121546802	CA1666IR
A0051541102	CA184	A0071545602	CA345IR	A0101544002	CA1057IR	A0121549802	CA1764IR
A0051542902	CA152IR	A0071545802	CA263IR	A0101544602	CA1044IR	A0131540002	CA1859IR
A0051543102	CA187IR	A0071546002	CA321IR	A0101544702	CA1062IR	A0131541002	CA1846IR
A0051543202	CA502IR	A0071546102	CA321IR	A0101544802	CA1395IR	A0131541302	CA1630IR
A0051543302	CA186IR	A0071546702	CA335IR	A0101544902	CA1090IR	A0131541502	CA1481IR
A0051543402	CA333IR	A0071546802	CA335IR	A0101545102	CA1057IR	A0131541702	CA1489IR
A0051545102	CA187IR	A0071549202	CA1035IR	A0101545202	CA1057IR	A0131542102	CA1840IR
A0051545202	CA186IR	A0071549902	CA1035IR	A0101545402	CA1062IR	A0131542802	CA1666IR
A0051545802	CA87IR	A0081541102	CA1735IR	A0101545502	CA1044IR	A0131543202	CA1630IR
A0051546002	CA186IR	A0081542902	CA723IR	A0101545902	CA1481IR	A0131543602	CA1489IR
A0051546302	CA195IR	A0081543002	CA714IR	A0101546402	CA1395IR	▲ A0131544202	CA1739IR
A0051546602	CA195IR	A0081543102	CA568IR	A0101546502	CA1299IR	▲ A0131544302	CA1739IR
A0051546702	CA87IR	A0081544002	CA645IR	A0101546802	CA1206IR	▲ A0131546802	CA2072IR

O.E. NO.	HC-PARTS	O.E. NO.	HC-PARTS	O.E. NO.	HC-PARTS	O.E. NO.	HC-PARTS
<b>MERCEDES BENZ <i>Continued</i></b>							
A0131547102	CA15051R	SM402-01	JS1017	A1T31471	JA155	A2T09691	JA6661R
A0131547302	CA12361R	SM402-04	JS648	A1T31685	JA1161R	▲ A2T09884	JA7751R
A0131547802	CA16661R	SM402-04N	JS648	A1T31699	JA1161R	▲ A2T10083	JA5851R
A0131547902	CA17391R	SM402-05	JS648	A1T32371	JA155	A2T12271	JA172
A0131548002	CA16561R	SM402-05N	JS648	A1T32471	JA1051R	A2T12671	JA1501R
A0131548102	CA18721R	SM402-10	JS626	A1T33277	JA1161R	A2T13391C	CA5561R
A0131548202	CA17761R	SM402-16	JS1083	A1T33371	JA155	A2T13391D	CA5861R
A0131549002	CA20321R	SM402-16N	JS1083	A1T33771	JA1711R	A2T13391E	CA5561R
A0141540702	CA18591R	SM402-17	JS319	A1T40191	JA1131R	A2T13471	JA1291R
A1121510001	CS1072	SM402-17N	JS319	A1T40391	JA1461R	A2T13571	JA1291R
A1121540202	CA18721R	SM402-21N	JS319	A1T40491	JA1461R	A2T13894	JA7621R
A1321510001	CS1452	SM422-09	JS319	A1T40791	JA1461R	A2T13977	JA14161R
A1321540001	CA20121R	SM42226	JS1151	A1T40891	JA1461R	A2T13977X	JA14161R
A1351510101	JS1359	SM422-26	JS1151	A1T41291	JA1131R	A2T14376	JA7931R
A1351540202	JA18951R	SM422-27	JS1150	A1T41991	JA1591R	A2T14472	JA8861R
A1601540101	CA16251R	SM442-10	JS319	A1T70783	JA7961R	A2T14591	CA7381R
A1601540201	CA16251R	SM44223	JS1150	A1TA2291	CA16371R	▲ A2T14592	CA8561R
A1601540301	CA17341R	SM442-23	JS1150	A1TA2293	CA16371R	A2T14694	JA7821R
A1601540401	CA17341R	SM442-25	JS1309	A1TA3391A	CA19321R	A2T14792	JA6901R
A1601540501	CA17341R			A1TA3391B	CA19321R	A2T14792ZC	JA6901R
A1601540601	CA17341R	MITSUBISHI		A1TA3391C	CA19321R	A2T14876	JA7931R
A1611543402	CA10571R	1800A052	CA20121R	A1TA3392A	CA18321R	A2T14972	JA103
A1661510001	CS1384	1800A053	CA20131R	A1TA3392A	CA18321R	A2T15372	JA172
A1661510001	CS1384	1800A070	JA18951R	A1TA3392C	CA18321R	A2T16071	JA172
A1661510101	CS1338	1800A222	JA18951R	A2T00991	JA1151R	A2T16071A	JA172
A2661540602	CA18741R	1810A048	CS1193	A2T01077	JA1781R	A2T16371	JA1501R
A2661540802	CA18751R	1810A050	JS1221	A2T01384	JA7751R	A2T16471	JA1171R
A2661540902	CA18741R	1810A053	JS1140	A2T01483	JA5851R	A2T16871	JA1501R
A2661541302	CA18741R	1810A062	CS1460	A2T01583	JA5851R	A2T17491	CA5871R
A2711540802	CA17521R	1810A101	CS594	A2T01683	JA5851R	A2T17574	JA11771R
A2711540902	CA17521R	1810A111	CS1416	A2T01783	JA5851R	A2T17783	JA6741R
A2711541002	CA17751R	1810A142	CS1510	A2T01976	JA7661R	A2T18177	JA12771R
A2721540002	CA19081R	1810A143	CS1460	A2T02084	JA7751R	A2T18277	JA12771R
A3661502350	CA8541R	A1T01591	JA1131R	A2T02271	JA8651R	A2T18476	JA6681R
A4571510301	CS1333	A1T01791	JA6821R	A2T02471	JA7701R	A2T18874	JA11771R
A6401540102	CA18731R	A1T01991	JA1461R	A2T02572	JA6701R	A2T19677	JA14161R
A6401540202	CA18731R	A1T02091	JA7511R	A2T02577	JA6701R	A2T19777	JA14161R
A6401540302	CA18731R	A1T02191	JA7511R	A2T02671	JA6671R	A2T19877	JA14161R
A6401540402	CA18731R	A1T02291	JA7531R	A2T02771	JA6671R	A2T19991	JA5751R
A6401540502	CA18731R	A1T02292ZC	JA7531R	A2T02871	JA6671R	A2T19991A	JA5751R
A6421540502	CA20551R	A1T02674	CA3591R	A2T02977	JA8651R	▲ A2T20191	JA5751R
A6461540102	CA20381R	A1T02674D	CA3591R	A2T03171	JA6701R	▲ A2T20191ZC	JA5751R
A6461540802	CA20531R	A1T02871	JA1051R	A2T03177	JA6701R	A2T20571	JA120
A6461541102	CA20381R	A1T02991	JA6821R	A2T03471	JA7701R	A2T20971	JA120
A6469060000	CS1485	A1T03191	JA6821R	A2T03477	JA7701R	▲ A2T20972	JA120
A6601540902	CA20241R	A1T03191ZC	JA6821R	A2T03591	JA1151R	A2T21072	JA101
A6611513501	CS331	A1T03195ZC	JA6821R	▲ A2T03691	JA6931R	A2T21982	JA103
A6681540102	CA16801R	A1T03274	JA7741R	▲ A2T03792	JA6881R	A2T22077	JA120
A6681540202	CA16801R	A1T03292	JA7741R	A2T04191	JA1591R	A2T22571	JA172
A6681540302	CA16801R	A1T03391	JA7741R	A2T04271	JA8651R	A2T22871	JA1041R
		A1T03392	JA7741R	A2T04277	JA8651R	A2T23277	JA1511R
		A1T03392	JA7741R	A2T04474	JA8041R	A2T23474	JA8841R
		A1T03392	JA7741R	A2T04474	JA8041R	A2T23477	JA8841R
		A1T03476	JA1161R	A2T04599	JA5761R	A2T23494	JA1251R
		A1T03791	JA7741R	A2T04677	JA5591R	A2T24272	JA1041R
		A1T03792	JA7741R	A2T05291	JA6931R	A2T24371	JA1091R
		A1T04495	JA6821R	A2T05772	JA1731R	A2T24771	JA1511R
		A1T04691	JA7511R	A2T05772X	JA1731R	A2T24971	JA1041R
		A1T04791	JA7511R	A2T05892	JA5751R	A2T24972	JA1041R
		A1T04892	JA7531R	A2T05892A	JA5751R	A2T25071	JA1271R
		A1T04892ZC	JA7531R	A2T05892B	JA5751R	A2T25081	JA7951R
		A1T04991	JA7531R	A2T05892ZC	JA5751R	A2T25171	JA1271R
		A1T05792	JA7741R	A2T05893	JA5751R	A2T25377	JA1621R
		A1T11574	JA872	A2T05893ZC	JA5751R	A2T25578	JA5731R
		A1T20572	JA121	A2T06092	JA5751R	A2T25584	JA5731R
		A1T20574	JA121	A2T06274	JA8041R	A2T25598	JA5731R
		A1T21374	JA121	A2T06384	JA7751R	A2T25972	JA7951R
		A1T22071	JA1051R	A2T06577	JA1741R	A2T26172	JA7951R
		A1T22581	JA100	A2T06871	JA7701R	A2T26391	CA2941R
		A1T22971	JA1051R	A2T06991	JA1461R	A2T26391G	CA2941R
		A1T22975	JA1051R	A2T07371	JA1291R	A2T26471	JA101
		A1T23377	JA1161R	A2T07474	JA8041R	A2T27091	CA2941R
		A1T24371	JA1051R	A2T07677	JA1781R	A2T27091A	CA2941R
		A1T24571	JA1051R	▲ A2T07777	JA1781R	A2T27091C	CA2941R
		A1T25077	JA1161R	▲ A2T08577	JA5761R	A2T27091D	CA2941R
		A1T25083	JA1161R	A2T08577A	JA5761R	A2T27091E	CA2941R
		A1T25097	JA1161R	A2T08577B	JA5761R	A2T27091F	CA2941R
		A1T30471	JA121	A2T09291	JA5981R	A2T27091G	CA2941R
		A1T30474	JA121	A2T09392	JA5981R	A2T27477	JA6751R
		A1T31374	JA1161R	A2T09493	JA6891R		
		A1T31377	JA1161R				

O.E. NO.	HC-PARTS	O.E. NO.	HC-PARTS	O.E. NO.	HC-PARTS	O.E. NO.	HC-PARTS
A2T27477A	JA675IR	A2T40571B	JA199IR	A2T81791A	JA1167IR	A2TB2391	JA1283
A2T27594	JA1275IR	A2T40577	JA199IR	▲ A2T81891	CA1032IR	A2TB2791	CA2099
A2T27594A	JA1275IR	▲ A2T40577B	JA199IR	▲ A2T82091	CA1137IR	A2TB2791ZC	CA2099
A2T27883	JA674IR	A2T40671	JA151IR	A2T82378	JA1430IR	A2TB2891	JA1704IR
A2T28091	JA688IR	A2T40971	JA158IR	A2T82491	JA1287IR	A2TB2991	JA1704IR
A2T28792	CA738IR	A2T40972	JA158IR	A2T82491A	JA1287IR	A2TB3091	CA2083IR
A2T28976	JA668IR	A2T41091	JA128IR	A2T82491B	JA1287IR	A2TB3191	JA1607IR
A2T30477	JA120	A2T41191	JA128IR	A2T82899	JA1183IR	A2TB3191A	JA1607IR
A2T30571	JA120	A2T41371	JA151IR	A2T82899A	JA1183IR	A2TB3691	JA1287IR
A2T30577	JA120	A2T41477	JA147IR	A2T82899AT	JA1183IR	A2TB3691KD	JA1287IR
A2T31574	CA84IR	A2T41599	JA179IR	A2T82899ZT	JA1183IR	A2TB3891	JA1606IR
A2T31677	JA125IR	A2T41599A	JA179IR	A2T83491	JA1188IR	A2TB3891KD	JA1606IR
A2T31977	JA125IR	A2T41599B	JA179IR	A2T83491A	JA1188IR	A2TB4391	CA1043IR
A2T32077	JA675IR	A2T41674	JA174IR	A2TA0091	JA1126IR	A2TB4691	JA1606IR
A2T32171	CA252IR	A2T41677	JA174IR	A2TA0291	CA1086IR	A2TB4791	CA1496IR
A2T32277	JA178IR	A2T41791	JA154IR	A2TA0291B	CA1086IR	A2TB4791A	CA1496IR
A2T32692	CA739IR	A2T41991	JA159IR	A2TA0291C	CA1086IR	A2TB4791B	CA1496IR
A2T32899	JA1416IR	A2T42177	JA174IR	A2TA0291D	CA1086IR	A2TB4891A	CA1564IR
A2T33191	JA1353IR	A2T42571	JA165IR	A2TA0291F	CA1086IR	A2TB4891B	CA1564IR
A2T33191A	JA755IR	A2T42599	JA778IR	A2TA0491	JA1287IR	A2TB4891C	CA1564IR
A2T33191ZC	JA755IR	A2T42671	JA159IR	▲ A2TA1099	JA1513IR	A2TB4891D	CA1564IR
A2T33891	JA1353IR	▲ A2T42677	JA159IR	▲ A2TA1099A	JA1513IR	A2TB5391	CA2083IR
A2T33891ZC	JA1353IR	▲ A2T43099	JA778IR	▲ A2TA1191	JA1188IR	A2TB5791ZC	JA1523IR
A2T33991	JA877IR	▲ A2T43183	JA663IR	▲ A2TA1991	CA1152IR	A2TB6191	JA1283
A2T33991A	JA877IR	A2T43372	JA165IR	A2TA1991D	CA1152IR	A2TB6192	JA1283
A2T34377	JA599IR	A2T43472	JA165IR	A2TA1991F	CA1152IR	A2TB6291	JA1704IR
A2T34477	JA699IR	A2T43583	JA663IR	A2TA1994	CA1043IR	A2TB6481	CA1652IR
A2T34591	CA532IR	A2T43671	JA129IR	A2TA1994B	CA1043IR	A2TB6991	CA2083IR
A2T34591A	CA532IR	A2T43691	JA598IR	▲ A2TA1994C	CA1043IR	A2TB7191	JA1799
A2T34591B	CA532IR	A2T43791	JA154IR	A2TA1994D	CA1043IR	A2TB7591	JA1728IR
A2T34591C	CA532IR	A2T43891	JA159IR	A2TA2091	CA1052IR	A2TB7591ZE	JA1728IR
A2T34598	CA583IR	A2T44071	JA159IR	A2TA2091D	CA1052IR	A2TB7791	JA1409
A2T34598A	CA583IR	A2T44077	JA159IR	A2TA2091E	CA1052IR	A2TB8691	JA1728IR
A2T34598B	CA583IR	A2T44277	JA174IR	A2TA2091F	CA1052IR	A2TC0091	JA1898
A2T34598C	CA583IR	A2T44672	JA165IR	A2TA2094	CA1065IR	A2TC0691	JA1728IR
A2T34692A	JA1292IR	A2T44991	JA191IR	A2TA2094B	CA1065IR	A2TC0691A	JA1728IR
A2T34692B	JA1292IR	A2T45091	JA191IR	A2TA2094C	CA1065IR	A2TC0691AE	JA1728IR
A2T34892	JA1288IR	A2T45272	JA692IR	A2TA2094D	CA1065IR	A2TC0691ZE	JA1728IR
A2T35091	JA1288IR	A2T45272A	JA692IR	A2TA2292	CA856IR	A2TC0981	CA1652IR
A2T35092	JA1288IR	A2T45771	JA165IR	A2TA2392	CA738IR	A2TC0982	CA1948IR
A2T35177	JA699IR	A2T45799	JA778IR	A2TA2492	CA739IR	A2TC1391ZC	CA1981IR
A2T35277	JA599IR	A2T45877	JA174IR	A2TA2591	CA1032IR	A2TC1479ZC	JA1530IR
A2T35791	JA762IR	A2T46591	JA192IR	A2TA3491	JA1126IR	A2TG0281	CA2081IR
A2T35791A	JA762IR	A2T46596	JA191IR	A2TA3791	UA1619	A2TG0391	CA2083IR
A2T36392	JA1185IR	A2T46871	JA129IR	A2TA3991	JA1188IR	A2TG1391	CA2042
A2T36478	JA876IR	A2T46871A	JA129IR	A2TA4091	JA1287IR	A2TJ0291ZE	CA1957IR
A2T36578	JA1282IR	A2T46991	JA159IR	A2TA4091A	JA1287IR	A2TJ0391	CA2014
A2T36578A	JA1282IR	A2T47299	JA179IR	A2TA4092A	JA1287IR	A2TJ0391A	CA2014
A2T37291	JA1407IR	A2T47371	JA129IR	A2TA4991	JA1523IR	A2TJ0391B	CA2014
A2T37391	JA1713IR	A2T47371A	JA129IR	A2TA5191	JA1531IR	A2TJ0391C	CA2014
A2T37391A	JA1713IR	A2T47474	JA804IR	A2TA5391	JA1523IR	A2TJN0076	JA1133IR
A2T37391AC	JA1713IR	A2T47891	JA191IR	A2TA5391ZT	JA1523IR	A2TN0076A	JA1133IR
A2T37391ZC	JA1713IR	A2T47974	JA804IR	A2TA5394	JA1805IR	A2TN0299	JA1411IR
A2T37691	CA1086IR	A2T48091	JA191IR	A2TA5891	JA1188IR	A2TN0399	JA1179IR
A2T37691A	CA1086IR	A2T48176	JA691IR	A2TA5991	JA1185IR	A2TN0499	JA1183IR
A2T37976	JA1187IR	A2T48176A	JA691IR	A2TA5991A	JA1185IR	A2TN0499AT	JA1183IR
A2T38291	JA1279IR	A2T48176B	JA691IR	A2TA6099	JA1530IR	A2TN0499ZT	JA1183IR
A2T38391	JA1167IR	A2T48195	JA1422IR	A2TA6099A	JA1530IR	A2TN0678	JA876IR
A2T38391ZC	JA1167IR	A2T48195A	JA1422IR	A2TA6099AT	JA1530IR	A2TN1199	JA1271IR
A2T38491	JA1126IR	A2T48195B	JA1422IR	A2TA7491	UA1619	A2TN1199A	JA1271IR
A2T38676	JA1133IR	A2T48292	JA166IR	▲ A2TA7491	UA1619	A2TN1199AT	JA1271IR
A2T38891	JA1126IR	A2T48298	JA166IR	▲ A2TA7491ZC	UA1619	A2TN1199ZT	JA1271IR
A2T38892	JA1126IR	A2T48691	JA598IR	▲ A2TA7591	JA1407IR	A2TN1299	JA1411IR
A2T38892A	JA1126IR	A2T48791	JA666IR	A2TA7691	JA1407IR	A2TN1299ZT	JA1411IR
A2T39091	JA1407IR	A2T48791ZC	JA666IR	A2TB0091	JA1283	A2TN1798	JA1533IR
A2T39291	JA1353IR	A2T49177	JA174IR	A2TB0091A	JA1283	A2TN1798A	JA1533IR
A2T39391	JA1188IR	A2T49377	JA654IR	A2TB0091B	JA1283	A2TN1798AT	JA1533IR
A2T39391A	JA1188IR	A2T49476	JA654IR	A2TB0191	JA1409	A2TN1798ZT	JA1533IR
A2T39992	JA1279IR	A2T49577	JA766IR	A2TB0191A	JA1409	A2TN2476	JA1133IR
A2T39992A	JA1279IR	A2T49792	JA688IR	A2TB0191B	JA1409	A2TN2476A	JA1133IR
A2T40091	JA1126IR	▲ A2T49891	JA154IR	▲ A2TB0491	JA1606IR	A3T00599	JA983IR
A2T40092	JA1126IR	A2T49992	JA690IR	A2TB0491A	JA1606IR	A3T00692	JA683IR
A2T40092A	JA1126IR	A2T72383	JA1427IR	A2TB0892	JA1523IR	▲ A3T00792	JA683IR
A2T40277	JA108IR	A2T80391	JA1188IR	A2TB1298	JA1515IR	▲ A3T01596	JA1168IR
A2T40374	JA125IR	A2T80591	JA1284IR	A2TB1299	JA1515IR	▲ A3T01598	JA1168IR
A2T40377	JA125IR	A2T80591A	JA1284IR	A2TB1491	CA2099	* A3T01871	JA883IR
A2T40483	JA147IR	A2T80591ZC	JA1284IR	A2TB1491ZC	CA2099	* A3T01872	JA883IR
A2T40484	JA663IR	▲ A2T81499	JA1179IR	A2TB2191A	CA1496IR	A3T01877	JA883IR
A2T40571	JA199IR	A2T81791	JA1167IR	A2TB2291A	CA1564IR	A3T01877A	JA883IR

O.E. NO.	HC-PARTS	O.E. NO.	HC-PARTS	O.E. NO.	HC-PARTS	O.E. NO.	HC-PARTS
<b>MITSUBISHI Continued</b>							
A3T02193.....	JA685IR	A3T45291.....	CA532IR	A3TB2691K.....	CA1741IR	A4T30593.....	JA1131IR
A3T02972.....	JA887IR	A3T45291A.....	CA532IR	A3TB4191.....	JA1522IR	A4TA0091B.....	CA836IR
A3T03099.....	JA677IR	A3T45291C.....	CA532IR	A3TB4981.....	JA1896IR	A4TA0091C.....	CA836IR
A3T03291.....	CA532IR	A3T45291D.....	CA532IR	A3TB5099.....	CA1983IR	A4TA0091D.....	CA836IR
A3T03291A.....	CA532IR	A3T45291F.....	CA532IR	A3TB6581.....	CA1972	A4TA0091E.....	CA836IR
A3T03291B.....	CA532IR	A3T45292.....	CA597IR	A3TB6781.....	CA2071	A4TA0091F.....	CA836IR
A3T03292.....	CA597IR	A3T45292C.....	CA597IR	A3TG0081.....	JA1705	* A4TA0092B.....	CA832IR
A3T03292A.....	CA597IR	A3T45292D.....	CA597IR	A3TG0081A.....	JA1705	▲ A4TA0092C.....	CA832IR
A3T03292B.....	CA597IR	A3T45292F.....	CA597IR	A3TG0091.....	JA1705	A4TA0092D.....	CA832IR
A3T03298.....	CA583IR	A3T45298.....	CA583IR	A3TG0491.....	CA2084IR	* A4TA0094.....	CA1315IR
A3T03298A.....	CA583IR	A3T45298D.....	CA583IR	A3TG1391.....	JA1902	A4TA0094A.....	CA1315IR
A3T03298B.....	CA583IR	A3T45298F.....	CA583IR	A3TG1391A.....	JA1902	A4TA0094B.....	CA1315IR
A3T03392.....	JA671IR	▲ A3T45691.....	JA684IR	▲ A3TG1891.....	CA2015IR	A4TA0094C.....	CA1315IR
A3T03393.....	JA671IR	A3T45693.....	JA684IR	A3TG1891B.....	CA2015IR	A4TA0094D.....	CA2040IR
A3T03393ZC.....	JA671IR	A3T45693ZC.....	JA684IR	A3TG1891ZE.....	CA2015IR	A4TA0094E.....	CA1633IR
A3T03471.....	JA664IR	A3T45694.....	JA684IR	A3TG1891ZEA.....	CA2015IR	A4TA0094F.....	CA1633IR
A3T03492.....	JA664IR	▲ A3T45794.....	JA870IR	A3TG1891ZEB.....	CA2015IR	A4TA8291.....	CA1633IR
A3T03493.....	JA664IR	A3T60G2.....	JA175IR	A3TG2681.....	CA2085IR	* A4TA8292.....	CA1633IR
A3T03493ZC.....	JA664IR	A3T76682.....	JA1524IR	A3TG2681AE.....	CA2085IR	* A4TA8492.....	CA1633IR
A3T04177.....	JA576IR	A3TA0591.....	CA825IR	A3TG2681ZE.....	CA2085IR	* A4TF0091A.....	CA1509IR
A3T04178.....	JA576IR	▲ A3TA0591C.....	CA825IR	A3TG3181.....	CA2013IR	* A4TF0091B.....	CA1509IR
A3T04199.....	JA576IR	A3TA0591D.....	CA825IR	A3TG3691.....	CA1990IR	* A4TJ0081C.....	CA1920IR
A3T04292.....	JA683IR	A3TA0591E.....	CA825IR	A3TG3691ZE.....	CA1990IR	* A4TJ0084.....	CA1920IR
A3T04999.....	JA1130IR	A3TA0591F.....	CA825IR	A3TG3691ZEB.....	CA1990IR	* A4TJ0084A.....	CA1920IR
A3T05192.....	JA1361IR	A3TA0592.....	CA614IR	A3TG4791.....	JA1902	A4TJ0084B.....	CA1920IR
A3T05499.....	JA983IR	A3TA0592C.....	CA614IR	A3TJ0781.....	CA1946IR	A4TJ0084C.....	CA1920IR
A3T06099.....	JA1130IR	A3TA0592D.....	CA614IR	A3TJ0781AE.....	CA1946IR	A4TJ0282.....	CA1971IR
A3T07483.....	JA1184IR	A3TA0592E.....	CA614IR	A3TJ0781ZE.....	CA1946IR	A4TJ0581.....	CA2086IR
A3T08183.....	JA878IR	A3TA0593.....	CA835IR	A3TJ2481.....	CA1979IR	A4TJ0582.....	CA2086IR
A3T08293.....	JA870IR	A3TA0593C.....	CA835IR	A3TJ2481ZE.....	CA1979IR	A4TJ0582ZE.....	CA2086IR
A3T08376.....	JA870IR	▲ A3TA0593D.....	CA835IR	A3TN0199.....	JA1802IR	A4TR5091ZT.....	CA2019IR
A3T08491.....	JA806IR	A3TA0791.....	JA1180IR	A3TN0299.....	JA1802IR	A4TR5188ZT.....	CA1842IR
A3T08491A.....	JA806IR	A3TA0791A.....	JA1180IR	A3TN0399.....	JA1271IR	A4TR5191ZT.....	CA1842IR
A3T08491C.....	JA806IR	A3TA1191.....	JA1601IR	A3TN0499.....	JA1271IR	A4TR5291AT.....	CA2039IR
A3T08491ZC.....	JA806IR	A3TA1191A.....	JA1601IR	A3TN0699.....	JA1419IR	A4TR5291ZT.....	CA2039IR
A3T08699.....	JA1375IR	A3TA2799.....	JA1368IR	A3TN0699A.....	JA1419IR	A4TR5491.....	CA1880IR
A3T09198.....	JA1376IR	A3TA2799A.....	JA1368IR	A3TN0899.....	JA1802IR	A4TR5491AT.....	CA1880IR
A3T09199.....	JA1376IR	▲ A3TA3098.....	JA1376IR	A3TN0899ZT.....	JA1802IR	A4TR5491ZT.....	CA1880IR
A3T09698.....	JA1375IR	A3TA3098A.....	JA1376IR	A3TN0999.....	JA1802IR	A4TR5592ZT.....	CA1883IR
A3T09699.....	JA1375IR	A3TA4399.....	JA1594IR	A3TN1578.....	JA1360IR	A4TR5592ZT.....	CA1883IR
A3T11191.....	JA1173IR	A3TA4791.....	JA1519IR	A3TN1578A.....	JA1360IR	A5T00192.....	JA653IR
A3T11278.....	JA1133IR	A3TA5491.....	JA1522IR	A3TN1578A.....	JA1360IR	A5T00272.....	JA104IR
A3T11278A.....	JA1133IR	A3TA5492.....	JA1522IR	▲ A3TN1791.....	CA1317IR	A5T00877.....	JA599IR
A3T11678.....	JA1360IR	A3TA5591.....	CA1098IR	A4T00891.....	CA614IR	A5T00972.....	JA803IR
A3T11678A.....	JA1360IR	A3TA5591A.....	CA1098IR	A4T00891C.....	CA614IR	A5T01271.....	JA803IR
A3T11991.....	JA1173IR	A3TA5591A.....	CA1646IR	A4T00891D.....	CA614IR	A5T01497.....	JA768IR
A3T12291.....	JA995IR	A3TA6491.....	CA1646IR	A4T00891E.....	CA614IR	A5T01577.....	JA805IR
A3T14491.....	JA1601IR	A3TA6491A.....	CA1646IR	A4T00991.....	CA832IR	A5T01599.....	JA599IR
A3T15099.....	JA1271IR	A3TA6581.....	JA1806IR	A4T00991B.....	CA832IR	A5T01777.....	JA599IR
A3T20777.....	JA125IR	A3TA6581A.....	JA1806IR	A4T00991C.....	CA832IR	A5T01977.....	JA805IR
A3T21277.....	JA125IR	A3TA6581AKD.....	JA1806IR	A4T00991D.....	CA832IR	A5T01977.....	JA805IR
A3T21277.....	JA125IR	A3TA6581KD.....	JA1806IR	A4T00991E.....	CA832IR	A5T02477.....	JA985IR
A3T21278.....	JA125IR	A3TA7791.....	JA1522IR	▲ A4T01493.....	JA995IR	A5T02477X.....	JA985IR
A3T21471.....	JA117IR	A3TA7791K1.....	JA1522IR	▲ A4T01591.....	CA731IR	A5T02577.....	JA985IR
A3T21677.....	JA125IR	A3TA8291.....	CA1852IR	A4T01893.....	JA1373IR	A5T02577X.....	JA985IR
A3T30271.....	JA150IR	A3TA8291RR.....	CA1852IR	A4T02891.....	CA825IR	A5T02677.....	JA1286IR
A3T31977.....	JA125IR	A3TA8491.....	CA1947IR	* A4T02891A.....	CA825IR	A5T02777.....	JA599IR
A3T32272.....	JA158IR	A3TB0291.....	JA1522IR	A4T02891B.....	CA825IR	A5T03092.....	JA974IR
A3T32377.....	JA108IR	A3TB0771.....	JA1615IR	A4T02892.....	CA614IR	A5T03192.....	JA974IR
A3T32872.....	JA175IR	A3TB0891.....	CA1646IR	A4T02892A.....	CA614IR	A5T03391.....	JA694IR
A3T32877.....	JA175IR	▲ A3TB0891A.....	CA1646IR	A4T02893.....	CA835IR	A5T03477.....	JA1286IR
A3T32997.....	JA181IR	A3TB0891B.....	CA1646IR	A4T02893A.....	CA835IR	A5T03477Y.....	JA1286IR
A3T33272.....	JA158IR	A3TB0891C.....	CA1646IR	A4T02893B.....	CA835IR	A5T03479.....	JA1286IR
A3T33377.....	JA108IR	A3TB0991.....	JA1598	A4T02893C.....	CA835IR	A5T03479.....	JA1286IR
A3T33684.....	JA181IR	▲ A3TB1299.....	JA1375IR	A4T02991.....	JA1532IR	A5T03677.....	JA805IR
A3T33698.....	JA181IR	A3TB1999.....	JA1617IR	A4T03091.....	JA1373IR	A5T03677A.....	JA805IR
A3T33772.....	JA107IR	A3TB1999KD.....	JA1617IR	A4T03191.....	JA995IR	A5T03777.....	JA805IR
A3T33977.....	JA125IR	A3TB2291ZC.....	JA1805IR	A4T03292.....	CA614IR	A5T04092.....	JA980IR
A3T34077.....	JA125IR	A3TB2491.....	JA1791	A4T03292A.....	CA614IR	A5T04392.....	JA974IR
A3T34391.....	JA128IR	A3TB2491ZC.....	JA1791	A4T03292B.....	CA614IR	A5T04392A.....	JA974IR
A3T34672.....	JA175IR	▲ A3TB2492ZC.....	JA1791	A4T03293.....	CA835IR	A5T04392B.....	JA974IR
A3T34677.....	JA175IR	A3TB2691.....	CA1741IR	A4T03293A.....	CA835IR	A5T04492A.....	JA974IR
A3T34872.....	JA158IR	A3TB2691B.....	CA1741IR	A4T03392.....	CA832IR	A5T0492B.....	JA974IR
A3T35091.....	JA128IR	A3TB2691C.....	CA1741IR	A4T03392A.....	CA832IR	A5T05091.....	JA689IR
A3T35278.....	JA164IR	A3TB2691D.....	CA1741IR	A4T03392B.....	CA832IR	A5T05473.....	JA1365IR
A3T35278A.....	JA164IR	A3TB2691E.....	CA1741IR	A4T03392BX.....	CA832IR	A5T05473A.....	JA1365IR
A3T35891.....	JA128IR	A3TB2691F.....	CA1741IR	A4T03491.....	CA836IR	A5T05473B.....	JA1365IR
A3T40472.....	JA887IR	A3TB2691G.....	CA1741IR	A4T03491A.....	CA836IR	A5T06291.....	JA980IR
A3T41876.....	JA973IR	A3TB2691H.....	CA1741IR	A4T03491B.....	CA836IR	A5T06391.....	JA980IR
A3T45191.....	CA532IR	A3TB2691J.....	CA1741IR	A4T03492.....	CA832IR	A5T06391ZC.....	JA980IR
				A4T03793A.....	CA832IR	▲ A5T06891.....	JA1182IR



O.E. NO.	HC-PARTS	O.E. NO.	HC-PARTS	O.E. NO.	HC-PARTS	O.E. NO.	HC-PARTS
A5T06891A	JA1182IR	A5TA2591	CA1137IR	A7T03371A	JA1412IR	AH2250C1	JA101
A5T06891B	JA1182IR	A5TA3891	JA1612IR	A7T03771A	JA1413IR	AH2250C31	JA103
A5T06891C	JA1182IR	A5TA3891A	JA1612IR	A7T03771A	JA1413IR	AH2250C42	JA103
A5T06891D	JA1182IR	A5TA3891AC	JA1612IR	A7T30271	JA652IR	AH2250C7	JA101
A5T07091	JA682IR	A5TA3891C	JA1612IR	A7T30371	JA652IR	AH2250H7	JA120
A5T07091A	JA682IR	A5TA3891ZC	JA1612IR	A7T30374	JA652IR	AH2250L1	JA172
A5T07091ZC	JA682IR	A5TA4291	CA2026IR	A7T30392	JA652IR	AH2255H1	JA120
A5T07591	JA1181IR	A5TA4291ZC	CA2026IR	A7T30471	JA652IR	AH2255H7	JA120
A5T07592	JA1181IR	A5TA4391	CA1474IR	A7T30471	JA652IR	APC30305	CA1990IR
A5T07592A	JA1181IR	A5TA4591	JA1514IR	A7T30471A	JA652IR	A-PC303-05	CA1990IR
A5T10271	JA150IR	A5TA4591ZC	JA1514IR	A7T30471B	JA652IR	AQ2260B3	JA158IR
A5T15171	JA150IR	A5TA4791	JA1520IR	A7T30571	JA652IR	AQ2140C4	CA190IR
A5T15471	JA117IR	A5TA5491	JA1514IR	A7T30674	JA652IR	AQ2240K1	JA150IR
A5T15684	JA148IR	A5TA5591	JA1520IR	A7T30872	JA652IR	AQ2245G1	JA151IR
A5T15784	JA148IR	A5TA6191	JA1293IR	AC2025T	JA121	AQ2245K1	JA150IR
A5T15884	JA148IR	A5TA6191ZC	JA1293IR	AC2025T5	JA121	AQ2250D32	JA104IR
A5T16084	JA148IR	A5TA6191ZE	JA1293IR	AC2040K	JA172	AQ2250G1	JA151IR
A5T16384	JA148IR	A5TA6291	CA1498IR	AC2040K1	JA172	AQ2250G7	JA151IR
A5T16471	JA129IR	A5TA6291A	CA1498IR	AC2040K3	JA172	AQ2250K	JA150IR
A5T20374	JA104IR	A5TA6291B	CA1498IR	AG2020N11	JA101	AQ2250K1	JA150IR
A5T20377	JA884IR	A5TA6291C	CA1498IR	AG2030A	JA100	M0T20871	CS594
A5T20387	JA884IR	A5TA6291D	CA1498IR	AG2035A	JA100	M0T20871ZE	CS594
A5T20484	JA148IR	A5TA6291E	CA1498IR	AG2035T	JA121	M0T20872ZE	CS594
A5T20571	JA150IR	A5TA6291F	CA1498IR	AG2035T11	JA121	M0T21471	CS1332
A5T20871	JA104IR	A5TA6291G	CA1498IR	AG2035T2	JA121	M0T21671	CS1487
A5T20872	JA104IR	A5TA6291H	CA1498IR	AG2035T3	JA121	M0T22471	CS1329
A5T20972	JA104IR	A5TA6291ZEB	CA1498IR	AG2035T8	JA121	M0T22472	CS1260
A5T21071	JA151IR	A5TA6291ZEC	CA1498IR	AG2035T9	JA121	M0T30471	JS1366
A5T21077	JA151IR	A5TA6292C	CA1687IR	AG2040AG3	JA101	M0T30475	JS1366
A5T21171	JA151IR	A5TA6292F	CA1687IR	AG2040T	JA120	M0T30771	JS1139
A5T21471	JA127IR	A5TA6292G	CA1687IR	AG2040T1	JA120	M0T32171	JS1367
A5T21472	JA127IR	A5TA6292ZEB	CA1687IR	AG2050N	JA101	M0T32172	JS1367
A5T21684	JA148IR	A5TA6391A	CA1499IR	AG2050N1	JA101	M0T32172ZE	JS1367
A5T21871	JA104IR	A5TA6391B	CA1499IR	AG2050N11	JA101	M0T32271	CS1417
A5T21897	JA104IR	A5TA6391C	CA1499IR	AG2050N14	JA101	M0T32271ZE	CS1417
A5T21984	JA148IR	A5TA6392C	CA1665IR	AG2050N16	JA101	M0T32571ZE	CS1465
A5T21984B	JA148IR	A5TA6591	CA1474IR	AG2050N21	JA101	M0T32771	CS1469
A5T22877	JA531IR	A5TA6891	JA1293IR	AG2050N24	JA101	M0T35471	CS1461
A5T22971	JA658IR	A5TA6891A	JA1293IR	AG2050N26	JA101	M0T35671	CS1488
A5T22971B	JA658IR	A5TA6991A	JA1727IR	AG2050N31	JA101	M0T35672	CS1488
A5T22997	JA659IR	A5TA7091	JA1727IR	AG2050N4	JA101	M0T36071	JS1310
A5T22997B	JA659IR	A5TA7091ZC	JA1727IR	AG2050N6	JA101	M0T36371	CS1493
A5T23171	JA129IR	A5TA7091ZE	JA1727IR	AG2050T15	JA120	M0T45071ZT	CS1111
A5T23377	JA151IR	A5TA7191ZC	JA1727IR	AG2050T16	JA120	M0T45171	CS1442
A5T23784	JA148IR	A5TA7692	CA1737IR	AG2050T5	JA120	M0T45171ZT	CS1442
A5T30171	JA127IR	A5TA7792	CA1780IR	AG2050T6	JA120	M0T45271	JS1359
A5T30574	JA531IR	A5TB0091	JA1897IR	AG2250C7	JA101	M0T45271ZT	JS1359
A5T30871	JA129IR	A5TB0891ZE	CA1943IR	AH2025T11	JA121	M0T45371ZT	CS1425
A5T30977	JA531IR	A5TB1291ZE	CA1943IR	AH2030B6	JA102	M0T45971ZT	CS1425
A5T31177	JA531IR	A5TB1292AE	CA2026IR	AH2035H27	JA121	M0T46171ZT	CS1452
A5T31372	CA96IR	A5TB1391	JA1897IR	AH2035H4	JA121	M0T60081	JS1219
A5T31571	JA129IR	A5TB1391ZD	JA1897IR	AH2035H54	JA121	M0T60081A	JS1219
A5T31671	JA129IR	A5TG0091	JA1895IR	AH2035H7	JA121	M0T70281	JS672
A5T31772	CA96IR	A5TG0091AE	JA1895IR	AH2035L	JA172	M0T70285	JS672
A5T31773	CA96IR	A5TG0091BE	JA1895IR	AH2035M4	JA872	M0T70381	JS1095
A5T31774	CA96IR	A5TG0091ZE	JA1895IR	AH2035N1	JA100	M0T71681	JS1020
A5T31971	JA129IR	A5TG0192A	CA1665IR	AH2035S	JA155	M0T80081	JS1136
A5T32071	JA129IR	A5TG0192B	CA1665IR	AH2035T1	JA121	M0T80281A	JS1301
A5T32174	JA125IR	A5TG0291	CA2004IR	AH2035T2	JA121	M0T80281B	JS1301
A5T32277	JA174IR	A5TG0881ZE	CA2087IR	AH2035T3	JA121	M0T80281ZC	JS1301
A5T32571	JA129IR	A5TG0881ZEB	CA2087IR	AH2035T4	JA121	M0T80285	JS759
A5T40377	JA174IR	A5TG0991	CA2012IR	AH2035T8	JA121	M0T80285A	JS759
A5T41094	JA165IR	A5TJ0091	CA2080IR	AH2035T9	JA121	M0T80381	JS1096
A5T41094B	JA165IR	A7T00171	JA682IR	AH2035Z1	JA121	M0T80881	JS1097
A5T41271	JA199IR	A7T00191	JA682IR	AH2035Z5	JA121	M0T81181	JS1313
A5T41277	JA199IR	A7T00591	JA682IR	AH2040C	CA190IR	M0T81281	JS1139
A5T41477	JA174IR	A7T00598	JA682IR	AH2040H1	JA121	M0T81283	JS1139
A5T41592	JA163IR	A7T01171	JA869IR	AH2040H4	JA121	M0T81284	JS1139
A5T41592B	JA163IR	A7T01174	JA869IR	AH2040H7	JA121	M0T81681	JS1366
A5T41792	JA163IR	A7T01374	JA869IR	AH2040K1	JA172	M0T81981	CS1210
A5T70178	JA972IR	A7T01991	JA682IR	AH2040L1	JA172	M0T82081	CS1244
A5T70183	JA972IR	A7T02491	JA682IR	AH2045K1	JA172	M0T82081ZE	CS1244
A5T70283	JA972IR	A7T02491A	JA682IR	AH2050C	JA101	M0T82281	CS1479
A5TA0791AC	JA682IR	A7T02491B	JA682IR	AH2055H7	JA120	M0T83981	JS1366
A5TA0791ZC	JA682IR	A7T02591	JA682IR	AH2060N2	JA101	M0T84381	JS674
A5TA0991	JA1514IR	A7T02691	JA682IR	AH2140B14	CA17H	M0T84381A	JS674
A5TA0991ZC	JA1514IR	A7T02771	JA869IR	AH2140H54	JA120	M0T84585	JS1016
A5TA1091	JA1520IR	A7T02874	JA869IR	AH2240L1	JA172	M0T84781	JS512
A5TA1091ZC	JA1520IR	A7T03371	JA1412IR	AH2245L1	JA172	M0T84881	JS1316

O.E. NO.	HC-PARTS	O.E. NO.	HC-PARTS	O.E. NO.	HC-PARTS	O.E. NO.	HC-PARTS
<b>MITSUBISHI Continued</b>							
M0T84881ZC	JS1316	M1T72081	JS763	M1T80681	CS1415	M2T51082	JS358
M0T84882ZC	JS1316	M1T72085	JS766	M1T84381ZC	JS1006	M2T51083	JS358
M0T85381	CS1277	M1T72086	JS766	M1T84481	JS670	M2T51085	JS345
M0T85681	JS1153	M1T72086A	JS766	M1T84883	CS1459	M2T51181	JS355
M0T85681ZC	JS1153	M1T72087	JS766	M1T84883ZC	CS1459	M2T51281	JS538
M0T85881	JS1153	M1T72087A	JS766	M1T84884	CS1459	M2T51282	JS538
M0T85981	JS781	M1T72181	JS920	M1T85681	CS1193	M2T51805	JS345
M0T86081	CS594	M1T72181A	JS920	M1T85682	CS1193	M2T52071	JS306
M0T86181	CS1273	M1T72182	JS920	M1T85781	CS1252	M2T52081	JS306
M0T86181	CS1273	M1T72182A	JS920	M1T85781	CS1252	M2T52082	JS306
M0T86481	JS1092	M1T72281	JS937	M1T85981	CS1193	M2T52281	JS538
M0T86581	JS1319	M1T72281A	JS937	M1T86181	JS1153	M2T52871	JS935
M0T86781	CS727	M1T72285	JS937	M1T86481	JS670	M2T52881	JS935
M0T87081	JS1318	M1T72481	JS380	M1T87081	JS1092	M2T52981	JS513
M0T87681	CS1436	M1T72481ZC	JS380	M1T90081	JS647	M2T53081	JS318
M0T87881	CS1332	M1T72483	JS380	M1T90081A	JS647	M2T53082	JS318
M0T88381	CS1273	M1T72483ZC	JS380	M1T90281	CS1177	M2T53083	JS318
M0T90981	JS1317	M1T72581	JS658	M1T93071	CS1460	M2T53085	JS318
M0T91381	JS1361	M1T72583	JS658	M1T93171ZC	CS1460	M2T53781	JS513
M0T91581	CS1273	M1T72583G	JS658	M1T93371	CS1460	M2T53881	JS520
M0T92581	JS674	M1T72781A	JS937	M1T93571	CS1460	M2T53882	JS520
M0T93681	CS1510	M1T72781B	JS937	M2T10071	JS301	M2T53883	JS520
M1T30071	CS1264	M1T72981	JS627	M2T10171	JS300	M2T54085	JS1102
M1T30072	CS1264	M1T72981	JS627	M2T10471	JS322	M2T54091	JS1102
M1T30171	CS1428	M1T72981A	JS627	M2T13081	CS1111	M2T54371	JS903
M1T30172	CS1428	M1T72981A	JS627	M2T13281	CS1186	M2T54372	JS903
M1T50071	CS132	M1T72985	JS627	M2T13581	CS1186	M2T54571	JS1011
M1T50171	CS373	M1T72985	JS627	M2T20181	JS300	M2T54572	JS1011
M1T50172	CS373	M1T72985A	JS627	M2T20181A	JS300	M2T54771	JS662
M1T50471	JS940	M1T72985A	JS627	M2T20181D	JS300	M2T54871	JS363
M1T60081	JS779	M1T73281	JS781	M2T20182	JS303	M2T54881	JS363
M1T60181	JS914	M1T73283	JS781	M2T23081	JS304	M2T54882	JS363
M1T60185	JS914	M1T73381	JS1004	M2T23181	JS305	M2T56071	JS928
M1T60281	JS939	M1T73381ZC	JS1004	M2T23685	JS772	M2T56072	JS928
M1T60285	JS939	M1T73383	JS1004	M2T25481	JS1094	M2T56171	JS344
M1T60285A	JS939	M1T73383ZC	JS1004	M2T25581	JS756	M2T56181	JS344
M1T60381	JS779	M1T73481A	JS768	M2T25681	JS756	M2T56182	JS344
M1T60581	JS890	M1T74081	JS670	M2T25681G	JS756	M2T56185	JS344
M1T61181	JS890	M1T74087	JS670	M2T25772	JS304	M2T56272	JS1014
M1T66081	JS1102	M1T74281	JS1006	M2T30381	JS512	M2T56471	JS1007
M1T70281	JS1092	M1T74281ZC	JS1006	M2T30481	JS394	M2T56472	JS1007
M1T70281ZC	JS1092	M1T74283	JS1006	M2T30581	JS394	M2T56475	JS1007
M1T70283	JS1092	M1T74283ZC	JS1006	M2T30586	JS394	M2T57271	JS344
M1T70283ZC	JS1092	M1T74286ZC	JS1006	M2T30881	JS309	M2T57273	JS344
M1T70381	JS373	M1T74287ZC	JS1006	M2T37081	JS305	M2T57371	JS397
M1T70381A	JS373	M1T74381	JS635	M2T37281	JS558	M2T58381	JS728
M1T70387	JS373	M1T74491	CS882	M2T40081	JS349	M2T58381	JS728
M1T70481	JS628	M1T74491	CS882	M2T41171	JS672	M2T58381	JS728
M1T70481ZC	JS628	M1T74581	JS380	M2T41381	JS512	M2T58381	JS728
M1T70482	JS628	M1T74583	JS380	M2T41581	JS394	M2T58481	JS927
M1T70483	JS628	M1T74583ZC	JS380	M2T41586	JS394	M2T58581	JS915
M1T70483	JS628	M1T75181	JS635	M2T42381	JS394	M2T58881	JS915
M1T70483ZC	JS628	M1T75181	JS635	M2T42881	JS1016	M2T58981	JS1102
M1T70483ZC	JS628	M1T75181A	JS635	M2T42981	JS300	M2T60171	JS769
M1T70485	JS628	M1T75283	JS1092	M2T44081	JS350	M2T60172	JS769
M1T70485A	JS628	M1T75381	JS635	M2T44681	JS350	M2T60185	JS892
M1T70485A	JS628	M1T75581	JS747	M2T44781	JS925	M2T61071	JS769
M1T70781	JS752	M1T75581ZC	JS747	M2T46081	JS512	M2T61072	JS769
M1T70981	JS911	M1T75681	JS670	M2T46081ZE	JS512	M2T61171	JS769
M1T70981A	JS911	M1T76281	JS635	M2T46781ZE	JS1310	M2T61171	JS892
M1T70982	JS911	M1T76481	JS1153	M2T47281	JS349	M2T61272	JS662
M1T70982A	JS911	M1T77081	JS919	M2T47381	CS1210	M2T61871	JS1001
M1T70985	JS773	M1T77181	JS1366	M2T47382	CS1210	M2T61871A	JS1001
M1T71081	JS920	M1T77281	JS759	M2T48081	JS643	M2T61871B	JS1001
M1T71281	JS637	M1T77381	JS637	M2T48381	CS1186	M2T62271	JS1009
M1T71281A	JS637	M1T77381ZC	JS637	M2T48681	JS672	M2T62771	JS892
M1T71281AC	JS637	M1T78881	JS627	M2T49181	JS394	M2T62971	JS344
M1T71281B	JS637	M1T78981	JS781	M2T49189	JS394	M2T63171	JS892
M1T71281ZC	JS637	M1T79081	JS658	M2T49282	JS305	M2T65271	JS777
M1T71381	JS658	M1T79481	CS1175	M2T49283	JS759	M2T65272	JS777
M1T71382	JS658	M1T79482	CS1175	M2T49881	JS350	M2T66871	JS553
M1T71382ZC	JS658	M1T79581	JS1153	M2T50171	JS306	M2T66872	JS553
M1T71481	JS667	M1T79681	JS915	M2T50181	JS306	M2T66873	JS553
M1T71481A	JS667	M1T79781	JS915	M2T50371	JS895	M2T67871	JS553
M1T71681	JS654	M1T80081	CS594	M2T50381	JS895	M2T67872	JS553
M1T71781	JS768	M1T80082	CS594	M2T50391	JS895	M2T67873	JS553
M1T71781A	JS768	M1T80181	CS1504	M2T50481	CS573	M2T67881	JS553
M1T71881	JS636	M1T80381	CS594	M2T50485	CS573	M2T67882	JS553
M1T71881A	JS636	M1T80481	CS594	M2T50981	JS940	M2T67883	JS553

O.E. NO.	HC-PARTS	O.E. NO.	HC-PARTS	O.E. NO.	HC-PARTS	O.E. NO.	HC-PARTS
M2T67884	JS553	M3T21282	JS329	M3T30581	JS309	M3T38882C	JS1000
M2T74171	JS770	M3T21282	JS329	M3T30581H	JS309	M3T38882C	JS640
M2T74371	JS1009	M3T21781	JS329	M3T30581J	JS309	M3T38883	JS640
M2T80582	CS885	M3T21781	JS329	M3T30583	JS309	M3T38885	JS640
M2T84071	JS1140	M3T21781	JS329	M3T30781	JS646	M3T38981	JS380
M2T84071ZT	JS1140	M3T21881	JS329	M3T30782	JS646	M3T39781	CS306
M2T84171	JS1351	M3T21881	JS329	M3T30881	JS1000	M3T39881	CS306
M2T84171ZT	JS1351	M3T21881	JS329	M3T30881	JS640	M3T40371	CS390
M2T84571	JS1351	M3T21882	JS329	M3T30981	JS907	M3T40471	JS557
M2T84771	CS885	M3T21882	JS329	M3T32081	JS327	M3T41081	JS349
M2T85271	JS1444	M3T21882	JS329	M3T32082	JS327	M3T41083	JS349
M2T85671	CS1427	M3T21882D	JS751	M3T32381	JS395	M3T41088	JS349
M2T85672	CS1427	M3T22081	JS327	M3T32382	JS395	M3T41185	JS751
M2T85871	CS1457	M3T22381	JS395	M3T32581	JS350	M3T41282	JS349
M2T87071	JS1140	M3T22581	JS349	M3T32581	JS350	M3T41481	JS378
M2T87071ZT	JS1140	M3T22581	JS350	M3T32582	JS350	M3T41581	JS309
M2T87072ZT	JS1140	M3T22582	JS349	M3T32583	JS350	M3T41681	JS303
M2T87171	JS1227	M3T22582	JS350	M3T32583	JS350	M3T41781	JS380
M2T87171ZT	JS1227	M3T22582	JS350	M3T32584	JS350	M3T41881	JS512
M2T87271	JS1352	M3T22681	JS362	M3T32585	JS396	M3T42781	JS643
M2T87271ZT	JS1352	M3T22781	JS646	M3T32589	JS349	M3T42781ZC	JS643
M2T87371	JS1227	M3T23081	JS303	M3T32591	JS350	M3T43181	JS1366
M2T87471	JS1238	M3T24081	JS327	M3T32592	JS350	M3T43381	JS1003
M2T87671	CS1160	M3T24181	CS89	M3T32593	JS350	M3T43481	JS643
M2T87971	JS1140	M3T24481	JS325	M3T32681	JS362	M3T43581	JS1000
M2T88071	JS1227	M3T24482	JS325	M3T32681	JS362	M3T44081	JS925
M2T88271	JS1140	M3T24482	JS325	M3T32681	JS362	M3T44091ZT	JS925
M2T88372	CS1507	M3T24482	JS325	M3T32781	JS646	M3T44181	JS925
M2T88372ZC	CS1507	M3T24482A	JS325	M3T32782	JS646	M3T44182	JS925
M2T88471	CS1454	M3T24482H	JS640	M3T32782D	JS646	M3T44281	JS512
M2T88473	CS1454	M3T24482HC	JS640	M3T32985	CS310	M3T44481	JS1300
M2T88572	CS1481	M3T24482J	JS640	M3T32986	CS310	M3T48181	JS1146
M2T88572ZC	CS1481	M3T24482K	JS640	M3T32988	CS310	M3T48382	JS557
M2T88671	JS1296	M3T24486	JS325	M3T32989	CS310	M3T49281	JS557
M2T88971	CS1482	M3T24486A	JS325	M3T32991	CS980	M3T49282	JS557
M2T90071	CS373	M3T24486H	JS640	M3T33081	JS633	M3T49381	JS1000
M2T92071	JS365	M3T25081	JS327	M3T33181	JS330	M3T49381	JS640
M2T92071A	JS365	M3T25181	JS329	M3T33181	JS330	M3T49481	JS640
M2T92171	JS634	M3T25281	JS303	M3T33181	JS330	M3T49581	JS640
M2T92172	JS634	M3T25282	JS303	M3T33182	JS394	M3T54072	JS777
M2T92172A	JS634	M3T25781	JS349	M3T33183	JS394	M3T61071	JS344
M2TS0571	CS1439	M3T25781	JS350	M3T33281	JS1098	M3T61171	JS1014
M2TS0575	CS1439	M3T25782	JS349	M3T33481	JS673	M3T70081	JS646
M3T10071	JS320	M3T25782	JS350	M3T33581	JS325	M3T80071	CS77
M3T10271	JS342	M3T25783	JS349	M3T33581	JS325	M3T80571	CS297
M3T10272	JS342	M3T25785	JS349	M3T33582	JS325	M3T90071	US845
M3T10372	JS322	M3T25882	JS349	M3T33582	JS325	M3T90072	US845
M3T10473	JS674	M3T25882	JS350	M3T33582A	JS325	M4T14771	JS352
M3T10473	JS674	M3T25883	JS349	M3T33583	JS640	M4T95481	US811
M3T10475	JS674	M3T25981	JS362	M3T33586	JS325	M7T03774	US823
M3T10476	JS674	M3T26685	JS775	M3T33586A	JS325	M7T03777	US823
M3T10476D	JS674	M3T27581	JS303	M3T33586D	JS640	M8T55071	CS1494
M3T10672	JS302	M3T27582	JS303	M3T33781	JS512	M8T55073	CS1494
M3T12572	JS351	M3T27681	JS304	M3T33781ZC	JS512	M8T61671	CS1383
M3T12572	JS351	M3T27685	JS304	M3T33785	JS512	M8T70071	JS1102
M3T12672	JS537	M3T27686	JS304	M3T33871	JS512	M8T70371	JS1009
M3T13073	JS303	M3T27686D	JS304	M3T33981	JS378	M8T70471	JS1014
M3T15071	JS342	M3T27686H	JS304	M3T33981H	JS378	M8T70471A	JS1014
M3T15072	JS342	M3T27686N	JS304	M3T34081	JS327	M8T71371	JS1235
M3T15073	JS342	M3T27688	JS304	M3T34082	JS327	M8T71371ZE	JS1235
M3T15074	JS342	M3T27781	JS305	M3T34781	JS380	M8T71471	JS1295
M3T15075	JS342	M3T27781D	JS305	M3T34782	JS380	M8T71471ZE	JS1295
M3T15772	JS342	M3T29481	JS303	M3T35081	JS327	M8T71571	JS1009
M3T15772	JS342	M3T29482	JS303	M3T35082	JS327	M8T75071	JS1221
M3T15872	JS342	M3T29681	JS330	M3T37783	JS759	M8T75071A	JS1221
M3T19371	CS93	M3T29681	JS330	M3T38881	JS1000	M8T75073	JS1221
M3T19571	CS130	M3T29681	JS330	M3T38881	JS640	M8T75073A	JS1221
M3T19771	CS306	M3T29681	JS330	M3T38881A	JS1000	M8T75074	JS1221
M3T19871	CS306	M3T30081	JS327	M3T38881A	JS640	M8T75074ZT	JS1221
M3T19971	CS168	M3T30082	JS327	M3T38881B	JS1000	M8T75171	JS1009
M3T20081	JS327	M3T30088	JS327	M3T38881B	JS640	M8T75371	JS1235
M3T20381	JS395	M3T30281	JS325	M3T38881C	JS1000	M8T76071	CS1424
M3T20681	JS302	M3T30281	JS325	M3T38881C	JS640	M8T76071ZE	CS1424
M3T20781	JS646	M3T30281	JS325	M3T38882	JS1000	M8T76072	CS1424
M3T21281	JS329	M3T30282	JS325	M3T38882	JS640	M8T76072ZE	CS1424
M3T21281	JS329	M3T30285	JS325	M3T38882A	JS1000	M8T80071	JS1354
M3T21281	JS329	M3T30286	JS325	M3T38882A	JS640	M8T80071A	JS1354
M3T21281D	JS751	M3T30381	JS395	M3T38882B	JS1000	M8T80071B	JS1354
M3T21282	JS329	M3T30382	JS395	M3T38882B	JS640	M8T85571	CS1494

O.E. NO.	HC-PARTS	O.E. NO.	HC-PARTS	O.E. NO.	HC-PARTS	O.E. NO.	HC-PARTS
<b>MITSUBISHI Continued</b>							
M9T60371	CS1325	MD034130	JA150IR	MD108023	JA667IR	MD172864	JS781
M9T60372	CS1325	MD034131	JA150IR	MD108229	JA667IR	MD174482	JS1095
M9T60471	CS1386	MD034132	JA150IR	MD108230	JA865IR	MD175810	JA1288IR
M9T60671	CS1348	MD034212	JS342	MD108509	JA770IR	MD175811	JA1288IR
M9T60672	CS1348	MD041700	JA151IR	MD108872	JA670IR	MD177596	JS892
M9T61171	CS1388	MD041701	JA151IR	MD109166	JA770IR	MD180238	JS350
M9T61471	CS1495	MD041705	JA117IR	MD111038	JA770IR	MD180239	JS643
M9T61571	CS1386	MD041706	JA175IR	MD111148	JA598IR	MD184279	JA1288IR
M9T61671	CS1432	MD050205	JS344	MD111149	JA598IR	MD184280	JA1185IR
M9T62173	CS1472	MD060793	JA148IR	MD111151	JA688IR	MD188242	JA1173IR
M9T62671	CS1496	MD061150	JA151IR	MD111233	JA159IR	MD188720	JS1020
M9T64171	CS1472	MD061151	JA151IR	MD111228	JA865IR	MD189658	JA1126IR
M9T80071	CS1497	MD061154	JS344	MD111231	JA865IR	MD189659	JA1126IR
M9T80472	CS1463	MD061430	JA147IR	MD111232	JA670IR	MD190812	JA1279IR
M9T80473	CS1463	MD063781	JA117IR	MD111233	JA973IR	MD190819	JA1167IR
M9T82671	CS1451	MD064066	JA151IR	MD111286	JA115IR	MD191402	JA1126IR
M9T82672	CS1451	MD064067	JA151IR	MD111607	JA693IR	MD191433	JS344
M9T83671	CS1463	MD064068	JA151IR	MD111932	JA983IR	MD191435	JS344
MCA01-0	JS301	MD066761	JS349	MD112208	JA670IR	MD191437	JS892
MCA02-0	JS300	MD067411	JA148IR	MD112318	JA775IR	MD192133	JA1187IR
MCA02-2	JS300	MD068565	JA148IR	MD112322	JA683IR	MD192134	JA1133IR
MD001155	JS342	MD069166	JS344	MD112323	JA683IR	MD192135	JA1360IR
MD001333	JS350	MD069859	JA148IR	MD112625	JS658	MD192136	JA1133IR
MD001502	JA172	MD069978	JA146IR	MD114620	JA689IR	MD192227	JS1003
MD001550	JS342	MD070310	JA148IR	MD115514	JS362	MD192228	JS643
MD001553	JS351	MD070933	JS355	MD115687	JA146IR	MD193323	JA1126IR
MD001555	JS350	MD070934	JS344	MD116427	JA770IR	MD194466	JA1279IR
MD003500	JA172	MD072585	JS318	MD120365	JA1131IR	MD194470	JA1173IR
MD003502	JA172	MD072654	JS769	MD121581	JS892	MD194482	JA1284IR
MD003503	JA172	MD073067	JA154IR	MD124233	JA585IR	MD197468	JA1532IR
MD003512	JA172	MD074644	JA159IR	MD124234	JA775IR	MD197469	JA1373IR
MD003513	JA172	MD074744	JA159IR	MD125096	JA666IR	MD197470	JA995IR
MD003516	JA172	MD074992	JA146IR	MD127087	JA793IR	MD197475	JA688IR
MD003517	JA172	MD075795	JA147IR	MD132130	JA793IR	MD198164	JA1167IR
MD003518	JA150IR	MD081567	JS350	MD133171	JA671IR	MD200695	JA1376IR
MD003550	JS342	MD081568	JS350	MD133513	JA664IR	MD257744	CA1585IR
MD003551	JS342	MD085874	JA663IR	MD135825	JA1130IR	MD301348	JS925
MD006187	JA150IR	MD086015	JA148IR	MD136838	JA664IR	MD301348G	JS925
MD006197	JA150IR	MD086016	JA148IR	MD136839	JA671IR	MD303330	JS925
MD007100	JA150IR	MD086046	JA175IR	MD136933	JS658	MD303481	JA1601IR
MD007509	JA150IR	MD086049	JA199IR	MD140189	JA674IR	MD304129	JA1179IR
MD007516	JA172	MD086784	JA159IR	MD140190	JS770	MD304139	JA148IR
MD009052	JA150IR	MD086785	JA159IR	MD141119	JA983IR	MD306648	JA1179IR
MD009053	JA150IR	MD087246	JA663IR	MD141855	JA685IR	MD306649	JA1183IR
MD009054	JA150IR	MD091790	JA159IR	MD147245	JA674IR	MD306649	JA1183IR
MD009070	JA172	MD091791	JA159IR	MD147246	JA1130IR	MD306834	JA1271IR
MD009071	JA150IR	MD091793	JA159IR	MD147246	JA1130IR	MD308088	CS886
MD013740	JA148IR	MD091794	JA154IR	MD149750	JA684IR	MD309333	JA689IR
MD013742	JA663IR	MD091794	JA154IR	MD149751	JA870IR	MD309334	JA1181IR
MD015020	JA199IR	MD091846	JA199IR	MD150657	JA995IR	MD309335	JA1181IR
MD015020	JA199IR	MD091847	JA199IR	MD153357	JA684IR	MD309471	JS658
MD015021	JA199IR	MD091849	JA146IR	MD153843	JA684IR	MD309472	JS781
MD015021	JA199IR	MD091850	JA146IR	MD156986	JS344	MD309843	JA1133IR
MD015040	JA150IR	MD095741	JA148IR	MD156987	JS892	MD309845	JA1126IR
MD015041	JA150IR	MD095865	JS769	MD156989	JS769	MD312857	JS1140
MD016920	JS396	MD099621	JA766IR	MD160540	JA1373IR	MD312858	JS1140
MD016921	JS349	MD099624	JA115IR	MD160671	JA878IR	MD313076	CA1136IR
MD017645	JA872	MD099625	JA154IR	MD161437	JS350	MD313327	JS658
MD021665	JS342	MD099667	JS628	MD162836	JS350	MD313395	JA1180IR
MD021666	JS352	MD100431	JS349	MD162837	JS349	MD313939	JA1183IR
MD021670	JS342	MD102084	JA690IR	MD162838	JS643	MD313940	JA1271IR
MD021674	JS349	MD102085	JA598IR	MD162839	JS628	MD313942	JA1271IR
MD021678	JS350	MD102088	JA666IR	MD162840	JS1004	MD314167	JS1351
MD021685	JS342	MD102747	JA159IR	MD162842	JS658	MD314235	JA1411IR
MD022572	JA151IR	MD102864	JA654IR	MD162843	JS781	MD315432	JA1802IR
MD022576	JA151IR	MD102865	JA654IR	MD162964	JA1184IR	MD315547	JS1351
MD022578	JA151IR	MD103372	JA775IR	MD162975	JS344	MD315548	JS1227
MD022579	JA117IR	MD103373	JA585IR	MD164975	JS344	MD316001	JS350
MD023746	JS318	MD103564	JA585IR	MD164976	JS770	MD317119	JA1601IR
MD023758	JS318	MD104644	JA159IR	MD164977	JS769	MD317401	JA1126IR
MD025679	JA151IR	MD105342	JA688IR	MD164978	JS892	MD317860	JA1523IR
MD027380	JS318	MD105606	JA766IR	MD166174	JA865IR	MD317862	JA1523IR
MD027381	JS318	MD106319	JA585IR	MD168988	JA870IR	MD317866	JA1185IR
MD027382	JS318	MD106320	JA585IR	MD168989	JA870IR	MD318086	JS915
MD027400	JS349	MD106332	JA775IR	MD169683	JA664IR	MD318458	CA1136IR
MD027401	JS349	MD106712	JA670IR	MD171228	JS915	MD320354	JA1419IR
MD027585	JS318	MD106713	JA875IR	MD172860	JS628	MD320618	JS915
MD027661	JA151IR	MD107615	JS349	MD172860	JS628	MD321445	JS925
MD034120	JS350	MD107683	JA151IR	MD172861	JS1004	MD324755	JA995IR
MD034121	JS350	MD108022	JA667IR	MD172863	JS658	MD325696	JA1531IR

O.E. NO.	HC-PARTS	O.E. NO.	HC-PARTS	O.E. NO.	HC-PARTS	O.E. NO.	HC-PARTS
MD325700.....	CA1075IR	ME204424A.....	JS1221	81388310.....	CS595	9AL2924K.....	CA183
MD327514.....	JA1271IR	ME204425.....	JS1221	81391004.....	CS1169	9AL3776G.....	CA75
MD327550.....	CA1136IR	ME204425B.....	JS1221	81391006.....	CS1061	9AL3911.....	CA78
MD327551.....	CA1075IR	ME215097.....	CS1494	81392005.....	CS1333	9AL5050K.....	CA316IR
MD328235.....	JS1313	ME220480.....	CS1494	81392006.....	CS1061	9AR2500K.....	CA52IR
MD329260.....	CS684	MEA01-0.....	JS320	81392007.....	CS1274	9AR2506K.....	CA52IR
MD330800.....	CA1075IR	MEA01-1.....	JS323	81456002.....	CS191	9AR2510.....	CA84
MD331137.....	JS1227	MEA03-0.....	JS537	81460037.....	CS98	9AR2511F.....	CA35IR
MD332022.....	JS1139	MEA03-1.....	JS537	81460046.....	CS99	9AR2517K.....	CA85IR
MD332546.....	JA1411IR	MEA04-0.....	JS322	81466002.....	CS191	9AR2519F.....	CA35IR
MD332547.....	JA1802IR	MEA04-1.....	JS322	81466003.....	CS506	9AR2520K.....	CA52IR
MD334176.....	JA1802IR	MEA04-6.....	JS322	81466005.....	CS544	9AR2524F.....	CA35IR
MD334546.....	JA1411IR	MEA07-0.....	JS302	81466008.....	CS198	9AR2527K.....	CA85IR
MD335584.....	JS1300	MEA07-1.....	JS302	81466009.....	CS506	9AR2533.....	CA325IR
MD336781.....	JA1519IR	MEA07-11.....	JS302	81466023.....	CS191	9AR2533P.....	CA325IR
MD340419.....	JA1533IR	MEA12-1.....	JS323	81466036.....	CS384	9AR2545.....	CA96IR
MD343416.....	JA1522IR	MEA13-1.....	JS343	81466044.....	CS1034	9AR2553.....	CA23V
MD343562.....	JA1523IR	MEA13-2.....	JS343	81466051.....	CS191	9AR2561K.....	CA96IR
MD344182.....	JS1140	MEA24-1.....	JS537	81466052.....	CS502	9AR2562K.....	CA94IR
MD344183.....	JS1227	MEA95-0.....	JS303	81466061.....	CS699	9AR2566K.....	CA23V
MD344963.....	JA1133IR	MEC01-0.....	JS303	81466062.....	CS617	9AR2569G.....	CA60IR
MD344964.....	JA1360IR	MEC01-1.....	JS303	81467001.....	CS198	9AR2570G.....	CA61IR
MD348221.....	JS1140	MEC01-2.....	JS303	81467005.....	CS526	9AR2588K.....	CA124IR
MD350608.....	JA1180IR	MED02-0.....	JS342	81467006.....	CS526	9AR2596K.....	CA124IR
MD350609.....	JA1601IR	MED02-1.....	JS343	81467007.....	CS564	9AR2602F.....	CA190IR
MD353869.....	CA1075IR	MED02-2.....	JS343	81467023.....	CS954	9AR2603F.....	CA259IR
MD354786.....	JA1284IR	MED03-1.....	JS537	81467042.....	CS881	9AR2605L.....	CA141IR
MD354797.....	JA1126IR	MED03-2.....	JS342	81467043.....	CS881	9AR2606K.....	CA52IR
MD354798.....	JA1279IR	MED03-3.....	JS342	81467045.....	CS121	9AR2610G.....	CA61IR
MD354806.....	JA1181IR	MED03-4.....	JS342	81467053.....	CS688	9AR2611F.....	CA190IR
MD356104.....	JS1139	MED03-4.....	JS342	81467065.....	CS962	9AR2613F.....	CA190IR
MD356178.....	CS1459	MED03-4.....	JS537	81467153.....	CS688	9AR2619G.....	CA48IR
MD357744.....	CA1585IR	MED04-2.....	JS303	81468001.....	CS951	9AR2621L.....	CA125IR
MD358421.....	JA1522IR	MM115513.....	JS362	81468009.....	CS506	9AR2622L.....	CA141IR
MD358607.....	JA1522IR	MM115514.....	JS362	081495002.....	CS1381	9AR2630K.....	CA305IR
MD359972.....	JS925	MM115517.....	JS362	081768131.....	CA1148IR	9AR2636G.....	CA136IR
MD360368.....	JS1139	MM409411.....	JS1014	081768135.....	CA907IR	9AR2638P.....	CA125IR
MD360635.....	JA1522IR	MM409413.....	JS1014	081768143.....	CA1505IR	9AR2641G.....	CA81IR
MD361621.....	JA1126IR	MM409414.....	JS895	081769148.....	CA1505IR	9AR2652F.....	CA126IR
MD361624.....	JA1167IR	MN137866.....	JA1419IR	081769686.....	CA333IR	9AR2659K.....	CA170IR
MD362207.....	JS781	MN137867.....	JA1183IR			9AR2660K.....	CA169IR
MD362870.....	JA1805IR	MN155953.....	JA1895IR	MOTOROLA		9AR2662F.....	CA172IR
MD362910.....	CS1459	MQJ1R.....	JS302	2518071.....	CA60IR	9AR2663K.....	CA150IR
MD363639.....	JA1805IR	MQJ2R.....	JS302	2541163.....	CA126IR	9AR2672P.....	CA377IR
MD366050.....	JA1183IR	MR994325.....	JS1139	2541423.....	CA212IR	9AR2673K.....	CA150IR
MD366051.....	JA1271IR	MR994922.....	JS1359	2940060.....	CA857IR	9AR2676K.....	CA224IR
MD366052.....	JA1533IR	MW30620657.....	CS1193	2940080.....	CA305IR	9AR2683G.....	CA61IR
MD368519.....	JA1523IR	MW30638577.....	CA1627IR	510-859.....	CA1201IR	9AR2687F.....	CA176IR
MD374904.....	JA1522IR	MWV10R.....	JS301	510-864.....	CA1202IR	9AR2687G.....	CA176IR
ME007578.....	JA972IR	MWV11R.....	JS301	8EA2002F.....	UA954	9AR2690P.....	CA377IR
ME012295.....	JS1354	MWV3R.....	JS300	8EA2004F.....	UA954	9AR2698F.....	CA190IR
ME013008.....	JS1354	MWV4R.....	JS300	8EA2016F.....	UA954	9AR2699G.....	CA61IR
ME014418.....	JS1354	MWV8R.....	JS301	8EB2002F.....	UA954	9AR2700G.....	CA126IR
ME015766.....	CS1494	MWV9R.....	JS301	8EK2005ND.....	UA935IR	9AR2703F.....	CA190IR
ME017034.....	JS553	MXR.....	JS343	8EK2011FA.....	UA934IR	9AR2706G.....	CA60IR
ME017035.....	JS553	PW501783.....	JS350	8EK2011FB.....	UA934IR	9AR2707G.....	CA126IR
ME017036.....	JS553	XD358597.....	JA1522IR	8EK2011FC.....	UA934IR	9AR2708G.....	CA140IR
ME017056.....	JS553			8EK2012NB.....	UA935IR	9AR2709L.....	CA139IR
ME017061.....	JS553	MONARK		8SC3002Y.....	UA920IR	9AR2712P.....	CA743IR
ME017085.....	JS553	337004.....	CS186	8SC3005Y.....	UA921IR	9AR2720K.....	CA84IR
ME017089.....	JS553	523037.....	CS120	91G2NA2F42.....	CA141IR	9AR2727G.....	CA140IR
ME017560.....	JA972IR	081165106.....	CS624	9AL2505.....	CA166	9AR2728F.....	CA176IR
ME017561.....	JA972IR	081251002.....	CS1112	9AL2505P.....	CA166	9AR2728G.....	CA176IR
ME017562.....	JA1427IR	081251007.....	CS1243	9AL2510.....	CA84	9AR2730P.....	CA175IR
ME017600.....	JA1524IR	081251033.....	CS1112	9AL2538K.....	CA106	9AR2731R.....	CA175IR
ME110JA.....	JS325	81360038.....	CS97	9AL2582K.....	CA148	9AR2746P.....	CA1201IR
ME200695.....	JA1376IR	81366062.....	CS617	9AL2590K.....	CA106	9AR2747P.....	CA1201IR
ME200696.....	JA1375IR	81368001.....	CS269	9AL2595K.....	CA84	9AR2748G.....	CA174IR
ME200698.....	JA1375IR	81368024.....	CS120	9AL2607.....	CA148	9AR2755P.....	CA207IR
ME201650.....	JS1221	81380038.....	CS97	9AL2615.....	CA140IR	9AR2757K.....	CA356IR
ME201745.....	JA1376IR	81382305.....	CS114	9AL2618G.....	CA48IR	9AR2759K.....	CA87IR
ME201837.....	JA1376IR	81387004.....	CS103	9AL2628P.....	CA166	9AR2759K01.....	CA87IR
ME201838.....	JA1375IR	81387034.....	CS186	9AL2679.....	CA148	9AR2760K.....	CA169IR
ME202755.....	JA1376IR	81388001.....	CS530	9AL2679K.....	CA148	9AR2764L.....	CA139IR
ME202970.....	JS1221	81388010.....	CS97	9AL2685K.....	CA147	9AR2765.....	CA87IR
ME202971.....	JA1375IR	81388020.....	CS394	9AL2696G.....	CA112	9AR2775.....	CA742IR
ME203546.....	JA1617IR	81388024.....	CS120	9AL2707L.....	CA139IR	9AR2775F.....	CA742IR
ME204424.....	JS1221	81388081.....	CS269	9AL2708G.....	CA140IR	9AR2778K.....	CA165IR
		81388309.....	CS120	9AL2834.....	CA70	9AR2779L.....	CA141IR



O.E. NO.	HC-PARTS	O.E. NO.	HC-PARTS	O.E. NO.	HC-PARTS	O.E. NO.	HC-PARTS
23100-01N06	JA887IR	23100-0U060	JA868IR	23100-46L11	JA165IR	23100-7F700	CA2079IR *
23100-01N13	JA886IR	23100-0Y710	JA1368IR	23100-47N70	JA1365IR	23100-7F701	CA2079IR *
23100-01N16	JA887IR	23100-10B10	JA104IR	23100-47R10	JA1292IR	23100-7T400	JA1516IR
23100-02E00	JA165IR	23100-10G03	JA662IR	23100-47R11	JA1292IR	23100-7T402	JA1516IR
23100-02E05	JA778IR	23100-11T10	JA185IR	23100-4B400	JA1287IR	23100-7T403	JA1516IR
23100-02E10	JA165IR	23100-11T13	JA185IR	23100-4M510	JA1607IR	23100-7T403	JA1516IR
23100-02E11	JA165IR	23100-12C11	JA781IR	23100-4M510	JA1607IR	23100-81T01	JA758IR
23100-02E15	JA778IR	23100-12C12	JA781IR	23100-4M610	JA1287IR	23100-81W00	JA754IR
23100-02E16	JA778IR	23100-12G01	JA1122IR	23100-4M611	JA1606IR	23100-85E00	JA767IR
23100-02N12	JA185IR	23100-12G02	JA1122IR	23100-50K10	JA1412IR	23100-86A00	JA1182IR
23100-02N13	JA780IR	23100-13E00	JA165IR	23100-50K15	JA1413IR	23100-86R00	JA1182IR
23100-02N14	JA678IR	23100-13E05	JA165IR	23100-50Y05	JA974IR	23100-88G00	JA1122IR
23100-02N15	JA678IR	23100-14E00	JA184IR	23100-50Y06	JA974IR	23100-8E100	JA1702IR
23100-02N16	JA185IR	23100-15P01	JA1422IR	23100-50Y08	JA974IR	23100-90060	JA100
23100-02N17	JA780IR	23100-15P11	JA1422IR	23100-50Y09	JA974IR	23100-91004	JA100
23100-02N18	JA678IR	23100-15P12	JA1422IR	23100-50Y18	JA974IR	23100-91009	JA100 ▲
23100-02N19	JA678IR	23100-15P13	JA1422IR	23100-50Y19	JA974IR	23100-91109	JA116IR
23100-02N20	JA185IR	23100-16A00	JA573IR	23100-51S00	JA781IR	23100-92G01	JA660IR
23100-02N21	JA780IR	23100-16A01	JA573IR	23100-51S10	JA781IR	23100-96E00	JA767IR
23100-02N22	JA678IR	23100-16N00	JA1186IR	23100-51S11	JA781IR	23100-96E01	JA767IR
23100-02N23	JA678IR	23100-17A00	JA573IR	23100-52F10	JA1275IR	23100-9C600	JA1162IR
23100-03B00	JA105IR	23100-17A01	JA573IR	23100-52F11	JA1275IR	23100-9F510	JA1287IR
23100-03B05	JA105IR ▲	23100-17B10	JA659IR	23100-53A00	JA163IR	23100-9F511	JA1606IR
23100-04F10	JA692IR	23100-17B11	JA659IR	23100-53A10	JA163IR	23100-9Y500	JA990IR
23100-04F11	JA692IR	23100-17C00	JA776IR	23100-53A11	JA163IR	23100-A4600	JA100
23100-04M00	JA158IR	23100-17S05	JA183IR	23100-54A01	JA182IR	23100-A4601	JA100
23100-04M10	JA158IR	23100-17S10	JA573IR ▲	23100-54A02	JA182IR	23100-A4602	JA100
23100-05B10	JA104IR ▲	23100-17S15	JA181IR	23100-54A03	JA182IR	23100-A4611	JA100
23100-05E06	JA765IR	23100-18000	JA102	23100-54B61	JA868IR	23100-A5500	JA100
23100-05E16	JA164IR	23100-18005	JA102	23100-54B62	JA868IR	23100-A5501	JA100
23100-05E17	JA164IR	23100-18006	JA102	23100-56A10	JA163IR	23100-A5502	JA100
23100-05E18	JA164IR	23100-18A00	JA181IR	23100-56A11	JA163IR	23100-AD210	JA1806IR
23100-05G05	JA754IR	23100-18A01	JA181IR	23100-56C00	JA182IR	23100-AD284	JA1806IR
23100-05P01	JA691IR	23100-18G02	JA186IR	23100-56C01	JA182IR	23100-AN000	JA1790IR
23100-05P03	JA691IR	23100-20B00	JA658IR	23100-56G00	JA1363IR	23100-AU000	JA1607IR
23100-05P11	JA691IR	23100-20J00	JA754IR ▲	23100-57J01	JA769IR	23100-AU400	JA1712IR
23100-05P12	JA691IR	23100-20W01	JA158IR	23100-57J02	JA769IR	23100-AU40A	JA1712IR
23100-05P13	JA691IR	23100-21G10	JA103	23100-57J03	JA769IR	23100-AU40D	JA1712IR
23100-06N00	JA773IR	23100-22J10	JA677IR	23100-57J04	JA769IR	23100-AU420	JA1712IR
23100-06S00	JA107IR	23100-24E15	JA778IR	23100-58L10	JA165IR	23100-AU424	JA1712IR
23100-06T10	JA105IR	23100-27G00	JA104IR	23100-58L11	JA165IR	23100-AU600	JA1725IR
23100-08E10	JA165IR	23100-27G10	JA104IR	23100-58S00	JA781IR	23100-AX600	JA1725IR
23100-08E11	JA165IR	23100-29912	JA102	23100-5F600	JA1176IR	23100-AX610	CA1963IR
23100-08E15	JA778IR	23100-2F000	JA1174IR	23100-5M310	JA1615IR	23100-AX62A	CA1963IR
23100-08E16	JA778IR	23100-2F001	JA1174IR	23100-5V410	JA1606IR	23100-AX62B	CA1977IR
23100-0C000	JA1374IR	23100-2F010	JA1174IR	23100-5Y700	JA990IR	23100-B0800	JA102
23100-0C001	JA1374IR	23100-2F200	JA1175IR	23100-64L00	JA765IR	23100-B9800	JA105IR
23100-0C800	JA975IR	23100-2F201	JA1175IR	23100-64J00	JA762IR	23100-B9801	JA105IR
23100-0C801	JA975IR	23100-2F210	JA1175IR	23100-64J02	JA762IR	23100-B9802	JA105IR
23100-0E400	JA769IR	23100-2J010	JA1287IR	23100-64J03	JA762IR	23100-B9805	JA105IR
23100-0E402	JA769IR	23100-2J011	JA1287IR	23100-64J04	JA762IR	23100-B9810	JA105IR
23100-0E700	JA974IR	23100-2J600	JA1528IR	23100-64J05	JA762IR	23100-BC00A	CA1957IR
23100-0E705	JA974IR	23100-2J601	JA1528IR	23100-64J10	JA762IR	23100-BC400	CA1957IR
23100-0E706	JA974IR	23100-2Y005	JA1357IR	23100-64J13	JA762IR	23100-BN300	JA1611IR
23100-0E711	JA974IR	23100-2Y006	JA1357IR	23100-64J16	JA762IR	23100-BN305	JA1611IR
23100-0E712	JA974IR	23100-2Y900	JA1357IR	23100-69T02	JA1527IR	23100-BU00A	JA1607IR
23100-0E715	JA974IR	23100-30B10	JA768IR	23100-69T03	JA1527IR	23100-BU010	JA1607IR
23100-0E716	JA974IR	23100-31P10	JA1361IR	23100-69T04	JA1527IR	23100-BU015	JA1607IR
23100-0E717	JA974IR	23100-31U00	JA1357IR	23100-69T05	JA1614IR	23100-BU500	JA1606IR
23100-0F000	JA1117IR	23100-31U00	JA1357IR	23100-69T10	JA1603IR	23100-C6000	JA100 ▲
23100-0F600	JA991IR	23100-31U01	JA990IR	23100-69T15	JA1527IR	23100-C8604	JA672IR
23100-0F601	JA991IR	23100-32J01	JA1420IR	23100-69T20	JA1603IR	23100-CN100	JA990IR
23100-0F610	JA1406IR	23100-32J03	JA1420IR	23100-69T60	JA1364IR	23100-D0201	JA107IR
23100-0L700	JA1357IR	23100-34E00	JA767IR	23100-69T61	CA1587IR ▲	23100-D0211	JA107IR
23100-0L701	JA990IR	23100-34E01	JA767IR	23100-6J111	JA1606IR	23100-D0800	JA887IR
23100-0M003	JA1182IR ▲	23100-35F10	JA782IR	23100-6J112	JA1606IR	23100-D0810	JA887IR
23100-0M005	JA1182IR	23100-37M00	JA158IR	23100-70N00	JA769IR	23100-D1700	JA107IR
23100-0M006	JA1182IR	23100-3831R	CA1933IR	23100-70N01	JA769IR	23100-D3300	JA107IR
23100-0M007	JA1182IR	23100-42L11	JA165IR	23100-71J00	JA756IR	23100-D4400	JA166IR
23100-0M008	JA1182IR	23100-42L12	JA165IR ▲	23100-71J10	JA756IR	23100-D4405	JA166IR
23100-0M009	JA1182IR	23100-42L71	JA781IR	23100-72J00	JA665IR	23100-D4410	JA166IR
23100-0M010	JA1182IR	23100-43G04	JA660IR	23100-72J10	JA665IR	23100-D4415	JA166IR
23100-0M010	JA1182IR	23100-43G05	JA780IR	23100-77A00	JA653IR	23100-D9704	JA757IR
23100-0M012	JA1182IR	23100-43G06	JA660IR	23100-77A10	JA653IR	23100-D9709	JA1162IR
23100-0M800	JA1287IR	23100-43G07	JA780IR	23100-77P00	JA1122IR	23100-D9710	JA1162IR
23100-0M810	JA1287IR	23100-43G08	JA660IR	23100-7C000	JA1525IR	23100-D9711	JA757IR
23100-0M811	JA1287IR	23100-43G09	JA780IR	23100-7C001	JA1525IR	23100-D9712	JA757IR
23100-0M901	JA769IR	23100-46512	JA101	23100-7F000	JA1364IR	23100-D9713	JA757IR
23100-0S300	JA1423IR	23100-46L10	JA165IR	23100-7F001	JA1364IR		

O.E. NO.	HC-PARTS	O.E. NO.	HC-PARTS	O.E. NO.	HC-PARTS	O.E. NO.	HC-PARTS
NISSAN <i>Continued</i>							
23100-DB000	CA2082IR *	23100-P0111	JA101	23100-V2810	JA158IR	23300-0C010	JS1094
23100-DB00A	CA2082IR *	23100-P0112	JA101	23100-V6000	JA765IR	23300-0M200	JS1100
23100-DC000	CA2081IR *	23100-P0113	JA101	23100-V7202	JA758IR	23300-0M210	JS1301
23100-EB310	CA2085IR *	23100-P1811	JA101	23100-V7203	JA758IR	23300-0M301	JS1100
23100-EB315	CA1946IR	23100-P3003	JA108IR	23100-V7204	JA758IR	23300-0M302	JS1100
23100-EB31A	CA2085IR *	23100-P3004	JA108IR	23100-V7205	JA758IR	23300-0M30A	JS1100
23100-EB31B	CA1946IR	23100-P3005	JA108IR	23100-VB310	JA1594IR	23300-0Y000	JS650
23100-F3810	JA1527IR ▲	23100-P3006	JA108IR	23100-VB311	JA1594IR	23300-0Y001	JS650
23100-G3706	JA779IR	23100-P3013	JA158IR	23100-VC100	JA1602IR	23300-0Y005	JS650
23100-G3710	JA573IR	23100-P3015	JA108IR	23100-VC10A	JA1602IR	23300-10G02	JS522
23100-G3711	JA573IR	23100-P3016	JA108IR	23100-VC10B	JA1602IR	23300-10T01	JS660
23100-G3716	JA181IR	23100-P3017	JA108IR	23100-VK010	CA1983IR	23300-10T02	JS517
23100-G4100	JA669IR	23100-P4500	JA103	23100-W1608	JA158IR	23300-11M00	JS389
23100-G5501	JA1291IR ▲	23100-P4501	JA103	23100-W1615	JA158IR	23300-11M01	JS389
23100-G5502	JA1291IR ▲	23100-P4503	JA101	23100-W1700	JA779IR	23300-11M02	JS389
23100-G5503	JA1291IR	23100-P4512	JA101	23100-W1701	JA162IR	23300-12G03	JS938
23100-G5504	JA1291IR	23100-Q0800	JA108IR	23100-W1702	JA162IR	23300-12G05	JS938
23100-G5700	JA773IR	23100-Q0810	JA108IR	23100-W1705	JA183IR	23300-15800	JS343
23100-G5701	JA773IR	23100-Q0811	JA108IR	23100-W1706	JA183IR	23300-15805	JS343
23100-G5702	JA773IR	23100-Q4501	JA104IR	23100-W1707	JA779IR	23300-15810	JS343
23100-G5704	JA773IR	23100-Q4511	JA104IR	23100-W1708	JA779IR ▲	23300-15815	JS343
23100-G9903	JA867IR	23100-Q4600	JA158IR	23100-W1710	JA162IR	23300-15A00	JS771
23100-G9904	JA1421IR	23100-Q4601	JA158IR	23100-W1805	JA198IR	23300-17C60	JS638
23100-H0300	JA101	23100-Q4610	JA158IR	23100-W1806	JA183IR	23300-18000	JS300
23100-H0310	JA100	23100-Q4611	JA158IR	23100-W1807	JA183IR	23300-18005	JS300
23100-H5810	JA101	23100-R2000	JA158IR	23100-W2501	JA669IR	23300-18015	JS300
23100-H5811	JA101	23100-R2002	JA158IR ▲	23100-W3405	JA779IR ▲	23300-18016	JS300
23100-H6200	JA101	23100-R9011	JA104IR	23100-W5800	JA104IR	23300-18C55	JS638
23100-H6201	JA101	23100-S6000	JA101	23100-W5801	JA104IR	23300-18C60	JS638
23100-H6202	JA101	23100-S6901	JA101	23100-W5802	JA104IR	23300-18C65	JS308
23100-H6203	JA101	23100-S6902	JA101	23100-W5803	JA104IR	23300-18V10	JS304
23100-H6204	JA101	23100-S6910	JA101	23100-W5806	JA158IR	23300-1F700	JS1305
23100-H6210	JA101	23100-U0100	JA100	23100-W5807	JA158IR	23300-1F705	JS1315
23100-H6211	JA101	23100-U0101	JA100	23100-W5810	JA104IR	23300-1F710	JS1307
23100-H6212	JA101	23100-U0102	JA100	23100-W5811	JA104IR	23300-1F715	JS1079
23100-H6213	JA101	23100-U0103	JA100	23100-W5816	JA158IR	23300-1F760	JS1305
23100-H6214	JA101	23100-U0104	JA100	23100-W5817	JA158IR	23300-1F770	JS1307
23100-H6215	JA101	23100-U0110	JA100	23100-W7015	JA104IR	23300-1F771	JS1307
23100-H7200	JA103	23100-U0111	JA100	23100-W7510	JA158IR	23300-1F772	JS1307
23100-H7201	JA103	23100-U0112	JA100	23100-Y0102	JA198IR	23300-1F77A	JS1307
23100-H7202	JA103	23100-U0113	JA100	23300-00H00	JS329	23300-1F77B	JS1307
23100-H7203	JA103	23100-U0114	JA105IR	23300-00H10	JS751	23300-1F77C	JS1307
23100-H7204	JA103	23100-U0514	JA101	23300-00Q0B	CS1207	23300-1KA1A	JS1367
23100-H7205	JA103	23100-U5511	JA165IR	23300-00Q0D	CS1415	23300-1M211	JS1301
23100-H7206	JA103	23100-U5800	JA101	23300-00Q0F	CS1332	23300-1M212	JS1301
23100-H7211	JA103	23100-U5801	JA101	23300-00Q1H	CS1332	23300-1M215	JS759
23100-H7212	JA103	23100-U5802	JA101	23300-00QA0	CS1332	23300-1M216	JS759
23100-H7700	JA104IR	23100-U5803	JA101	23300-00QAC	CS1193	23300-1S710	JS1219
23100-H7701	JA104IR	23100-U5810	JA101	23300-00QAF	CS1207	23300-1S711	JS1219
23100-H7702	JA104IR	23100-U5812	JA101	23300-00QAH	CS1255	23300-1S900	JS1159
23100-H7703	JA104IR	23100-U5813	JA101	23300-00QAL	CS1186	23300-1S900	JS1159
23100-H7710	JA104IR	23100-U6500	JA103	23300-00QAM	CS1057	23300-1W400	JS660
23100-H7711	JA104IR	23100-U6501	JA103	23300-00QAV	CS1207	23300-20H12	JS728
23100-JD71A	CA1979IR	23100-U6502	JA103	23300-00QAW	CS1273	23300-20P00	JS751
23100-JG71A	CA1979IR	23100-U6503	JA103	23300-00QAY	CS1385	23300-20R11	JS920
23100-L1802	JA784	23100-U6504	JA103	23300-00QAZ	CS1273	23300-21000	JS302
23100-M0400	JA100	23100-U6506	JA103	23300-01B00	JS556	23300-21005	JS302
23100-M0401	JA100	23100-U6510	JA103	23300-01E00	JS309	23300-21006	JS302
23100-M0402	JA100	23100-U6511	JA103	23300-01E10	JS309	23300-21007	JS302
23100-M0403	JA100	23100-U6513	JA103	23300-01E11	JS309	23300-21008	JS302
23100-M0410	JA100	23100-U7500	JA101	23300-01E12	JS309	23300-21009	JS302
23100-M0412	JA100	23100-U7510	JA101	23300-01E13	JS309	23300-21010	JS302
23100-M0413	JA100	23100-U7511	JA101	23300-01N00	JS893	23300-21015	JS302
23100-M0414	JA100	23100-U9502	JA125IR	23300-01Y10	JS773	23300-21016	JS302
23100-M5960	JA104IR	23100-U9503	JA104IR	23300-01Y11	JS773	23300-21017	JS302
23100-M6600	JA104IR	23100-U9510	JA104IR	23300-03E00	JS378	23300-21800	JS379
23100-M6601	JA104IR	23100-U9512	JA104IR	23300-03E10	JS378	23300-22P00	JS668
23100-M6610	JA104IR	23100-U9513	JA104IR	23300-03E11	JS378	23300-2F000	JS1142
23100-N3302	JA101	23100-U9601	JA158IR	23300-03J00	JS1093	23300-2F200	JS1156
23100-N9500	JA104IR	23100-U9602	JA158IR	23300-04E00	JS513	23300-2J201	JS1137
23100-N9502	JA104IR	23100-U9610	JA158IR	23300-04E01	JS513	23300-2J260	JS1137
23100-N9510	JA104IR	23100-U9612	JA158IR	23300-04E02	JS513	23300-2J261	JS1137
23100-N9511	JA104IR	23100-V0101	JA198IR	23300-04E10	JS513	23300-2Y900	JS924
23100-N9512	JA104IR	23100-V0102	JA198IR	23300-05E00	JS345	23300-30F10	JS667
23100-P0100	JA101	23100-V0106	JA198IR	23300-05E10	JS345	23300-30F11	JS667
23100-P0101	JA101	23100-V0107	JA198IR	23300-06E00	JS309	23300-30P14	JS937
23100-P0102	JA101	23100-V0802	JA807IR	23300-06E10	JS309	23300-30R01	JS937
23100-P0103	JA101	23100-V1905	JA779IR ▲	23300-09E00	JS397	23300-30R02	JS937
23100-P0110	JA101	23100-V2800	JA158IR	23300-09E10	JS397	23300-30R12	JS937



O.E. NO.	HC-PARTS	O.E. NO.	HC-PARTS	O.E. NO.	HC-PARTS	O.E. NO.	HC-PARTS
23300-30R13	JS937	23300-62C10	JS520	23300-9C600	JS568	23300-H5004	JS300
23300-31U00	JS924	23300-63J00	JS914	23300-9F600	JS1226	23300-H5010	JS300
23300-31U01	JS924	23300-63J02	JS914	23300-9F660	JS1226	23300-H5011	JS300
23300-31U02	JS924	23300-63J10	JS627	23300-9F661	JS1226	23300-H5012	JS300
23300-31W02	JS379	23300-63J11	JS627	23300-9F662	JS1226	23300-H5013	JS300
23300-31W04	JS359	23300-65F05	JS890	23300-9F66A	JS1226	23300-H5014	JS300
23300-3400A9	CS1415	23300-65F10	JS890	23300-9F66B	JS1226	23300-H5015	JS300
23300-36A00	JS520	23300-65Y00	JS766	23300-A3200	JS343	23300-H6900	JS300
23300-36A10	JS520	23300-65Y01	JS766	23300-AU600	JS1295	23300-H6901	JS300
23300-36A11	JS520	23300-65Y10	JS672	23300-AU601	JS1295	23300-H6902	JS300
23300-37503	JS379	23300-6K200	JS660	23300-AX000	JS1307	23300-H6903	JS300
23300-37508	JS379	23300-6T000	JS660	23300-AX002	JS1307	23300-H6904	JS300
23300-37A00	JS775	23300-6T001	JS660	23300-AX00A	JS1307	23300-H7301	JS300
23300-37A01	JS775	23300-6T00A	JS1159	23300-AX010	JS1016	23300-H7302	JS300
23300-37A10	JS775	23300-70J00	JS672	23300-AX01A	JS1016	23300-JG70A	CS1415
23300-37J00	JS1093	23300-70J01	JS891	23300-B03G0	JS305	23300-K9160	JS779
23300-37J05	JS1093	23300-70J02	JS672	23300-BC200	JS1367	23300-KA470	JS558
23300-3M000	JS1001	23300-70J03	JS672	23300-BC20A	JS1367	23300-KA471	JS558
23300-3M010	JS1001	23300-70J10	JS627	23300-BC20B	JS1367	23300-L1110	JS329
23300-3T700	JS660	23300-70J11	JS627	23300-BC400	CS1332	23300-L1110	JS329
23300-40500	JS303	23300-70J12	JS627	23300-BC40B	CS1332	23300-L1110	JS329
23300-40501	JS303	23300-70Y00	JS759	23300-BN301	JS1235	23300-L1110	JS329
23300-40510	JS303	23300-70Y01	JS759	23300-BN302	JS1235	23300-L1111	JS329
23300-40511	JS303	23300-70Y01	JS759	23300-BN700	CS1273	23300-L1111	JS329
23300-40512	JS303	23300-70Y10	JS759	23300-BN701	CS1273	23300-L1111	JS329
23300-40513	JS303	23300-72F10	JS937	23300-BN70A	CS1273	23300-L1800	JS379
23300-40700	JS303	23300-73C00	JS759	23300-C0600	JS905	23300-L2911	JS329
23300-40710	JS303	23300-73C10	JS759	23300-C6800	JS399	23300-L2911	JS329
23300-41B15	JS305	23300-73Y00	JS672	23300-C6801	JS399	23300-L2911	JS329
23300-41B71	JS1016	23300-73Y01	JS672	23300-C8601	JS540	23300-L2912	JS329
23300-44R10	JS920	23300-74Y00	JS759	23300-C8703	JS399	23300-L2912	JS329
23300-44R11	JS920	23300-74Y10	JS759	23300-C8704	JS399	23300-L2912	JS329
23300-45N50	JS660	23300-77A01	JS763	23300-CK800	CS1418	23300-L6000	JS904
23300-45N51	JS660	23300-77A11	JS763	23300-DO100	JS304	23300-L6810	JS927
23300-47500	JS306	23300-78503	JS302	23300-DO110	JS304	23300-M0100	JS301
23300-47501	JS306	23300-78504	JS302	23300-DO111	JS304	23300-M0101	JS301
23300-47502	JS306	23300-78505	JS302	23300-DO200	JS304	23300-M0110	JS301
23300-47510	JS306	23300-79E10	JS914	23300-DO210	JS304	23300-M0111	JS301
23300-47511	JS306	23300-7C625	JS568	23300-DO211	JS304	23300-M0112	JS301
23300-47601	JS340	23300-7F400	JS660	23300-DO212	JS304	23300-M0113	JS301
23300-48301	JS340	23300-80100	JS302	23300-DO213	JS304	23300-M1500	JS301
23300-4E210	JS627	23300-80200	JS305	23300-DO214	JS304	23300-M1501	JS301
23300-4J606	JS1225	23300-80F00	JS890	23300-DO300	JS649	23300-M1502	JS301
23300-50Y00	JS766	23300-80G00	JS660	23300-DO301	JS649	23300-M1503	JS301
23300-50Y01	JS766	23300-80G01	JS660	23300-DO310	JS513	23300-M1510	JS301
23300-50Y02	JS672	23300-80W00	JS303	23300-DO511	JS911	23300-M1511	JS301
23300-50Y10	JS766	23300-81N00	JS766	23300-DO512	JS911	23300-M4900	JS301
23300-50Y11	JS766	23300-81N01	JS766	23300-DO513	JS911	23300-M8000	JS305
23300-50Y12	JS672	23300-81N01	JS766	23300-DO514	JS911	23300-M8001	JS305
23300-50Y14	JS672	23300-81N10	JS766	23300-D1700	JS304	23300-M8010	JS305
23300-51E10	JS920	23300-81N11	JS766	23300-D9700	JS568	23300-M8011	JS305
23300-51E11	JS920	23300-81W00	JS307	23300-D9701	JS568	23300-M8100	JS556
23300-52F00	JS890	23300-83W00	JS522	23300-D9702	JS568	23300-M8101	JS556
23300-52F01	JS890	23300-84A01	JS520	23300-DB000	CS1491	23300-M8111	JS772
23300-52F05	JS890	23300-84A07	JS766	23300-DB00A	CS1491	23300-M8200	JS305
23300-52F10	JS890	23300-84A11	JS520	23300-E3000	JS303	23300-M8201	JS305
23300-52H00	JS1093	23300-84A17	JS766	23300-E3001	JS303	23300-M8202	JS305
23300-53F11	JS937	23300-85E00	JS754	23300-E3010	JS303	23300-M8210	JS305
23300-53J11	JS627	23300-85E01	JS754	23300-E3011	JS303	23300-M8211	JS305
23300-53J11	JS627	23300-86G10	JS939	23300-E3100	JS303	23300-M8212	JS305
23300-53J12	JS627	23300-86G11	JS939	23300-E3101	JS303	23300-M8300	JS556
23300-53J12	JS627	23300-86G12	JS939	23300-EB300	CS1424	23300-M8301	JS556
23300-53Y00	JS672	23300-87709	JS376	23300-EB30A	CS1424	23300-M8500	JS364
23300-53Y01	JS672	23300-88G00	JS1104	23300-EB30B	CS1424	23300-M8501	JS364
23300-54A00	JS539	23300-88G01	JS1104	23300-EE00A	JS1367	23300-M8502	JS364
23300-54A01	JS539	23300-8H300	JS1306	23300-EN200	CS1418	23300-N3300	JS307
23300-54A05	JS539	23300-8H500	JS1318	23300-EN20A	CS1418	23300-N3301	JS307
23300-54A06	JS539	23300-8H801	JS1295	23300-G2403	JS1214	23300-N3302	JS307
23300-54C00	JS914	23300-8H80A	JS1295	23300-G2404	JS1214	23300-N3303	JS307
23300-54T00	JS1159	23300-90067	JS1159	23300-G2405	JS1214	23300-N5900	JS306
23300-57J00	JS1001	23300-90069	JS1159	23300-G2406	JS1214	23300-N5901	JS306
23300-57J05	JS1001	23300-92350	JS1142	23300-G9900	JS936	23300-N5902	JS306
23300-57J11	JS1001	23300-94850	JS305	23300-H0100	JS300	23300-N5903	JS306
23300-57J13	JS1001	23300-99B00	JS305	23300-H0101	JS300	23300-N5910	JS306
23300-57M05	JS378	23300-99B05	JS1081	23300-H03900	JS300	23300-N5911	JS306
23300-57M60	JS654	23300-99B06	JS1081	23300-H5000	JS300	23300-OM301	JS1100
23300-57M70	JS654	23300-99B10	JS1016	23300-H5001	JS300	23300-OM302	JS1100
23300-60S10	JS751	23300-99B15	JS1079	23300-H5002	JS300	23300-P0613	JS329
23300-62C00	JS520	23300-99B16	JS1079	23300-H5003	JS300	23300-P0614	JS329

O.E. NO.	HC-PARTS	O.E. NO.	HC-PARTS	O.E. NO.	HC-PARTS	O.E. NO.	HC-PARTS
<b>NISSAN <i>Continued</i></b>							
23300-P0614	JS329	23300-W2801	JS358	1202101	CS70	1204036	CA384IR
23300-P0614	JS329	23300-W2802	JS358	1202102	CS66	1204037	CA384IR
23300-P1114	JS329	23300-W2803	JS662	1202103	CS66	1204039	CA509IR
23300-P1114	JS329	23300-W2804	JS662	1202104	CS80	1204040	CA509IR
23300-P1114	JS329	23300-W3410	JS662	1202105	CS80	1204041	CA353IR
23300-P5110	JS343	23300-W9810	JS779	1202108	CS87	1204042	CA353IR
23300-P5111	JS343	23300-WD000	JS1235	1202109	CS162	1204043	CA352IR
23300-P5112	JS329	23300-WD001	JS1235	1202110	CS1257	1204044	CA352IR
23300-P5112	JS329	23300-Y0102	JS307	1202113	CS263	1204045	CA198IR
23300-P5112	JS329	23300-Y0500	JS303	1202118	CS290	1204046	CA198IR
23300-P5113	JS329	23300-Y0501	JS303	1202125	CS372	1204051	CA221IR
23300-P5113	JS329	23300-Y0510	JS303	1202126	CS162	1204052	CA284IR
23300-P5113	JS329	23300-Y0511	JS303	1202127	CS1183	1204053	CA515IR
23300-P5114	JS751	23300-Y0512	JS303	1202129	CS162	1204056	CA384IR
23300-Q9000	JS378	23300-Y0513	JS303	1202130	CS372	1204058	CA604IR
23300-R2000	JS306	23300-Y0700	JS303	1202131	CS535	1204062	JA673IR
23300-R2010	JS306	23300-Y0701	JS303	1202134	CS66	1204063	CA1404IR
23300-R9000	JS329	23300-Y0702	JS307	1202135	CS1166	1204069	CA128IR
23300-R9000	JS329	23300-Y0710	JS303	1202136	JS651	1204070	CA517IR
23300-R9000	JS329	23300-Y0711	JS303	1202137	CS519	1204072	CA353IR
23300-S0500	JS302	23300-Y0712	JS303	1202138	CS727	1204076	CA548IR
23300-S0510	JS302	23300-Y0713	JS303	1202139	CS802	1204081	CA570IR
23300-U0100	JS302	23300-Y0714	JS303	1202141	CS984	1204084	JA874IR
23300-U0101	JS302	23300-Y0715	JS303	1202142	CS519	1204086	CA514IR
23300-U0102	JS302	23300-Y9700	JS568	1202143	CS322	1204087	CA517IR
23300-U0110	JS302	23300-Z5504	JS1087	1202144	CS727	1204088	CA513IR
23300-U0111	JS302	23300-Z5505	JS1087	1202145	CS879	1204090	CA615IR
23300-U0112	JS302	23300-Z5508	JS1087	1202146	JS651	1204091	CA516IR
23300-U0113	JS302	23300-Z5509	JS1087	1202147	JS639	1204092	CA519IR
23300-U6000	JS307	23300-Z5514	JS1087	1202148	CS976	1204096	CA701IR
23300-U6001	JS307	23300-Z5515	JS1087	1202152	JS999	1204097	CA701IR
23300-U6002	JS307	23300-Z5520	JS1087	1202154	JS999	1204100	CA514IR
23300-U6003	JS307	23300-AA300	JS670	1202156	CS322	1204105	CA517IR
23300-U6004	JS307	23300-AA40A	JS671	1202157	JS1091	1204107	CA509IR
23300-U6006	JS307	23300-AA41A	JS757	1202159	CS879	1204108	CA861IR
23300-U6007	JS307	31A66-00101	JS1014	1202161	JS941	1204109	CA513IR
23300-U7500	JS306	31A66-00102	JS1014	1202162	CS802	1204111	CA110IR
23300-U7501	JS306	34466-20102	JS777	1202163	JS639	1204112	CA48IR
23300-U7502	JS306	34466-20201	JS1007	1202168	CS984	1204113	CA198IR
23300-U7510	JS306	34468-16100	JA796IR	1202169	CS982	1204116	CA846IR
23300-U7511	JS306	34468-26100	JA796IR	1202172	CS519	1204117	CA515IR
23300-V0600	JS379	34468-28200	JA116IR	1202173	CS519	1204118	CA515IR
23300-V0603	JS379	52810-31000	JA1607IR	1202174	CS519	1204120	CA48IR
23300-V0605	JS379			1202179	CS1188	1204121	CA517IR
23300-V0606	JS359			1202184	JS999	1204122	CA570IR
23300-V0607	JS359	OPEL		1202591	JS1158	1204123	CA1391IR
23300-V0711	JS363	1202000	CS372	1202950	CS66	1204124	CA198IR
23300-V4361	CS282	1202001	CS162	1202951	CS70	1204125	CA42IR
23300-V4362	CS282	1202002	CS162	1202952	CS80	1204126	CA1066IR
23300-V5302	JS668	1202004	CS87	1202953	CS162	1204128	CA647IR
23300-V7200	JS650	1202005	CS372	1202954	CS263	1204129	CA1146IR
23300-V7260	JS650	1202006	CS80	1202955	CS148	1204130	CA513IR
23300-V8200	JS305	1202007	CS66	1202956	CS290	1204131	CA516IR
23300-VB300	JS650	1202008	CS70	1202956	CS322	1204132	JA673IR
23300-VB300	JS650	1202009	JS651	1202957	CS70	1204133	JA871IR
23300-VB3C0	JS650	1202010	CS372	1202958	CS372	1204134	CA1490IR
23300-VK500	CS1439	1202011	CS535	1202959	CS535	1204136	CA1257IR
23300-VK50A	CS1439	1202015	JS753	1204002	CA158IR	1204137	CA1440IR
23300-VM00A	CS1439	1202016	CS322	1204003	CA158IR	1204138	JA871IR
23300-W0400	JS303	1202017	JS639	1204004	CA264IR	1204143	CA846IR
23300-W0402	JS303	1202019	CS162	1204005	CA264IR	1204144	JA863IR
23300-W0403	JS303	1202020	CS162	1204006	CA128IR	1204146	CA1045IR
23300-W0410	JS303	1202021	CS70	1204007	CA99IR	1204149	CA99IR
23300-W0411	JS303	1202024	CS982	1204008	CA507IR	1204150	CA128IR
23300-W0412	JS303	1202026	JS941	1204009	CA508IR	1204151	CA128IR
23300-W0413	JS303	1202027	CS263	1204010	CA507IR	1204154	CA128IR
23300-W1000	JS308	1202028	CS263	1204011	CA508IR	1204155	CA1561IR
23300-W1001	JS308	1202030	CS80	1204012	CA158IR	1204157	JA1526IR
23300-W1002	JS308	1202033	JS941	1204013	CA264IR	1204158	JA1521IR
23300-W1010	JS935	1202034	CS70	1204014	CA128IR	1204160	CA1828IR
23300-W1011	JS935	1202035	CS70	1204015	CA99IR	1204161	CA110IR
23300-W1701	JS358	1202036	CS290	1204016	CA221IR	1204163	CA42IR
23300-W1702	JS358	1202037	CS66	1204017	CA110IR	1204165	CA48IR
23300-W1711	JS358	1202040	CS80	1204018	CA48IR	1204166	CA42IR
23300-W1712	JS358	1202045	CS322	1204019	CA42IR	1204167	CA110IR
23300-W1800	JS363	1202047	CS66	1204020	CA507IR	1204168	CA48IR
23300-W1810	JS363	1202048	CS356	1204021	CA508IR	1204169	CA110IR
23300-W1811	JS363	1202049	CS70	1204030	CA284IR	1204170	CA48IR
23300-W2500	JS358	1202088	CS1291	1204035	CA384IR	1204173	CA42IR
		1202100	CS70				

O.E. NO.	HC-PARTS	O.E. NO.	HC-PARTS	O.E. NO.	HC-PARTS	O.E. NO.	HC-PARTS
1204174	CA128IR	4416774	CS1415	6204037	CA1327IR	6204218	CA1973IR
1204175	CA99IR	4417538	CS1415	6204042	JA1172IR	6204246	CA1909IR
1204176	CA221IR	4417846	CA1645IR	6204043	JA1370IR	6204251	JA1901IR
1204190	CA221IR	4419036	CA2082IR *	6204045	JA1290IR	6204252	JA1900IR
1204191	CA128IR	4419088	CA2082IR *	6204046	JA1172IR	6204256	CA2046IR *
1204192	CA128IR	4430569	CA1661IR	6204047	JA1370IR	6204257	CA1955IR
1204197	CA507IR	4430591	CA1627IR	6204057	JA680IR	6204258	CA1956IR
1204198	CA508IR	4431557	CA1829IR	6204060	CA1150IR	6204259	CA1987IR
1204203	CA514IR	4434149	CA1877IR	6204062	CA1070IR	6204264	CA1916IR
1204216	CA615IR	4500044	CA1343IR	6204063	CA1045IR	6204265	CA1940IR
1204217	CA892IR	4500045	CA1434IR	6204065	CA1389IR	6204271	CA1960IR
1204219	CA647IR	4500256	CS1160	6204066	CA1507IR	6204274	CA2010IR
1204220	CA647IR	4502489	CS1263	6204069	CA1329IR	6204275	CA2017IR
1204221	CA846IR	4506175	CS1207	6204071	CA1257IR	6204278	CA2045IR
1204222	CA264IR	4506176	CA1661IR	6204073	CA1581IR	6204281	CA1934IR
1204310	CA48IR	4709920	CA2026IR *	6204074	CA1473IR	6204282	CA1987IR
1204311	CA110IR	4805517	CS1431	6204075	CA1257IR	6204283	CA1956IR
1204312	CA42IR	4805518	CS879	6204076	CA1391IR	6204284	JA1521IR
1204313	CA128IR	6202000	JS1158	6204077	CA1490IR	6204664	CA1855IR
1204314	CA128IR	6202001	JS999	6204079	CA1501IR	9110411	CS784
1204315	CA158IR	6202004	CS1291	6204080	CA1765IR	9110602	CS1263
1204316	CA264IR	6202006	CS1247	6204084	CA1582IR	9111540	CA1627IR
1204317	CA507IR	6202007	CS1188	6204085	CA1495IR	9111221	CS1207
1204318	CA508IR	6202008	CS879	6204088	CA1066IR	9112331	CA1645IR
1204319	CA507IR	6202009	CS976	6204095	CA1821IR	9112333	CS1207
1204320	CA508IR	6202013	CS1257	6204097	CA1561IR	9115191	CS519
1204321	CA264IR	6202014	CS976	6204098	CA1581IR	9115192	CS519
1204326	CA509IR	6202015	CS1395	6204099	CA1592IR	9115197	CS1257
1204327	CA352IR	6202016	CS1257	6204102	CA1747IR	9117031	CS519
1204328	CA353IR	6202017	CS984	6204103	CA1658IR	9117691	CS1188
1204329	CA198IR	6202020	CS1257	6204104	CA1748IR	9117930	CA1257IR
1204330	CA384IR	6202021	CS1247	6204105	CA1577IR	9117932	CA1490IR
1204331	CA514IR	6202022	CS1291	6204106	JA1172IR	9117933	CA1440IR
1204332	CA570IR	6202037	CS1395	6204107	CA1730IR	9117934	CA1501IR
1204333	CA352IR	6202043	JS1158	6204109	CA1053IR	9117936	CA1765IR
1204334	CA701IR	6202044	CS1291	6204112	CA1740IR	9118738	CA1582IR
1204335	CA264IR	6202048	CS1071	6204113	CA1592IR	9119793	JS941
1204336	CA128IR	6202051	CS1250	6204116	CA1582IR	9121119	CA1827IR
1204337	CA128IR	6202052	CS1247	6204118	CA1858IR	9129823	CA1391IR
1204338	CA198IR	6202055	CS1395	6204119	CA1740IR ▲	9130838	CS519
1204339	CA509IR	6202060	CS976	6204123	CA1833IR	09131133	CA1582IR
1204340	CA352IR	6202061	CS1257	6204136	CA1561IR	9131133	CA1582IR
1204341	CA353IR	6202064	CS1257	6204137	CA1748IR	9131264	CA1740IR
1204343	CA99IR	6202065	CS1250	6204140	JA1521IR	9132653	CA1473IR
1204344	CA519IR	6202066	CS879	6204141	CA1103IR	9133599	CA1257IR
1204349	CA516IR	6202071	CS1334	6204143	CA1582IR	9133600	CA1391IR
1204424	CA2010IR	6202072	CS1257	6204145	CA1658IR	9152247	CA1592IR
1204426	CA1955IR	6202073	CS1428	6204148	CA1730IR	9160344	CA1343IR
1204429	CA1934IR	6202074	CS1264	6204155	CA1391IR	9160345	CA1434IR
1204433	CA1884IR	6202075	CS519	6204160	CA1070IR	9160556	CS1160
1204434	CA1890IR	6202077	CS1257	6204173	CA1740IR	9165557	CS982
1204436	CA1885IR	6202079	CS1257	6204177	CA1658IR	9192364	CS982
1204618	JA1900IR	6202083	CS1334	6204178	CA1765IR	9192815	CA1257IR
1204643	CA2005IR	6202084	CS1438	6204179	CA1747IR	9192823	CA1391IR
1776346	CA352IR	6202087	JS1158	6204180	CA1855IR	9192826	CA1440IR
3493814	CA1103IR	6202088	CS1257	6204181	CA1862IR	9193117	CA1731IR
3493815	CA1103IR	6202089	CS1488	6204183	JA1901IR	9195336	CA1821IR
3493823	CA1053IR	6202090	CS1291	6204184	CA1592IR	9195752	CA1561IR
3493824	CA1053IR	6202103	JS1158	6204185	CA1730IR	9195753	CA1581IR
3493824	CA1053IR	6202125	CS1395	6204187	CA1884IR	9195822	CS982
3493848	CA861IR	6204000	CA1053IR	6204188	CA1885IR	9198664	CS1160
3493848	CA861IR	6204000	CA1053IR	6204189	CA1890IR	9199321	CS1257
4302135	JA1120IR	6204002	CA1053IR	6204191	CA1765IR	9199574	CA1740IR
4402600	CA1622IR	6204003	CA861IR	6204192	CA1391IR	9199575	CA1592IR
4402602	CS1263	6204004	CA1070IR	6204193	CA1747IR	9200610	CS1250
4403540	CA1627IR	6204005	CA1070IR	6204194	CA1658IR	9200890	CS1247
4404174	CA1622IR	6204006	CA1103IR	6204195	CA1909IR	9200955	CA1731IR
4404221	CS1207	6204007	CA1051IR	6204197	JA1900IR	9200956	CA1747IR
4404331	CA1645IR	6204008	CA861IR	6204198	JA1900IR ▲	9200957	CA1658IR
4405286	CA1827IR	6204009	CA1103IR	6204199	JA1899IR	9200958	CA1748IR
4411316	CA1627IR	6204010	CA1051IR	6204200	JA1899IR ▲	9200959	CA1577IR
4411318	CA1661IR	6204012	CA1507IR	6204201	CA1935IR	9200960	CS1188
4414332	CS1193	6204013	JA863IR	6204203	CA1748IR	9200961	CS879
4414402	CS1193	6204014	CA1150IR	6204204	CA1581IR	9200962	CS976
4415000	CA2081IR *	6204016	CA1231IR	6204205	CA1882IR	9201039	CA1730IR
4415001	CS1491	6204023	CA1326IR	6204207	CA1592IR	9201489	CA1053IR
4415443	CS1207	6204024	CA1327IR	6204208	CA1748IR	9201491	CA1045IR
4416485	CA1824IR	6204025	CA1328IR	6204209	CA1581IR	9201825	CS1207
4416689	CA1877IR	6204034	CA1507IR	6204213	CA1934IR	9201826	CA1661IR

O.E. NO.	HC-PARTS	O.E. NO.	HC-PARTS	O.E. NO.	HC-PARTS	O.E. NO.	HC-PARTS
<b>OPEL Continued</b>							
9512185	CA1916IR	55353257	CS1334	90444194	CA1070IR	93171950	CS1257
10295857	CA1389IR	55353669	CS1488	90444195	CA1070IR	93172020	CS1247
10297421	CA1495IR	55353857	CS1264	90458462	CS2727	93172075	CA1858IR
10480384	CA1053IR	55358857	CS1264	90460576	CA1507IR	93172080	CA1740IR ▲
10480423	CA1561IR	55556065	CA1592IR	90465731	CS984	93174028	JS1158
12564088	CS1291	55556067	CA1882IR	90487546	CS982	93174341	CS1263
12567585	CS1395	55556068	CA1748IR	90488053	CA352IR	93174469	CA1833IR
12568931	CS1291	55556069	CA1748IR	90506202	CA1327IR	93174497	CA1828IR
12570230	US1240	55556070	CA1581IR	90508037	CS879	93175799	JA1521IR
12570623	US1240	55556071	CA1581IR	90508842	CA1507IR	93175803	CA1103IR
12572716	US858	55556092	CS1438	90509838	CA1507IR	93175805	CA1582IR
12575626	CS1395	55556130	CS1257	90511442	CA1150IR	93175996	CS1257
13108596	CA1828IR	55556245	CS1395	90511445	CA1066IR	93176034	CS976
13108597	CA2067IR *	55559583	CA1916IR	90511446	CA1146IR	93176035	CA1740IR
13117278	CA1855IR	55563538	CS1488	90511724	CA1231IR	93176051	CS1257
13117279	CA1862IR	90006897	CA284IR	90511841	CS322	93176061	CS879
13117340	CA1884IR	90093899	CS148	90512188	CS2727	93176653	CA2067IR *
13117341	CA1885IR	90094133	CS162	90512189	CS879	93177833	CA1658IR
13129850	CA1740IR	90140179	CS263	90512216	CA1326IR	93177834	CA1765IR
13143128	CA1658IR	90244663	CA604IR	90512217	CA1327IR	93177835	CA1747IR
13147093	CA1765IR	90247986	CA604IR	90512219	CA1328IR	93178138	CS1334
13153236	CA1890IR	90277934	CS372	90512467	CS976	93178167	CS1257
13153237	CA1935IR	90277935	CA221IR	90519331	CS976	93178173	JA1526IR
13156050	CA1765IR	90289247	CA1146IR	90534472	CA1329IR	93179579	CA2081IR *
13156051	CA1391IR	90295212	CA384IR	90540209	CA1507IR	93179580	CS1491
13156052	CA1747IR	90297846	CS372	90540586	CS322	93180098	CA1884IR
13156053	CA1658IR	90297896	CA384IR	90541527	CS802	93180102	CA1885IR
13156054	CA1909IR	90337036	CA604IR	90542409	CA1150IR	93180104	CA1890IR
13197577	CA1855IR	90337041	CA198IR	90542412	CS984	93180414	CA1765IR
13197578	CA1934IR	90337043	CA128IR	90542532	CS982	93180415	CA1391IR
13222929	CA2046IR *	90337044	CA353IR	90542967	CS982	93180416	CA1747IR
13222930	CA1940IR	90337045	CA264IR	90542980	CA1070IR	93180417	CA1658IR
13222933	CA1973IR	90337046	CA352IR	90542981	CA1045IR	93180419	CA1909IR
13222934	CA1955IR	90337047	CA508IR	90543012	CA1507IR	93183381	CA1935IR
13222935	CA1956IR	90337048	CA509IR	90543228	CA1329IR	93183435	CA1748IR
13222936	CA1987IR	90337051	CA284IR	90543234	CA1257IR	93183436	CA1581IR
13229985	CA1960IR	90337074	CA353IR	90543871	CS519	93183437	CA1882IR
13229987	CA1592IR	90338170	CA846IR	90561167	CA1490IR	93184052	CA1592IR
13229988	CA1740IR	90338188	CA846IR	90561168	CA1501IR	93184055	CA1748IR
13229990	CA2005IR	90348290	CS372	90561169	CA1577IR	93184064	CA1581IR
13229991	CA2045IR	90348291	CS162	90561967	CA1257IR	93184533	CS1257
13229992	CA1994IR	90348292	CS1183	90561970	CA1391IR	93184535	CS1257
13256929	CA1934IR	90348695	CA515IR	90561971	CA1581IR	93185261	CA1934IR
13256930	CA1855IR	90348696	CA517IR	90561972	CA1765IR	93186246	CS1334
13256931	CA1987IR	90348697	CA513IR	90566073	CS982	93186763	CA1916IR
13256932	CA1956IR	90348698	CA514IR	90586916	CS1188	93188158	CA1973IR
13256933	CA1955IR	90349207	CA264IR	90589566	CA1440IR	93188332	CA1824IR
13283343	CA1855IR	90349208	CA352IR	90589721	CA1257IR	93189013	CA1877IR
13283344	CA1862IR	90349210	CA508IR	90589722	CA1561IR	93189251	CA1916IR
13308507	CA2045IR	90349211	CA221IR	91154217	CS1071	93189272	CA1916IR
13308508	CA1994IR	90349328	CA516IR	91167270	CS1193	93189495	JA1901IR
13502583	CA2005IR	90349353	CS1166	91167474	CS1193	93189496	JA1900IR
24256224	CA1730IR	90349835	CA353IR	91167635	CS1207	93190138	CA1940IR
24414255	CA1731IR	90349850	CA604IR	92059984	CA1053IR	93190827	CA1592IR
24421812	CS982	90349852	CA509IR	93160649	CA1829IR	93190828	CA1740IR
24430294	CA1740IR	90349853	CA353IR	93160665	CA1627IR	93190829	CA1960IR
24430295	CA1592IR	90349886	CA198IR	93160666	CA1661IR	93190915	CA1935IR
24436224	CA1582IR	90356665	CA861IR	93161060	CS1255	93190956	CS1207
24436553	CA1730IR	90356897	CA1045IR	93161425	CA1627IR	93190996	CS1207
24436877	CS1257	90365665	CA1045IR	93161427	CA1661IR	93191541	CA1645IR
24437119	CA1747IR	90371766	CS879	93161735	CA1959IR	93191921	CA2045IR
24437120	CA1748IR	90378503	CA846IR	93161788	CA1829IR	93191922	CA1994IR
24437121	CA1658IR	90379322	CA846IR	93169014	JS1158	93194153	CA2026IR *
24439410	CA1053IR	90389246	CA1066IR	93169024	CA1862IR	93196984	CA2082IR *
24439411	CA1045IR	90389247	CA1146IR	93169026	CA1855IR	93198179	CA1627IR
24447429	CA1833IR	90389248	CA1231IR	93169028	CA1884IR	93198275	CA1877IR
24451624	CA1584IR	90398044	CS80	93169029	CA1884IR	93199248	CA1909IR
24454144	CS1291	90399165	CA515IR	93169030	CA1890IR	93260364	CA1066IR
24454172	CS984	90413763	CA1070IR	93169031	CA1890IR	93603136	CA1146IR
24455914	CA1740IR ▲	90421876	CS519	93169032	CA1885IR	93604828	CS519
24460703	CS1247	90442072	CA647IR	93169033	CA1885IR	93857703	CS1415
24463063	CA1391IR	90443097	CA846IR	93169257	CA1884IR	93858918	CS1193
24463064	CA1490IR	90443488	CS322	93169258	CA1885IR	93859136	CS1415
55350543	CS1291	90443760	CA861IR	93169259	CA1890IR	93859444	CS1207
55351608	CS1257	90443927	CA846IR	93169260	CA1952IR	93863426	CS1415
55351630	CS976	90443929	CA1045IR	93170304	CA1582IR	94115567	JS629
55351638	CS879	90443930	CA861IR	93171526	CS976	94136448	JS629
55352105	CS1291	904443931	CA1045IR	93171936	CS1257	94332586	JS753
55352882	CS1428	904444193	CS2727	93171945	CS984	94371833	JS534

O.E. NO.	HC-PARTS	O.E. NO.	HC-PARTS	O.E. NO.	HC-PARTS	O.E. NO.	HC-PARTS
94382059	JA761IR	R1540025	CS1334	5702E2	CA1761IR	95494247	CS126
94386328	JS651	R1540027	JS1158	5705E2	CA7151R	95494263	CS127
94387653	JS999	R1610391	CA1581IR	570504	CA1501R	95494264	CA1731R
94405044	JA661IR			570511	CA2911R	95494265	CA1731R
94412142	JS354	PARIS RHONE	VALEO	570525	CA2941R	95494288	CA1731R
94413997	JA697IR			570563	CA3691R	95494430	CS166
94433912	JS639	PERKINS		570570	CA3691R	95495039	CA3701R
94448959	JS552	1850866	CS1471	570582	CA7351R	95495248	CS365
94449054	JA680IR	185046360	CA1494IR	570589	CA3591R	95495299	CS155
94452739	JA680IR	185046410	CA3051R	570590	CA5331R	95495509	CS165
94454188	JA11201R	185086321	JS737	570591	CA3801R	95495512	CA2911R
94454891	JS651	185086600	CS1471	570593	CA3801R	95495842	CA1721R
94469246	JS534	185086610	JS737	570597	CA5251R	95495843	CA1731R
94469496	JS629	2871A113	CA6211R	5802E2	CS373	95495989	CA1751R
94471996	JA6731R	2871A141	CA6001R	580236	CS373	95496431	CA1731R
94483918	JS651	2871A142	CA3061R	580253	CS306	95496559	CA1721R
96627034	CS1431	2871A160	CA1494IR	580271	CS155	95496952	CS365
96627035	CS879	2871A161	CA6501R	580285	CS361	95508644	CS326
97041790	JA8631R	2871A163	CA5641R	580292	CS373	95514125	CS373
97042325	JA8711R	2871A166	JA7561R	5426014	CS126	95536160	CS567
97043064	JA8711R	2871A167	CA10851R	5433495	CS126	95580160	CA115
97074611	JA8731R	2871A168	CA10851R	5446241	CA115	95580161	CS126
97112549	JS639	2871C105	CA3251R	5446248	CA115	95580162	CA1731R
97113118	JA8631R	2871D031	CA3061R	5473145	CA115	95580163	CA1721R
97113770	JA7611R	2871D032	CA7041R	5490011	CS165	95580165	CS150
97117769	JS753	2873A029	CS994	5490308	CS126	95580166	CS166
97117770	JS651	2873A030	CS703	5490422	CS165	95580171	CS365
97133369	JS941	2873A031	CS994	5490438	CA115	95580173	CA1741R
97133854	JA12901R	2873A102	CS693	5490668	CA115	95580174	CS127
97134762	JA8731R	2873A103	CS946	5490926	CS155	95580176	CA2291R
97134866	JA12901R	2873A104	CS109	5491077	CS127	95580177	CA7351R
97136688	JS999	2873B056	CS703	5491104	CA3031R	95580180	CS155
97146338	JS999	2873B061	CS1032	5491163	CS166	95580181	CS155
97147851	JA8731R	2873B071	CS703	5491319	CA112	95580182	CS165
97150200	JA11721R	2873B072	CS994	5491448	CS126	95580183	CS169
97150201	JA13701R			5491588	CS165	95591701	CS163
97150203	JS941	PEUGEOT		5702E3	CA1761IR	95598732	CA7351R
97150204	JS1091	5802E0	CS551	5705E3	CA6391R	95598734	CA2291R
97187655	JA8731R	5702E1	CA1761IR	5802E3	CS554	95607228	CA1501R
97189112	JA15261R	5705E1	CA6181R	5705E4	CA8201R	95607229	CS326
97189113	JA15211R	555711	CA2911R	5802E4	CS566	95607232	CA2911R
97189118	JS1158	555724	CA2941R	75491453	CS166	95607233	CS352
97210505	JS999	555758	CA1491R	75491615	CS165	95607234	CS373
97223653	JS999	555762	CA1491R	75491623	CS127	95618728	CA112
97241021	JA11721R	555763	CA3691R	75491667	CA115	95619181	CS155
97326180	JA15211R	555766	CA3381R	75491668	CS165	95619190	CA1761R
97355198	JA19011R	555775	CA1491R	75491721	CA115	95619191	CA2941R
97363832	JA19001R	555779	CA1501R	75491723	CS126	95619192	CA2911R
97363833	JA19001R	555782	CA3771R	75491911	CA2291R	95619193	CA3701R
97369507	JA18991R	555797	CA2281R	75492269	CS127	95619195	CS169
97369508	JA18991R	555799	CA1751R	75492470	CA1731R	95619196	CS573
97386062	JS1158	555801	CS362	75492472	CS166	95619197	CS361
98014743	JS1158	555804	CS128	75492505	CA2291R	95619682	CA2291R
98031154	CA20101R	555806	CS150	75492566	CS126	95624960	CS390
98031155	CA20171R	555808	CS154	75492583	CA115	95624961	CA3591R
98042872	CA20101R	555818	CS168	75492638	CS127	95632024	CA3591R
98056439	JA19001R	555821	CS273	90041021	CA5561R	95632727	CA5331R
98056441	JA18991R	555832	CS155	91510299	CA3771R	95635804	CA2291R
98056867	JA15211R	555833	CS314	91536242	CS390	95643763	CS567
R1030105	CA14341R	555836	CS373	95492810	CA115	95653974	CA1751R
R1040015	JS651	555838	CS326	95492868	CS166	95656486	CA5871R
R1040024	JS651	555840	CS366	95493014	CS155	95656487	CS566
R1040032	JS941	555848	CS385	95493072	CS155	95656488	CS551
R1040037	CS984	555852	CS151	95493097	CS365	95656489	CS712
R1530001	CA8611R	555896	CS163	95493117	CA1731R	95656490	CS542
R1530024	CA15811R	557024	CA2941R	95493129	CS127	95667742	CA6181R
R1530037	JA15211R	557075	CA1491R	95493159	CS163	95667747	CA6371R
R1530041	CA11031R	557082	CA3771R	95493464	CA1721R	95667748	CA6391R
R1530043	CA15821R	557097	CA2281R	95493755	CS165	95667749	CA6391R
R1530052	CA10531R	557291	CA3801R	95493934	CS166	95667750	CA6141R
R1530084	CA19091R	558001	CS362	95494135	CA1751R	95667751	CA8321R
R1530087	CA19161R	558004	CS128	95494137	CA1751R	95667752	CS390
R1530089	JA19011R	558006	CS150	95494138	CA2291R	95667753	CS390
R1530090	JA19001R	558009	CS154	95494144	CA1721R	95667754	CS566
R1530098	CA18841R	558018	CS168	95494145	CA1721R	95668060	CA5331R
R1530099	CA18901R	558033	CS314	95494228	CA1741R	95691093	CA3701R
R1530100	CA18851R	558040	CS366	95494229	CA1741R	96009847	CA5871R
R1540010	JS1158	558052	CS151	95494230	CA1741R	96016744	CA5251R
R1540015	CS984	558096	CS163	95494231	CA1741R	96017849	CS542

O.E. NO.	HC-PARTS	O.E. NO.	HC-PARTS	O.E. NO.	HC-PARTS	O.E. NO.	HC-PARTS
<b>PEUGEOT <i>Continued</i></b>							
96024261	CS567	9615735880	CA614IR	9635501280	CS1290	9648242180	CS1342
96028857	CS390	9615736080	CA532IR	9635557780	CA1640IR	9648644680	CS581
96035033	CS566	9615736180	CA583IR	963557780	CA1641IR	9649448380	JS1368
96054384	CS1177	9616862980	CA825IR	9635772780	CA1496IR	9649611280	CA1879IR
96122596	CA637IR	9617002980	CA614IR	9635772880	CA1564IR	9649611280	CA1879IR
96170025	CA614IR	9617002980	CA614IR	9635772980	CA1646IR	9649611480	CA1499IR
96251686	CS1244	9617003080	CA832IR	9636204480	CA1498IR	9649611580	CA1499IR
97517545	CS306	9617376180	CA835IR	9636204680	CA1589IR	9649611680	CA1681IR
97530824	CS581	9617842880	CA1155IR	9636254180	CA1553IR	9649611780	CA1665IR
98490185	CA1039IR	9617842980	CA1043IR	9636545580	CA1583IR	9649611880	CA1665IR
98490186	CA1157IR	9617843180	CA1098IR	9636559780	CS1326	9649846780	CA1914IR
5705E5	CA730IR	9617849180	CA1065IR	9637075380	CA1641IR	9649846880	CA2015IR
5802E5	CS715	9617861280	CA1151IR	9637398980	CA1499IR	9650358580	CA1761IR
1475489080	CS885	9617861380	CA1152IR	9637813680	CS1260	9650582080	CA1850IR
5702E6	CA1665IR	9618673980	CA835IR	9638275380	CA1499IR	9651927480	CA1665IR
5705E6	CA1086IR	9618725080	CS581	9638275580	CA1498IR	9652035480	CA1888IR
5802E6	CS884	9618946480	CA1098IR	9638275680	CA1499IR	9654343080	CA1665IR
7910014193	CS150	9618952880	CA1065IR	9638275780	CA1589IR	9654561480	CS1416
7910014194	CS150	9618961380	CA1152IR	9638275880	CA1498IR	9654595680	CS1416
7910016727	CS128	9618961380	CA1152IR	9638275980	CA1499IR	9654752880	CA1920IR
7910246983	CS154	9618961480	CA1052IR	9638276180	CA1640IR	9655249280	CA1086IR
7932567913	CS273	9618961580	CA1152IR	9638276280	CA1641IR	9655296080	CA1879IR
9150136780	CS168	9618961680	CA1052IR	9638543580	CA1687IR	9655858280	CA1879IR
9150457580	CS150	9619310280	CS566	9638543680	CA1665IR	9656003780	CA1589IR
9150516480	CS128	9619333080	CA825IR	9638543780	CA1681IR	9656262780	CS594
9150747780	CS326	9619333280	CA825IR	9638544180	CA1687IR	9656299480	CS594
9150747880	CS326	9619333380	CA836IR	9638544280	CA1665IR	9656317680	CS1244
9150803080	CS314	9619429380	CA715IR	9638544580	CA1665IR	9656955880	CA1687IR
9150864480	CS326	9619916180	CA1098IR	9639362380	CA1509IR	9656956080	CA1498IR
9150864580	CS326	9620170280	CA1099IR	9639362380	CA1509IR	9656956280	CA1665IR
9150870780	CA228IR	9620332580	CA1038IR	9639396580	CA1741IR	9656956380	CA1499IR
9151082480	CS314	9621158480	CA1156IR	9640088080	CA1741IR	9657129680	CA1888IR
9151095080	CA294IR	9621191780	CA1043IR	9640623580	CA1674IR	9658308780	CS581
9151424580	CS355	9621308580	CA1243IR	9640623580	CA1674IR	9660055080	CA1665IR
9151589980	CA308IR	9621791480	CA1509IR	9640825280	CS1260	9662731680	CA2008IR
9151798380	CA294IR	9621791680	CA1442IR	9640878780	CA1553IR	9662854080	CS1329
9151798480	CA532IR	9623083780	CA1315IR	9641302580	CA1553IR	9662854180	CS1391
9152017480	CA597IR	9623272180	CA1442IR	9641398480	CA1498IR	9663010980	CA2030IR
9467560280	CA1509IR	9623272280	CA1496IR	9641398680	CA1499IR	9663258880	CS1329
9467560380	CA1553IR	9623272380	CA1564IR	9641727480	CA1641IR	9663647980	CA2031IR
9555507680	CS1342	9623272780	CA1496IR	9642124980	CA1741IR	9664016980	CS1260
9558385480	CS361	9623272880	CA1564IR	9642147380	CA1646IR	9664057480	CA2031IR
9559873580	CA370IR	9623272980	CA1646IR	9642879480	CA1687IR	9664074280	CA2030IR
9559976380	CA583IR	9624141480	CA1043IR	9642879680	CA1665IR	9664532780	CA1954IR
9602174480	CA359IR	9624141580	CA1065IR	9642879780	CA1681IR	9664779680	CA2033IR
9603138880	CA532IR	9624177680	CA1312IR	9642879980	CA1498IR	9664883080	JS1368
9603139280	CA583IR	9625168580	CS1277	9642880080	CA1499IR	9665067980	CA1665IR
9603145180	CA597IR	9625168680	CS1244	9642880180	CA1589IR	9665577480	CA1687IR
9603503580	CS1177	9625382480	CS885	9642880280	CA1442IR	9665577580	CA1498IR
9603503680	CS712	9625382680	CS594	9642880380	CA1496IR	9665577780	CA1499IR
9603546480	CA832IR	9625382780	CS1177	9642880480	CA1564IR	9665617780	CA2008IR
9603552680	CA614IR	9626261480	CS1111	9643001680	CA1778IR	9688085380	CA1920IR
9605062780	CA617IR	9627727180	CA1442IR	9644037180	CA2008IR	9688268480	CS1260
9605062980	CA618IR	9627963380	CA1338IR	9644103580	CA1761IR	9751377680	CS306
9605219380	CS390	9628925380	CA618IR	9644103580	CA1761IR	5705E7	CA825IR
9607641280	CA1086IR	9630080280	CA1098IR	9644529680	CA1850IR	5802E7	CS621
9608719280	CS390	9630204580	CA1499IR	9644904680	CA1832IR	5705E8	CA836IR
9609313280	CS581	9631318180	CA1152IR	9644927080	CA1932IR	5802E8	CS581
9610205880	CS715	9631318280	CA1052IR	9645100680	CS1329	5702E9	CA1914IR
9610601580	CA825IR	9631318380	CA1043IR	9645100680	CS1329	5802E9	CS542
9610601880	CA836IR	9631318480	CA1065IR	9645907580	CA1553IR	5702A0	CA1553IR
9610870880	CA556IR	9631318580	CA1086IR	9645907680	CA1553IR	5702A1	CA1553IR
9610870880	CA556IR	9631318680	CA825IR	9645907780	CA1509IR	5702A2	CA1687IR
9610870980	CA614IR	9631318780	CA836IR	9645907880	CA1509IR	5702A3	CA1665IR
9610871080	CA832IR	9631324980	CA1305IR	9646049980	CA1674IR	5702A4	CA1681IR
9611365980	CA1086IR	9631325080	CA1305IR	9646065180	CA1920IR	5702A5	CA1741IR
9611366880	CA1086IR	9631919080	CA1338IR	9646065480	CA1761IR	5702A6	CA1674IR
9611369580	CA1086IR	9631919180	CA1388IR	9646068880	CA1674IR	5702A7	CA1674IR
9612257180	CA1086IR	9632489280	CA1392IR	9646153680	CA1442IR	5702A8	CA2037IR
9612259680	CA637IR	9633292480	CS581	9646321780	CA1761IR	5702C0	CA1643IR
9612259880	CA638IR	9633782480	CA1497IR	9646321880	CA1761IR	5702C3	CA1388IR
9612264280	CA820IR	9633782580	CA1498IR	9646388280	CA1920IR	5702C4	CA1388IR
9612264380	CA730IR	9633782680	CA1499IR	9646476280	CA1674IR	5702C5	CA1674IR
9612264680	CA820IR	9634475880	CA1392IR	9646477580	CA1674IR	5702C6	CA1674IR
9612558880	CS712	9634476880	CA715IR	9646679980	CS1260	5702C7	CA1832IR
9613015980	CS566	9634476880	CA715IR	9646694080	CS1391	5702C8	CA1687IR
9613230280	CS566	9634561480	CA1642IR	9646972280	CS1342	5702C9	CA1665IR
9613496680	CA637IR	9635342080	CA1509IR	9647157980	CS1342	5702F0	CA1665IR
9615519880	CS566	9635342080	CA1509IR	9648111680	CS594	5702F3	CA1674IR

O.E. NO.	HC-PARTS	O.E. NO.	HC-PARTS	O.E. NO.	HC-PARTS	O.E. NO.	HC-PARTS
5702F4	CA1920IR	57055X	CA1640IR	5705EY	CA1761IR	5705KG	CA1954IR
5702F8	CA1888IR	57055Y	CA1640IR	5705F2	CA533IR	5705KH	CA1978IR
5702F9	CA1914IR	57055Z	CA1641IR	5705F3	CA637IR	5705KJ	CA1949IR
5702G2	CA1920IR	57056A	CA1642IR	5705F4	CA638IR	5705KQ	CA2087IR *
5702G3	CA2006IR	57056B	CA1392IR	5705FA	CA1665IR	5705KR	CA2030IR
5702G4	CA1990IR *	57056C	CA1687IR	5705FE	CA1243IR	5705KV	CA2033IR
5702G8	CA2008IR	57056D	CA1665IR	5705FF	CA1152IR	5705KW	CA2015IR
5702G9	CA1879IR	57056E	CA1681IR	5705FH	CA1156IR	5705KX	CA1498IR
5702H0	CA1879IR	57056K	CA1920IR	5705FK	CA1305IR	5705KY	CA1499IR
5702H4	CA1850IR	57056M	CA1641IR	5705FN	CA1043IR	5705L1	CA1038IR
5702H7	CA2031IR	57056N	CA1741IR	5705FP	CA1152IR	5705L2	CA1203IR
5702H9	CA2006IR	57056P	CA1674IR	5705FV	CA1496IR	5705L3	CA836IR
5702J1	CA1978IR	57056Q	CA1835IR	5705FW	CA1442IR	5705L4	CA1099IR
5702J2	CA1949IR	57056R	CA1302IR	5705FX	CA1564IR	5705L5	CA1155IR
5702J3	CA2087IR *	57056S	CA1640IR	5705FY	CA1646IR	5705L6	CA1043IR
5702J4	CA2030IR	57056T	CA1640IR	5705FZ	CA1338IR	5705L7	CA1043IR
5702J9	CA2033IR	57056U	CA1641IR	5705G0	CA715IR	5705M5	CA1315IR
57051F	CA1338IR	57056V	CA1641IR	5705G4	CA556IR	5705M6	CA1095IR
57051G	CA1388IR	57056W	CA1642IR	5705G5	CA614IR	5705M7	CA1095IR
57051J	CA1305IR	57056X	CA1642IR	5705G6	CA832IR	5705M8	CA1086IR
57051K	CA1243IR	57056Y	CA1498IR	5705GA	CA1388IR	5705M9	CA1086IR
57051N	CA1583IR	57056Z	CA1498IR	5705GC	CA1509IR	5705N0	CA1038IR
57051P	CA1098IR	57057A	CA1499IR	5705GE	CA1497IR	5705N1	CA1038IR
57051Q	CA1098IR	57057C	CA1499IR	5705GF	CA1640IR	5705N2	CA1203IR
57051R	CA1156IR	57057E	CA1589IR	5705GG	CA1641IR	5705N3	CA1203IR
57051T	CA1156IR	57057F	CA1589IR	5705GH	CA1642IR	5705N4	CA1099IR
57051X	CA1305IR	57057G	CA1641IR	5705GJ	CA1640IR	5705N5	CA639IR
57051Y	CA1305IR	57057H	CA1641IR	5705GK	CA1641IR	5705N6	CA820IR
57052A	CA1442IR	57057K	CA836IR	5705GL	CA1642IR	5705N7	CA825IR
57052B	CA1496IR	57057P	CA1392IR	5705GN	CA1498IR	5705NA	CA1879IR
57052C	CA1564IR	57058A	CA1687IR	5705GP	CA1499IR	5705NE	CA1674IR
57052D	CA1646IR	57058C	CA1665IR	5705GQ	CA1589IR	5705NH	CA1761IR
57052E	CA617IR	57058E	CA1681IR	5705GR	CA836IR	5705NN	CA1978IR
57052F	CA618IR	57058F	CA1741IR	5705GT	CA1392IR	5705NP	CA1949IR
57052H	CA369IR	57058G	CA1674IR	5705GV	CA1084IR	5705P7	CA836IR
57052J	CA359IR	57058H	CA1741IR	5705GW	CA1199IR	5705R2	CA380IR
57052K	CA294IR	5705A0	CA583IR	5705GZ	CA1687IR	5705R5	CA1043IR
57052N	CA637IR	5705A2	CA587IR	5705H1	CA835IR	5705R6	CA1065IR
57052P	CA1043IR	5705AC	CA1674IR	5705H5	CA820IR	5705R7	CA1065IR
57052Q	CA1152IR	5705AE	CA2037IR	5705H6	CA730IR	5705R9	CA1565IR
57053B	CA614IR	5705AF	CA1643IR	5705H7	CA825IR	5705S0	CA1199IR
57053C	CA832IR	5705AJ	CA1392IR	5705H8	CA636IR	5705S1	CA836IR
57053D	CA835IR	5705AK	CA1781IR	5705H8	CA729IR	5705S2	CA1151IR
57054C	CA1039IR	5705AL	CA1674IR	5705HA	CA1741IR	5705S3	CA1152IR
57054E	CA1157IR	5705AN	CA1832IR	5705HC	CA1674IR	5705S4	CA1152IR
57054F	CA1509IR	5705AP	CA1687IR	5705HH	CA533IR	5705S5	CA1156IR
57054G	CA1497IR	5705AQ	CA1665IR	5705HJ	CA715IR	5705W4	CA1151IR
57054H	CA1498IR	5705AR	CA1761IR	5705HK	CA820IR	5705W5	CA1151IR
57054J	CA1499IR	5705AS	CA1761IR	5705HL	CA730IR	5705W7	CA1152IR
57054K	CA1589IR	5705AT	CA1637IR	5705HN	CA825IR	5705W9	CA1052IR
57054N	CA1640IR	5705AV	CA1932IR	5705HP	CA729IR	5705X0	CA1052IR
57054P	CA1641IR	5705AW	CA1665IR	5705HQ	CA638IR	5705X2	CA715IR
57054Q	CA1642IR	5705AX	CA1920IR	5705HS	CA1095IR	5705X3	CA1203IR
57054R	CA1442IR	5705AZ	CA1499IR	5705HT	CA1086IR	5705X7	CA1155IR
57054T	CA1442IR	5705C3	CA175IR	5705HV	CA1038IR	5705X8	CA1155IR
57054U	CA1496IR	5705C5	CA587IR	5705HW	CA1203IR	5705X9	CA618IR
57054V	CA1496IR	5705C6	CA556IR	5705HX	CA639IR	5705Y0	CA715IR
57054W	CA1564IR	5705C7	CA1832IR	5705HY	CA1065IR	5705Y1	CA637IR
57054X	CA1564IR	5705CA	CA1914IR	5705HZ	CA836IR	5705Y2	CA638IR
57054Y	CA1646IR	5705CF	CA2015IR	5705J0	CA638IR	5705Y3	CA1334IR
57054Z	CA1646IR	5705CH	CA1315IR	5705J1	CA1238IR	5705Y4	CA1312IR
57055A	CA1498IR	5705CJ	CA1888IR	5705J2	CA1238IR	5705Y9	CA176IR
57055B	CA1499IR	5705CQ	CA1589IR	5705J9	CA1095IR	5705Z0	CA294IR
57055C	CA1589IR	5705CS	CA1879IR	5705JA	CA1151IR	5705Z3	CA359IR
57055E	CA1392IR	5705CW	CA1665IR	5705JC	CA1052IR	5705AA	CA1553IR
57055F	CA1388IR	5705CX	CA1499IR	5705JE	CA1155IR	5802A0	CS390
57055G	CA1388IR	5705EA	CA1928IR	5705JF	CA1920IR	5802A8	CS551
57055H	CA1509IR	5705EE	CA1920IR	5705JG	CA2006IR	5802A9	CS551
57055J	CA1509IR	5705EF	CA2015IR	5705JH	CA1388IR	5802AE	CS1391
57055K	CA1497IR	5705EJ	CA1888IR	5705JK	CA617IR	5802AF	CS1391
57055L	CA1497IR	5705EK	CA1914IR	5705JN	CA359IR	5802AG	CS1391
57055M	CA1640IR	5705EL	CA1641IR	5705JR	CA637IR	5802AH	JS1368
57055N	CA1640IR	5705EN	CA1665IR	5705JS	CA618IR	5802AJ	JS1368
57055P	CA1641IR	5705ER	CA1553IR	5705JV	CA2008IR	5802AL	CS1407
57055Q	CA1641IR	5705ES	CA1674IR	5705K1	CA735IR	5802AN	CS1407
57055R	CA1642IR	5705ET	CA2037IR	5705K7	CA1098IR	5802AR	CS1417
57055T	CA1498IR	5705EV	CA1643IR	5705KA	CA2013IR *	5802AS	CS1421
57055U	CA1499IR	5705EW	CA1674IR	5705KC	CA2031IR	5802AT	CS1416
57055V	CA1589IR	5705EX	CA1761IR	5705KF	CA2006IR	5802AV	CS1416

O.E. NO.	HC-PARTS	O.E. NO.	HC-PARTS	O.E. NO.	HC-PARTS	O.E. NO.	HC-PARTS
<b>PEUGEOT Continued</b>							
5802AW	CS1416	5802V7	CS1244	37300-2W000	JA1795IR	922	CA1473IR
5802AX	JS1368	5802V8	CS1277	37300-2W001	JA1795IR	947	CA861IR
5802AZ	CS1260	5802V9	CS1108			110397	CS331
5802C2	CS390	5802W0	CS1108	<b>PORSCHE</b>			
5802C4	CS712	5802W1	CS1244	91160312004	CA813IR	110566	JS1159
5802C9	CS581	5802W2	CS1277	91160312005	CA814IR	111018	JS633
5802CA	CS1416	5802W3	CS1244	91160315501	CA1074IR	111089	JS640
5802CC	CS390	5802W4	CS594	91160410101	CS508	111534	JS517
5802CE	CS1391	5802W6	CS1290	91660410100	CS508	112161	CS977
5802CG	CS581	5802W7	CS1326	95560301700	CA1749IR	112816	JS640
5802CH	CS621	5802W9	CS594	95560410700	CS1327	112847	JS1098
5802CJ	CS712	5802X6	CS1057	96460315600	CA1074IR	113136	JS1311
5802CK	CS542	5802X7	CS1290	96460315601	CA1074IR	199903	US864
5802CL	CS885	5802X8	CS1290	96460410400	CS888	219053	JA173IR
5802CP	CS1177	5802X9	CS1326	96460410300	CS1440	219091	CA1386IR
5802CQ	CS570	5802Y0	CS1326	99660410400	CS1440	219101	JA694IR
5802CR	CS1111	5802Y3	CS581	99660410700	CS888	219137	CA1745IR
5802CS	CS326	5802Y4	CS1260	99660410701	CS888	219138	CA1672IR
5802CV	CS1108	5802Y5	CS1260	99660410800	CS888	219139	CA1671IR
5802CW	CS1244	5802Y6	CS1260	911603120EX	CA814IR	219170	JA1600IR
5802CY	CS594	5802Y9	CS1109			219170	JA1600IR
5802CZ	CS1290	5802Z0	CS1198	<b>PRESTOLITE</b>			
5802EA	CS1326	5802Z1	CS1109	858320	CS394	219187	CA1385IR
5802EF	CS1342	5802Z3	CS1198	858884	CA518IR	219187	CA1385IR
5802EG	CS1329	5802Z5	CS1342	859232	CA333IR	219199	CA1745IR
5802EP	CS581	5802Z6	CS1342	859327	CA1193IR	219202	CA1672IR
5802EQ	CS1177	5802Z7	CS1342	860809	CA1693IR	219235	JA1600IR ▲
5802ER	CS542	5802Z8	CS1329	128515	CA1668IR	219235	JA1600IR ▲
5802ES	CS566	5802Z9	CS1329	1286000	CA1669IR	219251	JA1600IR ▲
5802ET	CS715	5802AA	CS1329	1286500	CA1670IR	219292	JA1600IR ▲
5802EV	CS1417	AM532-010AR	CA115	1286590	CA1670IR	800264	JS1098
5802EY	CS1407	GX0610501B	CS127	20130103	JA193	1100077	UA929IR
5802EZ	CS1407	GX0610501BR	CS127	20500762	CS103	1100092	UA930IR
5802F1	CS621	GX0610502A	CS127	20500969	CS994	1100093	UA929IR
5802F3	CS542	GX0610502AR	CS127	20510202	CS1245	1100109	UA943IR
5802F6	CS885	V753509680	CA1990IR *	66021126	CA1457IR	1100110	UA943IR
5802FC	CS1421	V755001780	CS1417	66021836	CA1494IR	1100111	UA943IR
5802FE	JS1368	V755300980	CA2006IR	66925111	CS371	1100113	UA943IR
5802FG	CS1260	V757436580	CA2006IR	AELB697	CA333IR	1100115	UA943IR
5802FJ	CS594	V757695680	CA2087IR *	ANB6004	UA932	1100116	UA943IR
5802FK	CS594	V75769568002	CA2087IR *	ANB7001	UA932	1100117	UA943IR
5802G2	CS542			ANB7002	UA932	1100118	UA943IR
5802G4	CS885	<b>POONG SUNG</b>				1100119	UA943IR
5802H4	CS715	02121-8025	JA1795IR ▲	ANB7003	UA932	1100120	UA943IR
5802H6	CS885	02121-8025	JA1795IR ▲	ANB7004	UA932	1100121	UA943IR
5802H7	CS712	02121-8027	JA1795IR ▲	MCD4007	US872	1100122	UA943IR
5802H8	CS373	02121-8027	JA1795IR ▲	MDH4001	US871	1100123	UA943IR
5802J2	CS551	02121-8070	JA1795IR ▲	MDW4001M	US854	1100124	UA943IR
5802J3	CS715	02121-8070	JA1795IR ▲	MDW4101M	US854	1100125	UA943IR
5802L9	CS542	02121-8070	JA1795IR ▲	MDW4103M	US854	1100127	UA943IR
5802M0	CS542	02121-8071	JA1795IR ▲	MDW4204M	US967	1100128	UA943IR
5802M3	CS1177	02121-8071	JA1795IR ▲	MFY6201L	US823	1100129	UA943IR
5802M4	CS1177	02121-8073	JA1795IR ▲	MFY6201K	US823	1100130	UA943IR
5802M5	CS885	02121-8073	JA1795IR ▲	MFY6401K	US823	1100131	UA943IR
5802M6	CS884	02121-8073	JA1795IR ▲	MFY6401L	US823	1100132	UA943IR
5802M7	CS594	02121-8074	JA1795IR ▲	MFY6601L	US823	1100133	UA943IR
5802M9	CS1111	02121-8074	JA1795IR ▲	MFY6601K	US823	1100135	UA943IR
5802N3	CS581	02121-8074	JA1795IR ▲	MGD4001M	US854	1100136	UA943IR
5802N4	CS1108	02131-9040	JA1539IR	MGD4002A	US967	1100137	UA943IR
5802P8	CS581	02131-9070	JA1539IR ▲	MGD4002C	US967	1100138	UA943IR
5802Q0	CS551	02131-9110	JA1708IR	MGD4002M	US967	1100139	UA943IR
5802Q1	CS390	02131-9111	JA1708IR	MGD4007	US872	1100140	UA943IR
5802Q2	CS566	02131-9112	JA1708IR	MGD4007A	US872	1100141	UA943IR
5802Q3	CS542	02131-9113	JA1708IR	MGD4102A	US967	1100142	UA943IR
5802Q5	CS570	02131-9261	CA2018IR	MGD4102C	US967	1100143	UA943IR
5802Q7	CS1111	02131-9262	CA2018IR	MGD4108	US875	1100144	UA943IR
5802Q9	CS1111	02131-9310	JA1708IR	MGD4113	US872	1100145	UA943IR
5802R3	CS1111	02131-9311	JA1708IR	MGD4002	US873	1100146	UA943IR
5802R4	CS581	03101-3030	JS552	MGL4002	US873	1100147	UA943IR
5802R5	CS542	03101-3050	JS365	MGL4013	US873	1100148	UA943IR
5802R6	CS326	03101-3050	JS365	MGL4014	US873	1100149	UA943IR
5802R8	CS566	03101-3170	JS1234	MGL4109	US874	1100150	UA943IR
5802S3	CS1177	03101-3190	JS1234	MKW4001	US874	1100151	UA943IR
5802S3	CS594	03101-3220	JS1234	POC4001	US874	1100152	UA943IR
5802S4	CS306	03111-4040	CS331			1100153	UA943IR
5802S8	CS885	03111-4041	CS331	<b>REMY (DELCO)</b>			
5802V4	CS973	03111-4140	JS1298	00E091	CS977	1100154	UA943IR
5802V5	CS594	03111-4240	CS1446	215	CA1253IR	1100155	UA943IR
5802V6	CS1177	03111-4241	CS1446	454	CA1103IR	1100156	UA943IR
		37300-2W000	JA1795IR	456	CA1053IR	1100157	UA943IR
						1100158	UA943IR
						1100159	UA943IR



O.E. NO.	HC-PARTS	O.E. NO.	HC-PARTS	O.E. NO.	HC-PARTS	O.E. NO.	HC-PARTS
1100162	UA943IR	1100274	UA929IR	1100593	UA943IR	1100702	UA916
1100163	UA943IR	1100275	UA945IR	1100595	UA943IR	1100703	UA916
1100164	UA943IR	1100276	UA945IR	1100596	UA943IR	1100704	UA916
1100165	UA943IR	1100280	UA943IR	1100597	UA943IR	1100705	UA916
1100166	UA943IR	1100281	UA943IR	1100598	UA943IR	1100706	UA916
1100167	UA943IR	1100282	UA925IR	1100600	UA916	1100707	UA916
1100168	UA943IR	1100287	UA945IR	1100601	UA916	1100708	UA916
1100170	UA943IR	1100288	UA945IR	1100605	UA916	1100709	UA916
1100171	UA943IR	1100289	UA945IR	1100613	UA916	1100710	UA916
1100174	UA943IR	1100290	UA945IR	1100616	UA916	1100711	UA916
1100175	UA943IR	1100291	UA945IR	1100617	UA916	1100713	UA916
1100176	UA943IR	1100292	UA943IR	1100618	UA916	1100714	UA916
1100179	UA943IR	1100294	UA943IR	1100620	UA916	1100719	UA916
1100181	UA943IR	1100297	UA943IR	1100621	UA916	1100720	UA916
1100182	UA943IR	1100298	UA945IR	1100622	UA916	1100724	UA916
1100183	UA925IR	1100299	UA945IR	1100623	UA916	1100725	UA916
1100184	UA925IR	1100300	UA945IR	1100624	UA916	1100726	UA916
1100187	UA925IR	1100481	UA943IR	1100625	UA916	1100727	UA916
1100189	UA925IR	1100485	UA943IR	1100627	UA916	1100728	UA916
1100196	UA943IR	1100486	UA943IR	1100628	UA916	1100729	UA916
1100197	UA943IR	1100487	UA943IR	1100629	UA916	1100730	UA916
1100198	UA943IR	1100490	UA943IR	1100630	UA916	1100731	UA916
1100199	UA943IR	1100491	UA943IR	1100631	UA916	1100733	UA916
1100200	UA945IR	1100492	UA943IR	1100632	UA916	1100734	UA916
1100201	UA943IR	1100493	UA943IR	1100633	UA916	1100736	UA916
1100202	UA943IR	1100494	UA943IR	1100634	UA916	1100737	UA916
1100203	UA943IR	1100495	UA943IR	1100636	UA916	1100738	UA916
1100204	UA943IR	1100496	UA943IR	1100637	UA916	1100739	UA916
1100205	UA945IR	1100497	UA943IR	1100638	UA916	1100740	UA916
1100206	UA945IR	1100498	UA943IR	1100639	UA916	1100741	UA916
1100207	UA945IR	1100499	UA930IR	1100640	UA916	1100742	UA916
1100208	UA945IR	1100533	UA916	1100642	UA916	1100744	UA916
1100209	UA945IR	1100542	UA943IR	1100646	UA916	1100745	UA916
1100211	UA929IR	1100543	UA943IR	1100647	UA916	1100750	UA916
1100217	UA945IR	1100544	UA943IR	1100648	UA916	1100752	UA916
1100218	UA943IR	1100545	UA943IR	1100649	UA916	1100755	UA916
1100221	UA943IR	1100546	UA943IR	1100651	UA916	1100758	UA916
1100222	UA943IR	1100547	UA943IR	1100655	UA916	1100759	UA916
1100223	UA925IR	1100548	UA943IR	1100656	UA916	1100760	UA916
1100225	UA943IR	1100549	UA943IR	1100657	UA916	1100761	UA916
1100226	UA943IR	1100550	UA943IR	1100658	UA916	1100762	UA916
1100227	UA943IR	1100551	UA943IR	1100659	UA916	1100763	UA916
1100228	UA943IR	1100552	UA943IR	1100661	UA916	1100764	UA916
1100229	UA943IR	1100553	UA916	1100662	UA916	1100765	UA916
1100230	UA943IR	1100554	UA943IR	1100663	UA916	1100767	UA916
1100231	UA943IR	1100556	UA943IR	1100664	UA916	1100768	UA916
1100232	UA943IR	1100557	UA916	1100665	UA916	1100769	UA916
1100233	UA943IR	1100558	UA916	1100668	UA916	1100770	UA916
1100234	UA943IR	1100559	UA943IR	1100669	UA916	1100771	UA916
1100235	UA943IR	1100560	UA943IR	1100670	UA916	1100772	UA916
1100236	UA943IR	1100561	UA943IR	1100671	UA916	1100774	UA916
1100237	UA945IR	1100562	UA943IR	1100672	UA916	1100775	UA916
1100238	UA943IR	1100563	UA943IR	1100674	UA916	1100777	UA916
1100239	UA945IR	1100564	UA943IR	1100675	UA916	1100778	UA916
1100240	UA945IR	1100565	UA943IR	1100676	UA916	1100779	UA916
1100241	UA945IR	1100566	UA916	1100677	UA916	1100780	UA916
1100242	UA945IR	1100567	UA916	1100678	UA916	1100781	UA916
1100243	UA945IR	1100568	UA916	1100679	UA916	1100782	UA916
1100246	UA945IR	1100569	UA916	1100680	UA916	1100784	UA916
1100247	UA945IR	1100570	UA916	1100681	UA916	1100787	UA916
1100249	UA945IR	1100571	UA916	1100682	UA916	1100788	UA916
1100250	UA945IR	1100572	UA916	1100683	UA916	1100789	UA916
1100251	UA945IR	1100573	UA943IR	1100684	UA916	1100790	UA916
1100252	UA945IR	1100574	UA943IR	1100686	UA916	1100791	UA916
1100254	UA945IR	1100575	UA943IR	1100687	UA916	1100793	UA916
1100255	UA945IR	1100578	UA943IR	1100688	UA916	1100794	UA916
1100256	UA943IR	1100579	UA943IR	1100689	UA916	1100795	UA916
1100257	UA945IR	1100580	UA943IR	1100690	UA916	1100796	UA916
1100259	UA945IR	1100581	UA943IR	1100691	UA916	1100797	UA916
1100260	UA945IR	1100582	UA943IR	1100692	UA916	1100798	UA943IR
1100263	UA945IR	1100583	UA943IR	1100693	UA916	1100799	UA943IR
1100264	UA945IR	1100584	UA943IR	1100694	UA916	1100800	UA943IR
1100265	UA945IR	1100585	UA943IR	1100695	UA916	1100801	UA943IR
1100266	UA945IR	1100587	UA943IR	1100696	UA916	1100802	UA916
1100268	UA943IR	1100588	UA943IR	1100697	UA916	1100803	UA916
1100269	UA945IR	1100589	UA944IR	1100698	UA916	1100804	UA916
1100270	UA945IR	1100590	UA916	1100699	UA916	1100805	UA916
1100272	UA945IR	1100591	UA916	1100700	UA916	1100807	UA916
1100273	UA945IR	1100592	UA943IR	1100701	UA916	1100808	UA916

O.E. NO.	HC-PARTS	O.E. NO.	HC-PARTS	O.E. NO.	HC-PARTS	O.E. NO.	HC-PARTS
REMY (DELCO)	<i>Continued</i>						
1100809	UA916	1100917	UA916	1101081	UA925IR	1101307	UA945IR
1100810	UA916	1100919	UA943IR	1101082	UA925IR	1101308	UA955IR
1100811	UA916	1100920	UA943IR	1101083	UA925IR	1101310	UA964IR
1100813	UA916	1100921	UA916	1101084	UA925IR	1101318	UA933IR
1100814	UA916	1100922	UA943IR	1101085	UA925IR	1101320	UA953IR
1100815	UA916	1100923	UA943IR	1101086	UA925IR	1101321	UA947IR
1100816	UA916	1100924	UA943IR	1101087	UA925IR	1101324	UA955IR
1100817	UA916	1100925	UA943IR	1101088	UA925IR	1101332	UA955IR
1100818	UA916	1100926	UA943IR	1101090	UA924IR	1101333	UA945IR
1100819	UA916	1100927	UA943IR	1101091	UA938IR	1101344	UA1109IR
1100820	UA916	1100928	UA943IR	1101093	UA925IR	1101345	UA954IR
1100825	UA943IR	1100929	UA943IR	1101094	UA925IR	1101346	UA938IR
1100826	UA943IR	1100930	UA943IR	1101095	UA925IR	1101434	UA925IR
1100828	UA916	1100931	UA916	1101097	UA925IR	1101435	UA938IR
1100830	UA943IR	1100932	UA916	1101098	UA925IR	1101436	UA925IR
1100831	UA943IR	1100933	UA916	1101107	UA1113IR	1101437	UA925IR
1100832	UA943IR	1100934	UA943IR	1101109	UA938IR	1101442	UA925IR
1100833	UA943IR	1100935	UA943IR	1101110	UA939IR	1101443	UA925IR
1100834	UA916	1100936	UA943IR	1101111	UA939IR	1101444	UA925IR
1100836	UA916	1100937	UA943IR	1101124	UA940IR	1101445	UA925IR
1100837	UA916	1100939	UA916	1101126	UA941IR	1101448	UA925IR
1100838	UA916	1100940	UA943IR	1101127	UA958IR	1101449	UA925IR
1100839	UA916	1100943	UA916	1101136	UA1109IR	1101461	UA942IR
1100841	UA916	1100944	UA916	1101137	UA937IR	1101465	UA953IR
1100842	UA916	1100946	UA943IR	1101138	UA937IR	1101466	UA1113IR
1100843	UA916	1100947	UA943IR	1101139	UA938IR	1101467	UA1113IR
1100845	UA916	1100948	UA943IR	1101140	UA938IR	1101483	UA947IR
1100846	UA916	1100949	UA943IR	1101141	UA937IR	1101484	UA955IR
1100847	UA916	1100950	UA943IR	1101142	UA938IR	1101484	UA955IR
1100849	UA916	1100951	UA916	1101143	UA938IR	1101521	UA939IR
1100851	UA916	1101015	UA924IR	1101143	UA938IR	1101551	CA517IR
1100852	UA943IR	1101016	UA924IR	1101149	UA938IR	1101571	UA953IR
1100853	UA943IR	1101017	UA924IR	1101151	UA941IR	1101577	UA964IR
1100854	UA943IR	1101018	UA924IR	1101155	UA943IR	1101582	UA939IR
1100855	UA943IR	1101019	UA924IR	1101157	UA955IR	1101583	UA938IR
1100856	UA916	1101021	UA924IR	1101158	UA941IR	1101593	UA938IR
1100857	UA916	1101022	UA924IR	1101159	UA943IR	1101595	UA938IR
1100859	UA943IR	1101023	UA924IR	1101162	UA938IR	1101596	UA938IR
1100860	UA916	1101024	UA924IR	1101167	UA923IR	1101599	UA939IR
1100861	UA943IR	1101026	UA924IR	1101168	UA923IR	1101600	UA939IR
1100865	UA943IR	1101027	UA924IR	1101170	UA923IR	1101601	UA958IR
1100870	UA916	1101028	UA924IR	1101176	UA947IR	1101603	UA1109IR
1100871	UA916	1101029	UA924IR	1101176	UA947IR	1101606	UA1113IR
1100872	UA943IR	1101030	UA924IR	1101184	UA940IR	1101606	UA1113IR
1100873	UA943IR	1101031	UA924IR	1101192	UA943IR	1101618	UA938IR
1100874	UA943IR	1101032	UA924IR	1101196	CA353IR	1101619	UA953IR
1100875	UA916	1101033	UA924IR	1101199	CA352IR	1101620	UA939IR
1100878	UA916	1101034	UA924IR	1101203	UA943IR	1101621	UA953IR
1100879	UA916	1101035	UA924IR	1101203	UA943IR	1101629	UA939IR
1100880	UA943IR	1101036	UA924IR	1101224	UA936IR	1101632	UA939IR
1100881	UA943IR	1101037	UA925IR	1101225	UA925IR	1101633	UA939IR
1100882	UA943IR	1101038	UA925IR	1101228	UA945IR	1101634	UA953IR
1100883	UA916	1101039	UA925IR	1101231	UA938IR	1101635	UA953IR
1100884	UA943IR	1101040	UA925IR	1101240	UA955IR	1101636	UA953IR
1100885	UA916	1101041	UA925IR	1101241	UA955IR	1101642	UA1112IR
1100886	UA916	1101042	UA925IR	1101243	UA943IR	1101645	UA939IR
1100888	UA916	1101043	UA924IR	1101243	UA943IR	1101646	UA939IR
1100889	UA916	1101044	UA925IR	1101244	UA945IR	1101647	UA939IR
1100890	UA943IR	1101045	UA925IR	1101245	UA955IR	1101649	UA964IR
1100891	UA916	1101046	UA924IR	1101253	UA933IR	1101650	UA964IR
1100892	UA916	1101047	UA924IR	1101254	UA933IR	1101700	UA925IR
1100893	UA916	1101048	UA924IR	1101255	UA933IR	1101806	UA941IR
1100895	UA916	1101049	UA925IR	1101259	UA965IR	1101807	UA953IR
1100896	UA916	1101050	UA924IR	1101264	UA958IR	1101810	UA938IR
1100897	UA943IR	1101058	UA924IR	1101268	UA955IR	1101814	UA953IR
1100899	UA943IR	1101060	UA924IR	1101273	UA958IR	1101815	UA953IR
1100900	UA943IR	1101061	UA924IR	1101275	UA958IR	1101822	UA938IR
1100901	UA943IR	1101062	UA924IR	1101276	UA945IR	1101832	UA1109IR
1100902	UA943IR	1101063	UA924IR	1101277	UA938IR	1101843	UA958IR
1100903	UA943IR	1101064	UA924IR	1101278	UA938IR	1101846	UA1109IR
1100904	UA943IR	1101066	UA925IR	1101279	UA945IR	1101924	UA925IR
1100905	UA916	1101067	UA925IR	1101282	UA943IR	1101925	UA925IR
1100906	UA916	1101071	UA925IR	1101291	UA947IR	1102311	UA943IR
1100907	UA916	1101072	UA925IR	1101293	UA939IR	1102343	UA943IR
1100908	UA916	1101073	UA924IR	1101298	UA955IR	1102345	UA945IR
1100909	UA916	1101074	UA925IR	1101299	UA955IR	1102346	UA943IR
1100910	UA916	1101075	UA925IR	1101300	UA955IR	1102347	UA943IR
1100911	UA943IR	1101078	UA925IR	1101301	UA955IR	1102349	UA943IR
1100916	UA916	1101080	UA925IR	1101303	UA945IR	1102350	UA943IR
				1101304	UA955IR	1102351	UA943IR
				1101305	UA955IR	1102352	UA943IR



O.E. NO.	HC-PARTS	O.E. NO.	HC-PARTS	O.E. NO.	HC-PARTS	O.E. NO.	HC-PARTS
REMY (DELCO)	<i>Continued</i>						
1103198	UA943IR	1105250	UA925IR	1105565	UA945IR	1105707	UA945IR
1103199	UA943IR	1105328	UA925IR	1105566	UA945IR	1105708	UA945IR
1105022	UA945IR	1105330	UA925IR	1105567	UA945IR	1105710	UA939IR
1105023	UA945IR	1105332	UA925IR	1105570	UA936IR	1105711	UA939IR
1105025	UA945IR	1105333	UA925IR	1105571	UA936IR	1105715	UA939IR
1105029	UA945IR	1105335	UA925IR	1105572	UA955IR	1105718	UA953IR
1105033	UA943IR	1105339	UA925IR	1105573	UA943IR	1105720	UA953IR
1105034	UA945IR	1105342	UA925IR	1105574	UA943IR	1105722	UA938IR
1105036	UA945IR	1105343	UA925IR	1105576	UA945IR	1107194	US839
1105041	UA945IR	1105346	UA925IR	1105580	UA945IR	1107196	US869
1105043	UA943IR	1105347	UA925IR	1105581	UA955IR	1107203	US833
1105044	UA945IR	1105348	UA943IR	1105582	UA955IR	1107204	US839
1105045	UA945IR	1105351	UA943IR	1105584	UA943IR	1107205	US839
1105046	UA945IR	1105354	UA936IR	1105587	UA936IR	1107237	US818
1105047	UA945IR	1105356	UA936IR	1105588	UA945IR	1107242	US818
1105048	UA945IR	1105357	UA943IR	1105590	UA945IR	1107247	US818
1105049	UA945IR	1105360	UA943IR	1105591	UA945IR	1107248	US818
1105050	UA943IR	1105361	UA943IR	1105592	UA955IR	1107259	US818
1105058	UA945IR	1105362	UA943IR	1105594	UA945IR	1107260	US818
1105059	UA945IR	1105363	UA943IR	1105597	UA945IR	1107287	US839
1105060	UA945IR	1105365	UA943IR	1105599	UA945IR	1107293	US869
1105063	UA930IR	1105366	UA936IR	1105600	UA945IR	1107294	US869
1105066	UA943IR	1105371	UA945IR	1105602	UA955IR	1107295	US839
1105067	UA943IR	1105372	UA945IR	1105603	UA945IR	1107298	US869
1105068	UA943IR	1105415	UA925IR	1105604	UA955IR	1107299	US869
1105069	UA943IR	1105419	UA952IR	1105606	UA955IR	1107301	US818
1105070	UA943IR	1105420	UA943IR	1105607	UA945IR	1107302	US818
1105072	UA943IR	1105421	UA943IR	1105608	UA945IR	1107306	US818
1105073	UA943IR	1105422	UA943IR	1105610	UA945IR	1107308	US867
1105074	UA943IR	1105423	UA943IR	1105611	UA945IR	1107320	US818
1105075	UA945IR	1105424	UA943IR	1105612	UA940IR	1107330	US869
1105076	UA930IR	1105425	UA955IR	1105619	UA943IR	1107336	US818
1105078	UA943IR	1105426	UA945IR	1105620	UA945IR	1107355	US869
1105079	UA943IR	1105429	UA943IR	1105621	UA945IR	1107370	US818
1105080	UA943IR	1105433	UA925IR	1105623	UA945IR	1107373	US818
1105081	UA945IR	1105434	UA943IR	1105624	UA945IR	1107374	US818
1105082	UA945IR	1105441	UA955IR	1105627	UA945IR	1107377	US832
1105083	UA945IR	1105442	UA955IR	1105628	UA945IR	1107378	US832
1105084	UA945IR	1105443	UA955IR	1105629	UA955IR	1107391	US818
1105085	UA936IR	1105444	UA955IR	1105630	UA945IR	1107396	US869
1105091	UA945IR	1105445	UA955IR	1105632	UA943IR	1107399	US818
1105092	UA945IR	1105446	UA955IR	1105633	UA945IR	1107400	US818
1105098	UA943IR	1105447	UA955IR	1105635	UA945IR	1107496	US818
1105160	UA943IR	1105449	UA955IR	1105639	UA936IR	1107514	US843
1105161	UA943IR	1105451	UA936IR	1105645	UA943IR	1107539	US843
1105162	UA943IR	1105474	UA929IR	1105647	UA945IR	1107557	US835
1105163	UA943IR	1105475	UA929IR	1105648	UA955IR	1107582	US835
1105164	UA943IR	1105476	UA929IR	1105649	UA945IR	1107587	US825
1105165	UA943IR	1105479	UA936IR	1105650	UA945IR	1107588	US824
1105166	UA943IR	1105481	UA936IR	1105651	UA955IR	1107596	US818
1105167	UA943IR	1105492	UA955IR	1105652	UA945IR	1107652	US869
1105168	UA943IR	1105493	UA955IR	1105653	UA945IR	1107694	US855
1105169	UA943IR	1105495	UA955IR	1105654	UA955IR	1107709	US818
1105170	UA943IR	1105497	UA936IR	1105661	UA953IR	1107781	US877
1105171	UA943IR	1105506	UA955IR	1105662	UA940IR	1107863	US835
1105172	UA943IR	1105507	UA955IR	1105663	UA940IR	1107867	CS106
1105173	UA943IR	1105509	UA936IR	1105664	UA940IR	1108026	US869
1105174	UA943IR	1105510	UA952IR	1105665	UA940IR	1108197	US832
1105175	UA943IR	1105511	UA945IR	1105672	UA941IR	1108224	US869
1105176	UA943IR	1105512	UA925IR	1105673	UA945IR	1108225	US869
1105177	UA943IR	1105513	UA936IR	1105674	UA945IR	1108226	US869
1105178	UA943IR	1105514	UA943IR	1105675	UA945IR	1108331	US818
1105181	UA943IR	1105515	UA936IR	1105676	UA945IR	1108333	US869
1105182	UA945IR	1105516	UA945IR	1105677	UA941IR	1108335	US869
1105183	UA945IR	1105520	UA943IR	1105678	UA941IR	1108338	US877
1105185	UA943IR	1105521	UA945IR	1105681	UA936IR	1108348	US869
1105186	UA925IR	1105522	UA943IR	1105686	UA943IR	1108349	US869
1105188	UA943IR	1105523	UA945IR	1105688	UA953IR	1108351	US818
1105193	UA943IR	1105537	UA952IR	1105689	UA953IR	1108353	US869
1105195	UA943IR	1105543	UA955IR	1105691	UA945IR	1108361	US818
1105196	UA925IR	1105544	UA955IR	1105692	UA945IR	1108363	US818
1105197	UA925IR	1105547	UA955IR	1105694	UA1109IR	1108365	US818
1105198	UA925IR	1105549	UA936IR	1105697	UA942IR	1108366	US818
1105199	UA925IR	1105553	UA936IR	1105698	UA1109IR	1108367	US818
1105200	UA925IR	1105555	UA945IR	1105701	UA942IR	1108371	US818
1105243	UA925IR	1105556	UA943IR	1105703	UA945IR	1108375	US818
1105244	UA943IR	1105558	UA943IR	1105704	UA945IR	1108380	US818
1105245	UA945IR	1105559	UA943IR	1105705	UA945IR	1108383	US869
1105249	UA925IR	1105564	UA945IR	1105706	UA945IR	1108386	US869

O.E. NO.	HC-PARTS	O.E. NO.	HC-PARTS	O.E. NO.	HC-PARTS	O.E. NO.	HC-PARTS
1108387	US869	1109062	US877	1109788	US827	1113842	US811
1108389	US869	1109064	US877	1109789	US827	1113844	US811
1108391	US818	1109065	US877	1109791	US827	1113845	US811
1108400	US969	1109066	US877	1109794	US826	1113846	US811
1108419	US855	1109067	US877	1109798	US827	1113849	US811
1108421	US833	1109068	US877	1109831	US823	1113850	US811
1108422	US839	1109072	US869	1109832	US826	1113851	US811
1108423	US839	1109084	US855	1109838	US827	1113853	US823
1108427	US877	1109087	US867	1109839	US827	1113855	US811
1108428	US877	1109090	US832	1109840	US827	1113858	US811
1108429	US877	1109091	US832	1109841	US827	1113860	US811
1108430	US877	1109092	US855	1109842	US827	1113861	US811
1108434	US869	1109093	US833	1109845	US827	1113862	US811
1108435	US869	1109095	US839	1109846	US827	1113866	US811
1108436	US869	1109098	US838	1109960	US827	1113872	US811
1108439	US818	1109192	US843	1109961	US827	1113876	US811
1108445	US869	1109199	US815	1109965	US827	1113880	US811
1108446	US869	1109212	US809	1109972	US827	1113883	US811
1108448	US818	1109213	US809	1109973	US827	1113885	US811
1108477	US818	1109215	US809	1109977	US827	1113887	US811
1108479	US818	1109216	US809	1109978	US827	1113890	US811
1108480	US877	1109219	US828	1109979	US827	1113892	US811
1108481	US877	1109222	US827	1109986	US827	1113893	US811
1108495	US869	1109253	US843	1109987	US827	1113894	US811
1108496	US818	1109285	US827	1109989	US826	1113895	US811
1108498	US869	1109286	US827	1113256	US849	1113898	US811
1108500	US869	1109287	US827	1113267	US970	1113900	US811
1108501	US877	1109288	US827	1113270	US970	1113901	US823
1108502	US877	1109289	US827	1113273	US844	1113902	US811
1108503	US818	1109290	US827	1113275	US968	1113903	US811
1108505	US838	1109291	US827	1113276	US845	1113904	US823
1108506	US818	1109292	US827	1113277	US857	1113905	US811
1108508	US867	1109293	US827	1113278	US968	1113906	US811
1108512	US818	1109296	US827	1113281	US843	1113912	US811
1108513	US877	1109298	US823	1113282	US843	1113913	US811
1108516	US818	1109355	US855	1113285	US843	1113914	US811
1108517	US869	1109364	US818	1113288	US868	1113915	US811
1108519	US869	1109365	US818	1113296	US970	1113916	US811
1108521	US818	1109385	US827	1113510	US821	1113919	US823
1108597	US818	1109415	US818	1113517	US853	1113920	US811
1108692	US844	1109422	US867	1113518	US821	1113923	US823
1108694	US815	1109488	US969	1113519	US847	1113925	US823
1108696	US842	1109489	US969	1113521	US854	1113926	US811
1108745	US877	1109490	US969	1113552	US821	1113928	US823
1108746	US877	1109494	US827	1113553	US821	1113930	US823
1108747	US877	1109521	US830	1113559	US821	1113934	US823
1108748	US877	1109524	US830	1113577	US821	1113935	US811
1108755	US969	1109526	US810	1113578	US853	1113942	US823
1108756	US969	1109530	US810	1113579	US853	1113943	US823
1108758	US869	1109534	US830	1113589	US828	1113944	US811
1108759	US869	1109538	US810	1113594	US857	1113948	US811
1108762	US818	1109540	US868	1113598	US824	1113949	US823
1108765	US869	1109553	US827	1113652	US840	1113950	US823
1108766	US869	1109563	US828	1113683	US840	1113951	US811
1108770	US818	1109564	US810	1113706	US811	1113952	US811
1108774	US818	1109597	US818	1113707	US811	1113955	US811
1108776	US877	1109631	US827	1113708	US811	1113956	US811
1108777	US818	1109635	US826	1113709	US811	1113957	US811
1108778	US877	1109636	US827	1113710	US811	1113958	US811
1108779	US877	1109638	US827	1113713	US811	1113959	US823
1108780	US877	1109642	US827	1113741	US811	1113960	US823
1108781	US877	1109643	US827	1113745	US811	1113962	US823
1108782	US877	1109647	US827	1113778	US811	1113965	US811
1108790	US818	1109649	US827	1113781	US811	1113966	US811
1108795	US877	1109661	US827	1113783	US811	1113967	US823
1108796	US877	1109755	US827	1113800	US811	1113968	US811
1108797	US818	1109759	US827	1113814	US811	1113969	US823
1108798	US877	1109768	US827	1113815	US811	1113970	US811
1108857	US811	1109771	US827	1113818	US811	1113971	US811
1108918	US877	1109772	US827	1113820	US811	1113972	US811
1109022	US869	1109773	US827	1113823	US811	1113973	US811
1109025	US877	1109774	US827	1113824	US811	1113975	US811
1109026	US869	1109775	US827	1113825	US811	1113976	US811
1109036	US877	1109776	US827	1113827	US823	1113977	US811
1109038	US818	1109777	US827	1113828	US811	1113978	US811
1109052	US877	1109778	US827	1113831	US811	1113980	US811
1109056	US877	1109780	US827	1113834	US811	1113981	US811
1109057	US877	1109782	US827	1113835	US811	1113982	US823
1109061	US818	1109787	US827	1113840	US823	1113983	US811

O.E. NO.	HC-PARTS	O.E. NO.	HC-PARTS	O.E. NO.	HC-PARTS	O.E. NO.	HC-PARTS
REMY (DELCO)	<i>Continued</i>						
1113991	US823	1117253	UA1114IR	1990344	US864	1998339	US824
1113992	US823	1117258	UA1114IR	1990357	US863	1998342	US843
1113993	US823	1117259	UA1114IR	1990359	US863	1998347	US824
1113994	US811	1117615	UA948IR	1990360	US863	1998359	US843
1113995	US811	1117622	UA948IR	1990361	US864	1998363	US815
1113997	US811	1117640	UA948IR	1990364	US863	1998376	US843
1113998	US823	1117642	UA948IR	1990366	US863	1998389	US868
1113999	US811	1117643	UA948IR	1990367	US863	1998396	US818
1114109	US1025	1117644	UA948IR	1990368	US864	1998400	US877
1114114	US1025	1117645	UA948IR	1990373	US863	1998408	US845
1114129	US1025	1117647	UA948IR	1990378	US864	1998423	US845
1114138	US1025	1117648	UA946IR	1990382	US864	1998427	US858
1114141	US1025	1117650	UA948IR	1990383	US864	1998435	US877
1114152	US1025	1117655	UA948IR	1990384	US864	1998436	US877
1114156	US1025	1117836	UA946IR	1990388	US864	1998437	US877
1114158	US1025	1117880	UA1115IR	1990390	US864	1998438	US877
1114162	US1025	1117885	UA1115IR	1990402	US863	1998439	US877
1114167	US1025	1117886	UA1115IR	1990409	US864	1998440	US877
1114174	US1025	1117887	UA1115IR	1990410	US864	1998441	US877
1114175	US1025	1117890	UA1115IR	1990411	US864	1998442	US828
1114190	US1025	1117891	UA1115IR	1990412	US864	1998455	US824
1114704	US1025	1117892	UA1115IR	1990413	US863	1998456	US845
1114705	US1025	1117894	UA1115IR	1990414	US863	1998457	US845
1114706	US823	1117900	UA1620IR	1990416	US864	1998467	US877
1114708	US1025	1117912	UA1115IR	1990418	US864	1998490	US845
1114711	US823	1117931	UA1115IR	1990422	US864	1998514	US810
1114715	US811	1117942	UA1115IR	1990437	US864	1998516	US818
1114724	US1025	1117950	UA1115IR	1990453	US863	1998524	US858
1114728	US811	1117953	UA1115IR	1990455	US863	1998526	US810
1114737	US811	1117954	UA1115IR	1990456	US864	1998533	US810
1114748	US1025	1117955	UA1115IR	1990460	US864	1998544	US810
1114754	US1025	1117956	UA1115IR	1990474	US863	1998557	US818
1114762	US811	1117966	UA1115IR	1990485	US864	1998558	US877
1114791	US1025	1979857	UA945IR	1990491	US864	1998560	US877
1114802	US1025	1979858	UA945IR	1990493	US864	1998561	US877
1114824	US1025	1979859	UA945IR	1990497	US863	1998562	US877
1114826	US1025	1979860	UA943IR	1990703	US1025	1998564	US818
1114827	US1025	1979862	UA943IR	1990719	US859	1998566	US877
1114828	US1025	1979863	UA943IR	1990838	US864	1998568	US877
1114832	US1025	1979865	UA943IR	1993700	US811	1998570	US877
1114833	US1025	1979866	UA943IR	1993704	US823	1998574	US877
1114834	US1025	1979867	UA943IR	1993796	US863	1998576	US865
1114842	US811	1990202	US811	1993797	US863	1998577	US818
1114843	US823	1990204	US823	1993802	US864	1998579	US869
1114845	US823	1990219	US1025	1993804	US863	1998580	US969
1114846	US811	1990220	US1025	1993805	US864	1998583	US877
1114848	US811	1990221	US1025	1993808	US863	1998584	US877
1114849	US811	1990229	US827	1993810	US864	1998589	US877
1114850	US811	1990231	US827	1993814	US863	1998590	US877
1114851	US811	1990235	US827	1993815	US863	1998591	US818
1114854	US811	1990237	US827	1993842	US864	3182972	US647
1114856	US823	1990239	US827	1993881	JS931	3471141	CS87
1114872	US823	1990248	US827	1993945	US863	3471143	CS66
1114873	US811	1990249	US827	1993988	JS931	3471144	CS87
1114874	US811	1990250	US827	1998211	US877	3471150	CS162
1114875	US811	1990251	US827	1998213	US818	3471152	CS261
1114879	US811	1990259	US827	1998217	US877	3471153	CS261
1114880	US811	1990260	US827	1998222	US877	3471154	CS80
1114903	US811	1990262	US827	1998223	US877	3471155	CS263
1114905	US823	1990263	US827	1998226	US877	3471162	CS87
1114915	US811	1990264	US827	1998236	US818	3471163	CS66
1114916	US811	1990266	US827	1998238	US877	3471164	CS261
1114917	US823	1990268	US827	1998241	US877	3471165	CS80
1114923	US811	1990269	US827	1998242	US877	3471168	CS162
1114935	US811	1990270	US827	1998243	US877	3471168	CS162
1114951	US811	1990271	US827	1998244	US877	3471169	CS535
1114963	US811	1990272	US827	1998246	US877	3471170	CS518
1114964	US811	1990273	US827	1998247	US877	3471171	CS66
1114977	US1025	1990274	US827	1998260	US855	3471172	CS162
1117069	UA946IR	1990276	US827	1998261	US855	3471173	CS535
1117226	UA1114IR	1990281	US1025	1998266	US832	3471174	CS518
1117229	UA1114IR	1990282	US811	1998267	US832	3471176	CS80
1117236	UA1114IR	1990283	US823	1998271	US839	3471177	CS162
1117238	UA946IR	1990290	US1025	1998274	US838	3471214	CA508IR
1117239	UA1114IR	1990297	US823	1998281	US833	3471366	CS166
1117243	UA1114IR	1990304	US1025	1998317	US969	3471375	CS80
1117248	UA1114IR	1990324	US823	1998318	US969	3471377	CS263
1117249	UA946IR	1990325	US1025	1998336	US968	3471390	CS66
1117250	UA1114IR	1990343	US823	1998337	US835	3471391	CS87

O.E. NO.	HC-PARTS	O.E. NO.	HC-PARTS	O.E. NO.	HC-PARTS	O.E. NO.	HC-PARTS
3471392	CS80	3493409	CA1053IR	9000879	US1240	10478946	US864
3471393	CS162	3493454	CA1103IR	9000884	US1240	10478980	US864
3471394	CS263	3493455	CA1103IR	9000885	US1240	10478986	US864
3471850	CS518	3493459	CA1581IR	9000889	CS1291	10478998	US864
3472002	CA110IR	3493604	CA513IR	9000895	CS1258	10479097	UA1113IR
3472014	CA48IR	3493606	CA514IR	9000899	US1240	10479111	US864
3472018	CA42IR	3493619	CA264IR	9000902	CS1395	10479115	US863
3472022	CA99IR	3493620	CA352IR	9000910	US858	10479118	US863
3472023	CA128IR	3493621	CA517IR	9000934	CS1395	10479252	US864
3472024	CA99IR	3493634	CA570IR	9000936	CS1291	10479264	US863
3472026	CA128IR	3493635	CA198IR	9000952	CS1291	10479384	CA1053IR
3472027	CA110IR	3493639	CA513IR	9000965	CS1291	10479613	US860
3472028	CA110IR	3493641	CA516IR	9000967	CS1395	10479615	US845
3472032	CA48IR	3493704	CA892IR	10455006	US810	10479621	US845
3472033	CA42IR	3493706	CA647IR	10455010	US810	10479622	US857
3472035	CA48IR	3493714	CA513IR	10455011	US858	10479623	US857
3472037	CA128IR	3493715	CA892IR	10455013	US858	10479626	CS1381
3472038	CA99IR	3493716	CA514IR	10455016	US858	10479627	CS120
3472042	CA221IR	3493717	CA647IR	10455017	US810	10479806	UA965IR
3472048	CA128IR	3493719	CA264IR	10455019	US810	10479807	UA933IR
3472049	CA99IR	3493721	CA517IR	10455024	US810	10479814	UA938IR
3472050	CA508IR	3493734	CA570IR	10455025	US810	10479815	UA942IR
3472051	CA264IR	3493739	CA513IR	10455042	US858	10479816	UA947IR
3472052	CA507IR	3493741	CA516IR	10455048	US810	10479858	UA936IR
3472053	CA158IR	3493791	CA516IR	10455050	US858	10479874	UA953IR
3472057	CA110IR	3493814	CA1103IR	10455053	US810	10479895	UA1109IR
3472058	CA48IR	3493823	CA1053IR	10455054	US858	10479897	UA1113IR
3472059	CA128IR	3493824	CA1053IR	10455070	US858	10479901	UA964IR
3472060	CA42IR	3493824	CA1053IR	10455300	US818	10479902	UA938IR
3472061	CA99IR	3493847	CA861IR	10455301	US877	10479905	UA1109IR
3472062	CA221IR	3493848	CA861IR	10455304	US833	10479906	UA939IR
3472065	CA158IR	3493848	CA861IR	10455305	US877	10479909	UA938IR
3472066	CA264IR	3493855	CA1051IR	10455306	US877	10479910	UA938IR
3472067	CA507IR	3493914	CA1103IR	10455308	US877	10479911	UA938IR
3472068	CA508IR	3493955	CA1051IR	10455312	US855	10479912	UA939IR
3472069	CA509IR	4433162	UA951	10455332	US867	10479913	UA938IR
3472070	CA352IR	8000004	CA1833IR	10455340	US833	10479914	CA1103IR
3472082	CA353IR	8000032	CS1434	10455355	US833	10479916	UA947IR
3472091	CA198IR	8000048	CS1438	10455503	CS1210	10479920	UA965IR
3472093	CA221IR	8000174	JS1311	10455506	CS1183	10479923	CA1053IR
3472104	CA99IR	8000180	CS1395	10455603	US877	10479930	UA925IR
3472105	CA514IR	8000193	CS1258	10461024	US864	10479947	CA861IR
3472106	CA514IR	8000321	CS1291	10461025	US863	10479954	UA964IR
3472119	CA548IR	8200138	CS1381	10461030	US864	10479955	CA1051IR
3472120	CA517IR	8200519	CS1463	10461031	US863	10479962	UA964IR
3472121	CA517IR	8400156	CA2017IR	10461039	JS931	10479963	UA942IR
3472130	CA509IR	8400157	CA2010IR	10461043	US864	10479974	UA938IR
3472134	CA570IR	8400159	CA2010IR	10461054	US864	10479990	CA1386IR
3472135	CA198IR	8400218	CA2017IR	10461068	US864	10479991	UA967IR
3472139	CA513IR	8400219	CA2010IR	10461470	CS1381	10479993	UA939IR
3472142	CA701IR	9000700	CS535	10463007	UA958IR	10479998	UA938IR
3472143	CA701IR	9000719	US859	10463011	UA937IR	10479999	CA1386IR
3472144	CA615IR	9000735	US859	10463012	UA937IR	10480000	CA1396IR
3472170	CA524IR	9000751	CS535	10463013	UA938IR	10480017	UA967IR
3472188	CA352IR	9000756	CS535	10463014	UA938IR	10480027	UA964IR
3472202	CA42IR	9000758	CS535	10463015	UA937IR	10480028	UA939IR
3472204	CA99IR	9000762	US859	10463016	UA938IR	10480035	UA1112IR
3472206	CA158IR	9000768	US859	10463017	UA938IR	10480036	UA938IR
3472208	CA264IR	9000772	CS535	10463043	UA942IR	10480037	UA1113IR
3472210	CA221IR	9000785	CS535	10463097	UA953IR	10480040	UA964IR
3472220	CA158IR	9000786	US1029	10463118	UA947IR	10480052	UA1111IR
3472272	CA110IR	9000791	CS535	10463172	UA939IR	10480055	UA939IR
3472275	CA48IR	9000794	CS519	10463176	UA1113IR	10480058	UA943IR
3472641	CA516IR	9000794	CS727	10463187	UA1109IR	10480068	UA938IR
3472706	CA514IR	9000794	CS879	10463197	UA1109IR	10480071	UA1110IR
3493119	CA548IR	9000795	CS519	10463651	UA1538IR	10480072	UA967IR
3493204	CA99IR	9000795	CS879	10463940	UA1538IR	10480073	CA1396IR
3493219	CA548IR	9000802	CS535	10465001	US859	10480082	UA939IR
3493220	CA517IR	9000817	CS727	10465009	US859	10480085	UA937IR
3493225	CA1581IR	9000819	US1240	10465016	UA947IR	10480086	UA939IR
3493226	CA1561IR	9000820	CS1258	10465018	US810	10480087	UA939IR
3493230	CA509IR	9000821	US1240	10465045	US968	10480088	UA958IR
3493234	CA570IR	9000822	CS1258	10465046	US968	10480090	UA953IR
3493235	CA198IR	9000824	CS727	10465054	US970	10480092	UA953IR
3493239	CA513IR	9000835	CS1291	10465058	US844	10480093	UA953IR
3493242	CA701IR	9000839	US1240	10465065	US858	10480095	JA987IR
3493243	CA701IR	9000841	US1029	10478864	US823	10480096	JA987IR
3493244	CA615IR	9000850	CS1258	10478912	US827	10480097	UA939IR
3493273	CA1473IR	9000860	US1029	10478943	US864	10480099	UA939IR

O.E. NO.	HC-PARTS	O.E. NO.	HC-PARTS	O.E. NO.	HC-PARTS	O.E. NO.	HC-PARTS
REMY (DELCO)	<i>Continued</i>						
10480104	UA9391R	96208782	CS727	DRA0091	CA19561R	DRA0215	CA20061R
10480105	UA9381R	96208782	CS879	DRA0092	CA19871R	DRA0216	CA19491R
10480114	UA9381R	96208783	CS519	DRA0095	JA15331R	DRA0218	CA19941R
10480119	UA11101R	96208783	CS727	DRA0098	CA19411R	DRA0219	CA19261R
10480127	UA9641R	96208783	CS879	DRA0099	JA15281R	DRA0220	CA70
10480134	UA9381R	96208785	CS519	DRA0101	CA18361R	DRA0221	CA19381R
10480136	UA11091R	96208785	CS727	DRA0102	CA18751R	DRA0221N	CA19381R
10480137	UA11091R	96208785	CS879	DRA0103	CA17671R	DRA0225	CA19271R
10480167	UA15381R	96224431	CA13851R	DRA0103N	CA17671R	DRA0226	CA20911R *
10480168	UA15381R	96224431	CA13851R	DRA0104	CA18761R	DRA0229	CA20671R *
10480187	UA9671R	96224432	CA13861R	DRA0105	CA17411R	DRA0231	CA20821R *
10480189	UA9671R	96252115	CA17451R	DRA0109	JA1902	DRA0238	CA19981R
10480190	UA9671R	96252547	CA13961R	DRA0110	CA7341R	DRA0240	CA50
10480198	UA15381R	96252551	CA13851R	DRA0111	CA18531R	DRA0242	CA19971R
10480214	CA12531R	96252551	CA13851R	DRA0113	CA17421R	DRA0243	CA20181R
10480215	CA12531R	96275481	CS1210	DRA0114	JA18051R	DRA0247	CA19351R
10480222	CA10531R	96380673	JA16001R	DRA0115	JA18961R	DRA0248	CA19781R
10480223	CA13141R	96380673	JA16001R	DRA0116	JA1705	DRA0249	CA16691R
10480225	CA15811R	96450663	CS879	DRA0117	JA18081R	DRA0249	CA16701R
10480226	CA11031R	96550792	CS519	DRA0118	JA17241R	DRA0250	CA89
10480237	UA11101R	96569440	CS1210	DRA0119	CA18641R	DRA0251	CA19821R
10480254	UA15381R	96627034	CS1431	DRA0120	CA771R	DRA0253	CA14751R
10480273	CA14731R	96843574	CS1431	DRA0121	JA18911R	DRA0264	CA10851R
10480308	UA15381R	17610-Q1010	JS517	DRA0122	JA18001R	DRA0265	UA9201R
10480353	UA11101R	CER3087	CS977	DRA0123	CA18691R	DRA0267	UA9211R
10480384	CA10531R	DRA0002	CA147	DRA0124	CA19111R	DRA0276	CA19541R
10490000	CA13961R	DRA0005	CA19531R	DRA0130	CA761R	DRA0278	JA15351R
10490073	CA13961R	DRA0006	CA18141R	DRA0131	CA18321R	DRA0279	JA1706
10496873	US877	DRA0007	CA17661R	DRA0132	CA13251R	DRA0280	CA42
10496874	US877	DRA0007N	CA17661R	DRA0133	CA18861R	DRA0281	JA12861R
10497122	UA9411R	DRA0008	CA19741R	DRA0135	CA16641R	DRA0282	JA13631R
10497145	UA9411R	DRA0009	CA17561R	DRA0137	CA18681R	DRA0283	CA20011R
10663530	UA9381R	DRA0011	JA18931R	DRA0138	CA19051R	DRA0284	JA17961R
18000004	CA18331R	DRA0013	JA18921R	DRA0140	CA6161R	DRA0287	CA20251R
18000005	CA18821R	DRA0014	JA17981R	DRA0141	CA20591R *	DRA0287N	CA20251R
19010111	UA16201R	DRA0015	CA19151R	DRA0142	CA19201R	DRA0288	CA14751R
19010182	UA16201R	DRA0016	JA13711R	DRA0143	JA18971R	DRA0289	CA18851R
19010185	UA16201R	DRA0017	JA17271R	DRA0144	CA19371R	DRA0291	CA18481R
19010193	UA16201R	DRA0021	CA17551R	DRA0145	CA19831R	DRA0292	CA19751R
19010195	UA16201R	DRA0023	CA16381R	DRA0146	CA19521R	DRA0293	CA19331R
19011501	CS1463	DRA0023N	CA16381R	DRA0148	JA18951R	DRA0295	CA17701R
19020376	UA16201R	DRA0024	CA18571R	DRA0150	CA62	DRA0298	CA19241R
19020382	UA16201R	DRA0024N	CA18571R	DRA0152	CA19651R *	DRA0299	CA16251R
19020391	UA16201R	DRA0033	CA17381R	DRA0153	CA19801R *	DRA0303	CA15441R
19024010	CS191	DRA0035	JA16061R	DRA0154	CA19431R *	DRA0306	CA20351R
19024016	CS506	DRA0036	CA19951R	DRA0155	JA17261R	DRA0307	CA19141R
19024018	CS502	DRA0037	CA19401R	DRA0156	JA17851R	DRA0308	CA18881R
19024040	CS1034	DRA0039	CA19131R	DRA0157	CA2021 *	DRA0311	CA20411R
19024048	CS699	DRA0040	CG17	DRA0162	CA19531R	DRA0312	CA20071R
19024049	CS617	DRA0041	CA16431R	DRA0163	CA138	DRA0314	CA19861R
19024051	CS198	DRA0044	CA11981R	DRA0164	CA292	DRA0315	CA19921R
19024053	CS526	DRA0045	CA18531R	DRA0166	CA15871R	DRA0317	CA19731R
19024076	CS881	DRA0048	CA18291R	DRA0167	CA13031R	DRA0319	JA16001R
19024077	CS881	DRA0049	CA16221R	DRA0169	JA1898	DRA0320	CA134
19024080	CS688	DRA0050	CG19	DRA0170	CA37	DRA0321	CA17611R
19024085	CS962	DRA0052	CA19671R	DRA0171	CA20221R	DRA0322	CA19931R
19024109	CS1178	DRA0054	CA20441R *	DRA0172	JA17201R	DRA0324	JA17041R
19024196	CS1463	DRA0055	CA19231R	DRA0173	JA1799	DRA0325	JA15221R
19024204	CS120	DRA0057	CA19681R	DRA0177	CA20341R	DRA0335	JA15971R
19024205	CS186	DRA0058	CA20001R	DRA0177N	CA20341R	DRA0339	CA19591R
19024225	CS120	DRA0061	JA18071R	DRA0178	CA17771R	DRA0343	JA16031R
19024234	CS530	DRA0061N	JA18071R	DRA0181	CA15891R	DRA0345	JA7871R
19024252	CS103	DRA0062	CA19251R	DRA0182	JA19011R	DRA0350	CA283
19024256	CS394	DRA0067	CA18791R	DRA0183	CA19461R	DRA0353	CA20111R
19024258	CS120	DRA0069	CA16501R	DRA0190	CA118	DRA0355	CA19061R
19024261	CS1123	DRA0071	CG52	DRA0191	CA16741R	DRA0361	CA18871R
19024264	CS269	DRA0072	CG58	DRA0195	CA1972	DRA0365	CA2014
19024272	CS240	DRA0073	JA17831R	DRA0197	CA19961R	DRA0366	CA20841R *
19024280	CS608	DRA0074	JA18041R	DRA0198	CA20381R	DRA0367	CA19851R
19025100	CA10351R	DRA0075	JA18041R	DRA0201	CA19121R	DRA0368	CA19691R
19025101	CA14381R	DRA0076	JA17841R	DRA0202	CA19101R	DRA0374	CA16651R
19025113	CA15931R	DRA0077	CA16281R	DRA0204	CA20551R	DRA0376	CA20621R *
19025330	CA12361R	DRA0078	CA16751R	DRA0205	CA18791R	DRA0381	CA19711R
19025333	CA12371R	DRA0079	JA17881R	DRA0206	CA19631R	DRA0382	JA15301R
19025339	CA16241R	DRA0082	CA20811R *	DRA0207	CA19341R	DRA0386	JA16151R
19070032	CS1274	DRA0084	CA19991R	DRA0208	CA20521R	DRA0387	CA20771R *
19070039	CS1381	DRA0086	CA19311R	DRA0210	CA183	DRA0389	CA17341R
96208781	CS1183	DRA0087	CA19891R	DRA0213	CA19701R	DRA0390	CA184
96208782	CS519	DRA0089	CA19551R	DRA0214	CA20061R	DRA0391	CA19661R *



O.E. NO.	HC-PARTS	O.E. NO.	HC-PARTS	O.E. NO.	HC-PARTS	O.E. NO.	HC-PARTS
DRA0394	CA1957IR	DRA1080	CA69IR	DRA2261	CA174IR	DRA3053	JA189IR
DRA0399	CA1845IR	DRA1090	CA300IR	DRA2301	CA356IR	DRA3055	JA142IR
DRA0400	CA184	DRA1110	CA85IR	DRA2311	CA224IR	DRA3056	JA141IR
DRA0401	CA2003IR	DRA1120	CA93IR	DRA2321	CA268IR	DRA3057	JA196
DRA0402	CA1842IR	DRA1150	CA125IR	DRA2341	CA307IR	DRA3058	JA149
DRA0403	CA1939IR	DRA1160	CA189IR	DRA2341N	CA307IR	DRA3059	JA161IR
DRA0411	CA1964IR	DRA1190	CA132IR	DRA2361	CA229IR	DRA3059	JA167IR
DRA0416	CA2047IR	DRA1200	CA191IR	DRA2381	JA130	DRA3063	CA1028IR
DRA0417	JA1903IR	DRA1210	CA124IR	DRA2391	JA131	DRA3064	JA193
DRA0430	CA75	DRA1230	CA334IR	DRA2401	JA130	DRA3064N	JA777
DRA0437	CA2045IR	DRA1240	CA192IR	DRA2411	JA131	DRA3065	CA169IR
DRA0480	CA88	DRA1250	CA130IR	DRA2421	JA131	DRA3068	CA510IR
DRA0484	CA2046IR *	DRA1251	CA155IR	DRA2431	JA100	DRA3069	CA315IR
DRA0500	CA273	DRA1262	CA341IR	DRA2441	JA103	DRA3070	CA603IR
DRA0510	CA328IR	DRA1270	CA339IR	DRA2451	JA121	DRA3073	CA332IR
DRA0520	CA333IR	DRA1280	CA511IR	DRA2471	JA120	DRA3074	CA229IR
DRA0536	CA2049IR *	DRA1290	CA152IR	DRA2481	JA110	DRA3075	CA643IR
DRA0540	CA163IR	DRA1300	CA186IR	DRA2491	JA157	DRA3076	CA526IR
DRA0542	CA244IR	DRA1310	CA187IR	DRA2511	JA172	DRA3078	CA534IR
DRA0550	CA271IR	DRA1320	CA368IR	DRA2541	JA103	DRA3079	CA831IR
DRA0560	CA225IR	DRA1330	CA340IR	DRA2571	JA131	DRA3083	CA574IR
DRA0560	CA325IR	DRA1340	CA212IR	DRA2581	JA137	DRA3084	CA711IR
DRA0562	CA2026IR *	DRA1350	CA96IR	DRA2591	JA137	DRA3085	CA165IR
DRA0570	CA284IR	DRA1360	CA207IR	DRA2601	JA150IR	DRA3086	CA549IR
DRA0580	CA141IR	DRA1370	CA327IR	DRA2611	JA151IR	DRA3087	CA612IR
DRA0590	CA52IR	DRA1371	CA84	DRA2621	JA884IR	DRA3089	CA584IR
DRA0591	CA2095IR *	DRA1380	CA61IR	DRA2631	JA152IR	DRA3090	CA502IR
DRA0597	CA2030IR	DRA1390	CA235IR	DRA2641	JA795IR	DRA3096	JA691IR
DRA0600	CA246IR	DRA1410	CA119IR	DRA2651	JA104IR	DRA3097	JA778IR
DRA0600	CA52IR	DRA1420	CA287IR	DRA2661	JA158IR	DRA3098	JA575IR
DRA0610	CA136IR	DRA1430	CA87IR	DRA2671	JA198IR	DRA3099	JA565IR
DRA0618	CA2102IR *	DRA1440	CA195IR	DRA2681	JA104IR	DRA3100	CA240IR
DRA0620	CA139IR	DRA1440	CA634IR	DRA2681	JA109IR	DRA3103	JA577IR
DRA0670	CA199IR	DRA1450	CA222IR	DRA2691	JA138	DRA3104	JA598IR
DRA0690	CA196IR	DRA1460	CA228IR	DRA2710	CA366IR	DRA3105	CA579IR
DRA0700	CA121IR	DRA1470	CA706IR	DRA2720	CA227IR	DRA3106	CA524IR
DRA0710	CA125IR	DRA1480	CA367IR	DRA2721	CA749IR	DRA3107	CA605IR
DRA0730	CA88IR	DRA1500	CA237IR	DRA2730	CA320IR	DRA3108	CA580IR
DRA0740	CA136IR	DRA1520	CA140IR	DRA2741	CA288IR	DRA3109	CA581IR
DRA0750	CA139IR	DRA1520	CA367IR	DRA2781	CA131IR	DRA3110	CA328IR
DRA0760	CA226IR	DRA1530	CA140IR	DRA2790	CA294IR	DRA3113	JA554IR
DRA0770	CA60IR	DRA1540	CA205IR	DRA2793	CA380IR	DRA3114	JA771IR
DRA0780	CA94IR	DRA1550	CA236IR	DRA2794	CA583IR	DRA3115	JA752IR
DRA0790	CA126IR	DRA1641	CA165IR	DRA2800	CA87IR	DRA3116	JA166IR
DRA0798	CA2086IR *	DRA1670	CA84IR	DRA2860	CA592IR	DRA3117	JA753IR
DRA0800	CA259IR	DRA1671	CA84IR	DRA2930	CA238IR	DRA3118	JA555IR
DRA0810	CA110IR	DRA1672	CA84IR	DRA2940	CA238IR	DRA3119	JA188IR
DRA0830	CA42IR	DRA1680	CA17H	DRA2950	CA528IR	DRA3120	CA251IR
DRA0840	CA221IR	DRA1680	CA17V	DRA2960	CA358IR	DRA3123	JA751IR
DRA0843	CA570IR	DRA1680	CA259IR	DRA2980	CA272IR	DRA3124	JA187IR
DRA0850	CA48IR	DRA1680	CA60IR	DRA3013	CA22H	DRA3124N	JA187IR
DRA0854	CA2098IR *	DRA1691	CA17H	DRA3015	CA126IR	DRA3125	CA587IR
DRA0870	CA128IR	DRA1711	CA169IR	DRA3015	CA18H	DRA3126	CA556IR
DRA0880	CA99IR	DRA1721	CA81IR	DRA3017	JA153	DRA3127	JA785IR
DRA0882	CA513IR	DRA1741	CA149IR	DRA3018	JA177IR	DRA3128	JA864IR
DRA0900	CA507IR	DRA1791	CA71	DRA3019	JA170	DRA3129	CA635IR
DRA0910	CA158IR	DRA1831	CA170IR	DRA3023	JA113IR	DRA3133	CA606IR
DRA0920	CA508IR	DRA1841	CA344	DRA3025	JA129IR	DRA3134	CA640IR
DRA0923	CA701IR	DRA1871	CA164	DRA3026	JA191IR	DRA3135	CA535IR
DRA0930	CA264IR	DRA1911	CA174IR	DRA3027	JA173IR	DRA3136	CA643IR
DRA0933	CA548IR	DRA1931	CA112	DRA3028	JA179IR	DRA3137	CA535IR
DRA0940	CA127IR	DRA1932	CA112	DRA3029	JA559IR	DRA3138	JA195
DRA0970	CA316IR	DRA1932	CA115	DRA3030	CA272IR	DRA3139	JA190
DRA0970	CA355IR	DRA1941	CA114	DRA3033	JA146IR	DRA3140	CA263IR
DRA0980	CA129IR	DRA1941	CA148	DRA3034	JA159IR	DRA3143	JA689IR
DRA0980	CA1435IR	DRA2011	CA148	DRA3035	JA148IR	DRA3144	JA879IR
DRA0990	CA150IR	DRA2041	CA233IR	DRA3037	JA693IR	DRA3145	JA671IR
DRA0992	CA331IR	DRA2061	CA173IR	DRA3038	JA585IR	DRA3145N	JA671IR
DRA0993	CA374IR	DRA2071	CA178IR	DRA3038N	JA585IR	DRA3146	JA664IR
DRA0994	CA331IR	DRA2074	CA2010IR	DRA3040	CA591IR	DRA3148	JA690IR
DRA0995	CA308IR	DRA2074N	CA2010IR	DRA3043	JA181IR	DRA3149	JA683IR
DRA1000	CA291IR	DRA2075	CA2017IR	DRA3044	JA164IR	DRA3153	JA661IR
DRA1001	CA176IR	DRA2075N	CA2017IR	DRA3045	JA183IR	DRA3154	JA697IR
DRA1002	CA178IR	DRA2081	CA172IR	DRA3045	JA779IR	DRA3156	JA697IR
DRA1002	CA291IR	DRA2101	CA120	DRA3046	JA182IR	DRA3157	JA546IR
DRA1040	CA52IR	DRA2121	CA131	DRA3046N	JA182IR	DRA3159	JA681
DRA1050	CA190IR	DRA2151	CA46IR	DRA3047	JA163IR	DRA3160	CA320IR
DRA1060	CA35IR	DRA2211	CA104	DRA3048	JA651	DRA3163	JA862IR
DRA1070	CA121IR	DRA2241	CA175IR	DRA3049	JA194IR	DRA3164	JA543IR

O.E. NO.	HC-PARTS	O.E. NO.	HC-PARTS	O.E. NO.	HC-PARTS	O.E. NO.	HC-PARTS
REMY (DELCO)	<i>Continued</i>						
DRA3165	JA862IR	DRA3258	CA815IR	DRA3348	JA880IR	DRA3443	JA872
DRA3165N	JA862IR	DRA3259	CA1225IR	DRA3349	CA822IR	DRA3444	JA655IR
DRA3166	JA694IR	DRA3260	CA276IR	DRA3350	CA139IR	DRA3444N	JA655IR
DRA3167	JA699IR	DRA3260	CA357IR	DRA3353	CA890IR	DRA3445	CA915IR
DRA3168	JA668IR	DRA3263	CA818IR	DRA3354	CA641IR	DRA3447	JA1276IR
DRA3169	JA755IR	DRA3264	CA1251IR	DRA3355	CA642IR	DRA3447N	JA1276IR
DRA3173	JA806IR	DRA3265	CA889IR	DRA3356	CA634IR	DRA3448	JA1537IR
DRA3174	JA576IR	DRA3266	CA732IR	DRA3357	CA896IR	DRA3449	JA792IR
DRA3175	JA876IR	DRA3267	CA733IR	DRA3358	CA1036IR	DRA3453	JA971IR
DRA3176	JA877IR	DRA3268	CA740IR	DRA3359	CA913IR	DRA3454	CA1472IR
DRA3177	JA804IR	DRA3269	CA736IR	DRA3363	CA914IR	DRA3455	CA1189IR
DRA3178	JA1177IR	DRA3270	CA277IR	DRA3364	CA716IR	DRA3456	CA1311IR
DRA3180	CA242IR	DRA3273	CA848IR	DRA3366	CA741	DRA3457	CA628IR
DRA3183	JA793IR	DRA3274	CA717IR	DRA3367	CA1030IR	DRA3458	CA613IR
DRA3184	JA666IR	DRA3275	JA673IR	DRA3367	CA718IR	DRA3459	CA704IR
DRA3184N	JA666IR	DRA3275N	JA673IR	DRA3368	CA611IR	DRA3461	JA131
DRA3185	JA684IR	DRA3276	JA878IR	DRA3369	CA1031IR	DRA3463	CA23V
DRA3186	JA654IR	DRA3276N	JA878IR	DRA3369	CA719IR	DRA3464	CA600IR
DRA3186N	JA654IR	DRA3278	JA959IR	DRA3374	CA1034IR	DRA3465	JA1126IR
DRA3187	JA685IR	DRA3279	JA769IR	DRA3374N	CA1034IR	DRA3465N	JA1126IR
DRA3188	JA870IR	DRA3279N	JA769IR	DRA3375	JA1133IR	DRA3466	CA1136IR
DRA3189	JA972IR	DRA3280	CA321IR	DRA3375N	JA1133IR	DRA3467	JA865IR
DRA3190	CA141IR	DRA3283	CA596IR	DRA3375N	JA1187IR	DRA3468	JA663IR
DRA3193	JA670IR	DRA3284	CA601IR	DRA3376	JA761IR	DRA3469	JA1179IR
DRA3194	JA674IR	DRA3285	CA1095IR	DRA3376N	JA761IR	DRA3469N	JA1179IR
DRA3194N	JA674IR	DRA3286	CA627IR	DRA3377	JA983IR	DRA3471	JA197IR
DRA3195	JA974IR	DRA3287	CA582IR	DRA3377N	JA983IR	DRA3473	JA1375IR
DRA3196	JA658IR	DRA3288	CA623IR	DRA3378	JA1360IR	DRA3473N	JA1375IR
DRA3197	JA659IR	DRA3289	CA725IR	DRA3379	CA1075IR	DRA3474	JA1271IR
DRA3198	JA767IR	DRA3293	CA629IR	DRA3383	CA1238IR	DRA3474N	JA1271IR
DRA3199	JA756IR	DRA3294	CA564IR	DRA3384	CA836IR	DRA3475	JA975IR
DRA3203	JA762IR	DRA3295	CA731IR	DRA3385	CA1086IR	DRA3476	JA886IR
DRA3204	JA1122IR	DRA3296	JA863IR	DRA3386	JA796IR	DRA3477	JA887IR
DRA3205	JA186IR	DRA3296N	JA863IR	DRA3387	JA866IR	DRA3478	JA1421IR
DRA3205N	JA186IR	DRA3297	JA874IR	DRA3388	JA978IR	DRA3478	JA867IR
DRA3206	JA662IR	DRA3298	JA871IR	DRA3389	JA979IR	DRA3478N	JA867IR
DRA3208	JA660IR	DRA3298N	JA871IR	DRA3393	JA764IR	DRA3479	CA1053IR
DRA3208N	JA660IR	DRA3299	JA763IR	DRA3394	CA1160IR	DRA3479N	CA1053IR
DRA3209	JA677IR	DRA3303	JA759IR	DRA3395	CA1158IR	DRA3483	JA873IR
DRA3209N	JA677IR	DRA3304	JA760IR	DRA3396	CA1313IR	DRA3483N	JA873IR
DRA3213	JA162IR	DRA3305	JA697IR	DRA3397	CA1220IR	DRA3484	JA757IR
DRA3214	JA669IR	DRA3306	JA599IR	DRA3398	CA1221IR	DRA3484N	JA757IR
DRA3215	JA185IR	DRA3307	JA178IR	DRA3399	CA1190IR	DRA3485	CA1077IR
DRA3215N	JA185IR	DRA3308	JA154IR	DRA3403	CA1216IR	DRA3486	CA1077IR
DRA3216	JA678IR	DRA3309	JA667IR	DRA3404	CA1222IR	DRA3487	CA1078IR
DRA3216N	JA678IR	DRA3313	JA770IR	DRA3405	CA1218IR	DRA3488	CA1200IR
DRA3217	JA171IR	DRA3314	JA147IR	DRA3406	CA1084IR	DRA3489	CA1250IR
DRA3218	JA652IR	DRA3314N	JA147IR	DRA3407	CA1161IR	DRA3493	CA720IR
DRA3219	JA698IR	DRA3315	JA766IR	DRA3408	CA851IR	DRA3494	CA850IR
DRA3220	CA96IR	DRA3316	JA775IR	DRA3408N	CA572IR	DRA3495	JA774IR
DRA3223	JA695IR	DRA3316N	JA775IR	DRA3408N	CA851IR	DRA3496	JA869IR
DRA3224	JA143	DRA3317	JA165IR	DRA3409	CA572IR	DRA3497	JA802IR
DRA3225	JA552IR	DRA3318	JA184IR	DRA3409N	CA572IR	DRA3498	JA981IR
DRA3226	JA571IR	DRA3319	JA779IR	DRA3413	CA1196IR	DRA3499	JA1164IR
DRA3228	JA656	DRA3320	CA522IR	DRA3414	CA1153IR	DRA3503	JA976IR
DRA3229	JA868IR	DRA3323	JA765IR	DRA3415	CA1154IR	DRA3504	JA881IR
DRA3233	CA729IR	DRA3323N	JA765IR	DRA3416	CA1084IR	DRA3505	JA799IR
DRA3234	CA638IR	DRA3324	JA758IR	DRA3417	CA727IR	DRA3505N	JA799IR
DRA3235	CA639IR	DRA3325	JA768IR	DRA3418	CA851IR	DRA3506	JA1178IR
DRA3236	CA637IR	DRA3326	JA665IR	DRA3419	CA834IR	DRA3507	JA1274IR
DRA3237	CA648IR	DRA3327	JA781IR	DRA3421	JA139	DRA3508	JA988IR
DRA3238	CA617IR	DRA3328	JA782IR	DRA3423	CA1039IR	DRA3509	JA885IR
DRA3239	CA715IR	DRA3329	JA776IR	DRA3424	CA1565IR	DRA3514	JA1165IR
DRA3243	CA618IR	DRA3330	CA341IR	DRA3425	JA801IR	DRA3515	JA1369IR
DRA3244	CA820IR	DRA3333	JA773IR	DRA3426	JA180IR	DRA3517	JA1534IR
DRA3245	CA730IR	DRA3334	JA672IR	DRA3427	CA650IR	DRA3518	JA777
DRA3246	CA838IR	DRA3334N	JA672IR	DRA3428	CA1083IR	DRA3518N	JA777
DRA3246N	CA375IR	DRA3335	JA754IR	DRA3429	CA717IR	DRA3519	JA970IR
DRA3246N	CA838IR	DRA3336	JA682IR	DRA3433	CA891IR	DRA3519N	JA970IR
DRA3247	CA632IR	DRA3337	JA798IR	DRA3433N	CA1379IR	DRA3523	CA900IR
DRA3248	CA633IR	DRA3338	JA786	DRA3433N	CA891IR	DRA3524	CA622IR
DRA3249	CA634IR	DRA3339	JA783IR	DRA3434	CA707IR	DRA3525	CA905IR
DRA3250	CA252IR	DRA3340	CA246IR	DRA3435	CA290IR	DRA3526	CA899IR
DRA3250N	CA252IR	DRA3343	JA687	DRA3436	JA980IR	DRA3527	CA1049IR
DRA3253	CA607IR	DRA3344	JA553IR	DRA3437	JA772IR	DRA3528	CA1096IR
DRA3254	CA816IR	DRA3345	JA676	DRA3438	JA879IR	DRA3529	CA636IR
DRA3255	CA819IR	DRA3346	JA750IR	DRA3439	JA994IR	DRA3533	CA1055IR
DRA3256	CA821IR	DRA3346N	JA750IR	DRA3439N	JA994IR	DRA3534	CA1061IR
DRA3257	CA817IR	DRA3347	CA845IR	DRA3441	JA107IR	DRA3535	CA892IR

O.E. NO.	HC-PARTS	O.E. NO.	HC-PARTS	O.E. NO.	HC-PARTS	O.E. NO.	HC-PARTS
DRA3536	CA1217IR	DRA3685	JA1277IR	DRA3787	CA1651IR	DRA3890	CA129IR
DRA3537	CA647IR	DRA3686	CA1081IR	DRA3788	UA960	DRA3893	JA1368IR
DRA3538	CA1080IR	DRA3687	JA1181IR	DRA3789	JA1370IR	DRA3894	JA1361IR
DRA3539	CA896IR	DRA3688	JA1279IR	DRA3789N	JA1370IR	DRA3895	JA1292IR
DRA3540	CA341IR	DRA3689	JA1167IR	DRA3794	JA1521IR	DRA3896	JA1287IR
DRA3543	CA1036IR	DRA3693	JA1173IR	DRA3794N	JA1521IR	DRA3897	JA662IR
DRA3544	JA883IR	DRA3694	JA1185IR	DRA3797	CA1326IR	DRA3898	JA115IR
DRA3545	JA1172IR	DRA3695	JA1184IR	DRA3798	CA2074IR *	DRA3899	JA688IR
DRA3545N	JA1172IR	DRA3696	JA1180IR	DRA3799N	JA1723IR	DRA3900	CA310IR
DRA3546	CA18V	DRA3697	JA1182IR	DRA3803	CA1344IR	DRA3903	CA1581IR
DRA3548	CA18V	DRA3698	JA1162IR	DRA3804	CA1053IR	DRA3903N	CA1581IR
DRA3549	CA1387IR	DRA3698N	JA1162IR	DRA3805	CA1567IR	DRA3904	CA1473IR
DRA3550	CA823IR	DRA3699	JA1275IR	DRA3806	CA1512IR	DRA3904N	CA1473IR
DRA3553	CA1050IR	DRA3703	CA1051IR	DRA3806N	CA1512IR	DRA3905	JA1526IR
DRA3555	CA233IR	DRA3703N	CA1051IR	DRA3807	CA1578IR	DRA3905N	JA1526IR
DRA3556	CA15H	DRA3704	CA1103IR	DRA3808	CA1756IR	DRA3906	CA1499IR
DRA3557	CA1101IR	DRA3704N	CA1103IR	DRA3809	CA1559IR	DRA3906N	CA1499IR
DRA3558	CA1224IR	DRA3705	CA1329IR	DRA3814	CA1497IR	DRA3907	CA1589IR
DRA3563	CA18V	DRA3706	CA1422IR	DRA3815	CA1640IR	DRA3907N	CA1589IR
DRA3564	CA17V	DRA3707	CA1496IR	DRA3816	CA1641IR	DRA3908	CA832IR
DRA3569	CA626IR	DRA3708	CA813IR	DRA3817	CA1334IR	DRA3909	CA835IR
DRA3573	JA1272IR	DRA3709	CA814IR	DRA3818	CA1388IR	DRA3910	CA567IR
DRA3576	CG50	DRA3714	CA1298IR	DRA3819	CA1312IR	DRA3913	CA1345IR
DRA3579	CG19	DRA3715	CA1344IR	DRA3820	CA334IR	DRA3914	CA1637IR
DRA3583	CA1318IR	DRA3716	CA1060IR	DRA3823	CA1553IR	DRA3915	CA1621IR
DRA3584	JA1174IR	DRA3717	CA1444IR	DRA3824	JA1600IR	DRA3917	CA1306IR
DRA3585	JA1175IR	DRA3718	CA1331IR	DRA3824N	JA1600IR	DRA3917	JS1235
DRA3586	CA1316IR	DRA3719	CA1304IR	DRA3825	JA1280IR	DRA3918	CA1627IR
DRA3587	CA1337IR	DRA3720	CA345IR	DRA3826	JA1431IR	DRA3919	CA1307IR
DRA3588	CA325IR	DRA3723	CA1484IR	DRA3827	JA1358IR	DRA3921	CA1319IR
DRA3589	CA1396IR	DRA3724	CA848IR	DRA3828	CA1385IR	DRA3922	CA1506IR
DRA3589N	CA1396IR	DRA3725	CA1392IR	DRA3829	JA1529	DRA3923	CA1544IR
DRA3593	CA1386IR	DRA3726	CA1308IR	DRA3830	CA306IR	DRA3924	CA1576IR
DRA3593N	CA1386IR	DRA3727	CA1309IR	DRA3830	CA561IR	DRA3925	CA1346IR
DRA3608	CA1193IR	DRA3728	CA1333IR	DRA3834	CA738IR	DRA3926	JA1293IR
DRA3616	CA1233IR	DRA3729	CA1306IR	DRA3835	CA1474IR	DRA3927	JA1356IR
DRA3617	CA1097IR	DRA3733	CA1059IR	DRA3836	CA1379IR	DRA3928	JA1293IR
DRA3618	CA1107IR	DRA3734	CA1339IR	DRA3837	CA1330IR	DRA3929	JA1430IR
DRA3619	CA1492IR	DRA3735	CA1343IR	DRA3838	CA726IR	DRA3933	JA1372IR
DRA3620	CA595IR	DRA3736	CA1253IR	DRA3839	JA1129IR	DRA3934	CA1397IR
DRA3623	CA1192IR	DRA3736N	CA1253IR	DRA3840	CA500IR	DRA3935	CA1269IR
DRA3624	CA1243IR	DRA3737	JA1132IR	DRA3841	CA857IR	DRA3936	CA1348IR
DRA3625	CA1583IR	DRA3738	JA1191IR	DRA3841	CA858IR	DRA3937	CA1437IR
DRA3625N	CA1583IR	DRA3739	JA1166IR	DRA3843	JA1414IR	DRA3938	JA973IR
DRA3626	CA1338IR	DRA3740	CA321IR	DRA3844	JA1273IR	DRA3940	CA312IR
DRA3627	CA1305IR	DRA3743	JA984IR	DRA3845	JA1278IR	DRA3944	JA1611IR
DRA3628	CA624	DRA3744	JA1181IR	DRA3846	JA1715IR	DRA3945	JA1712IR
DRA3629	JA1121IR	DRA3745	JA989IR	DRA3846N	JA1715IR	DRA3946	JA1607IR
DRA3633	JA1127IR	DRA3745N	JA989IR	DRA3847	JA888IR	DRA3947	JA1790IR
DRA3634	JA1128IR	DRA3746	JA982	DRA3848	JA1366IR	DRA3948	JA1607IR
DRA3635	JA1281IR	DRA3747	JA1124	DRA3848N	JA1366IR	DRA3948N	JA1607IR
DRA3637	CA1745IR	DRA3748	JA1125	DRA3849	JA1171IR	DRA3949	CA1640IR
DRA3637N	CA1745IR	DRA3749	JA882IR	DRA3855	CA1347IR	DRA3953	CA1642IR
DRA3638	CA1671IR	DRA3753	CA1096IR	DRA3856	JA1710IR	DRA3954	CA1835IR
DRA3638N	CA1671IR	DRA3754	CA1628IR	DRA3857	CA1494IR	DRA3955	CA524IR
DRA3639	CA1216IR	DRA3755	CA1498IR	DRA3860	CA293IR	DRA3956	CA858IR
DRA3643	CA1349IR	DRA3755	CA1932IR	DRA3863	JA1515IR	DRA3957	CA1508IR
DRA3644	CA1350IR	DRA3756	CA1488IR	DRA3864	JA1409	DRA3958	CA357IR
DRA3646	CA1258IR	DRA3757	CA1487IR	DRA3865	CA1390IR	DRA3964	CA579IR
DRA3647	CA1137IR	DRA3758	CA1252IR	DRA3866	CA1299IR	DRA3965	CA377IR
DRA3648	CA1340IR	DRA3759	JA1424IR	DRA3867	JA1531IR	DRA3966	CA1141IR
DRA3649	CA1483IR	DRA3760	CA241IR	DRA3868	JA1411IR	DRA3967	CA562IR
DRA3653	CA1475IR	DRA3763	JA1407IR	DRA3869	JA1419IR	DRA3968	CA1561IR
DRA3655	CA1317IR	DRA3764	CA1157IR	DRA3870	CA910IR	DRA3968N	CA1561IR
DRA3655N	CA1317IR	DRA3765	CA1105IR	DRA3873	JA1284IR	DRA3970	CA315IR
DRA3656	CA1230IR	DRA3765	CA527IR	DRA3874	JA1427IR	DRA3984N	CA1670IR
DRA3658	JA1425IR	DRA3766	CA1199IR	DRA3875	JA1376IR	DRA3989	JA675IR
DRA3659	JA1120IR	DRA3767	CA1219IR	DRA3875N	JA1376IR	DRA3990	CA512IR
DRA3660	CA244IR	DRA3768	CA1558IR	DRA3876	JA1131IR	DRA3993	CA1455IR
DRA3663	JA1290IR	DRA3769	CA1234IR	DRA3877	JA1373IR	DRA3994	CA325IR
DRA3664	CA1556IR	DRA3773	CA843IR	DRA3878	JA1288IR	DRA3998	CA1325IR
DRA3667	CA1494IR	DRA3775	CA1389IR	DRA3879	JA1183IR	DRA4000	CA373IR
DRA3673	CA1150IR	DRA3776	CA1495IR	DRA3880	CA255IR	DRA4003	CA224IR
DRA3674	CA1380IR	DRA3777	CA560IR	DRA3883	JA1130IR	DRA4010	CA299IR
DRA3676	CA1100IR	DRA3778	CA717IR	DRA3885	JA1422IR	DRA4020	CA335IR
DRA3676	CA1380IR	DRA3779	CA1342IR	DRA3886	JA1420IR	DRA4027	CA1034IR
DRA3679	CA1337IR	DRA3783	CA1303IR	DRA3887	JA1413IR	DRA4029	JA1608IR
DRA3683	JA1283	DRA3784	CA1322IR	DRA3888	JA1412IR	DRA4033	CA1631IR
DRA3684	JA1282IR	DRA3786	CA1194IR	DRA3889	JA1374IR	DRA4034	JA1596IR

O.E. NO.	HC-PARTS	O.E. NO.	HC-PARTS	O.E. NO.	HC-PARTS	O.E. NO.	HC-PARTS
REMY (DELCO)	<i>Continued</i>						
DRA4035	CA1838IR	DRA4143	CA1635IR	DRA4238	CA1857IR	DRA4710	CA381IR
DRA4035N	CA1838IR	DRA4143N	CA1635IR	DRA4238N	CA1857IR	DRA4730	CA369IR
DRA4036	CA1310IR	DRA4144	CA1638IR	DRA4239	CA1834IR	DRA4740	CA375IR
DRA4037	CA1208IR	DRA4144N	CA1638IR	DRA4240	CA337IR	DRA4761	CA371IR
DRA4038	CA614IR	DRA4145	CA1323IR	DRA4243	CA1855IR	DRA4771	CA303IR
DRA4039	CA1572IR	DRA4146	CA1677IR	DRA4244	CA1862IR	DRA4780	CA378IR
DRA4040	CA141IR	DRA4146N	CA1677IR	DRA4245	CA1737IR	DRA4791	CA268IR
DRA4043	CA1681IR	DRA4147	JA769IR	DRA4246	CA1780IR	DRA4801	CA224IR
DRA4044	CA1687IR	DRA4148	CA1881IR	DRA4247	CA1777IR	DRA4810	CA372IR
DRA4045	CA1665IR	DRA4149	CA1645IR	DRA4247N	CA1777IR	DRA4821	CA289IR
DRA4046	CA1444IR	DRA4150	CA320IR	DRA4248	CA1778IR	DRA4831	CA359IR
DRA4047	CA1622IR	DRA4153	CA1626IR	DRA4249	CA1856IR	DRA4832	CA533IR
DRA4048	CA1771IR	DRA4154	CA1685IR	DRA4250	CA297IR	DRA4841	CA557IR
DRA4049	CA1662IR	DRA4155	CA1688IR	DRA4253	CA1855IR	DRA4850	CA229IR
DRA4054	CA1579IR	DRA4156	CA1746IR	DRA4255	CA1904IR	DRA4861	CA314IR
DRA4055	CA1332IR	DRA4157	CA1634IR	DRA4257	CA2037IR	DRA4881	CA329IR
DRA4056	CA1256IR	DRA4159	CA1733IR	DRA4258	CA1758IR	DRA4890	CA361IR
DRA4057	CA1573IR	DRA4160	CA320IR	DRA4258N	CA1758IR	DRA4901	CA338IR
DRA4057	CA574IR	DRA4163	CA1749IR	DRA4259	CA1823IR	DRA4910	CA824IR
DRA4057	CA625IR	DRA4164	CA1819IR	DRA4260	CA186IR	DRA4930	CA198IR
DRA4058	CA1400IR	DRA4165	CA1820IR	DRA4263	CA1885IR	DRA4940	CA502IR
DRA4059	CA1382IR	DRA4166	CA1634IR	DRA4264	CA1890IR	DRA4990	CA302IR
DRA4063	CA1383IR	DRA4166N	CA1634IR	DRA4265	CA1884IR	DRA5010	CA354IR
DRA4065	CA1584IR	DRA4167	CA1654IR	DRA4266	CA1757IR	DRA5020	CA569IR
DRA4066	CA1504IR	DRA4168	CA1660IR	DRA4267	CA1781IR	DRA5061	JA118
DRA4067	CA1750IR	DRA4169	CA1676IR	DRA4268	JA1711IR	DRA5081	JA157
DRA4068	CA1588IR	DRA4170	CA362IR	DRA4269	CA1874IR	DRA5141	JA174IR
DRA4069	CA1065IR	DRA4173	JA1518IR	DRA4269X	CA1874IR	DRA5161	JA884IR
DRA4070	CA595IR	DRA4173N	JA1518IR	DRA4270	CA568IR	DRA5181	JA125IR
DRA4073	CA1653IR	DRA4174	JA1708IR	DRA4273	CA1873IR	DRA5201	JA175IR
DRA4074	CA1976IR	DRA4174N	JA1708IR	DRA4274	JA1792IR	DRA5211	JA117IR
DRA4075	CA1698IR	DRA4175	JA1716IR	DRA4275	JA1721IR	DRA5241	JA199IR
DRA4077	CA1649IR	DRA4176	JA1717IR	DRA4276	JA1728IR	DRA5301	JA692IR
DRA4078	CA1760IR	DRA4177	JA1718IR	DRA4279	JA1796IR	DRA5311	JA165IR
DRA4079	JA1520IR	DRA4178	JA1789IR	DRA4281	JA129IR	DRA5321	JA1422IR
DRA4080	CA251IR	DRA4179	UA1619	DRA4283	JA1803IR	DRA5331	JA653IR
DRA4083	JA1514IR	DRA4180	CA277IR	DRA4284	CA1950IR	DRA5411	JA105IR
DRA4086	JA1801IR	DRA4183	JA1609IR	DRA4285	JA1899IR	DRA5431	JA109IR
DRA4087	JA1283	DRA4185	CA1451IR	DRA4286	CA1768IR	DRA5431	JA197IR
DRA4088	CA1680IR	DRA4186	CA1661IR	DRA4287	CA1833IR	DRA5491	JA155
DRA4088N	CA1680IR	DRA4187	CA1675IR	DRA4287N	CA1833IR	DRA5501	JA161IR
DRA4089	CA1630IR	DRA4189	JA1786IR	DRA4288	CA1388IR	DRA5501N	JA161IR
DRA4090	CA195IR	DRA4190	CA357IR	DRA4289	JA1725IR	DRA5521	JA144
DRA4093	JA1522IR	DRA4193	JA1703IR	DRA4291	JA128IR	DRA5591	JA134
DRA4094	JA1523IR	DRA4194	CA1627IR	DRA4294	CA2010IR	DRA5601	JA996IR
DRA4095	JA1516IR	DRA4195	CA1646IR	DRA4294N	CA2010IR	DRA5630	CA355IR
DRA4097	JA1602IR	DRA4196	JA1604IR	DRA4301	JA125IR	DRA5641	CA350IR
DRA4098	JA1594IR	DRA4197	CA1850IR	DRA4311	JA116IR	DRA5641N	CA350IR
DRA4099	CA1652IR	DRA4198	JA1795IR	DRA4321	JA140	DRA5670	CA342IR
DRA4104	CA1555IR	DRA4199	JA1795IR	DRA4350	CA722IR	DRA5681	JA573IR
DRA4105	JA1605IR	DRA4200	CA96IR	DRA4370	CA518IR	DRA5690	CA196IR
DRA4106	JA1722IR	DRA4203	JA1709IR	DRA4380	CA590IR	DRA5700	CA644IR
DRA4107	JA1793IR	DRA4203N	JA1709IR	DRA4380	CA590IR	DRA5700	CA644IR
DRA4108	JA1418IR	DRA4204	JA1539IR	DRA4391	CA295IR	DRA5720	CA712IR
DRA4113	CA1484IR	DRA4206	CA1697IR	DRA4400	CA333IR	DRA5730	CA541IR
DRA4114	CA1761IR	DRA4206	CA1697IR	DRA4400N	CA333IR	DRA5740	CA539IR
DRA4114	CA1761IR	DRA4207	CA1189IR	DRA4420	CA326IR	DRA5750	CA540IR
DRA4114	CA2008IR	DRA4208	CA1661IR	DRA4430	CA501IR	DRA5760	CA642IR
DRA4115	CA1625IR	DRA4209	CA1387IR	DRA4450	CA1404IR	DRA5780	CA586IR
DRA4115	CA1734IR	DRA4209	CA704IR	DRA4460	CA352IR	DRA5791	JA129IR
DRA4116	CA1587IR	DRA4210	CA710IR	DRA4463	CA517IR	DRA5800	CA630IR
DRA4117	CA1582IR	DRA4213	CA1831IR	DRA4470	CA325IR	DRA5810	CA542IR
DRA4118	CA1510IR	DRA4214	CA1674IR	DRA4480	CA254IR	DRA5820	CA503IR
DRA4119	CA1500IR	DRA4216	JA1353IR	DRA4490	CA504IR	DRA5841	CA609IR
DRA4120	CA566IR	DRA4217	CA836IR	DRA4500	CA520IR	DRA5871	JA531IR
DRA4123	CA1647IR	DRA4218	CA825IR	DRA4510	CA911IR	DRA5890	CA645IR
DRA4124	JA1351IR	DRA4219	CA836IR	DRA4520	CA376IR	DRA5910	CA702IR
DRA4126	CA1401IR	DRA4220	CA296IR	DRA4530	CA505IR	DRA6000	CA324IR
DRA4127	CA1731IR	DRA4223	JA1539IR	DRA4550	CA347IR	DRA6010	CA305IR
DRA4128	CA1761IR	DRA4226	JA1271IR	DRA4560	CA319IR	DRA6041	CA560IR
DRA4130	CA320IR	DRA4227	JA1183IR	DRA4580	CA537IR	DRA6050	CA299IR
DRA4133	JA1614IR	DRA4228	JA1899IR	DRA4590	CA349IR	DRA6060	CA561IR
DRA4135	CA833IR	DRA4228N	JA1899IR	DRA4610	CA1224IR	DRA6100	CA594IR
DRA4136	CA1041IR	DRA4230	CA298IR	DRA4620	CA87IR	DRA6110	CA1690IR
DRA4137	CA1672IR	DRA4230	CA520IR	DRA4630	CA313IR	DRA6150	CA1692IR
DRA4137N	CA1672IR	DRA4233	CA1839IR	DRA4640	CA254IR	DRA6160	CA563IR
DRA4138	CA1386IR	DRA4234	JA1525IR	DRA4650	CA353IR	DRA6215	CA516IR
DRA4139	JA599IR	DRA4236	CA1865IR	DRA4652	CA514IR	DRA6230	CA631IR
DRA4139	JA805IR	DRA4237	CA1857IR	DRA4660	CA509IR	DRA6240	CA558IR
DRA4140	CA322IR	DRA4237N	CA1857IR	DRA4700	CA381IR	DRA6241	CA558IR

O.E. NO.	HC-PARTS	O.E. NO.	HC-PARTS	O.E. NO.	HC-PARTS	O.E. NO.	HC-PARTS
DRA6250	CA516IR	DRA8110	CA839IR	DRA9570	CA1146IR	DRB1060	CA1480IR
DRA6251	CA516IR	DRA8130	CA826IR	DRA9620	CA1259IR	DRB1080	CA1580IR
DRA6260	CA364IR	DRA8160	CA1044IR	DRA9630	CA897IR	DRB1090	CA1035IR
DRA6263	CA588IR	DRA8170	CA1062IR	DRA9650	CA1207IR	DRB1110	CA1254IR
DRA6270	CA700IR	DRA8180	CA855IR	DRA9660	CA1138IR	DRB1120	CA1299IR
DRA6280	CA550IR	DRA8190	CA515IR	DRA9670	JA992IR	DRB1150	CA1443IR
DRA6281	CA748IR	DRA8200	CA846IR	DRA9690	CA700IR	DRB1160	JA987IR
DRA6301	JA657IR	DRA8260	CA1057IR	DRA9700	CA1145IR	DRB1170	JA1599IR
DRA6350	CA335IR	DRA8281	JA974IR	DRA9730	CA1503IR	DRB1180	JA1377IR
DRA6350	CA723IR	DRA8290	CA1236IR	DRA9750	CA1395IR	DRB1190	CA1569IR
DRA6360	CA714IR	DRA8300	CA700IR	DRA9760	CA1155IR	DRB1200	CA1140IR
DRA6370	CA645IR	DRA8310	CA1054IR	DRA9780	CA1151IR	DRB1210	CA1300IR
DRA6390	CA645IR	DRA8320	CA902IR	DRA9790	CA1593IR	DRB1230	CA1402IR
DRA6480	CA525IR	DRA8330	CA1063IR	DRA9800	CA1242IR	DRB1240	CA1257IR
DRA6490	CA811IR	DRA8340	CA841IR	DRA9810	CA1068IR	DRB1250	CA1490IR
DRA6501	JA171IR	DRA8351	CA898IR	DRA9831	CA1247IR	DRB1260	CA1391IR
DRA6510	CA619IR	DRA8390	CA827IR	DRA9870	CA1074IR	DRB1270	CA1440IR
DRA6520	CA379IR	DRA8600	CA861IR	DRA9881	CA1031IR	DRB1280	CA1492IR
DRA6530	CA604IR	DRA8600N	CA861IR	DRA9881	CA719IR	DRB1290	CA1591IR
DRA6540	CA519IR	DRA8610	CA829IR	DRA9891	CA1085IR	DRB1300	CA1260IR
DRA6542	CA530IR	DRA8630	CA1088IR	DRA9941	CA1098IR	DRB1310	CA1560IR
DRA6581	CA1028IR	DRA8641	CA894IR	DRA9971	CA830IR	DRB1320	CA1300IR
DRA6581	CA311IR	DRA8650	CA1032IR	DRB0002	CA1883IR	DRB1330	CA1327IR
DRA6631	CA719IR	DRA8660	CA1071IR	DRB0002N	CA1883IR	DRB1351	CA1079IR
DRA6641	JA160IR	DRA8670	CA1324IR	DRB0003	CA1883IR	DRB1361	CA1449IR
DRA6651	CA351IR	DRA8680	CA1149IR	DRB0003N	CA1883IR	DRB1401	CA1052IR
DRA6660	CA521IR	DRA8690	CA1076IR	DRB0011	CA1320IR	DRB1451	CA1150IR
DRA6671	CA703IR	DRA8720	CA729IR	DRB0061	CA1040IR	DRB1461	CA1099IR
DRA6690	CA738IR	DRA8751	CA648IR	DRB0101	CA1033IR	DRB1471	CA1156IR
DRA6750	CA506IR	DRA8791	CA825IR	DRB0161	CA895IR	DRB1480	CA1502IR
DRA6760	CA539IR	DRA8791N	CA825IR	DRB0170	CA1090IR	DRB1490	CA1446IR
DRA6760	CA547IR	DRA8841	CA889IR	DRB0180	CA1209IR	DRB1500	CA1378IR
DRA6770	CA538IR	DRA8910	CA1206IR	DRB0201	CA1038IR	DRB1500N	CA1378IR
DRA6780	CA727IR	DRA8920	JA991IR	DRB0201N	CA1038IR	DRB1510	CA1436IR
DRA6790	CA610IR	DRA8930	JA1117IR	DRB0211	CA1065IR	DRB1510N	CA1436IR
DRA6800	CA847IR	DRA8930N	JA1117IR	DRB0211N	CA1065IR	DRB1520	CA1845IR
DRA6810	CA724IR	DRA8940	CA1244IR	DRB0221	CA1152IR	DRB1530	CA1489IR
DRA6820	CA1062IR	DRA8950	CA1399IR	DRB0221N	CA1152IR	DRB1550	CA1491IR
DRA6820	CA833IR	DRA8960	CA826IR	DRB0231	CA1203IR	DRB1590	CA1481IR
DRA6860	CA711IR	DRA8990	CA1037IR	DRB0231N	CA1203IR	DRB1640	CA1236IR
DRA6920	CA240IR	DRA9000	CA1092IR	DRB0260	CA1593IR	DRB1650	CA1206IR
DRA6930	CA909IR	DRA9010	CA827IR	DRB0270	CA1204IR	DRB1730	CA1439IR
DRA6941	CA527IR	DRA9030	CA1142IR	DRB0280	CA1198IR	DRB1750	CA1632IR
DRA6961	CA589IR	DRA9080	CA1143IR	DRB0290	CA1197IR	DRB1750N	CA1632IR
DRA6991	JA696IR	DRA9090	CA1089IR	DRB0300	JA1176IR	DRB1750X	CA1632IR
DRA7021	JA168	DRA9100	CA1064IR	DRB0320	CA1239IR	DRB1760	CA1634IR
DRA7031	JA531IR	DRA9130	CA1336IR	DRB0330	CA1228IR	DRB1760N	CA1634IR
DRA7040	CA324IR	DRA9140	CA1235IR	DRB0340	CA1139IR	DRB1810	CA1591IR
DRA7051	CA370IR	DRA9150	CA903IR	DRB0350	CA1248IR	DRB1840	CA1433IR
DRA7112	CA739IR	DRA9170	CA1056IR	DRB0360	CA1229IR	DRB1860	CA1394IR
DRA7160	CA834IR	DRA9180	CA1069IR	DRB0370	CA1088IR	DRB1870	CA1541IR
DRA7221	CA705IR	DRA9200	CA1245IR	DRB0380	CA1261IR	DRB1870N	CA1541IR
DRA7231	CA705IR	DRA9210	CA1399IR	DRB0390	CA1256IR	DRB1890	CA1445IR
DRA7241	CA721	DRA9220	CA1106IR	DRB0400	CA1246IR	DRB1900	CA1549IR
DRA7271	JA551IR	DRA9230	CA1066IR	DRB0410	CA1102IR	DRB1910	CA1504IR
DRA7301	CA526IR	DRA9240	CA1045IR	DRB0430	CA1231IR	DRB1920	CA1542IR
DRA7311	CA602IR	DRA9240	CA1053IR	DRB0600	CA1403IR	DRB1920N	CA1542IR
DRA7321	CA549IR	DRA9250	CA1070IR	DRB0631	CA1216IR	DRB1930	CA1509IR
DRA7321	CA649IR	DRA9260	CA907IR	DRB0641	CA1216IR	DRB1940	CA1448IR
DRA7340	CA646IR	DRA9280	CA908IR	DRB0800	CA1395IR	DRB1950	CA1482IR
DRA7380	CA646IR	DRA9300	CA1043IR	DRB0830	JA1426IR	DRB1960	CA1557IR
DRA7410	CA333IR	DRA9330	CA737IR	DRB0840	CA1266IR	DRB1980	CA1556IR
DRA7410N	CA333IR	DRA9340	CA1438IR	DRB0850	JA1364IR	DRB1990	JA1415IR
DRA7420	CA824IR	DRA9350	CA1301IR	DRB0860	CA1249IR	DRB2000	CA1471IR
DRA7440	CA854IR	DRA9370	CA1300IR	DRB0870	CA1267IR	DRB2010	CA1485IR
DRA7440N	CA854IR	DRA9420	CA1563IR	DRB0870N	CA1267IR	DRB2020	CA1486IR
DRA7450	CA1027IR	DRA9440	CA912IR	DRB0880	CA1255IR	DRB2041	CA1434IR
DRA7460	CA1551IR	DRA9450	CA844IR	DRB0890	CA1543IR	DRB2091	CA1564IR
DRA7491	JA599IR	DRA9460	JA987IR	DRB0910	JA1405IR	DRB2161	CA837IR
DRA7760	CA853IR	DRA9481	CA1042IR	DRB0930	CA1226IR	DRB2350	CA1456IR
DRA7770	CA1035IR	DRA9490	CA1148IR	DRB0940	CA1240IR	DRB2360	CA1666IR
DRA7791	CA735IR	DRA9501	CA893IR	DRB0950	CA1297IR	DRB2360N	CA1666IR
DRA7880	CA904IR	DRA9501N	CA893IR	DRB0960	JA1134IR	DRB2360X	CA1666IR
DRA7890	CA238IR	DRA9510	CA1087IR	DRB0970	CA1262IR	DRB2370	CA1666IR
DRA7970	CA1081IR	DRA9520	CA1147IR	DRB0980	CA1452IR	DRB2370X	CA1666IR
DRA7990	CA1477IR	DRA9530	CA1237IR	DRB0990	CA1241IR	DRB2380	CA1666IR
DRA8080	CA906IR	DRA9540	CA852IR	DRB1000	CA1107IR	DRB2390	CA1739IR
DRA8090	CA320IR	DRA9550	CA1093IR	DRB1010	CA1144IR	DRB2390N	CA1739IR
DRA8100	CA1058IR	DRA9550N	CA1093IR	DRB1030	CA1505IR	DRB2390X	CA1739IR

O.E. NO.	HC-PARTS	O.E. NO.	HC-PARTS	O.E. NO.	HC-PARTS	O.E. NO.	HC-PARTS
REMY (DELCO)	<i>Continued</i>						
DRB2400.....	CA1739IR	DRB5370.....	CA1779IR	DRS0015N.....	CS1403	DRS0133.....	CS1424
DRB2400N.....	CA1739IR	DRB5370N.....	CA1779IR	DRS0016.....	CS1402	DRS0134.....	JS1365
DRB2410.....	CA1739IR	DRB5380.....	CA1752IR	DRS0016N.....	CS1402	DRS0134N.....	JS1365
DRB2410N.....	CA1739IR	DRB5390.....	CA1810IR	DRS0017.....	CS1426	DRS0135.....	CS1442
DRB2470.....	CA1575IR	DRB5420.....	CA1701IR	DRS0017N.....	CS1426	DRS0136.....	JS1365
DRB2520.....	CA1489IR	DRB5430.....	CA1812IR	DRS0020.....	CS122	DRS0140.....	CS74
DRB2530.....	CA1489IR	DRB5430N.....	CA1812IR	DRS0024.....	CS572	DRS0141.....	CS1431
DRB2540.....	CA1623IR	DRB5490.....	CA1694IR	DRS0025.....	CS682	DRS0147.....	CS1446
DRB2550.....	CA1689IR	DRB5611.....	JA1617IR	DRS0030.....	CS162	DRS0150.....	CS130
DRB2570.....	CA1656IR	DRB5691.....	JA1702IR	DRS0030.....	CS166	DRS0151.....	CS93
DRB2570.....	CA1872IR	DRB5801.....	JA1612IR	DRS0032.....	CS1430	DRS0154.....	JS940
DRB2580.....	CA1695IR	DRB5821.....	JA1595IR	DRS0032N.....	CS1430	DRS0157.....	CS1403
DRB2590.....	CA1663IR	DRB5831.....	JA1794IR	DRS0033.....	JS1317	DRS0157N.....	CS1403
DRB2590N.....	CA1663IR	DRB5861.....	JA1517IR	DRS0033N.....	JS1317	DRS0158.....	CS1429
DRB2600.....	CA1511IR	DRB5891.....	JA1410IR	DRS0034.....	JS1361	DRS0158N.....	CS1429
DRB2600N.....	CA1511IR	DRB5990.....	CA1667IR	DRS0034N.....	JS1361	DRS0159.....	CS1050
DRB2600N.....	CA1682IR	DRB6000.....	CA1062IR	DRS0035.....	CS1339	DRS0159N.....	CS1050
DRB2610.....	CA1547IR	DRB6010.....	CA1570IR	DRS0036.....	CS1244	DRS0160.....	CS1336
DRB2630.....	CA1566IR	DRB6030.....	CA1493IR	DRS0036N.....	CS1244	DRS0160N.....	CS1336
DRB2640.....	CA1586IR	DRB6040.....	CA1633IR	DRS0037.....	JS1355	DRS0161.....	CS1377
DRB2650.....	CA1639IR	DRB6040N.....	CA1633IR	DRS0038.....	JS1311	DRS0161N.....	CS1377
DRB2650N.....	CA1639IR	DRB6060.....	CA1700IR	DRS0040.....	CS66	DRS0162.....	JS929
DRB2660.....	JA1605IR	DRB6090.....	CA1743IR	DRS0040.....	CS80	DRS0164.....	CS1464
DRB2670.....	CA1684IR	DRB6110.....	JA1894IR	DRS0045.....	JS1363	DRS0166.....	CS1331
DRB2680.....	CA1585IR	DRB6120.....	CA1907IR	DRS0047.....	JS1098	DRS0167.....	CS1474
DRB2700.....	CA1441IR	DRB6130.....	CA1773IR	DRS0047N.....	JS1098	DRS0170.....	CS69
DRB2710.....	CA1548IR	DRB6150.....	CA1821IR	DRS0048.....	JS1352	DRS0174.....	CS1323
DRB2720.....	CA1544IR	DRB6160.....	CA1754IR	DRS0049.....	CS1443	DRS0175.....	JS1368
DRB2730.....	CA1732IR	DRB6180.....	CA1811IR	DRS0049N.....	CS1443	DRS0176.....	CS1466
DRB2750.....	CA1501IR	DRB6190.....	CA1683IR	DRS0051.....	CS885	DRS0177.....	CS1467
DRB2760.....	CA1648IR	DRB6210.....	CA1837IR	DRS0053.....	CS1387	DRS0178.....	CS1437
DRB2780.....	CA1223IR	DRB6220.....	CA1825IR	DRS0054.....	CS1384	DRS0185.....	CS1203
DRB2790.....	CA1636IR	DRB6230.....	CA1828IR	DRS0055.....	CS1468	DRS0186.....	CS1425
DRB2810.....	CA1644IR	DRB6250.....	CA1824IR	DRS0056.....	CS1112	DRS0187.....	CS1416
DRB2820.....	CA1679IR	DRB6260.....	CA1827IR	DRS0057.....	CS1381	DRS0188.....	CS1437
DRB2840.....	CA1673IR	DRB6270.....	CA1774IR	DRS0060.....	CS60	DRS0190.....	CS170
DRB3041.....	JA981IR	DRB6280.....	CA1863IR	DRS0063.....	CS1346	DRS0193.....	CS1192
DRB3130.....	CA1480IR	DRB6290.....	CA1853IR	DRS0065.....	JS1356	DRS0200.....	CS352
DRB3580.....	CA1232IR	DRB6300.....	CA1775IR	DRS0067.....	CS1376	DRS0201.....	JS907
DRB3650.....	CA1489IR	DRB6320.....	CA1846IR	DRS0068.....	CS1125	DRS0210.....	CS1422
DRB3660.....	CA1481IR	DRB6330.....	CA1859IR	DRS0069.....	JS1318	DRS0214.....	CS624
DRB3670.....	CA1776IR	DRB6340.....	CA1764IR	DRS0070.....	CS61	DRS0220.....	CS168
DRB3890.....	CA1505IR	DRB6440.....	CA1866IR	DRS0071.....	JS1349	DRS0222.....	CS1505
DRB3900.....	CA1481IR	DRB6550.....	CA1659IR	DRS0072.....	JS1357	DRS0229.....	CS1432
DRB3910.....	CA1630IR	DRB6560.....	CA1694IR	DRS0079.....	JS1359	DRS0232.....	CS1509
DRB4010.....	CA1592IR	DRB6570.....	CA1693IR	DRS0080.....	CS74	DRS0234.....	CS1264
DRB4011.....	CA1858IR	DRB6570N.....	CA1693IR	DRS0082.....	JS1353	DRS0241.....	CS1286
DRB4020.....	CA1740IR	DRB6580.....	CA1851IR	DRS0083.....	JS1316	DRS0242.....	CS1421
DRB4021.....	CA1740IR	DRB6590.....	CA1871IR	DRS0084.....	CS1427	DRS0246.....	CS1488
DRB4030.....	CA1577IR	DRB6590N.....	CA1871IR	DRS0085.....	CS1391	DRS0247.....	JS1367
DRB4060.....	CA1624IR	DRB7150.....	CA1908IR	DRS0091.....	JS1313	DRS0250.....	CS263
DRB4070.....	CA1744IR	DRB7160.....	CA1237IR	DRS0093.....	CS1288	DRS0253.....	JS934
DRB4210.....	CA1747IR	DRB7220.....	CA1867IR	DRS0094.....	CS1454	DRS0256.....	JS740
DRB4300.....	CA1546IR	DRB7270.....	CA1882IR	DRS0095.....	CS1482	DRS0257.....	JS738
DRB4310.....	CA1664IR	DRB7340.....	CA1860IR	DRS0099.....	CS1264	DRS0260.....	CS355
DRB4320.....	CA1759IR	DRB7380.....	CA1988IR	DRS0100.....	CS1463	DRS0261.....	CS142
DRB4340.....	CA1545IR	DRB7390.....	CA1877IR	DRS0101.....	JS1310	DRS0262.....	CS142
DRB4410.....	CA1658IR	DRB7420.....	CA1870IR	DRS0103.....	CS1417	DRS0270.....	CS154
DRB4460.....	CA1678IR	DRB7430.....	CA1847IR	DRS0105.....	JS1011	DRS0281.....	JS1309
DRB4480.....	CA1813IR	DRB7440.....	CA1853IR	DRS0109.....	CS1388	DRS0282.....	CS1383
DRB4490.....	CA2024IR	DRB7470.....	CA1861IR	DRS0109N.....	CS1388	DRS0290.....	CS275
DRB4540.....	CA1546IR	DRB7490.....	CA1840IR	DRS0110.....	CS83	DRS0300.....	CS278
DRB4550.....	CA1321IR	DRB7500.....	CA2028IR	DRS0111.....	CS1478	DRS0310.....	CS310
DRB4850.....	CA1540IR	DRB7530.....	CA1656IR	DRS0112.....	CS1401	DRS0330.....	CS180
DRB4890.....	CA1854IR	DRB7820.....	CA1880IR	DRS0113.....	CS1415	DRS0340.....	CS131
DRB4910.....	CA1769IR	DRB7820N.....	CA1880IR	DRS0114.....	CS1263	DRS0350.....	CS77
DRB5160.....	CA1699IR	DRB7820X.....	CA1880IR	DRS0115.....	CS1473	DRS0360.....	CS115
DRB5170.....	CA2040IR	DRB7870.....	CA333IR	DRS0116.....	JS1218	DRS0370.....	CS116
DRB5170N.....	CA2040IR	DRB7910.....	CA1928IR	DRS0119.....	CS1481	DRS0390.....	CS116
DRB5170X.....	CA2040IR	DRB7920.....	CA1922IR	DRS0120.....	CS261	DRS0390.....	CS123
DRB5280.....	CA1666IR	DRB8040.....	CA1945IR	DRS0120.....	CS70	DRS0390.....	CS592
DRB5290.....	CA1739IR	DRB8070.....	CA1916IR	DRS0121.....	CS261	DRS0400.....	CS78
DRB5290N.....	CA1739IR	DRB8380.....	CA1919IR	DRS0122.....	CS1439	DRS0410.....	CS79
DRB5300.....	CA1729IR	DRB9320.....	CA1917IR	DRS0124.....	CS1386	DRS0420.....	CS79
DRB5310.....	CA1815IR	DRS0006.....	CS1407	DRS0125.....	CS1495	DRS0430.....	CS156
DRB5320.....	CA1817IR	DRS0007.....	JS1312	DRS0126.....	CS1460	DRS0440.....	CS133
DRB5330.....	CA1818IR	DRS0008.....	JS909	DRS0130.....	CS1433	DRS0450.....	CS285
DRB5340.....	CA1782IR	DRS0010.....	CS141	DRS0130N.....	CS1433	DRS0460.....	CS77
DRB5360.....	CA1763IR	DRS0015.....	CS1403	DRS0131.....	CS87	DRS0470.....	CS298

O.E. NO.	HC-PARTS	O.E. NO.	HC-PARTS	O.E. NO.	HC-PARTS	O.E. NO.	HC-PARTS
DRS0490.....	<b>CS79</b>	DRS1420.....	<b>CS194</b>	DRS2460.....	<b>CS707</b>	DRS3084.....	<b>CS1201</b>
DRS0510.....	<b>CS69</b>	DRS1430.....	<b>CS98</b>	DRS2470.....	<b>CS336</b>	DRS3085.....	<b>JS364</b>
DRS0530.....	<b>CS62</b>	DRS1440.....	<b>CS195</b>	DRS2480.....	<b>CS121</b>	DRS3086.....	<b>JS311</b>
DRS0550.....	<b>CS117</b>	DRS1450.....	<b>CS99</b>	DRS2570.....	<b>CS690</b>	DRS3087.....	<b>JS375</b>
DRS0564.....	<b>CS1480</b>	DRS1460.....	<b>CS383</b>	DRS2581.....	<b>JS315</b>	DRS3088.....	<b>JS553</b>
DRS0570.....	<b>CS276</b>	DRS1470.....	<b>CS546</b>	DRS2590.....	<b>CS294</b>	DRS3088N.....	<b>JS553</b>
DRS0580.....	<b>CS117</b>	DRS1490.....	<b>CS198</b>	DRS2600.....	<b>CS294</b>	DRS3090.....	<b>CS341</b>
DRS0590.....	<b>CS338</b>	DRS1510.....	<b>CS198</b>	DRS2610.....	<b>CS507</b>	DRS3093.....	<b>JS351</b>
DRS0590.....	<b>CS353</b>	DRS1520.....	<b>CS99</b>	DRS2620.....	<b>CS378</b>	DRS3094.....	<b>JS358</b>
DRS0600.....	<b>CS382</b>	DRS1530.....	<b>CS951</b>	DRS2623.....	<b>CS378</b>	DRS3095.....	<b>JS363</b>
DRS0610.....	<b>CS76</b>	DRS1550.....	<b>CS194</b>	DRS2640.....	<b>CS132</b>	DRS3098.....	<b>JS387</b>
DRS0640.....	<b>CS72</b>	DRS1570.....	<b>CS191</b>	DRS2650.....	<b>CS348</b>	DRS3100.....	<b>CS356</b>
DRS0650.....	<b>CS292</b>	DRS1580.....	<b>CS565</b>	DRS2660.....	<b>CS508</b>	DRS3103.....	<b>CS364</b>
DRS0660.....	<b>CS135</b>	DRS1601.....	<b>CS166</b>	DRS2670.....	<b>CS572</b>	DRS3104.....	<b>CS536</b>
DRS0668.....	<b>CS1510</b>	DRS1611.....	<b>CS19</b>	DRS2680.....	<b>CS511</b>	DRS3105.....	<b>CS529</b>
DRS0670.....	<b>CS89</b>	DRS1651.....	<b>CS95</b>	DRS2690.....	<b>CS716</b>	DRS3107.....	<b>CS681</b>
DRS0671.....	<b>CS1506</b>	DRS1671.....	<b>CS126</b>	DRS2700.....	<b>CS501</b>	DRS3108.....	<b>CS581</b>
DRS0680.....	<b>CS334</b>	DRS1671.....	<b>CS94</b>	DRS2710.....	<b>CS335</b>	DRS3109.....	<b>CS715</b>
DRS0690.....	<b>CS80</b>	DRS1691.....	<b>CS143</b>	DRS2720.....	<b>CS682</b>	DRS3110.....	<b>CS343</b>
DRS0693.....	<b>CS1166</b>	DRS1691.....	<b>CS150</b>	DRS2730.....	<b>CS384</b>	DRS3113.....	<b>CS566</b>
DRS0710.....	<b>CS86</b>	DRS1701.....	<b>CS127</b>	DRS2740.....	<b>CS710</b>	DRS3114.....	<b>CS551</b>
DRS0720.....	<b>CS183</b>	DRS1711.....	<b>CS151</b>	DRS2780.....	<b>CS783</b>	DRS3115.....	<b>CS1177</b>
DRS0730.....	<b>CS324</b>	DRS1721.....	<b>CS93</b>	DRS2831.....	<b>JS674</b>	DRS3116.....	<b>CS310</b>
DRS0770.....	<b>CS184</b>	DRS1731.....	<b>CS126</b>	DRS2841.....	<b>JS360</b>	DRS3117.....	<b>CS594</b>
DRS0780.....	<b>CS132</b>	DRS1731.....	<b>CS94</b>	DRS2851.....	<b>JS315</b>	DRS3118.....	<b>CS621</b>
DRS0790.....	<b>CS622</b>	DRS1741.....	<b>CS95</b>	DRS2861.....	<b>JS327</b>	DRS3119.....	<b>CS681</b>
DRS0800.....	<b>CS132</b>	DRS1770.....	<b>CS523</b>	DRS2871.....	<b>JS350</b>	DRS3123.....	<b>CS701</b>
DRS0800.....	<b>CS282</b>	DRS1780.....	<b>CS280</b>	DRS2872.....	<b>JS396</b>	DRS3124.....	<b>CS379</b>
DRS0810.....	<b>CS508</b>	DRS1783.....	<b>CS280</b>	DRS2881.....	<b>JS394</b>	DRS3126.....	<b>CS528</b>
DRS0820.....	<b>CS136</b>	DRS1791.....	<b>CS163</b>	DRS2901.....	<b>JS373</b>	DRS3128.....	<b>JS896</b>
DRS0830.....	<b>CS185</b>	DRS1801.....	<b>CS155</b>	DRS2911.....	<b>JS304</b>	DRS3129.....	<b>CS584</b>
DRS0850.....	<b>CS81</b>	DRS1811.....	<b>CS143</b>	DRS2921.....	<b>JS556</b>	DRS3130.....	<b>CS325</b>
DRS0860.....	<b>CS273</b>	DRS1812.....	<b>CS321</b>	DRS2931.....	<b>JS343</b>	DRS3133.....	<b>JS657</b>
DRS0870.....	<b>CS119</b>	DRS1821.....	<b>CS165</b>	DRS2932.....	<b>JS329</b>	DRS3134.....	<b>JS657</b>
DRS0880.....	<b>CS286</b>	DRS1831.....	<b>CS315</b>	DRS2933.....	<b>JS340</b>	DRS3136.....	<b>JS527</b>
DRS0890.....	<b>CS268</b>	DRS1841.....	<b>CS397</b>	DRS2950.....	<b>CS120</b>	DRS3137.....	<b>JS347</b>
DRS0900.....	<b>CS311</b>	DRS1871.....	<b>CS91</b>	DRS2980.....	<b>CS311</b>	DRS3138.....	<b>JS314</b>
DRS0910.....	<b>CS185</b>	DRS1891.....	<b>CS90</b>	DRS2990.....	<b>CS81</b>	DRS3139.....	<b>JS628</b>
DRS0920.....	<b>CS272</b>	DRS1910.....	<b>CS139</b>	DRS3010.....	<b>CS327</b>	DRS3140.....	<b>CS386</b>
DRS0930.....	<b>CS290</b>	DRS1921.....	<b>CS147</b>	DRS3014.....	<b>JS382</b>	DRS3143.....	<b>JS658</b>
DRS0940.....	<b>CS299</b>	DRS1931.....	<b>CS363</b>	DRS3015.....	<b>JS377</b>	DRS3143N.....	<b>JS658</b>
DRS0950.....	<b>CS337</b>	DRS1941.....	<b>CS308</b>	DRS3017.....	<b>JS337</b>	DRS3144.....	<b>JS552</b>
DRS0950N.....	<b>CS337</b>	DRS1981.....	<b>JS330</b>	DRS3018.....	<b>JS642</b>	DRS3145.....	<b>JS532</b>
DRS0960.....	<b>CS607</b>	DRS2001.....	<b>JS331</b>	DRS3018N.....	<b>JS642</b>	DRS3146.....	<b>JS533</b>
DRS0970.....	<b>CS608</b>	DRS2011.....	<b>JS331</b>	DRS3019.....	<b>JS392</b>	DRS3148.....	<b>JS354</b>
DRS0980.....	<b>CS391</b>	DRS2021.....	<b>JS335</b>	DRS3023.....	<b>JS385</b>	DRS3148.....	<b>JS534</b>
DRS0990.....	<b>CS114</b>	DRS2031.....	<b>JS335</b>	DRS3024.....	<b>JS357</b>	DRS3149.....	<b>JS549</b>
DRS1000.....	<b>CS113</b>	DRS2061.....	<b>JS336</b>	DRS3025.....	<b>JS525</b>	DRS3150.....	<b>CS360</b>
DRS1020.....	<b>CS550</b>	DRS2071.....	<b>JS303</b>	DRS3026.....	<b>JS386</b>	DRS3150N.....	<b>CS360</b>
DRS1030.....	<b>CS128</b>	DRS2091.....	<b>JS302</b>	DRS3027.....	<b>CS332</b>	DRS3153.....	<b>JS634</b>
DRS1040.....	<b>CS804</b>	DRS2101.....	<b>JS303</b>	DRS3029.....	<b>JS538</b>	DRS3154.....	<b>JS637</b>
DRS1050.....	<b>CS188</b>	DRS2101.....	<b>JS307</b>	DRS3032.....	<b>JS662</b>	DRS3155.....	<b>JS747</b>
DRS1060.....	<b>CS230</b>	DRS2111.....	<b>JS301</b>	DRS3035.....	<b>JS355</b>	DRS3156.....	<b>JS636</b>
DRS1063.....	<b>CS689</b>	DRS2121.....	<b>JS322</b>	DRS3036.....	<b>JS344</b>	DRS3157.....	<b>JS635</b>
DRS1070.....	<b>CS148</b>	DRS2131.....	<b>JS320</b>	DRS3036N.....	<b>JS344</b>	DRS3158.....	<b>JS903</b>
DRS1080.....	<b>CS289</b>	DRS2161.....	<b>JS310</b>	DRS3037.....	<b>JS389</b>	DRS3159.....	<b>JS1004</b>
DRS1090.....	<b>CS347</b>	DRS2171.....	<b>JS342</b>	DRS3038.....	<b>JS379</b>	DRS3159N.....	<b>JS1004</b>
DRS1110.....	<b>CS314</b>	DRS2172.....	<b>JS643</b>	DRS3043.....	<b>JS512</b>	DRS3160.....	<b>CS346</b>
DRS1130.....	<b>CS503</b>	DRS2201.....	<b>JS333</b>	DRS3044.....	<b>JS372</b>	DRS3163.....	<b>JS658</b>
DRS1140.....	<b>CS103</b>	DRS2211.....	<b>JS333</b>	DRS3045.....	<b>JS380</b>	DRS3164.....	<b>JS672</b>
DRS1150.....	<b>CS188</b>	DRS2221.....	<b>JS333</b>	DRS3046.....	<b>JS318</b>	DRS3165.....	<b>JS517</b>
DRS1160.....	<b>CS231</b>	DRS2231.....	<b>JS300</b>	DRS3047.....	<b>JS309</b>	DRS3165N.....	<b>JS517</b>
DRS1170.....	<b>CS387</b>	DRS2231.....	<b>JS303</b>	DRS3048.....	<b>JS668</b>	DRS3166.....	<b>JS522</b>
DRS1180.....	<b>CS398</b>	DRS2251.....	<b>JS335</b>	DRS3050.....	<b>CS295</b>	DRS3167.....	<b>JS638</b>
DRS1200.....	<b>CS103</b>	DRS2261.....	<b>JS646</b>	DRS3052.....	<b>JS632</b>	DRS3168.....	<b>JS650</b>
DRS1200.....	<b>CS109</b>	DRS2271.....	<b>JS325</b>	DRS3053.....	<b>JS399</b>	DRS3169.....	<b>JS359</b>
DRS1220.....	<b>CS240</b>	DRS2281.....	<b>JS327</b>	DRS3055.....	<b>JS348</b>	DRS3173.....	<b>JS568</b>
DRS1240.....	<b>CS186</b>	DRS2291.....	<b>JS305</b>	DRS3057.....	<b>JS393</b>	DRS3174.....	<b>JS563</b>
DRS1260.....	<b>CS266</b>	DRS2301.....	<b>JS349</b>	DRS3058.....	<b>JS560</b>	DRS3175.....	<b>JS631</b>
DRS1270.....	<b>CS530</b>	DRS2301N.....	<b>JS349</b>	DRS3065.....	<b>CS18</b>	DRS3178.....	<b>JS760</b>
DRS1280.....	<b>CS97</b>	DRS2311.....	<b>JS388</b>	DRS3066.....	<b>CS720</b>	DRS3179.....	<b>JS760</b>
DRS1290.....	<b>CS269</b>	DRS2320.....	<b>CS282</b>	DRS3068.....	<b>CS19</b>	DRS3180.....	<b>CS349</b>
DRS1290N.....	<b>CS269</b>	DRS2330.....	<b>CS267</b>	DRS3070.....	<b>CS1110</b>	DRS3183.....	<b>JS628</b>
DRS1300.....	<b>CS101</b>	DRS2340.....	<b>CS326</b>	DRS3075.....	<b>CS338</b>	DRS3184.....	<b>JS656</b>
DRS1310.....	<b>CS232</b>	DRS2343.....	<b>CS566</b>	DRS3075.....	<b>CS353</b>	DRS3185.....	<b>JS761</b>
DRS1330.....	<b>CS394</b>	DRS2360.....	<b>CS297</b>	DRS3076.....	<b>CS317</b>	DRS3187.....	<b>CS791</b>
DRS1360.....	<b>CS120</b>	DRS2380.....	<b>CS331</b>	DRS3078.....	<b>CS361</b>	DRS3188.....	<b>CS505</b>
DRS1370N.....	<b>CS726</b>	DRS2420.....	<b>CS395</b>	DRS3080.....	<b>CS322</b>	DRS3189.....	<b>JS651</b>
DRS1380.....	<b>CS388</b>	DRS2440.....	<b>CS340</b>	DRS3083.....	<b>CS570</b>	DRS3194.....	<b>JS647</b>

O.E. NO.	HC-PARTS	O.E. NO.	HC-PARTS	O.E. NO.	HC-PARTS	O.E. NO.	HC-PARTS
REMY (DELCO)	<i>Continued</i>						
DRS3196.....	CS592	DRS3307.....	JS901	DRS3430.....	CS526	DRS3608.....	JS891
DRS3197.....	CS200	DRS3308.....	CS981	DRS3440.....	CS564	DRS3609.....	JS914
DRS3198.....	CS589	DRS3309.....	CS992	DRS3450.....	CS881	DRS3610.....	CS372
DRS3198N.....	CS589	DRS3313.....	CS1043	DRS3457.....	CS181	DRS3610N.....	CS372
DRS3199.....	CS587	DRS3314.....	CS1045	DRS3463.....	CS948	DRS3611.....	CS518
DRS3200.....	CS354	DRS3315.....	CS1124	DRS3464.....	CS997	DRS3611N.....	CS518
DRS3202.....	CS354	DRS3316.....	CS1076	DRS3466.....	CS181	DRS3613.....	JS938
DRS3202.....	CS684	DRS3317.....	CS800	DRS3468.....	CS609	DRS3614.....	JS1142
DRS3203.....	CS367	DRS3318.....	CS712	DRS3470.....	CS297	DRS3615.....	JS1156
DRS3205.....	CS610	DRS3320.....	CS1031	DRS3473.....	CS1056	DRS3616.....	JS999
DRS3206.....	CS579	DRS3324.....	CS805	DRS3474.....	CS610	DRS3617.....	CS594
DRS3207.....	JS627	DRS3326.....	CS718	DRS3475.....	JS1001	DRS3618.....	CS1177
DRS3208.....	JS666	DRS3327.....	JS778	DRS3476.....	CS1058	DRS3619.....	CS1108
DRS3209.....	JS665	DRS3328.....	CS707	DRS3477.....	CS1078	DRS3620.....	CS393
DRS3210.....	CS306	DRS3333.....	CS107	DRS3478.....	JS1079	DRS3623.....	CS681
DRS3213.....	JS1086	DRS3334.....	CS700	DRS3479.....	CS542	DRS3624.....	CS1174
DRS3214.....	JS1150	DRS3335.....	CS702	DRS3480.....	CS186	DRS3625.....	CS1060
DRS3214.....	JS648	DRS3336.....	CS693	DRS3483.....	JS902	DRS3626.....	CS978
DRS3215.....	JS653	DRS3337.....	CS623	DRS3484.....	JS1091	DRS3627.....	CS19
DRS3216.....	JS753	DRS3338.....	JS756	DRS3484N.....	JS1091	DRS3630.....	CS504
DRS3217.....	JS746	DRS3339.....	JS769	DRS3490.....	CS120	DRS3633.....	CS116
DRS3218.....	JS679	DRS3340.....	CS578	DRS3498.....	CS722	DRS3635.....	JS1149
DRS3219.....	JS748	DRS3343.....	JS770	DRS3501.....	JS640	DRS3635N.....	JS1149
DRS3220.....	CS714	DRS3343N.....	JS770	DRS3508.....	CS700	DRS3636.....	CS1047
DRS3223.....	JS639	DRS3344.....	JS769	DRS3511.....	JS640	DRS3637.....	JS912
DRS3224.....	JS673	DRS3344.....	JS892	DRS3518.....	US857	DRS3638.....	JS913
DRS3225.....	JS675	DRS3345.....	JS779	DRS3521.....	JS312	DRS3639.....	JS917
DRS3226.....	JS734	DRS3346.....	JS771	DRS3531.....	JS338	DRS3640.....	CS351
DRS3229.....	JS730	DRS3347.....	JS775	DRS3535.....	CS977	DRS3643.....	JS918
DRS3230.....	CS316	DRS3348.....	JS772	DRS3535N.....	CS977	DRS3644.....	JS1018
DRS3233.....	JS678	DRS3349.....	JS911	DRS3541.....	JS371	DRS3645.....	JS1090
DRS3234.....	JS752	DRS3350.....	CS358	DRS3545.....	CS1111	DRS3646.....	JS1015
DRS3235.....	JS915	DRS3353.....	JS766	DRS3546.....	JS916	DRS3646.....	JS1103
DRS3237.....	JS540	DRS3354.....	JS890	DRS3547.....	JS1005	DRS3647.....	JS1019
DRS3238.....	JS654	DRS3355.....	JS755	DRS3548.....	CS727	DRS3648.....	JS943
DRS3239.....	JS667	DRS3356.....	JS763	DRS3548N.....	CS727	DRS3649.....	JS1085
DRS3240.....	CS373	DRS3357.....	JS759	DRS3551.....	JS306	DRS3650.....	CS370
DRS3243.....	JS751	DRS3358.....	JS773	DRS3553.....	CS879	DRS3653.....	JS1082
DRS3244.....	JS732	DRS3359.....	JS893	DRS3554.....	CS1183	DRS3654.....	CS684
DRS3245.....	JS552	DRS3360.....	CS329	DRS3555.....	CS796	DRS3660.....	CS510
DRS3246.....	JS677	DRS3363.....	JS728	DRS3556.....	CS1068	DRS3670.....	CS300
DRS3247.....	JS1239	DRS3364.....	JS904	DRS3557.....	CS1109	DRS3675.....	CS1168
DRS3248.....	JS754	DRS3365.....	JS905	DRS3558.....	JS939	DRS3676.....	CS1396
DRS3249.....	JS391	DRS3366.....	CS808	DRS3561.....	JS383	DRS3676.....	CS613
DRS3253.....	JS774	DRS3367.....	JS664	DRS3563.....	CS278	DRS3676N.....	CS1396
DRS3254.....	JS659	DRS3368.....	CS691	DRS3564.....	CS592	DRS3677.....	JS1350
DRS3255.....	JS655	DRS3369.....	CS798	DRS3565.....	CS123	DRS3678.....	CS1270
DRS3256.....	JS736	DRS3373.....	JS757	DRS3566.....	CS785	DRS3679.....	JS1158
DRS3257.....	JS733	DRS3374.....	JS557	DRS3567.....	CS790	DRS3679N.....	JS1158
DRS3258.....	JS669	DRS3375.....	JS758	DRS3568.....	CS961	DRS3683.....	CS1053
DRS3259.....	JS729	DRS3376.....	JS776	DRS3569.....	CS1065	DRS3684.....	CS1171
DRS3260.....	CS506	DRS3378.....	JS652	DRS3571.....	JS339	DRS3685.....	CS793
DRS3266.....	CS380	DRS3379.....	JS1023	DRS3573.....	CS1066	DRS3688.....	JS1102
DRS3267.....	CS341	DRS3380.....	CS392	DRS3574.....	JS765	DRS3689.....	CS581
DRS3268.....	CS681	DRS3383.....	JS357	DRS3575.....	JS1017	DRS3690.....	CS604
DRS3269.....	CS882	DRS3384.....	JS918	DRS3577.....	JS923	DRS3693.....	CS1210
DRS3270.....	CS592	DRS3385.....	JS663	DRS3578.....	JS1008	DRS3694.....	JS998
DRS3273.....	CS964	DRS3386.....	JS1103	DRS3579.....	JS1000	DRS3696.....	CS1173
DRS3274.....	CS796	DRS3387.....	JS894	DRS3581.....	JS356	DRS3697.....	CS975
DRS3275.....	CS782	DRS3388.....	JS894	DRS3583.....	CS1191	DRS3699.....	CS1107
DRS3276.....	JS756	DRS3389.....	JS764	DRS3585.....	CS1042	DRS3703.....	JS737
DRS3277.....	CS886	DRS3393.....	CS1046	DRS3586.....	CS1170	DRS3704.....	JS1150
DRS3279.....	JS1009	DRS3394.....	JS941	DRS3587.....	CS1191	DRS3705.....	JS1151
DRS3280.....	CS592	DRS3394N.....	JS941	DRS3588.....	CS1052	DRS3706.....	JS1147
DRS3284.....	JS777	DRS3400.....	CS376	DRS3589.....	CS1125	DRS3707.....	JS1152
DRS3285.....	CS603	DRS3403.....	CS609	DRS3590.....	CS293	DRS3708.....	JS1303
DRS3286.....	CS109	DRS3404.....	CS785	DRS3593.....	CS590	DRS3715.....	CS1182
DRS3287.....	CS994	DRS3406.....	JS1022	DRS3594.....	CS378	DRS3716.....	CS965
DRS3288.....	CS1042	DRS3407.....	CS339	DRS3595.....	JS925	DRS3717.....	CS1195
DRS3289.....	CS703	DRS3408.....	CS336	DRS3596.....	JS1003	DRS3718.....	CS1242
DRS3293.....	CS1129	DRS3409.....	CS336	DRS3597.....	JS1020	DRS3719.....	CS1049
DRS3294.....	CS694	DRS3410.....	CS350	DRS3598.....	JS1014	DRS3720.....	CS595
DRS3295.....	JS906	DRS3413.....	CS591	DRS3599.....	JS935	DRS3723.....	JS1136
DRS3296.....	JS898	DRS3420.....	CS502	DRS3600.....	CS389	DRS3724.....	JS1146
DRS3297.....	JS910	DRS3423.....	CS947	DRS3603.....	JS924	DRS3725.....	JS1096
DRS3298.....	JS899	DRS3424.....	JS641	DRS3604.....	JS1081	DRS3726.....	JS1097
DRS3299.....	JS900	DRS3425.....	CS949	DRS3605.....	JS936	DRS3727.....	JS1098
DRS3303.....	JS735	DRS3426.....	CS889	DRS3606.....	JS920	DRS3728.....	JS1139
DRS3304.....	JS1021	DRS3427.....	CS1032	DRS3607.....	JS937	DRS3729.....	JS627



O.E. NO.	HC-PARTS	O.E. NO.	HC-PARTS	O.E. NO.	HC-PARTS	O.E. NO.	HC-PARTS
DRS3730	CS191	DRS3855	JS1154	DRS3984	CS1444	DRS5178	CS990
DRS3733	JS1001	DRS3856	JS1159	DRS3985	CS1332	DRS5190	CS609
DRS3734	JS1094	DRS3857	JS1215	DRS3985N	CS1332	DRS5200	CS562
DRS3735	CS1160	DRS3858	JS1217	DRS3987	CS1438	DRS5230	CS359
DRS3736	CS1244	DRS3859	JS1220	DRS3987N	CS1438	DRS5260	CS541
DRS3737	CS1290	DRS3861	CS317	DRS3988	CS1428	DRS5270	CS721
DRS3738	CS784	DRS3863	JS1221	DRS3991	JS521	DRS5320	CS606
DRS3739	CS1207	DRS3863N	JS1221	DRS4001	JS390	DRS5341	JS359
DRS3740	CS344	DRS3864	JS1299	DRS4051	JS319	DRS5351	JS644
DRS3743	CS684	DRS3865	JS1223	DRS4061	JS645	DRS5401	CS567
DRS3744	CS1131	DRS3866	JS1233	DRS4071	JS629	DRS5420	CS1184
DRS3745	JS512	DRS3867	JS1224	DRS4081	JS354	DRS5430	CS699
DRS3746	JS1092	DRS3868	JS1225	DRS4091	JS353	DRS5470	CS574
DRS3748	JS1024	DRS3869	JS1227	DRS4141	JS344	DRS5490	CS562
DRS3749	JS1138	DRS3869N	JS1227	DRS4151	JS362	DRS5521	CS369
DRS3753	JS1022	DRS3871	CS333	DRS4191	JS345	DRS5531	CS369
DRS3755	CS1050	DRS3877	CS1241	DRS4211	JS378	DRS5540	CS555
DRS3756	JS1216	DRS3878	CS1206	DRS4221	JS513	DRS5551	CS692
DRS3758	CS1219	DRS3880	CS547	DRS4231	JS308	DRS5560	CS687
DRS3759	JS1156	DRS3884	CS1252	DRS4231	JS935	DRS5600	CS585
DRS3764	CS955	DRS3885	JS1153	DRS4261	JS649	DRS5610	CS611
DRS3773	CS1132	DRS3887	CS1379	DRS4331	JS557	DRS5630	CS375
DRS3775	CS1186	DRS3888	JS1304	DRS4332	JS558	DRS5670	CS688
DRS3776	CS1174	DRS3894	CS1338	DRS4341	JS670	DRS5701	CS561
DRS3777	CS963	DRS3895	CS1190	DRS4361	JS630	DRS5721	JS626
DRS3778	CS613	DRS3896	CS1440	DRS4451	JS669	DRS5740	CS588
DRS3787	CS21	DRS3897	CS1292	DRS4461	JS316	DRS5751	JS520
DRS3789	CS337	DRS3898	CS1285	DRS4481	JS381	DRS5781	JS661
DRS3791	CS365	DRS3899	CS1383	DRS4531	JS317	DRS5910	CS709
DRS3796	CS946	DRS3899N	CS1383	DRS4560	CS617	DRS5930	CS554
DRS3797	CS1245	DRS3903	CS1260	DRS4570	CS514	DRS5970	CS713
DRS3797N	CS1245	DRS3904	CS1273	DRS4580	CS500	DRS5981	JS633
DRS3798	JS1314	DRS3905	CS1189	DRS4590	CS542	DRS6021	JS539
DRS3799	CS971	DRS3906	CS1455	DRS4600	CS330	DRS6100	CS1167
DRS3799N	CS971	DRS3910	CS576	DRS4610	CS328	DRS6110	CS614
DRS3801	CS362	DRS3913	JS1313	DRS4620	CS548	DRS6141	CS570
DRS3803	CS1291	DRS3913N	JS1313	DRS4630	CS569	DRS6190	CS598
DRS3803N	CS1291	DRS3914	JS1238	DRS4640	CS509	DRS6200	CS1073
DRS3804	JS1229	DRS3915	JS1296	DRS4680	CS794	DRS6230	CS615
DRS3805	JS1321	DRS3916	JS1295	DRS4690	CS524	DRS6240	CS624
DRS3806	CS985	DRS3917	JS1235	DRS4700	CS374	DRS6250	CS888
DRS3807	CS1064	DRS3918	JS1306	DRS4711	CS90	DRS6280	CS727
DRS3808	CS1071	DRS3919	JS999	DRS4730	CS706	DRS6280N	CS727
DRS3809	CS1115	DRS3923	JS1234	DRS4740	CS395	DRS6290	CS618
DRS3813	CS1127	DRS3923N	JS1234	DRS4780	CS194	DRS6290	CS713
DRS3814	CS1128	DRS3924	JS1298	DRS4800	CS368	DRS6300	CS619
DRS3816	CS1192	DRS3924N	JS1298	DRS4803	CS396	DRS6310	CS616
DRS3817	CS1193	DRS3927	CS1492	DRS4810	CS559	DRS6320	CS723
DRS3818	CS1205	DRS3928	CS1378	DRS4820	CS559	DRS6330	CS612
DRS3819	CS1208	DRS3929	CS1265	DRS4820	CS601	DRS6340	CS599
DRS3821	CS366	DRS3935	JS1236	DRS4830	CS683	DRS6350	CS724
DRS3823	CS1209	DRS3940	CS371	DRS4840	CS377	DRS6370	CS531
DRS3824	CS1211	DRS3943	JS922	DRS4860	CS1183	DRS6380	CS1075
DRS3825	CS1246	DRS3944	JS660	DRS4860N	CS1183	DRS6390	CS1162
DRS3825N	CS1246	DRS3945	JS1307	DRS4861	CS535	DRS6431	JS1366
DRS3826	CS1204	DRS3946	JS1305	DRS4870	CS546	DRS6431	JS671
DRS3827	CS1247	DRS3947	CS1069	DRS4880	CS131	DRS6441	JS657
DRS3828	CS1248	DRS3948	CS1276	DRS4890	CS515	DRS6470	CS719
DRS3831	CS573	DRS3949	CS1342	DRS4900	CS516	DRS6470N	CS719
DRS3833	CS1250	DRS3955	CS1193	DRS4910	CS544	DRS6500	JS1105
DRS3834	CS1251	DRS3956	CS1336	DRS4920	CS99	DRS6520	CS198
DRS3835	CS1257	DRS3956N	CS1336	DRS4940	CS583	DRS6550	CS887
DRS3836	CS1257	DRS3957	CS1275	DRS4960	CS375	DRS6560	CS878
DRS3836N	CS1257	DRS3957N	CS1275	DRS4960	CS686	DRS6570	CS784
DRS3837	CS1257	DRS3958	CS1328	DRS4971	JS365	DRS6600	CS980
DRS3837N	CS1257	DRS3963	CS1344	DRS4991	JS640	DRS6660	CS680
DRS3838	CS1207	DRS3965	JS1155	DRS5010	CS310	DRS6700	CS620
DRS3839	CS1253	DRS3967	CS1434	DRS5021	JS397	DRS6730	JS1016
DRS3841	CS385	DRS3967N	CS1434	DRS5031	JS317	DRS6740	JS1214
DRS3843	JS1320	DRS3968	CS1341	DRS5040	CS106	DRS6750	CS597
DRS3845	JS1093	DRS3968N	CS1341	DRS5050	CS577	DRS6780	CS725
DRS3846	JS1095	DRS3969	CS1377	DRS5090	CS613	DRS6790	CS788
DRS3847	JS1099	DRS3969N	CS1377	DRS5100	US628	DRS6800	CS788
DRS3848	JS1101	DRS3971	JS376	DRS5106	US813	DRS6800	CS880
DRS3849	JS1104	DRS3975	CS961	DRS5118	US628	DRS6840	CS600
DRS3850	CS390	DRS3975N	CS961	DRS5150	CS685	DRS6860	CS802
DRS3851	JS356	DRS3976	CS1329	DRS5150N	CS685	DRS6870	CS1037
DRS3853	JS1140	DRS3977	CS1192	DRS5170	CS708	DRS6880	CS879
DRS3854	JS1143	DRS3978	CS1192	DRS5173	JS1006	DRS6880N	CS879

O.E. NO.	HC-PARTS	O.E. NO.	HC-PARTS	O.E. NO.	HC-PARTS	O.E. NO.	HC-PARTS
REMY (DELCO)	<i>Continued</i>						
DRS6890	CS372	DRS8110	CS807	DRT1060	JS1236	DRZ0163	UA939IR
DRS6900	CS1059	DRS8180	CS1172	DRT1190	CS1382	DRZ0164	UA953IR
DRS6910	CS585	DRS8210	CS322	DRT1200	CS1274	DRZ0165	UA939IR
DRS6920	CS792	DRS8230	CS592	DRT1210	CS1394	DRZ0166	UA938IR
DRS6930	CS884	DRS8240	CS329	DRT1220	CS1392	DRZ0167	UA940IR
DRS6950	CS885	DRS8250	CS350	DRT1230	CS1406	DRZ0168	UA953IR
DRS6980	CS974	DRS8270	CS1202	DRT1240	CS1334	DRZ0169	UA953IR
DRS6990	CS801	DRS8270N	CS1202	DRT1260	CS1172	DRZ0170	UA961
DRS7000	CS789	DRS8310	CS594	DRT1320	CS1072	DRZ0176	UA1210IR
DRS7020	CS973	DRS8310N	CS594	DRT1360	CS1410	DRZ0177	UA958IR
DRS7041	CS1038	DRS8340	CS1074	DRT1480	CS1399	DRZ0179	UA964IR
DRS7041N	CS1038	DRS8350	CS1188	DRT1480X	CS1399	DRZ0180	UA941IR
DRS7050	CS962	DRS8370	CS1269	DRT1490	CS1380	DRZ0182	UA955IR
DRS7060	CS1050	DRS8380	CS1165	DRT1500	CS1412	DRZ0183	UA956
DRS7060N	CS1050	DRS8380N	CS1165	DRT1500	CS1419	DRZ0184	UA957
DRS7070	CS960	DRS8390	CS1181	DRT1520	CS388	DRZ0185	UA960
DRS7070N	CS960	DRS8420	CS502	DRT1530	CS1450	DRZ0186	UA959
DRS7090	CS387	DRS8430	CS1197	DRT1560	CS1453	DRZ0187	UA962IR
DRS7110	CS1067	DRS8450	CS1212	DRT1580	CS1404	DRZ0188	UA963IR
DRS7120	CS519	DRS8460	CS1067	DRT1610	CS1423	DRZ0189	UA1214
DRS7120N	CS519	DRS8470	CS1176	DRT1630	CS1435	DRZ0190	JA1168IR
DRS7180	CS1048	DRS8480	JS1236	DRT1810	CS1421	DRZ0191	UA1115IR
DRS7190	CS1113	DRS8490	CS1203	DRT1820	CS1408	DRZ0192	UA1112IR
DRS7220	CS709	DRS8500	CS1200	DRT1910	CS1327	DRZ0195	UA967IR
DRS7230	CS376	DRS8571	CS1117	DRT2250	CS1400	DRZ0199	JA1707
DRS7240	CS1112	DRS8611	CS1055	DRT2260	CS1420	DRZ0200	CA1478IR
DRS7240N	CS1112	DRS8630	JS1226	DRT2260X	CS1420	DRZ0201	UA1213
DRS7250	CS881	DRS8680	JS1135	DRT2290	CS1409	DRZ0202	UA969
DRS7260	CS1044	DRS8770	CS1179	DRT2411	CS1379	DRZ0208	UA943IR
DRS7260N	CS1044	DRS8780	CS1274	DRT2870	CS888	DRZ0209	UA948IR
DRS7300	CS984	DRS8800	CS1199	DRX08378	CA1253IR	DRZ0210	UA948IR
DRS7320	CS1077	DRS8810	CS564	DRX67095	CS1381	DRZ5100	US628
DRS7330	CS982	DRS8830	CS1445	DRX67131	CS120	DRZ5101	US647
DRS7381	CS684	DRS8840	CS1254	DRX67149	CS1381	DRZ5102	US809
DRS7391	CS684	DRS8850	CS1075	DRZ0100	UA943IR	DRZ5104	US811
DRS7420	CS976	DRS8860	CS1255	DRZ0102	UA916	DRZ5105	US812
DRS7420N	CS976	DRS8870	CS1272	DRZ0103	UA917	DRZ5106	US813
DRS7430	CS1185	DRS8880	CS1213	DRZ0104	UA918	DRZ5108	US815
DRS7450	CS988	DRS8890	CS1256	DRZ0109	UA923IR	DRZ5109	US816
DRS7450N	CS988	DRS8910	CS1271	DRZ0110	UA924IR	DRZ5111	US818
DRS7460	CS974	DRS8911	CS1271	DRZ0111	UA925IR	DRZ5112	US819
DRS7470	CS1055	DRS8920	CS1337	DRZ0112	UA926	DRZ5115	US823
DRS7480	CS1051	DRS8930	CS1194	DRZ0113	UA927	DRZ5116	US824
DRS7490	CS1118	DRS8940	CS1187	DRZ0114	UA928	DRZ5117	US825
DRS7500	JS1135	DRS8950	CS1203	DRZ0115	UA929IR	DRZ5118	US826
DRS7510	CS1126	DRS8960	CS1198	DRZ0116	UA930IR	DRZ5119	US827
DRS7520	CS989	DRS8960N	CS1198	DRZ0118	UA932	DRZ5120	US828
DRS7530	CS986	DRS8970	CS1326	DRZ0119	UA933IR	DRZ5121	US830
DRS7530N	CS986	DRS8990	CS1243	DRZ0121	UA935IR	DRZ5122	US832
DRS7750	CS1123	DRS9000	CS191	DRZ0122	UA936IR	DRZ5123	US833
DRS7760	CS1061	DRS9020	CS1130	DRZ0123	UA937IR	DRZ5124	US868
DRS7810	CS1169	DRS9030	CS610	DRZ0128	UA942IR	DRZ5125	US835
DRS7830	CS1062	DRS9040	CS807	DRZ0129	UA943IR	DRZ5126	US815
DRS7840	CS1057	DRS9550	CS1266	DRZ0130	UA943IR	DRZ5127	US837
DRS7850	CS1163	DRS9840	CS1395	DRZ0131	UA945IR	DRZ5128	US838
DRS7860	CS269	DRS9840N	CS1395	DRZ0132	UA946IR	DRZ5129	US839
DRS7860N	CS269	DRS9890	CS1343	DRZ0133	UA947IR	DRZ5130	US840
DRS7870	CS595	DRS9980	CS984	DRZ0136	UA1212	DRZ5131	US842
DRS7880	CS1261	DRT0070	CS1267	DRZ0137	UA951	DRZ5132	US843
DRS7890	CS1072	DRT0170	CS1268	DRZ0140	UA954	DRZ5133	US844
DRS7920	CS879	DRT0220	CS1324	DRZ0141	JA787IR	DRZ5134	US845
DRS7940	CS1063	DRT0230	CS1347	DRZ0142	UA948IR	DRZ5143	US855
DRS7950	CS611	DRT0240	CS1294	DRZ0143	UA952IR	DRZ5144	US877
DRS7960	CS1180	DRT0250	CS1293	DRZ0144	UA938IR	DRZ5150	CS979
DRS7980	CS1331	DRT0260	CS1323	DRZ0145	UA1109IR	DRZ5152	US810
DRS7983	CS1449	DRT0270	CS1405	DRZ0146	UA941IR	DRZ5153	US858
DRS7990	CS1279	DRT0280	CS1286	DRZ0147	UA964IR	DRZ5155	US858
DRS7990N	CS1279	DRT0290	CS1330	DRZ0149	UA1113IR	DRZ5156	US866
DRS8010	CS519	DRT0290N	CS1330	DRZ0150	UA1113IR	DRZ5161	CS979
DRS8010N	CS519	DRT0300	CS1393	DRZ0151	UA939IR	DRZ5162	CS1036
DRS8020	CS1114	DRT0320	CS1397	DRZ0152	UA940IR	DRZ5163	JS762
DRS8030	CS1196	DRT0330	CS1322	DRZ0153	UA941IR	DRZ5164	US810
DRS8040	CS1119	DRT0350	CS1283	DRZ0154	UA938IR	DRZ5165	US860
DRS8040N	CS1119	DRT0631	JS1302	DRZ0156	UA942IR	DRZ5166	US863
DRS8060	CS1041	DRT0780	CS1282	DRZ0157	UA940IR	DRZ5167	US864
DRS8080	CS1340	DRT0860	CS1398	DRZ0158	UA938IR	DRZ5168	US857
DRS8090	CS1161	DRT0880	CS1333	DRZ0160	UA1109IR	DRZ5169	US849
DRS8090N	CS1161	DRT0890	CS1413	DRZ0161	UA941IR	DRZ5170	US859
DRS8100	CS1116	DRT0900	CS1289	DRZ0162	UA953IR	DRZ5171	US867

O.E. NO.	HC-PARTS	O.E. NO.	HC-PARTS	O.E. NO.	HC-PARTS	O.E. NO.	HC-PARTS
DRZ5172	CS1175	5001853716	CS1497	7420862899	CA1883IR	7700426849	CA1627IR
DRZ5173	JS1006	5001859572	CS1464	7420997672	CS1496	7700427476	CA1661IR
DRZ5174	US869	5001860274	CA1456IR	7485003131	CS1491	7700427880	CA1298IR
DRZ5175	US1025	5001864576	CA1947IR *	7485115899	CS1491	7700427932	CA1544IR
DRZ5176	US970	5001865233	CA2081IR *	7700100647	CS681	7700429042	CA1344IR
DRZ5177	JS942	5001866291	CA1853IR	7700101274	CA1628IR	7700429310	CA1470IR
DRZ5178	CS990	5001866377	CA898IR *	7700101279	CA1484IR	7700430181	CA1306IR
DRZ5179	US1027	5001868213	CA1880IR	7700103386	CS680	7700430182	CA1506IR
DRZ5180	US870	5001868233	CS1496	7700104209	CA1309IR	7700430183	CA1622IR
DRZ5182	US810	5001874640	CA2085IR *	7700104210	CA1307IR	7700430579	CA1622IR
DRZ5185	US877	5010050717	CA898IR	7700104344	CS1131	7700431941	CA1506IR
X16478	CS535	5010050785	CA705IR	7700104346	CS1055	7700431943	CA1653IR ▲
		5010058424	CA705IR	7700104674	CS1174	7700431944	CA1621IR
		5010058981	CS1262	7700105119	CS1174	7700431945	CA1303IR
RENAULT		5010090370	CS608	7700105333	CA1304IR	7700431946	CA1322IR
0000434120	CS310	5010090371	CS607	7700105539	CA1444IR	7700432331	CA1484IR
0025841042	CS607	5010090683	CS608	7700106209	CS684	7700433069	CA1637IR ▲
0025841044	CS608	5010090684	CS607	7700106426	CS784	7700434899	CA1544IR
0028115088	CS983	5010096027	CS688	7700106500	CA1322IR	7700434900	CA1470IR
0028115089	CS688	5010142367	CA898IR	7700106501	CA1303IR	7700436623	CA1306IR
820053977	CS1290	5010142768	CA898IR	7700106763	CS784	7700436624	CA1333IR
5000049122	CS198	5010149022	CA898IR	7700107124	CA1306IR	7700436626	CA1309IR
5000049124	CS607	5010149120	CA705IR	7700113207	CS784	7700436627	CA1333IR
5000080750	CS194	5010217010	CS1278	7700113208	CS784	7700436628	CA1319IR
5000241518	CA134	5010217215	CS544	7700113209	CS684	7700436671	CA1444IR
5000241777	CS198	5010217532	CS1128	7700113627	CS1344	7700437090	CA1976IR
5000270909	CS710	5010217533	CS983	7700115294	CS1179	7700499228	CA373IR
5000296466	CS688	5010217956	CS1251	7700115479	CS1193	7700509355	CS95
5000393154	CS333	5010217961	CA1035IR	7700116260	CS1193	7700509855	CS95
5000559361	CS607	5010235982	CA898IR	7700116282	CS1252	7700519797	CS1173
5000592182	CS194	5010235984	CA705IR	7700116282	CS1252	7700521119	CA71
5000612741	CS333	5010270136	CA1339IR	7700260505	CS280	7700523602	CA71
5000725698	CA314IR	5010306007	CA1456IR	7700260710	CS882	7700525547	CS1173
5000785288	CS688	5010306413	CS1464	7700260710	CS882	7700543483	CS95
5000785698	CA705IR	5010306506	CA1738IR	7700260898	CA815IR	7700555163	CA71
5000785715	CA721	5010306507	CA1738IR	7700260899	CA1225IR	7700561416	CS94
5000785941	CA130IR	5010306533	CS1325	7700260935	CA817IR	7700561518	CA71
5000786439	CA705IR	5010306538	CA1852IR	7700268275	CS280	7700562300	CA71
5000786512	CA721	5010306592	CS1386	7700268597	CA169IR	7700569256	CS95
5000786538	CA705IR	5010306631	CS1497	7700268805	CA268IR	7700569257	CS95
5000789048	CS194	5010306710	CA1574IR	7700268806	CA268IR	7700572689	CS315
5000790629	CS983	5010306777	CS1348	7700268997	CA268IR	7700612755	CA332IR
5000791211	CS608	5010306801	CA1456IR	7700272482	CS310	7700615359	CA71
5000791383	CS688	5010306910	CS1325	7700273783	CS1186	7700615361	CA71
5000804191	CS565	5010347544	CA1667IR	7700274178	CS1186	7700621108	CS170
5000811448	US827	5010390082	CA1667IR	7700274303	CS1186	7700621302	CS94
5001000061	CS191	5010437728	CS1491	7700274351	CS1186	7700622528	CS355
5001014133	CA705IR	5010437730	CA2082IR *	7700300407	CA1343IR	7700622529	CS355
5001014136	CA721	5010480196	CS1386	7700300408	CA1434IR	7700622748	CS170
5001014142	CA721	5010480227	CA1574IR	7700300522	CS1160	7700622951	CS95
5001014166	CA898IR	5010480435	CS1325	77003001993	CS370	7700625428	CS317
5001014169	CA705IR	5010480572	CA1947IR *	7700308989	CA1438IR	7700625429	CS317
5001014175	CA705IR	5010480765	CA2019IR *	7700313447	CS1160	7700633709	CA178IR
5001014178	CA314IR	5010480878	CA1456IR	7700315522	CS1263	7700636595	CA71
5001014181	CA314IR	5010508379	CS1348	7700348548	CA170IR	7700638420	CS95
5001014184	CA705IR	5010508380	CS1386	7700349279	CA178IR	7700650287	CS315
5001014187	CS607	5010553879	CA2081IR *	7700349578	CA268IR	7700656203	CA178IR
5001014196	CS983	5010589525	CA1853IR	7700352049	CS681	7700662371	CA165IR
5001014200	CS1127	5010589551	CA1883IR	7700377051	CS1203	7700662415	CA165IR
5001014203	CS194	5830000132	CS688	7700377091	CA1854IR	7700665496	CA169IR
5001014209	CS333	5830000632	CS688	7700377092	CA1684IR	7700665610	CA268IR
5001014215	CS194	6000547927	CA165IR	7700414371	CA1036IR	7700665611	CA169IR
5001014218	CS1262	6000559751	CS95	7700416958	CA1036IR	7700665612	CA224IR
5001014221	CS608	6001000269	CA169IR	7700416985	CA1309IR	7700665613	CS338
5001014227	CS688	6001023940	CA848IR	7700421477	CA1628IR	7700666179	CA303IR
5001014230	CS370	6001548553	CA1933IR	7700422142	CA1322IR	7700669221	CS170
5001306801	CA1456IR	6001548554	CA1881IR	7700422143	CA1303IR	7700670878	CA332IR
5001822955	CS1278	6001549062	CS1442	7700422237	CA1484IR	7700680639	CS138
5001824629	CS983	6005003153	CS1173	7700424573	CA1307IR	7700681068	CS321
5001825905	CS1127	6005701125	CS1173	7700424575	CA1331IR	7700681957	CA169IR
5001831086	CS1128	6006000076	CA314IR	7700424582	CA1309IR	7700687564	CA510IR
5001831090	CS1251	6006000435	CA1339IR	7700424583	CA1333IR	7700691736	CA106
5001833946	CA898IR	6010347544	CA1667IR	7700424584	CA1319IR	7700692744	CA510IR
5001833966	CA705IR	6025007592	CA634IR	7700424585	CA1333IR	7700694096	CS315
5001837972	CA1035IR	6025105563	CA1454IR	7700424594	CA1308IR	7700702054	CA332IR
5001847422	CA1852IR	7000315522	CS1263	7700424595	CA1309IR	7700703490	CS310
5001847428	CS1325	7420466317	CA1883IR	7700424596	CA1306IR	7700707392	CA371IR
5001849990	CS1203	7420732977	CS1495	7700424597	CA1307IR	7700709420	CA224IR
5001853707	CS1325	7420853850	CA1853IR	7700424854	CA1319IR	7700710342	CA371IR
5001853710	CS1348						

O.E. NO.	HC-PARTS	O.E. NO.	HC-PARTS	O.E. NO.	HC-PARTS	O.E. NO.	HC-PARTS
<b>RENAULT <i>Continued</i></b>							
7700710343	CA3611R	7700805873	CA5271R	7701067297	CS1160	7701489237	CA3731R
7700710373	CA6431R	7700807041	CA3751R	7701348201	CA1781R	7701489288	CA3731R
7700710963	CA3781R	7700808647	CA5351R	7701348278	CS321	7701499199	CS94
7700710964	CA2241R	7700810256	CA5571R	7701348482	CS169	7701499200	CS95
7700714313	CA3141R	7700811399	CA6341R	7701348548	CA1701R	7701499202	CS170
7700715102	CS317	7700811462	CA7161R	7701348605	CS170	7701499203	CA71
7700721797	CA3721R	7700814146	CA7161R	7701348610	CA71	7701499204	CA1691R
7700721977	CA3721R	7700814147	CA7161R	7701348746	CS94	7701499205	CA3031R
7700729300	CA3721R	7700817232	CA6051R	7701348964	CS95	7701499206	CA1781R
7700730273	CA5801R	7700820449	CA8491R	7701349063	CA1691R	7701499207	CA1701R
7700730363	CA3721R	7700820794	CA8891R	7701349263	CA2881R	7701499208	CA2241R
7700730364	CA6121R	7700827344	CA9141R	7701349264	CS310	7701499219	CS321
7700730365	CA8311R	7700847513	CA10591R	7701349311	CA106	7701499220	CS169
7700730756	CS370	7700851490	CS523	7701349313	CA3031R	7701499225	CA3611R
7700731040	CA5811R	7700851491	CS317	7701349591	CS315	7701499227	CA5121R
7700734240	CA5571R	7700852395	CA6351R	7701349592	CA5121R	7701499229	CS354
7700735712	CS684	7700852853	CS575	7701351026	CS338	7701499230	CA3721R
7700740076	CS317	7700853827	CS681	7701351027	CS310	7701499233	CS317
7700747741	CS523	7700854311	CA8181R	7701351052	CA2881R	7701499234	CS169
7700748171	CA3141R	7700854414	CA7201R	7701351120	CS280	7701499235	CA3711R
7700749023	CA8301R	7700854954	CS310	7701351390	CS681	7701499237	CA2291R
7700749226	CA8381R	7700854955	CS681	7701351391	CS354	7701499238	CA5341R
7700749770	CS280	7700855154	CA11041R	7701351392	CS354	7701499246	CS353
7700750305	CS315	7700855616	CA10331R	7701351394	CS95	7701499247	CS310
7700750306	CS315	7700856247	CA8191R	7701351399	CA6431R	7701499248	CA3781R
7700750810	CA2681R	7700856249	CA8161R	7701351757	CA5491R	7701499249	CA3721R
7700751200	CS316	7700856250	CA8211R	7701351758	CA5241R	7701499250	CA6121R
7700751336	CA3731R	7700856260	CS791	7701351759	CA5271R	7701499251	CA3751R
7700751337	CA3721R	7700856291	CS1054	7701351760	CA5271R	7701499252	CA5571R
7700751401	CA2241R	7700856856	CA10601R	7701351762	CA5261R	7701499253	CA3751R
7700751442	CA2241R	7700857073	CA10361R	7701351763	CA3731R	7701499258	CA2241R
7700751495	CS280	7700857074	CA8961R	7701351764	CA5351R	7701499259	CA5101R
7700753081	CA5121R	7700857075	CA8961R	7701351765	CA6401R	7701499288	CA5791R
7700753082	CA3731R	7700857114	CS964	7701351772	CS681	7701499433	CA2881R
7700754200	CA3321R	7700857460	CA8161R	7701352045	CA8491R	7701499434	CA2681R
7700754831	CA2241R	7700858114	CS1055	7701352047	CA6051R	7701499436	CA6491R
7700754832	CA2291R	7700858375	CS1055	7701352050	CS784	7701499437	CA5241R
7700754833	CA3781R	7700858442	CS980	7701352055	CS338	7701499438	CA6021R
7700754835	CA5261R	7700859724	CA8891R	7701352115	CA7161R	7701499440	CA5261R
7700754850	CA5351R	7700859823	CS782	7701352116	CA8181R	7701499442	CA6401R
7700754852	CA5351R	7700860466	CA12501R	7701352117	CA10331R	7701499444	CA6051R
7700757741	CS523	7700860601	CA10591R	7701352118	CA7201R	7701499447	CA1691R
7700758172	CS316	7700860915	CS784	7701352119	CA8161R	7701499448	CA3031R
7700758217	CS310	7700860976	CA10401R	7701352120	CA8211R	7701499449	CA1781R
7700758336	CA1651R	7700860977	CA13201R	7701352121	CA8191R	7701499450	CA3321R
7700759289	CS317	7700861013	CS354	7701352122	CA8151R	7701499451	CA2241R
7700759861	CS882	7700861496	CA10791R	7701352125	CA3141R	7701499452	CA3611R
7700761416	CS354	7700862613	CA10801R	7701352126	CS791	7701499454	CA3601R
7700762458	CA3171R	7700862838	CS882	7701352209	CA8891R	7701499455	CA3711R
7700764382	CA3751R	7700862865	CA10781R	7701352210	CS980	7701499456	CA2241R
7700764429	CS353	7700864606	CA9131R	7701352300	CA10591R	7701499458	CA3011R
7700764766	CA1701R	7700864608	CS1057	7701352303	CA13201R	7701499459	CA2241R
7700767420	CA3751R	7700865213	CS684	7701352304	CA10401R	7701499461	CA5571R
7700773470	CA2291R	7700865719	CS681	7701352504	CA13391R	7701499463	CA3781R
7700777478	CS354	7700865985	CS1060	7701353119	CA8161R	7701499466	CS338
7700779362	CA1701R	7700866505	CS684	7701353827	CS681	7701499468	CS315
7700780507	CA3171R	7700866507	CA10771R	7701361053	CA6431R	7701499473	CS95
7700780773	CA5341R	7700867631	CS791	7701362052	CA3141R	7701499478	CS280
7700780774	CA5791R	7700867838	CS1057	7701381525	CA2681R	7701499479	CS317
7700784482	CA6491R	7700869377	CA12001R	7701381535	CA3141R	7701499480	CS317
7700784890	CA5491R	7700869600	CA13451R	7701381629	CS333	7701499482	CS310
7700784891	CA5491R	7700870279	CA13441R	7701381632	CS94	7701499484	CS321
7700784979	CA6021R	7700870818	CA12531R	7701381633	CS95	7701499489	CA5271R
7700786409	CA5571R	7700870951	CS791	7701381640	CS280	7701499490	CA5291R
7700791211	CA3751R	7700871033	CA10771R	7701381644	CS353	7701499493	CA71
7700793594	CA5261R	7700871055	CS978	7701381647	CS370	7701499495	CA1651R
7700796221	CA5241R	7700871057	CS681	7701473614	CA18811R	7701499545	CS964
7700796488	CS681	7700872258	CA12531R	7701473660	CA17711R	7701499597	CA10771R
7700796768	CA3171R	7700872348	CA12531R	7701474326	CA18231R	7701499598	CA6071R
7700796904	CA6401R	7700875450	CS1179	7701474416	CA17621R	7701499601	CS684
7700796907	CA6341R	7700876198	CA13021R	7701475896	CA18601R	7701499604	CA10791R
7700796909	CA6401R	7700880466	CA12501R	7701476808	CA18231R	7701499605	CA8481R
7700796914	CA5351R	7700889600	CA13451R	7701476810	CA16281R	7701499607	CA12501R
7700796943	CA6121R	7701024176	CS170	7701476811	CA17711R	7701499615	CS1060
7700798995	CA6071R	7701035684	CA8951R	7701476812	CA18601R	7701499616	CS978
7700803325	CA6051R	7701035685	CA12511R	7701477001	CA18811R	7701499645	CA3721R
7700803449	CA6061R	7701042288	CA10561R	7701478093	CA17621R	7701499648	CS355
7700805158	CA6331R	7701056687	CS1207	7701489227	CA3731R	7701499649	CS315
7700805159	CA6321R	7701065384	CS1418	7701489228	CA3731R	7701499651	CS1385

O.E. NO.	HC-PARTS	O.E. NO.	HC-PARTS	O.E. NO.	HC-PARTS	O.E. NO.	HC-PARTS
7701499669	CA7161R ▲	8200107686	CA1572IR	8200495268	CA2025IR	8200849752	CA2101IR *
7701499959	CA1304IR	8200107688	CA1622IR	8200495269	CA1767IR	8200960533	CA2086IR *
7702004621	CS95	8200112065	CA1662IR	8200495278	CA1829IR	8200960536	CA1971IR
7702007262	CS95	8200120286	CA1652IR	8200495294	CA1768IR	8201049749	CA2101IR *
7702046211	CS95	8200120571	CA1622IR	8200495301	CA1645IR	8953002577	CS338
7702082972	CS980	8200121413	CA1303IR	8200495302	CA1627IR	8982775029	CA602IR
7702102137	CS95	8200122976	CA1823IR	8200495304	CA1661IR	9627267180	CS1108
7702111083	CS95	8200128426	CA1622IR ▲	8200495305	CA1814IR	9645865180	CA1388IR
7702145531	CA375IR	8200130624	CS1207	8200518409	CA1878IR	8200064465B	CS1281
7702145739	CA378IR	8200138269	CA1767IR	8200519296	CA2066IR *	ROMANIA (E/P)	
7702146495	CS575	8200143045	CS1344	8200523616	CA1881IR	DM1114	CA624
7702150654	CA549IR	8200153710	CA1829IR	8200525891	CA1936IR	DM1130	CA746
7708758173	CS316	8200153713	CA1661IR	8200537415	CA1933IR	DM1132	CA746
7709758174	CS310	8200159642	CA1622IR ▲	8200538407	CA1627IR	DM1134	CA746
7711134216	CA1298IR	8200159642	CA1622IR ▲	8200538408	CA1814IR	DM2130	CS704
7711134217	CA1302IR	8200162474	CA1627IR	8200538815	CA1645IR	DM2134	CS704
7711134257	CA1322IR	8200162474	CA1627IR	8200538816	CA1661IR	DM2138	CS240 ◆
7711134260	CS681	8200175210	CA1824IR	8200568535	CS1415	DM2140	CS95
7711134267	CA1444IR	8200182178	CS1276	8200584658	CS1273	DM2146	CS95
7711134281	CA1345IR	8200186144	CS1179	8200584664	CS1442	DM91134	CA746
7711134297	CS1344	8200186148	CS1255	8200584675	CS1332	DM92140	CS95
7711134312	CA1645IR	8200190721	CA1827IR	8200584685	CS1273	ROVER GROUP	
7711134316	CA1627IR	8200193100	CA1444IR	8200584837	CS1425	ADU7457	JS664
7711134329	CA1661IR	8200199737	CS1255	8200584843	CS1332	AMR3021	CA1380IR ▲
7711134330	CS1207	8200205612	CA1622IR	8200588648	CA2003IR	AMR4247	CA1380IR ▲
7711134530	CS1174	8200206251	CA1661IR	8200590255	CA1645IR	AMR4247E	CA1380IR ▲
7711134564	CA1628IR	8200225336	CS1207	8200621305	CS1415	AMR4248	CA1191IR
7711134603	CS1263	8200225806	CA2025IR	8200623231	CA2054IR	AMR4249	CA560IR ▲
7711134617	CA1343IR	8200227092	CS1273	8200628419	CS1193	AMR5425	CA1337IR
7711134622	CS1160	8200229907	CA1863IR	8200628426	CS1193	AMR5425E	CA1337IR
7711134753	CA1976IR	8200237594	CS1288	8200628429	CS1478	ERR5009	CS1201
7711134758	CA1662IR	8200240487	CS1442	8200628430	CS1415	ERR5445	CS378
7711134792	CS1193	8200251006	CA1877IR	8200628460	CS1207	ERR5445	CS378
7711134795	CA1253IR	8200251007	CS1332	8200634603	CS1207	ERR6999	JA1710IR
7711134926	CA1767IR	8200262462	CA1824IR	8200634604	CS1288	GEU2255	CA561IR
7711135112	CA1823IR	8200266777	CS1276	8200654541	CA1866IR	GEU4527	CS691
7711135332	CA1768IR	8200266777	CS1276	8200654785	CA1971IR	GNU2320	CA1100IR
7711135333	CA1814IR	8200285128	CS1332	8200660022	CA1877IR	GNU2327	JA753IR
7711135502	CS1288	8200290215	CA1768IR	8200660025	CA1887IR	GNU2331	CA306IR
7711135519	CA1824IR	8200290217	CA1814IR	8200660029	CA1944IR	GNU2333	CA1101IR
7711135521	CS1273	8200290220	CA1767IR	8200660033	CA1860IR	GNU2335	CA359IR
7711135812	CA1827IR	8200298371	CS1425	8200660034	CA1974IR	GNU2336	CA1651IR
7711135920	CA2082IR *	8200306595	CS1332	8200660035	CA1827IR	GNU2380	JA1129IR
7711368323	CS1207	8200323126	CA2043IR	8200660037	CA1866IR	GNU2393	CA627IR
7711497093	CA1627IR	8200323137	CA1887IR	8200660040	CA1470IR	GNU2397	JA1424IR
7711497095	CA1762IR	8200325823	CA1860IR	8200660041	CA1918IR	GNU2480	JA1405IR
7711497098	CA1823IR	8200327183	CA1944IR	8200660043	CA1878IR	GNU2520	JA1129IR
7711497099	CA1652IR	8200331251	CS1193	8200660044	CA1976IR	GNU2521	CA1488IR
7711497535	CA2098IR *	8200356669	CA1945IR	8200660045	CA1637IR	GNU2562	CA1631IR
8200018818	CS1207	8200360480	CA1860IR	8200660057	CA2086IR *	GNU2727	JA1424IR
8200019706	CA1771IR	8200363528	CA2086IR *	8200660057	CA2086IR *	GNU2728	JA1424IR
8200021396	CS1273	8200369521	CS1385	8200660518	CS1425	GNU4541	CS1270
8200021396	CS1273	8200369521	CS1385	8200667603	CA1762IR	GNU4558	JS664
8200022774	CA1881IR	8200373636	CA1652IR	8200667605	CA1484IR	GNU4595	CS579
8200030635	CA1628IR	8200385098	CA1933IR	8200667607	CA2043IR	GNU4611	CS579
8200040415	CS1193	8200386806	CA1762IR ▲	8200667607	CA2043IR	GNU4737	JS1152
8200049826	CS1174	8200390667	CA1876IR	8200667610	CA2057IR	GNU4771	CS1270
8200049826	CS1174	8200390675	CA1860IR	8200667611	CA2058IR *	GNU4773	JS648
8200050150	CS1179	8200390676	CA1974IR	8200667614	CA1975IR	GNU4814	CS610
8200054336	CS1193	8200392926	CA1304IR	8200667616	CA2025IR	GNU4900	CS610
8200054588	CA1572IR	8200399594	CS1332	8200667617	CA1767IR	GXE4527	CS691
8200054590	CA1771IR	8200402016	CS1415	8200667617	CA1767IR	NAD000090	CS1171
8200060488	CA1298IR	8200404300	CA1827IR	8200667618	CA1768IR	NAD10003	CS1270
8200060816	CA1637IR	8200404459	CA1959IR	8200667619	CA2003IR	NAD10033	CS610
8200064344	CA1637IR	8200404461	CA1936IR	8200674762	CA2098IR *	NAD100380	CS589
8200064465	CS1281	8200404461	CA1936IR	8200674762	CA2098IR *	NAD100390	CS1201
8200064685	CA1653IR	8200406207	CA1866IR	8200690190	CA1627IR	NAD10041	CS579
8200065730	CA1637IR	8200410669	CA2003IR	8200690194	CA1829IR	NAD10042	CS579
8200069377	CS1255	8200410671	CA2057IR	8200690202	CA1661IR	NAD10046	CS329
8200075362	CS1193	8200410674	CA2058IR *	8200692863	CA1544IR	NAD10050	CS1270
8200082782	CS1174	8200410674	CA2058IR *	8200692865	CA1470IR	NAD100580	JS1314
8200086130	CA1645IR	8200410681	CA1975IR	8200692868	CA1827IR	NAD100740	CS610
8200086161	CA1768IR	8200426577	CS1273	8200692869	CA1824IR	NAD100750	CS610
8200086162	CA1814IR	8200429898	CA1866IR	8200718724	CA2054IR	NAD100790	JS1149
8200096510	CS1193	8200429905	CA1878IR	8200725683	CA1936IR	NAD100810	CS579
8200100907	CA1762IR	8200438148	CA1470IR	8200726639	CA1945IR	NAD100952	JS1320
8200103726	CA1628IR	8200458765	CS1415	8200727051	CA1628IR	NAD101070	CS610
8200103744	CA1484IR	8200460883	CS1478	8200728292	CA1876IR		
8200106788	CS1207	8200466763	CS784	8200741476	CS1509		
		8200468131	CA1948IR	8200772726	CA1975IR		
		8200474219	CA1918IR	8200810621	CA2098IR		

O.E. NO.	HC-PARTS	O.E. NO.	HC-PARTS	O.E. NO.	HC-PARTS	O.E. NO.	HC-PARTS
<b>ROVER GROUP</b> <i>Continued</i>							
NAD101080.....	<b>CS610</b>	YLE102370L.....	<b>JA1723IR</b>	571506.....	<b>CA227IR</b>	71270702.....	<b>CA283</b>
NAD101090.....	<b>JS1350</b>	YLE102400.....	<b>CA1676IR</b>	571506.....	<b>CA749IR</b>	71271202.....	<b>CA30</b>
NAD101140.....	<b>JS1321</b>	YLE102420.....	<b>CA1575IR</b>	571516.....	<b>CA550IR</b>	71271402.....	<b>CA283</b>
NAD101190.....	<b>CS1049</b>	YLE102430.....	<b>CA1576IR</b>	571516.....	<b>CA748IR</b>	71312002.....	<b>CA88</b>
NAD101240.....	<b>CS1242</b>	YLE102500.....	<b>CA1631IR</b>	571518.....	<b>CA558IR</b>	71314202.....	<b>CA1048IR</b>
NAD101260.....	<b>CS610</b>	YLE102500L.....	<b>CA1631IR</b>	571520.....	<b>CA1224IR</b>	71333102.....	<b>CA166</b>
NAD101320.....	<b>CS1503</b>	YLE500170.....	<b>CA1757IR</b> ▲	571523.....	<b>CA1310IR</b>	71333202.....	<b>CA166</b>
NAD101340.....	<b>CS1253</b>	YLE500180.....	<b>CA1584IR</b>	571527.....	<b>CA1310IR</b>	71523102.....	<b>CA78</b>
NAD101410.....	<b>JS1229</b>	YLE500200.....	<b>CA1958IR</b>	571527.....	<b>CA1310IR</b>	71543102.....	<b>CA78</b>
NAD101420.....	<b>JS1350</b>	YLE500310.....	<b>CA1922IR</b>	571529.....	<b>CA1310IR</b>	71635102.....	<b>CA164</b>
NAD101420E.....	<b>JS1350</b>	YLE500400.....	<b>CA1958IR</b>	571533.....	<b>CA1650IR</b>	71635702.....	<b>CA149IR</b>
NAD101470.....	<b>CS1254</b>			571613.....	<b>CA1851IR</b>	71636202.....	<b>CA331IR</b>
NAD101471.....	<b>CS1254</b>	SAME		571614.....	<b>CA1880IR</b>	71636302.....	<b>CA331IR</b>
NAD101481.....	<b>CS1445</b>	29439660.....	<b>CA631IR</b>	571688.....	<b>CA1842IR</b>	71636402.....	<b>CA176IR</b>
NAD101490.....	<b>CS1049</b>	29619390.....	<b>CS718</b>	1105367.....	<b>CA550IR</b>	71636802.....	<b>CA331IR</b>
NAD101500.....	<b>JS1321</b>	296190900.....	<b>CS605</b>	1105367.....	<b>CA748IR</b>	71636902.....	<b>CA331IR</b>
NAD101520.....	<b>JS1350</b>			1105368.....	<b>CA1438IR</b>	71650202.....	<b>CA84</b>
NAD500080.....	<b>CS1468</b>	<b>SCANIA</b>		1117252.....	<b>CA227IR</b>	71650802.....	<b>CA106</b>
NAD500080E.....	<b>CS1468</b>	160675.....	<b>CA1224IR</b>	1117252.....	<b>CA749IR</b>	71651302.....	<b>CA84IR</b>
NAD500210.....	<b>CS1201</b>	163394.....	<b>CS98</b>	1332903.....	<b>CS1169</b>	71651502.....	<b>CA150IR</b>
NAD500270.....	<b>CS1421</b>	183868.....	<b>CS97</b>	1335929.....	<b>CS1169</b>	71651602.....	<b>CA147</b>
NAD500330.....	<b>CS1468</b>	249587.....	<b>CA75</b>	1336136.....	<b>CA1148IR</b>	71651802.....	<b>CA303IR</b>
RTC5218E.....	<b>CA628IR</b>	257592.....	<b>CA227IR</b>	1357709.....	<b>CS1061</b>	71651902.....	<b>CA170IR</b>
RTC5680N.....	<b>CA628IR</b>	257592.....	<b>CA749IR</b>	1371679.....	<b>CA1310IR</b>	71652002.....	<b>CA374IR</b>
RTC6061N.....	<b>CS589</b>	263356.....	<b>CS97</b>	1377400.....	<b>CA1310IR</b>	71652102.....	<b>CA308IR</b>
STC2227.....	<b>CA1150IR</b>	279698.....	<b>CA130IR</b>	1382290.....	<b>CS1199</b>	71652302.....	<b>CA150IR</b>
STC229.....	<b>CA126IR</b>	279698.....	<b>CA155IR</b>	1394969.....	<b>CA1148IR</b>	71652402.....	<b>CA169IR</b>
STC234.....	<b>CA628IR</b>	279699.....	<b>CA130IR</b>	1397038.....	<b>CA1744IR</b>	71652602.....	<b>CA169IR</b>
YLE000010.....	<b>JA1424IR</b>	279699.....	<b>CA155IR</b>	1404788.....	<b>CS97</b>	71652702.....	<b>CA228IR</b>
YLE000040.....	<b>CA1632IR</b>	309220.....	<b>CS121</b>	1409378.....	<b>CA1148IR</b>	71653102.....	<b>CA374IR</b>
YLE000051.....	<b>CA1584IR</b>	310563.....	<b>CS97</b>	1409379.....	<b>CA1744IR</b>	71653202.....	<b>CA308IR</b>
YLE000070.....	<b>CA1756IR</b>	326353.....	<b>CA130IR</b>	1409380.....	<b>CA1148IR</b>	71655002.....	<b>CA88</b>
YLE000260.....	<b>CA1631IR</b>	326353.....	<b>CA155IR</b>	1433688.....	<b>CA1310IR</b>	71655102.....	<b>CA104</b>
YLE10011.....	<b>CA600IR</b>	349575.....	<b>CS881</b>	1433689.....	<b>CA1310IR</b>	71655202.....	<b>CA198IR</b>
YLE10018.....	<b>CA306IR</b>	349576.....	<b>CS1040</b>	1440768.....	<b>CA1310IR</b>	71655502.....	<b>CA198IR</b>
YLE10019.....	<b>CA627IR</b>	349578.....	<b>CS121</b>	1440769.....	<b>CA1310IR</b>	71716600.....	<b>CA638IR</b>
YLE10021.....	<b>CA306IR</b>	349579.....	<b>CS1284</b>	1447911.....	<b>CS1399</b>	71770102.....	<b>CA229IR</b>
YLE10025.....	<b>CA627IR</b>	354858.....	<b>CA227IR</b>	1447912.....	<b>CS1400</b>	71770202.....	<b>CA229IR</b>
YLE10035.....	<b>CA582IR</b>	354858.....	<b>CA749IR</b>	1448150.....	<b>CA1650IR</b>	<b>SKODA</b> ➤ <b>VOLKSWAGEN</b>	
YLE10050.....	<b>CA306IR</b>	357736.....	<b>CA227IR</b>	1475569.....	<b>CA1880IR</b>	<b>SMART</b>	
YLE10065.....	<b>CA1494IR</b>	357736.....	<b>CA749IR</b>	1475570.....	<b>CA1851IR</b>	0001477V006.....	<b>CS1241</b>
YLE10066.....	<b>CA600IR</b>	371972.....	<b>CA227IR</b>	1504316.....	<b>CA1880IR</b>	0002801V003.....	<b>CA1625IR</b>
YLE10067.....	<b>CA564IR</b>	371972.....	<b>CA749IR</b>	1516176.....	<b>CA1842IR</b>	0002801V004.....	<b>CA1625IR</b>
YLE10072.....	<b>CA582IR</b>	410676.....	<b>CA227IR</b>	1516316.....	<b>CA2039IR</b>	0002801V005.....	<b>CA1734IR</b>
YLE10075.....	<b>CA1191IR</b>	410676.....	<b>CA749IR</b>	1525447.....	<b>CA1842IR</b>	0002801V006.....	<b>CA1734IR</b>
YLE10082.....	<b>CA306IR</b>	472302.....	<b>CA1667IR</b>	1774594.....	<b>CA2039IR</b>	0002801V006.....	<b>CA1734IR</b>
YLE10083.....	<b>CA1651IR</b>	475885.....	<b>CA1624IR</b>	1777299.....	<b>CA1880IR</b>	0003188V004.....	<b>CS1206</b>
YLE10088.....	<b>CA325IR</b>	0518064.....	<b>CA1851IR</b>	1777300.....	<b>CA2039IR</b>	0003188V005.....	<b>CS1206</b>
YLE10105.....	<b>CA560IR</b>	549276.....	<b>CA1310IR</b>	1796026.....	<b>CS1399</b>	0003188V006.....	<b>CS1206</b>
YLE10113.....	<b>CA1191IR</b>	571167.....	<b>CS1169</b>	2031368.....	<b>CS1399</b>	0003188V007.....	<b>CS1206</b>
YLE10124.....	<b>CA1380IR</b>	571168.....	<b>CS1061</b>	2809251.....	<b>CA1310IR</b>	0003188V008.....	<b>CS1206</b>
YLE10128.....	<b>CA1100IR</b>	571414.....	<b>CA550IR</b>	4434056.....	<b>CA1246IR</b>	0003250V007.....	<b>CA1625IR</b>
YLE10130.....	<b>CA1252IR</b>	571416.....	<b>CA1148IR</b>	<b>SEAT</b> ➤ <b>VOLKSWAGEN</b>			
YLE101500.....	<b>JA1424IR</b>	571419.....	<b>CA1624IR</b>	<b>SEV</b>			
YLE101520.....	<b>CA1318IR</b>	571420.....	<b>CS97</b>	26641.....	<b>CA100</b>	0003250V008.....	<b>CA1625IR</b>
YLE101530.....	<b>CA1487IR</b>	571427.....	<b>CS1061</b>	26642.....	<b>CA100</b>	0003250V009.....	<b>CA1734IR</b>
YLE101530.....	<b>CA1487IR</b>	571438.....	<b>CA1148IR</b>	26650.....	<b>CA114</b>	0003250V010.....	<b>CA1734IR</b>
YLE101560.....	<b>CA627IR</b>	571453.....	<b>CS881</b>	26651.....	<b>CA71</b>	0003250V011.....	<b>CA1734IR</b>
YLE101570.....	<b>CA1346IR</b>	571454.....	<b>CS1040</b>	34810.....	<b>CA100</b>	0004717V005.....	<b>CA2024IR</b>
YLE101580.....	<b>CA564IR</b>	571461.....	<b>CS1284</b>	70220002.....	<b>CA71</b>	0004717V006.....	<b>CA2024IR</b>
YLE101640.....	<b>CA126IR</b>	571462.....	<b>CS1169</b>	71212002.....	<b>CA55</b>	Q0002801V003000000.....	<b>CA1625IR</b>
YLE101650.....	<b>JA1425IR</b>	571463.....	<b>CS1061</b>	71212202.....	<b>CA55</b>	Q0002801V004000000.....	<b>CA1625IR</b>
YLE101730.....	<b>JA1405IR</b>	571464.....	<b>CS1199</b>	71212302.....	<b>CA104</b>	Q0002801V005000000.....	<b>CA1734IR</b>
YLE101790.....	<b>CA1488IR</b>	571467.....	<b>CS1399</b>	71212402.....	<b>CA55</b>	Q0002801V006000000.....	<b>CA1734IR</b>
YLE101840.....	<b>CA1100IR</b>	571468.....	<b>CS1400</b>	71212602.....	<b>CA104</b>	Q0002801V006000000.....	<b>CS1206</b>
YLE101850.....	<b>CA1252IR</b>	571474.....	<b>CA1842IR</b>	71212402.....	<b>CA55</b>	Q0003188V004000000.....	<b>CS1206</b>
YLE101870.....	<b>CA1651IR</b>	571475.....	<b>CA1842IR</b>	71212602.....	<b>CA104</b>	Q0003188V005000000.....	<b>CS1206</b>
YLE101880.....	<b>CA1252IR</b>	571497.....	<b>CA1624IR</b>	71212702.....	<b>CA283</b>	Q0003188V007000000.....	<b>CS1206</b>
YLE101890.....	<b>CA2074IR</b> *	571498.....	<b>CA1148IR</b>	71226202.....	<b>CA106</b>	Q0003188V008000000.....	<b>CS1206</b>
YLE101971.....	<b>JA1723IR</b>	571499.....	<b>CA1744IR</b>	71226802.....	<b>CA114</b>	Q0003250V007000000.....	<b>CA1625IR</b>
YLE102010.....	<b>JA1425IR</b>	571500.....	<b>CA130IR</b>	71228102.....	<b>CA71</b>	Q0003250V008000000.....	<b>CA1625IR</b>
YLE102020.....	<b>CA1631IR</b>	571500.....	<b>CA155IR</b>	71228602.....	<b>CA114</b>	Q0003250V009000000.....	<b>CA1734IR</b>
YLE102060.....	<b>CA2075IR</b> *	571501.....	<b>CA130IR</b>	71229002.....	<b>CA114</b>	Q0003250V010000000.....	<b>CA1734IR</b>
YLE102200.....	<b>CA560IR</b> ▲	571501.....	<b>CA155IR</b>	71229502.....	<b>CA71</b>	Q0003250V011000000.....	<b>CA1734IR</b>
YLE102270.....	<b>JA1608IR</b>	571501.....	<b>CA155IR</b>	71230202.....	<b>CA106</b>	<b>SSANG YONG</b>	
YLE102280.....	<b>JA1723IR</b>	571503.....	<b>CA130IR</b>	71231002.....	<b>CA106</b>	0091543002.....	<b>CA1062IR</b>
YLE102290.....	<b>JA1608IR</b>	571503.....	<b>CA155IR</b>	71231102.....	<b>CA304</b>	1621543002.....	<b>CA1057IR</b>
YLE102330.....	<b>JA1596IR</b>	571505.....	<b>CA227IR</b>	71270002.....	<b>CA100</b>	6611513101.....	<b>CS331</b>
YLE102360.....	<b>JA1608IR</b>	571505.....	<b>CA749IR</b>	71270202.....	<b>CA100</b>	6611513201.....	<b>CS331</b>
				71270302.....	<b>CA100</b>		

O.E. NO.	HC-PARTS	O.E. NO.	HC-PARTS	O.E. NO.	HC-PARTS	O.E. NO.	HC-PARTS
6611513401.....	<b>CS331</b>	23700-AA150 .....	<b>JA695IR</b>	31100-60B51.....	<b>JS512</b>	31100-84EC0 .....	<b>CS1334</b>
6611513501.....	<b>CS331</b>	23700-AA160 .....	<b>JA108IR</b>	31100-60G10.....	<b>JS512</b>	31100-85010 .....	<b>JS758</b>
6611513901.....	<b>CS331</b>	23700-AA202 .....	<b>JA1407IR</b>	31100-60G11.....	<b>JS512</b>	31100-85020 .....	<b>JS758</b>
6621543202.....	<b>CA1685IR</b>	23700-AA210 .....	<b>JA1713IR</b>	31100-62030 .....	<b>JS512</b>	31100-85291 .....	<b>JS387</b>
6621543202.....	<b>CA1685IR</b>	23700-AA210F .....	<b>JA1713IR</b>	31100-63J00.....	<b>JS1310</b>	31100-85E00 .....	<b>CS1334</b>
A1621543002.....	<b>CA1057IR</b>	23700-AA211.....	<b>JA1713IR</b>	31100-64B12.....	<b>JS1092</b>	31100-86030 .....	<b>JS1092</b>
A6621543202.....	<b>CA1685IR</b>	23700-AA211F .....	<b>JA1713IR</b>	31100-64B13.....	<b>JS1092</b>	31100-86032 .....	<b>JS1092</b>
A6621543202.....	<b>CA1685IR</b>	23700-AA220 .....	<b>JA1713IR</b>	31100-64G00.....	<b>JS512</b>	31100-86033 .....	<b>JS1092</b>
		23700-AA230 .....	<b>JA1407IR</b>	31100-65DA0 .....	<b>JS1153</b>	31100-860D2.....	<b>JS1092</b>
STEYR → MERCEDES BENZ		23700-AA270 .....	<b>JA1713IR</b>	31100-65G00.....	<b>CS1504</b>	31100-86130 .....	<b>JS512</b>
SUBARU		23700-AA280 .....	<b>JA1407IR</b>	31100-65J10.....	<b>CS1487</b>	31100-86CB1 .....	<b>CS373</b>
23300-KA010 .....	<b>JS557</b>	23700-AA290 .....	<b>JA1407IR</b>	31100-67D10.....	<b>JS1153</b>	31100-86G00.....	<b>JS1310</b>
23300-KA020 .....	<b>JS557</b>	23700-AA34A .....	<b>JA1713IR</b>	31100-67D20.....	<b>JS1153</b>	31100-92330 .....	<b>JS512</b>
23300-KA030 .....	<b>JS558</b>	23700-AA350 .....	<b>JA1713IR</b>	31100-67J00.....	<b>CS1193</b>	31100-A83010 .....	<b>JS380</b>
23300-KA031 .....	<b>JS558</b>	23700-AA36A .....	<b>JA1713IR</b>	31100-68D00.....	<b>CS1444</b>	31100-A83031 .....	<b>JS380</b>
23300-KA031 .....	<b>JS558</b>	23700-AA370 .....	<b>JA1704IR</b>	31100-73010 .....	<b>JS330</b>	31100-M70F00 .....	<b>JS512</b>
23300-KA032 .....	<b>JS558</b>	23700-AA380 .....	<b>CA2083IR</b> *	31100-73030 .....	<b>JS330</b>	31100-M79F00 .....	<b>JS512</b>
23300-KA032 .....	<b>JS558</b>	23700-AA390 .....	<b>JA1704IR</b>	31100-73031 .....	<b>JS394</b>	31100-M81110 .....	<b>JS630</b>
23300-KA040 .....	<b>JS558</b>	23700-AA420 .....	<b>CA2083IR</b> *	31100-73033 .....	<b>JS394</b>	31100-M82011.....	<b>JS512</b>
23300-KA120 .....	<b>JS557</b>	23700-AA430 .....	<b>JA1704IR</b>	31100-73034 .....	<b>JS394</b>	31100-M82012 .....	<b>JS512</b>
23300-KA140 .....	<b>JS557</b>	23700-AA450 .....	<b>CA2083IR</b> *	31100-73035 .....	<b>JS394</b>	31100-M82013 .....	<b>JS512</b>
23300-KA190 .....	<b>JS557</b>	23700-AA520 .....	<b>CA2084IR</b> *	31100-73036 .....	<b>JS394</b>	31100-M82020 .....	<b>JS512</b>
23300-KA210 .....	<b>JS557</b>	23700-AA521 .....	<b>CA2084IR</b> *	31100-73071 .....	<b>JS330</b>	31100-M82020 .....	<b>JS512</b>
23300-KA220 .....	<b>JS557</b>	23700-AA540 .....	<b>CA2083IR</b> *	31100-73090 .....	<b>JS330</b>	31100-M82021 .....	<b>JS512</b>
23300-KA221 .....	<b>JS557</b>	32990-0100 .....	<b>JA100</b>	31100-75F00 .....	<b>CS1210</b>	31100-M86J01.....	<b>CS1334</b>
23300-KA250 .....	<b>JS557</b>	32990-5300 .....	<b>JA119</b>	31100-75F01 .....	<b>CS1210</b>	31400-50G10 .....	<b>JA682IR</b>
23300-KA270 .....	<b>JS557</b>	32990-5310 .....	<b>JA119</b>	31100-75F10 .....	<b>CS1210</b>	31400-50G10 .....	<b>JA682IR</b>
23300-KA280 .....	<b>JS557</b>	42990-5600 .....	<b>JA1711R</b>	31100-77E10.....	<b>JS1153</b>	31400-52D10 .....	<b>JA1356IR</b>
23300-KA290 .....	<b>JS557</b>	42990-6001 .....	<b>JA652IR</b>	31100-77E11.....	<b>JS1153</b>	31400-60A00.....	<b>JA682IR</b>
23300-KA370 .....	<b>JS557</b>	42990-6100 .....	<b>JA652IR</b>	31100-77E20.....	<b>JS1153</b>	31400-60A10.....	<b>JA682IR</b>
23300-AA000 .....	<b>JS393</b>	42990-6300 .....	<b>JA1711R</b> ▲	31100-77E22.....	<b>JS1153</b>	31400-60A11.....	<b>JA682IR</b>
23300-AA010 .....	<b>JS373</b>	42990-6400 .....	<b>JA652IR</b>	31100-77E90.....	<b>JS365</b>	31400-60A11.....	<b>JA682IR</b>
23300-AA020 .....	<b>JS670</b>	42990-6500 .....	<b>JA652IR</b> ▲	31100-78010 .....	<b>JS372</b>	31400-60A20.....	<b>JA682IR</b>
23300-AA030 .....	<b>JS393</b>	42990-6600 .....	<b>JA652IR</b>	31100-78021 .....	<b>JS630</b>	31400-60A21.....	<b>JA682IR</b>
23300-AA031 .....	<b>JS393</b>	42990-7000 .....	<b>JA119</b>	31100-78480 .....	<b>JS348</b>	31400-60A21.....	<b>JA682IR</b>
23300-AA040 .....	<b>JS373</b>	42990-7010 .....	<b>JA119</b>	31100-78611.....	<b>JS387</b>	31400-60AC0.....	<b>JA682IR</b>
23300-AA050 .....	<b>JS670</b>	42990-7020 .....	<b>JA119</b>	31100-79610 .....	<b>JS387</b>	31400-60AC1.....	<b>JA682IR</b>
23300-AA100 .....	<b>JS558</b>	42990-7040 .....	<b>JA197IR</b>	31100-79611.....	<b>JS387</b>	31400-60B11.....	<b>JA798IR</b> ▲
23300-AA180 .....	<b>JS373</b>	42990-7050 .....	<b>JA197IR</b>	31100-79611.....	<b>JS387</b>	31400-60B31.....	<b>JA682IR</b>
23300-AA190 .....	<b>JS670</b>	42990-7100 .....	<b>JA197IR</b>	31100-79620 .....	<b>JS758</b>	31400-60B40.....	<b>JA798IR</b>
23300-AA200 .....	<b>JS671</b>	42990-7110 .....	<b>JA197IR</b>	31100-79621 .....	<b>JS758</b>	31400-60B50.....	<b>JA682IR</b>
23300-AA210 .....	<b>JS670</b>	42990-7110 .....	<b>JA119</b>	31100-79628 .....	<b>JS758</b>	31400-60C10.....	<b>JA869IR</b>
23300-AA220 .....	<b>JS671</b>	42990-7300 .....	<b>JA119</b>	31100-79630 .....	<b>JS387</b>	31400-60C11.....	<b>JA869IR</b>
23300-AA221 .....	<b>JS671</b>	42990-7330 .....	<b>JA109IR</b>	31100-79631 .....	<b>JS387</b>	31400-60E10.....	<b>JA682IR</b>
23300-AA230 .....	<b>JS757</b>	42990-7340 .....	<b>JA109IR</b>	31100-79650 .....	<b>JS387</b>	31400-60E11.....	<b>JA682IR</b>
23300-AA231 .....	<b>JS757</b>	42990-7400 .....	<b>JA109IR</b>	31100-79650 .....	<b>JS387</b>	31400-60G10.....	<b>JA1293IR</b>
23300-AA270 .....	<b>JS1366</b>	42990-7600 .....	<b>JA197IR</b>	31100-79661 .....	<b>JS387</b>	31400-60G11.....	<b>JA1293IR</b>
23300-AA280 .....	<b>JS1366</b>	42990-7800 .....	<b>JA197IR</b> ▲	31100-79680 .....	<b>JS387</b>	31400-60G12.....	<b>JA1293IR</b>
23300-AA300 .....	<b>JS670</b>	42991-5900 .....	<b>JS558</b>	31100-79F00 .....	<b>JS512</b>	31400-60G13.....	<b>JA1293IR</b>
23300-AA380 .....	<b>JS1366</b>	42991-6100 .....	<b>JS558</b>	31100-79J00.....	<b>CS1335</b>	31400-63BD1.....	<b>JA682IR</b> ▲
23300-AA381 .....	<b>JS1366</b>	42991-6200 .....	<b>JS557</b>	31100-80091 .....	<b>JS394</b>	31400-65D00.....	<b>CA2026IR</b> *
23300-AA390 .....	<b>JS670</b>	42991-6400 .....	<b>JS557</b>	31100-80092 .....	<b>JS394</b>	31400-65G00.....	<b>CA1043IR</b>
23300-AA390 .....	<b>JS670</b>	42991-6500 .....	<b>JS557</b>	31100-80094 .....	<b>JS394</b>	31400-65J10 .....	<b>CA2004IR</b>
23300-AA420 .....	<b>JS1366</b>	42991-6710 .....	<b>JS557</b>	31100-80E00.....	<b>JS512</b>	31400-66010 .....	<b>JA118</b>
23300-AA450 .....	<b>JS1366</b>	42991-7000 .....	<b>JS348</b>	31100-80E10.....	<b>JS512</b>	31400-66D00.....	<b>JA1612IR</b>
23300-AA560 .....	<b>JS1366</b>	42991-7100 .....	<b>JS393</b>	31100-80G0.....	<b>JS1310</b>	31400-66D01.....	<b>JA1612IR</b>
23700-KA000 .....	<b>JA652IR</b>	42991-7110 .....	<b>JS393</b>	31100-80G00.....	<b>JS1310</b>	31400-66D02.....	<b>JA1612IR</b>
23700-KA020 .....	<b>JA652IR</b> ▲	42991-7120 .....	<b>JS393</b>	31100-80G10.....	<b>JS1319</b>	31400-66D10.....	<b>JA1293IR</b>
23700-KA021 .....	<b>JA652IR</b>	42991-7130 .....	<b>JS393</b>	31100-80X51.....	<b>JS394</b>	31400-66D11.....	<b>JA1293IR</b>
23700-KA030 .....	<b>JA652IR</b>	42991-7210 .....	<b>JS373</b>	31100-81010 .....	<b>JS630</b>	31400-67J00 .....	<b>CA1991IR</b> *
23700-KA031 .....	<b>JA652IR</b>	42991-7220 .....	<b>JS373</b>	31100-82010 .....	<b>JS512</b>	31400-68D02.....	<b>CA1553IR</b>
23700-KA110 .....	<b>JA652IR</b>	42991-7300 .....	<b>JS670</b>	31100-82011.....	<b>JS512</b>	31400-70010 .....	<b>JA118</b>
23700-KA120 .....	<b>JA652IR</b> ▲	42991-7310 .....	<b>JS670</b>	31100-82016.....	<b>JS512</b>	31400-70D00.....	<b>JA869IR</b>
23700-KA130 .....	<b>JA652IR</b>	42991-7500 .....	<b>JS670</b>	31100-82021.....	<b>JS380</b>	31400-70D10.....	<b>JA869IR</b>
23700-KA150 .....	<b>JA652IR</b> ▲	42991-7700 .....	<b>JS348</b>	31100-82030.....	<b>JS512</b>	31400-70D11.....	<b>JA869IR</b>
23700-KA151 .....	<b>JA652IR</b>	42991-AA010.....	<b>JS373</b>	31100-820D1.....	<b>JS512</b>	31400-70F60.....	<b>JA798IR</b>
23700-KA230 .....	<b>JA774IR</b>	82990-6110 .....	<b>JA100</b>	31100-82610.....	<b>JS512</b>	31400-71310.....	<b>JA118</b>
23700-KA240 .....	<b>JA774IR</b>	82991-6100 .....	<b>JS372</b>	31100-82612.....	<b>JS512</b>	31400-71C10.....	<b>JA682IR</b>
23700-KA250 .....	<b>JA774IR</b> ▲	82991-8600 .....	<b>JS372</b>	31100-826A0.....	<b>JS512</b>	31400-71C20.....	<b>JA682IR</b>
23700-KA270 .....	<b>JA774IR</b>			31100-826A1.....	<b>JS512</b>	31400-71C30.....	<b>JA682IR</b>
23700-KA360 .....	<b>JA774IR</b>	SUZUKI		31100-83010.....	<b>JS380</b>	31400-71C50.....	<b>JA798IR</b>
23700-KA470 .....	<b>JA774IR</b>	31000-82631 .....	<b>JS512</b>	31100-83011.....	<b>JS380</b>	31400-72010.....	<b>JA118</b>
23700-KA480 .....	<b>JA774IR</b>	31000-85010 .....	<b>JS758</b>	31100-83020.....	<b>JS380</b>	31400-72011.....	<b>JA118</b>
23700-AA000 .....	<b>JA109IR</b>	31100-51A90.....	<b>JS630</b>	31100-83030.....	<b>JS380</b>	31400-73J00 .....	<b>CA1674IR</b>
23700-AA020 .....	<b>JA109IR</b>	31100-60A10.....	<b>JS380</b>	31100-83031.....	<b>JS380</b>	31400-74010.....	<b>JA118</b>
23700-AA030 .....	<b>JA109IR</b>	31100-60A12.....	<b>JS380</b>	31100-83421.....	<b>JS380</b>	31400-75110.....	<b>JA157</b>
23700-AA040 .....	<b>JA197IR</b>	31100-60A13.....	<b>JS380</b>	31100-83E00.....	<b>JS512</b>	31400-75F00.....	<b>JA1612IR</b>
23700-AA050 .....	<b>JA695IR</b>	31100-60AB2.....	<b>JS380</b>	31100-84350.....	<b>JS630</b>	31400-75F01.....	<b>JA1612IR</b>
23700-AA090 .....	<b>JA698IR</b>	31100-60AC2.....	<b>JS380</b>	31100-84A00.....	<b>CS1273</b>	31400-75F50.....	<b>JA1293IR</b>

O.E. NO.	HC-PARTS	O.E. NO.	HC-PARTS	O.E. NO.	HC-PARTS	O.E. NO.	HC-PARTS
<b>SUZUKI Continued</b>				<b>TOYOTA</b>			
31400-77E10.....	JA1356IR	8545758.....	CA310IR	27020-0B805.....	JA167IR	27020-26051.....	JA131
31400-77E11.....	JA1356IR	8545873.....	CS89	27020-10110-71.....	JA137	27020-26060.....	JA137
31400-77E12.....	JA1356IR	8545881.....	CS89	27020-10940.....	JA791	27020-26061.....	JA137
31400-77E20.....	JA1293IR ▲	8548240.....	CA566IR	27020-12011.....	JA130	27020-26080.....	JA131
31400-77E21.....	JA1293IR ▲	8548943.....	CA1138IR	27020-12012.....	JA130	27020-26090.....	JA131
31400-77E22.....	JA1293IR ▲	8548950.....	CA1070IR	27020-12030.....	JA130	27020-26100.....	JA131
31400-77E23.....	JA1293IR ▲	8549412.....	CA1070IR	27020-12040.....	JA137	27020-26110.....	JA137
31400-77E24.....	JA1293IR	8549438.....	CA1138IR	27020-13010.....	JA131	27020-26111.....	JA137
31400-77E90.....	JA1430IR	8549552.....	CA1555IR	27020-13013.....	JA131	27020-26121.....	JA137
31400-78010.....	JA118	8557076.....	CA207IR	27020-13020.....	JA137	27020-26150.....	JA131
31400-78210.....	JA118	8559742.....	CA207IR	27020-13021.....	JA137	27020-26151.....	JA131
31400-78430.....	JA155	8567570.....	CA207IR	27020-13022.....	JA137	27020-27011.....	JA114
31400-78431.....	JA155	8571838.....	CA207IR	27020-13030.....	JA118	27020-29010.....	JA131
31400-78432.....	JA155	8572703.....	CA207IR	27020-13040.....	JA134	27020-31010.....	JA131
31400-79J00.....	JA1293IR	8577694.....	CA207IR	27020-13050.....	JA131	27020-31011.....	JA131
31400-79J00.....	CA1995IR	8577694.....	CA207IR	27020-13060.....	JA131	27020-31020.....	JA130
31400-80010.....	JA171IR	8586059.....	CA566IR	27020-13070.....	JA131	27020-31030.....	JA130
31400-80011.....	JA171IR	8597924.....	CA310IR	27020-13080.....	JA131	27020-31031.....	JA130
31400-80E00.....	JA798IR	8823254.....	CA207IR	27020-13110.....	JA139	27020-31032.....	JA130
31400-80G00.....	JA1293IR	8826851.....	CS878	27020-13140.....	JA139	27020-31033.....	JA130
31400-80G01.....	JA1803IR	8828238.....	CS372	27020-13160.....	JA139	27020-31040.....	JA131
31400-80G10.....	JA1803IR	8828972.....	CS802	27020-13170.....	JA139	27020-31041.....	JA131
31400-80G10A0T0.....	JA1803IR	9000952.....	CS1291	27020-13210.....	JA131	27020-31042.....	JA131
31400-81030.....	JA652IR ◆	9120965.....	CA566IR	27020-13220.....	JA131	27020-31043.....	JA131
31400-81A00.....	JA1612IR	9376799.....	CS346	27020-13240.....	JA137	27020-31050.....	JA130
31400-82110.....	JA802IR	9506221.....	CA310IR	27020-13290.....	JA131	27020-31051.....	JA130
31400-82111.....	JA802IR	9506353.....	CA567IR	27020-15010.....	JA138	27020-31071.....	JA131
31400-82610.....	JA188IR	9526005.....	CA567IR	27020-15020.....	JA138	27020-31080.....	JA157 ▲
31400-82611.....	JA188IR	9529033.....	CA567IR	27020-15021.....	JA138	27020-31090.....	JA130 ▲
31400-82630.....	JA652IR	9544537.....	CS976	27020-15022.....	JA138	27020-31110.....	JA137
31400-82631.....	JA652IR	9555285.....	CA566IR	27020-15030.....	JA138	27020-31111.....	JA137
31400-83010.....	JA188IR	9560954.....	CA566IR	27020-15110.....	JA687	27020-31120.....	JA137
31400-83E00.....	JA1293IR	9562752.....	CA566IR	27020-15120.....	JA687	27020-32011.....	JA131
31400-84E00.....	CA1943IR *	12755484.....	CA1916IR	27020-15140.....	JA138	27020-33010.....	JA131
31400-84E01.....	CA1943IR *	12757362.....	CA2068IR *	27020-16030.....	JA140	27020-33011.....	JA131
31400-84E10.....	CA2026IR *	12757363.....	CA1916IR	27020-16040.....	JA140	27020-33020.....	JA131
31400-85510.....	JA652IR	12759595.....	CA1952IR	27020-18010.....	JA131	27020-33021.....	JA131
31400-85E00.....	CA1862IR	12762730.....	CA1740IR	27020-18011.....	JA131	27020-33022.....	JA131
31400-86010.....	JA188IR	12770124.....	CA1961IR	27020-21010.....	JA131	27020-33030.....	JA131
31400-86510.....	JA798IR	55352105.....	CS1291	27020-21011.....	JA131	27020-33036.....	JA131
31400-86520.....	JA682IR	55352882.....	CS1428	27020-22010.....	JA130	27020-33040.....	JA131
31400-86521.....	JA682IR	55353669.....	CS1488	27020-22012.....	JA130	27020-34010.....	JA137 ▲
31400-86G00.....	CA2077IR *	55353996.....	CS1291	27020-22020.....	JA130	27020-34012.....	JA137
31400-M70F60.....	JA798IR	93184956.....	CA1246IR	27020-22021.....	JA130	27020-34020.....	JA137
31400-M79G00.....	JA1293IR	<b>THERMO KING</b>		27020-22022.....	JA130	27020-34021.....	JA140 ▲
32A66-00600.....	JS1009	1E32215G01.....	CA1082IR	27020-23011.....	JA130	27020-34030.....	JA131
32A66-10101.....	JS1009	20-44-3325.....	UA917	27020-23012.....	JA130	27020-34031.....	JA131
32A66-20601.....	JS1009	2D72786G01.....	UA934IR	27020-23021.....	JA130	27020-34050.....	JA137
<b>SAAB</b>				27020-23022.....	JA130	27020-34051.....	JA137
513088.....	CA1246IR	2D72787G01.....	UA935IR	27020-23023.....	JA130	27020-36021.....	JA131
4070428.....	CS372	2D72787G02.....	UA935IR	27020-23024.....	JA130	27020-36041.....	JA131
4235610.....	CS372	4006D20G01.....	UA917	27020-23025.....	JA130	27020-36042.....	JA131
4412805.....	CA1070IR	4117D21G01.....	UA922	27020-23026.....	JA130	27020-36043.....	JA131
4670428.....	CS372	4117D21G02.....	UA922	27020-23027.....	JA130	27020-36044.....	JA131
4739066.....	CA1070IR	44-3325.....	UA917	27020-23028.....	JA130	27020-36045.....	JA131
4941761.....	CA1555IR	44-6257.....	UA922	27020-23029.....	JA130	27020-36060.....	JA131
4966842.....	CS372	44-6266.....	UA922	27020-24010.....	JA130	27020-36061.....	JA131
4966842.....	CS372	44-7155.....	UA934IR	27020-24020.....	JA130	27020-36070.....	JA131
4966847.....	CS372	44-7156.....	UA935IR	27020-24021.....	JA130	27020-36071.....	JA131
5194758.....	CS727	44-7927.....	UA935IR	27020-24030.....	JA137	27020-36080.....	JA131
5246871.....	CA1138IR	44-8091.....	UA934IR	27020-24031.....	JA131	27020-37071.....	JA137
5246897.....	CA1555IR	44-8901.....	UA931IR	27020-24040.....	JA131	27020-38011.....	JA131
5248372.....	CA1683IR	44-8904.....	UA935IR	27020-24061.....	JA131	27020-38012.....	JA130
5470513.....	CA1828IR	44-8939.....	UA934IR	27020-24062.....	JA131	27020-38020.....	JA137
7532153.....	CS346	44-8950.....	CA1082IR	27020-24063.....	JA137	27020-38021.....	JA137
8309643.....	CS89	44-9571.....	CA1082IR	27020-24070.....	JA131	27020-38031.....	JA131
8319618.....	CS89	44-9575.....	CA1082IR	27020-24080.....	JA137	27020-38040.....	JA137
8523254.....	CA207IR	44-9750.....	UA934IR	27020-24081.....	JA137	27020-38041.....	JA137
8540684.....	CA207IR	44-9751.....	UA934IR	27020-24082.....	JA137	27020-38042.....	JA131
8545592.....	CA207IR	44-9752.....	UA934IR	27020-24090.....	JA130	27020-38120.....	JA131
8545642.....	CA207IR	44-9753.....	UA935IR	27020-24100.....	JA134	27020-39020.....	JA131
8545659.....	CA207IR	44-9754.....	UA934IR	27020-24101.....	JA134	27020-40060.....	JA131
8545667.....	CA592IR	44-9755.....	UA935IR	27020-24102.....	JA134	27020-40061.....	JA131
8545675.....	CA310IR	44-9755.....	UA935IR	27020-24110.....	JA134	27020-40062.....	JA131
8545683.....	CS346	5D33839G01.....	CA1082IR	27020-25010.....	JA131	27020-41032.....	JA131
8545691.....	CS346	5D35741G01.....	UA931IR	27020-25021.....	JA131	27020-41033.....	JA131
8545725.....	CA567IR	5D35741G03.....	UA931IR	27020-25105.....	JA134	27020-41034.....	JA131
8545741.....	CA566IR	5D38603G01.....	CA1082IR	27020-26021.....	JA131	27020-41061.....	JA137
				27020-26022.....	JA131	27020-44021.....	JA131 ▲
				27020-26031.....	JA131	27020-44030.....	JA131
				27020-26032.....	JA131	27020-44033.....	JA131 ▲
				27020-26040.....	JA131	27020-44042.....	JA131
				27020-26050.....	JA131		



O.E. NO.	HC-PARTS	O.E. NO.	HC-PARTS	O.E. NO.	HC-PARTS	O.E. NO.	HC-PARTS
27020-45031	JA144	27030-54261	JA777	27060-02070	JA987IR	27060-15130	JA976IR
27020-54021	JA149	27030-54262	JA777	27060-02100	JA987IR	27060-15140	JA976IR
27020-54040	JA149	27030-54263	JA777	27060-03010	JA885IR	27060-16010	JA142IR
27020-54150	JA799IR	27030-56011	JA651	27060-03040	JA1134IR	27060-16011	JA142IR
27020-54160	JA193	27030-56012	JA651	27060-03070	JA1599IR	27060-16012	JA142IR
27020-54210	JA193	27030-56013	JA651	27060-04010	CA1067IR	27060-16040	JA189IR
27020-54250	JA777	27030-56031	JA651	27060-0B010	JA1377IR	27060-16041	JA161IR
27020-54383	JA1270	27030-56032	JA651	27060-0D020	JA1605IR	27060-16042	JA189IR
27020-56110	JA676	27030-56080	JA676	27060-0D030	JA1605IR	27060-16050	JA142IR
27020-56180	JA982	27030-56090	JA676	27060-0D140	JA1894IR	27060-16051	JA142IR
27020-56220	JA800	27030-56150	JA982	27060-0D160	JA1605IR	27060-16060	JA161IR
27020-56230	JA676	27030-56220	JA676	27060-0D170	JA1894IR	27060-16080	JA996IR
27020-56320	JA1124	27030-56250	JA676	27060-0D190	JA1894IR	27060-16081	JA996IR
27020-57091	JA800	27030-56320	JA1124	27060-0D191	JA1894IR	27060-16082	JA996IR
27020-60031	JA176	27030-56340	JA676	27060-0D300	JA1894IR	27060-16090	JA142IR
27020-60032	JA176	27030-57081	JA800	27060-0G011	CA1965IR *	27060-16091	JA142IR
27020-60033	JA176	27030-57091	JA800	27060-0H070	CA1907IR	27060-16122	JA552IR
27020-60070	JA131	27030-64010	JA143	27060-0J010	JA1809IR	27060-16141	JA161IR
27020-60071	JA176	27030-64050	JA196	27060-0J020	JA1800IR	27060-16151	JA142IR
27020-60072	JA176	27030-64111	JA656	27060-0J030	JA1809IR	27060-16160	JA552IR
27020-60073	JA176	27030-64120	JA656	▲ 27060-0J040	JA1800IR	27060-16170	JA552IR
27020-61033	JA176	27030-64130	JA656	27060-0J051	CA1929IR *	27060-16180	JA996IR
27020-61110	JA137	▲ 27030-64140	JA656	27060-0J061	CA1942IR *	27060-16190	JA996IR
27020-61150	JA176	27030-64170	JA1362	27060-0L020	JA1796IR	27060-16230	JA552IR
27020-63010	JA140	27030-68040	JA1125	27060-0L021	JA1796IR	27060-16260	JA552IR
27020-64010	JA143	27030-68120	JA1125	27060-0L022	JA1796IR	27060-16280	JA161IR
27020-64060	JA196	27030-87701	JA190	27060-0L080	JA1796IR	27060-16320	JA981IR
27020-64080	JA194IR	27030-87702	JA190	27060-0L081	JA1796IR	27060-16350	JA981IR
27020-64100	JA194IR	27040-54030	JA799IR	27060-0N011	CA1930IR *	27060-16370	JA987IR
27020-64300	JA1362	27040-54050	JA799IR	27060-0N020	CA1964IR	27060-16390	JA987IR
27020-64310	JA1132IR	27040-54060	JA799IR	27060-0N021	CA1964IR	27060-16430	JA987IR
27020-68040	JA1125	27040-54080	JA799IR	27060-0N040	CA2097IR *	27060-16460	JA987IR
27020-68130	JA1125	27040-54100	JA799IR	27060-0Q010	CA1978IR	27060-17010	JA1294IR
27020-72010	JA144	27040-54130	JA881IR	27060-0Q011	CA1978IR	27060-17020	JA1294IR
27020-72030	JA144	27040-54151	JA799IR	▲ 27060-0Q020	CA1949IR	27060-17030	JA1295IR
27020-72050	JA144	27040-54160	JA881IR	27060-0Q021	CA1949IR	27060-17060	JA1296IR
27020-72060	JA144	27040-54170	JA750IR	27060-0Q030	CA2102IR *	27060-17160	JA1597IR
27020-72200	JA144	27040-54180	JA750IR	27060-0Q040	CA1889IR	27060-17170	JA1534IR
27020-72230	JA144	27040-54210	JA881IR	27060-0Q130	CA1949IR	27060-17171	JA1534IR
27020-72240	JA144	27040-54220	JA881IR	27060-0R011	CA2036IR *	27060-17220	JA1534IR
27020-87102	JA130	27040-54230	JA881IR	27060-0T020	CA2027IR	27060-17230	JA1724IR
27020-87103	JA130	27040-54231	JA750IR	27060-0T021	CA2027IR	27060-18010	JA142IR
27020-87209	JA130	27040-54240	JA881IR	27060-10010	JA142IR	27060-21010	JA1793IR
27020-87210	JA114	27040-54270	JA799IR	▲ 27060-10011	JA142IR	▲ 27060-21011	JA1793IR
27020-87211	JA130	▲ 27040-54271	JA799IR	▲ 27060-10030	JA141IR	27060-21020	JA1595IR
27020-87212	JA114	27040-54272	JA799IR	27060-10050	JA141IR	27060-21030	JA1794IR
27020-87214	JA114	27040-54280	JA1367IR	27060-10050	JA141IR	27060-21031	JA1794IR
27020-87216	JA118	27040-54290	JA1359IR	27060-10051	JA141IR	27060-21040	JA1793IR
27020-87507	JA118	27040-54300	JA1367IR	27060-10060	JA142IR	▲ 27060-21041	JA1793IR
27020-87509	JA118	27040-54310	JA1367IR	27060-10061	JA142IR	27060-21140	JA1794IR
27020-87701	JA131	27040-54320	JA989IR	27060-10070	JA141IR	27060-22030	JA1703IR
27020-87702	JA131	27040-54340	JA989IR	27060-10071	JA141IR	27060-22040	JA1703IR
27020-87705	JA130	27040-54350	JA1355IR	27060-10080	JA141IR	27060-22060	CA2047IR
27020-96601	JA791	27040-54440	JA1367IR	27060-10090	JA142IR	27060-22100	JA1703IR
27030-46034	JA651	27040-54500	JA1367IR	27060-10100	JA141IR	27060-22130	JA1703IR
27030-47023	JA651	27040-54580	JA1367IR	27060-11000	JA141IR	27060-22140	CA2047IR
27030-47024	JA651	27040-64010	JA799IR	27060-11020	JA142IR	▲ 27060-22160	JA1703IR
27030-47040	JA651	27040-64020	JA194IR	27060-11030	JA996IR	27060-23010	JA1722IR
27030-54011	JA149	27040-64030	JA194IR	27060-11041	JA1289IR	27060-23020	JA1714IR
27030-54012	JA149	27040-64050	JA578IR	27060-11050	JA142IR	▲ 27060-23030	JA1517IR
27030-54013	JA149	27040-64051	JA578IR	27060-11090	JA142IR	▲ 27060-23040	JA1722IR
27030-54020	JA149	27040-64060	JA194IR	27060-11120	JA142IR	27060-23061-71	JA1170IR ▲
27030-54021	JA149	27040-64070	JA194IR	27060-11160	JA142IR	▲ 27060-26020	JA152IR
27030-54022	JA149	27040-64080	JA194IR	27060-11170	JA988IR	27060-26021	JA152IR
27030-54130	JA193	27040-64090	JA194IR	27060-11250	JA1274IR	27060-26030	CA2029IR
27030-54140	JA193	27040-64100	JA194IR	27060-11260	JA1274IR	27060-27030	JA1783IR
27030-54150	JA193	27040-64110	JA194IR	27060-11270	JA988IR	27060-27040	JA1721IR
27030-54160	JA193	27040-64120	JA194IR	27060-11270	JA988IR	27060-27060	CA1951IR *
27030-54190	JA777	27040-64130	JA571IR	27060-11280	JA988IR	27060-27070	JA1721IR
27030-54210	JA193	27040-64131	JA571IR	▲ 27060-11281	JA988IR	27060-27090	CA1950IR
27030-54241	JA777	27040-64136	JA196	27060-11320	JA1178IR	27060-27100	JA1721IR
27030-54242	JA777	27040-64140	JA571IR	27060-11320	JA1178IR	27060-28010	JA152IR
27030-54243	JA777	27040-64141	JA571IR	27060-11340	JA988IR	27060-28011	JA152IR
27030-54244	JA777	27040-64200	JA1132IR	27060-15080	JA976IR	27060-28012	JA152IR
27030-54250	JA777	27040-64210	JA578IR	▲ 27060-15080	JA976IR	27060-28020	JA152IR
27030-54251	JA1270	27040-68030	JA1352IR	27060-15090	JA976IR	27060-28040	JA152IR
27030-54252	JA1270	27060-02050	JA987IR	27060-15100	JA976IR	27060-28060	JA1797IR
27030-54253	JA1270	27060-02060	JA987IR	27060-15120	JA976IR	27060-28070	JA1613IR
27030-54260	JA777	27060-02061	JA987IR	27060-15130	JA976IR	27060-28080	JA1797IR

O.E. NO.	HC-PARTS	O.E. NO.	HC-PARTS	O.E. NO.	HC-PARTS	O.E. NO.	HC-PARTS
<b>TOYOTA <i>Continued</i></b>							
27060-28090	JA1797IR	27060-64021	JA578IR	27060-75090	JA1354IR	28100-13020	JS333
27060-28100	JA1797IR	27060-64030	JA578IR	27060-75100	JA1535IR	28100-13030	JS333
27060-28110	JA1792IR	27060-64080	JA1166IR	27060-75100	JA1535IR	28100-13050	JS371
27060-28120	JA1792IR	27060-64100	JA1166IR	27060-75150	JA1535IR	28100-13080	JS371
27060-28260	JA1613IR	27060-64130	JA1119IR	27060-75190	JA1536IR	28100-14014	JS336
27060-30010	JA1796IR	27060-64150	JA1119IR	27060-76010	JA1351IR	28100-15010	JS338
27060-30010	JA1796IR	27060-64170	JA1604IR	27060-76020	JA1351IR	28100-15011	JS338
27060-30020	JA1796IR	27060-64270	JA1604IR	27060-76030	JA1351IR	28100-15020	JS388
27060-30040	JA1796IR	27060-67030	JA1410IR	27060-76040	JA1165IR	28100-15050	JS338
27060-30050	JA1796IR	27060-67070	JA1410IR	27060-76050	JA1165IR	28100-15060	JS381
27060-30060	CA2069IR *	27060-67070	JA1410IR	27060-76070	JA1369IR	28100-15070	JS339
27060-30130	CA2069IR *	27060-67110	JA1410IR	27060-76070	JA1369IR	28100-15110	JS317
27060-30150	JA1796IR	27060-70051	JA1611IR	▲ 27060-76080	JA1369IR	28100-15130	JS317
27060-30151	JA1796IR	27060-70070	JA189IR	▲ 27060-78001-71	JA9711R	28100-15140	JS381
27060-33010	JA1793IR ▲	27060-70101	JA1611IR	▲ 27060-78003-71	JA9701R	28100-15150	JS317
27060-33020	JA1893IR	27060-70140	JA1611IR	▲ 27060-78154-71	JA1536IR ▲	28100-15160	JS317
27060-33030	JA1892IR	27060-70141	JA189IR	▲ 27060-78159	JA1536IR ▲	28100-15170	JS317
27060-33040	JA1891IR	27060-70142	JA189IR	▲ 27060-78301-71	JA7921R	28100-15180	JS317
27060-33040	JA1891IR	27060-70150	JA885IR	▲ 27060-78700-71	JA1536IR ▲	28100-15190	JS917
27060-33071	CA1964IR	27060-70170	JA1611IR	▲ 27060-87106	JA1121IR	28100-16010	JS760
27060-33072	CA1964IR	27060-70240	JA885IR	▲ 27060-87512	JA8801R	28100-16020	JS560
27060-35060	JA1123IR	27060-70270	JA1611IR	▲ 27060-87Z06	JA8801R	28100-16040	JS760
27060-35061	JA1123IR	27060-70280	JA1611IR	▲ 27060-96001	JA9711R	28100-16041	JS760
27060-35120	JA1123IR	27060-70290	JA885IR	▲ 27060-97202	JA1609IR	28100-16070	JS760
27060-35130	JA1123IR	27060-70330	JA885IR	▲ 27060-YV010	CA1589IR	28100-16071	JS760
27060-37010	CA2027IR	27060-70410	JA981IR	▲ 27060-YV020	CA1674IR	28100-16080	JS563
27060-37011	CA2027IR	27060-70500	CA2022IR	27070-23001-71	JA1170IR	28100-16110	JS560
27060-38032	JA152IR	27060-72050	JA657IR	27070-23041-71	JA1170IR ▲	28100-16130	JS560
27060-40020	CA2102IR *	27060-72060	JA657IR	28100-01030	JS560	28100-16140	JS560
27060-41012	JA167IR	27060-72061	JA657IR	28100-02040	JS1105	28100-16150	JS1141
27060-42010	JA885IR ▲	27060-72062	JA657IR	28100-02060	JS1018	28100-16160	JS918
27060-42030	JA161IR	27060-72070	JA657IR	28100-02080	JS1105	28100-16180	JS1018
27060-42060	JA885IR ▲	27060-72071	JA657IR	28100-03030	JS632	28100-16190	JS1141
27060-43010	JA167IR	27060-72080	JA553IR	28100-03070	JS913	28100-16210	JS560
27060-43020	JA167IR	27060-72081	JA553IR	28100-03100	JS1218	28100-16220	JS560
27060-43030	JA167IR	27060-72090	JA657IR	28100-05801	JS385	28100-16230	JS918
27060-43040	JA167IR	27060-72101	JA657IR	28100-08010	JS1088	28100-16270	JS1018
27060-43060	JA657IR ▲	27060-72111	JA553IR	28100-08020	JS669	28100-17020	JS1021
27060-43090	JA657IR ▲	27060-72120	JA657IR	28100-08040	JS1144	28100-17030	JS1021
27060-43110	JA657IR	27060-72121	JA657IR	28100-0B010	JS1135	28100-17050	JS1217
27060-43120	JA657IR	27060-72170	JA546IR ▲	28100-0B020	JS1135	28100-20540	JS335
27060-43130	JA885IR	27060-72171	JA546IR ▲	28100-0D030	JS1236	28100-20551-71	JS669
27060-43140	JA885IR ▲	27060-74010	JA1611IR	28100-0D090	JS1362	28100-20552-71	JS764
27060-43990	JA546IR	27060-74020	JA1611IR	28100-0D130	JS1236	28100-20553-71	JS669
27060-54030	JA750IR	27060-74050	JA1611IR ▲	28100-0D180	JS1362	28100-20572	JS669
27060-54040	JA750IR	27060-74070	JA1611IR	28100-0E010	JS1024	28100-21020	JS1233
27060-54070	JA881IR	27060-74100	JA1611IR	28100-0G010	JS1135	28100-21021	JS1233
27060-54080	JA881IR	27060-74110	JA783IR	28100-0G020	JS1135	28100-21030	JS1224
27060-54140	JA1367IR	27060-74120	JA783IR	28100-0G040	JS1369	28100-21061	CS1499
27060-54210	JA989IR	27060-74130	JA783IR	28100-0H060	JS1363	28100-21062	CS1499
27060-54290	JA1367IR	27060-74140	JA783IR	28100-0H061	JS1363	28100-21142	JS331
27060-55011	JA142IR ▲	27060-74150	JA783IR	28100-0H110	JS1363	28100-22000	JS669
27060-55050	JA996IR ▲	27060-74170	JA882IR	28100-0J010	JS1299	28100-22010	JS330
27060-55060	JA1178IR ▲	27060-74180	JA1417IR	28100-0J020	JS1308	28100-22011	JS330
27060-55070	JA988IR ▲	27060-74190	JA783IR	28100-0J030	CS1506	28100-22012	JS330
27060-58010	JA553IR	27060-74210	JA783IR	28100-0J031	CS1506	28100-22020	JS330
27060-58020	JA984IR	27060-74250	JA882IR	28100-0J050	CS1506	28100-22021	JS330
27060-58030	JA1118IR	27060-74270	JA1611IR	28100-0L050	CS1448	28100-22022	JS330
27060-58050	JA1118IR ▲	27060-74290	JA783IR	28100-0L051	CS1448	28100-22030	JS1230
27060-58090	JA984IR	27060-74320	JA882IR	28100-0N010	CS1453	28100-22031	JS1230
27060-58220	JA1428IR	27060-74330	JA1417IR	28100-0Q012	CS1407	28100-22040	JS1236
27060-61021	JA152IR	27060-74360	JA1134IR	28100-0Q021	CS1407	28100-22041	JS1236
27060-62011	JA1164IR	27060-74370	JA981IR	28100-0Q031	CS1490	28100-22060-71	JS733
27060-62012	JA1164IR	27060-74400	JA981IR	28100-0R010	JS1369	28100-22061-71	JS733
27060-62090	JA1372IR	27060-74410	JA1134IR	28100-0T030	CS1450	28100-23010	JS336
27060-63020	JA161IR	27060-74430	JA1418IR	28100-0W080	JS1358	28100-23011	JS336
27060-63021	JA161IR	27060-74440	JA1371IR	28100-10020	JS631	28100-23011	JS336
27060-63030	JA189IR	27060-74500	JA1371IR	28100-10021	JS631	28100-23020	JS1299
27060-63031	JA189IR	27060-74560	JA1134IR	28100-10030	JS357	28100-23030	JS1223
27060-63040	JA189IR	27060-74590	JA1134IR	28100-10040	JS525	28100-23800-71	JS933
27060-63041	JA189IR	27060-74630	JA981IR	28100-11010	JS357	28100-23810-71	JS316
27060-63060	JA189IR	27060-74640	JA1134IR	28100-11060	JS1133	28100-24000	JS333
27060-63061	JA189IR	27060-74730	JA981IR	28100-11080	JS1023	28100-24010	JS333
27060-63080	JA161IR	27060-74740	JA1134IR	28100-11100	JS1024	28100-24012	JS333
27060-63081	JA161IR	27060-74750	JA1134IR	28100-11140	JS1023	28100-24020	JS333
27060-63082	JA161IR	27060-74830	JA1134IR	28100-11160	JS1024	28100-24021	JS333
27060-63100	JA189IR	27060-75030	JA1536IR	28100-12030	JS330	28100-24022	JS333
27060-63101	JA161IR	27060-75050	JA1354IR	28100-12040	JS330	28100-24030	JS333
27060-63102	JA189IR	27060-75080	JA657IR	28100-13010	JS371	28100-24031	JS333



O.E. NO.	HC-PARTS	O.E. NO.	HC-PARTS	O.E. NO.	HC-PARTS	O.E. NO.	HC-PARTS
<b>VALEO <i>Continued</i></b>							
432537	CS366	432845	CA139IR	433245	CS95	433345	CS692
432538	CS338	432853	CA141IR	433246	CS315	433346	CS396
432545	CS306	432854	CA87IR	433247	CS315	433347	CS592
432546	CS326	432855	CA228IR	433247	CS95	433348	CS376
432549	CS316	432856	CA125IR	433248	CS354	433349	CS334
432550	CS321	432868	CA355IR	433249	CS310	433351	CA115
432551	CS355	432984	CA1387IR	433253	CS170	433352	CA172IR
432553	CS280	432986	CA61IR	433254	CS316	433353	CA173IR
432555	CS317	432987	CA96IR	433255	CS143	433354	CA176IR
432557	CS94	432989	CA339IR	433255	CS321	433358	CA291IR
432558	CS126	433016	CS297	433256	CS338	433363	CA174IR
432560	CS385	433040	CA369IR	433257	CS280	433364	CA294IR
432565	CS315	433042	CA372IR	433259	CS180	433368	CA175IR
432566	CS310	433050	CA376IR	433260	CS131	433371	CA229IR
432581	CS310	433054	CA128IR	433261	CS79	433374	CA150IR
432582	CS354	433061	CA557IR	433262	CS132	433375	CA149IR
432586	CS1106	433065	CA557IR	433264	CS297	433380	CA308IR
432590	CS681	433067	CA831IR	433265	CS77	433387	CA228IR
432591	CS390	433069	CA359IR	433266	CS116	433392	CA114
432591	CS581	433077	CA224IR	433267	CS136	433404	CA811R
432601	CS344	433079	CA574IR	433268	CS272	433405	CA356IR
432606	CS297	433081	CA170IR	433269	CS62	433407	CA371IR
432614	CS310	433082	CA380IR	433272	CS18	433411	CA303IR
432621	CS310	433086	CA529IR	433273	CS18	433414	CA169IR
432622	CS681	433087	CA580IR	433274	CS76	433416	CA178IR
432623	CS390	433093	CA612IR	433276	CS90	433417	CA288IR
432628	CS681	433096	CA549IR	433277	CS147	433418	CA512IR
432629	CS575	433097	CA649IR	433278	CS91	433420	CA360IR
432631	CS791	433098	CA524IR	433279	CS139	433429	CA170IR
432633	CS621	433115	CA252IR	433282	CS289	433430	CA268IR
432634	CS371	433117	CA129IR	433283	CS308	433437	CA224IR
432636	CS566	433118	CA252IR	433285	CS397	433438	CA165IR
432637	CS684	433120	CA612IR	433286	CS78	433440	CA170IR
432638	CS882	433121	CA640IR	433287	CS123	433441	CA557IR
432643	CS796	433133	CA830IR	433289	CS86	433442	CA317IR
432644	CS1044	433138	CA345IR	433292	CS337	433442	CA375IR
432653	CS123	433144	CA605IR	433293	CS81	433444	CA372IR
432655	CS77	433145	CA606IR	433294	CS188	433445	CA373IR
432659	CS285	433148	CA633IR	433295	CS113	433446	CA361IR
432663	CS91	433149	CA635IR	433296	CS66	433447	CA224IR
432666	CS542	433150	CA632IR	433297	CS162	433448	CA529IR
432670	CS1060	433154	CA618IR	433298	CS70	433449	CA301IR
432672	CS684	433158	CA716IR	433300	CS321	433450	CA229IR
432673	CS886	433160	CA638IR	433301	CS275	433451	CA526IR
432674	CS978	433162	CA637IR	433303	CS326	433452	CA534IR
432675	CS327	433167	CA816IR	433304	CS306	433453	CA314IR
432684	CS684	433168	CA819IR	433305	CS373	433454	CA369IR
432685	CS1385	433176	CA535IR	433306	CS366	433455	CA359IR
432700	CA235IR	433179	CA1042IR	433307	CS317	433457	CA380IR
432714	CA147	433180	CA1054IR	433309	CS310	433458	CA579IR
432715	CA148	433181	CA1054IR	433310	CS353	433459	CA549IR
432724	CA170IR	433188	CA820IR	433311	CS390	433459	CA649IR
432726	CA375IR	433190	CA825IR	433314	CS550	433460	CA602IR
432728	CA165IR	433200	CS126	433315	CS1173	433461	CA527IR
432733	CA268IR	433202	CS142	433316	CS201	433462	CA526IR
432736	CA303IR	433203	CS142	433320	CS681	433463	CA524IR
432739	CA291IR	433204	CS355	433321	CS551	433464	CA830IR
432745	CA308IR	433206	CS166	433323	CS542	433465	CA529IR
432746	CA150IR	433207	CS127	433324	CS1177	433466	CA535IR
432749	CA371IR	433208	CS169	433324	CS373	433467	CA640IR
432759	CA512IR	433209	CS317	433325	CS371	433468	CA587IR
432763	CA373IR	433213	CS165	433326	CS361	433469	CA556IR
432764	CA378IR	433215	CS155	433327	CS567	433482	CA131
432765	CA372IR	433215	CS361	433328	CS393	433483	CA295IR
432772	CA300IR	433218	CS365	433331	CS184	433485	CA17V
432776	CA813IR	433219	CS163	433332	CS575	433486	CA627IR
432783	CA314IR	433223	CS352	433332	CS684	433487	CA525IR
432785	CA332IR	433224	CS151	433333	CS344	433488	CA580IR
432786	CA229IR	433226	CS168	433334	CS299	433489	CA581IR
432793	CA229IR	433227	CS273	433335	CS298	434005	CA341IR
432794	CA814IR	433228	CS128	433336	CS358	434009	CA595IR
432799	CA535IR	433229	CS314	433337	CS78	434010	CA595IR
432808	CA175IR	433230	CS154	433339	CS340	434013	CA702IR
432814	CA534IR	433231	CS362	433339	CS343	434014	CA824IR
432819	CA94IR	433233	CS381	433340	CS341	434016	CA1236IR
432825	CA226IR	433237	CS130	433342	CS380	434017	CA1433IR
432834	CA115	433237	CS93	433343	CS364	434026	CA1237IR
432835	CA60IR	433243	CS126	433344	CS290	434027	CA1236IR
432836	CA126IR	433243	CS94	433344	CS322	434028	CA1666IR

O.E. NO.	HC-PARTS	O.E. NO.	HC-PARTS	O.E. NO.	HC-PARTS	O.E. NO.	HC-PARTS
434029	CA1739IR	436080	CS782	436220	CA242IR	436320	CA338IR
434030	CA1739IR	436081	CS681	436223	CA306IR	436322	CA532IR
434032	CA1695IR	436082	CS89	436225	CA319IR	436326	CA332IR
434034	CA1679IR	436083	CS346	436226	CA154	436330	CA1042IR
434035	CA1237IR	436084	CS310	436228	CA298IR	436331	CA1054IR
434036	CA1739IR	436085	CS389	436229	CA46IR	436332	CA1054IR
436000	CS119	436089	CS385	436230	CA350IR	436333	CA897IR
436000	CS74	436090	CS621	436235	CA254IR	436334	CA1073IR
436001	CS183	436091	CS607	436236	CA254IR	436335	CA1105IR
436002	CS331	436093	CS1127	436237	CA355IR	436336	CA729IR
436003	CS1075	436095	CS983	436240	CA911IR	436338	CA637IR
436003	CS327	436096	CS608	436241	CA504IR	436339	CA638IR
436004	CS268	436097	CS983	436242	CA596IR	436340	CA639IR
436005	CS268	436098	CS983	436243	CA506IR	436344	CA729IR
436006	CS311	436100	CA235IR	436244	CA596IR	436345	CA820IR
436007	CS285	436102	CA300IR	436246	CA315IR	436346	CA730IR
436008	CS286	436103	CA1435IR	436247	CA510IR	436347	CA705IR
436009	CS69	436104	CA233IR	436248	CA175IR	436348	CA721
436010	CS72	436105	CA255IR	436249	CA643IR	436349	CA314IR
436011	CS80	436108	CA46IR	436250	CA549IR	436351	CA898IR
436012	CS87	436109	CA77IR	436250	CA649IR	436352	CA705IR
436013	CS263	436111	CA129IR	436251	CA632IR	436354	CA148
436014	CS282	436112	CA129IR	436252	CA606IR	436355	CA155IR
436016	CS297	436112	CA1435IR	436253	CA607IR	436360	CA314IR
436017	CS606	436113	CA307IR	436254	CA605IR	436363	CA733IR
436018	CS276	436114	CA252IR	436255	CA635IR	436364	CA732IR
436019	CS294	436117	CA351IR	436256	CA838IR	436366	CA825IR
436020	CS295	436118	CA350IR	436257	CA617IR	436371	CA1101IR
436021	CS293	436118	CA572IR	436258	CA618IR	436372	CA849IR
436021	CS79	436120	CA321IR	436259	CA648IR	436374	CA711IR
436022	CS294	436121	CA87IR	436260	CA715IR	436378	CA1192IR
436023	CS83	436125	CA69IR	436263	CA613IR	436380	CA845IR
436024	CS115	436126	CA287IR	436264	CA1387IR	436381	CA837IR
436025	CS140	436127	CA195IR	436264	CA704IR	436382	CA716IR
436025	CS292	436131	CA199IR	436265	CA76	436383	CA1104IR
436026	CS133	436132	CA251IR	436265	CA76IR	436384	CA1060IR
436027	CS507	436134	CA251IR	436266	CA339IR	436385	CA1064IR
436028	CS351	436135	CA196IR	436267	CA734IR	436388	CA837IR
436029	CS504	436136	CA192IR	436269	CA70	436389	CA1397IR
436030	CS569	436137	CA192IR	436273	CA564IR	436391	CA1339IR
436031	CS709	436139	CA191IR	436275	CA815IR	436393	CA1049IR
436032	CS514	436140	CA17H	436276	CA818IR	436394	CA1336IR
436033	CS285	436144	CA18H	436277	CA816IR	436395	CA1336IR
436034	CS518	436145	CA126IR	436278	CA819IR	436398	CA608IR
436034	CS727	436146	CA87IR	436279	CA1251IR	436399	CA347IR
436035	CS584	436147	CA313IR	436280	CA895IR	436400	CA302IR
436037	CS230	436148	CA507IR	436281	CA817IR	436403	CA848IR
436038	CS347	436149	CA128IR	436282	CA720IR	436410	CA859IR
436040	CS378	436150	CA99IR	436283	CA1225IR	436411	CA1063IR
436041	CS356	436153	CA48IR	436284	CA821IR	436412	CA227IR
436042	CS386	436155	CA110IR	436285	CA1033IR	436412	CA749IR
436043	CS350	436157	CA42	436287	CA207IR	436414	CA339IR
436044	CS370	436157	CA42IR	436288	CA592IR	436416	CA212IR
436045	CS510	436159	CA221IR	436289	CA310IR	436417	CA1336IR
436046	CS300	436159	CA570IR	436290	CA566IR	436417	CA326IR
436047	CS500	436160	CA158IR	436291	CA318IR	436418	CA501IR
436048	CS548	436161	CA264IR	436292	CA320IR	436420	CA368IR
436049	CS286	436166	CA94IR	436293	CA139IR	436421	CA334IR
436049	CS374	436167	CA126IR	436294	CA357IR	436422	CA240IR
436050	CS574	436169	CA60IR	436295	CA517IR	436423	CA333IR
436051	CS684	436173	CA293IR	436296	CA376IR	436425	CA186IR
436052	CS543	436175	CA15H	436297	CA514IR	436425	CA186IR
436053	JS380	436179	CA600IR	436298	CA198IR	436427	CA568IR
436056	CS519	436180	CA96IR	436299	CA354IR	436428	CA333IR
436058	CS310	436181	CA226IR	436300	CA503IR	436430	CA183
436059	CS310	436184	CA93IR	436301	CA604IR	436431	CA259IR
436060	CS681	436189	CA237IR	436302	CA530IR	436432	CA184
436061	CS338	436191	CA296IR	436303	CA521IR	436433	CA550IR
436062	CS581	436192	CA337IR	436305	CA89	436433	CA748IR
436063	CS570	436193	CA505IR	436306	CA88IR	436436	CA130IR
436064	CS566	436194	CA136IR	436307	CA271IR	436437	CA132IR
436065	CS566	436196	CA85IR	436308	CA289IR	436438	CA500IR
436068	CS712	436197	CA139IR	436309	CA574IR	436439	CA858IR
436070	CS395	436199	CA141IR	436311	CA567IR	436440	CA518IR
436073	CS240	436208	CA367IR	436312	CA370IR	436442	CA827IR
436074	CS572	436211	CA328IR	436313	CA224IR	436443	CA740IR
436075	CS511	436212	CA328IR	436314	CA533IR	436444	CA736IR
436078	CS280	436215	CA139IR	436315	CA349IR	436445	CA912IR
436079	CS791	436219	CA276IR	436316	CA229IR	436446	CA889IR

O.E. NO.	HC-PARTS	O.E. NO.	HC-PARTS	O.E. NO.	HC-PARTS	O.E. NO.	HC-PARTS
<b>VALEO <i>Continued</i></b>							
436447	CA1059IR	436530	JA116IR	436640	CA1139IR	436733	CA1307IR
436449	CA829IR	436531	JA179IR	436641	CA1323IR	436735	CA1303IR
436450	CA833IR	436532	JA134	436642	CA1152IR	436736	CA1322IR
436451	CA724IR	436533	JA144	436643	CA1156IR	436737	CA1333IR
436452	CA535IR	436534	JA131	436644	CA1486IR	436738	CA1306IR
436453	CA229IR	436535	JA138	436645	CA574IR	436739	CA1331IR
436454	CA838IR	436536	JA161IR	436646	CA716IR	436740	CA1333IR
436455	CA612IR	436537	JA142IR	436648	CA1079IR	436741	CA1305IR
436456	CA332IR	436538	JA141IR	436649	CA1078IR	436742	CA1345IR
436457	CA579IR	436540	JA140	436650	CA1336IR	436743	CA1434IR
436458	CA535IR	436541	JA552IR	436651	CA1339IR	436744	CA1397IR
436459	CA634IR	436542	JA173IR	436652	CA558IR	436745	CA1319IR
436461	CA633IR	436543	JA146IR	436653	CA1056IR	436746	CA1256IR
436462	CA634IR	436544	JA115IR	436654	CA1052IR	436747	JA150IR
436463	CA716IR	436545	JA163IR	436655	CA1256IR	436748	CA1444IR
436465	CA896IR	436546	JA164IR	436656	CA1573IR	436749	CA1392IR
436467	CA1036IR	436547	JA756IR	436661	CA896IR	436750	CA1484IR
436468	CA1320IR	436548	JA174IR	436662	CA1036IR	436752	CA1389IR
436469	CA1040IR	436549	JA884IR	436663	CA898IR	436753	CA1495IR
436470	CA913IR	436550	JA184IR	436664	CA705IR	436754	CA311IR
436471	CA914IR	436551	JA109IR	436665	CA1400IR	436755	CA1029IR
436472	CA711IR	436556	CA593IR	436666	CA1243IR	436755	CA611IR
436473	CA625IR	436557	CA184	436667	CA1044IR	436774	CA325IR
436474	CA556IR	436558	CA184	436668	CA1043IR	436785	CA345IR
436475	CA1238IR	436561	CA205IR	436669	CA1583IR	436786	CA322IR
436476	CA1086IR	436562	CA236IR	436670	CA1334IR	437049	CA594IR
436477	CA836IR	436567	CA366IR	436671	CA1312IR	437052	CA1692IR
436478	CA1098IR	436568	CA187IR	436673	CA1310IR	437052	CA562IR
436479	CA609IR	436570	CA823IR	436674	CA1310IR	437058	CA324IR
436480	CA894IR	436571	CA187IR	436675	CA1398IR	437072	CA263IR
436481	CA890IR	436574	CA335IR	436677	CA1338IR	437081	CA563IR
436482	CA827IR	436575	CA195IR	436678	CA1102IR	437091	CA560IR
436483	CA1265IR	436576	CA320IR	436679	CA1388IR	437110	CA284IR
436484	CA1269IR	436577	CA710IR	436680	CA558IR	437111	CA717IR
436486	CA1449IR	436578	CA186IR	436681	CA728IR	437112	CA1304IR
436487	CA1579IR	436581	CA537IR	436682	CA1041IR	437113	JA761IR
436488	CA1332IR	436583	CA1224IR	436683	CA1053IR	437114	CA1390IR
436489	CA1038IR	436584	CA824IR	436684	CA861IR	437115	CA1591IR
436490	CA1095IR	436585	CA502IR	436685	CA731IR	437116	CA1559IR
436496	CA1048IR	436586	CA642IR	436686	CA299IR	437117	CA1569IR
436497	JA551IR	436587	CA569IR	436687	CA1227IR	437118	CA1578IR
436498	JA190	436589	CA854IR	436687	CA305IR	437119	CA1298IR
436499	JA150IR	436590	CA853IR	436688	CA586IR	437120	JA863IR
436500	JA151IR	436591	CA1035IR	436689	CA712IR	437121	JA757IR
436501	JA151IR	436594	CA831IR	436690	CA299IR	437122	JA757IR
436502	JA101	436598	CA196IR	436692	CA600IR	437123	CA846IR
436502	JA103	436599	CA814IR	436694	CA627IR	437125	CA1044IR
436502	JA119	436601	CA276IR	436695	CA96IR	437126	CA1062IR
436504	JA664IR	436607	CA1247IR	436697	CA1573IR	437130	JA873IR
436505	JA104IR	436608	JA139	436698	CA1573IR	437131	JA680IR
436505	JA105IR	436609	JA671IR	436699	CA561IR	437134	JA1172IR
436506	JA104IR	436610	JA684IR	436700	CA1332IR	437135	JA871IR
436506	JA109IR	436611	CA1203IR	436701	CA1253IR	437137	CA1442IR
436507	JA105IR	436612	CA1099IR	436702	CA1096IR	437138	CA1496IR
436508	JA166IR	436613	CA1065IR	436704	CA313IR	437139	CA1564IR
436509	JA658IR	436614	CA1077IR	436706	CA1343IR	437140	CA1306IR
436510	JA573IR	436615	CA1077IR	436707	CA898IR	437141	CA1307IR
436511	JA157	436616	CA1250IR	436712	CA1344IR	437143	JA148IR
436512	JA153	436617	CA1200IR	436713	CA1306IR	437145	JA654IR
436513	JA170	436618	CA1080IR	436714	CA1302IR	437146	JA766IR
436514	JA177IR	436619	CA1150IR	436715	CA1383IR	437147	JA983IR
436515	JA113IR	436620	CA342IR	436716	CA1382IR	437148	JA585IR
436516	JA752IR	436621	CA515IR	436717	CA1383IR	437149	JA100
436517	JA771IR	436622	CA539IR	436718	CA1062IR	437150	JA182IR
436518	JA109IR	436623	CA547IR	436718	CA1395IR	437151	JA653IR
436518	JA197IR	436623	CA630IR	436719	CA1051IR	437152	JA769IR
436519	JA771IR	436625	CA263IR	436720	CA1103IR	437153	JA160IR
436520	JA751IR	436626	CA335IR	436721	CA516IR	437156	JA180IR
436521	JA753IR	436626	CA714IR	436722	CA352IR	437158	JA698IR
436522	JA127IR	436627	CA826IR	436723	CA384IR	437160	CA1584IR
436523	JA128IR	436628	CA539IR	436724	JA673IR	437161	JA155
436524	JA129IR	436629	CA263IR	436725	JA863IR	437162	JA171IR
436525	JA130	436630	CA541IR	436726	CA508IR	437163	JA188IR
436525	JA131	436631	CA538IR	436727	CA647IR	437164	CA836IR
436526	JA137	436632	CA542IR	436728	CA1309IR	437168	CA1344IR
436527	JA762IR	436633	CA1058IR	436729	CA1309IR	437170	CA1504IR
436528	JA191IR	436633	CA318IR	436730	CA1308IR	437171	CA1509IR
436529	JA165IR	436635	CA1039IR	436731	CA1056IR	437172	CA1750IR
436529	JA778IR	436636	CA1157IR	436732	CA1342IR	437173	CA1588IR

O.E. NO.	HC-PARTS	O.E. NO.	HC-PARTS	O.E. NO.	HC-PARTS	O.E. NO.	HC-PARTS
437174	CA1546IR	437346	CA1390IR	437431	CA1781IR	437519	JA987IR
437176	CA1664IR	437347	CA1653IR	437432	CA1778IR	437520	JA981IR
437177	CA1545IR	437348	CA1546IR	437433	CA1767IR	437521	CA1137IR
437178	CA1588IR	437349	CA1643IR	437434	CA1762IR	437522	CA1090IR
437179	JA874IR	437350	CA2037IR	437435	CA1774IR	437523	CA381IR
437180	JA1370IR	437351	CA1645IR	437436	CA1674IR	437525	CA1482IR
437181	CA1507IR	437352	CA1049IR	437437	CA1814IR	437526	CA1782IR
437183	CA1622IR	437353	CA1622IR	437438	CA908IR	437533	CA1934IR
437184	CA1506IR	437355	CA1498IR	437439	CA1768IR	437534	CA1489IR
437185	CA1641IR	437356	CA1499IR	437440	CA1593IR	437536	CA563IR
437186	CA1642IR	437357	CA1589IR	437441	CA1505IR	437537	CA1875IR
437187	CA1065IR	437358	CA1588IR	437442	CA1593IR	437538	CA1904IR
437188	CA1759IR	437359	CA1746IR	437443	CA1622IR	437540	CA1481IR
437190	CA1640IR	437360	CA1811IR	437444	CA1675IR	437542	CA1910IR
437191	CA1497IR	437361	CA1662IR	437445	CA1755IR	437543	CA1963IR
437192	CA1498IR	437362	CA1569IR	437446	CA1456IR	437544	CA1874IR
437193	CA1589IR	437363	CA1578IR	437447	CA1456IR	437545	CA1873IR
437194	CA1499IR	437364	CA1754IR	437449	CA1773IR	437546	CA1577IR
437198	CA1303IR	437365	CA1813IR	437450	CA1905IR	437547	CA1297IR
437199	CA1322IR	437366	CA1256IR	437451	CA1825IR	437548	CA1260IR
437200	CA1621IR	437367	CA1591IR	437452	CA1757IR	437550	CA1879IR
437201	CA1307IR	437369	CA828IR	437453	CA1758IR	437551	CA851IR
437202	CA1309IR	437370	CA893IR	437454	CA1782IR	437553	CA2002IR
437203	CA1306IR	437371	CA589IR	437455	JA1725IR	437554	CA1911IR
437204	CA1333IR	437372	CA903IR	437456	CA1817IR	437555	CA1912IR
437205	CA1078IR	437373	CA1976IR	437457	CA1850IR	437556	CA1905IR
437206	CA1333IR	437374	CA1654IR	437458	CA1761IR	437557	CA1953IR
437207	CA1146IR	437375	CA1660IR	437459	CA892IR	437558	CA1762IR
437208	CA1627IR	437376	CA1872IR	437460	CA1687IR	437559	CA1933IR
437210	CA1553IR	437377	CA1678IR	437461	CA1665IR	437560	CA1076IR
437211	CA1066IR	437378	CA584IR	437462	CA832IR	437562	CA1985IR
437212	CA1231IR	437379	CA305IR	437464	CA1473IR	437565	JA806IR
437213	CA1045IR	437380	CA560IR	437465	CA1646IR	437567	CA1216IR
437214	CA1326IR	437381	CA1690IR	437466	CA1329IR	437570	CA1257IR
437216	CA1327IR	437382	CA717IR	437467	CA1244IR	437575	CA1674IR
437218	CA826IR	437383	CA1071IR	437468	CA1769IR	437580	CA724IR
437220	CA532IR	437384	CA1149IR	437469	CA1818IR	437582	CA739IR
437220	CA597IR	437385	CA1032IR	437470	CA1810IR	437583	CA1757IR
437222	CA1689IR	437386	CA1143IR	437471	CA1761IR	437584	CA1879IR
437224	CA1872IR	437387	CA1037IR	437472	CA1674IR	437587	CA1062IR
437225	CA1623IR	437388	CA1087IR	437473	CA1855IR	437588	CA1148IR
437227	CA1631IR	437389	CA1145IR	437474	CA1862IR	437589	CA1440IR
437306	CA1444IR	437390	CA719IR	437475	CA1856IR	437594	CA1438IR
437307	CA1835IR	437391	CA738IR	437476	CA907IR	437595	CA855IR
437308	CA1574IR	437392	CA1089IR	437477	CA1240IR	437597	CA1190IR
437309	CA1756IR	437393	CA1484IR	437479	CA1267IR	437603	CA1748IR
437310	CA1106IR	437394	CA516IR	437480	JA1174IR	437604	CA1747IR
437311	CA1628IR	437395	CA1502IR	437481	CA1684IR	437609	CA1439IR
437312	CA1656IR	437396	CA1511IR	437482	CA1666IR	437610	CA1673IR
437313	CA1298IR	437397	CA1566IR	437483	CA1556IR	437611	CA1765IR
437314	CA1738IR	437398	CA1568IR	437485	CA1557IR	437612	CA1474IR
437315	CA1436IR	437399	CA1504IR	437486	CA1663IR	437613	CA1257IR
437316	CA1378IR	437400	CA1446IR	437489	CA1209IR	437614	CA1228IR
437317	CA1394IR	437401	CA1512IR	437491	CA1057IR	437615	CA1300IR
437318	CA1771IR	437402	CA1567IR	437492	CA1248IR	437616	JA1188IR
437319	CA1207IR	437403	CA1560IR	437493	CA1140IR	437617	JA1126IR
437320	CA1982IR	437404	CA1542IR	437494	CA1241IR	437618	CA1229IR
437321	CA1771IR	437405	CA610IR	437495	CA1093IR	437619	CA1475IR
437322	CA1572IR	437406	CA1584IR	437496	CA1501IR	437620	CA1483IR
437323	CA1637IR	437407	CA2008IR	437497	JA1521IR	437621	CA1489IR
437324	CA1207IR	437409	CA1681IR	437499	CA1062IR	437623	CA1340IR
437325	CA1574IR	437410	CA1756IR	437500	CA1325IR	437624	JA659IR
437327	CA1650IR	437413	CA1490IR	437501	JA1607IR	437625	CA1481IR
437328	CA1392IR	437414	CA1391IR	437502	CA1729IR	437626	CA1634IR
437329	CA716IR	437415	CA1680IR	437503	CA1855IR	437627	JA755IR
437330	CA1092IR	437416	JA1279IR	437504	CA1862IR	437629	CA700IR
437331	CA1245IR	437417	CA1756IR	437505	CA369IR	437630	CA1625IR
437333	JA689IR	437418	CA1746IR	437507	CA1937IR	437631	CA1734IR
437335	JA1807IR	437419	CA1512IR	437508	JA665IR	437632	JA798IR
437336	JA879IR	437420	CA1759IR	437509	JA988IR	437633	JA1293IR
437337	JA1715IR	437421	CA1584IR	437510	CA1318IR	437634	CA1034IR
437338	JA994IR	437422	CA1581IR	437511	CA1563IR	437635	CA1216IR
437339	CA1836IR	437423	CA1661IR	437512	JA1176IR	437636	CA1500IR
437340	CA1540IR	437424	CA1829IR	437513	CA1402IR	437637	JA753IR
437341	CA1541IR	437426	CA2052IR	437514	JA976IR	437638	JA682IR
437342	CA1641IR	437427	CA1083IR	437515	JA1405IR	437639	JA1531IR
437343	CA1642IR	437428	CA1637IR	437516	CA1088IR	437640	JA1605IR
437344	CA1641IR	437429	CA1388IR	437517	JA987IR	437641	CA1075IR
437345	CA1640IR	437430	CA1752IR	437518	CA1552IR	437642	CA1489IR

O.E. NO.	HC-PARTS	O.E. NO.	HC-PARTS	O.E. NO.	HC-PARTS	O.E. NO.	HC-PARTS
<b>VALEO Continued</b>							
437643	JA988IR	437735	CA1190IR	437829	JA1377IR	438111	CS1345
437644	CA1318IR	437736	JA685IR	437834	CA1206IR	438112	CS1344
437645	JA1272IR	437737	CA2024IR	437835	JA668IR	438113	JS768
437646	CG19	437738	CA1259IR	437836	JA1071R	438114	JS636
437647	CA1644IR	437739	JA750IR	437838	JA1891R	438115	JS1146
437648	JA877IR	437740	CA737IR	437840	JA1120IR	438118	JS628
437649	CA1257IR	437741	CA1547IR	437841	JA1941R	438119	JS1004
437650	JA1283	437742	CA1548IR	437842	JA1287IR	438120	JS781
437651	CA1385IR	437743	CA322IR	437843	JA1671R	438121	JS769
437652	CA1189IR	437744	CA1478IR	437847	JA1422IR	438123	JS344
437653	CA1491IR	437745	CA1492IR	437849	CA646IR	438131	CS879
437654	JA1426IR	437747	JA868IR	437851	CA1258IR	438132	JS1353
437655	CA1147IR	437748	CA1138IR	437852	CA1252IR	438133	CS1260
437656	CA1260IR	437749	CA1555IR	437860	JA661IR	438134	CS1174
437657	CA700IR	437750	JA776IR	437861	JA565IR	438135	JS1305
437658	JA652IR	437751	UA960	437862	CA1246IR	438137	JS1226
437659	CA1636IR	437752	JA782IR	437864	JA1164IR	438138	CS1343
437660	CA1299IR	437753	JA1119IR	437865	JA774IR	438141	JS517
437662	CA1732IR	437754	CA1204IR	437869	CA822IR	438144	CS1379
437663	CA1074IR	437755	JA1539IR	437870	JA1831R	438145	CS1345
437664	CA1075IR	437756	CA1217IR	437875	JA1122IR	438146	CS1338
437665	JA142IR	437757	JA991IR	437876	JA678IR	438147	CS1384
437666	CA1671IR	437758	CA841IR	437877	JA1117IR	438148	CS613
437667	JA1415IR	437759	JA885IR	437879	JA143	438151	CS1328
437668	CA1221IR	437760	JA1424IR	437881	JA873IR	438152	CS1181
437669	CA1220IR	437761	JA767IR	438010	CS1169	438156	JS1307
437670	CA1160IR	437763	CA1254IR	438011	CS1108	438158	CS1207
437672	CA1471IR	437764	JA975IR	438014	CS727	438159	JS759
437673	CA1485IR	437765	JA995IR	438015	JS1147	438162	CS1288
437674	CA1585IR	437766	JA1290IR	438017	JS923	438163	CS1276
437675	CA1477IR	437769	JA1599IR	438019	CS1131	438165	CS1342
437676	JA1167IR	437770	CA1234IR	438023	JS1216	438166	CS1329
437677	CA645IR	437771	CA1452IR	438024	JS648	438168	CS1346
437679	CA1159IR	437773	JA1407IR	438026	CS1127	438169	CS1118
437680	JA753IR	437774	CA1085IR	438027	CS1117	438170	CS1207
437681	JA805IR	437775	JA531IR	438030	CS1177	438171	CS1294
437682	JA599IR	437776	JA989IR	438031	CS99	438172	CS1330
437683	JA990IR	437777	JA185IR	438037	CS546	438173	CS1324
437684	JA666IR	437778	JA1162IR	438039	CS699	438174	CS1347
437685	JA780IR	437779	JA193	438040	CS617	438175	CS1293
437686	CA727IR	437780	CA1348IR	438041	CS198	438176	CS1323
437688	CA1316IR	437781	JA1133IR	438042	CS526	438178	JS1091
437689	CA1441IR	437782	JA869IR	438043	CS564	438183	CS519
437690	CA1639IR	437783	CA1069IR	438045	CS881	438184	CS1387
437691	CA1349IR	437784	JA1292IR	438047	CS121	438186	CS885
437692	JA1361IR	437785	CA1222IR	438051	CS962	438189	CS1391
437693	CA1158IR	437786	CA1218IR	438052	CS285	438190	CS1401
437694	CA1081IR	437787	CA1031IR	438053	CS374	438192	CS1407
437695	JA677IR	437788	CA719IR	438054	CS1174	438193	CS1342
437696	CA1255IR	437788	CA900IR	438060	CS1107	438197	CS1277
437697	JA1376IR	437792	CA1543IR	438061	CS1058	438198	CS1210
437698	JA1293IR	437793	JA555IR	438065	CS977	438199	CS360
437700	JA180IR	437794	JA670IR	438068	CS594	438200	CS1416
437701	CA1480IR	437795	CA381IR	438069	CS1177	438201	CS1478
437702	UA1213	437796	JA672IR	438071	JS1216	438202	CS1415
437704	CA1386IR	437798	CA1685IR	438073	CS1211	438207	CS715
437705	JA777	437801	CA1300IR	438074	CS784	438216	CS1330
437706	JA1271IR	437802	CA1443IR	438075	CS789	438217	CS1415
437707	JA880IR	437804	CA626IR	438076	CS974	438219	CS1470
437708	CA1440IR	437805	JA178IR	438077	CS801	438224	CS1332
437710	CA1586IR	437806	CA1206IR	438079	CS1117	438226	CS1323
437711	CA1439IR	437807	CA1299IR	438081	CS1186	438227	CS1480
437712	JA973IR	437808	CA840IR	438082	JS1147	438229	CS1322
437713	CA1301IR	437809	JA195	438087	CS1290	438254	CS1505
437714	JA1374IR	437810	JA571IR	438088	CS1263	438257	CS1508
437715	JA1364IR	437811	JA555IR	438090	CS1193	438263	CS1415
437717	CA511IR	437812	JA187IR	438092	CS1244	438322	JS671
437718	JA697IR	437813	CA506IR	438093	CS1111	439000	CA733IR
437720	JA760IR	437814	CA1084IR	438095	CS1193	439001	CA827IR
437723	CA1239IR	437815	CA1199IR	438096	CS1281	439003	CA736IR
437724	JA754IR	437818	CA591IR	438097	JS349	439004	CA912IR
437725	JA759IR	437819	CA1472IR	438098	JS643	439006	CA837IR
437726	JA1356IR	437820	JA1293IR	438099	JS1304	439007	CA1398IR
437727	CA1299IR	437821	JA194IR	438101	JS1303	439012	CA829IR
437728	JA803IR	437822	JA1430IR	438102	JS922	439020	CA914IR
437729	CA1300IR	437824	JA196	438104	JS633	439021	CA556IR
437731	JA773IR	437825	CA1191IR	438105	JS350	439023	CA1086IR
437732	CA644IR	437827	JA147IR	438106	CS1278	439024	CA836IR
437734	CA1230IR	437828	CA1745IR	438110	CS1174	439025	CA1098IR



O.E. NO.	HC-PARTS	O.E. NO.	HC-PARTS	O.E. NO.	HC-PARTS	O.E. NO.	HC-PARTS
439030	CA890IR	439292	CA1627IR	439469	CA2052IR	439597	CA2053IR
439031	CA827IR	439294	CA1553IR	439470	CA1388IR	439600	CA1904IR
439034	CA851IR	439296	CA1689IR	439471	CA1752IR	439604	CA1905IR
439035	CA1449IR	439298	CA1872IR	439472	CA1781IR	439605	CA2095IR
439036	CA1332IR	439299	CA1623IR	439473	CA1778IR	439606	CA2100IR
439038	CA845IR	439301	CA1631IR	439474	CA1767IR	439607	CA1906IR
439039	CA1038IR	439302	CA1444IR	439475	CA1762IR	439612	CA2044IR
439045	CA375IR	439303	CA1835IR	439478	CA1814IR	439613	CA2041IR
439047	CA361IR	439305	CA1756IR	439479	CA1768IR	439617	CA1954IR
439048	CA288IR	439306	CA1628IR	439480	CA1622IR	439619	CA2038IR
439053	CA1247IR	439307	CA1656IR	439481	CA1675IR	439620	CA1920IR
439054	CA1203IR	439308	CA1298IR	439482	CA1755IR	439621	CA2051IR
439056	CA1065IR	439310	CA1436IR	439485	CA1905IR	439622	CA2008IR
439062	CA1150IR	439311	CA1378IR	439486	CA1825IR	439625	CA1866IR
439064	CA1039IR	439312	CA1394IR	439487	CA1757IR	439630	CA2089IR
439065	CA1157IR	439317	CA1982IR	439488	CA1758IR	439631	CA2090IR
439069	CA1139IR	439318	CA1771IR	439489	CA1782IR	439632	CA2091IR
439070	CA1323IR	439319	CA1572IR	439490	JA1725IR	439633	CA1970IR
439072	CA1156IR	439325	CA716IR	439491	CA1817IR	439635	CA2031IR
439079	CA1336IR	439326	CA1836IR	439493	CA1761IR	439637	CA2056IR
439083	CA1052IR	439327	CA1540IR	439494	CA1687IR	439638	CS370
439092	CA1041IR	439328	CA1541IR	439495	CA1665IR	439643	CA1992IR
439093	CA1400IR	439330	CA1642IR	439497	CA1060IR	439646	CA1974IR
439094	CA1243IR	439331	CA1641IR	439498	CA1769IR	439651	JA1789IR
439095	CA1044IR	439333	CA1390IR	439500	CA1818IR	439653	CA2072IR
439098	CA1382IR	439338	CA1546IR	439501	CA1810IR	439661	CA2098IR
439099	CA1383IR	439339	CA1643IR	439502	CA1761IR	439662	CA2101IR
439103	CA1583IR	439340	CA2037IR	439503	CA1674IR	439669	CA1089IR
439104	CA1334IR	439341	CA1645IR	439504	CA1855IR	439680	CA1933IR
439105	CA1312IR	439343	JA689IR	439505	CA1862IR	439690	CA2030IR
439130	CA1041IR	439346	JA879IR	439506	CA1856IR	439691	CA1498IR
439166	CA1388IR	439384	JA1715IR	439507	CA1325IR	439692	CA1499IR
439167	CA1104IR	439385	JA994IR	439509	JA1172IR	439693	CA1665IR
439180	CA224IR	439391	CA1588IR	439511	CA1729IR	439695	CA1665IR
439181	CA1192IR	439392	CA1746IR	439521	CA1741IR	439697	CA2008IR
439182	CA1343IR	439393	CA1811IR	439523	CA1855IR	439701	CA2033IR
439183	CA898IR	439394	CA1662IR	439524	CA1862IR	439703	CA2031IR
439198	CA1395IR	439395	CA1754IR	439525	JA1607IR	439728	CA1993IR
439205	CA1302IR	439396	CA1813IR	439527	CA1937IR	439729	CA1758IR
439206	CA1342IR	439397	CA1256IR	439529	CA1402IR	440001	CA1223IR
439206	CA1398IR	439398	CA1591IR	439530	CA1062IR	440003	CA1582IR
439208	CA1303IR	439404	JA180IR	439531	CA1090IR	440004	CA1141IR
439212	CA1331IR	439408	JA690IR	439539	CA1934IR	440007	CA1832IR
439215	CA1345IR	439410	JA995IR	439540	CA1481IR	440008	JA1415IR
439223	CA1256IR	439411	JA685IR	439544	CA1875IR	440012	CA2025IR
439226	CA1484IR	439415	JA684IR	439545	CA1904IR	440017	CA1589IR
439229	CA1495IR	439417	CA1976IR	439550	CA1963IR	440023	JA1422IR
439230	CA1304IR	439420	CA1872IR	439551	CA1874IR	440024	CA1085IR
439231	CA1049IR	439427	CA1053IR	439552	CA1873IR	440025	CA1813IR
439232	CA1390IR	439429	CA1637IR	439553	CA1879IR	440026	JA1526IR
439234	CA1591IR	439430	CA1484IR	439555	CA1477IR	440027	CA588IR
439235	CA1559IR	439435	CA1646IR	439556	CA2002IR	440028	CA1881IR
439236	CA1569IR	439436	CA1502IR	439557	CA1911IR	440034	CA1959IR
439237	CA1578IR	439437	CA1511IR	439558	CA1912IR	440035	CA1936IR
439240	CA314IR	439438	CA1566IR	439559	CA1905IR	440036	CA2043IR
439241	CA854IR	439439	CA1568IR	439560	CA1953IR	440038	CA1921IR
439243	CA291IR	439440	CA1504IR	439561	CA1762IR	440039	CA1996IR
439244	CA1044IR	439441	CA1446IR	439563	CA1985IR	440044	CA1688IR
439245	CA1062IR	439442	CA1512IR	439567	CA1757IR	440048	CA1403IR
439248	CA1564IR	439443	CA1567IR	439568	CA1879IR	440051	CA1253IR
439252	CA1584IR	439444	CA1560IR	439570	CA1254IR	440053	CA2055IR
439255	CA1586IR	439445	CA1542IR	439571	CA2025IR	440054	CA1858IR
439257	CA1509IR	439446	CA1584IR	439573	CA1589IR	440055	CA1100IR
439258	CA1750IR	439447	CA2008IR	439575	CA1881IR	440056	CA1933IR
439261	CA1546IR	439448	CA1622IR	439576	CA1959IR	440057	CA2038IR
439263	CA1664IR	439450	CA1756IR	439577	CA1936IR	440058	JA974IR
439265	CA1588IR	439451	CA1675IR	439578	CA2043IR	440059	CA2058IR
439266	CA1622IR	439453	CA1490IR	439580	CA1921IR	440060	CA2057IR
439268	CA1641IR	439454	CA1391IR	439581	CA1996IR	440061	CA1824IR
439270	CA1065IR	439455	CA1680IR	439583	CA2055IR	440062	CA1470IR
439271	CA1759IR	439456	JA1279IR	439584	CA1933IR	440063	CA1993IR
439275	CA1498IR	439457	CA861IR	439586	CA1092IR	440065	CA2003IR
439282	CA1303IR	439458	CA738IR	439587	CA2058IR	440067	CA1824IR
439283	CA1322IR	439459	CA1757IR	439588	CA2057IR	440068	CA1975IR
439284	CA1621IR	439460	CA1746IR	439591	CA2003IR	440069	CA1691IR
439285	CA1307IR	439461	CA1512IR	439593	CA1975IR	440074	CA1977IR
439286	CA1309IR	439463	CA1584IR	439594	CA1045IR	440088	CA1679IR
439287	CA1306IR	439464	CA1661IR	439595	CA1977IR	440092	CA2054IR
439289	CA1333IR	439467	CA1829IR	439596	CA2054IR	440094	CA1877IR

O.E. NO.	HC-PARTS	O.E. NO.	HC-PARTS	O.E. NO.	HC-PARTS	O.E. NO.	HC-PARTS
<b>VALEO Continued</b>							
440098	JA758IR	455503	CS1262	455579	JS765	455692	CS333
440099	JA1178IR	455505	CS194	455580	JS356	455693	CS1060
440101	JA683IR	455506	JS325	455581	JS765	455694	CS354
440102	JA1514IR	455508	CS370	455582	JS627	455695	CS684
440103	JA1789IR	455509	CS983	455583	JS325	455696	CS322
440104	JA1789IR	455511	CS371	455584	JS891	455697	CS886
440105	JA1611IR	455512	CS566	455585	JS538	455698	CS978
440106	CA1904IR	455514	CS1177	455586	JS336	455699	CS519
440107	CA1905IR	455514	CS594	455587	JS333	455700	CS535
440108	CA2095IR	455516	CS530	455588	JS626	455702	CS1251
440109	CA2100IR *	455517	CS232	455589	JS311	455704	CS1278
440112	JA775IR	455518	CS394	455590	JS1022	455715	JS648
440113	JA1165IR	455519	CS501	455591	JS371	455716	JS648
440115	JA1607IR	455520	CS231	455592	JS382	455717	JS1152
440116	JA1790IR	455522	CS502	455593	JS365	455719	CS684
440118	JA1523IR	455523	CS526	455594	JS636	455720	CS1044
440119	JA1708IR	455524	CS564	455595	JS317	455722	CS1385
440120	JA1515IR	455525	CS387	455596	JS392	455723	CS1164
440121	CA1523IR	455526	CS546	455597	JS377	455724	CS719
440122	JA1600IR	455526	CS554	455598	JS360	455725	CS613
440123	CA1906IR	455527	CS186	455599	JS376	455726	CS708
440131	CA1050IR	455528	CS120	455600	JS390	455727	CS713
440132	CA1694IR	455529	CS120	455601	JS657	455728	CS880
440134	CA1448IR	455530	CS198	455602	JS998	455733	CS1169
440135	CA2044IR *	455531	CS191	455603	JS661	455734	CS1108
440137	CA1505IR	455532	CS269	455604	JS377	455736	CS727
440148	CA1475IR	455533	CS97	455605	JS316	455737	JS1147
440174	CA1954IR	455534	CS1040	455606	JS365	455738	CS681
440176	CA2038IR	455535	CS121	455607	JS325	455739	JS923
440177	CA1920IR	455536	CS1443	455608	JS640	455740	JS922
440178	CA2053IR	455536	CS391	455609	JS349	455741	CS1131
440179	CA2051IR *	455537	CS783	455610	JS350	455743	JS651
440180	CA2008IR	455538	CS699	455611	JS309	455744	JS753
440183	CA2041IR	455539	CS544	455612	JS325	455745	CS1055
440185	CA1866IR	455540	CS99	455613	JS327	455746	CS341
440191	CA1475IR	455541	CS881	455614	JS335	455747	CS1117
440192	CA1638IR	455542	CS617	455615	JS336	455748	CS581
440193	CA1857IR	455543	CS99	455616	JS385	455749	CS1177
440194	CA1031IR	455544	CS99	455617	JS357	455774	CS708
440194	CA719IR	455546	CS546	455618	CS388	455807	CS1056
440195	CA1508IR	455547	CS723	455619	CS194	455840	CS722
440196	CA1317IR	455548	CS618	455620	CS384	455871	CS962
440197	CA2089IR *	455548	CS713	455621	CS120	455872	CS975
440198	CA2090IR *	455549	CS523	455622	CS531	455873	CS374
440199	CA2091IR *	455550	CS684	455623	CS186	455876	CS1174
440200	CA1970IR	455551	CS882	455624	CS595	455877	CS786
440202	CA2031IR	455552	CS964	455625	CS576	455878	CS787
440204	CA2056IR *	455553	CS796	455626	CS683	455879	CS879
440209	CA1992IR	455554	CS1162	455627	CS554	455881	JS568
440212	CA1827IR	455555	JS342	455628	CS1167	455884	JS672
440214	CA1741IR	455557	JS322	455629	CS598	455885	CS982
440216	CA1974IR	455558	JS327	455630	CS599	455886	JS651
440220	CA1575IR	455559	JS331	455631	CS531	455887	JS941
440221	CA1576IR	455560	JS520	455632	CS1106	455887	JS941
440222	CA1760IR	455561	JS349	455633	CS807	455888	CS802
440223	CA1487IR	455561	JS350	455634	JS339	455889	CS984
440224	CA1635IR	455562	JS349	455635	CS592	455890	CS1107
440226	CA1544IR	455562	JS350	455636	CS562	455891	CS1058
440227	CA1628IR	455563	JS355	455637	JS325	455892	CS961
440228	CA1587IR	455564	JS300	455638	CS516	455893	CS1107
440229	CA1549IR	455565	JS302	455639	CS619	455894	CS986
440230	CA1446IR	455566	JS303	455640	CS559	455895	CS977
440234	CA1652IR	455567	JS389	455641	CS360	455896	CS613
440235	CA1863IR	455568	JS304	455642	CS616	455897	CS589
440236	CA1881IR	455569	JS305	455643	CS377	455898	CS885
440238	CA2072IR *	455570	JS306	455644	CS515	455899	CS885
440246	CA2098IR *	455571	JS399	455645	CS332	455900	CS885
440247	CA2101IR *	455572	JS358	455646	CS392	455901	JS380
440265	CA1933IR	455573	JS310	455647	CS612	455902	JS758
440275	CA2030IR	455574	JS359	455648	CS119	455903	CS685
440279	CA1879IR	455575	JS310	455649	CS577	455904	CS592
440282	CA2008IR	455575	JS315	455650	CS577	455905	JS344
440286	CA2033IR	455576	JS310	455651	CS348	455906	JS553
440291	CA2031IR	455576	JS315	455652	CS330	455907	JS658
440348	CA1865IR	455577	JS356	455653	CS972	455908	JS343
440349	CA1989IR	455577	JS765	455654	CS328	455909	JS364
455022	CS592	455578	JS319	455655	CS542	455909	JS556
455500	CS333	455578	JS645	455656	CS1128	455910	JS329
455502	CS688	455579	JS356	455657	CS980	455910	JS343
				455658	CS1177	455910	JS751

O.E. NO.	HC-PARTS	O.E. NO.	HC-PARTS	O.E. NO.	HC-PARTS	O.E. NO.	HC-PARTS
455911.....	JS660	458174.....	CS1061	458291.....	CS1415	458490.....	JS1150
455912.....	JS650	458175.....	CS1274	458292.....	CS1279	458491.....	JS770
455913.....	JS378	458176.....	CS1077	458293.....	CS1348	458492.....	CS988
455915.....	JS637	458177.....	CS1112	458296.....	JS894	458494.....	CS888
455916.....	JS670	458178.....	CS1288	458310.....	JS911	458495.....	CS1165
455917.....	JS557	458179.....	CS1276	458311.....	JS917	458498.....	CS1254
455918.....	JS1366	458180.....	CS1342	458312.....	JS513	458499.....	CS562
455918.....	JS671	458181.....	CS985	458314.....	JS1230	458500.....	CS585
455919.....	JS671	458183.....	CS1464	458315.....	JS902	458501.....	CS1160
455921.....	JS339	458184.....	CS879	458317.....	JS1156	458502.....	CS117
455922.....	JS335	458185.....	CS1329	458318.....	JS512	458503.....	JS357
455923.....	JS525	458187.....	JS1146	458319.....	JS512	458504.....	CS973
455924.....	JS1105	458188.....	CS519	458320.....	JS1224	458505.....	CS1213
455925.....	JS552	458189.....	CS1179	458321.....	JS1366	458506.....	JS1140
455926.....	CS194	458190.....	CS680	458322.....	JS671	458508.....	JS894
455927.....	CS974	458191.....	CS1346	458323.....	JS671	458509.....	JS918
455928.....	CS594	458192.....	CS1118	458324.....	JS1234	458511.....	CS1194
455929.....	CS1177	458193.....	CS965	458326.....	JS1136	458512.....	CS1125
455930.....	CS789	458194.....	CS375	458327.....	JS1299	458513.....	CS1041
455932.....	JS1216	458195.....	CS585	458328.....	CS1500	458514.....	JS1135
455933.....	CS624	458196.....	CS1255	458329.....	CS1382	458515.....	JS1138
455934.....	CS1211	458198.....	CS1269	458330.....	CS1129	458517.....	CS878
455936.....	CS784	458199.....	CS1199	458331.....	CS1331	458518.....	JS1149
455937.....	CS715	458200.....	CS1169	458333.....	CS1163	458519.....	CS578
455939.....	CS974	458201.....	CS1161	458334.....	CS1292	458520.....	JS1094
455940.....	JS1091	458202.....	CS721	458335.....	CS1243	458521.....	CS1272
455942.....	CS601	458203.....	CS691	458336.....	CS269	458522.....	JS1300
455943.....	CS684	458204.....	CS963	458337.....	CS1178	458523.....	CS611
455945.....	CS326	458205.....	CS1210	458339.....	CS1116	458526.....	JS1214
455946.....	CS390	458206.....	JS627	458340.....	CS506	458527.....	JS557
455947.....	CS327	458207.....	JS637	458341.....	CS989	458528.....	CS1048
455949.....	CS1117	458208.....	CS1203	458342.....	CS1274	458529.....	JS629
455950.....	CS1186	458209.....	CS191	458343.....	CS595	458531.....	JS1086
455951.....	JS1147	458210.....	CS1207	458345.....	CS1449	458533.....	JS632
455954.....	CS1207	458211.....	CS1074	458365.....	CS1330	458534.....	CS1140
455955.....	CS581	458212.....	CS1045	458366.....	CS1252	458536.....	JS638
455956.....	CS1290	458213.....	CS1294	458367.....	CS1415	458537.....	JS754
455957.....	CS1263	458214.....	CS1330	458370.....	CS1050	458538.....	CS1187
455959.....	CS1193	458215.....	CS1324	458371.....	CS1245	458539.....	CS1046
455961.....	CS1244	458216.....	CS1347	458372.....	CS1470	458540.....	CS508
455962.....	CS1111	458217.....	CS1293	458374.....	CS1246	458541.....	JS558
455963.....	JS349	458218.....	CS1323	458376.....	CS1050	458545.....	CS588
455964.....	JS643	458219.....	JS1158	458378.....	CS1242	458546.....	JS628
455968.....	JS922	458220.....	CS1114	458379.....	JS1321	458547.....	JS999
455969.....	JS923	458221.....	CS1119	458380.....	CS1336	458548.....	CS1326
455971.....	CS1193	458222.....	CS372	458381.....	JS1320	458550.....	CS1335
455972.....	CS1281	458223.....	CS1172	458382.....	JS939	458551.....	CS1241
455973.....	CS519	458224.....	CS1188	458385.....	CS1062	458552.....	CS1047
455974.....	CS1174	458226.....	CS1186	458386.....	CS1171	458553.....	JS924
455975.....	CS1345	458227.....	CS371	458388.....	CS1332	458555.....	CS1196
455976.....	CS1344	458228.....	CS519	458390.....	CS1323	458556.....	CS611
455977.....	CS798	458229.....	CS610	458391.....	CS1480	458557.....	JS781
455978.....	CS541	458230.....	CS981	458414.....	CS1505	458558.....	JS1006
455979.....	CS597	458231.....	CS1387	458417.....	CS1508	458559.....	JS667
455980.....	JS1353	458232.....	CS1113	458423.....	CS1415	458560.....	JS534
455981.....	CS788	458233.....	JS1096	458460.....	CS1067	458561.....	CS800
455982.....	CS1260	458237.....	CS1391	458461.....	CS1208	458563.....	CS794
455983.....	CS1174	458238.....	CS1401	458462.....	CS1072	458565.....	JS1090
455984.....	JS1305	458239.....	CS1273	458463.....	JS1016	458566.....	CS1049
455985.....	JS1307	458240.....	CS1072	458464.....	CS725	458567.....	JS1083
458027.....	JS560	458247.....	JS1079	458466.....	CS971	458568.....	CS1078
458041.....	CS801	458248.....	CS1407	458467.....	CS1063	458569.....	CS508
458116.....	CS1050	458249.....	CS1342	458469.....	CS1202	458573.....	JS942
458117.....	CS1050	458253.....	CS1049	458470.....	CS1245	458577.....	JS1153
458118.....	CS613	458254.....	CS1261	458471.....	CS1206	458579.....	JS892
458159.....	JS1226	458257.....	CS725	458473.....	CS792	458580.....	JS1088
458160.....	CS1343	458260.....	JS1135	458475.....	CS1256	458581.....	JS937
458161.....	JS517	458263.....	CS1179	458476.....	CS1053	458583.....	JS655
458162.....	CS1379	458265.....	CS992	458477.....	JS1092	458584.....	JS1005
458163.....	CS1345	458269.....	CS1267	458479.....	JS1023	458585.....	CS1212
458164.....	CS1338	458274.....	CS1255	458480.....	JS1080	458586.....	CS1200
458165.....	CS1384	458277.....	CS1277	458481.....	JS747	458587.....	JS1021
458166.....	CS1328	458278.....	CS1110	458482.....	CS1197	458588.....	CS1065
458167.....	CS1181	458280.....	CS1203	458483.....	JS766	458590.....	JS1103
458168.....	CS610	458285.....	JS913	458484.....	CS620	458592.....	JS646
458169.....	CS976	458286.....	CS1063	458485.....	JS1236	458593.....	CS709
458170.....	JS1307	458288.....	JS1314	458486.....	CS1198	458599.....	JS669
458172.....	CS1207	458289.....	CS1416	458487.....	JS670	458600.....	JS1143
458173.....	JS759	458290.....	CS1478	458488.....	CS583	458601.....	JS943

O.E. NO.	HC-PARTS	O.E. NO.	HC-PARTS	O.E. NO.	HC-PARTS	O.E. NO.	HC-PARTS
VALEO <i>Continued</i>							
458607	JS1314	600045	JA666IR	746018	CA1498IR	2521682	CA1042IR
458608	JS668	600046	JA1804IR	746020	CA1446IR	2522104	CA858IR
458610	CS622	600047	JA870IR	746021	CA1065IR	2541112	CA581IR
458611	JS521	600049	JA1709IR	746022	CA380IR	2541114	CA503IR
458612	CS1175	600052	JA682IR	746023	JA1172IR	2541115	CA608IR
458613	CS1180	600054	JA1271IR	746024	CA602IR	2541116	CA728IR
458614	JS768	600055	JA878IR	746025	CA1394IR	2541117	CA549IR
458616	CS184	600056	JA1130IR	746026	CA1304IR	2541118	CA649IR
458617	CS1170	600058	JS1000	746027	CA1762IR	2541119	CA524IR
458618	JS337	600059	JS633	746029	CA317IR	2541120	CA557IR
458619	JS390	600060	JS923	746030	CA635IR	2541121	CA605IR
458620	JS913	600062	JS1313	746031	CA618IR	2541122	CA527IR
458621	JS316	600065	JS1004	746032	CA1761IR	2541124	CA602IR
458622	JS386	600070	JS1313	746033	CA1217IR	2541127	CA838IR
458623	JS383	600072	JS770	746034	CA1034IR	2541130	CA1387IR
458624	JS752	600074	JS1098	746036	CA1098IR	2541131	CA1387IR
458625	CS329	600076	JS658	746038	CA1496IR	2541139	CA609IR
458627	CS711	600077	JS658	746041	CA715IR	2541142	CA525IR
458629	JS630	600078	JS1355	746042	CA1378IR	2541147	CA748IR
458631	JS1104	600081	JS1351	746043	CA1850IR	2541148	CA1387IR
458632	JS762	600083	JS1303	746044	CA1400IR	2541151	CA625IR
458634	JS560	600084	JS1311	746046	CA1080IR	2541154	CA894IR
499526	CA380IR	600093	JA1903IR	746047	CA638IR	2541156	CA526IR
510372	CA187IR	600500	JS922	746049	JA863IR	2541159	CA612IR
510391	CA212IR	626002	CS1277	746050	CA632IR	2541160	CA640IR
510426	CA341IR	726000	CS581	746051	CA825IR	2541168	CA857IR
510803	CA743IR	726001	CS681	746053	CA733IR	2541169	CA359IR
510804	CA744IR	726002	CS519	746054	CA1309IR	2541170	CA533IR
510834	CA742IR	726003	CS1057	746055	CA321IR	2541171	CA380IR
510847	CA176IR	726004	CS594	746056	CA890IR	2541173	CA574IR
514002	CA235IR	726005	CS1177	746057	CA827IR	2541174	CA711IR
518039	CA1192IR	726006	CS977	746058	CA1306IR	2541178	CA558IR
523161	CA240IR	726007	JS1158	746059	CA1640IR	2541180	CA294IR
541147	CA550IR	726008	CS1044	746060	CA1203IR	2541181	CA525IR
541147	CA748IR	726009	CS784	746061	CA1750IR	2541182	CA380IR
541178	CA558IR	726012	CS341	746062	CA1653IR	2541187	CA313IR
541314	CA1101IR	726013	JS941	746063	CA99IR	2541188	CA587IR
542746	CA1675IR	726014	CS684	746064	CA893IR	2541189	CA556IR
549277	CA1310IR	726015	CS310	746065	CA736IR	2541191	CA1192IR
567051	JA1172IR	726016	CS610	746066	CA740IR	2541193	CA587IR
573387	CS370	726017	CS566	746067	CA1039IR	2541197	CA535IR
592601	CA857IR	726018	CS801	746068	CA851IR	2541199	CA858IR
592772	CA1192IR	726019	CS974	746069	CA350IR	2541202	CA634IR
592776	CA858IR	726020	CS796	893633	JA787IR	2541204	CA314IR
592778	CA558IR	726021	CS885	1195239	CS1465	2541221	CA588IR
592786	CA898IR	726022	CS1111	1195248	JS1303	2541222	CA376IR
594085	CS807	726023	CS788	1195921	CS1433	2541225	CA229IR
594213	CS1251	726024	CS1174	1250128	JS1355	2541226	CA830IR
594215	CS1128	726025	CS1344	1250128	JS1355	2541230	CA1105IR
594216	CS983	726026	CS618	1250295	JS1365	2541233	CA129IR
600000	JA1188IR	726029	CS974	1250299	JS923	2541234	CA129IR
600001	JA1600IR	726031	CS1207	1250300	JS922	2541235	CA252IR
600003	JA674IR	726032	CS1067	1250301	JS923	2541236	CA252IR
600005	JA1709IR	726033	CS684	1250302	JS922	2541245	CA605IR
600006	JA1717IR	726034	CS789	1250303	CS1462	2541247	CA606IR
600007	JA1537IR	726035	CS310	1250449	CS1441	2541248	CA607IR
600009	JA1786IR	726036	CS880	2104248	CA643IR	2541254	CA313IR
600010	JA1711IR	726037	CS612	2104264	CA568IR	2541257	CA549IR
600011	JS892	726039	CS1346	2181693	CA705IR	2541258	CA632IR
600012	JA1518IR	726040	CS986	2181699	CA229IR	2541259	CA633IR
600013	JA1786IR	726041	CS519	2181726	CA529IR	2541262	CA815IR
600015	JA180IR	726042	CS1162	2181727	CA557IR	2541264	CA87IR
600017	JA1798IR	726043	CS1045	2181729	CA148	2541290	CA564IR
600018	JA1717IR	746000	CA1553IR	2181730	CA224IR	2541297	CA345IR
600019	JA888IR	746001	CA1627IR	2181761	CA898IR	2541298	CA618IR
600020	JA1785IR	746003	CA1053IR	2181762	CA898IR	2541299	CA617IR
600021	JA1717IR	746004	CA549IR	2181991	CA857IR	2541300	CA609IR
600022	JA1537IR	746005	CA637IR	2183106	CA308IR	2541301	CA503IR
600024	JA1709IR	746006	CA1043IR	2518017	CA313IR	2541305	CA362IR
600026	JA1287IR	746007	JA1521IR	2518028	CA350IR	2541307	CA535IR
600028	JA1798IR	746008	CA1541IR	2518039	CA1192IR	2541308	CA818IR
600029	JA1798IR	746010	CA861IR	2518044	CA345IR	2541310	CA816IR
600030	JA688IR	746011	CA1442IR	2518046	CA321IR	2541311	CA819IR
600032	JA148IR	746012	CA1572IR	2518051	CA1387IR	2541313	CA635IR
600034	JA995IR	746013	CA889IR	2518054	CA332IR	2541321	CA845IR
600037	JA877IR	746014	CA1509IR	2518057	CA150IR	2541323	CA148
600041	JA684IR	746015	CA1564IR	2518058	CA150IR	2541324	CA314IR
600043	JA870IR	746016	CA1038IR	2518085	CA579IR	2541325	CA716IR
600044	JA1788IR	746017	CA1581IR	2518086	CA534IR	2541327	CA838IR

O.E. NO.	HC-PARTS	O.E. NO.	HC-PARTS	O.E. NO.	HC-PARTS	O.E. NO.	HC-PARTS
2541328	CA635IR	2541494	CA1064IR	2541784	CA1052IR	2541954	CA1444IR
2541329	CA558IR	2541497	CA897IR	2541785	CA1152IR	2541959	CA1062IR
2541331	CA557IR	2541498	CA1073IR	2541786	CA1156IR	2541960	CA1044IR
2541339	CA1251IR	2541499	CA1054IR	2541788	CA1077IR	2541961	CA1569IR
2541340	CA895IR	2541600	CA896IR	2541789	CA1078IR	2541962	CA1578IR
2541341	CA264IR	2541602	CA816IR	2541790	CA1250IR	2541963	CA1591IR
2541344	CA817IR	2541603	CA1059IR	2541791	CA1200IR	2541965	CA1305IR
2541348	CA837IR	2541604	CA1320IR	2541792	CA1079IR	2541967	CA1392IR
2541349	CA720IR	2541608	CA1040IR	2541793	CA556IR	2541968	CA1390IR
2541350	CA713IR	2541609	CA1056IR	2541797	CA1077IR	2541969	CA1442IR
2541354	CA634IR	2541610	CA1036IR	2541801	CA1265IR	2541970	CA1496IR
2541355	CA729IR	2541612	CA1449IR	2541802	CA827IR ▲	2541971	CA1564IR
2541356	CA729IR	2541613	CA818IR	2541804	CA1102IR	2541976	CA1303IR
2541359	CA716IR	2541617	CA1332IR	2541808	CA716IR ▲	2541977	CA1322IR
2541360	CA639IR	2541618	CA1336IR	2541809	CA1056IR	2541978	CA1306IR
2541361	CA648IR	2541619	CA851IR	2541810	CA1339IR	2541979	CA1333IR
2541362	CA648IR	2541620	CA1041IR	2541811	CA1256IR	2541980	CA1484IR
2541363	CA359IR	2541624	CA1049IR	2541812	CA1269IR	2541981	CA1309IR
2541364	CA533IR	2541625	CA914IR	2541813	CA716IR	2541982	CA1309IR
2541365	CA587IR	2541626	CA829IR	2541815	CA736IR	2541983	CA1308IR
2541366	CA294IR	2541635	CA1336IR	2541816	CA912IR	2541984	CA1333IR
2541367	CA525IR	2541641	CA1080IR	2541817	CA829IR	2541985	CA1319IR
2541368	CA380IR	2541642	CA896IR	2541819	CA827IR	2541988	CA1307IR
2541369	CA556IR	2541643	CA913IR	2541821	CA733IR	2541989	CA1331IR
2541372	CA1063IR	2541645	CA588IR	2541821	CA733IR	2541992	CA1044IR
2541376	CA150IR	2541648	CA1336IR	2541828	CA858IR	2541995	CA1395IR
2541384	CA529IR	2541655	CA556IR	2541834	CA1334IR	2541997	CA1504IR
2541386	CA1225IR	2541658	CA837IR	2541835	CA1323IR	2541998	CA1542IR
2541387	CA150IR	2541663	CA1192IR	2541838	CA1062IR	2541999	CA1306IR
2541393	CA821IR	2541665	CA825IR	2541839	CA1044IR	2542201	CA1495IR
2541394	CA1033IR	2541672	CA294IR ▲	2541840	CA1312IR	2542202	CA1338IR
2541399	CA350IR	2541675	CA827IR ▲	2541841	CA1388IR	2542203	CA1388IR
2541400	CA564IR	2541676	CA827IR	2541842	CA1338IR	2542203	CA1388IR
2541403	CA898IR	2541677	CA617IR	2541844	CA1486IR	2542223	CA1302IR
2541410	CA733IR	2541678	CA1039IR	2541848	CA1400IR	2542224	CA1307IR
2541412	CA852IR ▲	2541679	CA1157IR	2541849	CA558IR	2542225	CA1546IR
2541415	CA732IR	2541680	CA833IR	2541850	CA858IR	2542227	CA1546IR ▲
2541416	CA740IR	2541683	CA724IR	2541854	CA637IR	2542228	CA1509IR
2541417	CA736IR	2541684	CA1095IR	2541856	CA1139IR	2542231	CA1306IR
2541420	CA912IR	2541694	CA1150IR	2541858	CA716IR ▲	2542232	CA1759IR
2541423	CA212IR	2541695	CA889IR	2541859	CA574IR ▲	2542233	CA1588IR
2541424	CA605IR	2541696	CA1397IR ▲	2541861	CA1332IR	2542234	CA1541IR
2541428	CA859IR	2541697	CA1398IR	2541862	CA1243IR	2542237	CA1394IR
2541434	CA298IR	2541703	CA1086IR	2541863	CA1583IR	2542238	CA1545IR
2541435	CA376IR	2541710	CA637IR	2541873	CA1310IR	2542239	CA1540IR
2541438	CA302IR	2541711	CA836IR	2541875	CA1573IR ▲	2542240	CA1436IR
2541439	CA588IR	2541712	CA1383IR	2541879	CA1056IR	2542241	CA1378IR
2541441	CA376IR	2541713	CA1382IR	2541880	CA1096IR	2542244	CA1502IR
2541442	CA376IR	2541714	CA1383IR	2541882	CA1573IR	2542245	CA1446IR
2541443	CA848IR	2541717	CA1579IR	2541883	CA1573IR	2542251	CA1559IR
2541444	CA625IR	2541718	CA617IR	2541884	CA1400IR	2542252	CA1298IR
2541445	CA574IR	2541719	CA618IR	2541887	CA1036IR	2542253	CA1043IR
2541446	CA711IR	2541720	CA1095IR	2541894	CA837IR	2542254	CA1065IR
2541447	CA715IR	2541724	CA715IR	2541895	CA1139IR	2542255	CA1152IR
2541448	CA1104IR	2541725	CA1038IR	2541899	CA1309IR	2542256	CA1052IR
2541452	CA190IR	2541726	CA1203IR	2541903	CA1036IR	2542257	CA1511IR
2541455	CA713IR	2541728	CA890IR	2541905	CA896IR	2542258	CA1566IR
2541457	CA820IR	2541731	CA729IR	2541906	CA1036IR	2542259	CA1567IR
2541458	CA636IR	2541732	CA648IR	2541908	CA1079IR	2542260	CA1512IR
2541459	CA637IR	2541733	CA820IR	2541911	CA1044IR	2542262	CA836IR
2541460	CA849IR	2541735	CA637IR	2541912	CA1256IR	2542263	CA836IR ▲
2541461	CA638IR	2541738	CA639IR	2541914	CA1307IR	2542264	CA1584IR
2541464	CA165IR	2541740	CA638IR	2541916	CA1310IR	2542265	CA1631IR
2541465	CA317IR	2541741	CA730IR	2541917	CA1397IR	2542267	CA836IR
2541466	CA372IR	2541747	CA1099IR	2541919	CA1062IR	2542270	CA1506IR
2541467	CA529IR	2541750	CA1059IR	2541920	CA1044IR	2542271	CA1622IR
2541469	CA612IR	2541758	CA1065IR	2541922	CA1342IR	2542272	CA1627IR
2541471	CA375IR	2541759	CA1043IR	2541927	CA1434IR	2542273	CA1053IR
2541473	CA837IR	2541760	CA1098IR	2541928	CA1343IR	2542275	CA1344IR
2541475	CA730IR	2541763	CA618IR	2541937	CA1077IR	2542279	CA1568IR
2541476	CA854IR	2541764	CA1095IR	2541938	CA1077IR	2542280	CA1560IR
2541478	CA711IR ▲	2541765	CA820IR	2541941	CA1332IR	2542281	CA1504IR
2541479	CA859IR	2541767	CA715IR	2541942	CA1078IR	2542282	CA1542IR
2541480	CA1063IR	2541768	CA1048IR	2541945	CA1573IR ▲	2542284	CA2088IR *
2541481	CA1054IR	2541770	CA1247IR	2541946	CA1345IR	2542285	CA1498IR
2541485	CA1060IR	2541775	CA1062IR	2541947	CA1344IR	2542286	CA1499IR
2541489	CA294IR	2541776	CA1044IR	2541950	CA1086IR	2542287	CA1497IR
2541490	CA574IR	2541777	CA705IR	2541951	CA825IR	2542289	CA1392IR
2541491	CA711IR	2541778	CA898IR	2541953	CA1304IR	2542291	CA1342IR

O.E. NO.	HC-PARTS	O.E. NO.	HC-PARTS	O.E. NO.	HC-PARTS	O.E. NO.	HC-PARTS
VALEO	<i>Continued</i>						
2542294	CA1750IR	2542481	CA1484IR	2542685	CA1825IR	2542928	CA1879IR
2542295	CA1664IR	2542483	CA1442IR	2542686	CA1584IR	2542938	CA1879IR
2542297	CA1589IR	2542484	CA1498IR	2542687	CA1769IR	2542945	CA1762IR ▲
2542298	CA1392IR	2542485	CA1687IR	2542689	CA861IR	2542946	CA1933IR
2542302	CA1622IR	2542486	CA1496IR	2542691	CA1444IR	2542948	CA1446IR
2542305	CA1640IR	2542487	CA1499IR	2542693	CA1761IR	2542949	CA1394IR
2542307	CA1642IR	2542488	CA1665IR	2542694	JA1725IR	2542952	CA1873IR
2542308	CA1738IR	2542489	CA1564IR	2542695	CA1782IR	2542954	CA1874IR
2542309	CA1738IR	2542490	CA1589IR	2542696	CA1729IR	2542955	CA1875IR
2542310	CA1574IR	2542491	CA1681IR	2542697	CA1985IR	2542966	CA1959IR
2542312	CA2037IR	2542493	CA1650IR	2542704	CA1674IR	2543205	CA2058IR *
2542315	CA1303IR	2542494	CA1811IR	2542705	CA1850IR	2543206	CA1975IR
2542316	CA1322IR	2542495	CA1653IR	2542708	CA1781IR	2543207	CA2057IR
2542317	CA1689IR	2542496	CA1678IR	2542715	CA1622IR	2543208	CA2003IR
2542319	CA1872IR	2542497	CA1746IR	2542720	CA1953IR	2543210	CA1879IR
2542320	CA1656IR	2542500	CA1553IR	2542722	CA1661IR	2543215	CA1589IR
2542322	CA1506IR	2542507	CA1540IR	2542725	CA1761IR	2543222	CA2095IR *
2542323	CA1546IR ▲	2542508	CA1541IR	2542726	CA2008IR	2543223	CA2100IR *
2542324	CA1588IR	2542509	CA1754IR	2542729	CA1934IR	2543236	CA1757IR
2542326	CA1653IR ▲	2542514	CA1049IR	2542730	CA1810IR	2543237	CA1325IR
2542327	CA1621IR	2542515	CA1569IR	2542731	CA1817IR	2543248	CA2038IR
2542342	CA1484IR	2542516	CA1578IR	2542736	CA1758IR	2543264	CA1911IR
2542343	CA1756IR	2542523	CA1645IR	2542738	CA1754IR	2543290	CA2055IR
2542344	CA1641IR	2542524	CA1680IR	2542739	CA1811IR	2543291	CA1921IR
2542345	CA1623IR	2542525	CA1641IR	2542742	CA1741IR	2543292	CA1825IR
2542347	CA1390IR	2542526	CA1741IR	2542746	CA1675IR	2543302	CA1993IR
2542350	CA1066IR	2542531	CA1509IR	2542747	CA1755IR	2543303	CA1904IR
2542351	CA1553IR	2542538	CA1756IR ▲	2542749	CA1773IR	2543304	CA1905IR
2542352	CA1065IR	2542540	CA1637IR	2542749	CA1773IR	2543306	CA1904IR
2542354	CA1444IR	2542543	CA1391IR	2542749	CA1773IR	2543313	CA1769IR
2542355	CA1152IR	2542545	CA1490IR	2542751	CA2025IR	2543315	CA1996IR
2542356	CA1052IR	2542546	CA1588IR	2542753	CA1774IR	2543320	CA1378IR
2542357	CA1043IR	2542547	CA1646IR	2542767	CA1378IR	2543337	CA1814IR
2542358	CA1065IR	2542548	CA1628IR	2542769	CA1904IR	2543338	CA1661IR
2542359	CA1049IR	2542551	CA1572IR	2542771	CA1680IR	2543339	CA1627IR
2542363	CA1306IR	2542553	CA1622IR	2542772	CA1873IR	2543340	CA1645IR
2542364	CA1307IR	2542554	CA1814IR	2542774	CA1874IR	2543341	CA1829IR
2542365	CA1309IR	2542556	CA1509IR	2542783	CA1912IR	2543342	CA1768IR
2542366	CA1333IR	2542557	CA1674IR	2542784	CA1937IR	2543343	CA1767IR
2542367	CA1333IR	2542564	CA1553IR	2542793	CA1499IR	2543344	CA2025IR
2542368	CA1319IR	2542565	CA1778IR	2542794	CA1665IR	2543363	CA1873IR
2542375	CA1583IR ▲	2542572	CA1872IR ▲	2542797	CA1631IR	2543366	CA1881IR
2542376	CA1065IR	2542573	CA1662IR	2542802	CA1499IR	2543369	CA1811IR
2542377	CA1591IR	2542577	CA1755IR ▲	2542803	CA1665IR	2543370	CA1906IR
2542379	CA1256IR	2542578	CA1675IR ▲	2542812	CA1584IR	2543374	CA1910IR
2542388	CA1835IR	2542582	CA1752IR	2542813	CA1310IR	2543378	CA1933IR
2542393	CA1661IR	2542584	CA828IR	2542814	CA1310IR	2543384	CA1627IR
2542394	CA1498IR	2542587	CA1746IR	2542815	CA1650IR	2543385	CA1814IR
2542396	CA1499IR	2542602	CA1756IR	2542817	CA1814IR	2543386	CA1661IR
2542397	CA1589IR	2542603	CA1303IR	2542818	CA1768IR	2543387	CA1645IR
2542398	CA1640IR	2542605	CA1756IR	2542819	CA1767IR	2543388	CA1936IR
2542399	CA1641IR	2542608	CA1654IR	2542824	CA1584IR	2543390	CA1904IR
2542400	CA1642IR	2542609	CA1660IR	2542826	CA1584IR	2543400	CA1992IR
2542402	CA1813IR	2542611	CA1905IR	2542827	CA1910IR	2543406	CA2072IR *
2542411	CA1771IR	2542613	CA1905IR	2542832	CA1761IR	2543412	CA1873IR
2542412	CA1342IR	2542614	CA1622IR	2542839	CA1850IR	2543427	CA2091IR *
2542413	CA1390IR	2542615	CA1761IR	2542840	CA1560IR	2543439	CA2003IR
2542414	CA1390IR	2542619	CA1761IR	2542841	CA1855IR	2543441	CA1645IR
2542415	CA1310IR	2542637	CA1767IR	2542849	CA2037IR	2543444	CA2053IR
2542416	CA1310IR	2542639	CA1829IR	2542850	CA1855IR	2543457	CA1920IR
2542417	CA1086IR	2542640	CA1661IR	2542851	CA1862IR	2543461	CA2041IR
2542418	CA825IR	2542645	CA1622IR ▲	2542852	CA1757IR ▲	2543469	CA2054IR
2542420	CA1628IR	2542646	CA1622IR ▲	2542855	CA2043IR	2543476	CA2008IR
2542422	CA1976IR	2542646	CA1622IR ▲	2542861	CA1862IR	2543477	CA1862IR
2542427	CA1687IR	2542650	CA1512IR	2542875	CA1325IR	2543479	CA1934IR
2542428	CA1665IR	2542653	CA1627IR	2542880	CA1086IR	2543480	CA1855IR
2542429	CA1681IR	2542653	CA1627IR	2542884	CA1862IR	2543484	CA1856IR
2542432	CA1982IR	2542662	CA1584IR	2542891	CA1911IR	2543488	CA1977IR
2542433	CA1310IR	2542663	CA1768IR	2542892	CA2002IR	2543492	CA1509IR
2542441	CA1643IR	2542664	CA1762IR	2542897	CA1304IR	2543493	CA1553IR
2542461	CA1836IR	2542669	CA2052IR	2542898	CA1782IR	2543498	CA2038IR
2542464	CA1637IR	2542670	CA1862IR	2542920	CA1498IR	2543509	CA1866IR
2542466	CA1572IR	2542671	CA1856IR	2542921	CA1687IR	2543520	CA1687IR
2542470	CA1881IR	2542672	CA1757IR	2542922	CA1499IR	2543521	CA1665IR
2542471	CA1574IR	2542678	CA1442IR	2542923	CA1665IR	2543522	CA1879IR
2542472	CA1674IR	2542679	CA1388IR	2542924	CA1761IR	2543523	CA1499IR
2542473	CA1771IR	2542680	CA1759IR	2542925	CA1674IR	2543524	CA1879IR
2542479	CA1310IR	2542681	CA1509IR	2542926	CA1963IR	2543525	CA1388IR
2542480	CA1298IR	2542684	CA1553IR	2542927	CA1963IR	2543526	CA1761IR

O.E. NO.	HC-PARTS	O.E. NO.	HC-PARTS	O.E. NO.	HC-PARTS	O.E. NO.	HC-PARTS
2543527	CA1674IR	2929640	CA150IR	2541665C	CA825IR	2543498B	CA2038IR
2543530	CA2098IR	2929780	CA126IR	2541678B	CA1039IR	2543526A	CA1761IR
2543538	CA2089IR	2937130	CA744IR	2541678C	CA1039IR	2543538A	CA2089IR *
2543539	CA2090IR	2937390	CA132IR	2541679C	CA1157IR	2543552A	CA1768IR
2543550	CA1637IR	2937760	CA75	2541683A	CA724IR	2543559A	CA2058IR *
2543551	CA2003IR	2938680	CA705IR	2541694D	CA1150IR	2543561A	CA2043IR
2543552	CA1768IR	2939210	CA132IR	2541697B	CA1398IR	2543563B	CA2057IR
2543553	CA1976IR	2939520	CA212IR	2541710B	CA637IR	2543576A	CA2031IR
2543554	CA1484IR	2940130	CA609IR	2541738B	CA639IR	2543590A	CA2054IR
2543555	CA1829IR	2940255	CA172IR	2541740B	CA638IR	2543595A	CA2025IR
2543557	CA1661IR	2940275	CA175IR	2541741B	CA730IR	2543596A	CA1767IR
2543558	CA1627IR	2940300	CA347IR	2541758B	CA1065IR	2543596B	CA1767IR
2543559	CA2058IR *	2940301	CA347IR	2541760B	CA1098IR	2605647D	CA2098IR *
2543560	CA1762IR	2940303	CA376IR	2541763A	CA618IR	2606005A	CA2056IR *
2543561	CA2043IR	2940304	CA296IR	2541763C	CA618IR	2606237A	CA1811IR
2543562	CA1762IR ▲	2940305	CA298IR	2541763D	CA618IR	2606272A	CA1974IR
2543563	CA2057IR	2940306	CA297IR	2541765A	CA820IR	2606301A	CA1874IR
2543564	CA1975IR	2940307	CA302IR	2541767A	CA715IR	2606952B	CA2044IR *
2543570	CA1873IR	2940308	CA505IR	2541775A	CA1062IR	2607209A	CA1687IR
2543576	CA2031IR	2940309	CA302IR	2541775B	CA1062IR	2607210A	CA1499IR
2543590	CA2054IR	2940310	CA337IR	2541776B	CA1044IR	2607211A	CA1681IR
2543595	CA2025IR	2940311	CA520IR	2541784B	CA1052IR	2607395A	CA1933IR
2543596	CA1767IR	2940347	CA352IR	2541788E	CA1077IR	2613270A	CA1778IR
2543597	CA1936IR	2940349	CA352IR	2541793A	CA556IR	2617195A	CA2090IR *
2543611	CA2030IR	2940353	CA128IR	2541797E	CA1077IR	532004C	CS169
2543639	CA1627IR	2940357	CA328IR	2541809A	CA1056IR	A0002655009	JA1807IR
2565993	CA596IR ▲	2940361	CA592IR	2541811A	CA1256IR	A0002655023	JA1789IR
2565994	CA355IR ▲	2940363	CA354IR	2541815A	CA736IR	A0002655023	JA1789IR
2565995	CA355IR	2940367	CA376IR	2541815B	CA736IR	A0002655103	CA1938IR
2574347	CA1759IR	2940369	CA505IR	2541821A	CA733IR	A0002655221	JA1607IR
2602237	CA1811IR	2940371	CA302IR	2541838A	CA1062IR	A0002655475	CA1906IR
2605106	CA1954IR	2940373	CA337IR	2541839A	CA1044IR	A0002655517	JA1798IR ▲
2605275	CA1975IR	2940375	CA298IR	2542351A	CA1553IR	A0002655524	JA1903IR
2605290	CA1954IR	2940377	CA894IR	2542351B	CA1553IR	A0B09601	JA878IR
2605546	CA2008IR	2940426	CA377IR	2542461A	CA1836IR	A11M11	CA115
2605547	CA2033IR	2940772	CA1387IR	2542500A	CA1553IR	A11M12	CA112
2605647	CA2098IR *	2940778	CA333IR	2542646A	CA1622IR	A11M4	CA115 ◆
2606005	CA2056IR *	2940780	CA333IR	2542646A	CA1622IR	A11M6	CA112
2606154	CA2101IR *	2940981	CA126IR	2542646C	CA1622IR	A11V10	CA617IR
2606272	CA1974IR	2941097	CA176IR	2542646C	CA1622IR	A11V101	CA1497IR
2606301	CA1874IR	2941222	CA735IR	2542646D	CA1622IR	A11V102	CA1640IR
2606333	CA1855IR	2941231	CA60IR	2542646D	CA1622IR	A11V104	CA1306IR
2606334	CA1862IR	2941232	CA175IR	2542646E	CA1622IR	A11V105	CA1333IR
2607208	CA1498IR	2941253	CA349IR	2542646E	CA1622IR	A11V106	CA1498IR
2607209	CA1687IR	2941293	CA354IR	2542671A	CA1856IR	A11V108	CA1640IR
2607210	CA1499IR	2941301	CA128IR	2542691C	CA1444IR	A11V109	CA1687IR
2607211	CA1681IR	2941814	CA740IR	2542693A	CA1761IR	A11V111	CA618IR
2607212	CA1879IR	2941983	CA1308IR	2542694A	JA1725IR	A11V110	CA1637IR
2607214	CA2031IR	2950220	CA126IR	2542694B	JA1725IR	A11V111	CA1298IR
2607395	CA1933IR	2950281	CA87IR ▲	2542720J	CA1953IR	A11V115	CA729IR ▲
2607732	CA1920IR	2950390	CA196IR	2542736A	CA1758IR	A11V116	CA729IR
2613270	CA1778IR	2950500	CA316IR	2542749A	CA1773IR	A11V117	CA648IR
2655103	CA1938IR	2950700	CA1387IR	2542749B	CA1773IR	A11V118	CA648IR
2655447	CA2020IR	2950830	CA277IR	2542749C	CA1773IR	A11V121	CA733IR
2655475	CA1906IR	2960000	CA1202IR	2542855B	CA2043IR	A11V122	CA732IR
2655476	JA1600IR ▲	2960120	CA368IR	2542892B	CA2002IR	A11V123	CA820IR
2655517	JA1798IR ▲	2960150	CA341IR	2542922A	CA1499IR	A11V124	CA636IR
2655524	JA1903IR	2960250	CA749IR	2542923A	CA1665IR	A11V125	CA637IR
2655635	CA1927IR	2541298A	CA618IR	2542924A	CA1761IR	A11V126	CA896IR
2655866	CA2023IR	2541299A	CA617IR	2542925A	CA1674IR	A11V128	CA816IR
2808490	CA1389IR	2541307C	CA535IR	2543205A	CA2058IR *	A11V129	CA1059IR
2809249	CA1310IR	2541307D	CA535IR	2543222B	CA2095IR *	A11V130	CA1320IR
2809253	CA1650IR	2541356A	CA729IR	2543248A	CA2038IR	A11V131	CA818IR
2809464	CA1499IR	2541393E	CA821IR	2543290B	CA2055IR	A11V132	CA820IR ▲
2925000	CA52IR	2541416F	CA740IR	2543305B	CA1905IR	A11V135	CA827IR ▲
2925060	CA52IR	2541417K	CA736IR	2543305C	CA1905IR	A11V136	CA827IR
2925330	CA325IR ◆	2541434A	CA298IR	2543315D	CA1996IR	A11V137	CA617IR
2926300	CA305IR	2541447A	CA715IR	2543370A	CA1906IR	A11V138	CA1095IR
2927060	CA60IR	2541457B	CA820IR	2543406A	CA2072IR *	A11V140	CA637IR
2927070	CA126IR	2541602A	CA816IR	2543426A	CA2044IR *	A11V142	CA617IR
2927120	CA743IR	2541602F	CA816IR	2543444A	CA2053IR	A11V143	CA618IR
2927550	CA207IR	2541610G	CA1036IR	2543457A	CA1920IR	A11V144	CA1095IR
2927750	CA742IR	2541617A	CA1332IR	2543469A	CA2054IR	A11V145	CA1038IR
2927790	CA237IR	2541617B	CA1332IR	2543476A	CA2008IR	A11V146	CA890IR
2927990	CA745IR	2541620A	CA1041IR	2543479A	CA1934IR	A11V147	CA729IR
2928590	CA228IR	2541620B	CA1041IR	2543480A	CA1855IR	A11V148	CA648IR
2928610	CA1387IR	2541626E	CA829IR	2543484A	CA1856IR	A11V149	CA820IR
2929510	CA355IR ▲	2541642G	CA896IR	2543488A	CA1977IR	A11V151	CA637IR
2929580	CA1201IR	2541665B	CA825IR	2543498A	CA2038IR	A11V154	CA1059IR

O.E. NO.	HC-PARTS	O.E. NO.	HC-PARTS	O.E. NO.	HC-PARTS	O.E. NO.	HC-PARTS
VALEO <i>Continued</i>							
A11VI55	CA618IR	A13N102	CA147	A13N220	CA380IR	A13R171	CA106
A11VI56	CA1095IR	A13N104	CA317IR	A13N221	CA150IR	A13R172T	CA148
A11VI57	CA820IR	A13N109	CA370IR	A13N226	CA529IR ▲	A13R184	CA148
A11VI59	CA1079IR	A13N11	CA155IR	A13N229T	CA705IR	A13R189	CA304
A11VI61	CA1077IR	A13N110	CA375IR	A13N22T	CA705IR	A13R192	CA300IR
A11VI62	CA827IR ▲	A13N113	CA170IR	A13N23	CA854IR	A13R203	CA84IR
A11VI64	CA827IR	A13N118	CA374IR	A13N230	CA605IR	A13R214	CA155IR
A11VI66	CA733IR	A13N12	CA288IR	A13N231	CA625IR	A13R215	CA84
A11VI66	CA733IR	A13N120	CA372IR	A13N232	CA574IR	A13R218	CA178IR
A11VI72	CA637IR	A13N121	CA375IR	A13N233	CA711IR	A13R219	CA147
A11VI76	CA1573IR	A13N123	CA369IR	A13N235	CA849IR	A13R22	CA114
A11VI77	CA1573IR ▲	A13N124	CA372IR ▲	A13N236	CA854IR	A13R220	CA356IR
A11VI79	CA1079IR	A13N126	CA301IR	A13N236M	CA854IR	A13R221	CA165IR
A11VI81	CA1343IR	A13N127	CA580IR	A13N238	CA711IR ▲	A13R222	CA165IR
A11VI84	CA636IR	A13N128	CA581IR	A13N239	CA377IR	A13R223	CA148
A11VI85	CA1077IR	A13N129	CA359IR	A13N240	CA294IR	A13R225	CA84
A11VI86	CA1573IR ▲	A13N13	CA165IR	A13N241	CA574IR	A13R228	CA224IR
A11VI87	CA1344IR	A13N130	CA533IR	A13N242	CA711IR	A13R230	CA268IR
A11VI88	CA1304IR	A13N133	CA574IR ▲	A13N247	CA735IR	A13R231	CA169IR
A11VI89	CA1305IR	A13N135	CA148	A13N259	CA1192IR	A13R242	CA268IR
A11VI91	CA1442IR	A13N136	CA529IR	A13N259M	CA1192IR	A13R243	CA169IR
A11VI92	CA1306IR	A13N137	CA557IR	A13N26	JA150IR	A13R247	CA169IR
A11VI93	CA1333IR	A13N138	CA711IR	A13N261	CA294IR ▲	A13R256	CA169IR
A11VI94	CA1484IR	A13N139	CA224IR ▲	A13N269	CA889IR	A13R258	CA170IR
A11VI95	CA1504IR	A13N14	CA165IR	A13N27	CA557IR	A13R259	CA150IR
A11VI96	CA1302IR	A13N140	CA705IR	A13N274	CA1383IR	A13R260	CA224IR
A11VI97	CA1306IR	A13N140T	CA705IR	A13N275	CA1382IR	A13R261	CA147
A11VI98	CA1298IR	A13N144	CA308IR ▲	A13N276	CA1383IR	A13R262	CA84IR
A11VI99	CA1498IR	A13N147	CA1192IR	A13N28	CA1048IR	A13R263	CA356IR
A12M11	CA172IR	A13N147M	CA1192IR	A13N281	CA1048IR	A13R266	CA150IR
A12M15	CA173IR	A13N148M	CA1192IR	A13N283	CA705IR	A13R267	CA374IR
A12M16	CA173IR	A13N149M	CA1192IR	A13N283M	CA705IR	A13R268	CA308IR
A12M17	CA172IR	A13N15	CA268IR	A13N289	CA574IR	A13R269	CA224IR
A12M9	CA173IR	A13N150	CA170IR	A13N29	CA360IR	A13R270	CA268IR
A12R1	CA71	A13N151	CA380IR	A13N2M	CA1192IR	A13R38	CA114
A12R11	CA71	A13N156	CA728IR	A13N30	CA301IR	A13R83	CA148
A12R14	CA164	A13N157	CA549IR	A13N31	CA169IR	A13R90	CA148
A12R21	CA114	A13N158	CA649IR	A13N32	CA374IR	A13R95	CA114
A12R22	CA81IR	A13N159	CA524IR	A13N33	CA334IR	A13V02	CA345IR
A12R30	CA331IR	A13N160	CA557IR	A13N35M	CA1192IR	A13V05	CA321IR
A12R31	CA331IR	A13N161	CA635IR	A13N38	CA291IR	A13V07	CA345IR
A12R32	CA149IR	A13N162	CA527IR	A13N39	CA88IR	A13VI100	CA1044IR
A12R33	CA331IR	A13N164	CA602IR	A13N40	CA150IR	A13VI101	CA1052IR
A12R34	CA149IR	A13N166	CA568IR	A13N41	CA308IR	A13VI102	CA1152IR
A12R36	CA176IR	A13N167	CA525IR	A13N42	CA150IR	A13VI104	CA1077IR
A12R37	CA176IR	A13N169	CA625IR	A13N43	CA291IR	A13VI105	CA1078IR
A12R38	CA174IR	A13N17	CA268IR	A13N46	CA84IR	A13VI106	CA1250IR
A12R4	CA71	A13N171	CA526IR	A13N47	CA356IR	A13VI107	CA1200IR
A12R43	CA172IR	A13N172	CA612IR	A13N49	CA371IR	A13VI108	CA556IR
A12R44	CA228IR	A13N173	CA640IR	A13N4T	CA705IR	A13VI109	CA1238IR
A12R45	CA173IR	A13N175	CA359IR	A13N50	CA361IR	A13VI111	CA815IR
A12R46	CA174IR	A13N176	CA533IR	A13N52	CA1048IR	A13VI114	CA1265IR
A12R5	CA71	A13N177	CA380IR	A13N56M	CA705IR	A13VI116	CA1102IR
A12R50	CA81IR	A13N178	CA574IR ▲	A13N57M	CA742IR	A13VI118	CA1056IR
A12R52	CA331IR	A13N179	CA711IR	A13N5T	CA705IR	A13VI119	CA1256IR
A12R53	CA173IR	A13N18	CA169IR	A13N6	CA178IR	A13VI121	CA1269IR
A12R55	CA174IR	A13N181	CA294IR	A13N63	CA224IR	A13VI122	CA716IR ▲
A12R73	CA174IR	A13N182	CA525IR	A13N64	CA289IR	A13VI123	CA740IR
A12R8	CA164	A13N183	CA380IR	A13N65	CA224IR	A13VI124	CA736IR
A12RP73	CA174IR	A13N184	CA587IR	A13N80	CA300IR	A13VI125	CA912IR
A13E09	CA302IR	A13N186M	CA1192IR	A13N84	CA150IR	A13VI126	CA829IR
A13E19	CA313IR	A13N19	CA303IR	A13N85	CA512IR	A13VI13	CA535IR
A13E23	CA129IR	A13N199	CA605IR	A13N86	CA373IR	A13VI130	CA1400IR
A13E25	CA252IR	A13N1M	CA1192IR	A13N87	CA224IR	A13VI132	CA1323IR
A13E26	CA252IR	A13N20	CA170IR	A13N88	CA378IR	A13VI134	CA1062IR
A13E39	CA354IR	A13N200	CA606IR	A13N89	CA372IR	A13VI135	CA1044IR
A13E41	CA376IR	A13N201	CA607IR	A13N91	CA303IR	A13VI137	CA1486IR
A13E43	CA302IR	A13N203	CA549IR ▲	A13N92	CA370IR	A13VI138	CA1139IR
A13E45	CA520IR	A13N204	CA633IR	A13N93	JA150IR	A13VI139	CA716IR ▲
A13E50	CA350IR	A13N206	CA635IR	A13N95	CA294IR	A13VI14	CA818IR
A13E58	CA302IR	A13N207	CA1101IR	A13NP173	CA529IR	A13VI140	CA1332IR
A13E63	CA851IR	A13N209	CA635IR	A13R115	CA106	A13VI141	CA1243IR
A13E66	CA596IR	A13N210	CA557IR	A13R120	CA106	A13VI142	CA1583IR
A13E67	CA596IR	A13N214	CA264IR	A13R121	CA283	A13VI149	CA1573IR ▲
A13E68	CA254IR	A13N215	CA359IR	A13R15	CA114	A13VI15	CA816IR ▲
A13E69	CA596IR ▲	A13N216	CA533IR	A13R152	CA106 ▲	A13VI150	CA1400IR
A13N10	CA329IR	A13N217	CA587IR	A13R157	CA114	A13VI151	CA1056IR
A13N100	CA148	A13N218	CA294IR	A13R169	CA147	A13VI152	CA1096IR
A13N101	CA147	A13N219	CA525IR	A13R170	CA114	A13VI153	CA1036IR



O.E. NO.	HC-PARTS	O.E. NO.	HC-PARTS	O.E. NO.	HC-PARTS	O.E. NO.	HC-PARTS
A13VI155	CA837IR	A13VI263	CA1052IR	A14N101	CA612IR	A14N65	CA229IR ▲
A13VI156	CA1139IR	A13VI264	CA1307IR	A14N102	CA831IR	A14N67	CA814IR
A13VI16	CA816IR	A13VI265	CA1309IR	A14N104	CA558IR	A14N69	CA229IR
A13VI160	CA1256IR	A13VI266	CA1333IR	A14N106	CA229IR	A14N73	CA535IR
A13VI163	CA1040IR	A13VI267	CA1319IR	A14N11	CA813IR	A14N74	CA831IR ▲
A13VI164	CA1036IR	A13VI273	CA1583IR ▲	A14N112M	CA857IR	A14N75	CA535IR
A13VI165	CA1080IR	A13VI274	CA1065IR	A14N114	CA898IR	A14N76	CA579IR
A13VI166	CA896IR	A13VI276	CA1499IR	A14N114T	CA898IR	A14N78	CA315IR
A13VI167	CA1036IR	A13VI277	CA1589IR	A14N115M	CA898IR	A14N79	CA315IR
A13VI17	CA819IR	A13VI278	CA1641IR	A14N116M	CA898IR	A14N81M	CA857IR ▲
A13VI170	CA1044IR	A13VI279	CA1642IR	A14N117	CA534IR	A14N84	CA229IR
A13VI171	CA1309IR	A13VI28	CA716IR ▲	A14N118M	CA857IR	A14N88	CA338IR
A13VI172	CA1307IR	A13VI280	CA1086IR	A14N118M	CA858IR	A14N89	CA229IR
A13VI173	CA1397IR	A13VI281	CA825IR	A14N119M	CA857IR	A14N90	CA735IR
A13VI175	CA1062IR	A13VI282	CA1665IR	A14N119M	CA858IR	A14N91	CA735IR
A13VI176	CA1044IR	A13VI283	CA1681IR	A14N12	CA510IR	A14N93	CA229IR
A13VI178	CA1342IR	A13VI285	CA1653IR	A14N121	CA332IR	A14N95	CA579IR
A13VI179	CA1434IR	A13VI286	CA1569IR	A14N124	CA579IR ▲	A14N96	CA534IR
A13VI18	CA845IR	A13VI287	CA1578IR	A14N125	CA534IR ▲	A14N97	CA271IR
A13VI180	CA1332IR	A13VI288	CA1641IR	A14N13	CA229IR	A14R11	CA166
A13VI184	CA1077IR	A13VI289	CA1572IR	A14N131	CA830IR	A14R17	CA166
A13VI185	CA1078IR	A13VI291	CA1622IR	A14N132	CA838IR	A14R22	CA166
A13VI188	CA1345IR	A13VI292	CA1303IR	A14N133	CA749IR	A14R23	CA315IR
A13VI189	CA1086IR	A13VI293	CA828IR	A14N134	CA229IR ▲	A14R27	CA166
A13VI190	CA1569IR	A13VI297	CA1622IR ▲	A14N135	CA748IR	A14R3	CA166
A13VI191	CA825IR	A13VI30	CA716IR	A14N137M	CA857IR	A14R41	CA315IR
A13VI193	CA1389IR	A13VI300	CA1444IR	A14N138	CA558IR	A14R45	CA510IR
A13VI195	CA1444IR	A13VI31	CA639IR	A14N139	CA556IR	A14S054	CA1584IR
A13VI197	CA1062IR	A13VI32	CA1225IR	A14N140	CA535IR	A14S055	CA1584IR
A13VI198	CA1044IR	A13VI34	CA821IR	A14N141M	CA858IR	A14V01	CA503IR
A13VI20	CA1251IR	A13VI35	CA1033IR	A14N142	CA634IR	A14V04	CA608IR
A13VI200	CA1578IR	A13VI39	CA852IR ▲	A14N144	CA314IR	A14V05	CA362IR
A13VI201	CA1392IR	A13VI40	CA740IR	A14N150	CA229IR ▲	A14V07	CA1063IR
A13VI202	CA1390IR	A13VI41	CA736IR	A14N151	CA830IR	A14V08	CA859IR
A13VI203	CA1496IR	A13VI44	CA912IR	A14N152	CA1105IR	A14V13	CA1042IR
A13VI204	CA1564IR	A13VI45	CA848IR	A14N156	CA632IR	A14V14	CA859IR
A13VI207	CA1303IR	A13VI46	CA715IR	A14N160	CA558IR	A14V15	CA1063IR
A13VI208	CA1322IR	A13VI47	CA1104IR	A14N163	CA314IR	A14V16	CA1054IR
A13VI209	CA1309IR	A13VI48	CA713IR	A14N164	CA838IR	A14V17	CA897IR
A13VI21	CA895IR	A13VI49	CA638IR	A14N171	CA634IR	A14V18	CA1073IR
A13VI210	CA1309IR	A13VI51	CA730IR	A14N172	CA556IR	A14V19	CA1054IR
A13VI211	CA1308IR	A13VI52	CA1060IR	A14N176	CA1339IR	A14V10	CA836IR
A13VI212	CA1333IR	A13VI54	CA1064IR	A14N177M	CA898IR	A14V11	CA1099IR
A13VI213	CA1319IR	A13VI55	CA1040IR	A14N178	CA1454IR	A14V13	CA1098IR
A13VI216	CA1307IR	A13VI57	CA1036IR	A14N18	CA532IR	A14V14	CA1156IR
A13VI217	CA1331IR	A13VI59	CA1449IR	A14N182	CA1336IR	A14V15	CA1334IR
A13VI220	CA1044IR	A13VI60	CA1332IR	A14N183M	CA1049IR	A14V16	CA1312IR
A13VI222	CA1395IR	A13VI61	CA1041IR	A14N185	CA1336IR	A14V17	CA1388IR
A13VI223	CA1542IR	A13VI62	CA914IR	A14N190	CA1336IR	A14V18	CA1338IR
A13VI224	CA1306IR	A13VI63	CA829IR	A14N196M	CA898IR	A14V19	CA1310IR
A13VI227	CA1307IR	A13VI64	CA1080IR	A14N198M	CA898IR	A14V19	CA1310IR
A13VI23	CA817IR	A13VI65	CA896IR	A14N199	CA1339IR	A14V20	CA1310IR
A13VI230	CA1043IR	A13VI66	CA913IR	A14N2	CA175IR	A14V20	CA1310IR
A13VI231	CA1065IR	A13VI68	CA556IR	A14N20	CA229IR	A14V22	CA1591IR
A13VI232	CA1152IR	A13VI70	CA837IR	A14N200M	CA858IR	A14V23	CA1495IR
A13VI233	CA1052IR	A13VI71	CA825IR	A14N205	CA558IR	A14V24	CA1338IR
A13VI234	CA1631IR	A13VI72	CA1039IR	A14N206M	CA858IR	A14V25	CA1388IR
A13VI235	CA1344IR	A13VI73	CA1157IR	A14N207M	CA1049IR	A14V25	CA1388IR
A13VI236	CA1499IR	A13VI74	CA833IR	A14N208M	CA1049IR	A14V27	CA1509IR
A13VI237	CA1342IR	A13VI75	CA724IR	A14N22	CA229IR	A14V28	CA1559IR
A13VI238	CA1622IR	A13VI76	CA1150IR	A14N23	CA315IR	A14V29	CA1584IR
A13VI24	CA837IR	A13VI77	CA1397IR ▲	A14N28T	CA721	A14V30	CA836IR
A13VI241	CA1750IR	A13VI78	CA1398IR	A14N3	CA721	A14V31	CA836IR ▲
A13VI242	CA1589IR	A13VI80	CA1238IR	A14N30M	CA898IR	A14V34	CA1756IR
A13VI246	CA1642IR	A13VI81	CA1086IR	A14N36	CA315IR	A14V35	CA1553IR
A13VI249	CA1506IR	A13VI82	CA1579IR	A14N37	CA229IR	A14V36	CA1813IR
A13VI25	CA720IR	A13VI83	CA715IR	A14N39	CA749IR	A14V37	CA1835IR
A13VI252	CA1653IR ▲	A13VI84	CA1203IR	A14N3T	CA721	A14V40	CA1674IR
A13VI253	CA1621IR	A13VI85	CA639IR	A14N4	CA314IR	A14V41	CA1553IR
A13VI254	CA1303IR	A13VI87	CA638IR	A14N47M	CA857IR	A14V42	CA1509IR
A13VI255	CA1322IR	A13VI88	CA730IR	A14N50	CA229IR	A14V45	CA1756IR ▲
A13VI256	CA1641IR	A13VI94	CA1065IR	A14N51	CA332IR	A14V46	CA1756IR
A13VI257	CA1390IR	A13VI95	CA1043IR	A14N53	CA526IR	A14V47	CA1756IR
A13VI258	CA1065IR	A13VI96	CA715IR	A14N54	CA643IR	A14V48	CA1761IR
A13VI259	CA1444IR	A13VI97	CA1247IR	A14N55	CA175IR	A14V49	CA1761IR
A13VI26	CA713IR	A13VI99	CA1062IR	A14N56	CA332IR	A14V52	CA1584IR
A13VI260	CA1043IR	A14N1	CA175IR	A14N59	CA338IR	A14V53	CA1584IR
A13VI261	CA1065IR	A14N100	CA857IR	A14N62	CA526IR	AB111033	JA995IR
A13VI262	CA1152IR	A14N100M	CA857IR	A14N64	CA229IR	AB111057	JA995IR ▲

O.E. NO.	HC-PARTS	O.E. NO.	HC-PARTS	O.E. NO.	HC-PARTS	O.E. NO.	HC-PARTS
<b>VALEO <i>Continued</i></b>							
AB150017	JA803IR	AF175362	JA1716IR ▲	D13E1231TE	CS983	D6RA511	CS621
AB150021	JA1276IR	AF175363	JA1711IR	D13E123TE	CS983	D6RA52	CS807
AB160044	JA694IR	AF175363	JA1711IR	D13HP601	CS1169	D6RA53	CS882
AB160063	JA694IR	AF175363	JA1711IR	D13HP605	CS1128	D6RA56	CS681
AB160108	JA1715IR	AF175363	JA1711IR	D13HP607	CS1251	D6RA57	CS581
AB165014	JA688IR	AF175385	JA1716IR ▲	D13HP702	CS1278	D6RA571	CS581
AB165104	JA1600IR	AF175476	JA1711IR	D13HP703	CS983	D6RA572	CS581
AB170035	JA1537IR	AF185381	JA1539IR ▲	D13HP709	CS1164	D6RA59	CS796
AB170035	JA1537IR	AF185452	JA1539IR	D15E30	CS1127	D6RA6	CS681
AB170036	JA877IR	AF190216	JA1717IR	D15E30T	CS1127	D6RA61	CS681
AB170094	JA877IR	AF190217	JA1717IR	D15E30TE	CS1127	D6RA62	CS519
AB175015	JA689IR	APR140AB	JA877IR	D6G1	CS1346	D6RA63	CS1060
AB175019	JA879IR	APR140AA	JA875IR ▲	D6G3	CS581	D6RA64	CS566
AB175020	JA671IR	APR165AA	JA585IR	D6G32	CS1346	D6RA66	CS566
AB175020	JA671IR	AR150BA	JA1169IR	D6G321	CS1346	D6RA661	CS566
AB175051	JA690IR	AR150CA	JA787IR	D6G33	CS1334	D6RA67	JS1147
AB175052	JA888IR	AR150AA	JA1169IR	D6G5	CS1117	D6RA68	CS327
AB175053	JA689IR	AR155BA	JA159IR	D6GS11	CS1294	D6RA7	CS1106
AB175054	JA879IR	AR160A	JA146IR	D6GS12	CS1330	D6RA70	CS1290
AB175054	JA879IR	AR175AA	JA690IR	D6GS13	CS1324	D6RA72	CS551
AB175068	JA879IR	BM51267AR	JA1366IR	D6GS14	CS1347	D6RA721	CS551
AB175359	JA888IR ▲	D10E43	CS138	D6GS19	CS1401	D6RA73	CS681
AB180085	JA1786IR ▲	D10E48	CS138	D6RA10	CS390	D6RA74	CS1244
AB180092	JA1786IR	D10E59	CS280	D6RA100	CS581	D6RA76	CS886
AB180092	JA1786IR	D10E63	CS138	D6RA101	CS784	D6RA78	JS923
AB180128	JA1788IR	D10E66	CS545	D6RA104	CS784	D6RA79	JS922
AB180140	JA1785IR	D10E72	CS273	D6RA105	CS1344	D6RA8	CS566
AB190012	JA683IR	D10E74	CS545	D6RA107	CS1290	D6RA80	JS1147
AB190025	JA684IR	D10E75	CS132	D6RA109	CS566	D6RA81	JS1216
AB190025	JA684IR	D10E80	CS138	D6RA110	CS1260	D6RA811	JS1216
AB190025	JA684IR	D10E81	CS132	D6RA114	CS1277	D6RA82	CS727
AB190058	JA994IR	D10E83	CS132	D6RA115	CS1344	D6RA83	CS1117
AB190058	JA994IR	D10E85	CS354	D6RA12	CS551	D6RA91	JS1353
AB190072	JA684IR	D10E88	CS523	D6RA13	JS380	D6RA92	CS879
AB190072	JA684IR	D10E881	CS523	D6RA132	CS519	D6RA93	CS519
AB190097	JA870IR ▲	D10E882	CS523	D6RA133	CS681	D6RAD183	CS1338
AB190110	JA1784IR	D10E89	CS523	D6RA137	CS1345	D6RADP359	CS1338
AB190111	JA1784IR ▲	D10E92	CS354	D6RA138	CS1345	D6RAP229	CS1117
AB190119	JA684IR	D10E921	CS354	D6RA138	CS1345	D6RAP404	CS1290
AB190147	JA1789IR	D11E109	CS163	D6RA138	CS1345	D7E1	CS1057
AB190150	JA1784IR	D11E119	CS607	D6RA141	CS791	D7E15	CS1186
AB190205	JA870IR	D11E119T	CS607	D6RA15	CS1106	D7E16	CS581
AB190386	JA870IR	D11E120	CS550	D6RA16	CS566	D7E18	CS1117
AB195126	JA1522IR	D11E122	CS608	D6RA161	CS566	D7E19	CS1174
AB195141	JA1718IR	D11E122T	CS608	D6RA162	CS519	D7E2	CS581
AC155515	JA787IR	D11E126	CS128	D6RA163	CS519	D7E20	CS1186
AC155603	JA1169IR	D11E131	CS1173	D6RA167	JS1147	D7E22	CS1174
AC155604	JA1169IR	D11E137	CS201	D6RA168	CS327	D7E23	CS581
AC155616	JA787IR	D11E141	CS109	D6RA18	CS566	D7E25	CS581
AC155907	JA787IR	D11E142	CS163	D6RA181	JS1216	D7E26	CS1174
AD155326	JA180IR	D11E154	CS201	D6RA187	CS1345	D7E27	CS1276
AD160209	JA180IR	D11E155	CS109	D6RA188	CS1345	D7E29	JS1305
AD165202	JA1366IR	D11E156	CS128	D6RA20	CS390	D7E30	JS1307
AD165206	JA1618IR ▲	D11E158	CS550	D6RA22	CS807	D7E31	JS1226
AD165206	JA1618IR ▲	D11E159	CS163	D6RA23	CS326	D7E32	JS1307
AD165320	JA1366IR	D11E163	CS155	D6RA249	CS519	D7E38	CS1117
AD165320Q	JA1366IR	D11E167T	CS783	D6RA25	CS183	D7E39	CS1385
AD165321	JA1366IR	D11E169	CS382	D6RA28	CS119	D7E4	CS1117
AD165321Q	JA1366IR	D11E170	CS163	D6RA293	CS519	D7E40	JS1307
AD165439	JA1618IR	D11E172	CS338	D6RA30	CS344	D7E41	JS1226
AD165439	JA1618IR	D11E173	CS365	D6RA32	CS519	D7E42	JS1307
AD165440	JA1618IR	D11E176	CS382	D6RA33	CS681	D7E47	CS1276
AD165440	JA1618IR	D11E177	CS155	D6RA37	CS581	D7E5	CS581
AD165454	JA1618IR ▲	D11E184	CS314	D6RA38	CS566	D7E52	CS1379
AD165454	JA1618IR ▲	D11E187	CS365	D6RA39	CS371	D7E6	CS1174
AD165471	JA1618IR	D11E188	CS366	D6RA40	CS991	D7E7	CS1111
AD165471	JA1618IR	D11E191	CS314	D6RA41	CS791	D7E8	CS1117
AD225412	JA972IR	D11E192	CS366	D6RA42	CS126	D7ED28	CS1384
AF111225	JA1709IR	D11E195	CS128	D6RA42	CS94	D7ED281	CS1384
AF111364	JA1518IR	D11E272	CS338	D6RA43	CS126	D7EP12	CS519
AF111364	JA1518IR	D11E84	CS109	D6RA43	CS94	D7ES1	CS1343
AF111364	JA1518IR	D13E110	CS983	D6RA431	CS126	D7ES2	CS1211
AF111382	JA1804IR	D13E110TE	CS983	D6RA431	CS94	D7ES4	CS1211
AF111390	JA1709IR	D13E111	CS983	D6RA44	CS166	D7ES5	CS1343
AF111393	JA1804IR	D13E111TE	CS983	D6RA45	CS882	D7G11	CS1207
AF111393	JA1804IR	D13E117TE	CS983	D6RA46	CS681	D7G14	CS1072
AF175207	JA1716IR	D13E118TE	CS983	D6RA47	CS275	D7G20	CS1072
AF175207	JA1716IR	D13E120TE	CS1262	D6RA5	CS390	D7G26	CS1391
AF175207	JA1716IR	D13E123	CS983	D6RA51	CS621	D7G3	CS1329

O.E. NO.	HC-PARTS	O.E. NO.	HC-PARTS	O.E. NO.	HC-PARTS	O.E. NO.	HC-PARTS
D7G3.....	CS1329	D8E117.....	CS142	D9E243.....	CS285	D9R90.....	CS361
D7G4.....	CS1328	D8E119.....	CS151	D9E26.....	CS143	D9R91.....	CS543
D7GS10.....	CS1323	D8E121.....	CS95	D9E27.....	CS129	D9R97.....	CS567
D7GS8.....	CS1293	D8E122.....	CS129	D9E276.....	CS310	D9R99.....	CS570
D7GS9.....	CS1387	D8E124.....	CS129	D9E278.....	CS315	D9RP160.....	CS331
D7R1.....	CS542	D8E126.....	CS180	D9E28.....	CS130	D9RP256.....	CS575
D7R11.....	CS542	D8E130.....	CS94	D9E300.....	CS280	ESW20ER121.....	CS1505
D7R12.....	CS1177	D8E131.....	CS94	D9E31.....	CS130	ESW20ER123.....	CS1508
D7R127.....	CS1177	D8E132.....	CS280	D9E32.....	CS130	FG18S012.....	CA2072IR *
D7R13.....	CS684	D8E133.....	CS130	D9E34.....	CS95	FG18S017.....	CA1920IR
D7R15.....	CS542	D8E134.....	CS93	D9E36.....	CS352	FG18S019.....	CA2041IR
D7R151.....	CS542	D8E137.....	CS142	D9E37.....	CS143	FG18S022.....	CA2089IR *
D7R16.....	CS978	D8E139.....	CS170	D9E38.....	CS362	FG18S023.....	CA2090IR *
D7R17.....	CS1108	D8E140.....	CS169	D9E39.....	CS310	FG18S027.....	CA2030IR
D7R18.....	CS684	D8E142.....	CS143	D9E40.....	CS165	FG18S048.....	CA1920IR
D7R19.....	CS1044	D8E144.....	CS168	D9E41.....	CS143	FG18S109.....	CA2090IR *
D7R2.....	CS594	D8E147.....	CS130	D9E43.....	CS306	FS60PR019.....	CS1380
D7R20.....	CS1177	D8E148.....	CS126	D9E44.....	CS306	HD90S010.....	CA1310IR
D7R22.....	CS1131	D8E151.....	CS142	D9E45.....	CS385	HD90S011.....	CA1310IR
D7R23.....	CS1055	D8E152.....	CS95	D9E46.....	CS315	HD90S011.....	CA1310IR
D7R24.....	CS594	D8E153.....	CS79	D9E48.....	CS326	HD90S013.....	CA1310IR
D7R25.....	CS684	D8E154.....	CS166	D9E49.....	CS326	HD90S013ZD.....	CA1310IR
D7R26.....	CS594	D8E155.....	CS127	D9E53.....	CS355	HD90S014.....	CA1310IR
D7R27.....	CS1177	D8E157.....	CS79	D9E54.....	CS352	HD90S014ZD.....	CA1310IR
D7R28.....	CS1044	D8E158.....	CS62	D9E55.....	CS315	HD90S015.....	CA1650IR
D7R281.....	CS1044	D8E21.....	CS95	D9E56.....	CS321	HD90S015ZD.....	CA1650IR
D7R3.....	CS542	D8E41.....	CS95	D9E57.....	CS168	HD90S016ZD.....	CA1310IR
D7R32.....	CS1177	D8E50.....	CS151	D9E61.....	CS352	HD90S017ZD.....	CA1310IR
D7R33.....	CS624	D8E54.....	CS94	D9E62.....	CS352	HD90S018ZD.....	CA1650IR
D7R34.....	CS1207	D8E60.....	CS95	D9E64.....	CS355	HD90S019ZD.....	CA1310IR
D7R35.....	CS684	D8E74.....	CS94	D9E66.....	CS321	HD90S020ZD.....	CA1310IR
D7R4.....	CS594	D8E76.....	CS129	D9E68.....	CS315	HD90S021ZD.....	CA1650IR
D7R40.....	CS1263	D8E81.....	CS95	D9E69.....	CS316	HK988300.....	JS770
D7R41.....	CS370	D8E86.....	CS94	D9E7.....	CS385	HQ808670.....	JS892
D7R42.....	CS374	D8E94.....	CS151	D9E70.....	CS317	M00A0240Z.....	JS640
D7R43.....	CS1044	D8E96.....	CS129	D9E701.....	CS317	M04686.....	JS633
D7R44.....	CS1193	D8E97.....	CS151	D9E702.....	CS317	M35216.....	JS1098
D7R45.....	CS542	D8E99.....	CS126	D9E74.....	CS321	M39376.....	JS643
D7R46.....	CS1044	D8R1.....	CS1288	D9E75.....	CS355	M39646.....	JS349
D7R47.....	CS1193	D8R27.....	CS1342	D9E76.....	CS310	M42373.....	JS637
D7R48.....	CS1281	D8R28.....	CS1416	D9E761.....	CS310	M43168.....	JS747
D7R48.....	CS1281	D8R29.....	CS1342	D9E77.....	CS310	M43196.....	JS1000
D7R49.....	CS1193	D8R49.....	CS1478	D9E771.....	CS310	M52100.....	JS922
D7R5.....	CS684	D9E100.....	CS280	D9E772.....	CS310	M53486.....	JS923
D7R53.....	CS1207	D9E101.....	CS362	D9E773.....	CS310	M56290.....	JS1303
D7R56.....	CS1207	D9E104.....	CS165	D9E774.....	CS310	M60081.....	JS1313
D7R57.....	CS885	D9E107.....	CS78	D9E776.....	CS310	M60082.....	JS1304
D7R61.....	CS1118	D9E108.....	CS123	D9E78.....	CS315	M60082.....	JS1304
D7R64.....	CS613	D9E109.....	CS79	D9E79.....	CS315	M62957.....	CS1492
D7R7.....	CS286	D9E11.....	CS385	D9E81.....	CS280	MC107012.....	JS396
D7R70.....	CS977	D9E110.....	CS77	D9E82.....	CS130	MC107023.....	JS396
D7R8.....	CS1177	D9E111.....	CS116	D9E83.....	CS306	MC108024.....	JS1000
D7RP123.....	CS1044	D9E113.....	CS77	D9E85.....	CS317	MC108027.....	JS633
D7RP204.....	CS1207	D9E114.....	CS79	D9E851.....	CS317	MC108030.....	JS633
D7RP82.....	CS1108	D9E12.....	CS95	D9E852.....	CS317	MC109011.....	JS633
D7RS1.....	JS645	D9E123.....	CS285	D9E861.....	CS169	MC109015.....	JS1098
D7RS129.....	CS789	D9E124.....	CS70	D9E87.....	CS93	MC109018.....	JS349
D7RS130.....	CS974	D9E125.....	CS263	D9E9.....	CS129	MC109021.....	JS1000
D7RS131.....	CS801	D9E127.....	CS91	D9E92.....	CS94	MC109025.....	JS349
D7RS150.....	CS1181	D9E128.....	CS66	D9E93.....	CS126	MC109028.....	JS1000
D7RS29.....	CS789	D9E129.....	CS162	D9E94.....	CS166	MC109028.....	JS640
D7RS30.....	CS974	D9E131.....	CS306	D9E95.....	CS385	MC109032.....	JS643
D7RS301.....	CS974	D9E132.....	CS306	D9E98.....	CS168	MC109036.....	JS640
D7RS31.....	CS801	D9E136.....	CS297	D9EP119.....	CS326	MG112014.....	JS628
D7RS50.....	CS1181	D9E137.....	CS310	D9R106.....	CS163	MG112022.....	JS658
D7RS7.....	JS1152	D9E138.....	CS310	D9R112.....	CS575	MG112022.....	JS658
D7RSA10.....	JS648	D9E14.....	CS154	D9R116.....	CS1035	MG120413.....	JS344
D7RSA11.....	JS648	D9E140.....	CS294	D9R118.....	CS580	MG120416.....	JS903
D7RSA4.....	JS648	D9E15.....	CS154	D9R119.....	CS331	MG120445.....	JS770
D7RSA5.....	JS648	D9E16.....	CS165	D9R121.....	CS373	MG122202.....	JS892
D7RSA7.....	JS1152	D9E167.....	CS78	D9R122.....	CS712	MG122404.....	JS365
D8E103.....	CS127	D9E17.....	CS89	D9R135.....	CS343	MG122433.....	JS769
D8E104.....	CS129	D9E18.....	CS93	D9R142.....	CS964	MG122433.....	JS892
D8E106.....	CS151	D9E19.....	CS130	D9R144.....	CS1035	MG232415.....	JS553
D8E107.....	CS150	D9E20.....	CS95	D9R149.....	CS1162	MP112033.....	JS1004
D8E109.....	CS180	D9E200.....	CS280	D9R237.....	CS310	MP112040.....	JS628
D8E111.....	CS94	D9E21.....	CS165	D9R73.....	CS353	MP112040.....	JS628
D8E113.....	CS151	D9E237.....	CS310	D9R84.....	CS373	MP112041.....	JS658
D8E116.....	CS126	D9E238.....	CS310	D9R89.....	CS524	MP112042.....	JS1004

O.E. NO.	HC-PARTS	O.E. NO.	HC-PARTS	O.E. NO.	HC-PARTS	O.E. NO.	HC-PARTS
<b>VALEO <i>Continued</i></b>							
MP112043	JS781	NA366	CA558IR	NA485	CA1052IR	ND059	CS371
NA014	CA94IR	NA371	CA333IR	NA486	CA1102IR	ND061	CS78
NA028	CA305IR	NA374	CA549IR	NA487	CA1104IR	ND062	CS123
NA036	CA126IR	NA376	CA524IR	NA488	CA596IR	ND063	CS79
NA039	CA169IR	NA378	CA527IR	NA489	CA596IR	ND064	CS77
NA058	CA1387IR	NA379	CA838IR	NA492	CA254IR	ND069	CS317
NA065	CA18H	NA380	CA252IR	NA494	CA1336IR	ND070	CS280
NA098	CA372IR	NA384	CA587IR	NA496	CA1077IR	ND076	CS608
NA116	CA377IR	NA385	CA556IR	NA498	CA1079IR	ND078	CS543
NA117	CA112	NA387	CA1192IR	NA499	CA1077IR	ND079	CS109
NA118	CA23V	NA388	CA1192IR	NA500	CA1043IR	ND091	CS91
NA120	CA139IR	NA390	CA581IR	NA501	CA1073IR	ND094	CS162
NA122	CA140IR	NA391	CA649IR	NA502	CA897IR	ND095	CS263
NA123	CA141IR	NA393	CA625IR	NA503	CA1139IR	ND096	CS79
NA128	CA136IR	NA394	CA612IR	NA504	CA1044IR	ND108	CS390
NA129	CA139IR	NA395	CA640IR	NA505	CA1573IR	ND109	CS551
NA134	CA276IR	NA396	CA332IR	NA506	CA1310IR	ND110	CS390
NA142	CA125IR	NA397	CA579IR	NA507	CA558IR	ND113	CS1106
NA181	CA212IR	NA398	CA535IR	NA509	CA705IR	ND114	CS310
NA201	CA302IR	NA399	CA634IR	NA510	CA898IR	ND121	CS681
NA202	CA520IR	NA400	CA229IR	NA513	CA557IR	ND122	JS380
NA205	CA557IR	NA402	CA609IR	NA514	CA705IR	ND124	CS119
NA206	CA328IR	NA405	CA1063IR	NA516	CA75	ND127	CS306
NA209	CA172IR	NA406	CA605IR	NA518	CA187IR	ND128	CS542
NA214	CA129IR	NA407	CA606IR	NA520	CA858IR	ND129	CS542
NA216	CA355IR	NA408	CA635IR	NA521	CA1583IR	ND131	CS581
NA224	CA128IR	NA409	CA632IR	NA522	CA1334IR	ND134	CS519
NA226	CA352IR	NA414	CA716IR	NA523	CA1312IR	ND135	CS331
NA230	CA592IR	NA415	CA639IR	NA524	CA1305IR	ND136	CS681
NA232	CA289IR	NA422	CA634IR	NA526	CA1247IR	ND138	CS1177
NA236	CA165IR	NA423	CA638IR	NA527	CA1256IR	ND140	CS807
NA238	CA371IR	NA425	CA748IR	NA528	CA1400IR	ND145	CS310
NA239	CA170IR	NA426	CA898IR	NA529	CA1256IR	ND146	CS983
NA242	CA735IR	NA433	CA637IR	NA530	CA1559IR	ND147	CS1035
NA243	CA378IR	NA434	CA820IR	NA531	CA1569IR	ND147	CS783
NA245	CA150IR	NA435	CA1304IR	NA532	CA1578IR	ND149	CS993
NA246	CA165IR	NA436	CA889IR	NA533	CA1395IR	ND152	CS684
NA247	CA308IR	NA437	CA740IR	NA534	CA1342IR	ND155	CS791
NA248	CA178IR	NA438	CA736IR	NA535	CA1390IR	ND156	CS681
NA249	CA229IR	NA439	CA912IR	NA536	CA1150IR	ND158	CS285
NA250	CA303IR	NA440	CA829IR	NA537	CA1389IR	ND159	CS796
NA251	CA314IR	NA441	CA837IR	NA538	CA1495IR	ND160	CS327
NA252	CA529IR	NA442	CA825IR	NA539	CA1200IR	ND161	CS964
NA254	CA332IR	NA444	CA1062IR	NA540	CA1078IR	ND162	CS1044
NA255	CA291IR	NA445	CA1044IR	NA541	CA1056IR	ND163	CS684
NA256	CA294IR	NA446	CA1042IR	NA542	CA1036IR	ND164	CS1060
NA257	CA84IR	NA447	CA1054IR	NA543	CA1309IR	ND165	CS1057
NA259	CA268IR	NA448	CA1054IR	NA544	CA1309IR	ND168	CS1108
NA265	CA356IR	NA449	CA896IR	NA545	CA1344IR	ND169	CS684
NA266	CA361IR	NA450	CA733IR	NA546	CA1307IR	ND170	CS727
NA268	CA512IR	NA454	CA618IR	NA547	CA1322IR	ND171	CS681
NA269	CA373IR	NA455	CA827IR	NA548	CA1333IR	ND172	CS1164
NA278	CA370IR	NA456	CA1579IR	NA549	CA1434IR	ND204	CS1177
NA281	CA375IR	NA457	CA845IR	NA550	CA1319IR	ND209	CS1117
NA282	CA369IR	NA458	CA816IR	NA551	CA1444IR	ND210	CS621
NA285	CA300IR	NA459	CA819IR	NA552	CA1298IR	ND211	CS542
NA287	CA813IR	NA460	CA821IR	NA553	CA314IR	ND212	CS581
NA288	CA510IR	NA461	CA1036IR	NA554	CA716IR	ND213	CS882
NA290	CA532IR	NA462	CA1059IR	NA557	CA1096IR	ND214	CS1131
NA294	CA526IR	NA463	CA607IR	NA560	CA1486IR	ND215	CS1055
NA297	CA814IR	NA464	CA633IR	NA561	CA837IR	ND216	CS1174
NA302	CA535IR	NA465	CA140IR	ND001	CS127	ND217	CS886
NA305	CA315IR	NA466	CA890IR	ND007	CS275	ND218	CS978
NA312	CA749IR	NA467	CA1157IR	ND010	CS168	S0001250303	CS1462
NA313	CA643IR	NA468	CA1039IR	ND020	CS132	S635329A	CS1380
NA315	CA831IR	NA469	CA1038IR	ND022	CS523	SG09B063	CA1499IR
NA316	CA359IR	NA470	CA1095IR	ND025	CS354	SG10B010	CA1506IR
NA317	CA533IR	NA471	CA1238IR	ND027	CS128	SG10B011	CA1622IR
NA336	CA380IR	NA472	CA1323IR	ND040	CS306	SG10B012	CA1053IR
NA337	CA721	NA473	CA1041IR	ND043	CS321	SG10B013	CA1738IR
NA345	CA525IR	NA474	CA914IR	ND049	CS126	SG10B014	CA1738IR
NA346	CA574IR	NA475	CA1080IR	ND049	CS94	SG10B016	CA1771IR
NA350	CA526IR	NA476	CA913IR	ND050	CS126	SG10B019	CA1572IR
NA352	CA711IR	NA477	CA1086IR	ND050	CS94	SG10B020	CA1771IR
NA360	CA705IR	NA478	CA1203IR	ND051	CS166	SG10B021	CA1564IR
NA361	CA705IR	NA479	CA1065IR	ND052	CS385	SG10B022	CA1589IR
NA363	CA857IR	NA480	CA836IR	ND055	CS361	SG10B023	CA1681IR
NA363	CA858IR	NA481	CA1098IR	ND057	CS315	SG10B031	CA1622IR
NA365	CA333IR	NA484	CA1156IR	ND058	CS310	SG10B032	CA1622IR ▲

O.E. NO.	HC-PARTS	O.E. NO.	HC-PARTS	O.E. NO.	HC-PARTS	O.E. NO.	HC-PARTS
SG10B032.....	CA1622IR ▲	SG15L026.....	CA1680IR	SG9B069.....	CA1560IR	TG15C028.....	CA1761IR
SG10B035.....	CA1622IR	SG15L027.....	CA1767IR	SG9B077.....	CA1086IR	TG15C034.....	CA1873IR
SG10B041.....	CA1053IR	SG15L033.....	CA2025IR	SG9B078.....	CA1446IR	TG15C038.....	CA1757IR ▲
SG10B048.....	CA1879IR	SG15L034.....	CA1767IR	SG9B079.....	CA1875IR	TG15C048.....	CA1911IR
SG11B010.....	CA1773IR	SG15L035.....	CA1767IR	SG9B087.....	CA1378IR	TG15C053.....	CA1761IR
SG11B010.....	CA1773IR	SG15L036.....	CA2025IR	SG9B089.....	CA1829IR	TG15C054.....	CA1674IR
SG11B010.....	CA1773IR	SG15S010.....	CA2037IR	SG9B107.....	CA1976IR	TG15C056.....	CA1873IR
SG12B010.....	CA1759IR	SG15S016.....	CA1509IR	SG9B108.....	CA1829IR	TG15C057.....	CA1873IR
SG12B011.....	CA1588IR	SG15S017.....	CA1674IR	TA000A14501.....	JA994IR	TG15C058.....	CA1959IR
SG12B012.....	CA1541IR	SG15S018.....	CA1553IR	TA000A15101.....	JA689IR	TG15C064.....	CA1757IR
SG12B015.....	CA1394IR	SG15S019.....	CA1778IR	TA000A33001.....	CA1057IR	TG15C065.....	CA1769IR
SG12B017.....	CA1627IR	SG15S021.....	CA1509IR	TA000A33002.....	CA1057IR	TG15C072.....	CA2051IR *
SG12B018.....	CA1664IR	SG15S022.....	CA1553IR	TA000A44301.....	JA1718IR	TG15C073.....	CA1904IR
SG12B020.....	CA1574IR	SG15S024.....	CA1761IR	TA000A48201.....	JA1804IR	TG15C091.....	CA1936IR
SG12B021.....	CA1689IR	SG15S025.....	CA2008IR	TA000A52202.....	JA1600IR	TG15C093.....	CA1904IR
SG12B023.....	CA1872IR	SG15S030.....	CA1584IR	TA000A54701.....	JA1711IR ▲	TG15C103.....	CA1970IR
SG12B024.....	CA1656IR	SG15S031.....	CA1850IR	TA000A55401.....	JA1172IR	TG15C112.....	CA2008IR
SG12B025.....	CA1588IR	SG15S032.....	CA2037IR	TA000A55601.....	JA1798IR	TG15C115.....	CA1509IR
SG12B027.....	CA1623IR	SG15S037.....	CA1778IR	TA000A56901.....	JA1709IR	TG15C116.....	CA1553IR
SG12B029.....	CA1591IR	SG6S010.....	CA1066IR	TA000A57301.....	JA1518IR	TG15C117.....	CA1388IR
SG12B030.....	CA1661IR	SG7S010.....	CA1484IR	TA000A57401.....	JA1711IR	TG15C118.....	CA1761IR
SG12B038.....	CA1881IR	SG7S012.....	CA1637IR	TA000A58602.....	JA1717IR	TG15C119.....	CA1674IR
SG12B039.....	CA1982IR	SG7S013.....	CA1484IR	TA000A61201.....	JA1709IR	TG15C121.....	CA1873IR
SG12B040.....	CA1643IR	SG7S014.....	CA1442IR	TA000A62401.....	JA1804IR	TG15C125.....	CA1936IR
SG12B042.....	CA1836IR	SG7S015.....	CA1498IR	TA000A62401.....	JA1804IR	TG15C134.....	CA2008IR
SG12B045.....	CA1574IR	SG7S016.....	CA1687IR	TA0B09601.....	JA787IR	TG15C135.....	CA2033IR
SG12B047.....	CA1754IR	SG7S020.....	CA1490IR	TG10B013.....	CA1879IR	TG15C146.....	CA1974IR
SG12B049.....	CA1541IR	SG7S021.....	CA1391IR	TG10B024.....	CA1879IR	TG15C154.....	CA2008IR
SG12B050.....	CA1645IR	SG7S024.....	CA1442IR	TG11C010.....	CA1768IR	TG16C013.....	CA1911IR
SG12B052.....	CA1814IR	SG7S025.....	CA861IR	TG11C011.....	CA1762IR	TG16C014.....	CA1996IR
SG12B054.....	CA1588IR	SG7S028.....	CA1298IR	TG11C014.....	CA1729IR	TG17C010.....	CA1905IR
SG12B055.....	CA1662IR	SG7S070.....	CA1637IR	TG11C015.....	CA1817IR	TG17C010B.....	CA1905IR
SG12B060.....	CA1872IR ▲	SG7S071.....	CA1484IR	TG11C016.....	CA1818IR	TG17C011.....	CA1905IR
SG12B062.....	CA1752IR	SG7S074.....	CA1298IR	TG11C017.....	CA1810IR	TG17C015.....	CA1953IR
SG12B065.....	CA1660IR	SG8B010.....	CA1545IR	TG11C021.....	CA1874IR	TG17C019.....	CA1912IR
SG12B068.....	CA1661IR	SG8B011.....	CA1436IR	TG11C022.....	CA1768IR	TG17C020.....	CA1937IR
SG12B071.....	CA1627IR	SG8B013.....	CA1502IR	TG11C027.....	CA2043IR	TG17C024.....	CA1910IR
SG12B071.....	CA1627IR	SG8B015.....	CA1511IR	TG11C034.....	CA1762IR ▲	TG17C032.....	CA2055IR *
SG12B072.....	CA1661IR	SG8B016.....	CA1566IR	TG11C035.....	CA1874IR	TG17C034.....	CA2095IR *
SG12B074.....	CA1759IR	SG8B017.....	CA1568IR	TG11C040.....	CA2057IR	TG17C041.....	CA2038IR
SG12B075.....	CA1754IR	SG8B018.....	CA1504IR	TG11C041.....	CA1975IR	TG17C048.....	CA1905IR
SG12B080.....	CA1631IR	SG8B020.....	CA1496IR	TG11C048.....	CA1921IR	TG17C054.....	CA1910IR
SG12B081.....	CA1814IR	SG8B021.....	CA1499IR	TG11C049.....	CA1768IR	TG17C061.....	CA2038IR
SG12B087.....	CA1481IR	SG8B022.....	CA1665IR	TG11C055.....	CA2003IR	TG23C012.....	CA2100IR *
SG12B089.....	CA1933IR	SG8B023.....	CA1755IR ▲	TG11C056.....	CA2054IR	TG23C017.....	CA2053IR
SG12B090.....	CA1394IR	SG8B026.....	CA1755IR	TG11C057.....	CA2056IR *	TG7S010.....	CA1498IR
SG12B092.....	CA2058IR *	SG8B027.....	CA1502IR	TG11C060.....	CA2003IR	TG7S011.....	CA1687IR
SG12B095.....	CA1645IR	SG9B010.....	CA1546IR	TG11C061.....	CA1768IR	TG7S012.....	CA1993IR
SG12B096.....	CA1627IR	SG9B011.....	CA1546IR ▲	TG11C062.....	CA1762IR	TG7S013.....	CA1687IR
SG12B097.....	CA1661IR	SG9B013.....	CA1378IR	TG11C063.....	CA2043IR	TG7S014.....	CA1498IR
SG12B098.....	CA1814IR	SG9B015.....	CA1446IR	TG11C064.....	CA1762IR ▲	TG7S015.....	CA1687IR
SG12B103.....	CA1881IR	SG9B017.....	CA1540IR	TG11C065.....	CA2057IR	TG8C011.....	JA1725IR
SG12B105.....	CA1933IR	SG9B018.....	CA1512IR	TG11C066.....	CA1975IR	TG8C011.....	JA1725IR
SG12B107.....	CA1661IR	SG9B019.....	CA1567IR	TG11C068.....	CA2054IR	TG8C018.....	CA1963IR
SG12B108.....	CA1645IR	SG9B023.....	CA1560IR	TG11C069.....	CA1975IR	TG8S010.....	CA1856IR
SG12B109.....	CA1814IR	SG9B024.....	CA1542IR	TG11C074.....	CA1874IR	TG8S012.....	CA1855IR
SG12B110.....	CA1627IR	SG9B025.....	CA2088IR *	TG12C021.....	CA1990IR *	TG8S013.....	CA1855IR
SG12B116.....	CA1645IR	SG9B027.....	CA1546IR ▲	TG12C033.....	CA1906IR	TG8S014.....	CA1855IR
SG12B122.....	CA1661IR	SG9B029.....	CA1256IR	TG12C037.....	CA2044IR *	TG8S017.....	CA1304IR
SG12B123.....	CA1627IR	SG9B033.....	CA1628IR	TG12C038.....	CA2091IR *	TG8S019.....	CA1963IR
SG12B124.....	CA2058IR *	SG9B035.....	CA1976IR	TG12C059.....	CA1954IR	TG8S021.....	CA1856IR
SG12S019.....	CA1392IR	SG9B037.....	CA1342IR	TG12C061.....	CA1954IR	TG8S022.....	CA1855IR
SG12S051.....	CA1741IR	SG9B038.....	CA1390IR	TG12C077.....	CA2101IR *	TG8S024.....	CA1977IR
SG12S055.....	CA1646IR	SG9B039.....	CA1390IR	TG12C087.....	CA2044IR *	TG8S025.....	CA1304IR
SG12S073.....	CA2052IR	SG9B042.....	CA1540IR	TG12C094.....	CA1933IR	TG9B024.....	CA1499IR
SG12S077.....	CA1741IR	SG9B047.....	CA1628IR	TG14C011.....	CA1782IR	TG9B025.....	CA1665IR
SG14B010.....	CA1811IR	SG9B048.....	CA1675IR ▲	TG14C012.....	CA1985IR	TG9B026.....	CA1879IR
SG14B011.....	CA1678IR	SG9B050.....	CA1654IR	TG14C014.....	CA2002IR	TG9B028.....	CA1589IR
SG14B012.....	CA1746IR	SG9B053.....	CA1829IR	TG14C015.....	CA1782IR	TG9B042.....	CA1866IR
SG14B013.....	CA1746IR	SG9B054.....	CA1781IR	TG14C022.....	CA1992IR	TG9B043.....	CA1665IR
SG14B016.....	CA1811IR	SG9B055.....	CA1512IR	TG14C025.....	CA1811IR	TG9B044.....	CA1879IR
SG14B017.....	CA1774IR	SG9B057.....	CA1675IR	TG15C012.....	CA1757IR	TG9B045.....	CA1499IR
SG14B019.....	CA1325IR	SG9B059.....	CA1378IR	TG15C015.....	CA1388IR	TG9B047.....	CA2098IR *
SG14B020.....	CA1325IR	SG9B063.....	CA1499IR	TG15C017.....	CA1769IR	TG9B049.....	CA2031IR
SG14B022.....	CA1811IR	SG9B064.....	CA1665IR	TG15C018.....	CA1825IR	TG9B064.....	CA1499IR
SG15L012.....	CA1680IR	SG9B065.....	CA1499IR	TG15C020.....	CA1761IR	TG9B065.....	CA1681IR
SG15L013.....	CA1767IR	SG9B066.....	CA1499IR	TG15C022.....	CA1674IR	TG9B066.....	CA1879IR
SG15L020.....	CA1767IR	SG9B067.....	CA1665IR	TG15C023.....	CA1850IR	TG9B068.....	CA2031IR
SG15L023.....	CA2025IR	SG9B068.....	CA1875IR	TG15C027.....	CA1904IR	TG9C013.....	CA1758IR

O.E. NO.	HC-PARTS	O.E. NO.	HC-PARTS	O.E. NO.	HC-PARTS	O.E. NO.	HC-PARTS
<b>VALEO Continued</b>							
TG9S010	CA1862IR	VA121	CA17V	VA232	CA562IR	VA325	JA974IR
TG9S011	CA1934IR	VA122	CA22H	VA234	CA584IR	VA326	CA87IR
TG9S015	CA1862IR	VA123	CA85IR	VA235	JA756IR	VA327	JA115IR
TG9S016	CA1862IR	VA124	CA173IR	VA236	CA295IR	VA328	JA598IR
TG9S021	CA1862IR	VA125	CA176IR	VA237	JA171IR	VA330	JA107IR
TG9S022	CA1862IR	VA126	CA170IR	VA238	JA753IR	VA331	JA762IR
TG9S036	CA1862IR	VA126	CA288IR	VA239	CA324IR	VA332	JA974IR
TG9S039	CA1934IR	VA127	CA242IR	VA240	JA543IR	VA333	CA1238IR
TM000A06901	JS365	VA128	CA52IR	VA241	JA655IR	VA334	CA1203IR
TM000A07901	JS922	VA129	CA169IR	VA242	JA140	VA335	CA1152IR
TM000A08401	JS923	VA130	CA175IR	VA243	JA189IR	VA336	CA1052IR
TM000A14401	CS1492	VA131	CA378IR	VA244	JA144	VA337	CA1156IR
TM000A14901	JS770	VA132	CA87IR	VA245	CA299IR	VA338	CA1065IR
TM000A18001	JS1098	VA132	CS126	VA247	JA164IR	VA339	CA1098IR
TM000A24601	JS892	VA133	CA322IR	VA248	CA1028IR	VA340	CA557IR
TM000A19301	JS658	VA135	CA627IR	VA248	CA311IR	VA341	CA1095IR
TM000A23601	JS1355	VA137	CA276IR	VA249	JA166IR	VA342	CA524IR
TM000A27301	JS1311	VA140	CA564IR	VA250	JA113IR	VA343	CA612IR
TM000A34101	JS1312	VA141	CA139IR	VA251	JA173IR	VA344	CA605IR
TM000A31001	JS1303	VA143	CA314IR	VA252	JA575IR	VA345	CA602IR
TM000A31201	JS1349	VA144	CA350IR	VA253	JA163IR	VA346	CA526IR
TM000A33401	JS1365	VA145	CA229IR	VA256	CA298IR	VA347	CA606IR
TM000A34101	JS1351	VA147	CA150IR	VA258	CA816IR	VA348	CA607IR
TM000A36101	JS1351	VA150	CA369IR	VA259	CA1029IR	VA349	CA635IR
TM000A37001	JS1303	VA153	CA372IR	VA259	CA611IR	VA350	CA838IR
TM000A37201	JS1311	VA153	CS95	VA261	CA251IR	VA351	CA640IR
TM000A37301	JS1312	VA154	CA372IR	VA262	CA196IR	VA352	CA896IR
TM000A37901	JS1370	VA155	CA141IR	VA263	CA345IR	VA353	CA1036IR
TM000A38001	CS1433	VA159	CA264IR	VA264	CA345IR	VA354	CA1320IR
TS10E1	CS1407	VA159	CA508IR	VA265	CA332IR	VA355	CA1040IR
TS10E26	CS1330	VA162	CA308IR	VA267	CA229IR	VA356	CA913IR
TS10E3	CS1276	VA163	CA99IR	VA268	JA149	VA357	CA914IR
TS10E4	CS1174	VA164	CA172IR	VA269	CA297IR	VA358	CA816IR
TS10E5	CS1174	VA166	CA252IR	VA270	CA342IR	VA359	CA821IR
TS12E10	CS1050	VA167	CA110IR	VA271	CA574IR	VA360	CA817IR
TS12ER20	CS1470	VA173	CA375IR	VA274	CA235IR	VA361	CA1225IR
TS14E11	CS1275	VA174	CA628IR	VA275	CA300IR	VA362	CA1101IR
TS14E110	CS1260	VA175	CA60IR	VA276	CA328IR	VA363	CA310IR
TS18E1	CS1293	VA177	CA88	VA277	CA521IR	VA364	CA827IR
TS18E13	CS1329	VA178	CA174IR	VA278	CA320IR	VA365	CA736IR
TS18E3	CS1323	VA180	CA115	VA279	CA538IR	VA366	CA733IR
TS18ER123	CS1323	VA181	CA88IR	VA280	CA1042IR	VA367	CA740IR
TS18ER20	CS1480	VA186	CA84IR	VA281	CA1064IR	VA368	CA313IR
TS22E26	CS1391	VA187	CA52IR	VA282	CA845IR	VA374	JA552IR
TS22E5	CS1415	VA188	CA271IR	VA283	CA533IR	VA377	CA861IR
TS22E5B	CS1415	VA189	CA359IR	VA284	CA294IR	VA380	CA139IR
TS22E8	CS1415	VA190	CA303IR	VA286	CA637IR	VA381	CA276IR
TS22E9	CS1415	VA191	CA356IR	VA287	CA638IR	VA382	CA376IR
TS8E1	CS1057	VA193	CA512IR	VA288	CA587IR	VA383	CA588IR
TS8E2	CS581	VA194	CA225IR	VA290	CA617IR	VA386	CA1077IR
TS8E3	JS1307	VA195	CA347IR	VA291	CA618IR	VA387	CA1079IR
TS8E4	JS1226	VA196	CA42	VA292	CA820IR	VA388	CA1078IR
TS8E5	JS1307	VA196	CA42IR	VA293	CA730IR	VA389	CA848IR
TS8E6	CS1385	VA200	CA48IR	VA294	CA729IR	VA390	JA755IR
VA100	CA17H	VA203	CA307IR	VA295	CA1086IR	VA391	CA1044IR
VA101	CA17V	VA206	CA228IR	VA296	CA715IR	VA392	CA1062IR
VA102	CA126IR	VA207	CA131	VA297	CA377IR	VA98	CA15H
VA102	CA611IR	VA208	CA165IR	VA298	JA160IR	VA99	CA17V
VA103	CA306IR	VA209	CA317IR	VA300	CA506IR	VS101	CS123
VA103	CA94IR	VA211	CA288IR	VA301	CA129IR	VS102	CS18
VA104	CA226IR	VA212	CA96IR	VA301	CA1435IR	VS103	CS310
VA104	CA96IR	VA214	CA517IR	VA304	CA644IR	VS104	CS1201
VA105	CA18H	VA215	CA516IR	VA306	CA255IR	VS104	CS590
VA106	CA306IR	VA216	CA514IR	VA307	CA1039IR	VS106	CS278
VA107	CA18V	VA218	JA131	VA308	CA1157IR	VS107	CS181
VA108	CA289IR	VA218	JA137	VA309	CA561IR	VS108	CS181
VA109	CA294IR	VA219	JA101	VA310	CA738IR	VS109	CS19
VA110	CA600IR	VA220	JA100	VA311	CA563IR	VS110	CS116
VA111	CA17H	VA221	JA104IR	VA313	CA650IR	VS111	CS18
VA112	CA18H	VA222	JA150IR	VA314	JA771IR	VS112	CS321
VA113	CA291IR	VA223	JA150IR	VA315	JA555IR	VS114	CS263
VA114	CA128IR	VA224	JA137	VA316	JA168	VS115	CS162
VA115	CA158IR	VA225	JA104IR	VA317	JA751IR	VS117	CS326
VA115	CA507IR	VA226	JA108IR	VA318	JA170	VS118	CS169
VA116	CA508IR	VA227	JA127IR	VA319	JA554IR	VS119	CS341
VA117	CA136IR	VA228	JA128IR	VA320	JA146IR	VS120	CS325
VA119	CA1554IR	VA229	JA125IR	VA322	JA129IR	VS122	CS316
VA119	CA325IR	VA230	CA594IR	VA323	CA560IR	VS123	CS592
VA120	CA131IR	VA231	CA560IR	VA324	CA325IR	VS124	CS708

O.E. NO.	HC-PARTS	O.E. NO.	HC-PARTS	O.E. NO.	HC-PARTS	O.E. NO.	HC-PARTS
VS125	CS528	VS227	CS393	VS319	CS681	049903015	CA521R
VS126	CS79	VS228	JS311	VS320	CS310	049903025	CA241IR
VS127	CS155	VS229	JS354	VS321	CS317	049903027	CA320IR
VS128	CS337	VS230	JS325	VS322	CS882	052903015	CA331R
VS129	CS129	VS231	CS294	VS323	CS964	052903017	CA331R
VS129	CS352	VS232	CS344	VS324	CS791	052903023	CA331R
VS131	CS70	VS232	CS964	VS325	CS280	052911023	CS79
VS132	CS126	VS233	JS385	VS326	CS684	053911023	CS569
VS134	CS143	VS235	CS330	VS328	CS346	054903015	CA521IR
VS136	CS720	VS236	CS390	VS329	CS618	055903023	CA331R
VS137	CS78	VS238	JS641	VS329	CS713	056911023	CS77
VS138	CS592	VS239	CS518	VS330	CS286	058903016	CA1093IR
VS139	CS91	VS240	JS357	VS333	JS380	058903018	CA1093IR
VS140	CS373	VS241	CS536	VS334	JS382	059903015	CA1141IR
VS141	CS72	VS243	CS589	VS335	JS377	059911024	CS1411
VS142	CS315	VS244	JS627	VS336	JS381	060903017	CA141IR
VS143	CS95	VS247	JS319	VS337	JS331	060903023	CA351R
VS144	CS355	VS247	JS645	VS338	JS335	060911023	CS83
VS145	CS90	VS249	CS516	VS340	CS619	061903023	CA351R
VS146	CS130	VS251	CS682	VS341	CS723	061911023	CS266
VS147	CS168	VS252	CS333	VS342	CS299	063903015	CA163IR
VS148	CS188	VS254	CS294	VS343	CS358	063903017	CA163IR
VS149	CS282	VS255	CS295	VS344	CS389	068903017	CA367IR
VS150	CS691	VS257	CS785	VS345	CS681	068903023	CA241IR
VS152	CS66	VS258	CS785			068903025	CA136IR
VS153	CS77	VS259	CS561	VOLKSWAGEN		068903031	CA302IR
VS154	CS83	VS261	CS724	001911023	CS1063	068911023	CS185
VS156	CS371	VS262	CS341	001911023	CS1063	069903017	CA237IR
VS162	CS170	VS263	CS592	012911023	CS1064	069903023	CA246IR
VS163	CS142	VS264	CS592	020911023	CS294	069911023	CS347
VS164	CS1056	VS265	CS330	021903017	CA827IR	070903017	CA236IR
VS166	CS147	VS266	CS609	021903025	CA1266IR	070903024	CA1820IR
VS167	CS116	VS267	CS119	021903026	CA1763IR	071903016	CA1093IR
VS168	CS338	VS270	CS684	022903023	CA154	073903023	CA320IR
VS169	CS139	VS271	CS81	023903023	CA827IR	073911023	CS300
VS172	CS314	VS272	CS581	025903017	CA537IR	074903023	CA906IR
VS173	CS356	VS274	CS719	025903023	CA320IR	074903026	CA1446IR
VS174	CS290	VS275	CS131	025911023	CS683	075903023	CA318IR
VS175	CS606	VS276	CS180	026903015	CA296IR	077903015	CA700IR
VS177	CS1110	VS277	CS569	026903017	CA296IR	078903015	CA837IR
VS177	CS72	VS278	CS297	026911023	CS297	078911023	CS725
VS179	CS587	VS279	CS542	027903015	CA342IR	091911023	CS115
VS182	CS90	VS281	CS361	027903017	CA343IR	176911023	CS295
VS183	CS156	VS282	CS621	027911023	CS392	211903031	CG19
VS184	CS116	VS283	CS1177	028903018	CA827IR	211911023	CS62
VS186	CS575	VS283	CS373	028903025	CA521R	001911023C	CS1063
VS188	CS127	VS284	CS551	028903026	CA1543IR	003911023A	CS117
VS189	CS115	VS285	CS1177	028903028	CA1248IR	003911023B	CS117
VS191	CS579	VS285	CS594	028903030	CA1394IR	003911023BX	CS117
VS192	CS343	VS286	CS275	028903031	CA1541IR	003911023C	CS531
VS193	CS62	VS287	CS796	028903031	CA1541IR	003911023D	CS531
VS194	CS122	VS288	CS285	030903023	CA354IR	003911023DX	CS531
VS195	CS322	VS288	CS285	031911023	CS500	003911023DX	CS531
VS197	CS306	VS289	CS376	034903015	CA708IR	003911023E	CS531
VS199	CS579	VS290	CS504	034903016	CA700IR	003911023EX	CS531
VS201	CS148	VS291	CS374	034903017	CA343IR	00A903025	CA1301IR
VS202	CS165	VS292	CS554	034911023	CS282	00A903025A	CA1300IR
VS204	CS140	VS293	CS289	035903015	CA124IR	012911023E	CS1327
VS205	CS1183	VS294	CS278	035903017	CA328IR	012911023F	CS1327
VS205	CS162	VS295	CS340	035911023	CS132	020911023A	CS713
VS206	CS317	VS296	CS330	036903017	CA139IR	020911023AX	CS618
VS207	CS78	VS297	CS328	036903021	CA376IR	020911023B	CS713
VS208	CS722	VS298	CS625	036903023	CA331R	020911023D	CS789
VS209	JS300	VS300	JS356	036903024	CA1657IR	020911023DX	CS789
VS210	JS302	VS300	JS765	036903025	CA588IR	020911023F	CS1062
VS211	JS333	VS301	JS626	036903026	CA1511IR	020911023H	CS1343
VS212	JS307	VS302	CS230	036903027	CA588IR	020911023J	CS618
VS215	JS304	VS303	JS633	036903028	CS79	020911023L	CS618
VS217	JS315	VS305	JS1000	036911023	CS79	020911023M	CS618
VS218	JS305	VS305	JS640	037903018	CA840IR	020911023MX	CS618
VS219	JS325	VS306	JS637	037903023	CA840IR	020911023N	CS618
VS220	JS327	VS307	CS331	037911023	CS294	020911023P	CS789
VS221	JS378	VS308	CS360	038903018	CA1587IR	020911023PX	CS789
VS222	JS309	VS308	CS360	038903025	CA1547IR	020911023R	CS789
VS222	JS309	VS309	CS268	039911023	CS117	020911023S	CS1343
VS224	JS394	VS310	CS576	045903023	CA1441IR	020911023T	CS1343
VS225	JS387	VS312	JS556	046903015	CA123IR	020911024A	CS1287
VS226	JS335	VS313	JS389	046903017	CA123IR	021903017A	CA736IR
VS226	JS349	VS314	JS759	046911023	CS132	021903020DX	CA871R
VS226	JS350	VS316	CS566	047903015	CA163IR	021903023A	CA154
VS226	JS350	VS318	CS681	047903017	CA1586IR		

O.E. NO.	HC-PARTS	O.E. NO.	HC-PARTS	O.E. NO.	HC-PARTS	O.E. NO.	HC-PARTS
VOLKSWAGEN <i>Continued</i>							
021903023F	CA154	028903018FX	CA829IR	028903031X	CA1541IR	02T911024A	CS1330
021903023FX	CA154	028903018G	CA1486IR	028911023M	CS801	02T911024B	CS1330
021903023J	CA827IR	028903018X	CA827IR	028911028L	CA1226IR	02Z911023C	CS1330
021903023K	CA912IR	028903023A	CA35IR	02A911023	CS559	02Z911023E	CS1294
021903023L	CA1399IR	028903023B	CA35IR	02A911023A	CS559	02Z911023F	CS1293
021903023M	CA827IR	028903023C	CA52IR	02A911023AX	CS559	02Z911023FX	CS1293
021903023N	CA1399IR	028903023D	CA1058IR	02A911028B	CS574	02Z911023G	CS1294
021903023Q	CA829IR	028903023E	CA829IR	02A911023BX	CS574	02Z911023H	CS1293
021903025A	CA912IR	028903023EX	CA829IR	02A911023C	CS620	02Z911023H	CS1293
021903025B	CA1399IR	028903023F	CA1107IR	02A911023D	CS614	02Z911023HX	CS1293
021903025BX	CA1399IR	028903025A	CA852IR	02A911023DX	CS614	02Z911023HX	CS1293
021903025C	CA1143IR	028903025AX	CA852IR	02A911023E	CS601	02Z911024A	CS1505
021903025E	CA1268IR	028903025C	CA829IR	02A911023EX	CS601	02Z911024J	CS1293
021903025F	CA1269IR	028903025CX	CA829IR	02A911023F	CS619	030903023A	CA732IR
021903025G	CA1142IR	028903025E	CA829IR	02A911023FX	CS619	030903023B	CA733IR
021903025G	CA1142IR	028903025EX	CA829IR	02A911023G	CS616	030903023BX	CA733IR
021903025J	CA1402IR	028903025F	CA1147IR	02A911023GX	CS616	030903023C	CA740IR
021903025K	CA1394IR	028903025FX	CA1147IR	02A911023H	CS620	030903023D	CA732IR
021903025N	CA1269IR	028903025G	CA733IR	02A911023HX	CS620	030903023DX	CA732IR
021903025T	CA1644IR	028903025G	CA733IR	02A911023J	CS974	030903023E	CA733IR
021903026A	CA1763IR	028903025G	CA733IR	02A911023JX	CS974	030903023E	CA733IR
021903026B	CA1749IR	028903025H	CA827IR	02A911023L	CS1119	030903023EX	CA733IR
021903026L	CA1912IR	028903025HX	CA827IR	02A911023LV	CS1119	030903023F	CA740IR
022903023A	CA154	028903025P	CA740IR	02A911023LX	CS1119	030903023FX	CA740IR
022903028A	CA1763IR	028903025Q	CA740IR	02A911023Q	CS620	030903023H	CA1436IR
022903028B	CA1912IR	028903025P	CA740IR	02A911023R	CS974	030903023J	CA1378IR
023903023B	CA827IR	028903025Q	CA736IR	02A911023S	CS1266	030903023JX	CA1378IR
023903025R	CA828IR	028903025Q	CA736IR	02A911023T	CS619	030903023L	CA1511IR
025903017X	CA537IR	028903025QX	CA736IR	02A911023TX	CS619	030903023M	CA1512IR
025903023A	CA537IR	028903025QX	CA736IR	02A911023X	CS559	030903023X	CA354IR
025903023B	CA911IR	028903025R	CA828IR	02A911024	CS974	031903017C	CA364IR
025903023D	CA320IR	028903025S	CA1089IR	02A911024B	CS974	031903023B	CA364IR
025903023E	CA320IR	028903025S	CA1089IR	02A911024D	CS974	031903023C	CA364IR
025911023A	CS683	028903025SX	CA1089IR	02A911024E	CS1266	031911023A	CS500
025911023AX	CS683	028903026A	CA1239IR	02A911024G	CS974	031911023AX	CS500
026903015A	CA298IR	028903026B	CA1255IR	02A911024X	CS974	031911023X	CS500
026903015B	CA320IR	028903026E	CA1543IR	02B911023A	CS599	034903015B	CA343IR
026903015C	CA320IR	028903026G	CA1260IR	02B911023AX	CS599	034903015C	CA910IR
026903015D	CA296IR	028903026G	CA1260IR	02B911023B	CS597	034903015D	CA320IR
026903015DX	CA296IR	028903026H	CA1394IR	02B911023BX	CS597	034903015F	CA700IR
026903015E	CA298IR	028903027B	CA736IR	02B911023C	CS598	034903015H	CA320IR
026903015EX	CA298IR	028903027C	CA827IR	02B911023CX	CS598	034903015J	CA911IR
026903015F	CA320IR	028903027D	CA1089IR	02B911023D	CS801	034903015K	CA320IR
026903017A	CA298IR	028903027E	CA1248IR	02B911023DX	CS801	034903015M	CA320IR
026903017AX	CA298IR	028903027G	CA1147IR	02B911023E	CS1209	034903015Q	CA343IR
026903017B	CA320IR	028903027H	CA827IR	02B911023F	CS1176	034903015T	CA521IR
026903017BX	CA320IR	028903027L	CA1265IR	02B911023J	CS801	034903016A	CA521IR
026903017N	CA298IR	028903027M	CA1341IR	02B911023L	CS801	034903016B	CA343IR
026903017X	CA296IR	028903027N	CA1228IR	02B911023M	CS1209	034903016D	CA521IR
026903023A	CA298IR	028903027P	CA1229IR	02B911023N	CS801	034903016E	CA320IR
026903023B	CA298IR	028903027P	CA1229IR	02E911023H	CS1286	034903016G	CA521IR
026911023A	CS77	028903027Q	CA1562IR	02E911023J	CS1409	034903016H	CA700IR
026911023AX	CS77	028903027S	CA1486IR	02E911023L	CS1286	034903016N	CA1140IR
026911023B	CS297	028903027T	CA1486IR	02M911023	CS1337	034903017A	CA708IR
026911023BX	CS297	028903028A	CA1147IR	02M911023A	CS1181	034903017B	CA700IR
026911023C	CS569	028903028B	CA1089IR	02M911023C	CS1181	034903017BX	CA700IR
026911023CX	CS569	028903028C	CA1436IR	02M911023D	CS1181	034903017X	CA343IR
026911023E	CS509	028903028D	CA1378IR	02M911023F	CS1181	034911023A	CS282
026911023EX	CS509	028903028DX	CA1378IR	02M911023G	CS1347	034911023X	CS282
026911023F	CS509	028903028E	CA1394IR	02M911023M	CS1347	035903015A	CA163IR
026911023FX	CS509	028903028F	CA1403IR	02M911023N	CS1323	035903015B	CA125IR
026911023G	CS569	028903028G	CA1265IR	02M911023N	CS1323	035903015D	CA328IR
026911023GX	CS569	028903028H	CA827IR	02M911023P	CS1323	035903015G	CA328IR
026911023X	CS297	028903028J	CA1297IR	02M911023Q	CS1405	035903015K	CA52IR
027903015A	CA343IR	028903028L	CA1226IR	02M911023R	CS1181	035903015L	CA141IR
027903015C	CA343IR	028903028P	CA1401IR	02M911024	CS1323	035903015M	CA244IR
027903015X	CA342IR	028903028R	CA1262IR	02M911024A	CS1323	035903015P	CA328IR
027911023X	CS392	028903029A	CA1540IR	02M911024G	CS1508	035903015Q	CA328IR
028903018A	CA1240IR	028903029B	CA1541IR	02M911024P	CS1323	035903015S	CA320IR
028903018AX	CA1240IR	028903029D	CA1540IR	02T911023B	CS1475	035903015T	CA910IR
028903018B	CA1089IR	028903029E	CA1541IR	02T911023C	CS1200	035903015X	CA124IR
028903018B	CA1089IR	028903029G	CA1394IR	02T911023E	CS1197	035903016C	CA328IR
028903018BX	CA1089IR	028903029M	CA1750IR	02T911023G	CS1282	035903017A	CA318IR
028903018BX	CA1089IR	028903029Q	CA1678IR	02T911023H	CS1200	035903017AX	CA318IR
028903018C	CA828IR	028903029R	CA1678IR	02T911023M	CS1324	035903017X	CA328IR
028903018CX	CA828IR	028903029S	CA1540IR	02T911023R	CS1330	035903023A	CA241IR
028903018E	CA1147IR	028903029T	CA1540IR	02T911023S	CS1330	035903023B	CA320IR
028903018EX	CA1147IR	028903030A	CA1394IR	02T911023T	CS1324	035903023D	CA320IR
028903018F	CA829IR	028903031A	CA1541IR	02T911024	CS1393	035911023A	CS132



O.E. NO.	HC-PARTS	O.E. NO.	HC-PARTS	O.E. NO.	HC-PARTS	O.E. NO.	HC-PARTS
035911023B	CS132	036903025M	CA297IR	038903018R	CA1542IR	047903015H	CA1542IR
035911023C	CS132	036903025N	CA354IR	038903018RX	CA1542IR	047903015J	CA1455IR
035911023D	CS282	036903025P	CA347IR	038903023G	CA1249IR	047903015M	CA1626IR
035911023E	CS132	036903025Q	CA376IR	038903023H	CA1570IR	047903015P	CA1093IR ▲
035911023EX	CS132	036903025QX	CA376IR	038903023J	CA1144IR	047903015Q	CA1586IR
035911023F	CS132	036903025S	CA588IR	038903023K	CA1502IR	047911023B	CS1211
035911023J	CS132	036903027B	CA588IR	038903023L	CA1446IR	047911023C	CS1204
035911023JX	CS132	036903027D	CA588IR	038903023Q	CA1502IR	047911023G	CS1204
035911023L	CS282	036903027E	CA376IR	038903023R	CA1446IR	049903015C	CA124IR
035911023LX	CS282	036903027G	CA376IR	038903023S	CA1394IR	049903015D	CA52IR
035911023M	CS282	036903028A	CA1512IR	038903023T	CA1587IR ▲	049903015E	CA52IR
035911023N	CS282	036911023A	CS79	038903024A	CA1446IR	049903015F	CA1141IR
035911023O	CS282	036911023B	CS79	038903024B	CA1502IR	049903015FX	CA1141IR
035911023Q	CS282	036911023C	CS293	038903024D	CA1446IR	049903015G	CA124IR
035911023QX	CS282	036911023D	CS79	038903024E	CA1446IR	049903015GX	CA124IR
035911023X	CS132	036911023E	CS293	038903024F	CA1394IR	049903015H	CA501IR
036903017A	CA136IR	036911023F	CS79	038903024G	CA1394IR	049903015J	CA141IR
036903017AX	CA136IR	036911023FX	CS79	038903025A	CA1548IR	049903015L	CA141IR
036903017B	CA139IR	036911023G	CS293	039903025B	CA588IR	049903015T	CA124IR
036903017C	CA277IR	036911023GX	CS293	039903027C	CA376IR	049903017A	CA242IR
036903017CX	CA277IR	036911023H	CS293	03C903023	CA1817IR	049903017B	CA241IR
036903017D	CA278IR	036911023HX	CS293	03C903023A	CA1985IR	049903017BX	CA241IR
036903017E	CA276IR	036911023J	CS79	03C903023AX	CA1985IR	049903017C	CA242IR
036903017EX	CA276IR	036911023K	CS293	03C903023B	CA1817IR	049903017CX	CA242IR
036903017F	CA297IR	036911023KX	CS293	03C903023C	CA1985IR	049903023B	CA124IR
036903017FX	CA297IR	036911023M	CS293	03C903023D	CA1817IR	049903023E	CA140IR
036903017G	CA619IR	036911023MX	CS293	03C903023G	CA1921IR	049903023F	CA140IR
036903017GX	CA619IR	036911023N	CS293	03C903023GX	CA1921IR	049903023FX	CA140IR
036903017H	CA588IR	036911023P	CS723	03C903023H	CA2056IR *	049903023G	CA141IR
036903017HX	CA588IR	036911023PX	CS723	03D903025D	CA1755IR ▲	049903023H	CA141IR
036903017J	CA347IR	036911023Q	CS788	03D903025E	CA1675IR ▲	049903023HX	CA141IR
036903017JX	CA347IR	036911023QX	CS788	03D903025H	CA1755IR	049903023J	CA140IR
036903017K	CA376IR	036911023R	CS723	03D903025J	CA1675IR	049903023K	CA141IR
036903017KX	CA376IR	036911023S	CS880	03G903016A	CA1910IR	049903023L	CA52IR
036903017L	CA354IR	036911023SX	CS880	03G903016A	CA1910IR	049903023M	CA328IR
036903017LX	CA354IR	036911023X	CS79	03G903016B	CA1986IR	049903023R	CA242IR
036903017Q	CA278IR	036911025B	CS880	03G903016BX	CA1986IR	049903023S	CA241IR
036903017QX	CA278IR	037903018A	CA841IR	03G903016E	CA1986IR	049903023SX	CA241IR
036903017X	CA139IR	037903018AX	CA841IR	03G903016EX	CA1986IR	049903023T	CA242IR
036903018B	CA1729IR	037903018X	CA840IR	03G903023	CA1912IR	049903023TX	CA242IR
036903023A	CA85IR	037903023A	CA841IR	03G903023X	CA1912IR	049903027A	CA320IR
036903023AX	CA85IR	037903023E	CA736IR	03G911023	CS1392	049903027F	CA242IR
036903023B	CA136IR	037903023F	CA828IR	03G11023A	CS1423	049911023D	CS77
036903023C	CA136IR	037903023G	CA736IR	03G911023AX	CS1423	049911023DX	CS77
036903023D	CA139IR	037903023GX	CA736IR	03L903023	CA2011IR	049911023E	CS77
036903023E	CA139IR	037903023P	CA298IR	03L903023A	CA2011IR	049911023G	CS297
036903023F	CA33IR	037903023Q	CA827IR	040903015G	CA124IR	049911023GX	CS297
036903023G	CA139IR	037903023Q	CA827IR	040903025.3	CA93IR	049911023H	CS297
036903023H	CA139IR	037903023QX	CA827IR	043903023A	CA93	050903015B	CA1244IR
036903023K	CA139IR	037903023QX	CA827IR	043903023B	CA93IR	050903015BX	CA1244IR
036903023L	CA136IR	037903025B	CA1267IR	043903023C	CA93IR	050903015C	CA908IR
036903023M	CA139IR	037903025C	CA1240IR	043903023CX	CA93IR	050903015CX	CA908IR
036903023N	CA136IR	037903025D	CA1241IR	043903023D	CA93IR	050903015G	CA843IR
036903023NX	CA136IR	037903025E	CA1511IR	043903023DX	CA93IR	050903015J	CA842IR
036903023P	CA139IR	037903025F	CA1512IR	043903023G	CA93IR	050903017A	CA827IR ▲
036903023PV	CA85IR	037903025G	CA1568IR	043903025A	CA93IR	050903023J	CA842IR
036903023PX	CA139IR	037903025H	CA1560IR	045903023A	CA1644IR	051903015D	CA700IR
036903023R	CA276IR	037903025J	CA1566IR	045903023B	CA1682IR	052903015A	CA85IR
036903023S	CA347IR	037903025K	CA1567IR	045903023D	CA2064IR *	052903017A	CA85IR
036903023SX	CA347IR	037903025L	CA1504IR	045903023E	CA1441IR	052903017AX	CA85IR
036903023T	CA276IR	037903025M	CA1542IR	045903023F	CA1644IR	052903017X	CA33IR
036903023TX	CA276IR	037903025N	CA1568IR	045903023G	CA1841IR	052911023A	CS79
036903023X	CA33IR	037903025P	CA1560IR	045903023GX	CA1841IR	052911023AX	CS79
036903024A	CA1733IR	037903025Q	CA1566IR	045903023H	CA2065IR	053903015B	CA843IR
036903024D	CA1729IR	037903025R	CA1567IR	045903025B	CA1682IR	053903015D	CA842IR
036903024E	CA1815IR	037903025S	CA1504IR	045903026C	CA1512IR	053903015E	CA842IR
036903024H	CA1729IR	037903025T	CA1542IR	046903015A	CA124IR	053911023A	CS612
036903024J	CA1729IR	037903026B	CA1567IR	046903015B	CA125IR	053911023B	CS612
036903024L	CA1560IR	037903026C	CA1512IR	046903015D	CA700IR ▲	053911023BX	CS612
036903024M	CA1815IR	038903018A	CA1542IR	046903015E	CA1397IR ▲	054903015A	CA700IR ▲
036903024N	CA1729IR	038903018B	CA1549IR	046903015F	CA1141IR	054903015C	CA855IR
036903025A	CA376IR	038903018C	CA1560IR	046903017A	CA124IR	054903015K	CA700IR ▲
036903025B	CA588IR	038903018CX	CA1560IR	046903017AX	CA124IR	054903015K	CA855IR
036903025D	CA85IR	038903018E	CA1546IR ▲	046903017X	CA123IR	054903015KX	CA855IR
036903025E	CA139IR	038903018EX	CA1546IR	046903115G	CA521IR ▲	054903015L	CA700IR
036903025F	CA85IR	038903018F	CA1588IR	046911023B	CS350	055903023A	CA85IR
036903025G	CA139IR	038903018P	CA1446IR	046911023BX	CS350	055903023B	CA35IR
036903025K	CA347IR	038903018PX	CA1446IR	046911023X	CS132	055903023BX	CA35IR
036903025L	CA376IR	038903018Q	CA1394IR ▲	047903015G	CA1504IR		

O.E. NO.	HC-PARTS	O.E. NO.	HC-PARTS	O.E. NO.	HC-PARTS	O.E. NO.	HC-PARTS
VOLKSWAGEN	<i>Continued</i>						
055903023C	CA52IR	060903017AX	CA140IR	068903029D	CA318IR	069903023X	CA246IR
055903023CX	CA52IR	060903017AY	CA35IR	068903029E	CA1058IR	069911023A	CS347
055903023D	CA141IR	060903017X	CA141IR	068903029F	CA318IR	069911023AX	CS347
055903023G	CA52IR	060903023A	CA52IR	068903029G	CA318IR	069911023B	CS386
055903023S	CA140IR	061903023A	CA52IR	068903029K	CA610IR	069911023BX	CS386
055911023A	CS276	061911023A	CS266	068903029M	CA318IR	069911023C	CS350
055911023AX	CS276	061911023AX	CS266	068903029N	CA318IR	069911023CX	CS350
055911023B	CS116	061911023V	CS266	068903029P	CA318IR	069911023D	CS350
055911023BX	CS116	061911023X	CS266	068903029Q	CA1058IR	069911023DX	CS350
055911023D	CS267	063903017X	CA163IR	068903029R	CA337IR	069911023E	CS1165
055911023DX	CS267	068903017A	CA706IR	068903029S	CA520IR	069911023F	CS1185
055911023E	CS294	068903017AX	CA706IR	068903029T	CA505IR	069911023H	CS1115
055911023F	CS294	068903017B	CA139IR	068903031A	CA297IR	069911023J	CS1187
055911023FX	CS294	068903017BX	CA139IR	068903031B	CA376IR	069911023K	CS1115
055911023G	CS615	068903017C	CA237IR	068903031C	CA619IR	069911023L	CS1165
055911023GX	CS615	068903017CX	CA237IR	068903031D	CA319IR	069911023M	CS1187
055911023H	CS294	068903017D	CA244IR	068903031E	CA297IR	069911023V	CS347
055911023HX	CS294	068903017DX	CA244IR	068903031EX	CA297IR	06A903023	CA1378IR
055911023J	CS294	068903017E	CA328IR	068903031F	CA297IR	06A903026	CA1378IR
055911023JX	CS294	068903017EX	CA328IR	068903031G	CA505IR	06A903026A	CA1378IR
055911023K	CS294	068903017G	CA277IR	068903031H	CA505IR	06A903026A	CA1378IR
055911023KX	CS294	068903017GX	CA277IR	068903031I	CA302IR	06A903026AX	CA1378IR
055911023L	CS294	068903017J	CA357IR	068903031L	CA337IR	06A903016	CA1545IR
055911023M	CS294	068903017JX	CA357IR	068903031J	CA337IR	06B903016A	CA1546IR
055911023MX	CS294	068903017K	CA376IR	068903031K	CA520IR	06B903016AB	CA1811IR
055911023R	CS294	068903017L	CA302IR	068903031KX	CA520IR	06B903016AC	CA1769IR
056903015A	CA35IR	068903017M	CA319IR	068903031L	CA319IR	06B903016AD	CA1759IR
056903015B	CA52IR	068903017MX	CA319IR	068903031Q	CA844IR	06B903016AE	CA1754IR
056903015C	CA125IR	068903017N	CA520IR	068903031R	CA610IR	06B903016AF	CA1811IR
056903015H	CA141IR	068903017NX	CA520IR	068903031RX	CA610IR	06B903016B	CA1759IR
056911023A	CS77	068903017P	CA318IR	068903031S	CA619IR	06B903016C	CA1545IR
056911023AX	CS77	068903017PX	CA318IR	068903031SX	CA619IR	06B903016D	CA1546IR
056911023B	CS77	068903017Q	CA610IR	068903033B	CA520IR	06B903016E	CA1759IR
056911023C	CS77	068903017QX	CA610IR	068903033E	CA1058IR	06B903016F	CA1664IR
056911023D	CS77	068903017R	CA505IR	068911023A	CS136	06B903016G	CA1664IR
058903015A	CA52IR	068903017RX	CA505IR	068911023AX	CS136	06B903016P	CA1754IR
058903016A	CA1139IR	068903017S	CA337IR	068911023C	CS185	06B903016Q	CA1769IR
058903016B	CA1139IR	068903017SX	CA337IR	068911023CX	CS185	06B903016S	CA1754IR
058903016BX	CA1139IR	068903017T	CA302IR	068911023D	CS299	06B903016AA	CA1811IR
058903016C	CA1140IR	068903017TX	CA302IR	068911023DX	CS299	06B911023	CS612
058903016D	CA1321IR	068903017X	CA367IR	068911023E	CS272	06B911023A	CS1394
058903016E	CA1139IR	068903018B	CA318IR	068911023EX	CS272	06B911023X	CS612
058903016X	CA1093IR	068903018BX	CA318IR	068911023F	CS348	06C903016	CA1588IR
058903018A	CA1139IR	068903018P	CA318IR	068911023FX	CS348	06C903016A	CA1588IR
058903018B	CA1139IR	068903023B	CA136IR	068911023G	CS295	06D903016	CA1769IR
058903018C	CA1140IR	068903023C	CA139IR	068911023GX	CS295	06D903016A	CA1811IR
058911023A	CS83	068903023F	CA139IR	068911023J	CS299	06D911021B	CS1437
058911023AX	CS83	068903023G	CA141IR	068911023JX	CS299	06D911023	CS1401
058911023B	CS612	068903023J	CA140IR	068911023L	CS606	06D911023A	CS1401
058911023BX	CS612	068903023K	CA277IR	068911023LX	CS606	06D911023B	CS1437
058911023F	CS1194	068903023L	CA136IR	068911023S	CS358	06E903016D	CA1996IR
059903015C	CA35IR	068903023N	CA139IR	068911023MX	CS358	06E911023B	CS1339
059903015D	CA52IR	068903023Q	CA237IR	068911023P	CS548	06E911023C	CS1339
059903015G	CA1588IR	068903023R	CA276IR	068911023PX	CS606	06F903023A	CA1782IR
059903015GX	CA1588IR	068903023S	CA357IR	068911023S	CS624	06F903023B	CA1818IR
059903015J	CA1546IR	068903023T	CA318IR	068911023SX	CS624	06F903023C	CA1782IR
059903015R	CA1937IR	068903023X	CA246IR	068911023T	CS713	06F903023D	CA1810IR
059903016D	CA1911IR	068903025A	CA139IR	068911023TX	CS713	06F903023E	CA1810IR
059903016E	CA1992IR	068903025C	CA367IR	068911023X	CS185	06F903023F	CA1782IR
059903016G	CA1992IR	068903025E	CA237IR	068911024B	CS624	06F903023G	CA1818IR
059903017D	CA52IR	068903025F	CA237IR	068911024BX	CS624	06F903023H	CA1782IR
059903017DX	CA52IR	068903025FX	CA237IR	068911024C	CS624	06F903023J	CA1782IR
059903017E	CA35IR	068903025G	CA244IR	068911024E	CS624	06F903016L	CA2007IR
059903017G	CA35IR	068903025H	CA328IR	068911024F	CS624	06H911021A	CS1437
059903017GX	CA35IR	068903025J	CA706IR	068911024F	CS624	06J903023C	CA1811IR
059903017H	CA125IR	068903025L	CA237IR	068911024G	CS624	070903017X	CA236IR
059903017HX	CA125IR	068903025Q	CA136IR	068911024G	CS624	070903023B	CA236IR
059903017K	CA1937IR	068903025T	CA141IR	068911024H	CS1208	070903023BX	CA236IR
059903023A	CA2002IR	068903027A	CA277IR	068911024K	CS295	070903024A	CA1819IR
059911023C	CS83	068903027B	CA276IR	068911024L	CS1387	070903024B	CA1820IR
059911023CX	CS83	068903027C	CA277IR	069903017A	CA318IR	070903024F	CA1819IR
059911023E	CS132	068903027D	CA357IR	069903017AX	CA318IR	070911023B	CS1378
059911023EX	CS132	068903027H	CA242IR	069903023A	CA237IR	071903016A	CA1397IR
059911023F	CS83	068903027P	CA367IR	069903023B	CA244IR	071903016C	CA1546IR
059911023FX	CS83	068903027PX	CA367IR	069903023C	CA328IR	071903016E	CA1664IR
059911023H	CS1114	068903027Q	CA237IR	069903023D	CA318IR	071903016G	CA1139IR
059911023H	CS1114	068903027QX	CA237IR	069903023F	CA520IR	071903023A	CA1107IR
059911023Q	CS1411	068903029A	CA318IR	069903023G	CA318IR	073903023A	CA320IR
060903017A	CA140IR	068903029C	CA1058IR	069903023H	CA318IR	073911023A	CS300

O.E. NO.	HC-PARTS	O.E. NO.	HC-PARTS	O.E. NO.	HC-PARTS	O.E. NO.	HC-PARTS
073911023AX	CS300	09A911023	CS1477	466772	CS391	3544624	CA899IR
073911023X	CS300	09A911023A	CS1390	468202	CS99	3544625	CA904IR
074903018A	CA1763IR	09A911023B	CS1390	469414	CS710	3545364	CA1096IR
074903023A	CA610IR	0AH911023	CS1322	477049	CS699	3803646	CS1271
074903023B	CA708IR	0AH911023A	CS1322	500300	CA272IR	3963143	CA1049IR
074903023C	CA708IR	0AH911023B	CS1397	834339	CS140	3964839	CS1161
074903023H	CA521IR	0AH911023BX	CS1397	838060	CS958	3978044	CS1474
074903023Q	CA1269IR	0AM911023B	CS1470	872258	CA1253IR	3978710	CS1285
074903023R	CA828IR	0AM911023D	CS1480	872258	CA1253IR	3986428	CA1049IR
074903023R	CA828IR	0AM911023Q	CS1480	872364	CS797	3986429	CA907IR
074903023X	CA906IR	111911021B	CS60	873348	CA1253IR	4772059	CS001
074903025A	CA610IR	111911021C	CS60	1089861	CA518IR	4880691	CS726
074903025B	CA844IR	111911021E	CS61	1089862	CA853IR	4881097	CS001
074903025BX	CA844IR	111911021EX	CS61	1096757	CA1049IR	5001600	CS135
074903025J	CA1454IR	111911021G	CS61	1096758	CA907IR	5001601	CS690
074903025K	CA1402IR	111911023BT	CS62	1235424	CA88	5001612	CA89
074903025L	CA1848IR	111911023C	CS62	1235908	CA88	5001613	CS292
074903025M	CA1587IR	111911023D	CS62	1257294	CA273	5001614	CS292
074903025N	CA1594IR	113903031G	CG19	1257938	CS347	5001615	CA88
074903025Q	CA1445IR	113903031GX	CG19	1257939	CS386	5001668	CS95
074903025R	CA1445IR	113903031H	CG17	1258994	CA273	5001669	CS95
074903025S	CA1763IR	113903031K	CG19	1269702	CA271IR	5001677	CA132IR
074903025T	CA1394IR	113903031M	CG19	1308720	CA88IR	5001679	CA132IR
075903023A	CA318IR	113903031N	CG19	1308723	CA591IR	5001680	CS544
076903023D	CA140IR	113903031P	CG19	1323351	CA271IR	5001683	CS710
076903023G	CA237IR	113903031PX	CG19	1323490	CA591IR	5001686	CS99
076903023H	CA537IR	113903031Q	CG19	1324142	CA272IR	5001701	CS321
076903023I	CA911IR	113911021B	CS60	1328392	CS386	5001759	CS783
076903023J	CA298IR	141911021A	CS61	1346707	CS292	5001782	CA366IR
076903023K	CA520IR	175903023K	CA141IR	1346707	CS292	5001784	CS391
076903023M	CA140IR	175903023L	CA141IR	1348401	CA591IR	5001835	CA366IR
076903023N	CA337IR	175911023B	CS116	1348508	CA528IR	5001866	CA273
076911023A	CS1435	175911023C	CS267	1348509	CA590IR	5001867	CS347
077903015C	CA700IR	1HS911023B	CS618	1357199	CS389	5001961	CA271IR
077903015E	CA1232IR	1LO903029	CA1058IR	1362798	CA811IR	5002050	CS386
077903015G	CA700IR	211903031A	CG19	1363451	CS680	5002051	CA88IR
077911023C	CS985	211903031D	CG17	1363494	CA900IR	5002052	CA591IR
077911023E	CS1041	211903031E	CG17	1363495	CA1551IR	5002476	CS338
078903015A	CA855IR	311903017D	CG16	1363496	CA381IR	5002608	CA580IR
078903015AX	CA855IR	311903017F	CG16	1363497	CA622IR	5002635	CA605IR
078903015B	CA837IR	311903017J	CG16	1363511	CA381IR	5002691	CA633IR
078903015C	CA855IR	311903017JX	CG16	1363511	CA381IR	5002698	CS317
078903015D	CA837IR	311903031E	CG16	1398327	CA381IR	5002699	CS523
078903015DX	CA837IR	311903031F	CG16	1398702	CS135	5002701	CS882
078903015F	CA855IR	311903031J	CG16	1398764	CS690	5002701	CS882
078903015F	CA855IR	311911023B	CS62	1505107	CA132IR	5002730	CA272IR
078903015FX	CA855IR	311911023C	CS62	1505307	CA132IR	5002781	CA535IR
078903016A	CA837IR	311911023D	CS62	1509425	CA366IR	5002790	CA579IR
078903016AB	CA1746IR	311911023DX	CS62	1542195	CS783	5002898	CA88IR
078903016AC	CA1746IR	441.04009-219.6	CS1047	1543695	CS797	5002899	CA591IR
078903016E	CA1546IR	4Z7903015	CA1746IR	1545417	CS783	5003002	CA590IR
078903016F	CA1588IR	6K0903028	CA1510IR	1547049	CS962	5003009	CS391
078903016G	CA1546IR	6U0911023A	CS1047	1556955	CS1116	5003027	CS506
078903016H	CA1588IR	6U0911023B	CS798	1578139	CA366IR	5003028	CS544
078903016HX	CA1588IR	7M5903028	CA1836IR	1578140	CA132IR	5003029	CS99
078903016R	CA1813IR	BBW911023	CS79	1578938	CA366IR	5003089	CA722IR
078903016S	CA1813IR	BBW911023B	CS116	1607361	CA505IR	5003312	CS699
078903017B	CA837IR	BCA903015	CA337IR	1607362	CA500IR	5003349	CA518IR
078911023A	CS725	J2702054352	JA777	1621048	CA853IR	5003398	CA853IR
078911023D	CS1074	J2702054700	JA777	1638187	CS1116	5003448	CA518IR
078911023X	CS725	J2706035061	JA1123IR	1676800	CS1167	5003508	CA528IR
07K903025A	CA1782IR	JUF903031A	CA505IR	1676816	CS1167	5003564	CS389
085911023A	CS988			1676822	CS1443	5003636	CA811IR
085911023AX	CS988	VAUXHALL → OPEL		3032961	CA1224IR	5003665	CA381IR
085911023B	CS788			3173821	CA1049IR	5003694	CA900IR
085911023BX	CS788	VOLVO		3283184	CA289IR	5003695	CA904IR
085911023E	CS788	240340	CS99	3412455	CS310	5003708	CS386
085911023F	CS1194	240504	CS710	3417316	CA711IR	5003746	CA903IR
085911023H	CS1259	241735	CA89	3430012	CS310	5003804	CA381IR
085911023J	CS788	243007	CS726	3515930	CA1551IR	5003805	CA900IR
085911023JX	CS788	308043	CS544	3523044	CA1551IR	5003806	CA528IR
085911023K	CS988	420731	CS699	3523045	CA1551IR	5003920	CA1069IR
085911023L	CS988	420760	CS1443	3523301	CS389	5003975	CA1088IR
085911023M	CS988	420780	CS544	3523302	CS135	5003996	CA1088IR
091911023A	CS298	464316	CS135	3523303	CS690	6205473	CA339IR
091911023AX	CS298	465604	CS391	3523422	CA1088IR	6686461	CS99
091911023B	CS298	465929	CS506	3523878	CA903IR	6779261	CA518IR
091911023BX	CS298	465930	CS544	3544119	CA1069IR	6779713	CA366IR
091911023X	CS115	465931	CS99	3544497	CA905IR	6849755	CA1056IR
				3544498	CA900IR	6886493	CA132IR

O.E. NO.	HC-PARTS	O.E. NO.	HC-PARTS	O.E. NO.	HC-PARTS	O.E. NO.	HC-PARTS
VOLKSWAGEN <i>Continued</i>							
8111001	CA1443IR	8252889	CS1207	9031138	CA625IR	30658087	CA2028IR
8111007	CS1113	8253502	CA1484IR	9031146	CA574IR	30658567	CS1271
8111048	CA1204IR ▲	8253504	CS1174	9031147	CA7111R	30667058	CS1377
8111107	CA1096IR	8253505	CS1179	9031302	CS310	30667067	CA1865IR
8111119	CA1445IR	8253507	CA1470IR	9031303	CS684	30667068	CA1834IR
8111122	CA1445IR	8253534	CA1298IR	9031311	CA574IR	30667069	CA1926IR
8111505	CA612IR	8253540	CA1344IR	9031312	CA7111R	30667071	CA1864IR
8111509	CS374	8253611	CA1506IR	9031316	CA716IR	30667072	CA1931IR
8111510	CS354	8253612	CA1622IR	9031705	CA1573IR	30667102	CS1050
8111537	CA602IR	8253632	CA1544IR	9031705	CA574IR	30667103	CA1966IR *
8111568	CS980	8253634	CS1186	9031705	CA625IR	30667118	CA1968IR
8111570	CA896IR	8253785	CA1627IR	9031707	CA7111R	30667119	CA2001IR
8111571	CA1036IR	8253786	CS1193	9130002	CA1088IR	30667295	CA1923IR
8111572	CS784	8253797	CA1637IR	9130003	CA1088IR	30667494	CS1377
8111577	CA1040IR	8253860	CA1661IR	9130217	CA1822IR	30667501	CA1862IR
8111578	CA1320IR	8253873	CS1174	9130273	CA1056IR	30667787	CA1988IR
8111634	CA1088IR	8253975	CA1662IR	9130274	CA1088IR	30667788	CA2028IR
8111635	CS1060	8253980	CA1645IR	9130275	CA1069IR	30667874	CS1377
8111643	CS978	8601699	CA1439IR	9130485	CA1088IR	30667894	CA1988IR
8111693	CS791	8602002	JA1522IR	9148665	CA1096IR	30667895	CA2028IR
8111698	CA1077IR	8602067	CS978	9162400	CS1113	30724473	CS1271
8111699	CA1078IR	8602083	CS684	9162422	CA1069IR	30755494	CA1864IR
8111700	CA1079IR	8602084	CS680	9162423	CA1655IR	30773111	CA1967IR
8111701	CS681	8602085	CS680	9162424	CA1088IR ▲	30782052	CS1271
8111702	CA1200IR	8602096	CA1096IR	9162468	CA1096IR	30782228	CS1271
8111703	CA1250IR	8602097	CA1309IR	9162617	CS680	30795169	CA2000IR
8111704	CA848IR	8602100	CA848IR	9162618	CS680	30795422	CA1865IR
8111708	CA632IR	8602101	CA1080IR	9162683	CA1088IR	30795423	CA1834IR
8111710	CA1059IR	8602102	CS1060	9162684	CA1096IR	30795493	CA1962IR
8111712	CA831IR	8602103	CS1132	9162927	CA1204IR ▲	30795495	CA1931IR
8111811	CA1036IR	8602104	CS1272	9162928	CS1051	30808465	CS1060
8111838	CA1253IR	8602138	CA1056IR	9164940	CA1096IR	30854113	CS1132
8111839	CA1253IR	8602159	CA1331IR	9164941	CA1056IR	31268035	CS1430
8111840	CS1057	8602185	CA1309IR	9442130	CA1445IR	31288155	CA1834IR
8111887	CA1056IR	8602274	CS1281	9442188	CA1096IR	31288275	CS1050
8111888	CA1309IR	8602275	CA1673IR ▲	9442841	CA1443IR	36000037	CA1968IR
8111905	CA1322IR	8602276	CA1439IR	9442905	CA1204IR	36000038	CA2001IR
8111906	CA1303IR	8602277	CA1443IR	9447863	CA1056IR ▲	36000039	CS1430
8111910	CA1333IR	8602279	CA1627IR	9447864	CA1655IR	36000207	CA1967IR
8111911	CA1319IR	8602343	CA1673IR	9447865	CA1069IR	36000220	CA1923IR
8111912	CA1333IR	8602355	CS1271	9447866	CA1204IR	36000221	CS1377
8111917	CA1344IR	8602360	CS1196	9459038	CA1443IR	36000237	CS1271
8111918	CA1345IR	8602556	CA1572IR	9459077	CA1439IR	36000598	CA1865IR
8111920	CA1304IR	8602710	CA1673IR	9459092	CA1439IR	36000798	CA2000IR
8111921	CA1444IR	8602712	CA1673IR ▲	9459093	CA1445IR	36002496	CS1430
8111943	CA1306IR	8602713	CA1861IR ▲	9459468	CS1196	36002497	CS1403
8111944	CA1307IR	8602714	CA1861IR	9472908	CA1439IR	36002574	CA1864IR
8111945	CA1309IR	8602806	CA1627IR	9489312	CA1673IR ▲	36002575	CA1931IR
8112272	CA1668IR	8602818	CS1271	9496882	CS1271	36002642	CS1271
8112614	CA1049IR	8602924	CS1398	9519360	CA1667IR	36002761	CS1050
8112932	CA1669IR	8603182	CA1865IR	9520621	CA1667IR	36005266	CA2028IR
8112933	CA1670IR	8603262	CA1988IR	9520862	CA1670IR	36050273	CS1398
8113165	CS1161	8603265	CA2028IR	9521761	CA907IR	85000087	CS1388
8113258	CA1049IR	8603271	CA1864IR	11030906	CS506	85000186	CS1161
8113717	CA284IR	8603272	CA1931IR	11031126	CS544	85000221	CA518IR
8113860	CS1474	8603292	CS1403	11170011	CA1049IR	85000257	CA1853IR
8113908	CA132IR	8603377	CS1050	11170134	CA1853IR	85000295	CS1451
8113909	CA722IR	8603409	CS1377	11170321	CA1853IR	85000438	CS506
8113910	CA366IR	8603496	CA1966IR *	20397219	CS1495	85000439	CS544
8113911	CA518IR	8603539	CS1271	20409228	CA1853IR	85000440	CS699
8113912	CA853IR	8603604	CA1962IR	20409240	CA1883IR	85000441	CS1116
8113918	CS1161	8603689	CS1403	20430564	CS1388	85000443	CS1443
8144401	CA1049IR	8603690	CS1341	20450305	CS1451	85000446	CS1474
8156816	CA1049IR	8622742	CS1398	20451445	CS1161	85000447	CS1285
8156817	CA907IR	8622786	CA1673IR	20466315	CA1853IR	85000450	CS506
8192262	CS1443	8637847	CA1673IR ▲	20536466	CS1161	85000507	CA1049IR
8192965	CS1285	8637848	CA1673IR	20553711	CS544	85000526	CS1451
8251071	CA1439IR	8637849	CA1861IR ▲	20572417	CS1472	85000626	CA1853IR
8251551	CS680	8651665	CA1861IR	20732404	CS1451	85000628	CA1883IR
8251635	CA1303IR	8666579	CA1865IR	20739778	CA1883IR	85000629	CA1883IR
8251639	CA1056IR	8666581	CA1926IR	20849350	CA1853IR	85000644	CA1883IR
8251641	CA1627IR	8676489	CA1673IR	20849352	CA1883IR	85000677	CS1472
8251643	CS1193	8676496	CA1673IR	20891242	CS1472	85000709	CA132IR
8251648	CA1572IR	8676498	CA1673IR	21067513	CS1474	85000710	CA722IR
8251655	CA1439IR	8676499	CA1861IR	21164603	CS1496	85000711	CA366IR
8251655	CA1439IR	8688170	CA1864IR	21429789	CA1883IR	85000712	CA853IR
8251655	CA1439IR	8697650	CS1430	21477589	CS1474	85000713	CA907IR
8251725	CA1627IR	9031062	CA289IR	24437136	CS1257	85000714	CA907IR
8252875	CS1255	9031081	CA372IR	30658085	CA1988IR	85000715	CA907IR

O.E. NO.	HC-PARTS	O.E. NO.	HC-PARTS	O.E. NO.	HC-PARTS	O.E. NO.	HC-PARTS
85000716 .....	CA853IR						
85000746 .....	CS1472						
85000749 .....	CS1496						
85003104 .....	CA1667IR						
85003303 .....	CS1474						
85003304 .....	CS1285						
85003355 .....	CA1853IR						
YANMAR							
119131-77010 .....	JS748						
119209-77010 .....	JS1239						
119225-77011 .....	JS1356						
119226-77010 .....	JS1356						
119226-77010 .....	JS1356						
119254-77200 .....	JA160IR						
119285-77010 .....	JS1239						
119620-77011 .....	JS909						
121120-77011 .....	JS1239						
121120-77012 .....	JS1239						
121450-77010 .....	JS729						
124250-77012 .....	JS1232						
124772-77020 .....	JS731						
128170-77010 .....	JS1145						
128170-77201 .....	JA116IR						
128171-77200 .....	JA116IR						
129486-77011 .....	JS776						
129772-77200 .....	JA986IR						

**Notes**

A large, empty rectangular box with a thin black border, occupying most of the page. It is intended for the user to write their notes.

A large, empty rectangular box with a thin black border, occupying most of the page. It is intended for the user to write their notes.

**Notes**

A large, empty rectangular box with a thin black border, occupying most of the page. It is intended for the user to write their notes.



A large, empty rectangular box with a thin black border, occupying most of the page. It is intended for the user to write their notes.

**Notes**

A large, empty rectangular box with a thin black border, occupying most of the page. It is intended for the user to write their notes.

A large, empty rectangular box with a thin black border, occupying most of the page. It is intended for the user to write their notes.

**Notes**

A large, empty rectangular box with a thin black border, occupying most of the page. It is intended for the user to write their notes.

A large, empty rectangular box with a thin black border, occupying most of the page. It is intended for the user to write their notes.

**Notes**

A large, empty rectangular box with a thin black border, occupying most of the page. It is intended for the user to write their notes.

A large, empty rectangular box with a thin black border, occupying most of the page. It is intended for the user to write their notes.

## Notes



A large, empty rectangular box with a thin black border, occupying most of the page. It is intended for the user to write their notes.

**Notes**

A large, empty rectangular box with a thin black border, occupying most of the page. It is intended for the user to write their notes.